

Train avant & arrière *Front & rear Axle*



— WE CREATE EXCELLENCE —



2015 - 2016

www.sasic.com



E-T-A-I





SOMMAIRE / INDEX

Train Avant & Arrière *Front & Rear Axle*



**Les directions & pompes de directions
ont désormais leurs catalogues respectifs**

*For steerings & power steering pumps please
refer to steerings & power steering pumps catalogs*



Table des matières / *Contents*

p. B - E

Réf. remplacées
Superseded references

p. F



Applications

p. 1

CROSS LISTS

OE



Sasic

p. 1457

Dépôts régionaux & Dépôts à l'étranger
Warehouses

p. 1478

Traductions, abréviations
Translations, abbreviations

p. 1479





Conditions générales de vente à l'international
General terms of sales

p. 1482

NEW

365 Nouvelles références





365 New references

			
ALFA ROMEO		CITROEN	
33	1	AX	169
75	1	Berlingo VL	174
90	2	BX	184
145	2	C-Crosser	186
147	6	C1	190
155	7	C2	193
156	9	C3	199
159	12	C3 Picasso	209
164	13	C3 Pluriel	212
166	14	C4	216
Arna	16	C4 Aircross	223
Brera	16	C4 Picasso -06/13	225
GT	17	C4 Picasso 06/13-	228
GTV	19	C5	228
Mito	20	C6	239
Spider	22	C8	242
AUDI		DS3	246
80	24	DS4	248
90	28	DS5	251
100	29	Evasion	253
200	31	LN LNA	256
A1	31	Nemo VL	257
A2	33	Saxo	260
A3	34	Visa	265
A4 I 94-2000	50	Xantia	268
A4 II 2000-	55	XM	272
A4 III 2008-	63	Xsara	275
A5	67	Xsara Picasso	287
A6 I 94-97	71	ZX	291
A6 II 97-04/2004	73	Berlingo VU	296
A6 III 05/04- 03/11	78	C15	313
A6 IV 02/11- 4G	81	C25	318
A7	83	C35	321
A8	84	Jumper	322
Q3	87	Jumpy	334
Q5	90	Nemo VU	339
Q7	92	DACIA	
TT	93	Dokker	343
BMW		Duster	344
Série 1 E81 E87	98	Logan I	348
Série 1 E82	101	Logan II	352
Série 1 E88	104	Lodgy	354
Série 3 E21	107	Sandero I	355
Série 3 E30	108	Sandero II	358
Série 3 E36	111	DAEWOO	
Série 3 E46	115	Espero	359
Série 3 E90	123	Kalos	360
Série 3 E91	127	Lacetti	361
Série 3 E92	131	Leganza	362
Série 3 E93	134	Matiz	362
Série 5 E28	137	Nexia	363
Série 5 E34	137	Nubira	364
Série 5 E39	140	Rezzo	365
Série 5 E60	144	Tico	365
Série 5 E61	147	DAIHATSU	
Série 6 E63 Coupé	150	Terios	366
Série 6 E64 Cab.	151	FIAT	
Série 7 E32	152	500	366
Série 7 E65	152	Barchetta	367
Série 7 E66	153	Brava	368
X1	153	Bravo	370
X3	155	Cinquecento	374
X5	159	Coupé	374
X6	160	Croma	376
Z1	160	Duna	377
Z3	160	Fiorino VL	377
Z4	161	Idea	380
CHEVROLET		Linea	381
Aveo	163	Marea	382
Captiva	164	Multipla	384
Cruze	165	Palio	385
Kalos	165	Panda	388
Lacetti	166	Punto	390
Matiz	167	Grande Punto	395
Nubira	168		
Orlando	168		
Spark	168		

Les dessins, photos, références constructeurs (origine) ne servent qu' à identifier les pièces et sont donnés à titre indicatif.















TABLE DES MATIÈRES CONTENTS



















			
Punto Evo	398	KIA	
Qubo	401	Ceed	530
Regata	403	Picanto	532
Ritmo	404	Rio	534
Seicento	405	Sephia	536
Stilo	406	Soul	537
Tempra	407	Sportage	538
Tipo	410	Venga	540
Ulysse	413	LADA	
Uno	416	Niva	541
Doblo	419	LANCIA	
Ducato 81-94	422	Dedra	541
Ducato 94-01	426	Delta	545
Ducato 244.. 02-06	431	Kappa	548
Ducato 250.. 06-	433	Lybra	549
Fiorino VU	437	Musa	550
Scudo	439	Phedra	551
Strada	443	Prisma	552
FORD		Thema	554
B-Max	445	Thesis	554
C-Max	445	Y (Epsilon)	555
Cougar	449	Ypsilon	557
Escort	450	Y10	558
Fiesta I/II 76-89 OF/FB/O/V	453	Zeta	559
Fiesta III 89-95 FA/B/V	454	LAND ROVER	
Fiesta IV/V 95-02 JB FA/B JA/V	457	Discovery	562
Fiesta VI 02-10/08	460	FreeLander	562
Fiesta VII 10/08-	463	LEXUS	
Focus	464	CT	562
Fusion	470	MAZDA	
Galaxy	472	2	563
Ka	475	3	564
Kuga	478	5	566
Mondeo	479	121	567
Orion	485	323	567
Puma	488	626	568
Scorpio	490	Demio	569
Sierra	491	MERCEDES	
S-Max	492	Série 124 12/84-	570
StreetKa	494	Série 190 (201) 10/82-08/93	577
Courier	495	Classe A (168) 07/97-	579
Tourneo	498	Classe A (169) 07/04-	581
Tourneo Connect	499	Classe B (245) 05/05-	584
Transit	500	Classe C (202) 03/93-	586
Transit Connect	505	Classe C (203) 05/00-	590
HONDA		Classe C (204) 01/07-	595
Accord	507	Classe CLK Coupé (209) 06/02-	597
Civic	507	Classe CLS (219)09/04-04/08	598
CR-V	509	Classe E (207) 01/09-	598
Insight	509	Classe E (210) 06/95-03/03	600
Jazz	510	Classe E (211) 03/02-	602
HYUNDAI		Classe E (212) 01/09-	605
Accent	512	Classe SL (230) 10/01-	606
Coupé	513	Classe SLK (170) 04/96-	606
Getz	513	Classe SLK (171) 03/04-	607
I 10	514	Classe V (638) 10/96-	609
I 20	515	MB100	610
I 30	516	Sprinter	611
IX 20	518	Transporter /T1	615
IX 35	519	Vaneo 02/02-	615
IX 55	520	Viano	616
Santa Fe	521	Vito	618
Tucson	521	MINI	
IVECO		Mini I R50 R53 06/01-09/06	621
Daily I -03/96	523	Mini II R56 09/06-	624
Daily I 04/96-05/99	525	Mini Cab. R52 -02/09	627
Daily II 05/99-03/06	526	Mini Cab. R57 03/09-	630
Daily III 04/06-	528	Mini Clubman R55 08/07-	633
Grinta	529	Mini Coupé R58 09/11-	636
JEEP		Mini Roadster R59 02/12-	638
Cherokee	529	Mini Countryman R60 06/10-	641
Grand Cherokee	529		

Drawings, pictures, references from car makers or OE suppliers, are given for identification of the parts and have only a guidance value.

Los dibujos, las fotos y las referencias de origen solamente sirven a la identificación de los repuestos en concepto de indicación.

					
MITSUBISHI					
ASX 		642	403		821
Carisma		642	404		821
Colt		643	405		824
Outlander		644	406		829
Pajero		644	407		840
Space Star		645	4007		847
			4008		849
			504		851
			505		857
			508		860
			5008		865
			604		868
			605		872
			607		877
			806		882
			807		885
			Bipper VL		889
			Expert VL		891
			RCZ		897
NISSAN					
200 SX 		645	Bipper VU		899
Almera		645	Boxer I -01/02		902
Almera Tino		647	Boxer II 01/02-07/06		908
Cube		648	Boxer III 07/06-		913
Juke		648	Expert VU		916
Leaf		649	J5		921
Maxima		650	J7		925
Micra		650	J9		926
Note		653	Partner		927
Primera		655	RENAULT		
Qashqai		656	R4 		946
Sunny		658	R5		949
Terrano II		659	Super 5		951
Tiida		660	R6		955
X-Trail		662	R9		957
Interstar 		664	R12		961
Kubistar		666	R14		962
Primastar		666	R18		963
			R19		966
OPEL			R20		970
Adam 		669	R21		971
Agila		669	R21 Nevada		977
Ampera		670	R25		982
Antara		671	R30		985
Ascona C		672	Avantime		986
Astra F		673	Captur		989
Astra G		677	Clio I -02/98		990
Astra H		680	Clio II 03/98-		995
Astra J		684	Clio III 09/05-		1005
Calibra		686	Clio IV 09/12-		1012
Corsa A		688	Espace J11/S11		1014
Corsa B		690	Espace J63/S63		1017
Corsa C		694	Espace JEO		1020
Corsa D		696	Espace JKO		1023
Frontera		699	Fluence		1027
Insignia		699	Fuego		1029
Kadett E		700	Kangoo I -02/03 VL		1030
Meriva		702	Kangoo I 03/03-12/07 VL		1038
Omega A		706	Kangoo II 01/08- VL		1044
Omega B		707	Koleos		1046
Signum		708	Laguna I		1048
Tigra		709	Laguna I Nevada		1051
Vectra A		713	Laguna II		1054
Vectra B		717	Laguna II Estate		1057
Vectra C		720	Laguna III		1060
Zafira		723	Laguna III Estate		1063
Combo 		727	Laguna III Coupé		1066
Movano		730	Latitude		1069
Vivaro		734	Megane I		1069
			Megane I Break		1076
PEUGEOT			Megane I Cabriolet		1079
104 		737	Megane I Classic		1084
106		739	Megane I Coupé		1089
107		746	Megane II /Classic		1094
1007		748	Megane II Break		1100
204		751	Megane II Cab. CC		1103
205		753	Megane II Coupé		1106
206		759	Megane III		1110
206+ 04/09-		769	Megane III Break		1113
207		773	Megane III Cab. CC		1116
208		778	Megane III Coupé		1118
2008		781	Modus		1121
301		783	Safrane		1124
304		785	Scenic I -04/03		1127
305		787			
306		791			
307		797			
307 CC		803			
308 -09/13		807			
308 09/13-		812			
309		812			
3008		817			

Les dessins, photos, références constructeurs (origine) ne servent qu' à identifier les pièces et sont donnés à titre indicatif.





			
Scenic II 05/03-03/09 	1134	Horizon 	1291
Scenic III 04/09-	1140	Samba	1292
Thalia Symbol I (LB)	1142	TOYOTA	
Thalia Symbol II (LU)	1146	Auris 	1293
Twingo I	1148	Avensis	1293
Twingo II	1152	Aygo	1296
Twizy	1155	Avensis Verso	1296
Vel Satis	1155	Aygo	1297
Wind	1158	Corolla	1298
Zoe	1159	Corolla Verso	1301
Express	1161	Rav4	1302
Kangoo I -02/03 VU 	1166	Urban	1305
Kangoo I 03/03-12/07 VU	1172	Verso 06/09-	1305
Kangoo II 01/08- VU	1179	Yaris	1306
Mascott	1181	VOLKSWAGEN	
Master I	1182	New Beetle 	1309
Master II	1186	Bora	1314
Master III	1190	Corrado	1317
Messenger B70/80/90 110/20	1192	Derby	1321
Traffic I	1194	Eos	1322
Traffic II	1198	Golf I 76-83	1326
ROVER		Golf II 83-91	1328
25 45 	1203	Golf III 91-97	1331
75	1204	Golf IV 97-03	1336
100	1204	Golf V 03-	1341
200 400	1205	Golf VI 10/08-	1347
Metro	1206	Golf VII 11/12-	1351
Mini	1207	Golf III Cabriolet	1352
SAAB		Golf IV Cabriolet	1354
9-3 	1207	Jetta	1357
9-5	1207	Lupo	1363
9000	1208	Passat I II 73-88	1366
SEAT		Passat III IV 88-97	1367
Alhambra 	1209	Passat V 96-05	1370
Altea	1212	Passat VI 05-10	1375
Arosa	1216	Passat VII 10-	1380
Cordoba	1219	Phaeton	1383
Exeo	1224	Polo -05/09	1383
Ibiza I 84-93	1227	Polo (6R) 06/09-	1392
Ibiza II III IV 93-01(6K)	1228	Up	1396
Ibiza V 01- (6J 6L)	1232	Santana	1398
Leon	1237	Scirocco	1399
Malaga	1244	Sharan	1404
Marbella	1245	Tiguan	1407
Mii	1246	Touareg	1411
Toledo	1247	Touran	1412
Inca	1257	Vento	1416
SKODA		Caddy 	1420
Citigo 	1259	Crafter	1425
Fabia	1260	LT I 75-96	1426
Favorit	1266	LT II III 96-	1427
Felicia	1267	Transporter TYP3 (F24) 80-92	1429
Octavia	1268	Transporter TYP4 (F70/D) 91-03	1430
Rapid	1274	Transporter TYP5 (F7J/H) 03-	1432
Roomster	1276	VOLVO	
Superb	1279	340/360 	1435
Yeti	1284	440/460	1435
SMART		480	1436
City 	1287	740	1436
Forfour	1287	760	1437
Fortwo	1287	780	1438
Roadster	1288	850	1439
SUZUKI		940 960	1440
Alto 	1289	C30	1440
Splash	1289	C70 Coupé	1442
Swift	1290	S40 V40	1444
Wagon R	1291	S60	1448
TALBOT		V50	1449
1100 	1291	V60	1451
1307 1308 1309	1291	S70 V70	1452
1510	1291	S80	1454
		XC60 XC70	1455
		XC90	1456

Drawings, pictures, references from car makers or OE suppliers, are given for identification of the parts and have only a guidance value.

Los dibujos, las fotos y las referencias de origen solamente sirven a la identificación de los repuestos en concepto de indicación.



Références remplacées / *Superseeded references*

  NEW	  NEW
0355455	0355385
0385215	0385225
1034984	1034944
1315825	1315695
1315835	1315705
2005112	2005113
2005304	5203793
2005306	5203783
2250009	2250011
2650006	2250002
4001563	4001528
4003219	4003221
4003220	4003222
4003322	4005529
4005264	4005263
4005303	0355275
5203A73	5203A63
5203C93	5213643
5203F13	5203F33
5203G93	5203943
5213773	5213763
5213993	5213A33
5233953	5233AR3
6403303	6403313
7470009	7470002
7470011	7470001
7476085	7476088
7776033	9006855
	7776100
	7964001
	7964002
	7964003
	9001457
	9001550
	9001623
	9001727
	9005019
	9005021
	9005078
	9005083
	9005242
	9005376
	9005524
	9006249
	9006260
	9006331
	9006414
	9006415
	9006458
	9006471
	9006472
	9006587
	9006625
	9006627
	9006687
	7776078
	7964001S
	7964002S
	7964003S
	9001709
	2606001
	9001622
	0945695
	2306052
	9005031
	9005016
	2306010
	9005249
	0335415
	9005246
	9006248
	9006207
	9006337
	9006635
	9006634
	9006357
	9006695
	9006697
	9006584
	9006635
	9006634
	9006688

Eléments DIRECTION

Steering parts

Elementos Direcciones

Elementy układ kierowniczy

Элементы рулевой системы

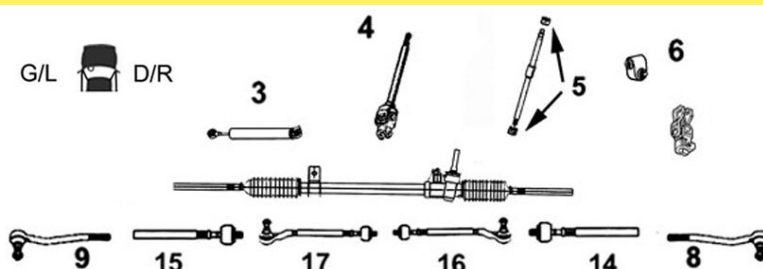
**9006404****Rotule de direction G/D**

OE 510615

L/R tie rod end

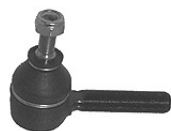
8
9

M14x1

TT /all models

Bras & Triangle de suspension

Control arm

Brazo y triángulo

Wahacz

Рычаг подвески

G/L D/R

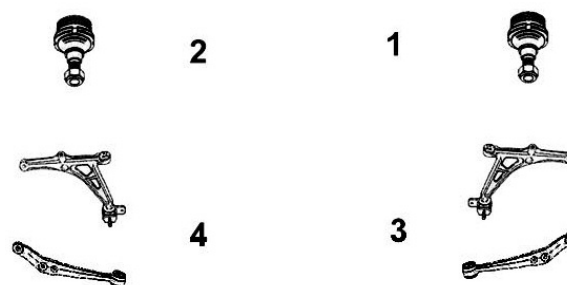
**9005146****Bras de suspension D**

OE 60501401

Right track control arm



3

Avec rotule With ball joint

TT /all models

Eléments DIRECTION

Steering parts

Elementos Direcciones

Elementy układ kierowniczy

Элементы рулевой системы

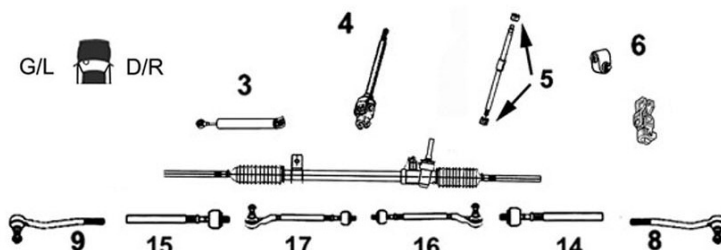
**9006238****Axe de bielle G/D**

OE 60724204

L/R axial joint

14
15Côté dir. M14x1.5 Côté rot. M14x1.5
long 229 mm

TT /all models

10/85-12/93

9006405**Rotule de direction G/D**

OE 60521320

L/R tie rod end

8
9

M14 x 1.5

TT /all models

10/85-12/93

90

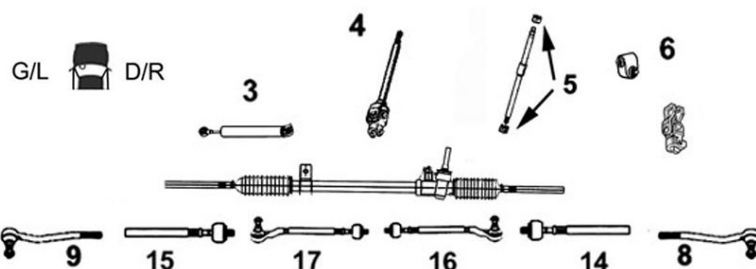
Eléments DIRECTION*Steering parts**Elementos Direcciones**Elementy układ kierowniczy**Элементы рулевой системы***9006238****Axe de bielle G/D**

OE 60724204

L/R axial joint

14 Côté dir. M14x1.5 Côté rot. M14x1.5
15 long 229 mm

TT /all models

11/84-10/88

9006405**Rotule de direction G/D**

OE 60521320

L/R tie rod end

8 M14 x 1.5
9

TT /all models

11/84-10/88

145 ...

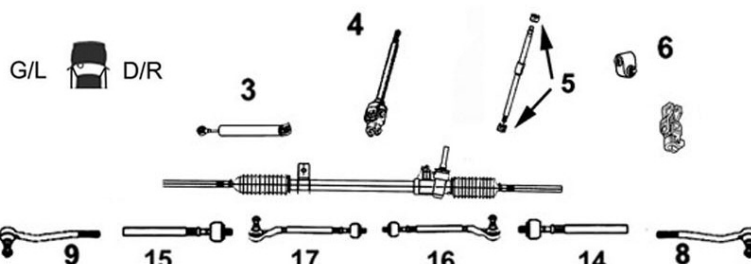
Eléments DIRECTION*Steering parts**Elementos Direcciones**Elementy układ kierowniczy**Элементы рулевой системы***9006654****Rotule de direction G/D**

OE 9947719

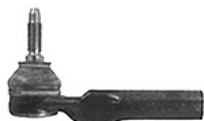
L/R tie rod end

8 M14 x 1.5
9

1.4i 16v. TS Junior / Sport

12/91-01/01

1.6i 16v. TS Junior / Sport

12/96-01/01

1.8i 16v. /TS

12/96-01/01

1.9 JTD

02/99-01/01

2.0 16v. /TS /Quadrifoglio

10/95-01/01

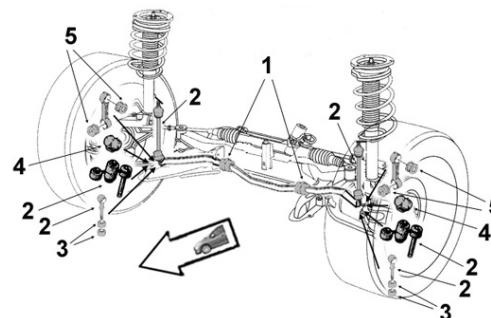
**Barre stabilisatrice***Stabilizer bar**Barra estabilizadora**Drażek stabilizatora**стабилизатор поперечной устойчивости***9005082****Bielle barre stab.**

OE 60570627

Stabilizer bar stub axle

2

1.4i	08/94-02/97
1.4i 16v.	03/97-10/01
1.6i	08/94-02/97
1.6i 16v.	03/97-10/01
1.7i 16v.	08/94-02/97
1.8i 16v.	03/97-10/01
1.9 JTD	04/99-10/01
1.9 TD	08/94-04/99
2.0i 16v.	01/96-08/98

9001502**Liaison élastique**





OE 7601642

Elastic link

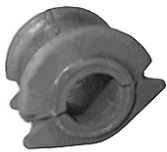
3 Ø int.10.4 Ø ext.30.5
 long. tube int.15.5 ext.17.5

1.4i	08/94-02/97
1.4i 16v.	04/99-10/01
1.6i	08/94-02/97
1.6i 16v.	04/99-10/01
1.7i 16v.	08/94-02/97
1.8i 16v.	04/99-10/01
1.9 JTD	04/99-10/01
2.0i 16v. Twin Spark	04/99-10/01

9001729		Palier de barre milieu	
OE 7760425		<i>Middle bar main bearing</i>	
	1 Barre Ø 22		
	1.4i 16v. 1.6i 16v. 1.8i 16v. 1.9 JTD 1.9 TD 2.0i 16v. 2.0i 16v. Twin Spark	AR32102 AR67601	03/97-10/01 04/99-10/01 03/97-10/01 04/99-10/01 08/94-04/99 01/96-08/98 06/98-10/01

Bras & Triangle de suspension <i>Control arm</i> <i>Brazo y triángulo</i> <i>Wahacz</i> <i>Рычаг подвески</i>	G/L  D/R		2	1	
			4	3	

9005149	Triangle de susp. G
OE 46474556	<i>Left track control arm</i>
	4 Avec rotule With ball joint Ø 17
	TT /all models 01/94-

9005148	Triangle de susp. D
OE 46474557	<i>Right track control arm</i>
	3 Avec rotule With ball joint Ø 17
	TT /all models 01/94-

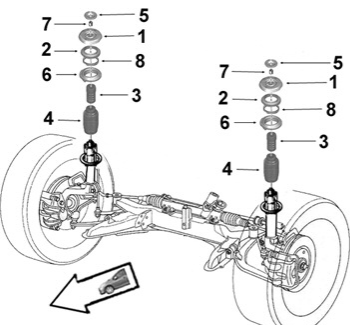
 Support d'amortisseur <i>Suspension mounting</i> <i>Soporte amortiguador</i> <i>Poduszka amortyzatora</i> <i>Опора амортизатора</i>	

9005636	Support suspension G
OE 60570732	<i>Left suspension mounting</i>
	1
	1.4i 08/94-02/97 1.6i 1.7i 16v.

9005634	Support suspension D
OE 60570731	<i>Right suspension mounting</i>
	1
	1.4i 08/94-02/97 1.6i 1.7i 16v.

8005206	Butée à billes G/D
OE 7601502	<i>L/R ball bearing</i>
	2 Ø 78.5 x 128 x 47
	1.4i 16v. 04/99-10/01 1.6i /16v. 1.7i 16v. 1.8i 16v. 1.9 TD 04/99-10/01 1.9 JTD 04/99-10/01 2.0 04/99-10/01

146 ...

Eléments DIRECTION
Steering parts
Elementos Direcciones
Elementy układ kierowniczy
Элементы рулевой системы

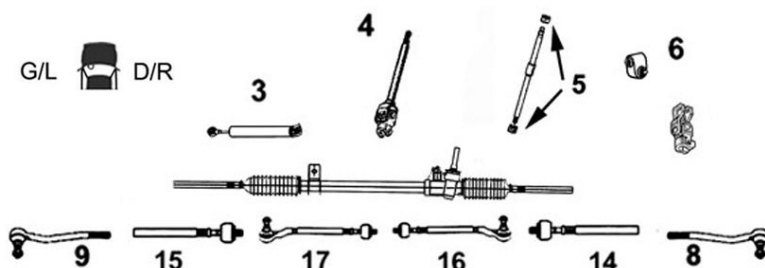
**9006654** Rotule de direction G/D

OE 9947719 L/R tie rod end

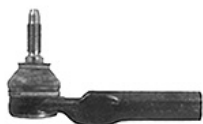
8
9**M14x1.5**

1.4i 16v. TS Junior / Sport	11/96-01/01
1.6ie 16v. TS Junior / Sport	11/96-01/01
1.8i 16v. TS	11/96-01/01
1.9 JTD	02/99-01/01
2.0 16v. /TS /Quadrifoglio	10/95-01/01

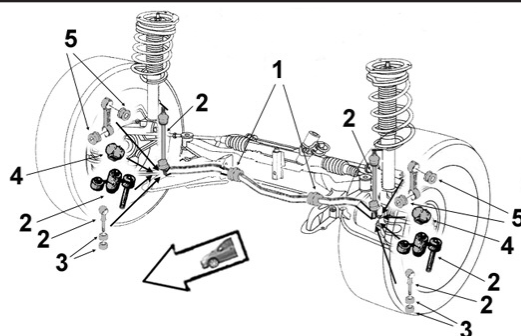

Barre stabilisatrice
Stabilizer bar
Barra estabilizadora
Drążek stabilizatora
стабилизатор поперечной устойчивости

**9005082** Bielle barre stab.

OE 60570627 Stabilizer bar stub axle



2

1.4i		04/95-02/97
1.4i 16v.		03/97-04/99
1.6i		04/95-02/97
1.6i 16v.	AR67601	03/97-04/99
1.7i 16v.		04/95-02/97
1.8i 16v.		03/97-04/99
1.9 TD	AR33601	04/95-04/99
2.0i 16v.	AR67204	05/96-08/98
2.0i 16v.	AR32301	06/98-04/99

9001502 Liaison élastique

OE 7601642 Elastic link



3

Ø int.10.4 Ø ext.30.5 long. tube int.15.5 ext.17.5

1.4i		04/95-02/97
1.4i 16v.		03/97-04/99
1.6i		04/95-02/97
1.6i 16v.	AR67601	03/97-04/99
1.7i 16v.		04/95-02/97
1.8i 16v.		03/97-04/99
1.9 TD	AR33601	04/95-04/99
2.0i 16v.	AR67204	05/96-08/98
2.0i 16v.	AR32301	06/98-04/99

9001729 Palier de barre milieu

OE 7760425 Middle bar main bearing

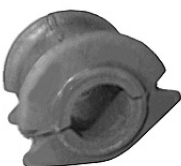

1

Barre Ø 22

1.4i 16v.		03/97-04/99
1.6i 16v.	AR67601	03/97-04/99
1.8i 16v.	AR67106	03/97-08/98
1.8i 16v.	AR32201	06/98-04/99
1.9 TD	AR33601	04/95-04/99
2.0i 16v.	AR67204	05/96-08/98
2.0i 16v.	AR32301	06/98-04/99

9001728 Palier de barre milieu

OE 7760424 Middle bar main bearing



1

Barre Ø 23

1.9 TD	AR33601	04/95-04/99
--------	---------	-------------

Bras & Triangle de suspension

Control arm
Brazo y triángulo
Wahacz
Рычаг подвески

G/L D/R

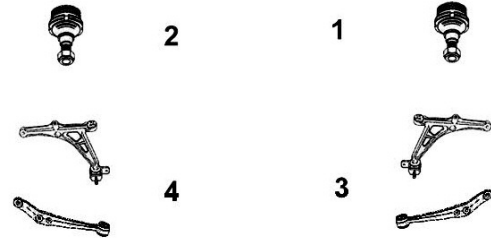

9005149

Triangle de susp. G

OE 46474556

Left track control arm



4 Avec rotule With ball joint Ø 17

TT /all models 01/94-

9005148

Triangle de susp. D

OE 46474557

Right track control arm



3 Avec rotule With ball joint Ø 17

TT /all models 01/94-



Support d'amortisseur

Suspension mounting
Soporte amortiguador
Poduszka amortyzatora
Опора амортизатора

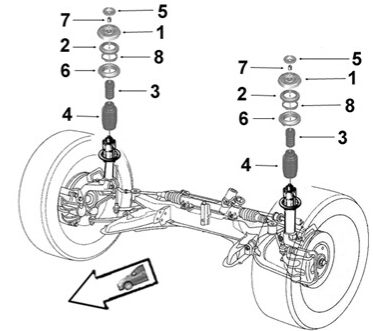

9005636

Support suspension G

OE 60570732

Left suspension mounting



1
1.6
1.7i 16v.

9005634

Support suspension D

OE 60570731

Right suspension mounting



1
1.6
1.7i 16v.

8005206

Butée à billes G/D

OE 7601502

L/R ball bearing



2 Ø 78.5 x 128 x 47

1.4
1.4i 16v.
1.6
1.6i 16v.
1.7i 16v.
1.8i 16v.
1.9 TD
1.9 JTD
2.0i 16v.

04/95-
11/96-
05/96-
06/98-
04/99-
05/96-

147 ...

Éléments DIRECTION
 Steering parts
 Elementos Direcciones
 Elementy układ kierowniczy
 Элементы рулевой системы

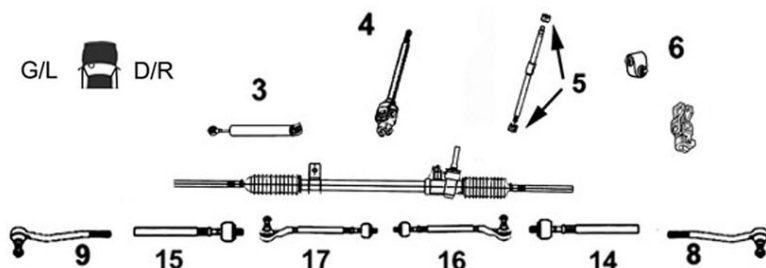

9006647 Rotule de direction G
 OE 9947919 Left tie rod end



9
 1.6i 16v.
 1.9 JTD
 2.0i 16v.
 3.2i
 11/02-10/05

9006648 Rotule de direction D
 OE 9947920 Right tie rod end

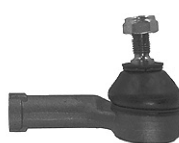

8
 1.6i 16v.
 1.9 JTD
 2.0i 16v.
 3.2i
 09/04-12/05



Barre stabilisatrice
 Stabilizer bar
 Barra estabilizadora
 Drażek stabilizatora
 стабилизатор поперечной устойчивости

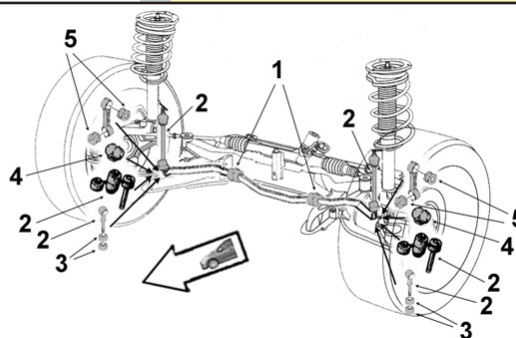

9005031 Bielle barre stab.
 OE 60625029 Stabilizer bar stub axle



2
 1.6i 16v.
 1.9 JTD
 2.0i 16v.
 3.2i GTA

Bras & Triangle de suspension

Control arm
 Brazo y triángulo
 Wahacz
 Рычаг подвески

G/L D/R

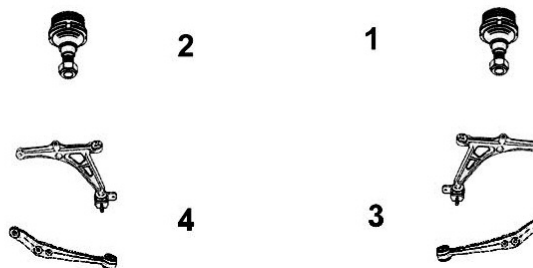

9005661 Triangle de susp. sup. G
 OE 51834093 Upper left track control arm



4 Avec rotule With ball joint
 1.6i 16v.
 1.9 JTD
 2.0i 16v.
 3.2i GTA
 11/02-12/05

9005660 Triangle de susp. sup. D
 OE 51834094 Upper right track control arm



3 Avec rotule With ball joint
 1.6i 16v.
 1.9 JTD
 2.0i 16v.
 3.2i GTA
 11/02-12/05

... 147

9005663

Triangle de susp. inf. G

OE 50509340

Lower left track control arm



4 Avec rotule With ball joint

1.6i 16v.
1.9 JTD
2.0i 16v.
3.2i

09/04-12/05

9005662

Triangle de susp. inf. D

OE 60686892

Lower right track control arm



3 Avec rotule With ball joint

1.6i 16v.
1.9 JTD
2.0i 16v.
3.2i

09/04-12/05



Barre stabilisatrice

Stabilizer bar

Barra estabilizadora

Drażek stabilizatora

стабилизатор поперечной устойчивости

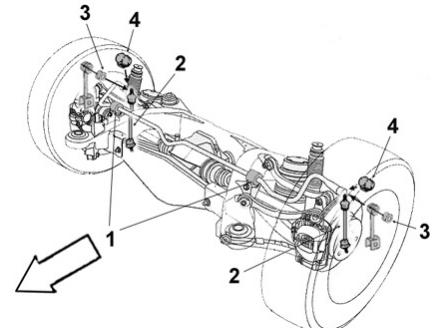

9005022

Biellette barre stab.

OE 60613575

Stabilizer bar stub axle



2

1.6i 16v.
1.9 JTD
2.0i 16v.
3.2i GTA

155 ...

Eléments DIRECTION

Steering parts

Elementos Direcciones

Elementy układ kierowniczy

Элементы рулевой системы

G/L D/R

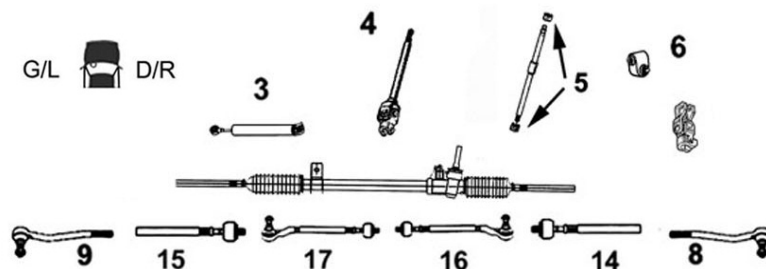

9006334

Rotule de direction G

OE 9947437

Left tie rod end



9 M12 x 1.5

TT /all models Sauf V6 03/92-04/95
1.8i 05/96-05/98

9006335

Rotule de direction D

OE 9947436

Right tie rod end



8 M12 x 1.5

TT /all models Sauf V6 03/92-04/95
1.8i 05/96-05/98

9006654

Rotule de direction G/D

OE 9947719

L/R tie rod end

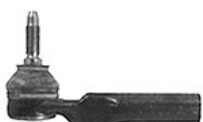

**8
9 M14 x 1.5**

2.0 16v. turbo /Q4 /TS
2.5 V6
2.5 TD

05/95-12/97
05/95-12/97
05/95-12/97



Barre stabilisatrice
 Stabilizer bar
 Barra estabilizadora
 Drażek stabilizatora
 стабилизатор поперечной устойчивости

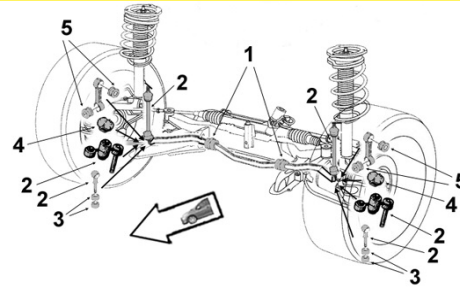

9005082 **Biellette barre stab.**
 OE 60570627 *Stabilizer bar stub axle*



2	1.8	K	01/92-12/96
	1.9 TD		01/92-12/96
	2.0	K	01/92-12/96
	2.5 V6	K	01/92-12/96
	2.5 TD		01/92-12/96

9001728 **Palier de barre milieu**
 OE 7760424 *Middle bar main bearing*



1	Barre Ø 23		
	1.8	K	01/92-12/96
	1.9 TD		01/92-12/96
	2.0	K	01/92-12/96
	2.5 V6	K	01/92-12/96
	2.5 TD		01/92-12/96

Bras & Triangle de suspension

Control arm
 Brazo y triángulo
 Wahacz
 Рычаг подвески

G/L D/R



9005149 **Triangle de susp. G**
 OE 60586771 *Left track control arm*



4	Avec rotule With ball joint Ø17	
	TT /all models	03/92-

9005148 **Triangle de susp. D**
 OE 60809814 *Right track control arm*



3	Avec rotule With ball joint Ø17	
	TT /all models	03/92-



Support d'amortisseur

Suspension mounting
 Soporte amortiguador
 Poduszka amortyzatora
 Опора амортизатора

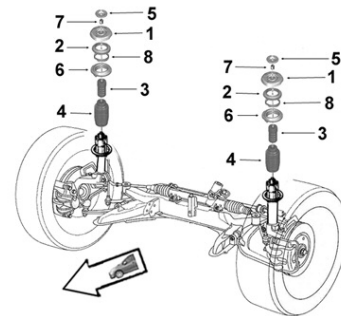

9005636 **Support suspension G**
 OE 60570732 *Left suspension mounting*



1	1.9 TD	01/92-12/96
	2.5 TD	01/92-12/96

9005634 **Support suspension D**
 OE 60570731 *Right suspension mounting*



1	1.9 TD	01/92-12/96
	2.5 TD	01/92-12/96

... 155

8005206

Butée à billes G/D

OE 7601502

L/R ball bearing



2 Ø 78.5 x 128 x 47

1.7i		01/94-05/96			
1.8i	K	01/92-12/96			
1.8i /16v.		05/96-05/98			
1.9 TD		01/92-12/96			
2.0	K	01/92-12/96			
2.0i 16v. TS		03/95-05/98			

2.0i Turbo 4WD		07/92-05/96
2.5 V6	K	01/92-12/96
2.5 TD		01/92-12/96

156 ...

Eléments DIRECTION

Steering parts

Elementos Direcciones

Elementy uklad kierowniczy

Элементы рулевой системы

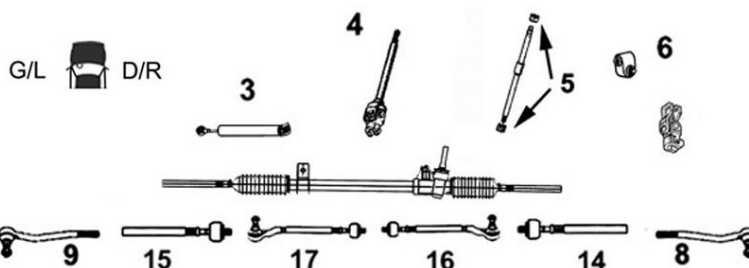

9006647

Rotule de direction G

OE 9947919

Left tie rod end

9



1.6i 16v.		
1.8i 16v.		
1.9 JTD		
2.0i 16v.		-12/01
2.0 JTS /Selespeed		03/02-
2.0i 16v. TS /Selespeed		01/03-
2.4 JTD		
2.5 V6		
3.2		01/02-07/03

9006648

Rotule de direction D

OE 9947920

Right tie rod end

8

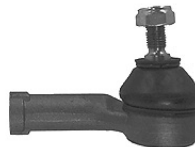

1.6i 16v.		
1.8i 16v.		
1.9 JTD		
2.0i 16v.		-12/01
2.0 JTS /Selespeed		03/02-
2.0i 16v. TS /Selespeed		01/03-
2.4 JTD		
2.5 V6		
3.2		01/02-07/03



Barre stabilisatrice

Stabilizer bar

Barra estabilizadora

Drażek stabilizatora

стабилизатор поперечной устойчивости

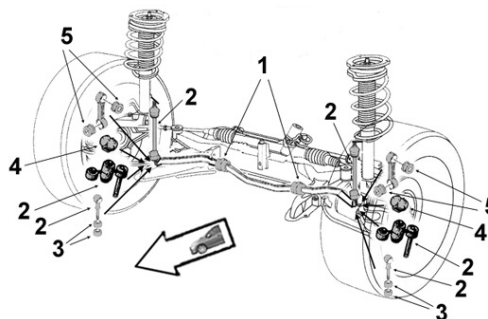

9005031

Biellette barre stab.

OE 60625029

Stabilizer bar stub axle

2



1.6i 16v.		
1.8i 16v.		
1.9 JTD		
2.0i 16v. /JTS		
2.4 JTD		
2.5 V6		-12/01

-12/01



Barre stabilisatrice
 Stabilizer bar
 Barra estabilizadora
 Drażek stabilizatora
 стабилизатор поперечной устойчивости

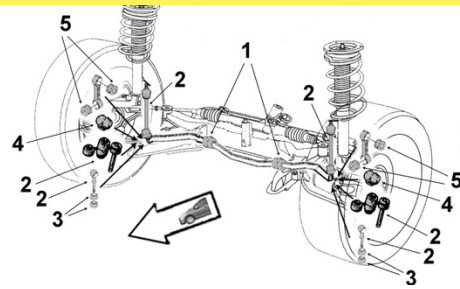

9005031 **Biellette barre stab.**
 OE 46843389 *Stabilizer bar stub axle*



2

2.4 JTD 175hp 129kw/ Break
 2.5 V6 /Break
 2.5i V6 24v./ Break
 3.2i GTA /Selespeed /Break

01/02-
 01/03-
 01/03-
 01/02-12/05

Bras & Triangle de suspension

Control arm
 Brazo y triángulo
 Wahacz
 Рычаг подвески

G/L D/R

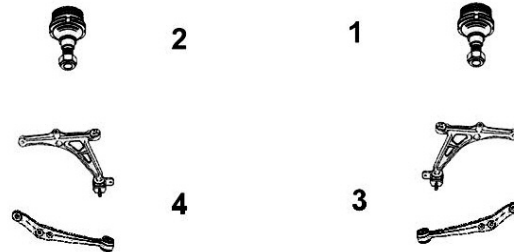

9005661 **Triangle de susp. sup. G**
 OE 51834093 *Upper left track control arm*

4 **Avec rotule With ball joint**

1.6i 16v. Ch- Vet 0041426 -12/01
 1.6i 16v. TS 01/03-
 1.6i 16v. TS Break 11/04-
 1.8i 16v. 01/02-07/03
 1.8i 16v. TS 140hp 144hp Break
 04/00-12/01
 1.8i 16v. TS 01/03-
 1.9 JTD -07/03
 1.9 JTD 115hp 125hp 136hp 140hp
 12/02-04/07
 2.0i 16v. /TS Selespeed Ch- Vet 0041426
 -12/01
 2.0 JTS /Selespeed 01/02-12/05
 2.0i 16v. TS 150hp Break
 04/00-12/01
 2.0i 16v. TS 155hp Break BV5/6
 04/00-12/01
 2.0i 16v. TS /Selespeed 01/03-
 2.4 JTD -07/03
 2.4 JTD 136hp 140hp Break
 04/00-12/01
 2.4 JTD 150hp 110kw BVM
 07/03-12/05
 2.4 JTD 165hp 120kw BVM
 04/04-12/05
 2.4 JTD 175hp 129kw 01/03-
 2.5 V6 Ch- Vet 0041426 BVM BVA -
 12/01
 2.5i V6 24v. 01/03-
 3.2 01/02-12/05



9005660 **Triangle de susp. sup. D**
 OE 51834094 *Upper right track control arm*

3 **Avec rotule With ball joint**

1.6i 16v. Ch- Vet 0041426 -12/01
 1.6i 16v. TS 01/03-
 1.6i 16v. TS Break 11/04-
 1.8i 16v. 01/02-07/03
 1.8i 16v. TS 140hp 144hp Break
 04/00-12/01
 1.8i 16v. TS 01/03-
 1.9 JTD -07/03
 1.9 JTD 115hp 125hp 136hp 140hp
 12/02-04/07
 2.0i 16v. /TS Selespeed Ch- Vet 0041426
 -12/01
 2.0 JTS /Selespeed 01/02-12/05
 2.0i 16v. TS 150hp Break
 04/00-12/01
 2.0i 16v. TS 155hp Break BV5/6
 04/00-12/01
 2.0i 16v. TS /Selespeed 01/03-
 2.4 JTD -07/03
 2.4 JTD 136hp 140hp Break
 04/00-12/01
 2.4 JTD 150hp 110kw BVM
 07/03-12/05
 2.4 JTD 165hp 120kw BVM
 04/04-12/05
 2.4 JTD 175hp 129kw 01/03-
 2.5 V6 Ch- Vet 0041426 BVM BVA -
 12/01
 2.5i V6 24v. 01/03-
 3.2 01/02-12/05



9005663	Triangle de susp. inf. G	9005662	Triangle de susp. inf. D
OE 50509340	<i>Lower left track control arm</i>	OE 60686892	<i>Lower right track control arm</i>
	4 Avec rotule <i>With ball joint</i>		3 Avec rotule <i>With ball joint</i>
	1.6i 16v. -12/01		1.6i 16v. -12/01
	1.6i 16v. TS Break 04/00-12/01		1.6i 16v. TS Break 04/00-12/01
	1.6i 16v. TS 01/03-		1.6i 16v. TS 01/03-
	1.8i 16v. -12/01		1.8i 16v. -12/01
	1.8i 16v. TS 140hp 144hp Break 04/00-12/01		1.8i 16v. TS 140hp 144hp Break 04/00-12/01
	1.8i 16v. TS 01/03-		1.8i 16v. TS 01/03-
	1.9 JTD -05/06		1.9 JTD -05/06
	2.0i 16v. -12/01		2.0i 16v. -12/01
	2.0 JTS 01/02-		2.0 JTS 01/02-
	2.0i 16v. TS 150hp 04/00-12/01		2.0i 16v. TS 150hp 04/00-12/01
	2.0i 16v. TS 155hp Break BV5/6 04/00-12/01		2.0i 16v. TS 155hp Break BV5/6 04/00-12/01
	2.0i 16v. TS /Selespeed BVM 01/03-		2.0i 16v. TS /Selespeed BVM 01/03-
	2.4 JTD -12/01		2.4 JTD -12/01
	2.4 JTD 136hp 140hp Break 04/00-12/01		2.4 JTD 136hp 140hp Break 04/00-12/01
	2.4 JTD 175hp 129kw 01/03-		2.4 JTD 175hp 129kw 01/03-
	2.5 V6 -12/01		2.5 V6 -12/01
	Sauf 190hp break BV5/BVA & 192hp break BV6 04/00-12/01		Sauf 190hp break BV5/BVA & 192hp break BV6 04/00-12/01
	2.5 V6 190hp Break 04/00-12/01		2.5 V6 190hp Break 04/00-12/01
	BVM BVA		BVM BVA
2.5i V6 24v. 01/03-	2.5i V6 24v. 01/03-		
3.2 01/02-07/03	3.2 01/02-07/03		



Barre stabilisatrice
Stabilizer bar
Barra estabilizadora
Drażek stabilizatora
 стабилизатор поперечной устойчивости

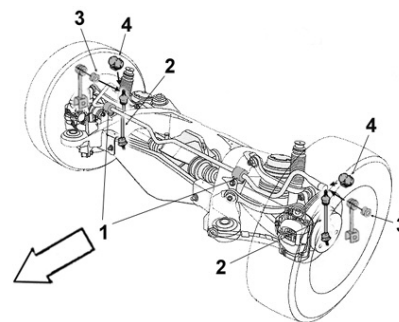

9005022	Biellette barre stab.
OE 60613575	<i>Stabilizer bar stub axle</i>
	2
	1.6i 16v. -12/01
	1.6i 16v. TS /Break 01/02-
	1.8i 16v. -12/01
	1.8i 16v. TS/ Break 01/02-
	1.9 JTD -12/01
	1.9 JTD 115hp 125hp 136hp 140hp /Break 01/02-
	1.9 JTD 150hp 110kw /4WD /Break 09/04-
	2.0i 16v. -12/01
	2.0 JTS /Selespeed /Break 07/02-12/05
	2.0i 16v. TS /Break 01/02-
	2.0 TS Selespeed /Break 01/03-
	2.4 JTD -12/01
	2.4 JTD 175hp 129kw /Break 01/02-
	2.5 V6 -12/01
2.5 V6 /Break 01/02-	
3.2i GTA /Selespeed /Break 07/03-12/05	

159

Eléments DIRECTION

Steering parts

Elementos Direcciones

Elementy układ kierowniczy

Элементы рулевой системы

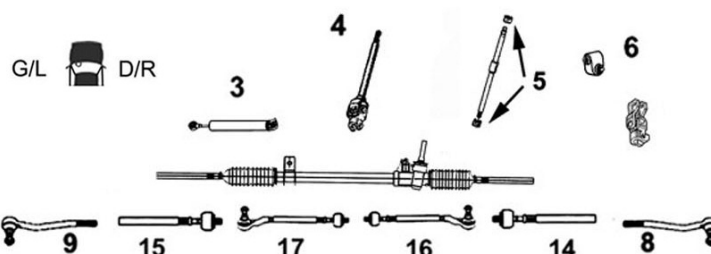
**7676061****Rotule de direction G**

OE 77363706

Left tie rod end

NEW

**9 M20 x 1.5**

TT /all models

7676060**Rotule de direction D**

OE 77363707

Right tie rod end

NEW

**8 M20 x 1.5**

TT /all models

Bras & Triangle de suspension

Control arm

Brazo y triángulo

Wahacz

Рычаг подвески

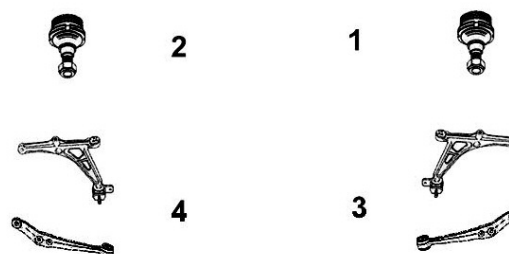
G/L  D/R**7476194****Triangle de susp. G Sup.**

OE 51787337

Upper left track control arm

NEW

**4 Avec rotule With ball joint**

TT /all models -02/08

7476195**Triangle de susp. D Sup.**

OE 51787336

Upper right track control arm

NEW

**3 Avec rotule With ball joint**

TT /all models -02/08

7476198**Triangle de susp. inf. G**

OE 51842925

Lower left track control arm

NEW

**4 Avec rotule With ball joint**

TT /all models

7476197**Triangle de susp. inf. D**

OE 51842924

Lower right track control arm

NEW

**3 Avec rotule With ball joint**

TT /all models

Eléments DIRECTION
 Steering parts
 Elementos Direcciones
 Elementy układ kierowniczy
 Элементы рулевой системы

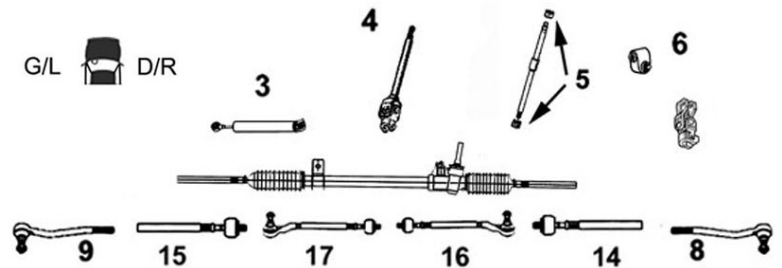



9006240 OE 60507910	Axe de bielle G/D L/R axial joint
	14 Côté dir. M14x1.5 Côté rot. M14x1.5 15 long 269 mm TT /all models Sauf 2.5TD

9006339 OE 60511622	Rotule de direction G/D L/R tie rod end
	8 M14 x 1.5 9 TT /all models 07/87-



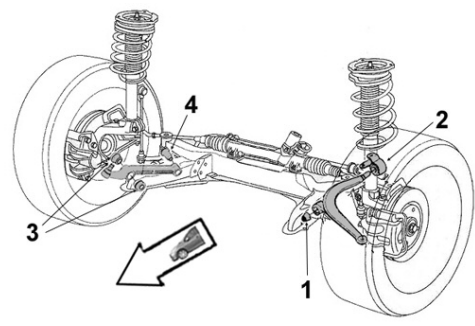

Eléments SUSPENSION
 Suspension parts
 Elementos suspensión
 Elementy zawieszenie
 Элементы подвески

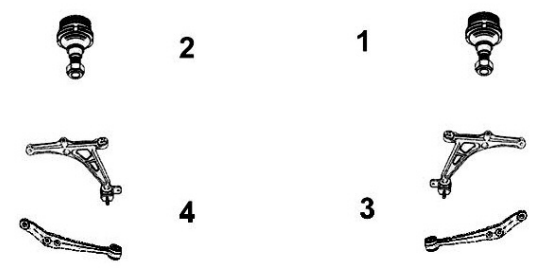

9003100 OE 82388433	Articulation Bush
	2.0 2.0 2.5 TD 3.0 V6 K K BVA

Bras & Triangle de suspension
 Control arm
 Brazo y triángulo
 Wahacz
 Рычаг подвески



9005151 OE 60801528	Triangle de susp. G Left track control arm
	4 Avec rotule With ball joint TT /all models / type K Sauf 3.0 V6

9005150 OE 60801529	Triangle de susp. D Right track control arm
	3 Avec rotule With ball joint TT /all models / type K Sauf 3.0 V6

Les réf. constructeurs (OE) ne servent qu'à identifier les pièces et sont données à titre indicatif.

166 ...

Eléments DIRECTION
 Steering parts
 Elementos Direcciones
 Elementy układ kierowniczy
 Элементы рулевой системы

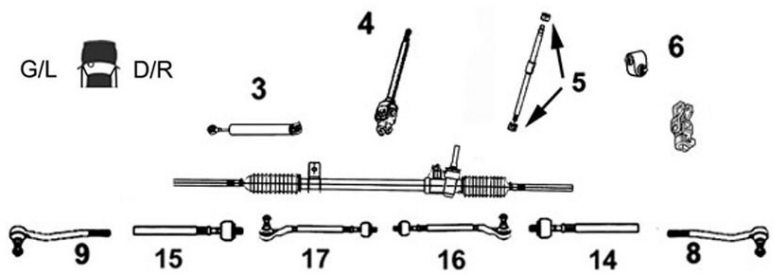

7776019 **Axe de bielle G/D**

OE 9948297 L/R axial joint

14 Côté dir. M16x1.5 Côté rot. M14x1.5 long 220 mm
15



2.0i	09/00-
2.0i 16v.	10/98-
2.0i Turbo	10/98-
2.4 JTD	10/98-
2.5 V6 24v.	10/98-
3.0i	10/98-
3.2i	10/03-

9006647 **Rotule de direction G**

OE 9947919 Left tie rod end

9

2.0i 16v.	-12/02
2.0 V6 Turbo	-12/02
2.4 JTD	
2.5 V6	BVM BVA
3.0 V6	BVM BVA
3.2	01/04-07/07



9006648 **Rotule de direction D**

OE 9947920 Right tie rod end

8

2.0i 16v.	-12/02
2.0 V6 Turbo	-12/02
2.4 JTD	
2.5 V6	BVM BVA
3.0 V6	BVM BVA
3.2i	01/04-07/07

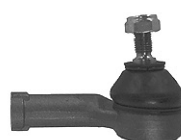

Barre stabilisatrice
 Stabilizer bar
 Barra estabilizadora
 Drażek stabilizatora
 стабилизатор поперечной устойчивости

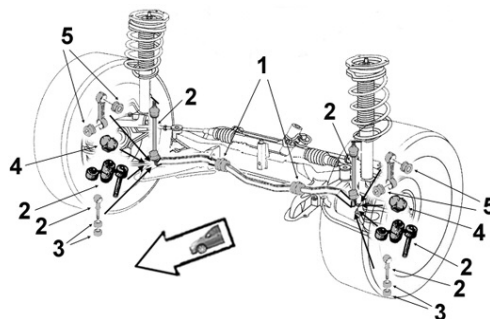

9005020 **Biellette barre stab.**

OE 60630757 Stabilizer bar stub axle

2

2.0i 16v.	-12/02
2.0i V6 Turbo	-12/02
2.4 JTD	-12/02
2.4 JTD	01/06-07/07
2.5 V6	-12/02
3.0 V6	-12/02



Bras & Triangle de suspension

Control arm
Brazo y triángulo
Wahacz
Рычаг подвески

G/L D/R

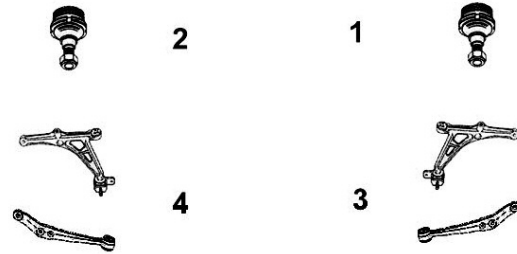

9005666 Triangle de susp. sup. G
OE 60666021 Upper left track control arm



4 Avec rotule With ball joint

2.0i		-12/02
2.0i		01/04-12/05
2.0 V6 Turbo		-12/02
2.4 JTD		-07/07
2.5 V6	BVM BVA	-12/02
3.0 V6	BVM BVA	-12/02
3.2		01/04-07/07

9005664 Triangle de susp. sup. D
OE 60666020 Upper right track control arm



3 Avec rotule With ball joint

2.0i		-12/02
2.0i		01/04-12/05
2.0 V6 Turbo		-12/02
2.4 JTD		-07/07
2.5 V6	BVM BVA	-12/02
3.0 V6	BVM BVA	-12/02
3.2		01/04-07/07

7476015 Triangle de susp. G
OE 60695895 Left track control arm



4 Avec rotule With ball joint

2.0i		10/98-12/05
2.0i V6 Turbo		10/98-09/00
2.4 JTD		09/98-07/07
2.5 V6 24v.		10/98-12/04
3.0i		10/98-12/05
3.2i		10/03-07/07

7476014 Triangle de susp. D
OE 60695896 Right track control arm



3 Avec rotule With ball joint

2.0i		10/98-12/05
2.0i V6 Turbo		10/98-09/00
2.4 JTD		09/98-07/07
2.5 V6 24v.		10/98-12/04
3.0i		10/98-12/05
3.2i		10/03-07/07



Barre stabilisatrice
Stabilizer bar
Barra estabilizadora
Drażek stabilizatora
стабилизатор поперечной устойчивости

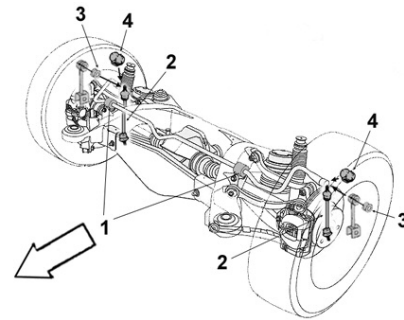

9005024 Biellette barre stab. G
OE 60628284 Left stabilizer bar stub axle



2

2.0i 16v.		-12/02
2.0 V6 Turbo		-12/02
2.4 JTD		-07/07
2.5 V6		-12/02
3.0 V6		-12/02

9005023 Biellette barre stab. D
OE 60628255 Right stabilizer bar stub axle



2

2.0i 16v.		-12/02
2.0 V6 Turbo		-12/02
2.4 JTD		-07/07
2.5 V6		-12/02
3.0 V6		-12/02

Arna

Eléments DIRECTION

Steering parts

Elementos Direcciones

Elementy układ kierowniczy

Элементы рулевой системы

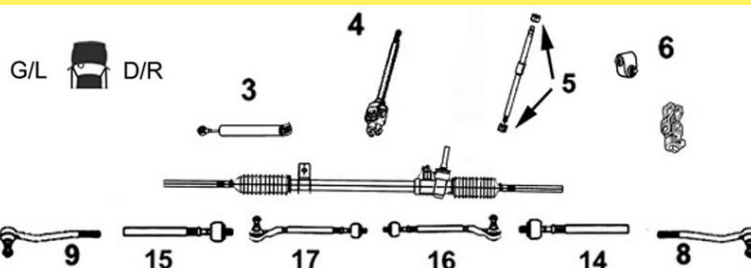

9006404

Rotule de direction G/D

OE 510615

L/R tie rod end

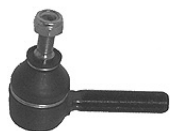
8
9

M14 x 1

TT /all models

Bras & Triangle de suspension

Control arm

Brazo y triángulo

Wahacz

Рычаг подвески

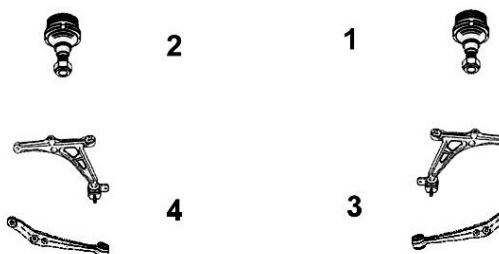
G/L  D/R

9005146

Bras de suspension D

OE 60501401

Right track control arm



3

Avec rotule With ball joint

TT /all models

Brera ...

Eléments DIRECTION

Steering parts

Elementos Direcciones

Elementy układ kierowniczy

Элементы рулевой системы

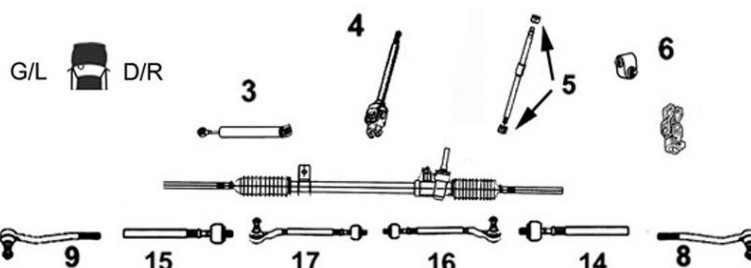

7676061

Rotule de direction G

OE 77363706

Left tie rod end

NEW



9

M20 x 1.5

TT /all models

7676060

Rotule de direction D

OE 77363707

Right tie rod end

NEW



8

M20 x 1.5

TT /all models

... Brera

Bras & Triangle de suspension

Control arm
Brazo y triángulo
Wahacz
Рычаг подвески

G/L  D/R

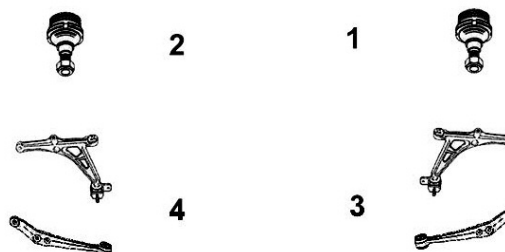

7476194 Triangle de susp. G Sup.
OE 51787337 Upper left track control arm

NEW



4 Avec rotule With ball joint

TT /all models -02/09

7476195 Triangle de susp. D Sup.
OE 51787336 Upper right track control arm

NEW



3 Avec rotule With ball joint

TT /all models -02/09

7476198 Triangle de susp. inf. G
OE 51842925 Lower left track control arm

NEW



4 Avec rotule With ball joint

TT /all models

7476197 Triangle de susp. inf. D
OE 51842924 Lower right track control arm

NEW



3 Avec rotule With ball joint

TT /all models

GT ...

Eléments DIRECTION

Steering parts
Elementos Direcciones
Elementy układ kierowniczy
Элементы рулевой системы

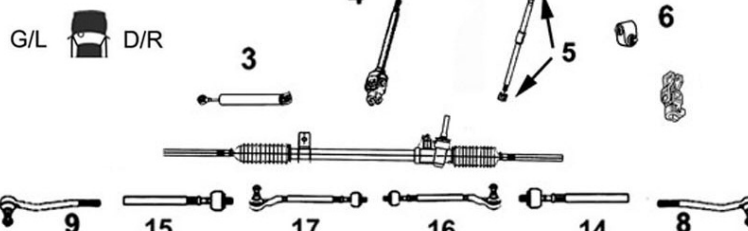

9006647 Rotule de direction G
OE 9947919 Left tie rod end

9



1.8i 16v.		03/04-
1.9 JTD	BVM6	03/04-
2.0 JTS		03/04-
3.2 V6	BVM6	03/04-

9006648 Rotule de direction D
OE 9947920 Right tie rod end

8

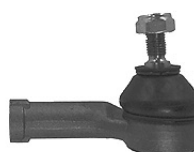

1.8i 16v.		03/04-
1.9 JTD	BVM6	03/04-
2.0 JTS		03/04-
3.2 V6	BVM6	03/04-

... GT ...



Barre stabilisatrice
 Stabilizer bar
 Barra estabilizadora
 Drażek stabilizatora
 стабилизатор поперечной устойчивости

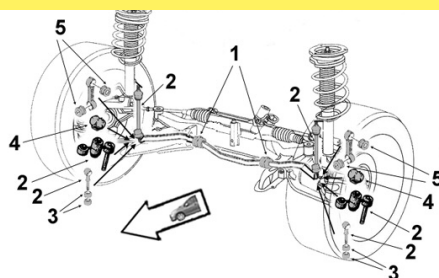

9005022 **Biellette barre stab.**
 OE 60613575 *Stabilizer bar stub axle*



2

1.8i 16v.
 1.9 JTD

03/04-
 03/08-

Bras & Triangle de suspension

Control arm
 Brazo y triángulo
 Wahacz
 Рычаг подвески

G/L D/R



9005661 **Triangle de susp. sup. G**
 OE 51834093 *Upper left track control arm*



4

Avec rotule *With ball joint*

1.9 JTD BVM6 03/04-
 2.0 JTS /TS Selespeed Coupé
 03/04-11/04
 2.0 JTS
 11/04-
 3.2 V6 BVM6 03/04-

9005660 **Triangle de susp. sup. D**
 OE 51834094 *Upper right track control arm*



3

Avec rotule *With ball joint*

1.9 JTD BVM6 03/04-
 2.0 JTS /TS Selespeed Coupé
 03/04-11/04
 2.0 JTS
 11/04-
 3.2 V6 BVM6 03/04-

9005663 **Triangle de susp. inf. G**
 OE 50509340 *Lower left track control arm*



4

Avec rotule *With ball joint*

1.8i 16V.
 1.9 JTD BVM6 03/04-
 2.0 JTS
 03/04-
 3.2 V6 BVM6 03/04-

9005662 **Triangle de susp. inf. D**
 OE 60686892 *Lower right track control arm*



3

Avec rotule *With ball joint*

1.8i 16V.
 1.9 JTD BVM6 03/04-
 2.0 JTS
 03/04-
 3.2 V6 BVM6 03/04-

... GT



Barre stabilatrice
 Stabilizer bar
 Barra estabilizadora
 Drażek stabilizatora
 стабилизатор поперечной устойчивости

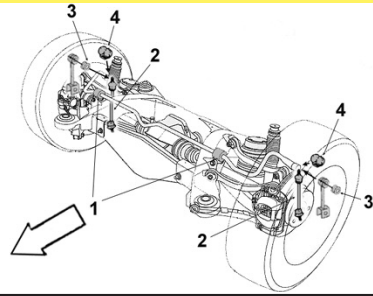

9005031

Biellette barre stab.

OE 46843389

Stabilizer bar stub axle

2



1.8i 16v.
 1.9 JTD

03/04-
 03/08-

GTV ...

Eléments DIRECTION
 Steering parts
 Elementos Direcciones
 Elementy układ kierowniczy
 Элементы рулевой системы

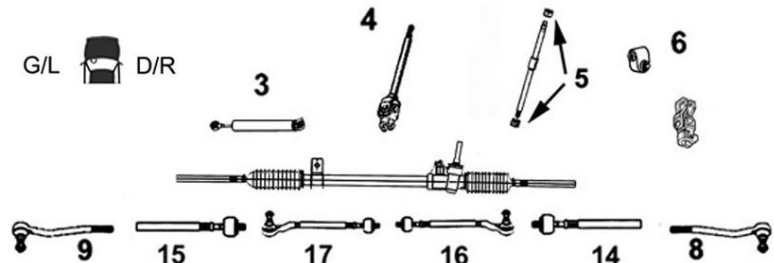

9006654

Rotule de direction G/D

OE 9947719

L/R tie rod end

8
9

M14 x 1.5

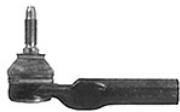

1.8 16v.
 2.0 TS
 2.0 JTS
 2.0 V6 Turbo
 3.0 V6
 3.2 V6 24v.

05/98-
 05/98-
 04/03-
 05/98-
 10/00-
 04/03-



Barre stabilatrice
 Stabilizer bar
 Barra estabilizadora
 Drażek stabilizatora
 стабилизатор поперечной устойчивости

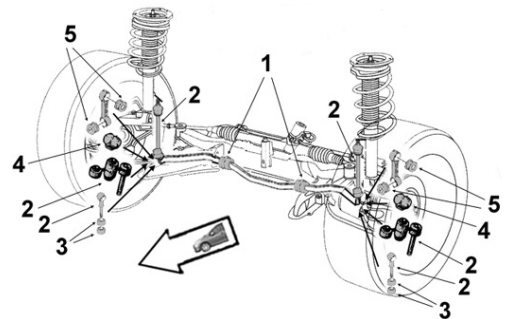

9005082

Biellette barre stab.

OE 60570627

Stabilizer bar stub axle

2



1.8
 2.0 CEE2 CEE3
 2.0i 16v. TS
 2.0 V6 Turbo

01/98-
 01/98-
 04/95-08/98
 01/98-

... GTV

Bras & Triangle de suspension

Control arm
Brazo y triángulo
Wahacz
Рычаг подвески

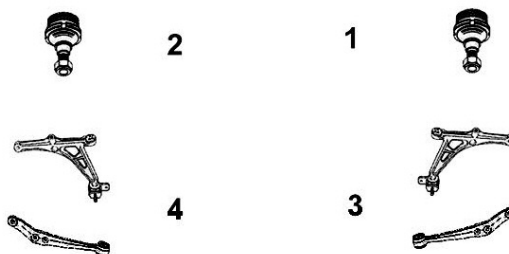
G/L  D/R**9005149**

OE 46474556

Triangle de susp. G*Left track control arm***9** Avec rotule With ball joint Ø17

1.8i 16v.		06/98-09/00
2.0i 16v. TS	AR32301	04/95-09/00
2.0i 16v. TS	AR16201	04/95-08/98
2.0i 16v. TS	AR16201	05/03-12/05
2.0i 16v. TS	AR32310	09/00-05/03
2.0i 16v. TS	AR32301	06/98-09/00
2.0 JTS		05/03-12/05
2.0i Turbo		04/95-09/00
3.0i V6 24v.	AR16102	03/97-05/03
3.0i V6 24v.	160kw AR16105	09/00-05/03
3.2i		05/03-12/05

**9005148**

OE 46474557

Triangle de susp. D*Right track control arm***8** Avec rotule With ball joint Ø17

1.8i 16v.		06/98-09/00
2.0i 16v. TS	AR32301	04/95-09/00
2.0i 16v. TS	AR16201	04/95-08/98
2.0i 16v. TS	AR16201	05/03-12/05
2.0i 16v. TS	AR32310	09/00-05/03
2.0i 16v. TS	AR32301	06/98-09/00
2.0 JTS		05/03-12/05
2.0i Turbo		04/95-09/00
3.0i V6 24v.	AR16102	03/97-05/03
3.0i V6 24v.	160kw AR16105	09/00-05/03
3.2i		05/03-12/05



Mito ...

Eléments DIRECTION

Steering parts
Elementos Direcciones
Elementy układ kierowniczy
Элементы рулевой системы

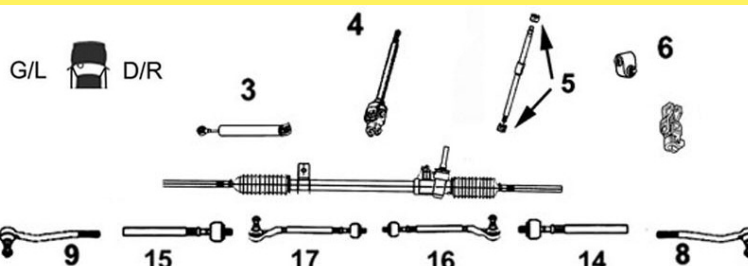
**7776038**

OE -

Axe de bielle G/D*L/R axial joint***14** Côté dir. M14x1.5 Côté rot. M14x1.5 long 293 mm

1.3 MJTD	09/08-
1.4i	09/08-
1.4i Turbo	09/08-
1.6 JTD	09/08-

**7676014**

OE 77363829

Rotule de direction G*Left tie rod end***9** M14 x 1.5

0.9 Turbo	11/11-
1.3 JTDM	10/08-
1.4i	09/08-
1.4i Turbo	10/08-
1.4i Turbo Multiair 99kw	01/10-
1.6 JTD FAP	09/08-

**7676013**

OE 77363830

Rotule de direction D*Right tie rod end***8** M14 x 1.5

0.9 Turbo	11/11-
1.3 JTDM	10/08-
1.4i	09/08-
1.4i Turbo	10/08-
1.4i Turbo Multiair 99kw	01/10-
1.6 JTD FAP	09/08-



... Mito ...



Barre stabilisatrice
Stabilizer bar
Barra estabilizadora
Drażek stabilizatora
стабилизатор поперечной устойчивости

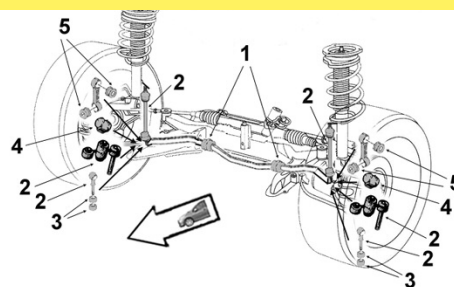

2306023

Biellette barre stab.

OE 55700753

Stabilizer bar stub axle



2

1.3 JTDM	199A3000	BVM	10/08-
1.3 JTDM FAP	199B1000	BVM	01/10-
1.4i	955A1000	BVM	09/08-
1.4i	955A6000	BVM	09/09-
1.4i Turbo	198A4000 199A8000	BVM	10/08-
1.4i Turbo QV	940A2000	BVM	01/10-
1.4i Turbo Multiair	955A2/7000		01/10-
1.6 JTD FAP	955A3000	BVM	09/08-



Eléments SUSPENSION

Suspension parts
Elementos suspensión
Elementy zawieszenie
Элементы подвески

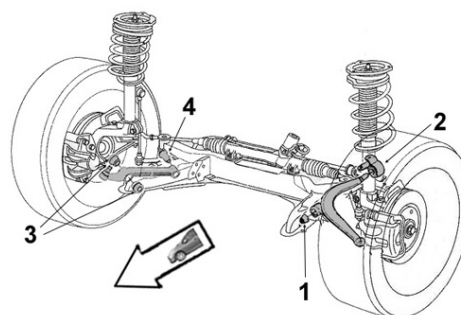

2256032

Articulation AV

Part/oe 51783056

Front bush



1

**Ø int. 12.5 Ø ext. 42 coll. 43 coll. 50.5
 long.tube int. 67.5 ext. 41**

1.3 JTDM		09/08-
1.4i	BVM	09/08-
1.4i 16v.	BVM	10/08-
1.4i Turbo	BVM	10/08-
1.4i Turbo Multiair	955A7000	
	BV Rob.	01/10-
1.6 JTD FAP	BVM	09/08-

2256009

Articulation AR

Part/oe 55700751

Rear bush



2

**Ø int. 12.5 Ø ext. 73
 long. tube int. 66 ext. 27.5**

1.4i	955A1000	BVM	09/08-
1.4i 16v.	199A6000	BVM	10/08-
1.4i Turbo	199A8000	BVM	10/08-
1.6 JTD FAP	955A3000	BVM	09/08-

Bras & Triangle de suspension

Control arm
Brazo y triángulo
Wahacz
Рычаг подвески

G/L D/R

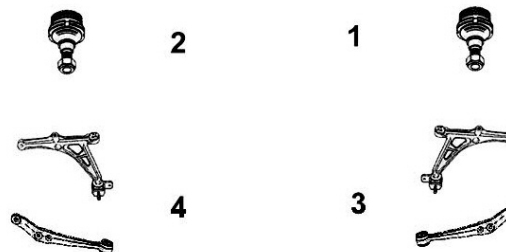

7470005

Triangle de susp. G

OE 51895367

Left track control arm



4

Avec rotule With ball joint

0.9i Turbo		07/11-
1.3 JTD		06/11-
1.4i 70hp 80hp 95hp 105hp		09/08-
1.4i Turbo 120hp 155hp		10/08-
	150hp 170hp	
1.4i Turbo Multiair 135hp 165hp		01/10-
1.6 JTD		09/08-

7470006

Triangle de susp. D

OE 51895366

Right track control arm



3

Avec rotule With ball joint

0.9i Turbo		07/11-
1.3 JTD		06/11-
1.4i 70hp 80hp 95hp 105hp		09/08-
1.4i Turbo 120hp 155hp		10/08-
	150hp 170hp	
1.4i Turbo Multiair 135hp 165hp		01/10-
1.6 JTD		09/08-

... Mito

Bras & Triangle de suspension

Control arm
Brazo y triángulo
Wahacz
Рычаг подвески

G/L  D/R

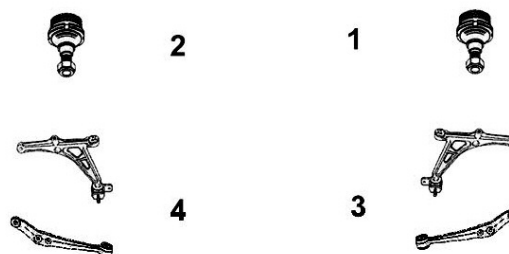

7570004

Rotule de susp. inf. G/D

Part/oe 51895367

L/R lower suspension ball joint



1
2

0.9i Turbo Twinair
1.3 JTD FAP
1.3 JTDM FAP
1.4i
1.4i 16v.
1.4i Turbo /Multiair
1.6 JTD FAP

11/11-
06/11-
17/02/11-
09/08-
09/08-
09/08-
09/08-



Support d'amortisseur

Suspension mounting
Soporte amortiguador
Poduszka amortyzatora
Опора амортизатора

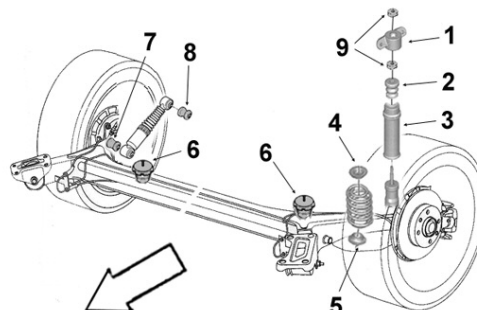

2656041

Support suspension G

OE 55701902

Left suspension mounting



4

1.3 JTDM FAP 199A3000	BVM6	10/08-
1.4i	955A1000	BVM6
1.4i Turbo	198A4000	BVM5
1.4i Turbo	199A8000	BVM6
1.6 JTD FAP	955A3000	BVM6

2656040

Support suspension D

OE 55701901

Right suspension mounting



3

1.3 JTDM FAP 199A3000	BVM6	10/08-
1.4i	955A1000	BVM6
1.4i Turbo	198A4000	BVM5
1.4i Turbo	199A8000	BVM6
1.6 JTD FAP	955A3000	BVM6

Spider ...

Eléments DIRECTION

Steering parts
Elementos Direcciones
Elementy uklad kierowniczy
Элементы рулевой системы

G/L  D/R

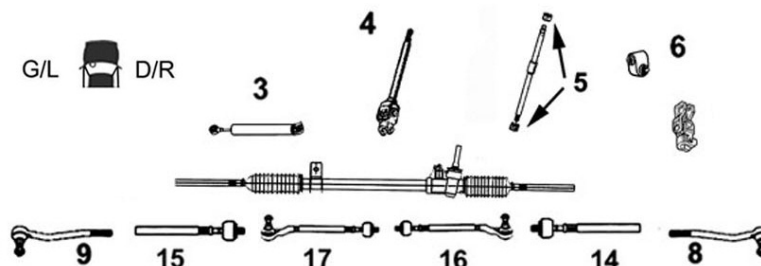

9006654

Rotule de direction G/D

OE 9947719

L/R tie rod end

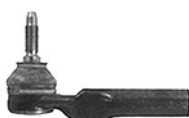













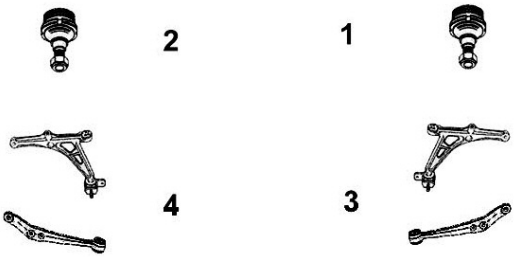

8
9

M14 x 1.5
1.8 16v.
2.0i 16v. TS
2.0 JTS
2.0 V6 Turbo
3.0 V6
3.2 V6

05/98-04/05
05/98-04/05
04/03-04/05
05/98-04/05
05/98-04/05
04/03-04/05

... Spider

... Spider			
7676061 OE 77363706	Rotule de direction G <i>Left tie rod end</i>	7676060 OE 77363707	Rotule de direction D <i>Right tie rod end</i>
 	4 M20 x 1.5 TT /all models 09/06-	 	3 M20 x 1.5 TT /all models 09/06-
<p>Bras & Triangle de suspension <i>Control arm</i> <i>Brazo y triángulo</i> <i>Wahacz</i> <i>Рычаг подвески</i></p>			
<p>G/L  D/R</p>			
			
9005149 OE 46474556	Triangle de susp. G <i>Left track control arm</i>	9005148 OE 46474557	Triangle de susp. D <i>Right track control arm</i>
	4 Avec rotule With ball joint Ø 17 BVM 1.8i 16v. 06/98-09/00 2.0 JTS 05/03-12/05 2.0i 16v. TS 06/98-12/05 3.0i /24v. 04/95-05/03 3.2i 05/03-12/05		3 Avec rotule With ball joint Ø 17 BVM 1.8i 16v. 06/98-09/00 2.0 JTS 05/03-12/05 2.0i 16v. TS 06/98-12/05 3.0i /24v. 04/95-05/03 3.2i 05/03-12/05
7476194 OE 51787337	Triangle de susp. G Sup. <i>Upper left track control arm</i>	7476195 OE 51787336	Triangle de susp. D Sup. <i>Upper right track control arm</i>
 	4 Avec rotule With ball joint TT /all models 09/06-02/09	 	3 Avec rotule With ball joint TT /all models 09/06-02/09
7476198 OE 51842925	Triangle de susp. inf. G <i>Lower left track control arm</i>	7476197 OE 51842924	Triangle de susp. inf. D <i>Lower right track control arm</i>
 	4 Avec rotule With ball joint TT /all models 09/06-	 	3 Avec rotule With ball joint TT /all models 09/06-

80 ...

SASIC

AUDI

Eléments DIRECTION
 Steering parts
 Elementos Direcciones
 Elementy układ kierowniczy
 Элементы рулевой системы

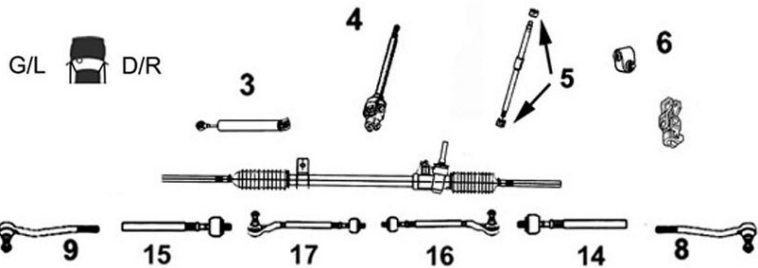

9006244 **Axe de bielle G**
 Part/oe 811419801E *Left axial joint*



15 M14x1.5
 TT /all models -12/81
 TT /all models 01/82-09/86
 TT /all models 4/5 cyl.
 sauf Quattro 09/86-09/91
 TT /all models 09/91-

9006245 **Axe de bielle D**
 Part/oe 811419802J *Right axial joint*



14 M14 x 1.5
 TT /all models -12/81
 TT /all models 01/82-09/86
 TT /all models 4/5 cyl.
 sauf Quattro 09/86-09/91
 TT /all models 4WD -09/91

9006300 **Rotule de direction G/D**
 OE 811419812A *L/R tie rod end*

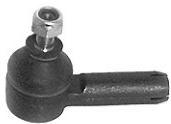

8 M14 x 1.5
 TT /all models Ch- 81A0173589 09/78-12/81
 TT /all models 01/82-09/86
 TT /all models 4/5 cyl. sauf Quattro 09/86-09/91
 TT /all models 09/91-
 TT /all models 4WD



Barre stabilisatrice
 Stabilizer bar
 Barra estabilizadora
 Drażek stabilizatora
 стабилизатор поперечной устойчивости

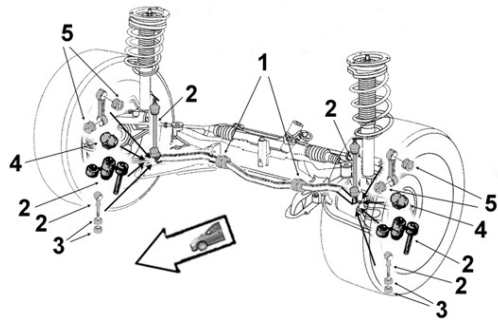

9005087 **Biellette barre stab.**
 OE 8A0407465 *Stabilizer bar stub axle*



2
 1.6i 01/92-
 1.9 TD 01/92-
 1.9 TDi 01/92-
 2.0 i /E /16v. 01/92-
 2.0i 16v. 01/92-
 2.3 E 01/92-
 2.6 E V6 01/92-

9001762 **Palier de barre bout**
 OE 893411327E *End bar main bearing*



4 Ø 22
 1.6i 01/92-
 1.9 TD 01/92-
 1.9 TDi 01/92-
 2.0 i /E /16v. 01/92-

9001505 **Palier de barre bout**
 OE 823411313A *End bar main bearing*



Barre Ø 21 -ch 8A1038757
 1.6 D
 1.6 TD
 1.8 i
 1.9 SDi
 2.0i

9001504 **Palier de barre milieu**
 OE 811411327A *Middle bar main bearing*



Barre Ø 21 -ch 8A1038757
 1.6 D
 1.6 TD
 1.8 i
 1.9 SDi
 2.0i



Eléments SUSPENSION
Suspension parts
Elementos suspensión
Elementy zawieszenie
Элементы подвески

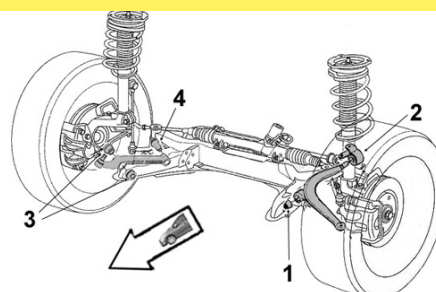

AUDI



9001506 Articulation AV/AR

OE 8A0407181 *Front rear bush*



Ø int.10	Ø ext.37	coll.46	long. tube int. 41.5	ext.34	ep. coll.4	
1.6i			DA			07/93-06/95
1.6 D/ TD			DA			01/87-
1.8/i			DA			01/87-
1.9 SDi			DA			01/87-
1.9 TD			DA			11/91-06/95
1.9 TDi			DA			02/92-06/95
2.0i			DA			01/87-
2.3 i/E 4WD			DA			11/91-06/95
2.6 E V6			DA			10/92-06/95

9001503 Articulation AV/AR

OE 811407181A *Front rear bush*



Ø int.10	Ø ext.38	coll.47	long. tube int. 44	ext.24	ep. coll.8	
1.6 D			DNA			01/87-
1.6 TD			DNA			01/87-
1.8			DNA			01/87-
1.8i			DNA			01/87-
1.9 SDi			DNA			01/87-
2.0i			DNA			01/87-

Bras & Triangle de suspension

Control arm
Brazo y triángulo
Wahacz
Рычаг подвески

G/L D/R

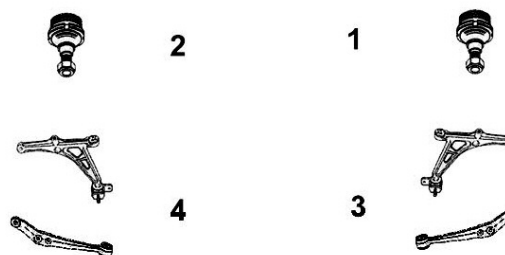

9005200 Rotule de susp. inf. G/D

OE 823407365E *L/R lower suspension ball joint*



1	2	Ø 17		
		TT /all models		09/77-12/81
		TT /all models	DNA	01/82-09/86

9005201 Rotule de susp. inf. G

OE 855407365A *Left lower suspension ball joint*



2	Ø 17	Trous Oublon		
		TT /all models	DA	01/82-09/86
		TT /all models 4WD		01/81-
		TT /all models sauf 2.3D sauf Quattro	DA 4/5 cyl.	09/86-03/88

Bras & Triangle de suspension

Control arm
Brazo y triángulo
Wahacz
Рычаг подвески

G/L  D/R

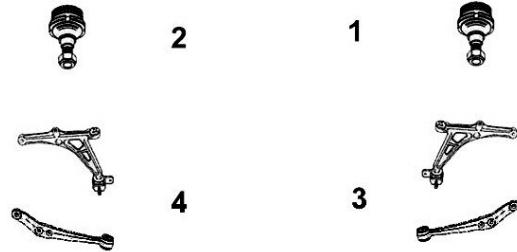

9005209 Rotule de susp. inf. G
OE 893407365A *Left lower susp. ball joint*



2 Ø 19
TT /all models 01/90-09/91
sauf 2.3D sauf Quattro DNA 4 cyl.

9005208 Rotule de susp. inf. D
OE 893407366A *Right lower susp. ball joint*



1 Ø 19
TT /all models 01/90-09/91
sauf 2.3D sauf Quattro DNA 4 cyl.

9005203 Rotule de susp. inf. G
OE 893407365F *Left lower susp. ball joint*



2 Ø 19
TT /all models 03/88-09/91
sauf 2.3 170hp 125kw et 2.3D
sauf Quattro DA 4/5 cyl.
TT /all models 4WD
Sauf 2.3 170hp 125kw Ch- 89J351001

9005204 Rotule de susp. inf. D
OE 893407366F *Right lower susp. ball joint*



1 Ø 19
TT /all models 03/88-09/91
sauf 2.3 170hp 125kw et 2.3D
sauf Quattro DA 4/5 cyl.
TT /all models 4WD
Sauf 2.3 170hp 125kw Ch- 89J351001

9005516 Rotule de susp. inf. G
OE 893407365E *Left lower susp. ball joint*



2
2.3 09/86-09/91

9005517 Rotule de susp. inf. D
OE 893407366E *Right lower susp. ball joint*



1
2.3 09/86-09/91

9005206 Rotule de susp. inf. G
OE 8A0407365 *Left lower susp. ball joint*



2 Ø 19
TT /all models Sauf V6 09/91-
TT /all models 4WD 09/91-

9005207 Rotule de susp. inf. D
OE 8A0407366 *Right lower susp. ball joint*

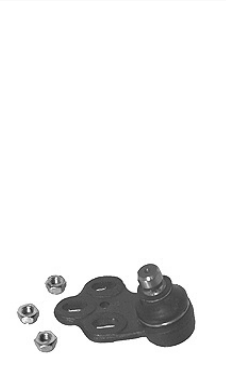

1 Ø 19
TT /all models Sauf V6 09/91-
TT /all models 4WD 09/91-



Support d'amortisseur
 Suspension mounting
 Soporte amortiguador
 Poduszka amortyzatora
 Опора амортизатора

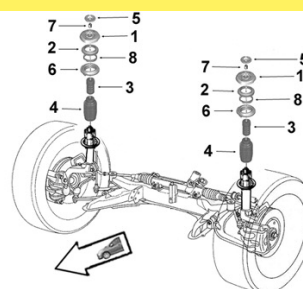

AUDI



9005324 Butée de suspension G/D

OE 893412131B L/R suspension bush



3

1.4	-08/91	1.9i	-08/91
1.6i	09/91-06/95	1.9 SDi	08/89-
1.6	-08/91	1.9 TD	09/91-06/95
1.6 E	09/91-06/95	1.9 TDi	09/91-06/95
1.6 D	09/86-	2.0 /i /E /16v.	09/91-06/95
1.6 TD	09/86-	2.0i	-08/91
1.8	-08/91	2.0 /i E	09/91-06/95
1.8i	-08/91	2.0 4WD	09/91-06/95

Eléments TRAIN ARRIERE

Rear axle parts
 Tren TRAS
 Elementy zawieszenia tylnego
 элементы задней оси.



9001546 Articulation

OE 431505172 Bush



Ø int.12 Ø ext.34 coll.34 long. tube int.40 ext.20 ep. coll.2

1.4	01/87-12/92
1.6	01/87-12/92
1.6 D	01/87-12/92
1.6 TD	01/87-12/92
1.8	01/87-12/92
1.8i	01/87-12/92
1.9 SDi	01/87-12/92
2.0i	01/87-12/92

9001552 Articulation essieu AR

OE 811511247 Rear axle bush



Ø int.12 Ø ext.41.5 long. tube int.38 ext.28

1.3	01/79-07/86	1.9	07/81-07/83
1.4	09/86-07/88	1.9 SDi	08/89-08/91
1.6	01/79-08/91	2.0 /i /E	08/83-08/86
1.6 D	08/81-08/91	2.0i	07/88-09/91
1.6 TD	08/81-08/91	2.0i 16v.	07/88-09/91
1.8	08/81-08/91	2.2i WE	08/81-
1.8i	09/86-08/91		

9001553 Articulation essieu AR

OE 8A0501541 Rear axle bush



Ø int.12 Ø ext.56.5 coll.70.5 long. tube int.90 ext.82 ep. coll.7

1.6i	09/91-01/96
1.6 E	09/91-01/96
1.9 TD TDi	09/91-01/96
2.0 /i /E /16v.	09/91-01/96
2.0 /i /E 16v.	ACE 6A
2.3 E	09/91-01/96
2.6 E V6	09/91-01/96
2.8i V6 E	09/91-01/96

90 ...

SASIC

AUDI

Eléments DIRECTION
 Steering parts
 Elementos Direcciones
 Elementy układ kierowniczy
 Элементы рулевой системы

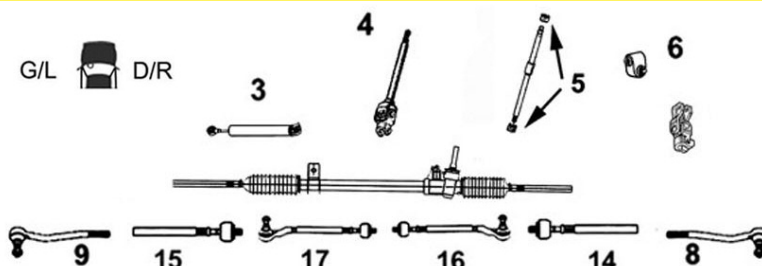

9006244 **Axe de bielle G**
 Part/oe 811419801E *Left axial joint*



15 M14x1.5
 TT /all models 01/84-09/86
 TT /all models 4/5 cyl. 09/86-09/91
 sauf Quattro

9006245 **Axe de bielle D**
 Part/oe 811419802J *Right axial joint*



14 M14x1.5
 TT /all models 01/84-09/86
 TT /all models 4/5 cyl. 09/86-09/91
 sauf Quattro

9006245 **Axe de bielle G/D**
 Part/oe 811419802J *L/R axial joint*



14
15 M14x1.5
 TT /all models -09/91

9006300 **Rotule de direction G/D**
 OE 811419812A *L/R tie rod end*



8
9 M14x1.5
 TT /all models 01/84-09/86
 TT /all models 4/5 cyl. 09/86-09/91
 sauf Quattro
 TT /all models 4WD

Bras & Triangle de suspension

Control arm
 Brazo y triángulo
 Wahacz
 Рычаг подвески

G/L D/R

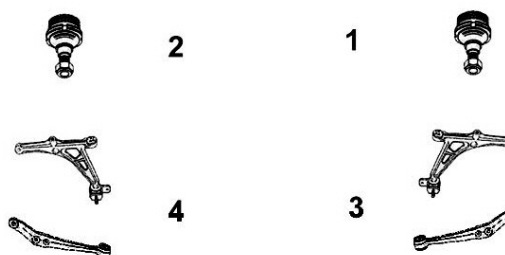

9005200 **Rotule de susp. inf. G/D**
 OE 823407365E *L/R lower suspension ball joint*



1
2 Ø17
 TT /all models DNA 01/84-09/86
 Sauf 2.0 5 cyl.

9005203 **Rotule de susp. inf. G**
 OE 893407365F *Left lower susp. ball joint*





2 Ø19
 TT /all models 03/88-09/91
 sauf 2.3 125kw et 2.3D
 sauf Quattro 4 et 5 cyl. DA + 90TD
 TT /all models 4WD
 Sauf 2.3 125kw Ch- 89J351001

9005204 **Rotule de susp. inf. D**
 OE 893407366F *Right lower susp. ball joint*





1 Ø19
 TT /all models 03/88-09/91
 sauf 2.3 170hp 125kw et 2.3D
 sauf Quattro 4 et 5 cyl. DA + 90TD
 TT /all models 4WD
 Sauf 2.3 170hp 125kw Ch- 89J351001

... 90

9005209 OE 893407365A	Rotule de susp. inf. G <i>Left lower susp. ball joint</i>	9005208 OE 893407366A	Rotule de susp. inf. D <i>Right lower susp. ball joint</i>
	2 Ø19 TT /all models 01/90-09/91 sauf 2.3D sauf Quattro DNA 4 cyl.		1 Ø19 TT /all models 01/90-09/91 sauf 2.3D sauf Quattro DNA 4 cyl.



9005201 OE 855407365A	Rotule de susp. inf. G <i>Left lower suspension ball joint</i>
	2 Ø17 Trous Oublon TT /all models DA 01/84-09/86 TT /all models 4/5 cyl. 09/86-03/88 sauf 2.3D sauf Quattro DA + 90TD TT /all models 4WD 01/81-

9005516 OE 893407365E	Rotule de susp. inf. G <i>Left lower susp. ball joint</i>	9005517 OE 893407366E	Rotule de susp. inf. D <i>Right lower susp. ball joint</i>
	2 2.3 sauf Quattro 09/86-09/91		1 2.3 sauf Quattro 09/86-09/91

100 ...

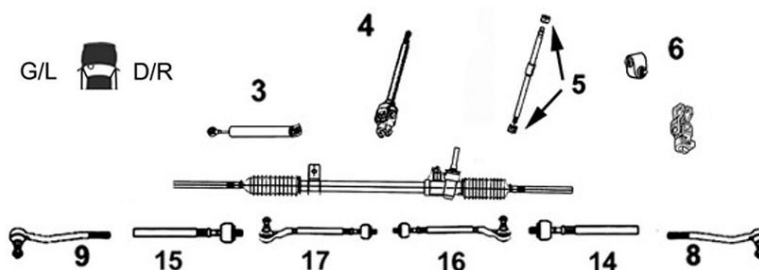
Eléments DIRECTION
Steering parts
Elementos Direcciones
Elementy uklad kierowniczy
Элементы рулевой системы



9006302 OE 443419811D	Rotule de direction G <i>Left tie rod end</i>	9006301 OE 443419812D	Rotule de direction D <i>Right tie rod end</i>
	9 M16 x 1.5 TT /all models 08/82-07/91 Sauf quattro TT /all models 4WD 01/85-12/90		8 M16 x 1.5 TT /all models 08/82-07/91 Sauf quattro TT /all models 4WD 01/85-12/90



Eléments SUSPENSION
Suspension parts
Elementos suspensión
Elementy zawieszenie
Элементы подвески

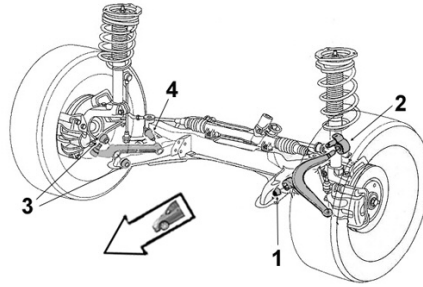

9001545

Art. int. bras

OE 4A0407183D

Arm inner bush



Ø int.14.5 Ø ext.54.5
 long. tube int.48 ext.31

2.0	01/91-06/94
2.0i /16v.	01/91-06/94
2.3/i	01/91-06/94
2.5 TDi	01/91-06/94
2.6/i V6	01/91-06/94
2.8/i V6	01/91-06/94

9001544

Articulation ext.

OE 4A0407181A

Outer bush



Ø int.16.5 Ø ext.45 coll.63
 long. tube int.23 ext.14 ep. coll.6.5

2.0	01/91-06/94
2.0i /16v.	01/91-06/94
2.3/i	01/91-06/94
2.5 TDi	01/91-06/94
2.6/i V6	01/91-06/94
2.8/i V6	01/91-06/94

Bras & Triangle de suspension

Control arm
Brazo y triángulo
Wahacz
Рычаг подвески

G/L D/R

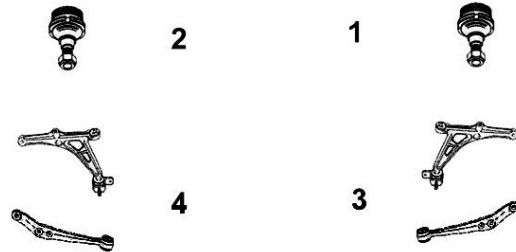

9005158

Bras de suspension D

OE 437407152A

Right track control arm



3 Avec rotule *With ball joint*

DA Ch 43C022303-44M050000

TT /all models
 TT /all models 4WD

08/82-07/91
 01/85-12/90

Eléments TRAIN ARRIERE

Rear axle parts
Tren TRAS
Elementy zawieszenia tylnego
элементы задней оси.



9001546

Articulation

OE 431505172

Bush



Ø int.12 Ø ext.34 coll.34 long. tube int.40 ext.20 ep. coll.2

1.8	01/87-06/94
2.0/i/ 16v.	01/87-06/94
2.0 D/TD	01/87-06/94
2.2/i	01/87-06/94
2.3/i	01/87-06/94
2.5 TDi	01/87-06/94
2.6/i V6	01/87-06/94
2.8/i V6	01/87-06/94

200

Eléments DIRECTION

Steering parts

Elementos Direcciones

Elementy układ kierowniczy

Элементы рулевой системы

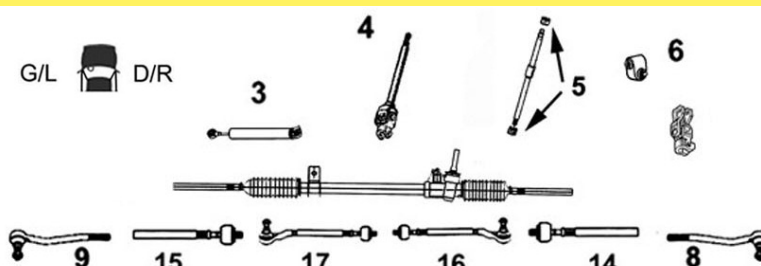

9006302

Rotule de direction G

OE 443419811D

Left tie rod end



9 M16 x 1.5

TT /all models 01/84-12/88
TT /all models 4WD 01/85-12/90

9006301

Rotule de direction D

OE 443419812D

Right tie rod end



8 M16 x 1.5

TT /all models 01/84-12/88
TT /all models 4WD 01/85-12/90

Bras & Triangle de suspension

Control arm

Brazo y triángulo

Wahacz

Рычаг подвески

G/L D/R

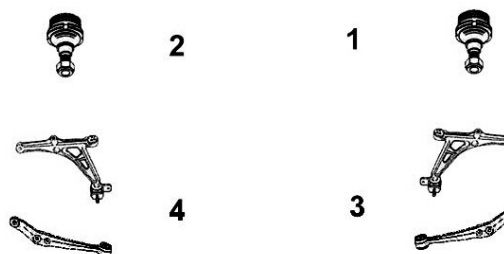

9005158

Bras de suspension D

OE 437407152A

Right track control arm



3 Avec rotule With ball joint

TT /all models DA Ch 43C022303-44M050000
TT /all models 4WD DA Ch 43C022303-44M050000

01/84-12/88
01/85-12/90

A1 ...



Barre stabilisatrice

Stabilizer bar

Barra estabilizadora

Drażek stabilizatora

стабилизатор поперечной устойчивости

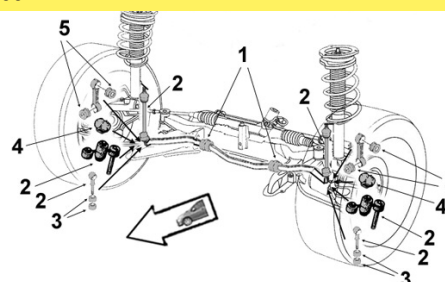

9005089

Bielle barre stab.

OE 6Q0411315N

Stabilizer bar stub axle



1.2 TSi CBZA BVM 09/10-
1.4 TFSi CAVG CAXA
BVM BV rob. 09/10-

1.6 TDi FAP CAYB CAYC
BVM BV rob. 09/10-

2.0 TDi CFHB CFHD 09/11-

2306018

Palier de barre milieu

OE 6Q0411314Q

Middle bar main bearing



Barre Ø 19

1.2 TFSi TSi 09/10-
1.4 TFSi 09/10-
1.6 TDI 09/10-

... A1 ...



Eléments SUSPENSION

Suspension parts
Elementos suspensión
Elementy zawieszenie
Элементы подвески

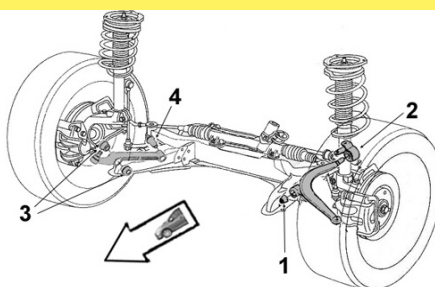

SASIC

AUDI

9001523

Articulation AV

OE 357407182

Front bush



Ø int.12 Ø ext.33 coll.36
long. tube int.54 ext.29 ep. coll.5

1.2 TSi TFSi	09/10-
1.4 TFSi	09/10-
1.6 TDi	03/11-
2.0 TDi	03/11-

9001542

Articulation AR

OE 1J0407181

Rear bush



Ø int.13 Ø ext.59.5
long. tube int.41 ext.23.5

1.2 TSi TFSi	09/10-
1.4 TFSi	09/10-
1.6 TDi	03/11-
2.0 TDi	03/11-

Bras & Triangle de suspension

Control arm
Brazo y triángulo
Wahacz
Рычаг подвески

G/L D/R

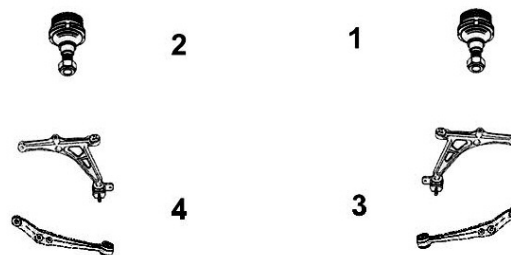

7476091

Triangle de susp. inf. G

OE 6R0407151F

Lower left track control arm

NEW



4 Sans rotule Without ball joint

1.2 TSi /TFSi	CBZA	BVM	09/10-
1.4 TFSi	CAVG/XA		09/10-
1.6 TDi FAP	CAYB/C	BVM	09/10-
2.0 TDi FAP	CFHB/D		09/11-

7476092

Triangle de susp. inf. D

OE 6R0407152F

Lower right track control arm

NEW



3 Sans rotule Without ball joint

1.2 TSi /TFSi	CBZA	BVM	09/10-
1.4 TFSi	CAVG/XA		09/10-
1.6 TDi FAP	CAYC/B	BVM	09/10-
2.0 TDi FAP	CFHB/D		09/11-

7476183

Triangle de susp. inf. G

OE 6R0407151F+6R0407365A Lower L track control arm

NEW



4 Avec rotule With ball joint

1.2 TSi /TFSi	CBZA	BVM	09/10-
1.4 TFSi	CAVG/XA		09/10-
1.6 TDi FAP	CAYB /C		09/10-
2.0 TDi FAP	CFHB /D		09/11-

7476184

Triangle de susp. inf. D

OE 6R0407152F+6R0407366A Lower R track control arm

NEW



3 Avec rotule With ball joint

1.2 TSi /TFSi	CBZA	BVM	09/10-
1.4 TFSi	CAVG/XA		09/10-
1.6 TDi FAP	CAYB /C		09/10-
2.0 TDi FAP	CFHB /D		09/11-

7576019

Rotule de susp. inf. G

OE 6R0407365A

Left lower susp. ball joint

NEW



2

1.2 TSi /TFSi	CBZA	BVM	09/10-
1.4 TFSi	CAVG/XA		09/10-
1.6 TDi FAP	CAYB /C		09/10-
2.0 TDi FAP	CFHB /D		09/11-

7576020

Rotule de susp. inf. D

OE 6R0407366A

Right lower susp. ball joint

NEW



1

1.2 TSi /TFSi	CBZA	BVM	09/10-
1.4 TFSi	CAVG/XA		09/10-
1.6 TDi FAP	CAYB /C		09/10-
2.0 TDi FAP	CFHB /D		09/11-

... A1



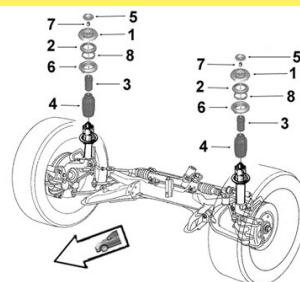

Support d'amortisseur
 Suspension mounting
 Soporte amortiguador
 Poduszka amortyzatora
 Опора амортизатора



AUDI





9005614 OE 1J0412331C Tampon suspension AV G/D <i>L/R front suspension rebound stop</i>	9005338 OE 1H0412303B Butée de suspension <i>Shock bush</i>																																								
 <div style="display: flex; align-items: center;"> <div style="border: 1px solid black; padding: 2px; margin-right: 5px;">1</div> <table style="font-size: small;"> <tr><td>1.2 TSi</td><td>CBZA</td><td>BVM</td><td>09/10-</td></tr> <tr><td>1.4 TFSi</td><td>CAVG/XA</td><td>BVM BV rob.</td><td>09/10-</td></tr> <tr><td>1.6 TDi</td><td>FAP CAYB/C</td><td>BVM</td><td>09/10-</td></tr> <tr><td>2.0 TDi</td><td>FAP CFHB/D</td><td></td><td>09/11-</td></tr> </table> </div>	1.2 TSi	CBZA	BVM	09/10-	1.4 TFSi	CAVG/XA	BVM BV rob.	09/10-	1.6 TDi	FAP CAYB/C	BVM	09/10-	2.0 TDi	FAP CFHB/D		09/11-	 <div style="display: flex; align-items: center;"> <div style="border: 1px solid black; padding: 2px; margin-right: 5px;">3</div> <table style="font-size: small;"> <tr><td>H64</td><td></td><td></td><td></td></tr> <tr><td>1.2 TSi</td><td>CBZA</td><td>BVM</td><td>09/10-</td></tr> <tr><td>1.4 TFSi</td><td>CAVG/XA</td><td>BVM BV rob.</td><td>09/10-</td></tr> <tr><td>1.6 TDi</td><td>Châssis sport</td><td></td><td>05/10-</td></tr> <tr><td>1.6 TDi</td><td>FAP CAYB/C</td><td>BVM</td><td>09/10-</td></tr> <tr><td>2.0 TDi</td><td>Châssis sport</td><td>CFHD</td><td>09/11-</td></tr> </table> </div>	H64				1.2 TSi	CBZA	BVM	09/10-	1.4 TFSi	CAVG/XA	BVM BV rob.	09/10-	1.6 TDi	Châssis sport		05/10-	1.6 TDi	FAP CAYB/C	BVM	09/10-	2.0 TDi	Châssis sport	CFHD	09/11-
1.2 TSi	CBZA	BVM	09/10-																																						
1.4 TFSi	CAVG/XA	BVM BV rob.	09/10-																																						
1.6 TDi	FAP CAYB/C	BVM	09/10-																																						
2.0 TDi	FAP CFHB/D		09/11-																																						
H64																																									
1.2 TSi	CBZA	BVM	09/10-																																						
1.4 TFSi	CAVG/XA	BVM BV rob.	09/10-																																						
1.6 TDi	Châssis sport		05/10-																																						
1.6 TDi	FAP CAYB/C	BVM	09/10-																																						
2.0 TDi	Châssis sport	CFHD	09/11-																																						

9005327 OE 357413175A Protecteur amortisseur G/D <i>L/R shock absorber protector</i>	4 H221.5																				
	<table style="font-size: small;"> <tr><td>1.2 TSi</td><td>CBZA</td><td>BVM</td><td>09/10-</td></tr> <tr><td>1.4 TFSi</td><td>CAVG/XA</td><td>BVM BV rob.</td><td>09/10-</td></tr> <tr><td>1.6 TDi</td><td></td><td></td><td>05/10-</td></tr> <tr><td>1.6 TDi</td><td>FAP CAYB/C</td><td>BVM</td><td>09/10-</td></tr> <tr><td>2.0 TDi</td><td></td><td></td><td>09/10-</td></tr> </table>	1.2 TSi	CBZA	BVM	09/10-	1.4 TFSi	CAVG/XA	BVM BV rob.	09/10-	1.6 TDi			05/10-	1.6 TDi	FAP CAYB/C	BVM	09/10-	2.0 TDi			09/10-
1.2 TSi	CBZA	BVM	09/10-																		
1.4 TFSi	CAVG/XA	BVM BV rob.	09/10-																		
1.6 TDi			05/10-																		
1.6 TDi	FAP CAYB/C	BVM	09/10-																		
2.0 TDi			09/10-																		

A2 ...

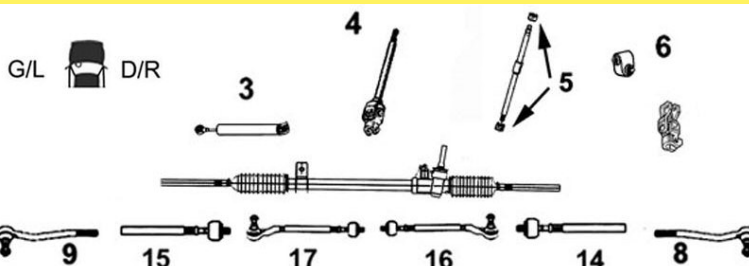
Eléments DIRECTION
 Steering parts
 Elementos Direcciones
 Elementy układ kierowniczy
 Элементы рулевой системы



9006634 OE 8Z0423811A Rotule de direction G <i>Left tie rod end</i>	9006635 OE 8Z0423812A Rotule de direction D <i>Right tie rod end</i>																																
 <div style="display: flex; align-items: center;"> <div style="border: 1px solid black; padding: 2px; margin-right: 5px;">9</div> <table style="font-size: small;"> <tr><td>M14 x 1.5</td><td></td><td></td><td></td></tr> <tr><td>1.4i 16v.</td><td></td><td>07/00-12/05</td><td></td></tr> <tr><td>1.4 TDi</td><td></td><td>10/00-12/05</td><td></td></tr> <tr><td>1.6 FSi</td><td></td><td>06/02-12/05</td><td></td></tr> </table> </div>	M14 x 1.5				1.4i 16v.		07/00-12/05		1.4 TDi		10/00-12/05		1.6 FSi		06/02-12/05		 <div style="display: flex; align-items: center;"> <div style="border: 1px solid black; padding: 2px; margin-right: 5px;">8</div> <table style="font-size: small;"> <tr><td>M14 x 1.5</td><td></td><td></td><td></td></tr> <tr><td>1.4i 16v.</td><td></td><td>07/00-12/05</td><td></td></tr> <tr><td>1.4 TDi</td><td></td><td>10/00-12/05</td><td></td></tr> <tr><td>1.6 FSi</td><td></td><td>06/02-12/05</td><td></td></tr> </table> </div>	M14 x 1.5				1.4i 16v.		07/00-12/05		1.4 TDi		10/00-12/05		1.6 FSi		06/02-12/05	
M14 x 1.5																																	
1.4i 16v.		07/00-12/05																															
1.4 TDi		10/00-12/05																															
1.6 FSi		06/02-12/05																															
M14 x 1.5																																	
1.4i 16v.		07/00-12/05																															
1.4 TDi		10/00-12/05																															
1.6 FSi		06/02-12/05																															

... A2



Support d'amortisseur
 Suspension mounting
 Soporte amortiguador
 Poduszka amortyzatora
 Опора амортизатора

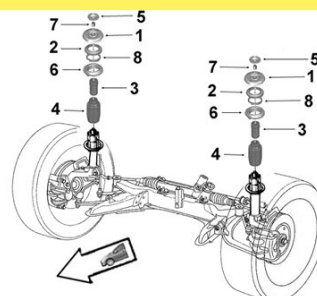

2656053

Protecteur amortisseur G/D

OE 6N0413175A

L/R shock absorber protector

4 H206



1.2 TDi
 1.4
 1.4 TDi
 1.6 FSi

A3 ...

Eléments DIRECTION

Steering parts

Elementos Direcciones

Elementy uklad kierowniczy

Элементы рулевой системы

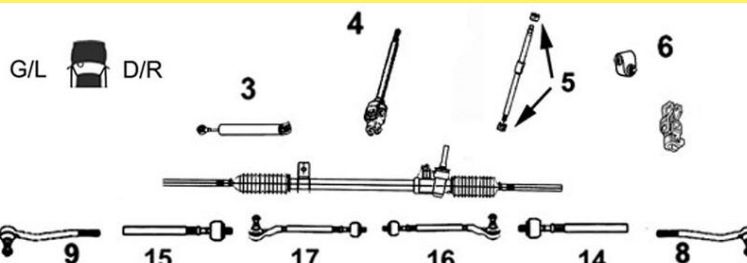

9006873

Axe de bielle G/D

OE 1K0423810A

L/R axial joint

14 Côté dir. M16x1.5 Côté rot. M16x1.5 long 310 mm

15

1.2 TSi /Sportback /Cab.		10/09-
1.4 TFSi /Sportback		09/07-
1.6i 75kw /sportback	BGU BSE	06/03-
1.6i /Sportback		06/03-
1.6 FSi 85kw 3ptes	BAG /LF/LP	06/03-
1.6 FSi Sportback 5ptes	BVM/Tiptronic	
1.6 TDi /Sportback /Cab.		04/09-
1.8 TFSi /Sportback /4WD /Cab.		06/06-
1.9 TDi 77kw /Sportback /Cab.		06/03-
1.9 TDi Sportback 5ptes		
2.0 FSi /Sportback	BV Tiptronic	06/03-
2.0 TFSi /Sportback /4WD S3	BVM	
2.0 TFSi /Sportback /4WD S3 /Cab.	BV rob.	
2.0 TFSi 4WD Sportback S3		
2.0 TDi 3ptes		06/03-
2.0 TDi Sportback 5ptes	BVM/ BV rob.	
2.0 TDi /Sportback /4WD /Cab.	BVM	06/03-
2.0 TDi DPF /Sportback /Cab.	BV rob.	02/08-
3.2 4WD /Sportback		



9006213

Axe de bielle G/D

Part/oe 1J0422803A

L/R axial joint

14 Côté dir. M16x1.5 Côté rot. M14x1.5 long 338 mm

15

1.6 3ptes	-ch 8LW050421	AEH AKL APF AGN		-05/03
1.8i 20v. Turbo Berline 3ptes	-ch 8LW050421	AGU/QA/RZ APP	BV5	
1.8 FSi 3ptes	-ch 8LW050421	APG AGN		
1.9 TDi 66kw 3ptes	-ch 8LW050421	AGR ALH	BVM	
1.9 TDi 66kw 3ptes		AGR ALH	BVA	-05/03
1.9 TDi 81kw 3ptes	-ch 8LW050421	ASV AHF		
1.9 TDi 96kw 3ptes	-ch 8LW050421	ASZ		



... A3 ...

9006219 Axe de bielle G/D

Part/oe 1J0422803H L/R axial joint

14 Côté dir. M16x1.5 Côté rot. M14x1.5 long 320 mm
15



1.6		AVU	-05/03
1.6	Ch- 8LW050422	AEH AKL APF AGN	-05/03
1.8i 20v. Turbo	Ch- 8LW050422	AGU/QA/RZ/UM	-05/03
1.8i 20v. Turbo /4WD	Ch- 8LW050422	AJQ APP AUQ ARY	-05/03
1.8 FSi	Ch- 8LW050422	AGN APG	-05/03
1.9 TDi /4WD	Ch- 8LW050422		-05/03

9006638 Rotule de direction G

OE 1K0423811J Left tie rod end

9 M16 x 1.5



1.2 TSi /Sportback	10/09-07/12
1.2 TSi Cab.	01/10-
1.4 TFSi /Sportback	12/07-07/12
1.4 TFSi Cab. CAXC	03/11-
1.6i /Sportback /ETH	06/03-07/12
1.6i Cab. BSE	08/08-
1.6 FSi Sportback	
1.6 FSi 3ptes BAG BLF/P	06/03-06/08
1.6 TDi FAP /Sportback	10/09-07/12
1.6 TDi FAP Cab.	10/09-
1.8 TFSi /Sportback/4WD	06/06-07/12
1.8 TFSi Cab.	02/08-
1.8 TFSi CJSA	06/12-
1.9 TDi /FAP /Sportback	
BLS BXE	04/05-07/12
1.9 TDi 3ptes BKC BXE	06/03-
1.9 TDi FAP Cab. BLS	02/08-
1.9 TDi Sportback	
2.0 FSi /Sportback 3ptes	06/03-
AXW BLR/LX/VY	
2.0 TFSi Cab. CAWB CCZA	02/08-
2.0 TFSi /Sportback /4WD /S3	
2.0 TDi /Sportback /4WD	
AZV BKD/UY	06/03-07/12
2.0 TDi FAP Sportback/4WD	
CBAA/AB/BB	06/08-07/12
2.0 TDi FAP CRBC	06/12-
2.0 TDi FAP Sportback/4WD	
BMM/N	11/04-07/12
2.0 TDi /Sportback /4WD	
CFFA/B/GB	10/09-07/12
2.0 TDi FAP Cab. CBAA/B	02/08-
2.0 TDi Cab. CFFA/B	10/09-
3.2 4WD /Sportback	

9006637

OE 1K0423812J

Rotule de direction D

Right tie rod end

8 M16 x 1.5



1.2 TSi /Sportback	10/09-07/12
1.2 TSi Cab.	01/10-
1.4 TFSi /Sportback	12/07-07/12
1.4 TFSi Cab. CAXC	03/11-
1.6i /Sportback /ETH	06/03-07/12
1.6i Cab. BSE	08/08-
1.6 FSi Sportback	
1.6 FSi 3ptes BAG BLF/P	06/03-06/08
1.6 TDi FAP /Sportback	10/09-07/12
1.6 TDi FAP Cab.	10/09-
1.8 TFSi /Sportback/4WD	06/06-07/12
1.8 TFSi Cab.	02/08-
1.8 TFSi CJSA	06/12-
1.9 TDi /FAP /Sportback	
BLS BXE	04/05-07/12
1.9 TDi 3ptes BKC BXE	06/03-
1.9 TDi FAP Cab. BLS	02/08-
1.9 TDi Sportback	
2.0 FSi /Sportback 3ptes	06/03-
AXW BLR/LX/VY	
2.0 TFSi Cab. CAWB CCZA	02/08-
2.0 TFSi /Sportback /4WD /S3	
2.0 TDi /Sportback /4WD	
AZV BKD/UY	06/03-07/12
2.0 TDi FAP Sportback/4WD	
CBAA/AB/BB	06/08-07/12
2.0 TDi FAP CRBC	06/12-
2.0 TDi FAP Sportback/4WD	
BMM/N	11/04-07/12
2.0 TDi /Sportback /4WD	
CFFA/B/GB	10/09-07/12
2.0 TDi FAP Cab. CBAA/B	02/08-
2.0 TDi Cab. CFFA/B	10/09-
3.2 4WD /Sportback	

... A3 ...

Eléments DIRECTION
Steering parts
Elementos Direcciones
Elementy układ kierowniczy
Элементы рулевой системы

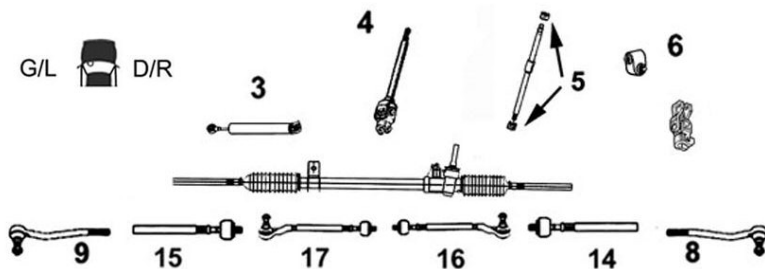

AUDI

9006385

Rotule de direction G

OE 1J0422811A

Left tie rod end



9 M14 x 1.5

1.6 3ptes -ch 8LW050421 -05/03
 AEH AKL
 APF AGN

1.8i 20v. Turbo Berline 3ptes -05/03
 -ch 8LW050421
 AGU/QA/RZ

APP BV5

1.8 FSi 3ptes -ch 8LW050421 -05/03
 AGN APG

1.9 TDi 3ptes -ch 8LW050421 -05/03
 AGR/LH BVM

AGR BVA

AHF ASV ASZ

9006384

Rotule de direction D

OE 1J0422812A

Right tie rod end



8 M14 x 1.5

1.6 3ptes -ch 8LW050421 -05/03
 AEH AKL
 APF AGN

1.8i 20v. Turbo Berline 3ptes -05/03
 -ch 8LW050421
 AGU/QA/RZ

APP BV5

1.8 FSi 3ptes -ch 8LW050421 -05/03
 AGN APG

1.9 TDi 3ptes -ch 8LW050421 -05/03
 AGR/LH BVM

AGR BVA

AHF ASV ASZ

9006634

Rotule de direction G

OE 1J0422812B

Left tie rod end



8 M14 x 1.5 Dir. TRW

1.6 Ch- 8LW050422 -05/03
 AEH/KL/PF/GN

1.6 AVU -05/03

1.8i 20v. Turbo Ch- 8LW050422
 APP BV5 -05/03

1.8i 20v. Turbo /4WD -05/03
 Ch- 8LW050422

1.8 FSi Ch- 8LW050422 -05/03

1.9 TDi /4WD Ch- 8LW050422
 -05/03

9006635

Rotule de direction D

OE 1J0422811B

Right tie rod end



9 M14 x 1.5

1.6 Ch- 8LW050422 -05/03
 AEH/KL/PF/GN

1.6 AVU -05/03

1.8i 20v. Turbo Ch- 8LW050422
 APP BV5 -05/03

1.8i 20v. Turbo /4WD -05/03
 Ch- 8LW050422

1.8 FSi Ch- 8LW050422 -05/03

1.9 TDi /4WD Ch- 8LW050422
 -05/03



Barre stabilisatrice
 Stabilizer bar
 Barra estabilizadora
 Drażek stabilizatora
 стабилизатор поперечной устойчивости

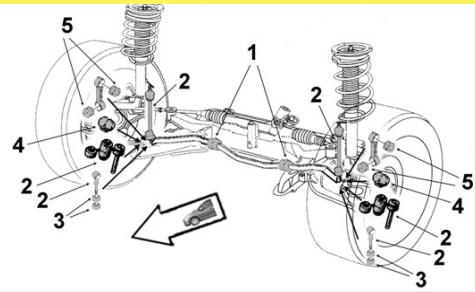

	<p>2306010 Biellette barre stab. OE 1K0411315P <i>Stabilizer bar stub axle</i></p> <p>2</p> <table border="0"> <tr><td>1.2 TSi /Sportback</td><td>CBZB</td><td>BVM BV rob.</td><td>10/09-</td></tr> <tr><td>1.4 TFSi /Sportback</td><td></td><td></td><td>12/07-</td></tr> <tr><td>1.6i /Sportback /Cab.</td><td></td><td></td><td>01/04-</td></tr> <tr><td>1.6 FSi /Sportback</td><td></td><td>BVM</td><td>09/03-12/07</td></tr> <tr><td>1.6 TDi FAP /Sportback /Cab.</td><td>CAYB/C</td><td>BVM BV rob.</td><td>04/09-</td></tr> <tr><td>1.8 TFSi /Sportback /4WD /Cab.</td><td>BZB CDAA</td><td></td><td>02/08-</td></tr> <tr><td>1.8 TFSi 3ptes</td><td>BYT</td><td></td><td>06/06-06/08</td></tr> <tr><td>1.8 TFSi Cab.</td><td>CDAA</td><td>BVM BV rob.</td><td>11/08-</td></tr> <tr><td>1.8 TFSi Sportback</td><td>BYT</td><td></td><td>06/06-12/07</td></tr> <tr><td>1.9 TDi /Sportback</td><td></td><td>BVM</td><td>06/03-06/08</td></tr> <tr><td>1.9 TDi /Sportback</td><td>BXE</td><td>BVM</td><td>06/08-</td></tr> <tr><td>1.9 TDi FAP /Sportback /Cab.</td><td>BLS</td><td></td><td>06/08-</td></tr> <tr><td>2.0 FSi /Sportback</td><td></td><td></td><td>06/03-06/06</td></tr> <tr><td>2.0 TFSi /4WD /Sportback /Cab.</td><td>AXX CAWB BWA</td><td>BV rob.</td><td>09/04-</td></tr> <tr><td>2.0 TFSi /Sportback /4WD</td><td>AXX BWA</td><td></td><td>09/04-</td></tr> <tr><td>2.0 TFSi /Sportback /4WD S3</td><td></td><td></td><td>09/04-</td></tr> <tr><td>2.0 TFSi Cab.</td><td>CAWB CCZA</td><td></td><td>04/08-</td></tr> <tr><td>2.0 TDi /Sportback /4WD /Cab.</td><td>CFFB/GB</td><td>BVM BV rob.</td><td>10/09-</td></tr> <tr><td>2.0 TDi /DPF /4WD</td><td>CBBB</td><td></td><td>06/08-</td></tr> <tr><td>2.0 TDi /DPF /Sportback /4WD /Cab.</td><td>CBAB</td><td></td><td>08/08-</td></tr> <tr><td>2.0 TDi /Sportback</td><td></td><td>BVM</td><td>06/03-06/08</td></tr> <tr><td>3.2i V6 24v. /Sportback /4WD</td><td></td><td></td><td>01/04-</td></tr> </table>	1.2 TSi /Sportback	CBZB	BVM BV rob.	10/09-	1.4 TFSi /Sportback			12/07-	1.6i /Sportback /Cab.			01/04-	1.6 FSi /Sportback		BVM	09/03-12/07	1.6 TDi FAP /Sportback /Cab.	CAYB/C	BVM BV rob.	04/09-	1.8 TFSi /Sportback /4WD /Cab.	BZB CDAA		02/08-	1.8 TFSi 3ptes	BYT		06/06-06/08	1.8 TFSi Cab.	CDAA	BVM BV rob.	11/08-	1.8 TFSi Sportback	BYT		06/06-12/07	1.9 TDi /Sportback		BVM	06/03-06/08	1.9 TDi /Sportback	BXE	BVM	06/08-	1.9 TDi FAP /Sportback /Cab.	BLS		06/08-	2.0 FSi /Sportback			06/03-06/06	2.0 TFSi /4WD /Sportback /Cab.	AXX CAWB BWA	BV rob.	09/04-	2.0 TFSi /Sportback /4WD	AXX BWA		09/04-	2.0 TFSi /Sportback /4WD S3			09/04-	2.0 TFSi Cab.	CAWB CCZA		04/08-	2.0 TDi /Sportback /4WD /Cab.	CFFB/GB	BVM BV rob.	10/09-	2.0 TDi /DPF /4WD	CBBB		06/08-	2.0 TDi /DPF /Sportback /4WD /Cab.	CBAB		08/08-	2.0 TDi /Sportback		BVM	06/03-06/08	3.2i V6 24v. /Sportback /4WD			01/04-
1.2 TSi /Sportback	CBZB	BVM BV rob.	10/09-																																																																																						
1.4 TFSi /Sportback			12/07-																																																																																						
1.6i /Sportback /Cab.			01/04-																																																																																						
1.6 FSi /Sportback		BVM	09/03-12/07																																																																																						
1.6 TDi FAP /Sportback /Cab.	CAYB/C	BVM BV rob.	04/09-																																																																																						
1.8 TFSi /Sportback /4WD /Cab.	BZB CDAA		02/08-																																																																																						
1.8 TFSi 3ptes	BYT		06/06-06/08																																																																																						
1.8 TFSi Cab.	CDAA	BVM BV rob.	11/08-																																																																																						
1.8 TFSi Sportback	BYT		06/06-12/07																																																																																						
1.9 TDi /Sportback		BVM	06/03-06/08																																																																																						
1.9 TDi /Sportback	BXE	BVM	06/08-																																																																																						
1.9 TDi FAP /Sportback /Cab.	BLS		06/08-																																																																																						
2.0 FSi /Sportback			06/03-06/06																																																																																						
2.0 TFSi /4WD /Sportback /Cab.	AXX CAWB BWA	BV rob.	09/04-																																																																																						
2.0 TFSi /Sportback /4WD	AXX BWA		09/04-																																																																																						
2.0 TFSi /Sportback /4WD S3			09/04-																																																																																						
2.0 TFSi Cab.	CAWB CCZA		04/08-																																																																																						
2.0 TDi /Sportback /4WD /Cab.	CFFB/GB	BVM BV rob.	10/09-																																																																																						
2.0 TDi /DPF /4WD	CBBB		06/08-																																																																																						
2.0 TDi /DPF /Sportback /4WD /Cab.	CBAB		08/08-																																																																																						
2.0 TDi /Sportback		BVM	06/03-06/08																																																																																						
3.2i V6 24v. /Sportback /4WD			01/04-																																																																																						
	<p>9005084 Biellette barre stab. OE 1J0411315J <i>Stabilizer bar stub axle</i></p> <p>2 Barre Ø 21</p> <table border="0"> <tr><td>1.6</td><td>AEH/KL/PF/VU</td><td>09/96-</td></tr> <tr><td>1.8i 20v. Turbo</td><td>AGU/JQ/QA/RZ</td><td></td></tr> <tr><td></td><td>APP/UM/UQ</td><td>09/96-</td></tr> <tr><td>1.8i 20v. Turbo 4WD</td><td>-ch 8LX140000</td><td></td></tr> <tr><td></td><td>AJQ BV5</td><td>12/98-</td></tr> <tr><td>1.8i 20v. FSi</td><td>AGN APG</td><td>09/96-</td></tr> <tr><td>1.9 TDi</td><td>AGR/LH/TD/XR</td><td>09/96-</td></tr> <tr><td></td><td>ASV/HF/SZ</td><td></td></tr> </table>	1.6	AEH/KL/PF/VU	09/96-	1.8i 20v. Turbo	AGU/JQ/QA/RZ			APP/UM/UQ	09/96-	1.8i 20v. Turbo 4WD	-ch 8LX140000			AJQ BV5	12/98-	1.8i 20v. FSi	AGN APG	09/96-	1.9 TDi	AGR/LH/TD/XR	09/96-		ASV/HF/SZ		<p>9005093 Biellette barre stab. OE 1J0411315K <i>Stabilizer bar stub axle</i></p> <p>2 Barre Ø 23</p> <table border="0"> <tr><td>1.6i</td><td>AEH/KL/PF/VU</td><td>02/99-10/00</td></tr> <tr><td>1.8i 20v. Turbo</td><td>AGU/JQ/PP/QA</td><td></td></tr> <tr><td></td><td>ARZ/UM/UQ</td><td>09/96-10/00</td></tr> <tr><td>1.8i 20v. Turbo 4WD</td><td>Ch- 8L-X-140000</td><td></td></tr> <tr><td></td><td>AJQ</td><td>12/98-10/00</td></tr> <tr><td>1.8i 20v. FSi</td><td>Ch- 8L-X-140000</td><td></td></tr> <tr><td></td><td>AGN/PG</td><td>09/96-10/00</td></tr> <tr><td>1.9 TDi</td><td>Ch- 8L-X-140000</td><td>AGR/HF/LH</td></tr> <tr><td></td><td>ASV/SZ/TD/XR</td><td>09/96-09/01</td></tr> </table>	1.6i	AEH/KL/PF/VU	02/99-10/00	1.8i 20v. Turbo	AGU/JQ/PP/QA			ARZ/UM/UQ	09/96-10/00	1.8i 20v. Turbo 4WD	Ch- 8L-X-140000			AJQ	12/98-10/00	1.8i 20v. FSi	Ch- 8L-X-140000			AGN/PG	09/96-10/00	1.9 TDi	Ch- 8L-X-140000	AGR/HF/LH		ASV/SZ/TD/XR	09/96-09/01																																				
1.6	AEH/KL/PF/VU	09/96-																																																																																							
1.8i 20v. Turbo	AGU/JQ/QA/RZ																																																																																								
	APP/UM/UQ	09/96-																																																																																							
1.8i 20v. Turbo 4WD	-ch 8LX140000																																																																																								
	AJQ BV5	12/98-																																																																																							
1.8i 20v. FSi	AGN APG	09/96-																																																																																							
1.9 TDi	AGR/LH/TD/XR	09/96-																																																																																							
	ASV/HF/SZ																																																																																								
1.6i	AEH/KL/PF/VU	02/99-10/00																																																																																							
1.8i 20v. Turbo	AGU/JQ/PP/QA																																																																																								
	ARZ/UM/UQ	09/96-10/00																																																																																							
1.8i 20v. Turbo 4WD	Ch- 8L-X-140000																																																																																								
	AJQ	12/98-10/00																																																																																							
1.8i 20v. FSi	Ch- 8L-X-140000																																																																																								
	AGN/PG	09/96-10/00																																																																																							
1.9 TDi	Ch- 8L-X-140000	AGR/HF/LH																																																																																							
	ASV/SZ/TD/XR	09/96-09/01																																																																																							
	<p>2306007 Biellette barre stab. G OE 1J0411315D <i>Left stabilizer bar stub axle</i></p> <p>2</p> <table border="0"> <tr><td>1.8i 20v. Turbo 4WD 180hp</td><td></td><td></td></tr> <tr><td>Ch- 8LX140001</td><td>BVM</td><td>12/98-06/03</td></tr> <tr><td>1.9 TDi /4WD 130hp 96kw</td><td>BVM</td><td>10/00-06/03</td></tr> </table>	1.8i 20v. Turbo 4WD 180hp			Ch- 8LX140001	BVM	12/98-06/03	1.9 TDi /4WD 130hp 96kw	BVM	10/00-06/03	<p>2306008 Biellette barre stab. D OE 1J0411316D <i>Right stabilizer bar stub axle</i></p> <p>2</p> <table border="0"> <tr><td>1.8i 20v. Turbo 4WD 180hp 132kw</td><td></td><td></td></tr> <tr><td>Ch- 8LX140001</td><td>BVM</td><td>12/98-06/03</td></tr> <tr><td>1.9 TDi /4WD 130hp 96kw</td><td>BVM</td><td>10/00-06/03</td></tr> </table>	1.8i 20v. Turbo 4WD 180hp 132kw			Ch- 8LX140001	BVM	12/98-06/03	1.9 TDi /4WD 130hp 96kw	BVM	10/00-06/03																																																																					
1.8i 20v. Turbo 4WD 180hp																																																																																									
Ch- 8LX140001	BVM	12/98-06/03																																																																																							
1.9 TDi /4WD 130hp 96kw	BVM	10/00-06/03																																																																																							
1.8i 20v. Turbo 4WD 180hp 132kw																																																																																									
Ch- 8LX140001	BVM	12/98-06/03																																																																																							
1.9 TDi /4WD 130hp 96kw	BVM	10/00-06/03																																																																																							
	<p>9005018 Liaison élastique OE 1J0411327 <i>Elastic link</i></p> <p>5 Ø int.14.5 ext.Ø 29 coll.35 x2 long. tube int.22.5 ext.18 ep. coll.2 x2</p> <table border="0"> <tr><td>1.6</td><td></td><td>10/00-06/03</td></tr> <tr><td>1.8i 20v. Turbo</td><td></td><td></td></tr> <tr><td></td><td>AGU/UM/RY/UQ</td><td>10/00-06/03</td></tr> <tr><td>1.8i 20v. FSi</td><td>AGN/PG</td><td>10/00-06/03</td></tr> <tr><td>1.9 TDi</td><td>ALH/TD/XR</td><td>10/00-06/03</td></tr> <tr><td>1.9 TDi</td><td>AHF/SV/SZ</td><td>10/00-06/03</td></tr> </table>	1.6		10/00-06/03	1.8i 20v. Turbo				AGU/UM/RY/UQ	10/00-06/03	1.8i 20v. FSi	AGN/PG	10/00-06/03	1.9 TDi	ALH/TD/XR	10/00-06/03	1.9 TDi	AHF/SV/SZ	10/00-06/03	<p>9001730 Palier de barre milieu OE 1J0411314R <i>Middle bar main bearing</i></p> <p>1 Barre Ø 21</p> <table border="0"> <tr><td>1.6i</td><td>AEH/KL/PF</td><td>02/99-06/03</td></tr> <tr><td>1.6i</td><td>AVU</td><td>10/00-06/03</td></tr> <tr><td>1.8i 20v. Turbo</td><td></td><td>03/97-06/03</td></tr> <tr><td>1.8 FSi</td><td></td><td>09/96-06/03</td></tr> <tr><td>1.9 TDi</td><td>AGR/LH/TD/XR</td><td>03/97-06/03</td></tr> <tr><td>1.9 TDi</td><td>ASV AHF</td><td>04/97-06/03</td></tr> <tr><td>1.9 TDi</td><td>ASZ</td><td>10/00-06/03</td></tr> </table>	1.6i	AEH/KL/PF	02/99-06/03	1.6i	AVU	10/00-06/03	1.8i 20v. Turbo		03/97-06/03	1.8 FSi		09/96-06/03	1.9 TDi	AGR/LH/TD/XR	03/97-06/03	1.9 TDi	ASV AHF	04/97-06/03	1.9 TDi	ASZ	10/00-06/03																																																
1.6		10/00-06/03																																																																																							
1.8i 20v. Turbo																																																																																									
	AGU/UM/RY/UQ	10/00-06/03																																																																																							
1.8i 20v. FSi	AGN/PG	10/00-06/03																																																																																							
1.9 TDi	ALH/TD/XR	10/00-06/03																																																																																							
1.9 TDi	AHF/SV/SZ	10/00-06/03																																																																																							
1.6i	AEH/KL/PF	02/99-06/03																																																																																							
1.6i	AVU	10/00-06/03																																																																																							
1.8i 20v. Turbo		03/97-06/03																																																																																							
1.8 FSi		09/96-06/03																																																																																							
1.9 TDi	AGR/LH/TD/XR	03/97-06/03																																																																																							
1.9 TDi	ASV AHF	04/97-06/03																																																																																							
1.9 TDi	ASZ	10/00-06/03																																																																																							

... A3 ...

SASIC



Barre stabilisatrice
 Stabilizer bar
 Barra estabilizadora
 Drążek stabilizatora
 стабилизатор поперечной устойчивости

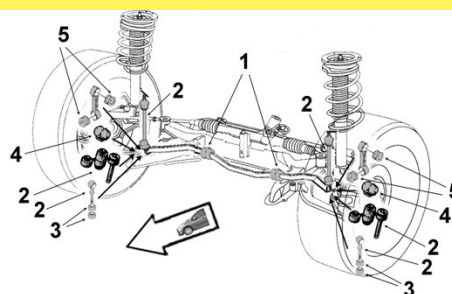

2306134

Palier de barre

OE 1J0411314S

Bar main bearing

NEW

1 Ø17



1.8i Turbo	-ch 8L-W001701	AJQ APP	09/96-06/03
1.8 Turbo 4WD		AQA ARX	10/98-06/03
1.8i Turbo S3 4WD			03/99-05/03
1.9 TDi	-ch 8L-W001701		09/96-06/03
1.9 TDi 4WD			08/00-05/03



Eléments SUSPENSION

Suspension parts
 Elementos suspensión
 Elementy zawieszenie
 Элементы подвески

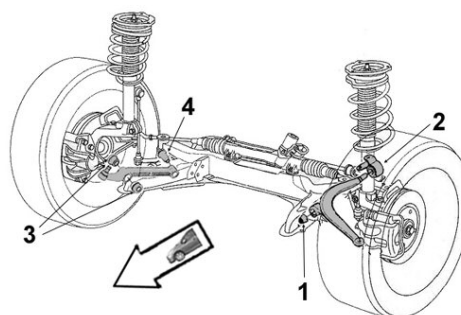

2256003

Articulation AR G

OE 1K0199231J

Left rear bush

2



1.6i	BGU/SE	06/03-06/08
1.6 FSi 16v.	BAG/LF/LP	09/03-12/07
1.8 TFSi /Sportback /4WD	CDA	06/08-
1.9 TDi	BKC/XE	06/03-06/08
1.9 TDi 105hp 77kw /FAP /Sportback /Cab.	BLS/XE	06/08-
2.0 FSi	A/XW B/LR/LX/VY	06/03-06/08
2.0 TFSi	AXX BWA	09/04-06/08
2.0 TDi	BKD	06/03-06/08
2.0 TDi /DPF /Sportback /4WD /Cab.	CBAB/B	02/08-
2.0 TDi /DPF /Sportback /4WD /Cab.	BKD	06/03-06/08
3.2i V6 24v. 4WD	BDB/MJ/UB	01/04-06/08

2256002

Articulation AR D

OE 1K0199232J

Right rear bush

2



1.6i	BGU/SE	06/03-06/08
1.6 FSi 16v.	BAG/LF/LP	09/03-12/07
1.8 TFSi /Sportback /4WD	CDA	06/08-
1.9 TDi	BKC/XE	06/03-06/08
1.9 TDi 105hp 77kw /FAP /Sportback /Cab.	BLS/XE	06/08-
2.0 FSi	A/XW B/LR/LX/VY	06/03-06/08
2.0 TFSi	AXX BWA	09/04-06/08
2.0 TDi	BKD	06/03-06/08
2.0 TDi /DPF /Sportback /4WD /Cab.	CBAB/B	02/08-
2.0 TDi /DPF /Sportback /4WD /Cab.	BKD	06/03-06/08
3.2i V6 24v. 4WD	BDB/MJ/UB	01/04-06/08

9001542

Articulation AR

OE 1J0407181

Rear bush

Øint.13 Ø ext.59.5 long.tube int.41 ext.23.5



1.6i	09/96-
1.8i 20v. Turbo /4WD	09/96-
1.8 FSi	09/96-
1.9 TDi	09/96--06/03

... A3 ...

9001759
Articulation AV

OE 1K0407182

Front bush
1 Ø int.12 Ø ext.40 coll.48 long. tube int.54 ext.33 ep. coll.6

1.2 TSi /Sportback /Cab.	CBZB	10/09-07/12
1.4 TFSi /Sportback /Cab.	CAXC	12/07-07/12
1.6i /ETH /Sportback	CCSA CMXA	06/08-07/12
1.6i	BGU BSE	06/03-06/08
1.6i /Sportback /Cab.	BSE	06/08-
1.6i FSi	BAG BLF/P	06/03-
1.6 TDi FAP /Sportback /Cab.	CAYB/C	04/09-07/12
1.8 TFSi /Sportback	BYT BZB	06/06-07/12
1.8 TFSi /Sportback /4WD /Cab.	CDAA	06/08-
1.8 TFSi Cab.	BZB	02/08-
1.9 TDi 105hp 77kw	BKC BXE	06/03-06/08
1.9 TDi 105hp 77kw /FAP /Sportback /Cab.	BLS BXE	04/06-
2.0 FSi	A/XW/XX B/LR/LX/VY/WA	06/03-06/08
2.0 TFSi /Sportback	BWA CAWB	04/07-07/12
2.0 TFSi /Sportback /4WD S3	BHZ BZC	11/06-07/12
2.0 TFSi Sportback /4WD	AXX BWA	09/04-06/08
2.0 TFSi Cab.	CAWB CCZA	02/08-
2.0 TFSi /Sportback /4WD S3	CCZA CDLA/C	06/08-
2.0 TDi /FAP /Sportback /4WD	AZV BMM/N BUY	01/04-07/12
2.0 TDi	BKD	06/03-
2.0 TDi /DPF /Sportback /4WD /Cab.	CBAA/B CBBB CFFA/B CFGB	06/08-
3.2i V6 24v. 4WD	BDB/MJ/UB	01/04-06/08
3.2i V6 24v. /Sportback /4WD	BUB	06/08-

9001523
Articulation AV

OE 357407182

Front bush
1 Ø int.12 Ø ext.33 coll.36 long. tube int.54 ext.29 ep. coll.5

1.6i		09/96-
1.8i 20v. Turbo /4WD		09/96-
1.8 FSi		09/96-
1.9 TDi		09/96-

AUDI

... A3 ...



AUDI

Bras & Triangle de suspension

Control arm
Brazo y triángulo
Wahacz
Рычаг подвески

G/L D/R

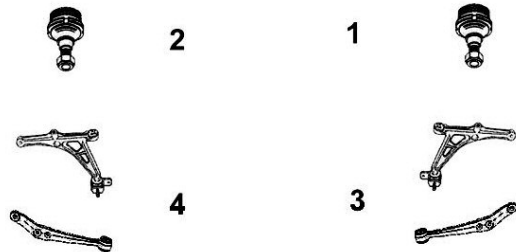



7476018		Triangle de susp. G	7476017		Triangle de susp. D
OE 1K0407151AC		Left track control arm	OE 1K0407152AD		Right track control arm
	4	Fonte Iron Sans rotule Without tie rod end		3	Fonte Iron Sans rotule Without tie rod end
		1.4 TFSi /Sportback 12/07-05/09			1.4 TFSi /Sportback 12/07-05/09
		1.6i /Sportback /Cab. 06/03-05/09			1.6i /Sportback /Cab. 06/03-05/09
		1.6 FSi /Sportback 09/03-12/07			1.6 FSi /Sportback 09/03-12/07
		1.8 TFSi /Sportback BYT 06/06-06/08			1.8 TFSi /Sportback BYT 06/06-06/08
		1.8 TFSi /Sportback /4WD /Cab. CDAA 06/08-05/09			1.8 TFSi /Sportback /4WD /Cab. CDAA 06/08-05/09
		1.9 TDi /Sportback /Cab. 04/06-05/09			1.9 TDi /Sportback /Cab. 04/06-05/09
		2.0 FSi /Sportback 06/03-06/06			2.0 FSi /Sportback 06/03-06/06
		2.0 TFSi /4WD /Sportback S3 /Cab. 09/04-07/12			2.0 TFSi /4WD /Sportback S3 /Cab. 09/04-07/12
		2.0 TDi /DPF /Sportback /4WD /Cab. 01/04-05/09			2.0 TDi /DPF /Sportback /4WD /Cab. 01/04-05/09
	3.2i V6 24v. 4WD /Sportback 4WD 01/04-05/09		3.2i V6 24v. 4WD /Sportback 4WD 01/04-05/09		
9005757		Triangle de susp. G	9005756		Triangle de susp. D
OE 1K0407151AB		Left track control arm	OE 1K0407152AB		Right track control arm
	4	Acier Steel Sans rotule Without tie rod end		3	Acier Steel Sans rotule Without tie rod end
		1.4 TFSi /Sportback 06/08-07/12			1.4 TFSi /Sportback 06/08-07/12
		1.8 TFSi /Sportback 04/05/09-07/12			1.8 TFSi /Sportback 04/05/09-07/12
	OE 1K0407151AH			OE 1K0407152AH	
		1.6 FSi Sportback			1.6 FSi Sportback
		1.9 TDi/ Sportback			1.9 TDi/ Sportback
		2.0 TFSi Sportback 5ptes			2.0 TFSi Sportback 5ptes
		2.0 TDi/ Sportback			2.0 TDi/ Sportback
9005136		Triangle de susp. G/D			
OE 1J0407151C		L/R track control arm			
	3	Sans rotule Without tie rod end			
	4				
			1.6	-05/03	
			1.8i 20v. Turbo	-05/03	
			1.8 FSi	-05/03	
	1.9 TDi	-05/03			

... A3 ...

AUDI



7476128 Triangle de susp. G		7476127 Triangle de susp. D	
OE 1K0407151AC+1K0407365C L track control arm		OE 1K0407152AD+1K040766C R track control arm	
	NEW	4 Avec rotule With ball joint	NEW
		1.4 TFSi /Sportback 12/07-05/09	1.4 TFSi /Sportback 12/07-05/09
		1.6i /Sportback /Cab. 06/03-	1.6i /Sportback /Cab. 06/03-
		1.6 FSi /Sportback 09/03-12/07	1.6 FSi /Sportback 09/03-12/07
		1.8 TFSi /Sportback /Cab. BYT 06/06-06/08	1.8 TFSi /Sportback /Cab. BYT 06/06-06/08
		1.8 TFSi /Sportback /4WD /Cab. CDAA 06/08-05/09	1.8 TFSi /Sportback /4WD /Cab. CDAA 06/08-05/09
		1.9 TDi /Sportback /Cab. 04/06-	1.9 TDi /Sportback /Cab. 04/06-
		2.0 FSi / Sportback / 3ptes Tiptronic 06/03-	2.0 FSi / Sportback / 3ptes Tiptronic 06/03-
		2.0 TFSi /4WD /Sportback 09/04-07/12	2.0 TFSi /4WD /Sportback 09/04-07/12
		2.0 TDi /DPF /Sportback 01/04-05/09 /4WD /Cab.	2.0 TDi /DPF /Sportback 01/04-05/09 /4WD /Cab.
	3.2i V6 24v. 4WD/Sportback 4WD 01/04-05/09	3.2i V6 24v. 4WD/Sportback 4WD 01/04-05/09	
7476118 Triangle de susp. G		7476119 Triangle de susp. D	
OE 1J0407151C+1J0407365H Left track control arm		OE 1J0407151C+1J0407366H Right track control arm	
	NEW	4 Avec rotule With ball joint	NEW
		1.6 -05/03	1.6 -05/03
		1.8i 20v. Turbo /4WD -05/03	1.8i 20v. Turbo /4WD -05/03
		1.8 FSi -05/03	1.8 FSi -05/03
		1.9 TDi -05/03	1.9 TDi -05/03
7476095 Triangle de susp. G		7476097 Triangle de susp. D	
OE 1K0407365C + 1K0407151P L track control arm		OE 1K0407366C + 1K0407152P R track control arm	
	NEW	4 Avec rotule With ball joint	NEW
		1.6 FSi Sportback 5ptes BVM/ Tiptronic 09/03-12/07	1.6 FSi Sportback 5ptes BVM/ Tiptronic 09/03-12/07
		1.9 TDi Sportback 5ptes	1.9 TDi Sportback 5ptes
		2.0 TFSi Sportback 5ptes BVM/ Tiptronic	2.0 TFSi Sportback 5ptes BVM/ Tiptronic
		2.0 TDi Sportback 5ptes BVM/BVA DSG	2.0 TDi Sportback 5ptes BVM/BVA DSG

... A3 ...

SASIC





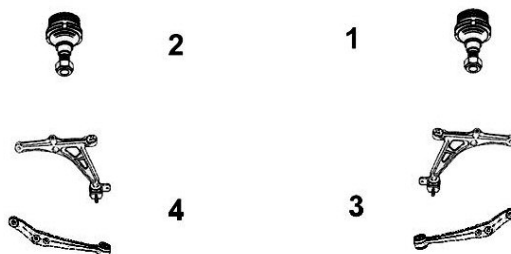

AUDI

Bras & Triangle de suspension

Control arm
Brazo y triángulo
Wahacz
Рычаг подвески

G/L  D/R



9005570		Rotule de susp. inf. G		9005569		Rotule de susp. inf. D	
OE 1K0407365C		Left lower suspension ball joint		OE 1K0407366C		Right lower suspension ball joint	
	2	1.2 TSi /Sportback /Cab.	-07/12		1	1.2 TSi /Sportback /Cab.	-07/12
		1.4 TFSi /Sportback	-07/12			1.4 TFSi /Sportback	-07/12
		1.6i /Sportback /Cab.	06/03-07/12			1.6i /Sportback /Cab.	06/03-07/12
		1.6 FSi /Sportback	09/03-07/12			1.6 FSi /Sportback	09/03-07/12
		1.6 TDi /Sportback /Cab.	-07/12			1.6 TDi /Sportback /Cab.	-07/12
		1.8 TFSi /Sportback /4WD /Cab.	06/06-07/12			1.8 TFSi /Sportback /4WD /Cab.	06/06-07/12
		1.9 TDi 105hp 77kw /FAP /Sportback/Cab.	06/03-07/12			1.9 TDi 105hp 77kw /FAP /Sportback/Cab.	06/03-07/12
		1.9 TDi Sportback 5ptes	-07/12			1.9 TDi Sportback 5ptes	-07/12
		2.0 FSi 150hp 110kw /Sportback	06/03-07/12			2.0 FSi 150hp 110kw /Sportback	06/03-07/12
		2.0 TFSi Sportback /Cab. BVM	-07/12			2.0 TFSi Sportback /Cab. BVM	-07/12
		2.0 TFSi Sportback 4WD 5ptes Tiptronic	-07/12			2.0 TFSi Sportback 4WD 5ptes Tiptronic	-07/12
		2.0 TFSi /4WD /Cab.	-07/12			2.0 TFSi /4WD /Cab.	-07/12
		2.0 TDi /DPF /Sportback /4WD /Cab.	01/04-07/12			2.0 TDi /DPF /Sportback /4WD /Cab.	01/04-07/12
		3.2i V6 24v. 4WD /Sportback 4WD	01/04-07/12			3.2i V6 24v. 4WD /Sportback 4WD	01/04-07/12
	9005266		Rotule de susp. inf. G		9005267		Rotule de susp. inf. D
OE 1J0407365J		Left lower suspension ball joint		OE 1J0407366J		Right lower suspension ball joint	
	2	Axe Ø 18			1	Axe Ø 18	
		1.6	-05/03			1.6	-05/03
		1.8i 20v. Turbo /4WD	-05/03			1.8i 20v. Turbo /4WD	-05/03
		1.8 FSi	-05/03			1.8 FSi	-05/03
		1.9 TDi	-05/03			1.9 TDi	-05/03
7576007		Rotule de susp. inf. G		7576005		Rotule de susp. inf. D	
OE 3C0407365A		Left lower suspension ball joint		OE 3C0407366A		Right lower suspension ball joint	
	2				1		
	2.0 TFSi 4WD /Sportbak	11/06-		2.0 TFSi 4WD /Sportbak	11/06-		



Support d'amortisseur
 Suspension mounting
 Soporte amortiguador
 Poduszka amortyzatora
 Опора амортизатора

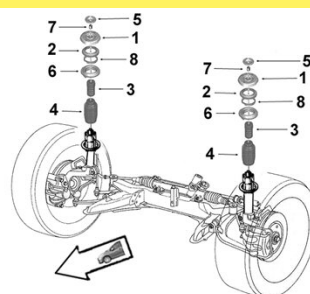

9005622 **Support suspension G/D**
 OE 1K0412331B *L/R suspension mounting*



1	1.2 TSi /Sportback	CBZB	10/09-07/12
	1.4 TFSi /Sportback	CAXC	12/07-
	1.6i /ETH /Sportback	CCSA CMXA	06/08-07/12
	1.6i /Sportback	BGU BSE	06/03-
	1.6 FSi	BAG BLF BLP	06/03-
	1.6 TDi FAP /Sportback	CAYB/C	04/09-07/12
	1.8 TFSi /Sportback	BYT BZB	06/06-07/12
	1.8 TFSi /Sportback /4WD	CDAA	06/08-
	1.9 TDi /Sportback	BKC BXE	06/03-
	1.9 TDi FAP /Sportback	BLS	04/05-
	2.0 FSi	AXW/XX BLR/LX/VY/WA	06/03-
	2.0 TFSi	AXX BWA	06/03-
	2.0 TFSi /Sportback	CAWB	04/07-07/12
	2.0 TFSi /Sportback /4WD S3	CCZA CDLA/C	06/08-
	2.0 TFSi /Sportback 4WD S3	BHZÀ BZC	12/06-07/12
	2.0TFSi /Sportback	CCZA	06/08-
	2.0 TDi	BKD	06/03-
	2.0 TDi /DPF /Sportback /4WD	CBAA/B CBBB CFFA/B CFFB	06/08-
	2.0 TDi /FAP /Sportback /4WD	AZV BMM/N BUY	01/04-07/12
	3.2i V6 24v. 4WD	BDB BMJ BUD	09/04-
	3.2i V6 24v. 4WD /Sportback	BUB	06/08-

9005614 **Tampon suspension AV G/D**
 OE 1J0412331C *L/R front suspension rebound stop*



1	1.6i	01/96-12/03
	1.8i 20v. Turbo /4WD	01/96-12/03
	1.8 FSi	01/96-12/03
	1.9 TDi	01/96-12/03

9005352 **Butée à billes G/D**
 OE 1J0412249 *L/R ball bearing*



2	1.6i	01/96-12/03
	1.8i 20v. Turbo /4WD	01/96-12/03
	1.8 FSi	01/96-12/03
	1.9 TDi	01/96-12/03

9005336 **Butée de suspension**
 OE 1K0412303T *Shock bush*



1	H86		
	1.2 TSi /Sportback /Cab.	CBZB	10/09-
	1.4 TFSi /Sportback /Cab.	CAXC	06/08-
	1.6i	BGU	06/03-
	1.6i /Sportback	BVM /Tiptronic	06/08-07/12
	1.6i /Sportback /Cab.	BSE	06/03-
	1.6 FSi	BAG	06/03-
	1.6 FSi /Sportback	BLF/P	09/03-12/07
	1.6 TDi FAP /Sportback /Cab.	CAYB CAYC	04/09-
	1.8 TFSi /Sportback /Cab.	CDAA	06/08-
	1.8 TFSi Cab.	BZB	06/06-07/12
	1.9 TDi	BKC	06/03-
	1.9 TDi /Sportback	BXE	09/03-
	1.9 TDi FAP /Sportback /Cab.	BLS	06/08-
	2.0 FSi	AXW	06/03-
	2.0 FSi /Sportback	BLR/X BVY	06/03-06/06
	2.0 TFSi /Sportback	CCZA	06/08-
	2.0 TFSi /Sportback	CAWB	04/07-
	2.0 TFSi /Sportback	BWA	09/04-07/12
	2.0 TFSi Cab.	CAWB	02/08-
	2.0 TFSi Sportback	AXX	09/04-06/08
	2.0 TDi /FAP /Sportback	BMM/N BUY	06/03-
	2.0 TDi /FAP /Sportback /Cab.	CBAA/B CBBB CFFA/B	06/08-
	2.0 TDi /Sportback	AZV BKD	06/03-

... A3 ...

SASIC

AUDI



Support d'amortisseur
Suspension mounting
Soporte amortiguador
Poduszka amortyzatora
Опора амортизатора

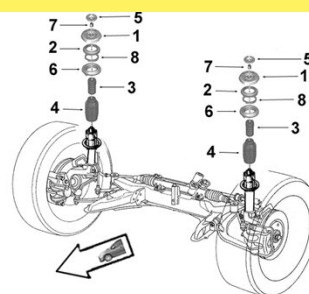

9005339

Butée de suspension

OE 1K0412303S

Shock bush



3

H90

1.2 TSi /Sportback	CBZB	01/10-
1.4 TFSi /Sportback	CAXC	01/10-
1.6i	BGU BSE	06/03-
1.6i Tiptronic	BGU	06/03-
1.6i /Sportback	BSE CCSA CMXA	01/10-
1.6 FSi	BAG BLF BLP	06/03-
1.6 TDi FAP /Sportback	CAYB/C	01/10-
1.8 TFSi /Sportback	BZB CDA A	01/10-07/12
1.9 TDi	BKC BXE	06/03-
1.9 TDi /FAP /Sportback	BLS BXE	01/10-07/12
2.0 FSi	AXW BLR/X BVY	06/03-
2.0 FSi Tiptronic	AXW	06/03-
2.0 TFSi	AXX BWA	09/04-06/08
2.0 TFSi /Sportback	BWA CAWB CCZA	01/10-07/12
2.0 TDi BVA	BKD	06/03-
2.0 TDi /FAP /Sportback	AZV BKD BMM/N BUY	01/10-07/12
2.0 TDi /FAP /Sportback	CBAA/B CBBB CFFA/B CFGB	01/10-07/12

9005338

Butée de suspension

OE 1H0412303B

Shock bush



3

H64

1.6i	09/96-
1.8i 20v. Turbo /4WD	09/96-
1.8 FSi	09/96-
1.9 TDi	09/96-

2656002

Butée de suspension

OE 1H0412303

Shock bush



3

H103

1.6i	AEH/KL/PF	02/99-10/00
1.8i 20v. Turbo	AJQ/PP/QA BVM	09/96-10/00
1.8i 20v. Turbo	ARZ/GU	03/97-10/00
1.8 FSi	APG/GN	09/96-10/00
1.9 TDi	AGR/HF/LH/SV	09/96-10/00

2656003

Butée de suspension

OE 1J0412303

Shock bush



3

H53

1.6i Sport	10/00-06/03
1.8i 20v. Turbo Sport /4WD	12/98-06/03
1.8 FSi Sport	10/00-06/03
1.9 TDi /4WD Sport	10/00-06/03

9005334

Butée de suspension

OE 1K0412303F

Shock bush



3

H55

1.6i	BGU BVM /Tiptronic	06/03-
1.6 FSi	BAG	06/03-
1.9 TDi	BKC	06/03-
2.0 FSi	AXW BVM/ Tiptronic	06/03-
2.0 TDi	BKD BVA	06/03-

... A3 ...

9005337 Butée de suspension

OE 1K0412303P *Shock bush*



3 H85

1.6i BVM /Tiptronic	BGU	06/03-
1.6 FSi	BAG	06/03-
1.8 TFSi /Sportback /4WD	CDAA	06/08-
1.9 TDi	BKC	06/03-
2.0 FSi BVM /Tiptronic	AXW	06/03-
2.0 TFSi 4WD	AXX BWA	09/04-06/08
2.0 TFSi 4WD /Sportback	CCZA	06/08-
2.0 TFSi 4WD S3 /Sportback	BHZ BWA BZC	11/06-07/12
2.0 TFSi 4WD S3 /Sportback	CDLC	06/08-07/12
2.0 TDi	BKD	06/03-
2.0 TDi DPF 4WD /Sportback	CBAB/BB/FB/GB	06/08-
2.0 TDi FAP 4WD /Sportback BVM	BMM/N	07/05-07/12
3.2i V6 24v. 4WD	BDB BMJ BUB	01/04-06/08
3.2i V6 24v. 4WD /Sportback	BUB	06/08-

2656053 Protecteur amortisseur G/D

OE 6N0413175A *L/R shock absorber protector*



H206

1.2 TSi /Sportback /Cab.		10/09-
1.4 TFSi /Sportback /Cab.		12/07-
1.6i /ETH /Sportback		06/03-
1.6 FSi /Sportback		09/03-12/07
1.6 TDi /Sportback		04/09-
1.8 TFSi /Sportback /Cab.		06/06-
1.9 TDi /Sportback /Cab.		06/03-
2.0 FSi /Sportback		06/03-06/06
2.0 TFSi /Sportback 4WD /Cab.		09/04-
2.0 TDi /FAP /Sportback /4WD /Cab.		06/03-
3.2i /Sportback		01/04-

9005327 Protecteur amortisseur G/D

OE 357413175A *L/R shock absorber protector*



4 H221.5

1.6i		09/96-
1.8i 20v. Turbo /4WD		09/96-
1.8 FSi		09/96-
1.9 TDi		09/96-

AUDI



... A3 ...

SASIC

AUDI



Barre stabilisatrice
 Stabilizer bar
 Barra estabilizadora
 Drażek stabilizatora
 стабилизатор поперечной устойчивости

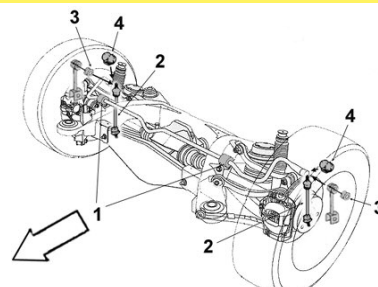

9005094 **Biellette barre stab.**
 OE 1K0505465K *Stabilizer bar stub axle*



2	1.2 TSi /Sportback /Cab.	BVM BV rob.	CBZB	10/09-
	1.4 TFSi /Sportback /Cab.			12/07-
	1.6 /i		BGU BSE	06/03-06/08
	1.6i /ETH /Sportback /Cab.		BSE CCSA CMXA	06/08-
	1.6 FSi		BAG BLF BLP	09/03-12/07
	1.6 TDi FAP /Sportback /Cab.	BVM BV rob.	CAYB CAYC	04/09-
	1.8 TFSi /Sportback /4WD /Cab.		BZB CDAA	02/08-
	1.8 TFSi 3ptes		BYT	06/06-06/08
	1.8 TFSi Sportback		BYT	06/06-12/07
	1.9 TDi		BKC BXE	06/03-06/08
	1.9 TDi /Sportback	BVM	BXE	06/08-
	1.9 TDi FAP /Sportback		BLS	04/05-06/08
	1.9 TDi FAP /Sportback /Cab.		BLS	06/08-
	2.0 FSi		AXW/XX BLR/LX/VY/WA	06/03-06/08
	2.0 TFSi /4WD /Sportback /Cab.			09/04-
	2.0 TFSi /Sportback /4WD S3			09/04-
	2.0 TDi /Sportback /4WD	BVM BV rob.	CFFB CFGB	10/09-
	2.0 TDi /DPF /4WD		CBBB	06/08-
	2.0 TDi /DPF /Sportback /4WD		BMM BUY	07/05-
	2.0 TDi /DPF /Sportback /4WD /Cab.		CBAA/B CFFA	08/08-
2.0 TDi /DPF Sportback		BKD BMN	06/03-	
2.0 TDi /Sportback		AZV	09/04-	
3.2i V6 24v. /Sportback /4WD			01/04-	

2306009 **Biellette barre stab.**
 OE 1J0505466B *Stabilizer bar stub axle*



2	1.8i 20v. Turbo 4WD 180hp 132kw	BVM		12/98-06/03
	1.9 TDi /4WD 130hp 96kw	BVM		10/00-06/03

9001739 **Palier de barre milieu**
 OE 1K0511327AP *Middle bar main bearing*



1	Barre Ø 18.5			
	1.2 TSi /Sportback		CBZB	10/09-07/12
	1.4 TFSi /Sportback		CAXC	12/07-
	1.6i /ETH /Sportback		CCSA CMXA	06/08-07/12
	1.6i 100hp 75kw /Sportback		BGU BSE	06/03-
	1.6 FSi		BAG BLF BLP	06/03-
	1.6 TDi FAP /Sportback		CAYB/C	04/09-07/12
	1.8 TFSi /Sportback		BYT BZB	06/06-07/12
	1.8 TFSi /Sportback /4WD		CDAA	06/08-
	1.9 TDi /Sportback		BKC BXE	06/03-
	1.9 TDi FAP /Sportback		BLS	04/06-
	2.0 FSi /Sportback	BVM /Tiptronic	AXW/XX BLR/LX/VY/WA	06/03-
	2.0 TFSi /Sportback		BWA CAWB	04/07-07/12
	2.0 TFSi /Sportback /4WD S3		CCZA CDLA/C	06/08-
	2.0 TFSi /Sportback /4WD S3		BHZ BZC	11/06-07/12
	2.0 TFSi Sportback /4WD		AXX BWA	09/04-06/08
	2.0 TDi		BKD BDB BMJ BUB	06/03-
2.0 TDi /FAP /Sportback /4WD		AZV BMM/N BUY	01/04-07/12	
2.0 TDi DPF/ Sportback /4WD		CBAA/B CBBB CFFA/B CFGB	06/08-07/12	
3.2i V6 24v. /Sportback /4WD		BDB BMJ BUB	01/04-	

... A3 ...

2306013

Palier de barre milieu

OE 1K0511327AQ Middle bar main bearing



1 Barre Ø 19.6

1.2 TSi Cab.	CBZB	02/08-
1.4 TFSi Cab.	CAXC	02/08-
1.6i Cab.	BSE	08/08-
1.6 TDi Cab.	CAYC	02/08-
1.8 TFSi Cab.	BZB CDAA	02/08-
1.9 TDi FAP Cab.	BLS	02/08-
2.0 TFSi Cab.	CAWB CCZA	02/08-
2.0 TDi /DPF Cab.	CBAA/B CAWB CFFA/B	02/08-

9001737

Palier de barre milieu

OE 1K0511327AR Middle bar main bearing



1 Barre Ø 20.7

1.2 TSi /Sportback	CBZB	10/09-
1.4 TFSi /Sportback	CAXC	12/07-
1.6i /ETH /Sportback	CCSA CMXA	06/08-07/12
1.6i /Sportback	BGU BSE	06/03-
1.6 FSi	BAG BLF BLP	06/03-
1.6 TDi FAP /Sportback	CAYB/C	04/09-07/12
1.8 TFSi /Sportback	BYT BZB	06/06-07/12
1.8 TFSi /Sportback /4WD	CDAA	06/08-
1.9 TDi /Sportback	BKC BXE	06/03-
1.9 TDi FAP /Sportback	BLS	04/05-
2.0 FSi /Sportback	AXW BLR/X BVY	06/03-06/06
2.0 TFSi	AXX BWA	06/03-
2.0 TFSi /Sportback 4WD S3	CCZA CDLA/C	06/08-
2.0 TFSi /Sportback 4WD S3	BHZ BZC	12/06-07/12
2.0 TFSi Sportback /4WD	AXX BWA	09/04-06/08
2.0 TFSi Sportback /4WD	CAWB	04/07-07/12
2.0 TDi	BKD	06/03-
2.0 TDi /FAP /Sportback /4WD	AZV BMM/N BUY	01/04-07/12
2.0 TDi DPF/ Sportback /4WD	CBAA/B CBBB CFFA/B CFGB	06/08-07/12
3.2i V6 4WD /Sportback	BDB BMJ BUB	01/04-



Support d'amortisseur

Suspension mounting
Soporte amortiguador
Poduszka amortyzatora
Опора амортизатора

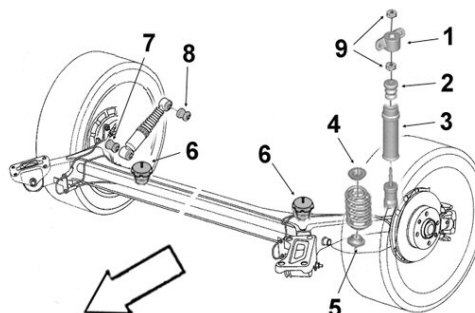

2656059

Support suspension

OE 1K0513353R Suspension mounting



1

1.2 TSi /Sportback	BVM6/ rob.7	CBZB	06/08-
1.4 TFSi /Sportback	BVM6/ rob.7	CAXC	06/08-
1.6i /Sportback /Cab.			01/04-
1.6 FSi /Sportback		BAG BLF/P	09/03-12/07
1.6 TDi FAP /Sportback		CAYB/C	06/08-
1.8 TFSi /Sportback /4WD /Cab.	BVM6/ rob.7		06/08-
1.9 TDi /Sportback 105hp 77kw /Cab.			06/03-
2.0 FSi /Sportback		AXW BLR/X BVY	06/03-06/06
2.0 TFSi /Sportback	BV rob.6	CAWB	04/07-
2.0 TFSi /Sportback /4WD	BVM6 /rob	CCZA	06/08-
2.0 TFSi /Sportback /4WD	BVM6 /rob.6	AXX	09/04-06/08
2.0 TFSi /Sportback /4WD	BVM6 /rob.6	BWA	09/04-
2.0 TFSi 4WD S3/ Sportback	BVM6 /rob.6	CDLA/C	06/08-
2.0 TFSi 4WD S3/ Sportback		BHZ BZC	12/06-
2.0 TFSi Cab.	BVM6 /rob.6	CAWB	02/08-
2.0 TDi /FAP /Sportback /4WD	BVM6 /rob.6	AZV BKD BMM/N BUY	01/04-
2.0 TDi FAP /Sportback /4WD	BVM6 /rob.6	CBAA/B CFFA/B CFGB	08/08-
2.0 TDi FAP /Sportback /4WD 170hp 125kw	BVM6 /rob.6	CBBB	06/08-
2.0 TDi FAP Cab.	BVM6 /rob.6	CBAB	02/08-
3.2i V6 24v. 4WD/ Sportback	BVM6 /rob.6	BDB BMJ BUB	09/04-

... A3 ...



Support d'amortisseur
Suspension mounting
Soporte amortiguador
Poduszka amortyzatora
Опора амортизатора

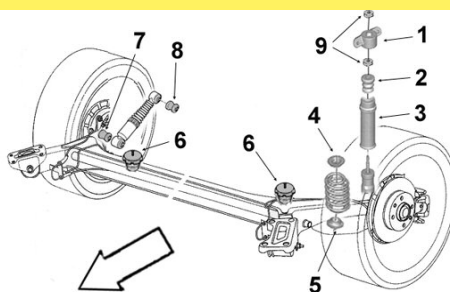

9005630

Support suspension G/D

OE 1J0513353B

L/R suspension mounting



1

1.6i AEH AKL APF	09/96-
1.6i AVU AGN	09/96-
1.8i 20v. Turbo AGU	09/96-
1.8i 20v. Turbo APP BV5	09/96-
1.8 FSi APG AGN	09/96-
1.9 TDi AGR ASV ASZ	09/96-

9005631

Support suspension G/D

OE 1K0513353H

L/R suspension mounting



1

1.6i BGU BSE	06/03-06/08
1.6i BGU Tiptronic	06/03-
1.6 FSi BAG BLF BLP	06/03-
1.9 TDi BKC BXE	06/03-06/08
2.0 FSi AXW	06/03-
2.0 TFSI /4WD	06/03-06/08
2.0 TDi BKD BVA	06/03-06/08
3.2i V6 24v. 4WD BDB BMJ BUB	09/04-06/08

2656043

Butée de suspension

OE 1K0511353J

Shock bush



2

Ovale Oval H100

1.2 TSi Berline	CBZB	10/09-
1.4 TFSi Berline	CAXC	12/07-
1.6i Berline	BGU	06/03-06/08
1.6i /4WD Berline	BSE CCSA	06/03-20/04/09
1.6i Cab.	BSE	08/08-
1.6 FSi Berline	BAG BLF/P	09/03-12/07
1.6 TDi FAP Berline /Cab.	CAYC/B	04/09-
1.8 TFSi /4WD Berline	BZB	06/06-20/04/09
1.8 TFSi Berline	BYT	06/06-06/08
1.8 TFSi Cab.	BZB	02/08-
1.8 TFSi Cab.	CDA A	11/08-
1.8 TFSi /4WD Berline	CDA A	06/08-
1.9 TDi Berline	BKC	06/03-06/08
1.9 TDi Berline	BXE	06/03-20/04/09
1.9 TDi FAP Berline	BLS	04/05-
1.9 TDi FAP Cab.	BLS	02/08-
2.0 FSi Berline	AXW BLR/X BVY	06/03-06/06
2.0 TFSi Berline	CAWB	04/07-20/04/09
2.0 TFSi 4WD S3 Berline	BHZ BZC	12/06-20/04/09
2.0 TFSi 4WD S3 Berline	CDLA/C	06/08-20/04/09
2.0 TFSi Cab.	CAWB	02/08-
2.0 TFSi Cab.	CCZA	11/08-
2.0 TFSi /4WD Berline	AXX BWA	09/04-20/04/09
2.0 TFSi /4WD Berline	CCZA	06/08-
2.0 TDi Berline	BUY	01/06-20/04/09
2.0 TDi Berline	AZV	01/04-20/04/09
2.0 TDi Berline	CFGB	06/10-
2.0 TDi /Cab.	CFFB	10/09-
2.0 TDi FAP Cab.	CBAB	02/08-
2.0 TDi FAP /4WD Berline	BMM	11/04-20/04/09
2.0 TDi FAP /4WD Berline	BMN	06/06-20/04/09
2.0 TDi FAP /4WD Berline	CBAA/B CBBB	06/08-20/04/09
2.0 TDi /4WD Berline 5ptes	CFFB	10/09-
2.0 TDi /4WD Berline	BKD	06/03-20/04/09
3.2i V6 24v. /4WD Berline	BUB	09/04-20/04/09
3.2i V6 24v. /4WD Berline	BDB	01/04-06/08
3.2i V6 24v. /4WD Berline	BMJ	09/04-06/08

2656049

Butée de suspension

OE 1K0511353M

Shock bush



2

H 133 susp. sport

1.2 TSi Cab.	CBZB	01/08-
1.4 TFSi Cab.	CAXC	01/08-
1.6i Cab.	BSE	01/08-
1.6 TDi FAP Cab.	CAYC	01/08-
1.8 TFSi Cab.	BZB CDA A	01/08-
1.9 TDi FAP Cab.	BLS	01/08-
2.0 TFSi Cab.	CAWB CCZA	01/08-
2.0 TDi /FAP Cab.	CBAA/B CFFA/B	01/08-

... A3

AUDI



9005328 Butée de suspension G/D

OE 1J0512131B *L/R suspension bush*



2 H 129

1.6i	AEH AKL APF	02/99-10/00
1.6i	AVU AGN	10/00-06/03
1.8i 20v. Turbo		09/96-06/03
1.8 FSi	APG AGN	09/96-06/03
1.9 TDi		09/96-06/03

Eléments TRAIN ARRIERE

Rear axle parts

Tren TRAS

Elementy zawieszenia tylnego

элементы задней оси.



2606001 Articulation traverse

OE 6R0501541A *Cross bar bush*



Ø int. 12 Ø ext. 71.5 coll. 80 long. tube int. 90 ext. 54.5

1.6i	02/99-06/03
1.8i 20v. Turbo	09/96-06/03
1.8 FSi	09/96-06/03
1.9 TDi	09/96-06/03

9001786 Articulation essieu G/D inf.

OE 1K0505553A *Lower L/R axle bush*



Ø int. 12 Ø ext. 37 long. tube int. 50 ext. 28

1.2 TSi /Sportback /Cab.	CBZB	10/09-07/12
1.4 TFSi /Sportback /Cab.	CAXC	12/07-
1.6i /Sportback /Cab.	BGU BSE	06/03-
1.6i /ETH /Sportback	CCSA CMXA	06/08-07/12
1.6 FSi	BAG BLF BLP	06/03-
1.6 TDi FAP /Sportback /Cab.	CAYB/C	04/09-07/12
1.8 TFSi /Sportback	BYT BZB	06/06-07/12
1.8 TFSi /Cab.	BZB	02/08-
1.8 TFSi /Sportback /4WD /Cab.	CDAA	06/08-
1.9 TDi /Sportback	BKC BXE	06/03-
1.9 TDi /Sportback /4WD /Cab.	BLS	04/05-
2.0 FSi	AXW/XX BLR/LX/VY/WA	06/03-
2.0 TFSi /Sportback	BWA CAWB	04/07-07/12
2.0 TFSi /Sportback /4WD S3	BHZ BZC	11/06-07/12
2.0 TFSi Sportback /4WD	AXX BWA	09/04-06/08
2.0 TFSi Cab.	CAWB CCZA	02/08-
2.0 TFSi /Sportback /4WD S3	CCZA CDLA/C	06/08-
2.0 TDi	BKD	06/03-
2.0 TDi /FAP /Sportback /4WD	AZV BMM/N BUY	01/04-07/12
2.0 TDi /DPF /Sportback /4WD /Cab.	CBAA/B CBBB CFFA/B CFGB	02/08-
2.0 TDi DPF Cab.	CBAB	02/08-
3.2i V6 24v. 4WD	BDB BMJ BUB	01/04-06/08
3.2i V6 24v. /Sportback /4WD	BUB	06/08-

A4 I 94-2000 ...

Eléments DIRECTION
Steering parts
Elementos Direcciones
Elementy układ kierowniczy
Элементы рулевой системы

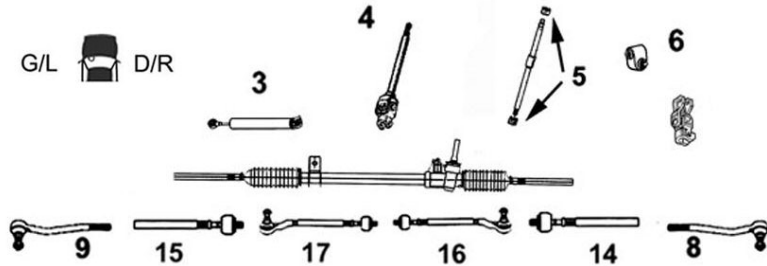

AUDI

9006247 **Axe de bielle G/D**
 OE 4B0422821 *L/R axial joint*

14 côté dir. M16x1.5 côté rot. M14x1.5 long 128 mm
15



1.6i /Avant	-09/01	2.5 TDi /Avant /4WD	-09/01
1.8i 20v. /Turbo /Avant /4WD	-09/01	2.6i V6 /Avant /4WD	-09/01
1.9 Di /Avant	-09/01	2.7i V6 /Turbo /Avant 4WD S4	-09/01
1.9 TDi /Avant /4WD	-09/01	2.8i V6 30v. /Avant /4WD	-09/01
2.4i V6 /Avant /4WD	-09/01		

9006302 **Rotule de direction G**
 OE 443419811D *Left tie rod end*

9 M16 x 1.5



TT /all models 4WD / Avant
 / Avant 4WD S4 01/90-12/91

9006301 **Rotule de direction D**
 OE 443419812D *Right tie rod end*

8 M16 x 1.5



TT /all models 4WD / Avant
 / Avant 4WD S4 01/90-12/91

9006304 **Rotule de direction G**
 OE 4A0419811A *Left tie rod end*

9 M20 x 1.5



TT /all models 4WD / Avant
 / Avant 4WD S4 01/91-12/94

9006303 **Rotule de direction D**
 OE 4A0419812A *Right tie rod end*

8 M20 x 1.5



TT /all models 4WD / Avant
 / Avant 4WD S4 01/91-12/94

9006413 **Rotule de direction G/D**
 OE 4B0419811F *L/R tie rod end*

8 M14 x 1.5
9



1.6i /Avant	-09/01
1.8i 20v. /Turbo /Avant	01/99-01/01
1.9 Di	04/96-02/99
1.9 TDi /Avant	-01/01
2.4i /Avant	01/99-01/01
2.5 TDi /Avant	01/99-01/01
2.8 /Avant	-01/01

... A4 I 94-2000 ...

7676051
Rotule de direction G/D

OE 4F0498811A

L/R tie rod end
NEW

8	M14x1.5				
9	1.6i /Avant	Conduite à D	Châssis sport	ch-8D-Y-005049	01/97-09/01
	1.6i /Avant	Conduite à G	Châssis sport	ch-8D-X-303810	01/97-09/01
	1.8i 20v. /Turbo /Avant	Conduite à D	Châssis sport	ch-8D-Y-005049	01/99-09/01
	1.8i 20v. /Turbo /Avant	Conduite à G	Châssis sport	ch-8D-X-303810	01/99-09/01
	1.9 TDi /Avant 90hp 66kw	Conduite à D	Châssis sport	ch-8D-Y-005049	09/96-09/01
	1.9 TDi /Avant 90hp 66kw	Conduite à G	Châssis sport	ch-8D-X-303810	09/96-09/01
	2.4i /Avant 165hp 121kw	Conduite à D		ch-8D-Y-005049	09/97-09/01
	2.4i /Avant 165hp 121kw	Conduite à G		ch-8D-X-303810	09/97-09/01
	2.5 TDi /Avant	Conduite à D	Châssis sport	ch-8D-Y-005049	04/98-09/01
	2.5 TDi /Avant	Conduite à G	Châssis sport	ch-8D-X-303810	04/98-09/01
	2.7i V6 30v./ Avant 4WD S4 265hp 195kw		AGB	BVM6	09/97-02/99
	2.7i V6 Avant 4WD S4 380hp 280kw		AZR	BVM6	07/00-09/01
	2.7i V6 RS4 Avant 4WD 380hp 280kw		ASJ	BVM6	07/00-09/01
	2.7i V6 Turbo 4WD/ Avant S4 265hp 195kw		AZB	BVM6	02/99-09/01
	2.8i V6 / 30v./ Avant 195hp 142kw	Conduite à D	Châssis sport	ch-8D-Y-005049	02/95-09/01
	2.8i V6 / 30v./ Avant 195hp 142kw	Conduite à G	Châssis sport	ch-8D-X-303810	02/95-09/01

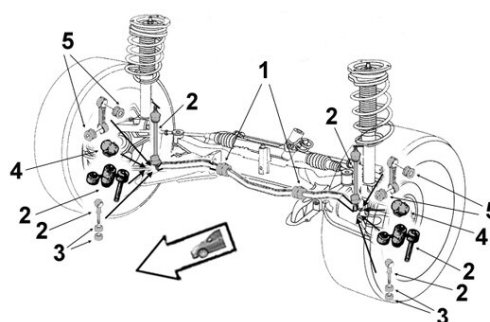
Barre stabilisatrice
Stabilizer bar
Barra estabilizadora
Drażek stabilizatora
стабилизатор поперечной устойчивости

9005086
Biellette barre stab. G

OE 8D0411317D

Left stabilizer bar stub axle

2	Ch- 8D-W-290001
	1.6i
	1.8i 20v./ 4WD /Turbo/ Turbo 4WD
	1.9 Di
	1.9 TDi /4WD
	2.4i /4WD
	2.5 TDi /4WD
	2.6i /4WD
	2.7i RS4 4WD Break
	2.7i S4 4WD
	2.8i /4WD

9005096
Biellette barre stab. D

OE 8D0411318D

Right stabilizer bar stub axle

2	Ch- 8D-W-290001
	1.6i
	1.8i 20v./ 4WD /Turbo/ Turbo 4WD
	1.9 Di
	1.9 TDi /4WD
	2.4i /4WD
	2.5 TDi /4WD
	2.6i /4WD
	2.7i RS4 4WD Break
	2.7i S4 4WD
	2.8i /4WD

2306011
Biellette barre stab.

OE 4D0411317K

Stabilizer bar stub axle

2	-ch 8D-W-290001
	1.6i
	1.8i 20v. /4WD
	1.8i 20v. Turbo /4WD
	1.9 Di BVM
	1.9 TDi /4WD -
	2.4i /4WD BVM
	2.8 V6 BVM
	2.8i V6 30v. /4WD

9001547
Palier de barre milieu

OE 4D0411327E

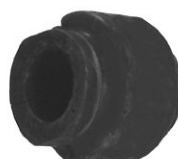
Middle bar main bearing

1	Barre Ø 26.8	
	1.6i	02/95-
	1.8i 20v./ turbo	02/95-
	1.9 Di	02/95-
	1.9 TDi	02/95-
	2.4i V6 30v.	02/95-
	2.5 TDi	02/95-
	2.6i V6	02/95-
	2.8i V6 / 30v.	02/95-

9001548
Palier de barre milieu

OE 4D0411327H

Middle bar main bearing

1	Barre Ø 29	
	1.6i	01/95-
	1.8i 20v. /turbo	01/95-
	1.9 Di	01/95-
	1.9 TDi	01/95-
	2.4i V6 30v.	01/95-
	2.5 TDi	01/95-
	2.6i V6	01/95-
	2.8i V6 /30v.	01/95-

... A4 I 94-2000 ...

SASIC

AUDI



Eléments SUSPENSION
Suspension parts
Elementos suspensión
Elementy zawieszenie
Элементы подвески

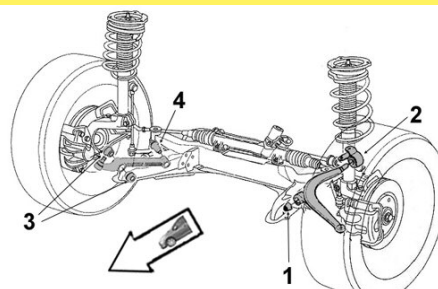

9001543 **Articulation bras sup. AV/AR**
 OE 4D0407515C *Upper arm bush F/R*



4 Ø int.10 Ø ext.46.5
 long. tube int.40 ext.25.5
 1.6 02/95-
 1.8i 20v./ turbo 02/95-
 1.9 Di 02/95-
 1.9 TDi 02/95-
 2.4i V6 30v. 02/95-
 2.5 TDi 02/95-
 2.6i V6 02/95-
 2.8i V6 /30v. 02/95-

9001538 **Articulation AV bras inf. AV**
 OE 4D0407181H *Front lower arm front bush*



1 Ø int.12 Ø ext.40 long. tube int.50 ext.42
 1.6i 01/95-
 1.8i 20v./ turbo 01/95-
 1.9 Di 01/95-
 1.9 TDi 01/95-
 2.4i V6 30v. 01/95-
 2.5 TDi 01/95-
 2.6i V6 01/95-
 2.8i V6 /30v. 01/95-

9001539 **Articulation AR bras inf. AV**
 OE 4D0407182G *Front lower rear arm bush*



2 Ø int.12 Ø ext.50 long. tube int.60 ext.31
 1.6 01/95-
 1.8i 20v./ turbo 01/95-
 1.9 Di 01/95-
 1.9 TDi 01/95-
 2.4i V6 30v. 01/95-
 2.5 TDi 01/95-
 2.6i V6 01/95-
 2.8i V6 /30v. 01/95-

9001540 **Articulation bras inf. AR**
 OE 4D0407183M *Lower arm bush Rear*



3 Ø int.12 Ø ext.65
 long. tube int.80 ext.65.5
 1.6 02/95-02/99
 1.8i /20v./ 4WD Avec clim. 02/95-02/99
 1.8i 20v. Turbo/ 4WD 02/95-02/99
 1.9 Di 02/95-02/99
 1.9 TDi 90hp 66kw 110hp 81kw 02/95-02/99
 2.4 02/95-02/99
 2.8 02/95-02/99

Bras & Triangle de suspension

Control arm
Brazo y triángulo
Wahacz
Рычаг подвески

G/L D/R

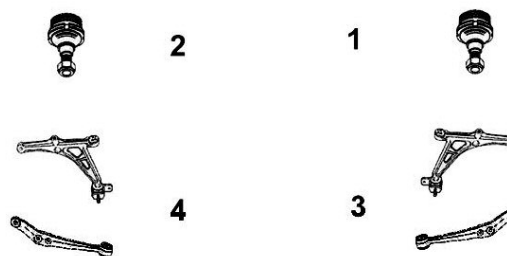

9005158 **Bras de suspension D**
 OE 437407156A *Right track control arm*



3 Avec rotule With ball joint
 TT /all models 4WD / Avant / Avant 4WD S4 01/90-12/91

9005161 **Bras de suspension G**
 OE 4A0407151 *Left track control arm*



4 Avec rotule With ball joint
 TT /all models 4WD / Avant / Avant 4WD S4 01/91-

9005160 **Bras de suspension D**
 OE 4A0407152 *Right track control arm*













3 Avec rotule With ball joint
 TT /all models 4WD / Avant / Avant 4WD S4 01/91-

... A4 I 94-2000 ...

AUDI

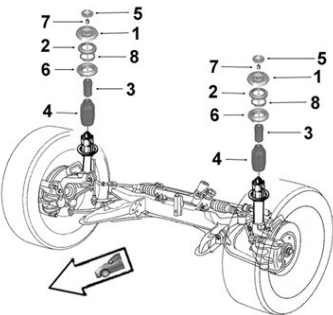
SASIC

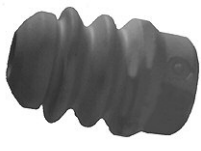
<p>9005747 Bras de susp. AR sup. G OE 8D0407509G <i>Left rear upper track control arm</i></p>  <p>4 Avec rotule <i>With ball joint</i></p> <table style="width: 100%; border: none;"> <tr><td>1.6</td><td>-12/98</td></tr> <tr><td>1.8i /20v. /4WD BVM</td><td>-12/98</td></tr> <tr><td>1.8i 20v. Turbo /4WD</td><td>-12/98</td></tr> <tr><td>1.9 Di</td><td>04/96-02/99</td></tr> <tr><td>1.9 TDi</td><td>-12/98</td></tr> <tr><td>2.8 /4WD</td><td>-12/98</td></tr> </table>	1.6	-12/98	1.8i /20v. /4WD BVM	-12/98	1.8i 20v. Turbo /4WD	-12/98	1.9 Di	04/96-02/99	1.9 TDi	-12/98	2.8 /4WD	-12/98	<p>9005748 Bras de susp. AR sup. D OE 8D0407510G <i>Right rear upper track control arm</i></p>  <p>3 Avec rotule <i>With ball joint</i></p> <table style="width: 100%; border: none;"> <tr><td>1.6</td><td>-12/98</td></tr> <tr><td>1.8i /20v. /4WD</td><td>-12/98</td></tr> <tr><td>1.8i 20v. Turbo /4WD</td><td>-12/98</td></tr> <tr><td>1.9 Di</td><td>04/96-02/99</td></tr> <tr><td>1.9 TDi</td><td>-12/98</td></tr> <tr><td>2.8 2WD /4WD</td><td>-12/98</td></tr> </table>	1.6	-12/98	1.8i /20v. /4WD	-12/98	1.8i 20v. Turbo /4WD	-12/98	1.9 Di	04/96-02/99	1.9 TDi	-12/98	2.8 2WD /4WD	-12/98								
1.6	-12/98																																
1.8i /20v. /4WD BVM	-12/98																																
1.8i 20v. Turbo /4WD	-12/98																																
1.9 Di	04/96-02/99																																
1.9 TDi	-12/98																																
2.8 /4WD	-12/98																																
1.6	-12/98																																
1.8i /20v. /4WD	-12/98																																
1.8i 20v. Turbo /4WD	-12/98																																
1.9 Di	04/96-02/99																																
1.9 TDi	-12/98																																
2.8 2WD /4WD	-12/98																																
<p>9005140 Bras de susp. AV sup. G OE 8E0407505A <i>Left front upper track control arm</i></p>  <p>4 Avec rotule <i>With ball joint</i></p> <table style="width: 100%; border: none;"> <tr><td>1.6</td><td></td></tr> <tr><td>1.8i /20v. /4WD</td><td></td></tr> <tr><td>1.8i 20v. Turbo 4WD</td><td></td></tr> <tr><td>1.9 Di</td><td>BVM 04/96-02/99</td></tr> <tr><td>1.9 TDi</td><td></td></tr> <tr><td>2.4 /4WD</td><td></td></tr> <tr><td>2.5 TDi /4WD</td><td></td></tr> <tr><td>2.8 /4WD</td><td></td></tr> </table>	1.6		1.8i /20v. /4WD		1.8i 20v. Turbo 4WD		1.9 Di	BVM 04/96-02/99	1.9 TDi		2.4 /4WD		2.5 TDi /4WD		2.8 /4WD		<p>9005141 Bras de susp. AV sup. D OE 8E0407506A <i>Right front upper track control arm</i></p>  <p>3 Avec rotule <i>With ball joint</i></p> <table style="width: 100%; border: none;"> <tr><td>1.6</td><td></td></tr> <tr><td>1.8i /20v. /4WD</td><td></td></tr> <tr><td>1.8i 20v. Turbo /4WD</td><td></td></tr> <tr><td>1.9 DI</td><td>BVM 04/96-02/99</td></tr> <tr><td>1.9 TDi</td><td></td></tr> <tr><td>2.4 /4WD</td><td></td></tr> <tr><td>2.5 TDi /4WD</td><td></td></tr> <tr><td>2.8 /4WD</td><td></td></tr> </table>	1.6		1.8i /20v. /4WD		1.8i 20v. Turbo /4WD		1.9 DI	BVM 04/96-02/99	1.9 TDi		2.4 /4WD		2.5 TDi /4WD		2.8 /4WD	
1.6																																	
1.8i /20v. /4WD																																	
1.8i 20v. Turbo 4WD																																	
1.9 Di	BVM 04/96-02/99																																
1.9 TDi																																	
2.4 /4WD																																	
2.5 TDi /4WD																																	
2.8 /4WD																																	
1.6																																	
1.8i /20v. /4WD																																	
1.8i 20v. Turbo /4WD																																	
1.9 DI	BVM 04/96-02/99																																
1.9 TDi																																	
2.4 /4WD																																	
2.5 TDi /4WD																																	
2.8 /4WD																																	
<p>9005156 Bras de susp. AR inf. G OE 8E0407693AG <i>Left rear lower track control arm</i></p>  <p>4 Avec rotule <i>With ball joint</i></p> <table style="width: 100%; border: none;"> <tr><td>1.6</td><td></td></tr> <tr><td>1.8i /20v. /4WD</td><td></td></tr> <tr><td>1.8i 20v. Turbo /4WD</td><td></td></tr> <tr><td>1.9 TDi</td><td></td></tr> <tr><td>2.4i</td><td></td></tr> <tr><td>2.5 TDi</td><td></td></tr> <tr><td>2.8 /4WD</td><td></td></tr> </table>	1.6		1.8i /20v. /4WD		1.8i 20v. Turbo /4WD		1.9 TDi		2.4i		2.5 TDi		2.8 /4WD		<p>9005154 Bras de susp. AR inf. D OE 8E0407694AG <i>Right rear lower track control arm</i></p>  <p>3 Avec rotule <i>With ball joint</i></p> <table style="width: 100%; border: none;"> <tr><td>1.6</td><td></td></tr> <tr><td>1.8i /20v. 4WD</td><td></td></tr> <tr><td>1.8i 20v. Turbo /4WD</td><td></td></tr> <tr><td>1.9 TDi</td><td></td></tr> <tr><td>2.4i</td><td></td></tr> <tr><td>2.5 TDi</td><td></td></tr> <tr><td>2.8 /4WD</td><td></td></tr> </table>	1.6		1.8i /20v. 4WD		1.8i 20v. Turbo /4WD		1.9 TDi		2.4i		2.5 TDi		2.8 /4WD					
1.6																																	
1.8i /20v. /4WD																																	
1.8i 20v. Turbo /4WD																																	
1.9 TDi																																	
2.4i																																	
2.5 TDi																																	
2.8 /4WD																																	
1.6																																	
1.8i /20v. 4WD																																	
1.8i 20v. Turbo /4WD																																	
1.9 TDi																																	
2.4i																																	
2.5 TDi																																	
2.8 /4WD																																	
<p>9005157 Bras de susp. AV inf. G/D OE 4D0407151P <i>L/R front lower track control arm</i></p>  <p>3 Avec rotule <i>With ball joint</i></p> <p>4</p> <table style="width: 100%; border: none;"> <tr><td>1.6</td><td></td></tr> <tr><td>1.8i /20v. /4WD</td><td></td></tr> <tr><td>1.8i 20v. Turbo /4WD</td><td></td></tr> <tr><td>1.9 Di</td><td>04/96-02/99</td></tr> <tr><td>1.9 TDi</td><td></td></tr> <tr><td>2.4i</td><td></td></tr> <tr><td>2.5 TDi</td><td></td></tr> <tr><td>2.8 /4WD</td><td></td></tr> </table>		1.6		1.8i /20v. /4WD		1.8i 20v. Turbo /4WD		1.9 Di	04/96-02/99	1.9 TDi		2.4i		2.5 TDi		2.8 /4WD																	
1.6																																	
1.8i /20v. /4WD																																	
1.8i 20v. Turbo /4WD																																	
1.9 Di	04/96-02/99																																
1.9 TDi																																	
2.4i																																	
2.5 TDi																																	
2.8 /4WD																																	
 <p>Support d'amortisseur <i>Suspension mounting</i> <i>Soporte amortiguador</i> <i>Poduszka amortyzatora</i> <i>Опора амортизатора</i></p>																																	
<p>9001710 Support suspension G/D OE 4D0412377F <i>L/R suspension mounting</i></p>  <p>1</p> <table style="width: 100%; border: none;"> <tr><td>1.6i</td><td>02/95-</td></tr> <tr><td>1.8i /20v. /4WD</td><td>02/95-</td></tr> <tr><td>1.8i 20v. Turbo /4WD</td><td>02/95-</td></tr> <tr><td>1.9 TDi</td><td>02/95-</td></tr> <tr><td>2.8i</td><td>02/95-</td></tr> <tr><td>2.8i 4WD</td><td>02/95-</td></tr> </table>	1.6i	02/95-	1.8i /20v. /4WD	02/95-	1.8i 20v. Turbo /4WD	02/95-	1.9 TDi	02/95-	2.8i	02/95-	2.8i 4WD	02/95-	<p>9005326 Butée de suspension G/D OE 8D0412131F <i>L/R suspension bush</i></p>  <p>3 H85 <i>sauf Sport</i></p> <table style="width: 100%; border: none;"> <tr><td>1.6i</td><td>02/95-</td></tr> <tr><td>1.8i 20v. /Turbo</td><td>02/95-</td></tr> <tr><td>1.9 Di</td><td>02/95-</td></tr> <tr><td>1.9 TDi</td><td>02/95-</td></tr> <tr><td>2.4i V6 30v.</td><td>02/95-</td></tr> <tr><td>2.5 TDi</td><td>02/95-</td></tr> <tr><td>2.6i V6</td><td>02/95-</td></tr> <tr><td>2.8i V6 /30v.</td><td>02/95-</td></tr> </table>	1.6i	02/95-	1.8i 20v. /Turbo	02/95-	1.9 Di	02/95-	1.9 TDi	02/95-	2.4i V6 30v.	02/95-	2.5 TDi	02/95-	2.6i V6	02/95-	2.8i V6 /30v.	02/95-				
1.6i	02/95-																																
1.8i /20v. /4WD	02/95-																																
1.8i 20v. Turbo /4WD	02/95-																																
1.9 TDi	02/95-																																
2.8i	02/95-																																
2.8i 4WD	02/95-																																
1.6i	02/95-																																
1.8i 20v. /Turbo	02/95-																																
1.9 Di	02/95-																																
1.9 TDi	02/95-																																
2.4i V6 30v.	02/95-																																
2.5 TDi	02/95-																																
2.6i V6	02/95-																																
2.8i V6 /30v.	02/95-																																

... A4 I 94-2000

SASIC

AUDI

Bras & Triangle de suspension

Control arm
Brazo y triángulo
Wahacz
Рычаг подвески

G/L  D/R

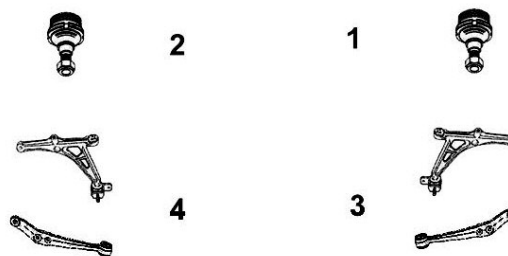

7476158

Bras de susp. AR G/D

OE 8D0501530

L/R rear track control arm

NEW

3
4

Avec rotule With ball joint



1.8i 20v. /Avant 4WD	07/95-04/00
1.8i 20v. Turbo /Avant 4WD	07/95-09/01
1.8i Turbo /Avant 4WD	10/97-08/01
1.9 TDi /Avant 4WD	10/91-01/01
2.2i /Avant 4WD S4	11/91-06/94
2.4i V6 /Avant 4WD	03/97-09/01
2.5 TDi /Avant 4WD	09/97-09/01
2.6i V6 /Avant 4WD	02/95-08/97
2.7i V6 /Avant 4WD /RS4 /S4	07/00-09/01
2.7i V6 Turbo /Avant 4WD S4	02/99-09/01
2.8i V6 /Avant 4WD	02/95-09/01
2.8i V6 30v. /Avant 4WD	04/96-09/01

Eléments TRAIN ARRIERE

Rear axle parts

Tren TRAS

Elementy zawieszenia tylnego

элементы задней оси.



9001549

Bague de palier AR

OE 8D0512333

Rear bearing ring



Ø int.16	
1.6i	01/95-12/98
1.8i / 20v. / Turbo	01/95-12/98
1.9 TDi	01/95-12/98
2.4i 30v.	01/95-12/98
2.5 TDi	01/95-12/98
2.6i	01/95-12/98
2.8i	01/95-12/98
2.8i 30v.	01/95-12/98

9001554

Articulation essieu AR

OE 8D0501541D

Rear axle bush



Ø int.12 Ø ext.56 coll.73.5 long. tube int.101 ext.78 ep. coll.22	
1.6i	01/95-12/98
1.8i /20v. /Turbo	01/95-12/98
1.9 Di	04/96-02/99
1.9 TDi 90hp 110hp	07/95-02/99
2.4i 30v.	01/95-12/98
2.5 TDi	01/95-12/98
2.6i	01/95-12/98
2.8i/ 30v.	01/95-12/98

9001764

Articulation essieu G/D

OE 8D0501541A

L/R axle bush



Ø int.12 Ø ext.56.5 coll.74 long. tube int.101 ext.59 ep. coll.22

1.6i	02/95-
1.8i /20v.	02/95-
1.8i 20v. Turbo	02/95-
1.9 TDi 90hp 66kw	02/95-
1.9 TDi 110hp 81kw	02/95-
2.8i	02/95-

A4 II 2000- ...

Eléments DIRECTION
Steering parts
Elementos Direcciones
Elementy uklad kierowniczy
Элементы рулевой системы

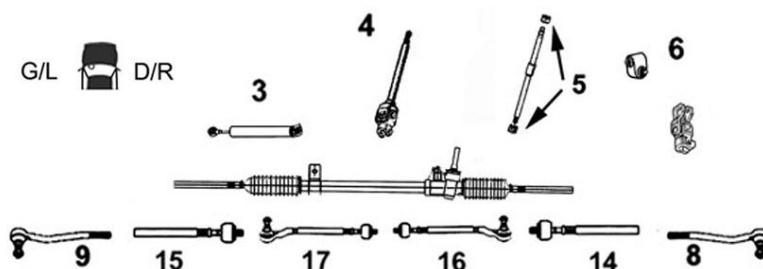

AUDI



7776081 Axe de bielle G/D

OE 8E0422821C *L/R axial joint*

NEW



14 15 Côté dir. M16x1.5 côté rot. M14x1.5 long 128 mm

TT /all models /Avant /4WD Ch- 8EZ1000001 -ch 8EZ8805000 01/01-04/08

TT /all models 4WD / Cab. 06/03-04/09

7676051 Rotule de direction G/D

OE 4F0498811A *L/R tie rod end*

NEW



8 9 M14 x 1.5

1.6i	ALZ	BVM5	11/04-04/08
1.8i 20v. Turbo /Avant Châssis sport			11/04-04/08
1.8i 20v. Turbo Cab. Châssis sport	BFB	BVM5 /Séq.	02/06-04/09
1.9 TDi /FAP /Avant Châssis sport			11/04-04/08
2.0i 20v./ Avant	ALT	BVM5 /Séq.	09/04-04/08
2.0 /TFSi/ Avant Châssis sport			09/04-04/08
2.0 TFSi Cab.	BWE	BVM6 /Séq.	02/06-04/09
2.0 TDi /FAP /Avant			09/04-04/08
2.0 TDi FAP Cab.	BPW	BVM6 /Séq.	02/06-04/09
2.5 TDi/ Avant	BDG	BVM6 /Séq.	09/04-06/06
2.7 TDi /Avant Châssis sport			01/06-04/08
2.7 TDi Cab.	BPP	BV Séq.	05/06-04/09
3.0 TDi 4WD Cab.	ASB	BVM6 BVA6	02/06-04/09
3.0 TDi /Avant/ 4WD Châssis sport			02/05-04/08
3.2 FSi /4WD Cab.	AUK	BVM6 BVA6/ Séq.	02/06-04/09
3.2 FSi/ Avant			01/05-04/08
4.2 FSi RS4 4WD Cab.	BNS	BVM6	03/06-09/08
4.2 FSi RS4/ Avant 4WD	BNS	BVM6	01/06-04/08
4.2i V8 4WD S4 Cab.	BBK	BVM6 BVA6	01/05-04/09
4.2i V8 4WD/ Avant S4	BBK	BVM6 BVA6	03/03-04/08

9006413 Rotule de direction G/D

OE 8E0411811B *L/R tie rod end*



8 9 M14 x 1.5

1.8i 20v. Turbo /4WD	AVJ BFB	01/01-
1.9 TDi	AWX	01/01-
2.0i 20v.	ALT	01/01-
2.5 TDi 4WD	AKE	01/01-
3.0 V6 /4WD	ASN BVM /Tiptronic	01/01-

... A4 II 2000- ...

SASIC

AUDI



Barre stabilisatrice
 Stabilizer bar
 Barra estabilizadora
 Drażek stabilizatora
 стабилизатор поперечной устойчивости

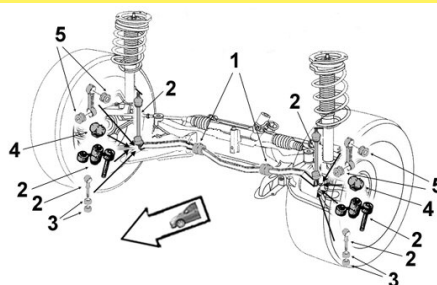

9005069

Biellette barre stab. G

OE 8E0411317

Left stabilizer bar stub axle

2	1.6i	ALZ	09/01-
	1.8i 20v. Turbo /4WD	AVJ BFB	01/01-
	1.9 TDi /4WD	AVB/VF/WX BKE/RB	01/01-
	2.0 FSi	AWA	08/02-
	2.0i 20v.	ALT	01/01-
	2.0 TFSi /4WD	BGB/WE	09/04-04/08
	2.0 TDi	BLB/RE	09/04-04/08
	2.0 TDi DPF /4WD /Avant	BRD	05/06-04/08
	2.0 TDi DPF /4WD /Avant /Cab.	BPW	09/04-04/09
	2.4i	BDV	08/02-
	2.5 TDi	BDG/DH/FC/CZ	01/01-
	2.5 TDi /4WD	AKE/YM BAU	01/01-
	2.5 TDi 4WD /4WD Avant	BDH	01/01-09/04
	2.7 TDi /Avant /Cab.	BPP	01/06-04/09
	3.0i V6 /4WD	ASN	01/01-
	3.0 TDi 4WD	BKN	02/05-12/05
	3.0 TDi 4WD /Avant /Cab.	ASB	01/06-04/09
	3.2 FSi /4WD	AUK	01/05-04/08
	4.2 FSi RS4 4WD /Avant /Cab.	BNS	01/06-09/08
	4.2i S4 V8 4WD /Avant	BBK	01/05-04/08



9005068

Biellette barre stab. D

OE 8E0411318

Right stabilizer bar stub axle

2	1.6i	ALZ	09/01-
	1.8i 20v. Turbo /4WD	AVJ BFB	01/01-
	1.9 TDi /4WD	AVB/VF/WX BKE/RB	01/01-
	2.0 FSi	AWA	08/02-
	2.0i 20v.	ALT	01/01-
	2.0 TFSi /4WD	BGB/WE	09/04-04/08
	2.0 TDi	BLB/RE	09/04-04/08
	2.0 TDi DPF /4WD /Avant	BRD	05/06-04/08
	2.0 TDi DPF /4WD /Avant /Cab.	BPW	09/04-04/09
	2.4i	BDV	08/02-
	2.5 TDi	BDG/DH/FC/CZ	01/01-
	2.5 TDi /4WD	AKE/YM BAU	01/01-
	2.5 TDi 4WD /4WD Avant	BDH	01/01-09/04
	2.7 TDi /Avant /Cab.	BPP	01/06-04/09
	3.0i V6 /4WD	ASN	01/01-
	3.0 TDi 4WD	BKN	02/05-12/05
	3.0 TDi 4WD /Avant /Cab.	ASB	01/06-04/09
	3.2 FSi /4WD	AUK	01/05-04/08
	4.2 FSi RS4 4WD /Avant /Cab.	BNS	01/06-09/08
	4.2i S4 V8 4WD /Avant	BBK	01/05-04/08



9001740

Palier de barre milieu

OE 4D0411327J

Middle bar main bearing

1	Ø 29		
	1.6i	ALZ	09/01-
	1.8i 20v. Turbo /4WD	AVJ BFB	01/01-
	1.9 TDi	AVB BKE	09/01-
	1.9 TDi	AWX AVF	01/01-
	1.9 TDi 4WD /Avant	AVF	01/02-09/04
	1.9 TDi DPF /Avant	BRB	09/05-04/08
	2.0i 20v.	ALT	01/01-
	2.0 FSi	AWA	08/02-
	2.0 TFSi /4WD	BGB BWE	09/04-04/08
	2.0 TDi DPF /Avant	BLB BRE	09/04-04/08
	2.0 TDi DPF /Avant /4WD Avant /Cab.	BPW	01/06-04/09
	2.0 TDi DPF /Avant /4WD Avant	BRD	05/06-04/08
	2.4i	BDV	09/01-
	2.5 TDi /4WD	AKE/YM BAU	09/01-
	2.5 TDi	BDG/H BFC BCZ	09/01-
	2.5 TDi 4WD /4WD Avant	BDH	01/01-09/04
	2.7 TDi /Avant /Cab.	BPP	01/06-04/09
	3.0 V6	ASN	01/01-
	3.0 TDi 4WD	BKN	02/05-12/05
	3.0 TDi 4WD /Avant /Cab.	ASB	01/06-04/09
	3.2 FSi /4WD	AUK	01/05-04/08
	4.2 FSi 4WD S4	BBK	01/05-04/08
	4.2 FSi RS4 4WD /Avant /Cab.	BNS	01/06-09/08



... A4 II 2000- ...



Eléments SUSPENSION
Suspension parts
Elementos suspensión
Elementy zawieszenie
Элементы подвески

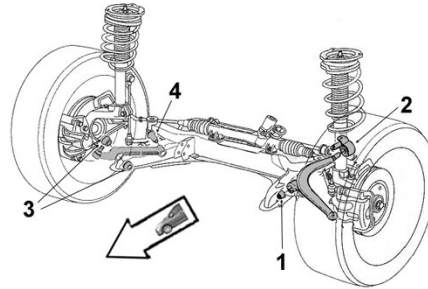

AUDI



9001758 Articulation bras sup. AV/AR

OE 4B0407515 *Upper arm bush F/R*



3	Ø int.10 Ø ext. 46.5 long. tube int.40 ext.26		
	1.6i	ALZ	09/01-
	1.8i 20v. Turbo /4WD	AVJ BFB	01/01-
	1.9 TDi	AVB/VF/WX	01/01-
	2.0 FSi	AWA	08/02-
	2.0i 20v.	ALT	01/01-
	2.4i	BDV	01/01-
	2.5 TDi /4WD /4WD Avant	AKE/YM BAU BDG/H BFC/CZ	01/01-
	3.0 V6	ASN	01/01-

9001539 Articulation AR bras inf. AV

OE 4D0407182G *Front lower rear arm bush*



2	Ø int.12 Ø ext.50 long. tube int.60 ext.31		
	1.6i	ALZ	09/01-
	1.8i 20v. Turbo /4WD	AVJ BFB	01/01-
	1.9 TDi	AVB AWX/VF	01/01-
	2.0 FSi	AWA	08/02-
	2.0i 20v.	ALT	01/01-
	2.4i	BDV	08/02-
	2.5 TDi	BDG/H BFC BCZ	01/01-
	2.5 TDi /4WD	AKE/YM BAU	01/01-
	2.5 TDi 4WD /4WD Avant	BDH	01/01-09/04
	3.0 V6	ASN	01/01-

2256004 Articulation AV bras inf. AV

OE 8E0407181C *Front lower arm front bush*



3	Ø int. 12.5 Ø ext. 40.5 long. tube int. 37 ext. 31		
	1.6i 100	BVM	09/01-09/04
	1.8i 20v. Turbo /4WD /Avant		09/01-12/01
	1.8i 20v. Turbo /Avant /4WD Avant	BFB	06/03-09/04
	1.9 TDI /4WD /Avant		09/01-09/04
	2.0i 20v. /Avant		01/01-09/04
	2.0 FSi 150 /Avant		06/03-09/04
	2.4i 170 /Avant		09/01-09/04
	2.5 TDI 180 4WD /Avant		09/01-09/04
	2.5 TDI 155 /Avant		09/01-08/02
	2.5 TDi 163/ Avant		08/02-09/04
	3.0i 220 /Avant		01/01-09/04
	3.0i 220 4WD /Avant		01/01-09/04

9001540 Articulation bras inf. AR

OE 4D0407183Q *Lower arm bush Rear*



4	Ø int.12 Ø ext.65 long. tube int.80 ext.65.5		
	1.6i	ALZ	09/01-09/04
	1.8i 20v. Turbo /4WD	AVJ BFB	01/01-09/04
	1.9 TDi	AVB/F AWX	09/01-09/04
	2.0i 20v.	ALT	01/01-09/04
	2.0 FSi	AWA	08/02-09/04
	2.4i	BDV	09/01-09/04
	2.5 TDi /4WD	AKE/YM BAU	01/01-09/04
	2.5 TDi	BDG/H/FC/CZ	01/01-09/04
	3.0 V6	ASN	01/01-09/04

... A4 II 2000- ...



Eléments SUSPENSION

Suspension parts
Elementos suspensión
Elementy zawieszenie
Элементы подвески

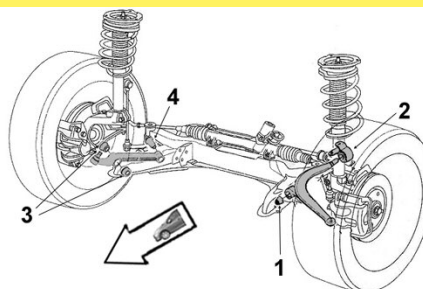

AUDI

SASIC

9001540 Articulation bras inf. AR

OE 4D0407183Q Lower arm bush Rear



4 Ø int.12 Ø ext.65 long. tube int. 80 ext.65.5

2.5 TDi 4WD /4WD Avant

BDH

01/01-09/04

2256005 Articulation bras inf. AR

OE 4F0407183C Lower arm bush Rear



4 Ø int. 12 Ø ext. 65 long. tube int. 80 ext. 55.5

1.6i
1.8i 20v. Turbo /4WD /Avant
1.9 TDi /Avant
2.0i 20v. /Avant
2.0 TFSi /4WD /Avant
2.0 TDi /Avant
2.5 TDi /Avant
3.0 TDi 4WD
3.2 FSi 4WD

09/04-04/08
09/04-04/08
09/04-04/08
09/04-04/08
09/04-04/08
09/04-04/08
09/04-04/08
09/04-04/08
09/04-04/08

Bras & Triangle de suspension

Control arm
Brazo y triángulo
Wahacz
Рычаг подвески

G/L D/R



9005749 Bras de susp. AR sup. G

OE 8E0407509A Left rear upper track control arm

4 Avec rotule With ball joint

1.6i 09/01-09/04
2.0 FSi 08/02-09/04
2.4i V6 30v. 09/01-09/04

OE 4D0407509G

1.8i 20v. Turbo /4WD 01/01-
1.9 TDi /4WD AVB/VF/WX BKE 01/01-
2.0i 20v. ALT BVM /BVA 01/01-
2.5 TDi /4WD 01/01-
3.0 V6 /4WD ASN BVM /Tiptronic 01/01-



9005750 Bras de susp. AR sup. D

OE 8E0407510A Right rear upper track control arm

3 Avec rotule With ball joint

1.6i 09/01-09/04

OE 4D0407510G









1.8i 20v. Turbo /4WD 01/01-
1.9 TDi /4WD AVB/VF/WX BKE 01/01-
2.0i 20v. ALT BVM /BVA 01/01-
2.5 TDi /4WD 01/01-
3.0 V6 /4WD ASN BVM /Tiptronic 01/01-



OE 4D0407510J

2.0 FSi 08/02-09/04
2.4i V6 30v. 09/01-09/04

... A4 II 2000- ...

... A4 II 2000- ...			
7476206 OE 8E0407509P	Bras de suspension Sup. AR G <i>Rear Upper left track control arm</i>	7476207 OE 8E0407510P	Bras de suspension Sup. AR D <i>Rear Upper right track control arm</i>
	<p style="text-align: center;">4 Avec rotule With ball joint Ø 16</p> <p>1.6i 11/04-04/08 1.8i 20v Turbo Cab. Susp. Sport Ch- F8H-5014476 -04/09 1.8i 20v. Turbo /4WD 11/04-04/08 1.9 TDi 11/04-04/08 2.0i 20v. 09/04-04/08 2.0 TFSI /4WD 09/04-04/08 2.0 TFSi Cab. 02/06-04/09 2.0 TDi /4WD 09/04-04/08 2.0 TDi Cab. 02/06-04/09 2.5 TDi 09/04-06/06 2.7 TDi 01/06-04/08 2.7 TDi Cab. 05/06-04/09 3.0 TDi 4WD 02/05-04/08 3.0 TDi 4WD Cab. 02/06-04/09 3.2 FSi /4WD 01/05-04/08 3.2 FSi 4WD Cab. 02/06-04/09 4.2 V8 4WD S4 /Cab. Susp. Sport 03/03-12/05</p>		<p style="text-align: center;">3 Avec rotule With ball joint Ø 16</p> <p>1.6i 11/04-04/08 1.8i 20v Turbo Cab. Susp. Sport Ch- F8H-5014476 -04/09 1.8i 20v. Turbo /4WD 11/04-04/08 1.9 TDi 11/04-04/08 2.0i 20v. 09/04-04/08 2.0 TFSI /4WD 09/04-04/08 2.0 TFSi Cab. 02/06-04/09 2.0 TDi /4WD 09/04-04/08 2.0 TDi Cab. 02/06-04/09 2.5 TDi 09/04-06/06 2.7 TDi 01/06-04/08 2.7 TDi Cab. 05/06-04/09 3.0 TDi 4WD 02/05-04/08 3.0 TDi 4WD Cab. 02/06-04/09 3.2 FSi /4WD 01/05-04/08 3.2 FSi 4WD Cab. 02/06-04/09 4.2 V8 4WD S4 /Cab. Susp. Sport 03/03-12/05</p>
9005140 OE 8E0407505A	Bras de susp. AV sup. G <i>Left front upper track control arm</i>	9005141 OE 8E0407506A	Bras de susp. AV sup. D <i>Right front upper track control arm</i>
	<p style="text-align: center;">4 Avec rotule With ball joint</p> <p>1.6i 01/01-09/04 1.8i 20v. Turbo /4WD AVJ BFB 01/01- 1.9 TDi /4WD AVB/F AWX 01/01- 2.0i 20v. ALT BVM /BVA 01/01- 2.0 FSi AWA 08/02-09/04 2.4i V6 BDV 01/01-09/04 2.5 TDi /4WD 01/01- 3.0 V6 /4WD ASN BVM /Tiptronic 01/01-</p>		<p style="text-align: center;">3 Avec rotule With ball joint</p> <p>1.6i 01/01-09/04 1.8i 20v. Turbo /4WD AVJ BFB 01/01- 1.9 TDi /4WD AVB/F AWX 01/01- 2.0i 20v. ALT BVM /BVA 01/01- 2.0 FSi AWA 08/02-09/04 2.4i V6 BDV 01/01-09/04 2.5 TDi /4WD 01/01- 3.0 V6 /4WD ASN BVM /Tiptronic 01/01-</p>
9005156 OE 8E0407693AG	Bras de susp. AR inf. G <i>Left rear lower track control arm</i>	9005154 OE 8E0407694AG	Bras de susp. AR inf. D <i>Right rear lower track control arm</i>
	<p style="text-align: center;">4 Avec rotule With ball joint</p> <p>1.6i ALZ 01/01-09/04 1.8i 20v. Turbo /4WD AVJ BFB 01/01-09/04 1.9 TDi /4WD AVB /F/V/WX BKE 01/01-09/04 2.0i 20v. ALT BVM /BVA 01/01-09/04 2.0 FSi AWA 08/02-09/04 2.4i V6 BDV 01/01-09/04 2.5 TDi 4WD AKE/YM 01/01-09/04 2.5 TDi /4WD BDG/FC/CZ/AU/DH 08/02-09/04 3.0 V6 /4WD ASN BVM /Tiptronic 01/01-09/04</p>		<p style="text-align: center;">3 Avec rotule With ball joint</p> <p>1.6i ALZ 01/01-09/04 1.8i 20v. Turbo /4WD AVJ BFB 01/01-09/04 1.9 TDi /4WD AVB /F/V/WX BKE 01/01-09/04 2.0i 20v. ALT BVM /BVA 01/01-09/04 2.0 FSi AWA 08/02-09/04 2.4i V6 BDV 01/01-09/04 2.5 TDi 4WD AKE/YM 01/01-09/04 2.5 TDi /4WD BDG/FC/CZ/AU/DH 08/02-09/04 3.0 V6 /4WD ASN BVM /Tiptronic 01/01-09/04</p>
7476202 OE 8E0407693AL	Bras de susp. AR inf. G <i>Left rear lower track control arm</i>	7476203 OE 8E0407694AL	Bras de susp. AR inf. D <i>Right rear lower track control arm</i>
	<p style="text-align: center;">4 Avec rotule With ball joint</p> <p>TT /all models /4WD /Avant /Avant 4WD /S4 /S4Avant Sauf Cab. Ch-8EZ5400001 -ch 8EZ8805000 09/04-04/08 TT /all models /4WD Cab. 02/06-04/09</p>		<p style="text-align: center;">3 Avec rotule With ball joint</p> <p>TT /all models /4WD /Avant /Avant 4WD /S4 /S4Avant Sauf Cab. Ch-8EZ5400001 -ch 8EZ8805000 09/04-04/08 TT /all models /4WD Cab. 02/06-04/09</p>

AUDI



... A4 II 2000- ...

SASIC

AUDI

Bras & Triangle de suspension

Control arm
Brazo y triángulo
Wahacz
Рычаг подвески

G/L  D/R

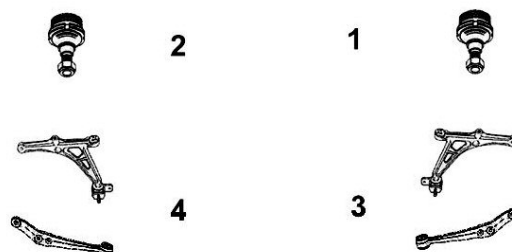

7476019

Bras de susp. AV inf. G/D

OE 8E0407151R

L/R front lower track control arm



3 Avec rotule With ball joint

4	1.6i	11/00-	2.4i	09/01-12/04
	1.8 Turbo /4WD	11/00-	2.5 TDi	08/01-05/06
	1.9 TDi /4WD	11/00-	2.7 TDi	11/05-
	2.0	11/00-	3.0i /4WD	11/00-07/06
	2.0 FSi	07/02-12/04	3.0 TDi 4WD	11/04-
	2.0 TFSi /4WD	11/04-	3.2 FSi /4WD	01/05-
	2.0 TDi /4WD	11/04-	4.2i S4 /RS4	03/03-



Support d'amortisseur

Suspension mounting
Soporte amortiguador
Poduszka amortyzatora
Опора амортизатора

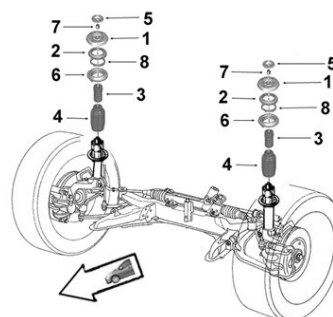

9005620

Support suspension G/D

OE 8E0412377C

L/R suspension mounting



1	1.8i 20v. Turbo	AVJ	01/01-
	1.9 TDi	AWX	01/01-
	2.0i 20v.	ALT	01/01-
	2.5 TDi	AKE	01/01-
	3.0 V6	ASN	01/01-

9005326

Butée de suspension G/D

OE 8D0412131F

L/R suspension bush



3	H85		
	1.6i susp. sport	ALZ	09/01-
	1.8i 20v. Turbo susp. sport	BFB	11/04-
	1.8i 20v. Turbo /4WD susp. sport	AVJ BFB	01/01-
	1.9 TDi susp. sport	AVB/WX BKE/RB	01/01-
	2.0i 20v. susp. sport	ALT	01/01-
	2.0 TFSi	BGB BWE	09/04-
	2.0 TDi susp. sport	BLB BRE	09/04-
	2.4i susp. sport	BDV	09/01-
	2.5 TDi susp. sport		01/01-
	3.0 V6 susp. sport	ASN	01/01-
	3.0 TDi	BKN	02/05-
	3.2 FSi	AUK	01/05-

2656009

Butée de suspension

OE 8D0412131E

Shock bush



3	H77	
	4.2i S4 V8 4WD	01/05-04/08

... A4 II 2000- ...



Barre stabilisatrice
 Stabilizer bar
 Barra estabilizadora
 Drażek stabilizatora
 стабилизатор поперечной устойчивости

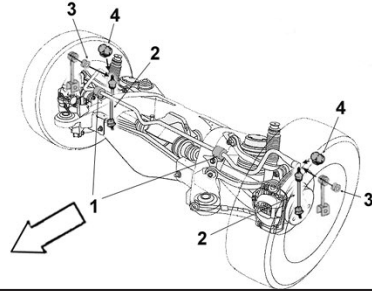

2306012 **Biellette barre stab.** OE 8E0505465AF *Stabilizer bar stub axle*



2	1.6i	BVM	09/01-04/08
	1.8i 20v. Turbo/Avant/4WD/4WD Avant	BVM	01/01-04/08
	1.9 TDi /Avant		09/01-04/08
	1.9 TDi 4WD /Avant	BVM	01/02-09/04
	2.0i 20v. /Avant		01/01-09/04
	2.0i 20v. /Avant	ALT	11/04-04/08
	2.0 FSi /Avant		08/02-09/04
	2.0 TFSi/Avant / 4WD /4WD Avant		09/04-04/08
	2.0 TDi /Avant		09/04-04/08
	2.4i V6 30v. /Avant		09/01-09/04
	2.5 TDi /Avant		09/01-06/06
	2.5 TDi 4WD /Avant		09/01-09/04
	2.7 TDi /Avant /Cab.	BPP	01/06-04/09
	3.0i V6 30v. /Avant		01/01-09/04
	3.0i V6 30v. 4WD /Avant		01/01-09/04
	3.0 TDi 4WD /Avant /Cab.	ASB	01/06-04/09
3.0 TDi 4WD /Avant		02/05-12/05	
3.2 FSi /Avant	BV Séquent.	01/05-04/08	
3.2 FSi 4WD /Avant		01/05-04/08	
4.2i RS4 /Break /Cab.		01/06-09/08	
4.2i S4 V8 4WD /Avant	BBK	01/04-04/08	

2306104 **Palier de barre** OE 8E0511327A *Bar main bearing*



1	Ø 17.5 -ch 8EZ8-805000		
	1.6i /Avant		09/01-
	1.8i 20v. Turbo /4WD /Avant /Cab.		01/01-
	1.9 TDi /Avant		09/01-
	2.0i 20v. /FSi /Avant		01/01-
	2.0 TFSi /4WD /Avant /Cab.		09/04-
	2.0 TDi /Avant /4WD /Cab.		09/04-
	2.4i		09/01-
	2.5 TDi /Avant /4WD		09/01-
	2.7 TDi /Avant /Cab.		01/06-
	3.0i /Avant /4WD		01/01-
	3.0 TDi 4WD /Avant		02/05-
3.2 FSi /4WD /Avant /Cab.		01/05-	
4.2i 4WD /Avant		01/05-	

2306105 **Palier de barre** OE 4B0511327 *Bar main bearing*



1	Ø 16 -ch 8EZ8-80500		
	1.6i /Avant		09/01-
	1.8i 2.0v. Turbo /4WD /Avant		01/01-
	1.9 TDi /Avant		09/01-
	2.0i 20v. /FSi /Avant		01/01-
	2.0 TFSi /4WD /Avant		09/04-
	2.0 TDi /Avant /4WD		09/04-
	2.4i		09/01-
	2.5 TDi /Avant /4WD		09/01-
	2.7 TDi /Avant		01/06-
	3.0i /Avant /4WD		01/01-
	3.0 TDi 4WD /Avant		02/05-
3.2 FSi /4WD /Avant		01/05-	
4.2i 4WD /Avant		01/05-	

... A4 II 2000-

SASIC

AUDI

Eléments TRAIN ARRIERE

Rear axle parts

Tren TRAS

Elementy zawieszenia tylnego

элементы задней оси.



9001776

Articulation porte moyeu

OE 8E0505203D

Hub seat bush

Ø int.12 Ø ext.44 coll.46 coll.51 long.tube int.60 ext.27 ep.coll.5



1.6i	ALZ	09/01-
1.8i 20v. Turbo /4WD	AVJ BFB	01/01-
1.9 TDi /4WD	AVB/F AWX BKE	01/01-
2.0i 20v.	ALT	01/01-
2.0 FSi	AWA	08/02-
2.0 TFSi /4WD	BGB BWE	09/04-04/08
2.0 TDi	BLB BRE	09/04-04/08
2.0 TDi DPF 4WD /Avant	BPW BRD	01/06-04/08
2.4i	BDV	09/01-
2.5 TDi	BDG	01/01-
2.5 TDi /4WD	AKE/YM BAU	01/01-
2.5 TDi /4WD /4WD Avant	BDH/FC/CZ	01/01-
3.0 V6	ASN	01/01-
3.0 TDi 4WD	BKN	02/05-12/05
3.0 TDi 4WD /Avant /Cab.	ASB	01/06-04/09
3.2 FSi /4WD	AUK	01/05-04/08
4.2 FSi 4WD S4	BBK	01/05-04/08

9001746

Articulation traverse AV G/D

OE 8E0505145AR

L/R Front cross bar bush

Ø int.18.5 Ø ext.80 coll.88 long.tube int.68 ext.62 ep.coll.6



1.8i 20v. Turbo	AVJ	01/01-
1.9 TDi	AWX	01/01-
2.0i 20v.	ALT	01/01-
2.5 TDi	AKE	01/01-
3.0 V6	ASN	01/01-

9003101

Articulation traverse AR G/D

OE 8E0505145AP

L/R rear cross bar bush

Ø int.20 Ø ext.80 coll.87.5 long.tube int.68 ext.55 ep.coll.8



1.8i 20v. Turbo	AVJ	01/01-
1.9 TDi	AWX	01/01-
2.0i 20v.	ALT	01/01-
2.5 TDi	AKE	01/01-
3.0 V6	ASN	01/01-

A4 III 2008-

Eléments DIRECTION

Steering parts

Elementos Direcciones

Elementy układ kierowniczy

Элементы рулевой системы

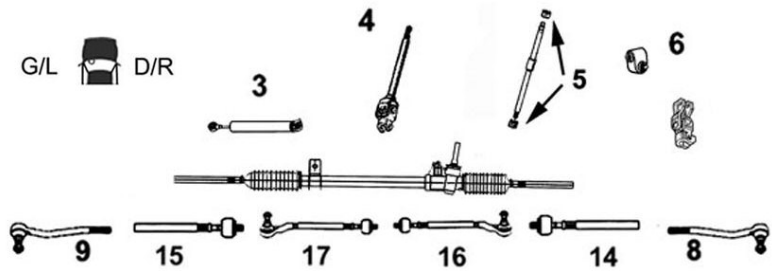

7776078

Axe de bielle G/D

OE 4H0422810A

L/R axial joint

NEW

14 Côté dir. M16x1.5 Côté rot. M16x1.5 long 226 mm
15



1.8 TFSi /4WD /Avant	Ch- WAUZZZ8KZ8-000001	
2.0 TFSi /4WD /Avant	Ch- WAUZZZ8KZ8-000001	
2.0 TFSi Allroad /Avant	Sauf DA électromécanique	
2.0 TDi /4WD /Avant	Ch- WAUZZZ8KZ8-000001	01/10-
2.0 TDi Allroad /Avant	Sauf DA électromécanique	
2.7 TFSi /Avant	Ch- WAUZZZ8KZ8-000001	-10/11
3.0 TDi 4WD /Avant	Ch- WAUZZZ8KZ8-000001	-10/11
3.0 TDi /Allroad /Avant	Sauf DA électromécanique	01/10-
3.0 TDi 4WD /Avant		11/11-
3.0 TSi /TFSi 4WD /Avant		11/11-

7676052

Rotule de direction G

OE 8K0422817B

Left tie rod end

NEW

9 M16 x 1.5



1.8 TFSi /Avant 120hp 88kw	CDHA	01/08-10/11
1.8 TFSi 4WD/Avant 160hp 118kw	CDHB	08/08-10/11
2.0 TFSi /Avant 180hp 133kw	CDNB	10/08-10/11
2.0 TFSi /4WD /Avant 210hp 155kw	CDNC	08/08-10/11
2.0 TFSi Avant Allroad 210hp 155kw	CDNC	BVM BV rob. 03/09-
2.0 TDi FAP/Avant 120hp 88kw 136hp 100kw	CAGB/C	BVM 01/08-10/11
2.0 TDi FAP/4WD/Avant 142hp 105kw 170hp 125kw	CAGA/HA	01/08-10/11
2.0 TDi FAP Avant Allroad 170hp 125kw	CAHA	BVM 03/09-
2.7 TDi FAP /Avant 190hp 140kw	CAMA	01/08-10/11
2.7 TDi FAP 190hp 140kw	CGKA	01/08-10/11
2.7 TDi FAP Avant 190hp 140kw	CGKA	BVM 11/08-10/11
3.0 TDi FAP 4WD /Avant 240hp 176kw	CAPA CCWA	11/07-10/11
3.0 TDi FAP Avant Allroad 240hp 176kw	CCWA	BVM BV rob. 03/09-
3.0 TFSi 4WD S4 /Avant 330hp 245kw	CAKA	10/08-10/11
3.2 FSi /4WD /Avant 265hp 195kw	CALA	11/07-10/11

7676053

Rotule de direction D

OE 8K0422818B

Right tie rod end

NEW

8 M16 x 1.5



1.8 TFSi /Avant 120hp 88kw	CDHA	01/08-10/11
1.8 TFSi 4WD/Avant 160hp 118kw	CDHB	08/08-10/11
2.0 TFSi /Avant 180hp 133kw	CDNB	10/08-10/11
2.0 TFSi /4WD /Avant 210hp 155kw	CDNC	08/08-10/11
2.0 TFSi Avant Allroad 210hp 155kw	CDNC	BVM BV rob. 03/09-
2.0 TDi FAP/Avant 120hp 88kw 136hp 100kw	CAGB/C	BVM 01/08-10/11
2.0 TDi FAP/4WD/Avant 142hp 105kw 170hp 125kw	CAGA/HA	01/08-10/11
2.0 TDi FAP Avant Allroad 170hp 125kw	CAHA	BVM 03/09-
2.7 TDi FAP /Avant 190hp 140kw	CAMA	01/08-10/11
2.7 TDi FAP 190hp 140kw	CGKA	01/08-10/11
2.7 TDi FAP Avant 190hp 140kw	CGKA	BVM 11/08-10/11
3.0 TDi FAP 4WD /Avant 240hp 176kw	CAPA CCWA	11/07-10/11
3.0 TDi FAP Avant Allroad 240hp 176kw	CCWA	BVM BV rob. 03/09-
3.0 TFSi 4WD S4 /Avant 330hp 245kw	CAKA	10/08-10/11
3.2 FSi /4WD /Avant 265hp 195kw	CALA	11/07-10/11

... A4 III 2008- ...



Barre stabilisatrice
 Stabilizer bar
 Barra estabilizadora
 Drążek stabilizatora
 стабилизатор поперечной устойчивости

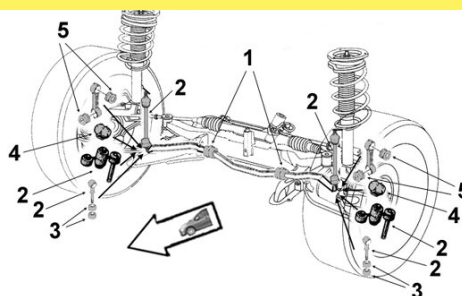

2306118 **Palier de barre milieu**
 OE 8K0411327A *Middle bar main bearing*

1 Ø24



1.8 TFSi /Avant	CDHA	BVM6 /Séq.	01/08-10/11
1.8 TFSi /Avant /4WD	CDHB	BVM6 /Séq.	08/08-10/11
1.8 TSI 170hp 125kw /SW	CJEB	BVM6 /Séq.	10/11-
2.0 TFSi /Avant	CDNB	BVM6 /Séq.	07/08-10/11
2.0 TFSi /Avant	CDNC	BV Séq.	08/08-
2.0 TFSi /Avant	CDNC	BVM6	07/08-10/11
2.0 TFSi 4WD/ Avant	CDNC	BVM6	07/08-
2.0 TFSi Avant 4WD	CDNC	BV rob.7	10/11-
2.0 TFSi ETH /Avant /4WD	CFKA	BVM6	10/11-
2.0 TSi 4WD	CDNC	BV rob.7	10/11-
2.0 TDi 4WD FAP /Avant	CAGA	BVM6	10/08-10/11
2.0 TDi FAP /Avant	CAGA	BVM6 /Séq.	01/08-10/11
2.0 TDi FAP /Avant	CAGC	BVM6	04/08-10/11
2.0 TDi FAP /Avant	CGLD CJCA/B/C	BVM6 /Séq.	10/11-
2.0 TDi FAP /Avant /4WD	CAHA	BVM6	01/08-10/11
2.0 TDi FAP /Avant /4WD	CGLC	BVM6 /Séq.	10/11-
2.7 TDi FAP /Avant	CGKA CAMA	BV Séq.	01/08-10/11
2.7 TDi FAP /Avant	CGKA	BVM6	11/08-10/11
3.0 TDi 4WD FAP/ Avant	CDUC		10/11-
3.0 TDi 4WD FAP/ Avant	CKVB	BV rob.7	10/11-
3.0 TDi FAP 4WD/ Avant	CAPA	BVM6	05/08-10/11
3.0 TDi FAP 4WD/ Avant	CCWA	BVM6 BVA6	01/08-10/11
3.0 TDi FAP/SW	CLAB	BV Séq.	10/11-
3.0 TFSi 4WD /Avant	CMUA	BV rob.7	10/11-
3.0 TSi 4WD/ SW	CGWC	BV rob.7	10/11-
3.2 FSi 4WD/ Avant	CALA	BVM6 BVA6	01/08-10/11
3.2 FSi/ Avant	CALA	BV Séq.	11/07-10/11

9001547 **Palier de barre milieu**
 OE 4D0411327G *Middle bar main bearing*

1 Barre Ø26.8

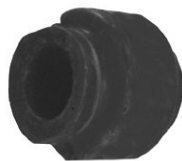

1.8 TSI 170hp 125kw /SW	CJEB		10/11-
1.8 TFSi /Avant	CDHA		01/08-
1.8 TFSi /4WD /Avant /Avant 4WD	CDHB		01/08-
2.0 TFSi ETH /Avant /4WD	CFKA		10/11-
2.0 TFSi /Avant	CDNB		07/08-
2.0 TFSi /4WD /Avant /Avant 4WD	CDNC		07/08-
2.0 TDi FAP /Avant /4WD	CGLC/D CJCA/B/C		10/11-
2.0 TDi DPF 4WD /Avant /Avant 4WD	CAGA		01/08-
2.0 TDi DPF 4WD /Avant /Avant 4WD	CAGC CAHA		01/08-
2.7 TDi DPF /Avant	CAMA CGKA		01/08-
3.0 TDi DPF 4WD /Avant 4WD	CDUC CKVB		10/11-
3.0 TDi DPF/Avant	CLAB		10/11-
3.0 TDi DPF 4WD /Avant 4WD	CAPA CCWA		01/08-
3.0 TFSi Avant 4WD	CMUA		10/11-
3.0 TFSi 4WD /Avant	CAKA		10/08-
3.0 TSi Avant 4WD	CGWC		10/11-
3.2 FSi /4WD /Avant /Avant 4WD	CALA		01/08-

... A4 III 2008- ...



Eléments SUSPENSION

Suspension parts

Elementos suspensión

Elementy zawieszenia

Элементы подвески

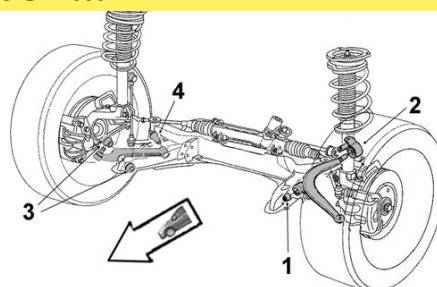

AUDI



2256052

Articulation bras sup. AV/AR

OE 8K0407515

Upper arm bush F/R

4 Ø int. 10 Ø ext. 46.5 long. tube int.40 ext.26



1.8 TFSi 120hp 160hp / 4WD
2.0 TFSi 180hp 211hp / 4WD
2.0 TDi 120hp 142hp / 4WD
2.7 TDi 190hp 140kw
3.0 TDi 240hp 176kw 4WD
3.0 TFSi 330hp 245kw 4WD
3.2 FSi 265hp 195kw

2256054

Art. AR bras inf. AV Côté berceau

OE 8K0407182B

Rear arm bush Front frame side

4 Ø int. 12 Ø ext. 50 long. tube int.55 ext.35



1.8 TFSi 120hp 160hp / 4WD
2.0 TFSi 180hp 211hp / 4WD
2.0 TDi 120hp 142hp / 4WD
2.7 TDi 190hp 140kw
3.0 TDi 240hp 176kw 4WD
3.0 TFSi 330hp 245kw 4WD
3.2 FSi 265hp 195kw

2256053

Articulation bras inf. AR

OE 8K0407183A

Lower arm bush Rear

4 Ø int. 12 Ø ext. 65 long. tube int.80 ext.66



1.8 TFSi 120hp 160hp / 4WD
2.0 TFSi 180hp 211hp / 4WD
2.0 TDi 120hp 142hp / 4WD
2.7 TDi 190hp 140kw
3.0 TDi 240hp 176kw 4WD
3.0 TFSi 330hp 245kw 4WD
3.2 FSi 265hp 195kw

Bras & Triangle de suspension

Control arm

Brazo y triángulo

Wahacz

Рычаг подвески

G/L D/R



7476137

Bras de susp. AR sup. G

OE 8K0407509A

Left rear upper track control arm

NEW

4 Avec rotule With ball joint



1.8 TFSi /Avant 05/08-
1.8 TSi /Avant 10/11-
2.0 TFSi /Avant/4WD 07/08-
2.0 TFSi Allroad 03/09-
2.0 TDi FAP /Avant /4WD 04/08-
2.0 TDi FAP Allroad 03/09-
2.7 TDi FAP /Avant 01/08-
3.0 TDi FAP /Avant /4WD 10/11-
3.0 TDi FAP Allroad 03/09-
3.0 TFSi 4WD /Avant 10/11-
3.0 TFSi 4WD S4 /Avant 10/08-
3.0 TSi 4WD /Avant 10/11-
3.2 FSi /4WD /Avant 01/08-

7476188

Bras de susp. AR sup. D

OE 8K0407510A

Right rear upper track control arm

NEW

3 Avec rotule With ball joint



1.8 TFSi /Avant 05/08-
1.8 TSi /Avant 10/11-
2.0 TFSi /Avant/4WD 07/08-
2.0 TFSi Allroad 03/09-
2.0 TDi FAP /Avant /4WD 04/08-
2.0 TDi FAP Allroad 03/09-
2.7 TDi FAP /Avant 01/08-
3.0 TDi FAP /Avant /4WD 10/11-
3.0 TDi FAP Allroad 03/09-
3.0 TFSi 4WD /Avant 10/11-
3.0 TFSi 4WD S4 /Avant 10/08-
3.0 TSi 4WD /Avant 10/11-
3.2 FSi /4WD /Avant 01/08-

7476135

Bras de susp. AV sup. G

OE 8K0407505A

Left front upper track control arm

NEW

4 Avec rotule With ball joint



1.8 TFSi /Avant /4WD 01/08-10/11
1.8 TSi /Avant 10/11-
2.0 TFSi /Avant /4WD 07/08-
2.0 TFSi Allroad 03/09-
2.0 TDi FAP/Avant/4WD 04/08-
2.0 TDi FAP Allroad 03/09-
2.7 TDi FAP /Avant 01/08-10/11
3.0 TDi FAP/Avant/4WD 01/08-
3.0 TDi FAP Allroad 03/09-
3.0 TFSi 4WD /S4 /Avant 10/08-
3.0 TSi 4WD /Avant 10/11-
3.2 FSi /4WD /Avant 01/08-10/11

7476189

Bras de susp. AV sup. D

OE 8K0407506A

Right front upper track control arm

NEW

3 Avec rotule With ball joint



1.8 TFSi /Avant /4WD 01/08-10/11
1.8 TSi /Avant 10/11-
2.0 TFSi /Avant /4WD 07/08-
2.0 TFSi Allroad 03/09-
2.0 TDi FAP/Avant/4WD 04/08-
2.0 TDi FAP Allroad 03/09-
2.7 TDi FAP /Avant 01/08-10/11
3.0 TDi FAP/Avant/4WD 01/08-
3.0 TDi FAP Allroad 03/09-
3.0 TFSi 4WD /S4 /Avant 10/08-
3.0 TSi 4WD /Avant 10/11-
3.2 FSi /4WD /Avant 01/08-10/11

... A4 III 2008- ...

SASIC





AUDI

Bras & Triangle de suspension

Control arm
Brazo y triángulo
Wahacz
Рычаг подвески

G/L  D/R



7476227 OE 8K0407693N	Bras de susp. AR inf. G <i>Left rear lower track control arm</i>	7476225 OE 8K0407694N	Bras de susp. AR inf. D <i>Right rear lower track control arm</i>
<p>NEW</p> 	<p>4 Avec rotule With ball joint</p> <p>Articulation Ø 65 Ch- 8KZ8-000001</p> <p>1.8 TFSi /4WD /Avant -10/11 2.0 TFSi /4WD /Avant -10/11 2.0 TFSi Allroad -02/11/09 2.0 TDi /4WD /Avant -10/11 2.0 TDi Allroad -02/11/09 2.7 TDi /Avant -10/11 3.0 TDi 4WD /Avant -10/11 3.0 TDi Allroad -02/11/09 3.0 TFSi 4WD /Avant -10/11 3.2 FSi /4WD /Avant -10/11</p>	<p>NEW</p> 	<p>3 Avec rotule With ball joint</p> <p>Articulation Ø 65 Ch- 8KZ8-000001</p> <p>1.8 TFSi /4WD /Avant -10/11 2.0 TFSi /4WD /Avant -10/11 2.0 TFSi Allroad -02/11/09 2.0 TDi /4WD /Avant -10/11 2.0 TDi Allroad -02/11/09 2.7 TDi /Avant -10/11 3.0 TDi 4WD /Avant -10/11 3.0 TDi Allroad -02/11/09 3.0 TFSi 4WD /Avant -10/11 3.2 FSi /4WD /Avant -10/11</p>
7476124 OE 8K0407151D	Bras de susp. AV inf. AVG <i>Front L front lower track control arm</i>	7476125 OE 8K0407152D	Bras de susp. AV inf. AVD <i>Front R front lower track control arm</i>
<p>NEW</p> 	<p>4 Sans rotule Without ball joint</p> <p>1.8 TFSi /Avant /4WD 01/08-10/11 2.0 TFSi /Avant /4WD 10/08-10/11 2.0 TFSi Allroad Avant 03/09-</p> <p>2.0 TDi FAP/Avant/4WD 01/08-10/11 2.0 TDi FAP Allroad 03/09-</p> <p>2.7 TDi FAP /Avant 01/08-10/11 3.0 TDi FAP 4WD/Avant 01/08-10/11 3.0 TDi FAP Allroad 03/09-</p> <p>3.0 TFSi 4WD S4/Avant 10/08-10/11 3.2 FSi /4WD /Avant 01/08-10/11</p>	<p>NEW</p> 	<p>3 Sans rotule Without ball joint</p> <p>1.8 TFSi /Avant /4WD 01/08-10/11 2.0 TFSi /Avant /4WD 10/08-10/11 2.0 TFSi Allroad Avant 03/09-</p> <p>2.0 TDi FAP/Avant/4WD 01/08-10/11 2.0 TDi FAP Allroad 03/09-</p> <p>2.7 TDi FAP /Avant 01/08-10/11 3.0 TDi FAP 4WD/Avant 01/08-10/11 3.0 TDi FAP Allroad 03/09-</p> <p>3.0 TFSi 4WD S4/Avant 10/08-10/11 3.2 FSi /4WD /Avant 01/08-10/11</p>
7576018 OE 8K0407689G	Rotule de susp. inf. <i>Inferior suspension ball joint</i>		
	<p>1/2</p> <p>1.8 TFSi /Avant 01/08-15/08/11 2.0 TFSi /4WD /Avant 07/08-15/08/11 2.0 TDi /Avant /4WD 01/08-15/08/11 2.7 TDi /Avant 07/08-15/08/11 3.0 TDi 4WD /Avant 11/07-15/08/11 3.0 TFSi 4WD /Avant 10/08-15/08/11 3.2 FSi /4WD /Avant 11/07-15/08/11</p>		

... A4 III 2008-



Support d'amortisseur
 Suspension mounting
 Soporte amortiguador
 Poduszka amortyzatora
 Опора амортизатора

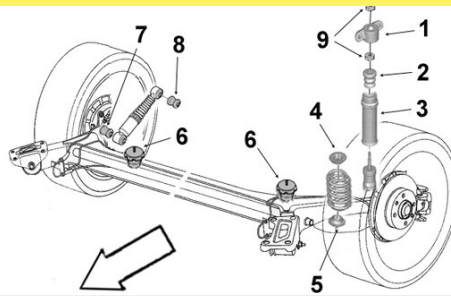

2656042

Support suspension

OE 8K0513353E

Suspension mounting



1	1.8 TFSi /Avant /4WD	01/08-
	1.8 TSI /Avant	10/11-
	2.0 TFSi /Avant /4WD	07/08-
	2.0 TDiFA /Avant/4WD	01/08-
	2.7 TDi FAP /Avant	01/08-10/11
	3.0 TDi FAP/Avant/4WD	11/07-
	3.0 TFSi 4WD	10/08-
	3.0 TSi 4WD	10/11-
	3.2 FSi /Avant/4WD	11/07-10/11

2656050

Butée de suspension

OE 8K0512131

Shock bush



2	H 145	
	1.8 TFSi /Avant	05/08-
	1.8 TSI /Avant	10/11-
	2.0 TFSi/EIH/Avant/4WD	07/08-
	2.0 TSi 4WD	10/11-
	2.0 TDi /Avant /4WD	04/08-
	2.7 TDi /Avant	01/08-10/11
	3.0 TDi /Avant /4WD	05/08-
	3.0 TFSi /Avant /4WD	10/11-
	3.0 TSi /Avant /4WD	10/11-
	3.2 FSi /Avant /4WD	11/07-10/11

Eléments TRAIN ARRIERE

Rear axle parts

Tren TRAS

Elementy zawieszenia tylnego

элементы задней оси.



2606007

Art. AV traverse AR

OE 8K0505145B

Cross bar front bush rear



1.8 TFSi
 2.0 TFSi
 2.0 TDi
 2.7 TDi
 3.0 TDi
 3.0 TFSi
 3.2 FSi

2606008

Art. AR traverse AR

OE 8K0505145C

Cross bar rear bush rear



1.8 TFSi
 2.0 TFSi
 2.0 TDi
 2.7 TDi
 3.0 TDi
 3.0 TFSi
 3.2 FSi

A5 ...

Eléments DIRECTION

Steering parts

Elementos Direcciones

Elementy układ kierowniczy

Элементы рулевой системы

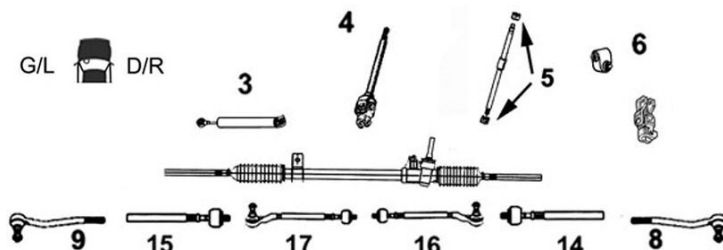

7776078

Axe de bielle G/D

OE 4H0422810A

L/R axial joint

NEW



14 Côté dir. M16x1.5 Côté rot. M16x1.5 long 226 mm

15	1.8 TFSi	02/08-07/11
	1.8 TSI	01/12-
	2.0 TFSi	02/08-
	2.0 TSi /TFSi	01/12-
	2.0 TDi	02/08-
	2.7 TDi	02/08-07/11
	3.0i Turbo	04/09-07/11
	3.0 TDi	02/08-
	3.0 TSi	01/12-
	3.2 FSi	02/08-07/11
	4.2i 4WD	02/08-

... A5 ...

Eléments DIRECTION
 Steering parts
 Elementos Direcciones
 Elementy uklad kierowniczy
 Элементы рулевой системы

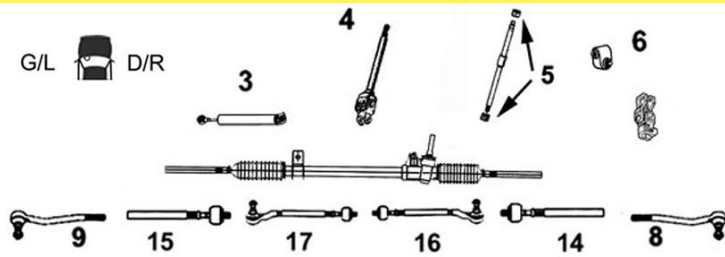

AUDI BASIC

7676052 **Rotule de direction G**
 OE 8K0422817B *Left tie rod end*

NEW



9	M16 x 1.5	
	1.8 TFSi	10/07-12/11
	2.0 TFSi	09/08-12/11
	2.0 TDi	12/07-12/11
	2.7 TDi	10/07-12/11
	3.0i Turbo S5	04/09-12/11
	3.0 TDi	07/07-12/11
	3.2 FSi	10/07-12/11
	4.2i /S5	07/07-07/11

7676053 **Rotule de direction D**
 OE 8K0422818B *Right tie rod end*

NEW



8	M16 x 1.5	
	1.8 TFSi	10/07-12/11
	2.0 TFSi	09/08-12/11
	2.0 TDi	12/07-12/11
	2.7 TDi	10/07-12/11
	3.0i Turbo S5	04/09-12/11
	3.0 TDi	07/07-12/11
	3.2 FSi	10/07-12/11
	4.2i /S5	07/07-07/11



Barre stabilisatrice
 Stabilizer bar
 Barra estabilizadora
 Drążek stabilizatora
 стабилизатор поперечной устойчивости

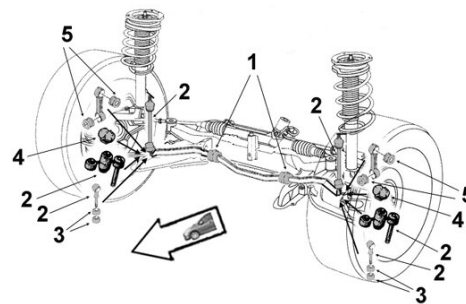

2306118 **Palier de barre milieu**
 OE 8K0411327A *Middle bar main bearing*



1	Ø 24	
	1.8 TFSi /TSi	09/07-
	2.0 TFSi / TSi	09/07-
	2.0 TDi	09/07-
	2.7 TDi	09/07-
	3.0i Turbo S5	09/07-
	3.0 TDi	09/07-
	3.0 TSi	09/07-
	3.2 FSi	09/07-
	4.2i /S5	09/07-

9001547 **Palier de barre milieu**
 OE 4D0411327G *Middle bar main bearing*

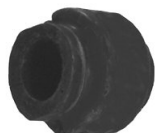

1	Barre Ø26.8	
	2.0 TFSi	07/07-
	2.0 TDi	07/07-
	2.7 TDi	07/07-
	3.0 TDi	07/07-
	3.2 FSi	07/07-

2306107 **Palier de barre milieu**
 OE 8K0411327B *Middle bar main bearing*



1	Ø 26		
	3.0 TDi	BVM6	07/07-03/09/07
	4.2i S5 Coupé	BVM6	07/07-03/09/07

... A5 ...



Eléments SUSPENSION
Suspension parts
Elementos suspensión
Elementy zawieszenie
Элементы подвески

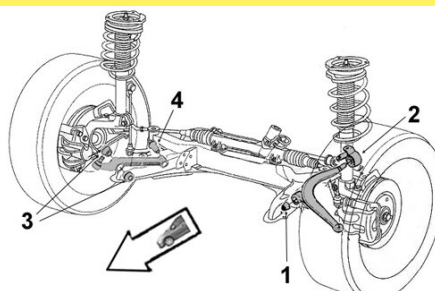

AUDI



2256052

Articulation bras sup. AV/AR

OE 8K0407515

Upper arm bush F/R



4 Ø int. 10 Ø ext. 46.5 long. tube int.40 ext.26

1.8 TFSi	07/07-
2.0 TFSi	07/07-
2.0 TDi	07/07-
2.7 TDi	07/07-
3.0 TDi	07/07-
3.2 FSi	07/07-
4.2	07/07-

2256054

Art. AR bras inf. AV Côté berceau

OE 8K0407182B

Rear arm bush Front frame side



4 Ø int. 12 Ø ext. 50 long. tube int.55 ext.35

1.8 TFSi	07/07-
2.0 TFSi	07/07-
2.0 TDi	07/07-
2.7 TDi	07/07-
3.0 TDi	07/07-
3.2 FSi	07/07-
4.2i	07/07-

2256053

Articulation bras inf. AR

OE 8K0407183A

Lower arm bush Rear



4 Ø int. 12 Ø ext. 65 long. tube int.80 ext.66

1.8 TFSi	07/07-
2.0 TFSi	07/07-
2.0 TDi	07/07-
2.7 TDi	07/07-
3.0 TDi	07/07-
3.2 FSi	07/07-
4.2i	07/07-

Bras & Triangle de suspension

Control arm
Brazo y triángulo
Wahacz
Рычаг подвески

G/L D/R

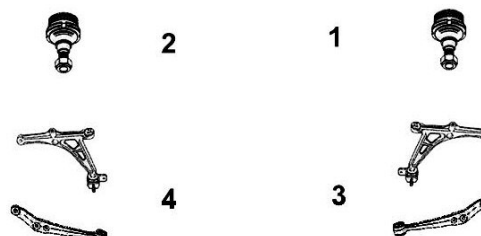

7476137

Bras de susp. AR sup. G

OE 8K0407509A

Left rear upper track control arm

NEW



4 Avec rotule With ball joint

1.8 TFSi	10/07-
1.8 TSi	08/11-
2.0 TDi	12/07-
2.0 TFSi	11/08-
2.0 TSi	08/11-
2.7 TDi	10/07-12/11
3.0i Turbo S5	04/09-12/11
3.0 TDi	07/07-
3.0 TSi	08/11-
3.2 FSi	10/07-12/11
4.2i	07/07-
4.2i S5	07/07-07/11

7476188

Bras de susp. AR sup. D

OE 8K0407510A

Right rear upper track control arm

NEW



3 Avec rotule With ball joint

1.8 TFSi	10/07-
1.8 TSi	08/11-
2.0 TDi	12/07-
2.0 TFSi	11/08-
2.0 TSi	08/11-
2.7 TDi	10/07-12/11
3.0i Turbo S5	04/09-12/11
3.0 TDi	07/07-
3.0 TSi	08/11-
3.2 FSi	10/07-12/11
4.2i	07/07-
4.2i S5	07/07-07/11

7476135

Bras de susp. AV sup. G

OE 8K0407505A

Left front upper track control arm

NEW



4 Avec rotule With ball joint

1.8 TFSi	10/07-12/11
1.8 TSi	08/11-
2.0 TDi	12/07-
2.0 TFSi	09/08-
2.0 TSi	07/11-
2.7 TDi	10/07-12/11
3.0i Turbo S5	04/09-12/11
3.0 TDi	07/07-
3.0 TSi	08/11-
3.2 FSi	10/07-12/11
4.2i	06/10-
4.2i S5	07/07-07/11

7476189

Bras de susp. AV sup. D

OE 8K0407506A

Right front upper track control arm

NEW



3 Avec rotule With ball joint

1.8 TFSi	10/07-12/11
1.8 TSi	08/11-
2.0 TDi	12/07-
2.0 TFSi	09/08-
2.0 TSi	07/11-
2.7 TDi	10/07-12/11
3.0i Turbo S5	04/09-12/11
3.0 TDi	07/07-
3.0 TSi	08/11-
3.2 FSi	10/07-12/11
4.2i	06/10-
4.2i S5	07/07-07/11

... A5 ...

SASIC

AUDI

Bras & Triangle de suspension

Control arm
Brazo y triángulo
Wahacz
Рычаг подвески

G/L  D/R



7476227

Bras de susp. AR inf. G

OE 8K0407693N

Left rear lower track control arm

NEW



4	Avec rotule With ball joint	
	Articulation Ø 65	
	1.8 TFSi	-02/11/09
	2.0 TFSi	-02/11/09
	2.0 TDi	-02/11/09
	2.7 TDi	-02/11/09
	3.0i Turbo	-02/11/09
	3.0 TDi	-02/11/09
	3.2 FSi	-02/11/09
	4.2i	-02/11/09

7476225

Bras de susp. AR inf. D

OE 8K0407694N

Right rear lower track control arm

NEW



3	Avec rotule With ball joint	
	Articulation Ø 65	
	1.8 TFSi	-02/11/09
	2.0 TFSi	-02/11/09
	2.0 TDi	-02/11/09
	2.7 TDi	-02/11/09
	3.0i Turbo	-02/11/09
	3.0 TDi	-02/11/09
	3.2 FSi	-02/11/09
	4.2i	-02/11/09

7476124

Bras de susp. AV inf. AVG

OE 8K0407151D

Front L front lower track control arm

NEW



4	Sans rotule Without ball joint	
	1.8 TFSi	10/07-15/08/11
	2.0 TDi	12/07-15/08/11
	2.0 TFSi	09/08-15/08/11
	2.7 TDi	10/07-15/08/11
	3.0i Turbo S5	04/09-15/08/11
	3.0 TDi	07/07-15/08/11
	3.2 FSi	10/07-15/08/11
	4.2i	06/10-07/11
	4.2i S5	07/07-07/11

7476125

Bras de susp. AV inf. AVD

OE 8K0407152D

Front R front lower track control arm

NEW



3	Sans rotule Without ball joint	
	1.8 TFSi	10/07-15/08/11
	2.0 TDi	12/07-15/08/11
	2.0 TFSi	09/08-15/08/11
	2.7 TDi	10/07-15/08/11
	3.0i Turbo S5	04/09-15/08/11
	3.0 TDi	07/07-15/08/11
	3.2 FSi	10/07-15/08/11
	4.2i	06/10-07/11
	4.2i S5	07/07-07/11

7576018

Rotule de susp. inf.

OE 8K0407689G

Inferior suspension ball joint

NEW



1	1.8 TFSi	10/07-15/08/11
2	2.0 TFSi	09/08-15/08/11
	2.0 TDi	12/07-15/08/11
	2.7 TDi	10/07-15/08/11
	3.0i Turbo S5	04/09-15/08/11
	3.0 TDi	07/07-15/08/11
	3.2 FSi	10/07-15/08/11
	4.2i S5	07/07-07/11



Support d'amortisseur

Suspension mounting
Soporte amortiguador
Poduszka amortyzatora
Опора амортизатора

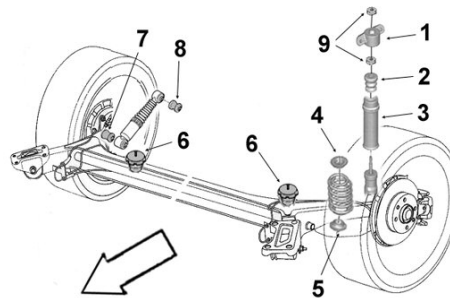

2656042

Support suspension

OE 8K0513353E

Suspension mounting



1	1.8 TFSi			10/07-12/11
	1.8 TFSi Coupé	CDHB	BVM6 /Seq.	04/09-07/11
	1.8 TSi			08/11-
	2.0 TFSi			09/08-
	2.0 TDi			12/07-
	2.7 TDi			10/07-12/11
	3.0i Turbo S5			04/09-12/11
	3.0 TDi			07/07-
	3.0 TSi			08/11-
	3.2 FSi			10/07-12/11

... A5

Eléments TRAIN ARRIERE

Rear axle parts

Tren TRAS

Elementy zawieszenia tylnego

элементы задней оси.



2606007

Art. AV traverse AR

OE 8K0505145B

Cross bar front bush rear



1.8 TFSi	07/07-
2.0 TFSi	07/07-
2.0 TDi	07/07-
2.7 TDi	07/07-
3.0 TDi	01/09-
3.0 TSi	01/09-
3.2 FSi	07/07-
4.2i	07/07-

2606008

Art. AR traverse AR

OE 8K0505145C

Cross bar rear bush rear



1.8 TFSi	07/07-
2.0 TFSi	07/07-
2.0 TDi	07/07-
2.7 TDi	07/07-
3.0 TDi	01/09-
3.0 TSi	01/09-
3.2 FSi	07/07-
4.2i	07/07-

A6 I 94-97 ...

Eléments DIRECTION

Steering parts

Elementos Direcciones

Elementy uklad kierowniczy

Элементы рулевой системы

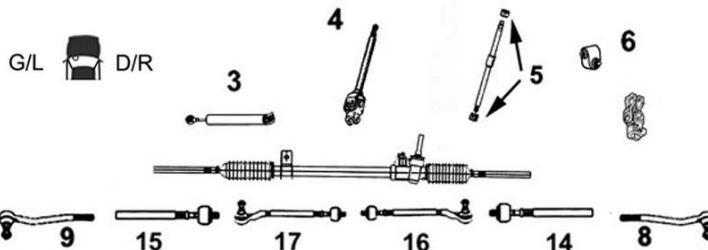

9006302

Rotule de direction G

OE 443419811D

Left tie rod end



9 M16 x 1.5	
1.8i 20v.	06/94-07/97
1.9 TDi	06/94-07/97
2.0	06/94-07/97
2.5 TDi	06/94-07/97
2.6	06/94-07/97
2.8	06/94-07/97
4.2 /S6 4WD	07/94-01/98

9006301

Rotule de direction D

OE 443419812D

Right tie rod end



8 M16 x 1.5	
1.8i 20v.	06/94-07/97
1.9 TDi	06/94-07/97
2.0	06/94-07/97
2.5 TDi	06/94-07/97
2.6	06/94-07/97
2.8	06/94-07/97
4.2 /S6 4WD	07/94-01/98



Barre stabilisatrice

Stabilizer bar

Barra estabilizadora

Drażek stabilizatora

стабилизатор поперечной устойчивости

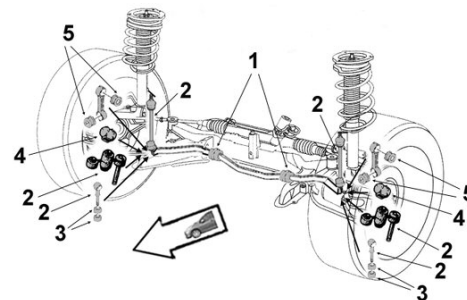

9001798

Palier de barre milieu

OE 4A0411327F

Middle bar main bearing



1 Ø 23	
1.8i 20v.	01/95-
2.0i	01/95-

9001742

Palier de barre milieu

OE 4A0411327A

Middle bar main bearing



1 Ø 24		
1.9 TDi	BV6	01/95-
2.5 TDi		01/95-
2.6i		01/95-
2.8i		01/95-

... A6 I 94-97 ...



Eléments SUSPENSION

Suspension parts

Elementos suspensión

Elementy zawieszenie

Элементы подвески

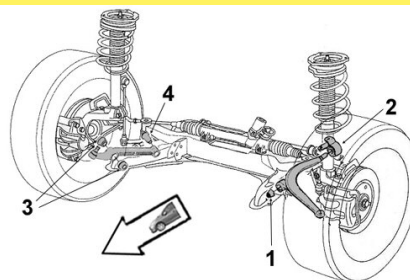

SASIC

AUDI

9001544

Articulation ext. bras inf.

OE 4A0407181A

Lower arm outer bush



3 Ø int.16.5 Ø ext.45 coll.63
long. tube int.23 ext.14 ep. coll.6.5

1.8i 20v.		01/95-
1.9 TDi		01/95-
2.0i		01/95-
2.5 TDi	BV6	01/95-
2.6i		01/95-
2.8i		01/95-

9001545

Art. int. bras inf.

OE 4A0407183D

Lower arm inner bush



4 Ø int.14.5 Ø ext.54.5
long. tube int.48 ext.31

1.8i 20v.		01/95-
1.9 TDi		01/95-
2.0i		01/95-
2.5 TDi	BV6	01/95-
2.6i		01/95-
2.8i		01/95-

Bras & Triangle de suspension

Control arm

Brazo y triángulo

Wahacz

Рычаг подвески

G/L D/R



9005161

Bras de suspension G

OE 4A0407151

Left track control arm



4 Avec rotule With ball joint

1.8i 20v.		06/94-07/97
1.9 TDi		06/94-07/97
2.0		06/94-07/97
2.5 TDi		06/94-07/97
2.6		06/94-07/97
2.8		06/94-07/97
4.2 S6 4WD		07/94-01/98

9005160

Bras de suspension D

OE 4A0407152

Right track control arm



3 Avec rotule With ball joint

1.8i 20v.		06/94-07/97
1.9 TDi		06/94-07/97
2.0		06/94-07/97
2.5 TDi		06/94-07/97
2.6		06/94-07/97
2.8		06/94-07/97
4.2 S6 4WD		07/94-01/98



Support d'amortisseur

Suspension mounting

Soporte amortiguador

Poduszka amortyzatora

Опора амортизатора

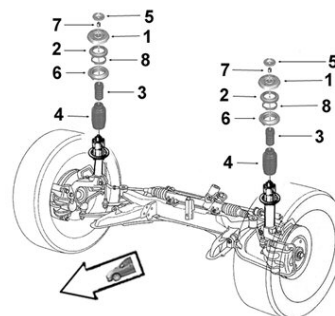

8005208

Butée à billes

OE 4A0412249

Ball bearing



2

1.8i 20v.		01/95-
1.9 TDi		01/95-
2.0		01/95-
2.5 TDi		01/95-
2.6		01/95-
2.8		01/95-

... A6 I 94-97



Eléments SUSPENSION
Suspension parts
Elementos suspensión
Elementy zawieszenie
Элементы подвески

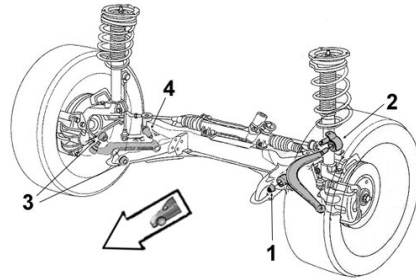

AUDI



9001546 OE 431505172	Articulation <i>Bush</i>	9003102 OE 4A0511247	Articulation essieu G/D <i>L/R axle bush</i>
	Ø int.12 Ø ext.34 coll.34 long. tube int.40 ext.20 ep. coll.2 1.8i 20v./ turbo 06/94- 1.9 TDi 06/94- 2.0 E /16v. /i 16v. 06/94- 2.3 E/i 06/94- 2.5 TDi V6 06/94- 2.6 E V6 06/94- 2.8 E V6 /i V6 30v. 06/94-		Ø int.14 Ø ext.62 long. tube int.57 ext.47 1.8i 20v. 01/95- 1.9 TDi 01/95- 2.0i 01/95- 2.5 TDi 01/95- 2.6i 01/95- 2.8i 01/95-

A6 II 97-04/2004 ...

Eléments DIRECTION
Steering parts
Elementos Direcciones
Elementy układ kierowniczy
Элементы рулевой системы

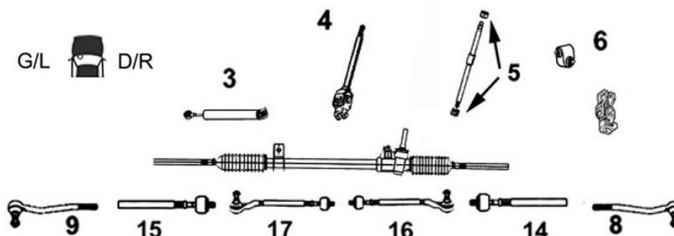

9006247 OE 4B0422821	Axe de bielle G/D <i>L/R axial joint</i>	7776081 OE 4D0422821A	Axe de bielle G/D <i>L/R axial joint</i>
	14 Côté dir. M16x1.5 Côté rot. M14x1.5 15 long 128 mm 1.8i 20v. Turbo /Avant /4WD -07/01 1.9 TDi /Avant -07/01 2.4i V6 /Avant /4WD -07/01 2.5 TDi /Avant /4WD -07/01 2.7i V6 Bi Turbo /Avant /4WD -07/01 2.8i V6 30v. /Avant /4WD -07/01 3.7i V8 /Avant /4WD -07/01 4.2i Turbo RS6 4WD /Avant -11/02 4.2i V8 40v. /Avant /4WD -07/01		14 Côté dir. M16x1.5 Côté rot. M14x1.5 15 long 128 mm TT /all models /Avant /4WD -ch 4BZ5050000 07/01-05/04 TT /all models Allroad -12/05

9006413 OE 4B0419811F	Rotule de direction G/D <i>L/R tie rod end</i>		
	8 M14 x 1.5 9 1.8i 20v. Turbo AEB BVM /Tiptronic 01/98-04/04 1.8i 20v. Turbo 4WD AEB 01/98-04/04 1.9 TDi AFN BVM BVA 01/98-04/04 2.4 V6 APS BV5 01/98-04/04 2.5 TDi 163hp 120kw Allroad 4WD BV6 2.5 TDi 180hp 132kw Allroad 4WD BV6/Tiptronic 2.7i Turbo Allroad 4WD BV6/Tiptronic 4.7 4WD Avant Tiptronic		

7676051 OE 4F0498811A	Rotule de direction G/D <i>L/R tie rod end</i>		
	8 M14 x 1.5 9		
	2.5 TDi Avant 4WD Ch- 4B-2-150001	AKE	BVM6 BVA5 07/00-07/01

... A6 II 97-04/2004 ...



Barre stabilisatrice
 Stabilizer bar
 Barra estabilizadora
 Drażek stabilizatora
 стабилизатор поперечной устойчивости

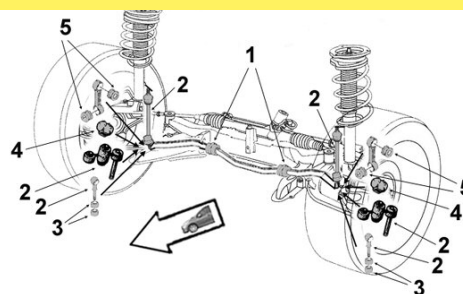

9005086 **Biellette barre stab. G**
 OE 8D0411317D *Left stabilizer bar stub axle*



2
 1.8i 20v. Turbo /4WD 01/98-
 1.9 TDi 01/98-
 2.4i 01/98-
 2.5 TDi /4WD 01/98-
 2.7i V6 Bi Turbo 01/98-
 2.8i V6 01/98-
 4.2i S6 40v. 4WD 05/99-

9005096 **Biellette barre stab. D**
 OE 8D0411318D *Right stabilizer bar stub axle*



2
 1.8i 20v. Turbo /4WD 08/98-
 1.9 TDi 08/98-
 2.4i 08/98-
 2.5 TDi /4WD 08/98-
 2.7i V6 Bi Turbo 08/98-
 2.8i V6 08/98-
 4.2i S6 4WD 05/99-

9001548 **Palier de barre milieu**
 OE 4D0411327H *Middle bar main bearing*



1 Barre Ø29
 1.8i 20v. Turbo /4WD 01/98-
 1.9 TDi 01/98-
 2.4 V6 01/98-
 2.5 TDi /4WD 01/98-
 2.7i V6 Bi Turbo 05/99-07/01
 2.8i V6 06/97-07/01
 4.2i S6 4WD 05/99-07/01



Eléments SUSPENSION
 Suspension parts
 Elementos suspensión
 Elementy zawieszenie
 Элементы подвески

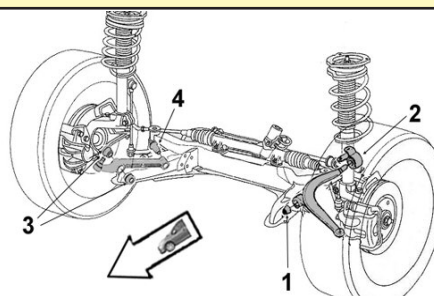

9001758 **Articulation bras sup. AV/AR**
 OE 4B0407515 *Upper arm bush F/R*



4 Ø int.10 Ø ext.46.5 long. tube int.40 ext.26
 1.8i 20v./ turbo
 1.9 TDi
 2.0i 20v.
 2.4 V6
 2.5 TDi
 2.7i V6 Bi Turbo
 2.8i V6
 3.0i V6
 3.7i V8
 4.2i S6 4WD

9001538 **Articulation AV bras inf. AV**
 OE 4D0407181H *Front lower arm front bush*



3 Ø int.12 Ø ext.40 long. tube int.50 ext.42
 1.8i 20v./ turbo
 1.9 TDi
 2.0i 20v.
 2.4 V6
 2.5 TDi
 2.7i V6 Bi Turbo
 2.8i V6
 3.0i V6
 3.7i V8
 4.2i S6 4WD

9001539 **Articulation AR bras inf. AV**
 OE 4D0407182G *Front lower rear arm bush*



4 Ø int.12 Ø ext.50 long. tube int.60 ext.31
 1.8i 20v./ turbo
 1.9 TDi
 2.0i 20v.
 2.4 V6
 2.5 TDi
 2.7i V6 Bi Turbo
 2.8i V6
 3.0i V6
 3.7i V8
 4.2i S6 4WD

9001540 **Articulation bras inf. AR**
 OE 4D0407183AC *Lower arm bush Rear*



4 Ø int.12 Ø ext.65 long. tube int.80 ext.65.5
 1.8i 20v./ turbo
 1.9 TDi
 2.0i 20v.
 2.4 V6
 2.5 TDi
 2.7i V6 Bi Turbo
 2.8i V6
 3.0i V6
 3.7i V8
 4.2i S6 4WD

... A6 II 97-04/2004

Bras & Triangle de suspension





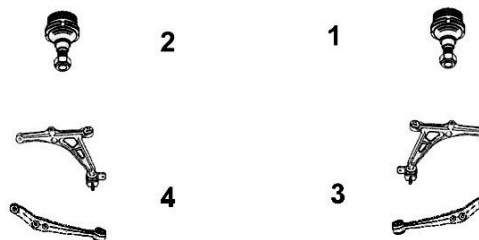

Control arm
Brazo y triángulo
Wahacz
Рычаг подвески

G/L  D/R



AUDI

SASIC

9005749 OE 4D0407509J	Bras de susp. AR sup. G <i>Left rear upper track control arm</i>	9005750 OE 4D0407510G	Bras de susp. AR sup. D <i>Right rear upper track control arm</i>
	4 Avec rotule With ball joint 1.8i 20v. Turbo /4WD 01/98-04/04 1.9 TDi BVA 01/98-04/04 2.0i 20v. 07/01-04/05 2.4 V6 /4WD 01/98-04/05 2.5 TDi /4WD 02/98-12/05 2.7i V6 4WD 05/99-12/05 2.8i V6 /4WD 06/97-07/01 3.0i V6 30v. /4WD 07/01-04/05 4.2 4WD 05/99-12/05		3 Avec rotule With ball joint 1.8i 20v. Turbo /4WD 01/98-04/04 1.9 TDi BVA 01/98-04/04 2.0i 20v. 07/01-04/05 2.4 V6 /4WD 01/98-04/05 2.5 TDi /4WD 02/98-12/05 2.7i V6 4WD 05/99-12/05 2.8i V6 /4WD 06/97-07/01 3.0i V6 30v. /4WD 07/01-04/05 4.2 4WD 05/99-12/05
9005140 OE 8E0407505A	Bras de susp. AV sup. G <i>Left front upper track control arm</i>		
	4 Avec rotule With ball joint 1.8i 20v. Turbo/4WD AEB APU AWT 01/98-04/04 1.9 TDi AFN/JM/VF/VG/WX 01/98-04/04 2.0i 20v. ALT 07/01-04/05 2.4 V6 /4WD Ch- 4B1090001 A/GA/PS/ML BDV 01/98-04/04 2.5 TDi 01/98-12/05 2.7i V6 05/99-12/05 2.8i V6 06/97-07/01 3.0i 07/01-04/05 4.2i 05/99-12/05		
9005141 OE 8E0407506A	Bras de susp. AV sup. D <i>Right front upper track control arm</i>		
	3 Avec rotule With ball joint 1.8i 20v. Turbo/4WD AEB APU AWT 01/98-04/04 1.9 TDi AFN/JM/VF/VG/WX 01/98-04/04 2.0i 20v. ALT 07/01-04/05 2.4 V6 /4WD Ch- 4B1090001 A/GA/PS/ML BDV 01/98-04/04 2.5 TDi 01/98-12/05 2.7i V6 05/99-12/05 2.8i V6 06/97-07/01 3.0i 07/01-04/05 4.2i 05/99-12/05		
9005156 OE 8E0407693AG	Bras de susp. AR inf. G <i>Left rear lower track control arm</i>		
	4 Avec rotule With ball joint 1.8i 20v. Turbo /4WD AEB APU AWT 01/98-04/04 1.9 TDi AFN/JM/VF/VG/WX 01/98-04/04 2.0i 20v. ALT 07/01-04/05 2.4 V6 /4WD AGA/ML/PS BDV 01/98-04/04 2.5 TDi /4WD AFB/KE/KN/YM 01/98- 2.5 TDi /4WD BDG/FC/AU/DH/CZ 07/01- 2.7i V6 4WD AZA AJK ARE BES 05/99-04/05 2.8i V6 /4WD AMX/LG/PR/QD/CK 06/97- 3.0i /4WD ASN 07/01-04/05 4.2i /4WD ANK ARS AQJ 07/00-07/01		
9005154 OE 8E0407694AG	Bras de susp. AR inf. D <i>Right rear lower track control arm</i>		
	3 Avec rotule With ball joint 1.8i 20v. Turbo /4WD AEB APU AWT 01/98-04/04 1.9 TDi AFN/JM/VF/VG/WX 01/98-04/04 2.0i 20v. ALT 07/01-04/05 2.4 V6 /4WD AGA/ML/PS BDV 01/98-04/04 2.5 TDi /4WD AFB/KE/KN/YM 01/98- 2.5 TDi /4WD BDG/FC/AU/DH/CZ 07/01- 2.7i V6 4WD AZA AJK ARE BES 05/99-04/05 2.8i V6 /4WD AMX/LG/PR/QD/CK 06/97- 3.0i /4WD ASN 07/01-04/05 4.2i /4WD ANK ARS AQJ 07/00-07/01		

... A6 II 97-04/2004 ...

SASIC

AUDI

Bras & Triangle de suspension

Control arm
Brazo y triángulo
Wahacz
Рычаг подвески

G/L  D/R

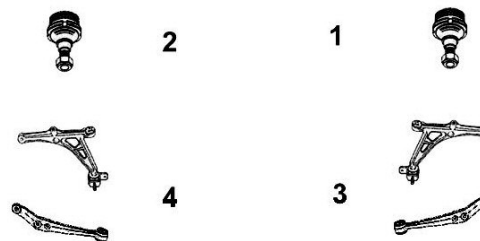

9005157

Bras de susp. AV inf. G/D

OE 4D0407151P

L/R front lower track control arm



3 Avec rotule With ball joint

4 1.8i 20v. Turbo /4WD

1.9 TDi

2.4 V6 /4WD -ch 4BW100000

2.4 V6

2.5 TDi /4WD

2.5 TDi /4WD

2.7i V6

2.8i V6

3.0i V6

AEB APU AWT

AFN AJM AVG

AGA/ML/PS

BDV

AFB/KE/YM/KM/KN

BAU/DG/FC/DH/CZ

AZA AJK ARE BES

AMX/LG/PR/QD/CK

ASN 07/01

01/98-04/04

01/98-04/04

01/98-04/04

07/01-04/05

02/98-

08/02-

05/99-04/05

06/97-07/01

-04/05

7476033

Bras de susp. AV inf. G/D

OE 4B3407151K

L/R front lower track control arm

Avec rotule With ball joint



3 1.8i 20v. Turbo /4WD /Avant

4 1.9 TDi /Avant

2.0i 20v. /Avant

2.4i V6 30v. /4WD /Avant

2.4i V6 30v. /4WD /Avant

2.5 TDi /4WD /Avant

2.5 TDi /4WD /Avant

2.7i V6 Turbo 4WD

2.7i V6 Turbo 4WD

3.0i V6 30v. /4WD /Avant

3.0i V6 30v. /4WD /Avant

4.2i S6 4WD /Avant

Jante 17 / 18 pouces

Jante 17 / 18 pouces

Jante 17 / 18 pouces

Jante 17 / 18 pouces

Ch- 4B-2-031501

Ch- 4B-2-031501

Ch- 4B-2-031501

Ch-4B-2-000001 -ch4B-2-031501

Ch- 4B-2-031501

Ch-4B-2-000001 -ch4B-2-031501

Ch- 4B-2-031501

Ch-4B-2-000001 -ch4B-2-031501

Ch- 4B-2-031501

Ch-4B-2-000001 -ch4B-2-031501

Ch- 4B-2-031501

Ch-4B-W-100001



Support d'amortisseur

Suspension mounting
Soporte amortiguador
Poduszka amortyzatora
Опора амортизатора

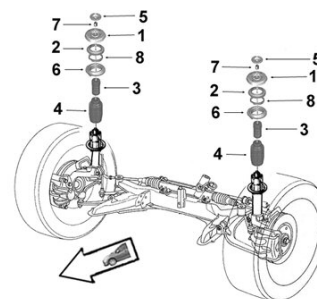

9001710

Support suspension G/D

OE 4D0412377F

L/R suspension mounting



1

1.8i 20v. Turbo /4WD

1.9 TDi

2.4i V6

2.5 TDi /4WD

2.7i V6 Bi Turbo

2.8i V6

4.2i S6 4WD

AEB APU AWT

AFN AVG AJM

AGA AML APS

AFB AKN AKE

AJK AZA

ACK ALG AMX APR AQD

ARS AQJ ANK

06/97-07/01

06/97-07/01

06/97-07/01

02/98-07/01

05/99-07/01

06/97-07/01

05/99-07/01

9005326

Butée de suspension G/D

OE 8D0412131F

L/R suspension bush



3

H85

1.8i 20v. Turbo /4WD 01/98-

1.9 TDi 01/98-

2.0i 20v. 01/98-

2.4i V6 30v. 01/98-

2.5 TDi /4WD 01/98-

2.7i V6 30v. 05/99-

2.8i V6 30v. 01/98-

4.2i S6 4WD 05/99-

2656009

Butée de suspension

OE 8D0412131E

Shock bush



3

H77 susp. sport

1.8i 20v. Turbo /4WD 06/97-07/01

1.9 TDi 06/97-07/01

2.4i /4WD 06/97-07/01

2.5 TDi /4WD 02/98-07/01

2.7i V6 Bi Turbo 4WD 05/99-07/01

2.8i V6 30v. /4WD 06/97-07/01

4.2i S6 4WD 05/99-07/01

... A6 II 97-04/2004



Barre stabilatrice
 Stabilizer bar
 Barra estabilizadora
 Drażek stabilizatora
 стабилизатор поперечной устойчивости

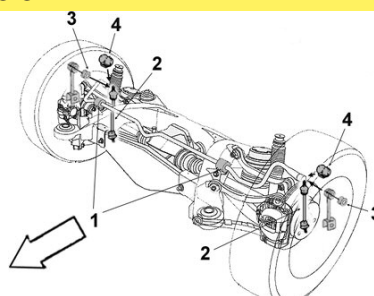

AUDI



2306105

Palier de barre

OE 4B0511327

Bar main bearing

1 Ø16 Châssis sport



1.8 Turbo 4WD	06/97-07/01
2.4i V6 4WD	06/97-07/01
2.5 TDi 4WD	06/97-07/01
2.7i V6 4WD	05/99-07/01
2.8i V6 4WD	06/97-07/01
4.2i v8 4WD	05/99-07/01

06/97-07/01
06/97-07/01
06/97-07/01
05/99-07/01
06/97-07/01
05/99-07/01



Support d'amortisseur
 Suspension mounting
 Soporte amortiguador
 Poduszka amortyzatora
 Опора амортизатора

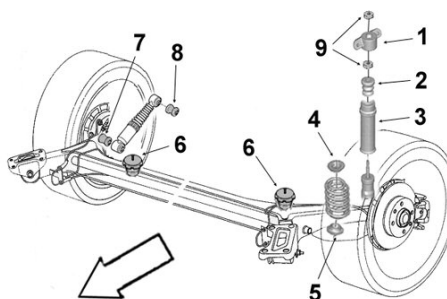

9005621

Support suspension G/D

OE 8E0513353B

L/R suspension mounting

1



1.8i 20v. Turbo sauf Quattro	01/98-
1.9 TDi	08/98-
2.4i V6	08/98-
2.5 TDi	04/98-
2.7i V6	05/99-
2.8i V6	01/98-

01/98-
08/98-
08/98-
04/98-
05/99-
01/98-

Eléments TRAIN ARRIERE

Rear axle parts
 Tren TRAS
 Elementy zawieszenia tylnego
 элементы задней оси.



9001773

Support essieu AR G

OE 4B0501521E

Left rear axle mounting



1.8i 20v. Turbo	06/97-07/01
1.9 TDi	06/97-07/01
2.4i V6	06/97-07/01
2.5 TDi	02/98-07/01
2.8i V6	06/97-07/01

9001774

Support essieu AR D

OE 4B0501522E

Right rear axle mounting



1.8i 20v. Turbo	06/97-07/01
1.9 TDi	06/97-07/01
2.4i V6	06/97-07/01
2.5 TDi	02/98-07/01
2.8i V6	06/97-07/01

A6 III 05/04- 03/11 ...

SASIC

AUDI

Eléments DIRECTION

Steering parts

Elementos Direcciones

Elementy uklad kierowniczy

Элементы рулевой системы

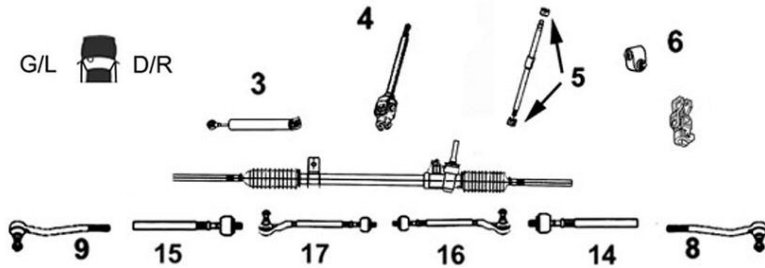

7776077

Axe de bielle G/D

OE 4F0422821D

L/R axial joint

NEW

14 Côté dir. M16x1.5 Côté rot. M14x1.5 long 140 mm
15



TT /all models

Ch- 4FZ5000001 -ch4FZB150000

04/05-12/10

7676051

Rotule de direction G/D

OE 4F0498811A

L/R tie rod end

NEW

8	M14 x 1.5			
9	2.0 TFSi /Avant	BPJ	BVM6 /Séq.	10/08-12/10
	2.0 TDi FAP /Avant			11/08-12/10
	2.7 TDi /Avant			03/06-12/10
	2.7 TDi Allroad	CANC	BVA6	10/08-
	2.8 FSi/ Avant /4WD			10/06-12/10
	3.0 TFSi/ Avant 4WD	CAJA	BVA6	10/08-12/10
	3.0 TFSi Allroad	CAJA	BVA6	10/08-
	3.0 TDi/ Avant			06/06-12/10
	3.0 TDi Allroad Avant			10/08-
	4.2 FSi /Avant 4WD	BVJ	BVA6	06/06-12/10
	4.2 FSi Allroad	BVJ	BVA6	10/08-
	5.0i Turbo RS6 4WD	BUH	BVA6	10/08-12/10
	5.2i/ Avant 4WD S6	BXA	BVA6	04/06-12/10



Barre stabilisatrice

Stabilizer bar

Barra estabilizadora

Drażek stabilizatora

стабилизатор поперечной устойчивости

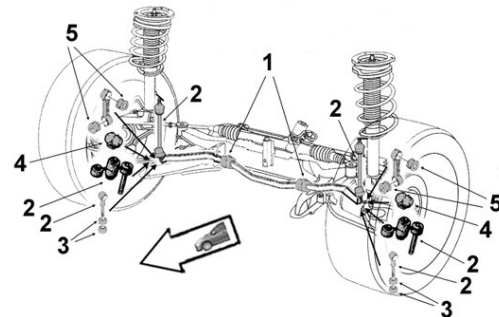

9001740

Palier de barre milieu

OE 4D0411327J

Middle bar main bearing

1	Ø29	
	2.0 TFSi /Avant	05/05-12/10
	2.0 TDi /Avant	05/04-12/10
	2.4i /4WD	05/04-10/08
	2.7 TDi /4WD /Avant	01/05-12/10
	2.7 TDi Allroad	10/08-
	2.8 FSi /4WD /Avant	10/08-12/10
	3.0 TFSi 4WD/ Avant	10/08-12/10
	3.0 TFSi Allroad	10/08-
	3.0 TDi 4WD /Avant	05/04-12/10
	3.0 TDi Allroad	10/08-
	3.2 FSi /4WD	05/04-10/08
	4.2i 4WD S6	05/04-06/06
	4.2 FSi 4WD /Avant 4WD	10/08-12/10
	4.2 FSi Allroad	10/08-
	5.0i Turbo RS6 4WD /Avant	10/08-12/10
	5.2i S6 4WD /Avant	10/08-12/10



... A6 III 05/04- 03/11 ...



Eléments SUSPENSION

Suspension parts

Elementos suspensión

Elementy zawieszenie

Элементы подвески

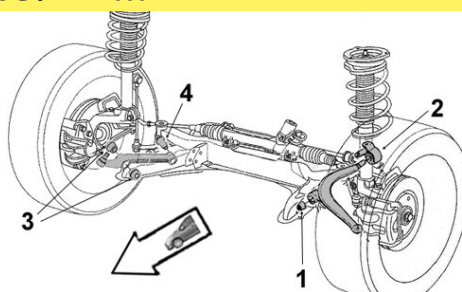

AUDI



2256005

Articulation bras inf. AR

OE 4F0407183A

Lower arm bush Rear



4 Ø int. 12 Ø ext. 65 long. tube int. 80 ext. 55.5
-ch 4F6055000

2.0 TFSi	05/04-
2.0 TDi /Break	05/04-
2.4 V6 /4WD /Avant	05/04-
2.7 TDi /Avant	05/04-
3.0 TDi 4WD /Avant	05/04-
3.2 FSi /4WD /Avant	05/04-
4.2 V8 /Avant S6	05/04-

Bras & Triangle de suspension

Control arm
Brazo y triángulo
Wahacz
Рычаг подвески

G/L D/R

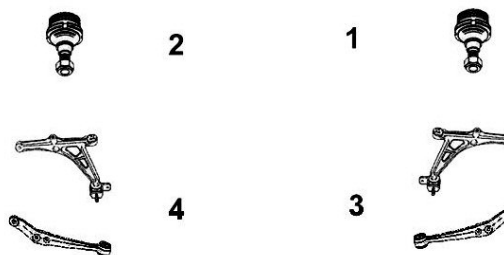

7476204

Bras de suspension Sup. AR G

OE 4E0407509H Rear Upper left track control arm

NEW

4 Avec rotule With ball joint Ø 18

Ch- 4FZ5000001 - 4FZB150000



2.0 TFSi /Avant	01/05-
2.0 TDi /Avant	01/05-
2.4i V6 24v. /Avant	01/05-
2.7 TDi /Avant	01/05-
2.7 TDi Allroad	01/07-
2.8 FSi /Avant	01/05-
3.0 TFSi /Avant	01/05-
3.0 TFSi Allroad	01/07-
3.0i V6 30v. /Avant	01/05-
3.0 TDi /Avant	01/05-
3.0 TDi Allroad	01/07-
3.2 FSi /Avant	01/05-
3.2 FSi Allroad	01/07-
4.2 FSi Allroad	01/07-
4.2 FSi /Avant	01/05-
4.2i /Avant	01/05-
4.2i Turbo RS6 /Avant	01/05-
5.0i Turbo RS6 /Avant	01/05-
5.2i /Avant	01/05-

7476205

Bras de suspension Sup. AR D

OE 4E0407510H Rear Upper right track control arm

NEW

3 Avec rotule With ball joint Ø 18

Ch- 4FZ5000001 - 4FZB150000



2.0 TFSi /Avant	01/05-
2.0 TDi /Avant	01/05-
2.4i V6 24v. /Avant	01/05-
2.7 TDi /Avant	01/05-
2.7 TDi Allroad	01/07-
2.8 FSi /Avant	01/05-
3.0 TFSi /Avant	01/05-
3.0 TFSi Allroad	01/07-
3.0i V6 30v. /Avant	01/05-
3.0 TDi /Avant	01/05-
3.0 TDi Allroad	01/07-
3.2 FSi /Avant	01/05-
3.2 FSi Allroad	01/07-
4.2 FSi Allroad	01/07-
4.2 FSi /Avant	01/05-
4.2i /Avant	01/05-
4.2i Turbo RS6 /Avant	01/05-
5.0i Turbo RS6 /Avant	01/05-
5.2i /Avant	01/05-

... A6 III 05/04- 03/11 ...

SASIC









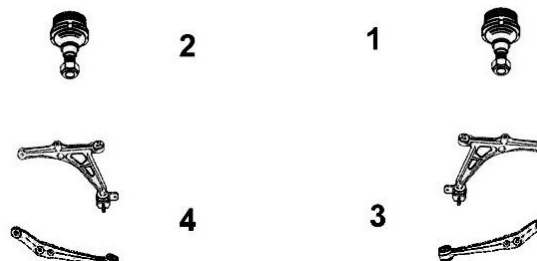

AUDI

Bras & Triangle de suspension

Control arm
Brazo y triángulo
Wahacz
Рычаг подвески

G/L  D/R



7476208 OE 4E0407505E	Bras de suspension Sup. AV G <i>Front upper left track control arm</i>	7476209 OE 4E0407506E	Bras de suspension Sup. AV D <i>Front upper right track control arm</i>
	4 Avec rotule With ball joint Ø 18		3 Avec rotule With ball joint Ø 18
	2.0 TFSi /Avant 05/05-12/10 2.0 TDi /Avant 05/04-12/10 2.4i V6 24v./4WD/Avant 05/04-10/08 2.7 TDi /4WD /Avant 01/05-12/10 2.7 TDi Allroad 06/06-01/12 2.8 FSi /4WD /Avant 10/06-12/10 3.0 TFSi 4WD /Avant 10/08-12/10 3.0 TFSi Allroad 10/08-01/12 3.0 TDi 4WD /Avant 05/04-12/10 3.0 TDi Allroad 06/06-01/12 3.2 FSi /4WD /Avant 05/04-10/08 3.2 FSi Allroad 06/06-10/08 4.2 FSi Allroad 06/06-01/12 4.2i /FSi 4WD /Avant 05/04-12/10 5.0i Turbo RS6 4WD/Avant 10/08-12/10 5.2i 4WD /Avant Ch- 4F-8-018001 -12/10		2.0 TFSi /Avant 05/05-12/10 2.0 TDi /Avant 05/04-12/10 2.4i V6 24v./4WD/Avant 05/04-10/08 2.7 TDi /4WD /Avant 01/05-12/10 2.7 TDi Allroad 06/06-01/12 2.8 FSi /4WD /Avant 10/06-12/10 3.0 TFSi 4WD /Avant 10/08-12/10 3.0 TFSi Allroad 10/08-01/12 3.0 TDi 4WD /Avant 05/04-12/10 3.0 TDi Allroad 06/06-01/12 3.2 FSi /4WD /Avant 05/04-10/08 3.2 FSi Allroad 06/06-10/08 4.2 FSi Allroad 06/06-01/12 4.2i /FSi 4WD /Avant 05/04-12/10 5.0i Turbo RS6 4WD/Avant 10/08-12/10 5.2i 4WD /Avant Ch- 4F-8-018001 -12/10
7476199 OE 4F0407693H	Bras de susp. AR inf. G <i>Left rear lower track control arm</i>	7476200 OE 4F0407694H	Bras de susp. AR inf. D <i>Right rear lower track control arm</i>
	4 Avec rotule With ball joint		3 Avec rotule With ball joint
	TT /all models Sauf S6 /RS6 Ch- 4FZ5000001 -ch 4FZB150000 01/05-12/11		TT /all models Sauf S6 /RS6 Ch- 4FZ5000001 -ch 4FZB150000 01/05-12/11
7476201 OE 4F0407151A			
Bras de suspension inf. AV <i>Front lower Track control arm</i>			
	3 Avec rotule With ball joint		
	4		
2.0 TDi /Avant 07/04-12/10 2.4i V6 24v. /4WD /Avant 05/04-12/10 2.7 TDi /4WD 01/05-12/10 2.7 TDi Allroad 06/06-08/11 2.8 FSi /4WD /Avant 06/07-12/10 3.0 TFSi 4WD /Avant 10/08-12/10 3.0 TFSi Allroad 10/08-01/12 3.0 TDi 4WD /Avant 05/04-12/10 3.0 TDi Allroad 06/06-01/12 3.2 FSi /4WD /Avant 05/04-10/08 3.2 FSi Allroad 06/06-10/08 4.2 FSi /4WD /Avant 06/06-12/10 4.2 FSi Allroad 06/06-01/12 5.0i Turbo RS6 4WD /Avant 10/08-12/10 5.2i 4WD /Avant 04/06-12/10			

... A6 III 05/04- 03/11



Support d'amortisseur

Suspension mounting
Soporte amortiguador
Poduszka amortyzatora
Опора амортизатора

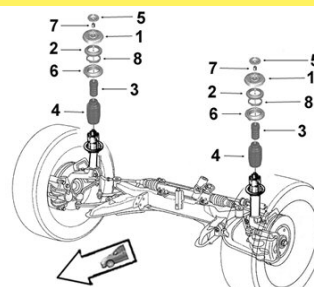

9005326

Butée de suspension G/D

OE 8D0412131F

L/R suspension bush

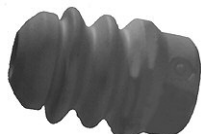

3

H85

2.0 TFSi	05/05-10/08
2.0 TDi	05/04-10/08
2.4i /4WD	05/04-10/08
2.7 TDi /4WD	01/05-10/08
3.0 TDi 4WD	05/04-06/06
3.0 TDi 4WD /Avant	06/06-10/08
3.2 FSi /4WD	05/04-10/08
4.2i 4WD S6	05/04-06/06

Sauf châssis sport

9001776

Articulation porte moyeu

OE 8E0505203D

Hub seat bush

Ø int.12 Ø ext.44 coll.46 coll.51
long. tube int.60 ext.27 ep. coll.5



2.0 TFSi /Avant	05/05-12/10
2.0 TDi /Avant	05/04-12/10
2.4i /4WD	05/04-10/08
2.7 TDi /4WD /Avant	01/05-12/10
2.7 TDi 4WD / Allroad	10/08-
2.8 FSi /4WD /Avant	10/08-12/10
3.0 TFSi 4WD /Avant	10/08-12/10
3.0 TFSi Allroad	10/08-
3.0 TDi 4WD /Avant	05/04-12/10
3.0 TDi Allroad CDYA/C	10/08-
3.2 FSi /4WD AUK	05/04-10/08
4.2i 4WD S6 BAT	05/04-06/06
4.2 FSi 4WD/Avant BVJ	10/08-12/10
4.2 FSi Allroad Avant BVJ	10/08-
5.0i Turbo RS6 4WD/Avant	BUH 10/08-12/10
5.2i S6 4WD/Avant BXA	10/08-12/10

Éléments TRAIN ARRIERE

Rear axle parts

Tren TRAS

Elementy zawieszenia tylnego

элементы задней оси.



A6 IV 02/11- 4G ...



Barre stabilisatrice

Stabilizer bar

Barra estabilizadora

Drażek stabilizatora

стабилизатор поперечной устойчивости

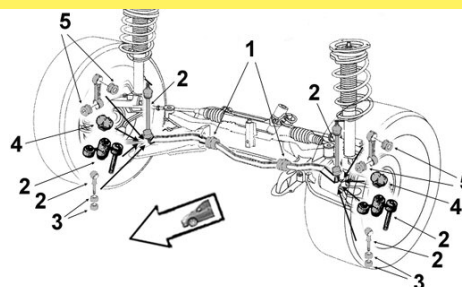

2306118

Palier de barre milieu

OE 8K0411327A

Middle bar main bearing



1 Ø24

2.0 TFSi	06/11-
2.0 TDi	03/11-
2.8 FSi	03/11-
3.0 TDi	03/11-
3.0 TDi	03/11-
3.0 TFSi	03/11-
4.0 TFSi	03/11-

2306107

Palier de barre milieu

OE 8K0411327B

Middle bar main bearing



1 Ø26

Barre stab. bleue
Ch- 4GZB-000001

2.0 TFSi	17/01/11-
2.0 TDi	17/01/11-
2.8 FSi	17/01/11-
3.0 TDi	17/01/11-
3.0 TFSi	17/01/11-

... A6 IV 02/11- 4G

SASIC

AUDI

Bras & Triangle de suspension

Control arm
Brazo y triángulo
Wahacz
Рычаг подвески

G/L  D/R



7476124

Bras de susp. AV inf. AVG

OE 8K0407151D *Front L front lower track control arm*

NEW



4 Sans rotule *Without ball joint*

2.0 TFSi	06/11-15/08/11
2.0 TDi	03/11-15/08/11
2.8 FSi	03/11-15/08/11
3.0 TDi	03/11-15/08/11
3.0 TFSi	03/11-15/08/11

7476125

Bras de susp. AV inf. AVD

OE 8K0407152D *Front R front lower track control arm*

NEW



3 Sans rotule *Without ball joint*

2.0 TFSi	06/11-15/08/11
2.0 TDi	03/11-15/08/11
2.8 FSi	03/11-15/08/11
3.0 TDi	03/11-15/08/11
3.0 TFSi	03/11-15/08/11

7576018

Rotule de susp. inf.

OE 8K0407689G *Inferior suspension ball joint*

NEW



1
2

2.0 TFSi	06/11-15/08/11
2.0 TDi	06/11-15/08/11
2.8 FSi /4WD	03/11-15/08/11
3.0 TDi /4WD	03/11-15/08/11
3.0 TFSi 4WD	03/11-15/08/11
4.0 TFSi 4WD	01/11-15/08/11



Support d'amortisseur

Suspension mounting
Soporte amortiguador
Poduszka amortyzatora
Опора амортизатора

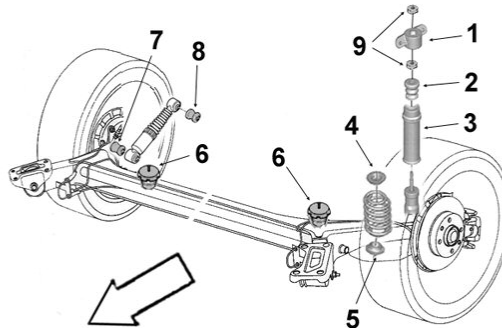

2656050

Butée de suspension

OE 8K0512131 *Shock bush*



2 H 145

2.0 TFSi /Avant	06/11-
2.0 TDi /Avant /FAP	03/11-
2.8 FSi /Avant /4WD	03/11-
3.0 TDi /Avant /4WD	03/11-
3.0 TFSI 4WD /Avant	03/11-

A7



Barre stabilisatrice
 Stabilizer bar
 Barra estabilizadora
 Drażek stabilizatora
 стабилизатор поперечной устойчивости

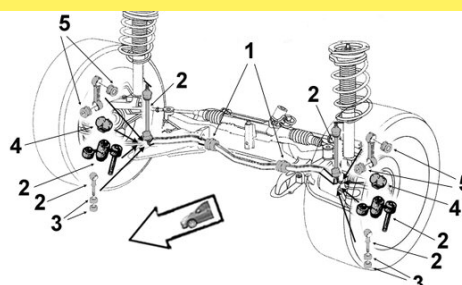

AUDI



9001547 **Palier de barre milieu**
 OE 4D0411327G *Middle bar main bearing*

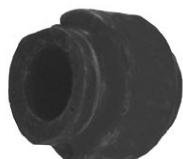

1 Barre Ø26.8

2.8 FSi
 3.0i Turbo
 3.0 TDi

10/10-
 10/10-
 03/11-

2306107 **Palier de barre milieu**
 OE 8K0411327B *Middle bar main bearing*



1 Ø26
 Barre stab. bleue

2.8 FSi
 3.0i Turbo
 3.0 TDi
 3.6 FSi
 4.0 TFSi

Bras & Triangle de suspension

Control arm
 Brazo y triángulo
 Wahacz
 Рычаг подвески

G/L D/R



7476124 **Bras de susp. AV inf. AVG**
 OE 8K0407151D *Front L front lower track control arm*

NEW



4 Sans rotule Without ball joint

2.8 FSi 10/10-15/08/11
 3.0i Turbo 10/10-15/08/11
 3.0 TDi 10/10-15/08/11

7476125 **Bras de susp. AV inf. AVD**
 OE 8K0407152D *Front R front lower track control arm*

NEW



3 Sans rotule Without ball joint

2.8 FSi 10/10-15/08/11
 3.0i Turbo 10/10-15/08/11
 3.0 TDi 10/10-15/08/11

7576018 **Rotule de susp. inf.**
 OE 8K0407689G *Inferior suspension ball joint*

NEW



1
2

2.8 FSi
 3.0i Turbo
 3.0 TDi

10/10-15/08/11
 10/10-15/08/11
 10/10-15/08/11

A8 ...

Eléments DIRECTION
Steering parts
Elementos Direcciones
Elementy uklad kierowniczy
Элементы рулевой системы

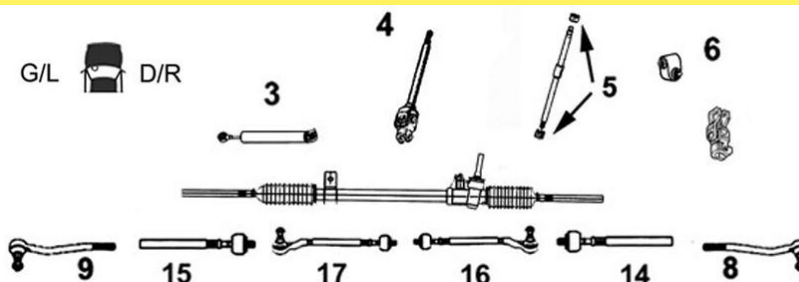

AUDI

9006247 **Axe de bielle G/D**
 OE 4B0422821 *L/R axial joint*

14 Côté dir. M16x1.5 Côté rot. M14x1.5
15 long 128 mm



2.5 TDi /4WD	-11/02
2.8i V6 30v. /4WD	-11/02
3.3 TDi 4WD	-11/02
3.7i V8 /4WD	-11/02
4.2i 4WD	-11/02
6.0i W12 4WD	-11/02

9006413 **Rotule de direction G/D**
 OE 4B0419811F *L/R tie rod end*

8 M14 x 1.5
9



2.5 TDi /4WD	09/97-11/02
2.8i V6 /4WD	09/94-11/02
3.3 TDi 4WD	07/00-11/02
3.7i /4WD	12/95-11/02
4.2i 4WD	09/94-11/02
6.0i 4WD	06/01-11/02



Barre stabilisatrice
Stabilizer bar
Barra estabilizadora
Drażek stabilizatora
 стабилизатор поперечной устойчивости

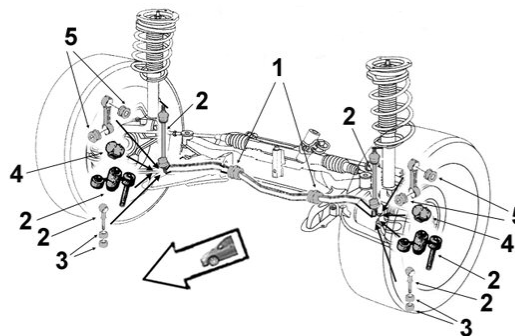

2306107 **Palier de barre milieu**
 OE 8K0411327B *Middle bar main bearing*

1 Ø26
 Barre stab. blanche Ch- 4HZAN000001



2.0 TFSi	03/10-
3.0 TDi /4WD /FAP	03/10-
3.0 TFSi 4WD	03/10-
4.0 TFSi 4WD	03/10-
4.2i 4WD	03/10-

9001547 **Palier de barre milieu**
 OE 4D0411327G *Middle bar main bearing*

1 Barre Ø26.8

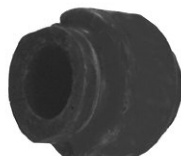

2.5 TDi V6 24v.	01/94-
2.8 E V6	01/94-
2.8 E V6 30v.	01/94-

9001548 **Palier de barre milieu**
 OE 4D0411327H *Middle bar main bearing*

1 Barre Ø29



2.5 TDi /4WD	AFB AKE AKN	09/97-11/02
--------------	-------------	-------------

... A8 ...



Eléments SUSPENSION

Suspension parts

Elementos suspensión





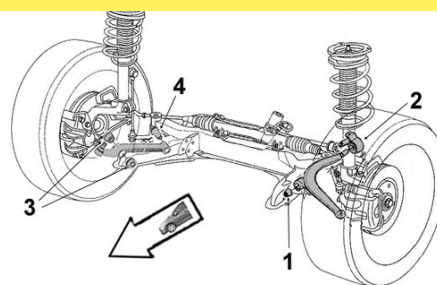























Elementy zawieszenie

Элементы подвески



AUDI



9001758 OE 4B0407515	Articulation bras sup. AR <i>Rear upper arm bush</i>	9001538 OE 4D0407181H	Articulation cent. bras inf. AV <i>Front lower middle arm bush</i>															
	4 Ø int.10 Ø ext.46.5 long. tube int.40 ext.26 2.5 TDi V6 24v. 01/94-11/02 2.8 V6 01/94-11/02 2.8 V6 30v. 01/94-11/02		3 Ø int.12 Ø ext.40 long. tube int.50 ext.42 2.5 TDi V6 24v. 01/94-11/02 2.8 V6 01/94-11/02 2.8 V6 30v. 01/94-11/02															
9001539 OE 4D0407182G	Articulation ext. bras inf. AV <i>Front lower arm outer bush</i>	9001540 OE 4D0407183AC	Articulation bras inf. AR <i>Lower arm bush Rear</i>															
	4 Ø int.12 Ø ext.50 long. tube int.60 ext.31 2.5 TDi V6 24v. 01/94-11/02 2.8 V6 01/94-11/02 2.8 V6 30v. 01/94-11/02		4 Ø int.12 Ø ext.65 long. tube int.80 ext.65.5 2.5 TDi V6 24v. 01/94-11/02 2.8 V6 01/94-11/02 2.8 V6 30v. 01/94-11/02															
<table style="width: 100%; border: none;"> <tr> <td style="width: 30%; vertical-align: top;"> Bras & Triangle de suspension Control arm Brazo y triángulo Wahacz Рычаг подвески </td> <td style="width: 10%; text-align: center; vertical-align: middle;"> G/L  D/R </td> <td style="width: 30%; text-align: center; vertical-align: middle;">  2 </td> <td style="width: 10%; text-align: center; vertical-align: middle;"> 1 </td> <td style="width: 30%; text-align: center; vertical-align: middle;">  </td> </tr> <tr> <td colspan="2"></td> <td style="text-align: center; vertical-align: middle;">  4 </td> <td colspan="2" style="text-align: center; vertical-align: middle;">  3 </td> </tr> <tr> <td colspan="2"></td> <td style="text-align: center; vertical-align: middle;">  </td> <td colspan="2" style="text-align: center; vertical-align: middle;">  </td> </tr> </table>				Bras & Triangle de suspension Control arm Brazo y triángulo Wahacz Рычаг подвески	G/L  D/R	 2	1				 4	 3						
Bras & Triangle de suspension Control arm Brazo y triángulo Wahacz Рычаг подвески	G/L  D/R	 2	1															
		 4	 3															
																		
9005749 OE 4D0407509J	Bras de susp. AR sup. G <i>Left rear upper track control arm</i>	9005750 OE 4D0407510J	Bras de susp. AR sup. D <i>Right rear upper track control arm</i>															
	4 Avec rotule With ball joint 2.5 TDi /4WD 09/97-11/02 2.8i V6 /4WD 09/97-11/02 3.3 TDi 4WD 09/97-11/02 3.7i /4WD 09/97-11/02 4.2i 4WD /S8 09/97-11/02 6.0i 4WD 06/01-11/02		3 Avec rotule With ball joint 2.5 TDi /4WD 09/97-11/02 2.8i V6 /4WD 09/97-11/02 3.3 TDi 4WD 09/97-11/02 3.7i /4WD 09/97-11/02 4.2i 4WD /S8 09/97-11/02 6.0i 4WD 06/01-11/02															
7476204 OE 4E0407509H	Bras de suspension Sup. AR G <i>Rear Upper left track control arm</i>	7476205 OE 4E0407510H	Bras de suspension Sup. AR D <i>Rear Upper right track control arm</i>															
	4 Avec rotule With ball joint Ø 18 Ch- 4EZ3000001 - 4EZA-02000 2.0 TFSi 2.8FSi /i V6 3.0i V6 30v. /TFSi 3.0 TDi 3.2 FSi 3.7i 4.0 TDi 4.0 TFSi 4.2i /FSi 4.2 TDi 5.2 FSi 6.0i 48v.		3 Avec rotule With ball joint Ø 18 Ch- 4EZ3000001 - 4EZA-02000 2.0 TFSi 2.8FSi /i V6 3.0i V6 30v. /TFSi 3.0 TDi 3.2 FSi 3.7i 4.0 TDi 4.0 TFSi 4.2i /FSi 4.2 TDi 5.2 FSi 6.0i 48v.															

... A8

SASIC

AUDI

Bras & Triangle de suspension

Control arm
Brazo y triángulo
Wahacz
Рычаг подвески

G/L  D/R

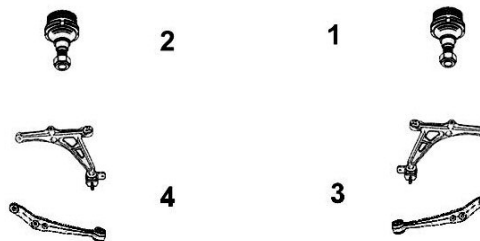

7476208

Bras de suspension Sup. AV G

OE 4E0407505E

Front upper left track control arm

NEW



4 Avec rotule With ball joint Ø 18 -ch 4EZA-02000

2.8 FSi	12/07-
3.0i V6 30v. /4WD	06/03-
3.0 TDi 4WD	11/03-
3.2 FSi /4WD	04/05-
3.7i 4WD	01/03-
4.0 TDi 4WD	06/03-
4.2i /FSi 4WD	06/06-
4.2 TDi 4WD	01/03-
5.2 FSi 4WD S8	04/06-
6.0i 48v. 4WD	04/04-

7476209

Bras de suspension Sup. AV D

OE 4E0407506E

Front upper right track control arm

NEW



3 Avec rotule With ball joint Ø 18 -ch 4EZA-02000

2.8 FSi	12/07-
3.0i V6 30v. /4WD	06/03-
3.0 TDi 4WD	11/03-
3.2 FSi /4WD	04/05-
3.7i 4WD	01/03-
4.0 TDi 4WD	06/03-
4.2i /FSi 4WD	06/06-
4.2 TDi 4WD	01/03-
5.2 FSi 4WD S8	04/06-
6.0i 48v. 4WD	04/04-

9005156

Bras de susp. AR inf. G

OE 8E0407693AG

Left rear lower track control arm



4 Avec rotule With ball joint Sauf jantes 20 pouces

2.5 TDi /4WD	09/97-11/02
2.8i V6 /4WD	09/94-11/02
3.7i /4WD	12/95-11/02
4.2i 4WD /S8	09/94-09/02

9005154

Bras de susp. AR inf. D

OE 8E0407694AG

Right rear lower track control arm



3 Avec rotule With ball joint Sauf jantes 20 pouces

2.5 TDi /4WD	09/97-11/02
2.8i V6 /4WD	09/94-11/02
3.7i /4WD	12/95-11/02
4.2i 4WD /S8	09/94-09/02

9005157

Bras de susp. AV inf. G/D

OE 4D0407151P

L/R front lower track control arm



3 Avec rotule With ball joint
4 -ch 4D-X-005500

2.5 TDi /4WD	09/97-04/00
2.8i V6 /4WD	09/94-
3.7i /4WD	12/95-
4.2i 4WD /S8	09/94-



Support d'amortisseur

Suspension mounting
Soporte amortiguador
Poduszka amortyzatora
Опора амортизатора

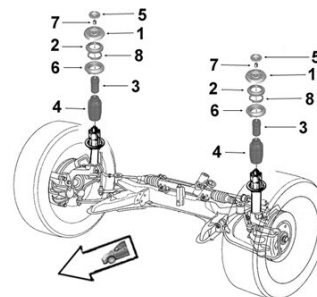

9005326

Butée de suspension G/D

OE 8D0412131F

L/R suspension bush

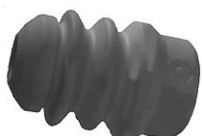

3 H85

2.5 TDi /4WD	AFB AKE AKN	09/97-11/02
--------------	-------------	-------------

Q3 ...

Eléments DIRECTION

Steering parts

Elementos Direcciones

Elementy układ kierowniczy

Элементы рулевой системы

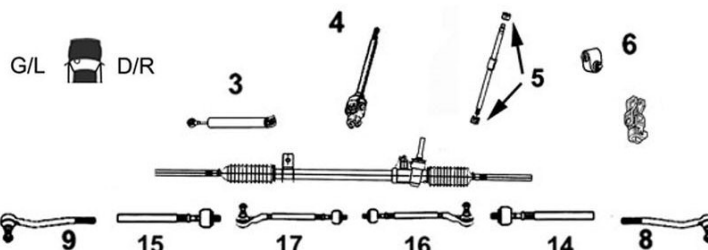

9006873

Axe de bielle G/D

OE 1K0423810A

L/R axial joint



14 Côté dir. M16x1.5 Côté rot. M16x1.5 long 310 mm
15

2.0 TFSi 4WD
2.0 TDi /4WD

06/11-
06/11-

9006638

Rotule de direction G

OE 1K0423811K

Left tie rod end



9 M16 x 1.5

2.0 TFSi 4WD
2.0 TDi FAP/4WD

06/11-
06/11-

9006637

Rotule de direction D

OE 1K0423812K

Right tie rod end



8 M16 x 1.5

2.0 TFSi 4WD
2.0 TDi FAP /4WD

06/11-
06/11-



Barre stabilisatrice

Stabilizer bar

Barra estabilizadora

Drażek stabilizatora

стабилизатор поперечной устойчивости

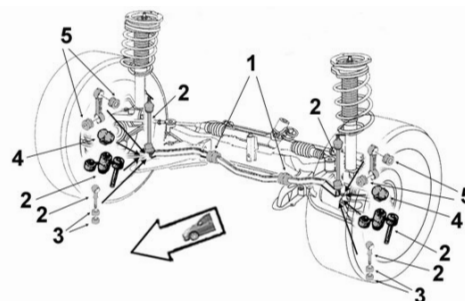

2306010

Biellette barre stab.

OE 1K0411315P

Stabilizer bar stub axle



2

2.0 TFSi
2.0 TDi

06/11-

06/11-

AUDI

SASIC

... Q3 ...



Eléments SUSPENSION

Suspension parts
Elementos suspensión
Elementy zawieszenie
Элементы подвески

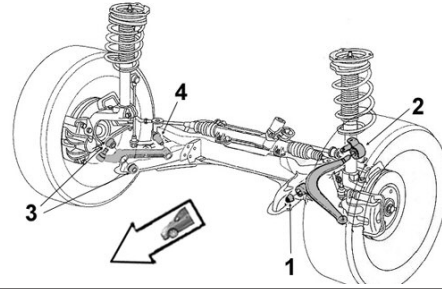

SASIC

AUDI

9001759

Articulation AV

OE 1K0407182

Front bush



1 Ø int.12 Ø ext.40 coll.48 long. tube int.54 ext.33 ep. coll.6

2.0 TFSi
2.0 TDi

06/11-
06/11-

Bras & Triangle de suspension

Control arm
Brazo y triángulo
Wahacz
Рычаг подвески

G/L D/R

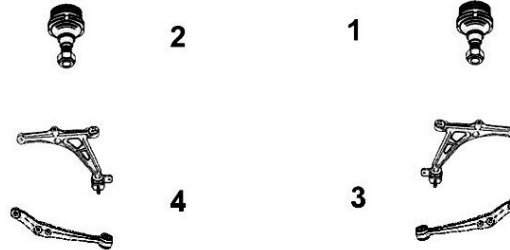

7476038

Triangle de susp. G/D

OE 3C0407151G

L/R track control arm



3 Avec rotule With ball joint
4

2.0 TFSi 4WD
2.0 TDi /4WD

14/10/13-
14/10/13-

7476180

Triangle de susp. G

OE 3C0407151G+1K0407365C Left track control arm

NEW



4 Avec rotule With ball joint

2.0 TFSi 4WD
2.0 TDi /4WD

14/10/13-
14/10/13-

7476179

Triangle de susp. D

OE 3C0407151G+1K0407366C Right track control arm

NEW



3 Avec rotule With ball joint

2.0 TFSi 4WD
2.0 TDi /4WD

14/10/13-
14/10/13-

9005570

Rotule de susp. inf. G

OE 1K0407365C Left lower suspension ball joint



2

2.0 TFSi 4WD
2.0 TDi /4WD

06/11-
06/11-

9005569

Rotule de susp. inf. D

OE 1K0407366C Right lower suspension ball joint



1

2.0 TFSi 4WD
2.0 TDi /4WD

06/11-
06/11-

... Q3



Support d'amortisseur
Suspension mounting
Soporte amortiguador
Poduszka amortyzatora
Опора амортизатора

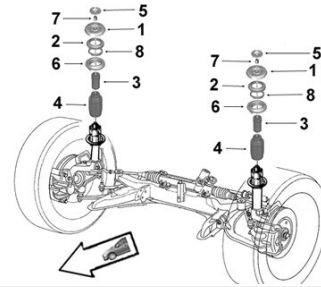

2656053

Protecteur amortisseur G/D

OE 6N0413175A

L/R shock absorber protector



4 H206

2.0 TFSi
 2.0 TDi

06/11-
 06/11-



Barre stabilisatrice
Stabilizer bar
Barra estabilizadora
Drażek stabilizatora
стабилизатор поперечной устойчивости

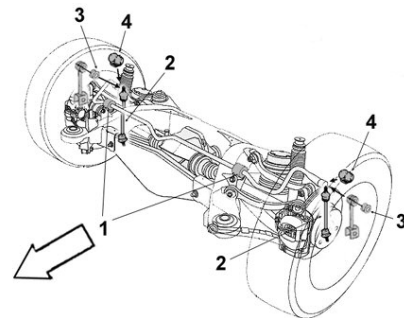

9005094

Biellette barre stab.

OE 1K0505465K

Stabilizer bar stub axle



2

2.0 TFSi
 2.0 TDi

06/11-
 06/11-

Eléments TRAIN ARRIERE

Rear axle parts
Tren TRAS
Elementy zawieszenia tylnego
элементы задней оси.



9001786

Articulation essieu G/D inf.

OE 1K0505553A

Lower L/R axle bush



Ø int. 12 Ø ext. 37 long. tube int. 50 ext. 28

2.0 TFSi
 2.0 TDi

06/11-
 06/11-

Q5 ...

Eléments DIRECTION

Steering parts

Elementos Direcciones

Elementy układ kierowniczy

Элементы рулевой системы

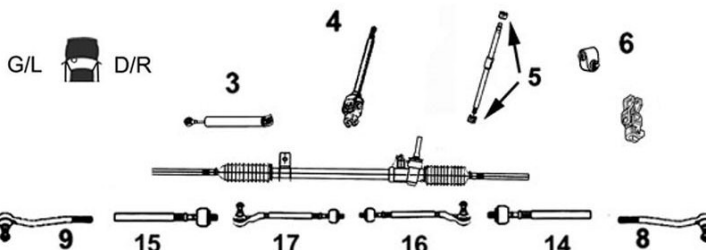

7776078

Axe de bielle G/D

OE 4H0422810A

L/R axial joint

NEW



14 Côté dir. M16x1.5 Côté rot. M16x1.5 long 226 mm
15 Sauf DA électromécanique

2.0 TFSi	4WD	10/08-
2.0 TDi	/4WD	10/08-
3.0 TDi	4WD	10/08-
3.2 FSi	4WD	10/08-

7676052

Rotule de direction G

OE 8K0422817B

Left tie rod end

NEW



9 M16 x 1.5
 Sauf DA électromécanique

2.0 TFSi	4WD	10/08-
2.0 TDi	/4WD	10/08-
3.0 TDi	4WD	10/08-
3.2 FSi	4WD	10/08-

7676053

Rotule de direction D

OE 8K0422818B

Right tie rod end

NEW



8 M16 x 1.5
 Sauf DA électromécanique

2.0 TFSi	4WD	10/08-
2.0 TDi	/4WD	10/08-
3.0 TDi	4WD	10/08-
3.2 FSi	4WD	10/08-



Barre stabilisatrice

Stabilizer bar

Barra estabilizadora

Drażek stabilizatora

стабилизатор поперечной устойчивости

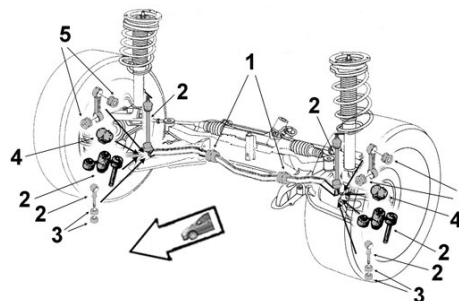

2306109

Palier de barre milieu

OE 8K0411327C

Middle bar main bearing

1



2.0 TFSi	4WD	10/08-	
2.0 TDi	4WD	10/08-	
3.0 TDi FAP	4WD	BV rob.7	10/08-
3.2 FSi	4WD	BV rob.7	10/08-

... Q5







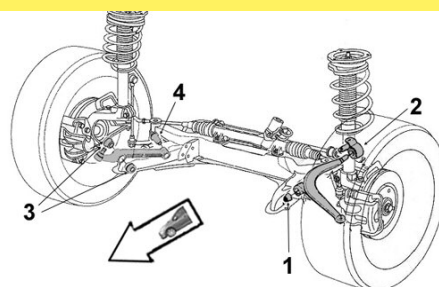





Eléments SUSPENSION

Suspension parts
Elementos suspensión
Elementy zawieszenie
Элементы подвески



AUDI



2256004 OE 8E0407181C	Art. AV bras inf. AV ext. <i>Front outer lower arm front bush</i>	2256051 OE 8R0407515	Art. bras sup. AV/AR <i>Upper arm bush F/R</i>
	3 Ø int. 12.5 Ø ext. 40.5 long. tube int. 37 ext. 31 2.0 TFSi 10/08- 2.0 TDi 10/08- 3.0 TDi 10/08- 3.2 FSi 10/08-		4 Ø int. 10 Ø ext. 46.3 long. tube int. 40 ext. 26 2.0 TFSi 10/08- 2.0 TDi 10/08- 3.0 TDi 10/08- 3.2 FSi 10/08-
2256054 OE 8K0407182B	Art. AR bras inf. AV Côté berceau <i>Rear arm bush Front frame side</i>	2256053 OE 8K0407183A	Articulation bras inf. AR <i>Lower arm bush Rear</i>
	4 Ø int. 12 Ø ext. 50 long. tube int. 55 ext. 35 2.0 TFSi 10/08- 2.0 TDi 10/08- 3.0 TDi 10/08- 3.2 FSi 10/08-		4 Ø int. 12 Ø ext. 65 long. tube nt. 80 ext. 66 2.0 TFSi 10/08-10/09 2.0 TDi 10/08-10/09 3.0 TDi 10/08-10/09 3.2 FSi 10/08-10/09
<p>Bras & Triangle de suspension Control arm Brazo y triángulo Wahacz Рычаг подвески</p>			
G/L  D/R			
7476227 OE 8K0407693N	Bras de susp. AR inf. G <i>Left rear lower track control arm</i>	7476225 OE 8K0407694N	Bras de susp. AR inf. D <i>Right rear lower track control arm</i>
	4 Avec rotule With ball joint Articulation Ø 65 2.0 TFSi 4WD -20/07/09 2.0 TDi 4WD -20/07/09 3.0 TDi 4WD -20/07/09 3.2 FSi 4WD -20/07/09		3 Avec rotule With ball joint Articulation Ø 65 2.0 TFSi 4WD -20/07/09 2.0 TDi 4WD -20/07/09 3.0 TDi 4WD -20/07/09 3.2 FSi 4WD -20/07/09
7476124 OE 8K0407151D	Bras de susp. AV inf. AVG <i>Front L front lower track control arm</i>	7476125 OE 8K0407152D	Bras de susp. AV inf. AVD <i>Front R front lower track control arm</i>
	4 Sans rotule Without ball joint 2.0 TFS 4WD 10/08-15/08/11 2.0 TDi /4WD 09/09-15/08/11 3.0 TDi 4WD 10/08-15/08/11 3.2 FSi 4WD 10/08-15/08/11		3 Sans rotule Without ball joint 2.0 TFS 4WD 10/08-15/08/11 2.0 TDi /4WD 09/09-15/08/11 3.0 TDi 4WD 10/08-15/08/11 3.2 FSi 4WD 10/08-15/08/11

... Q5

Bras & Triangle de suspension

Control arm
Brazo y triángulo
Wahacz
Рычаг подвески

G/L  D/R

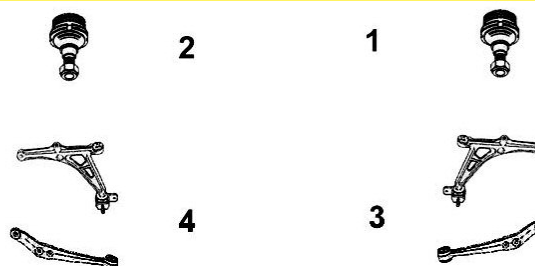

7576018

Rotule de susp. inf.

OE 8K0407689G

Inferior suspension ball joint

NEW



1
2

2.0 TFSi	4WD
2.0 TDi	/4WD
3.0 TDi	4WD
3.2 FSi	4WD

10/08-15/08/11
10/08-15/08/11
10/08-15/08/11
10/08-15/08/11



Support d'amortisseur

Suspension mounting
Soporte amortiguador
Poduszka amortyzatora
Опора амортизатора

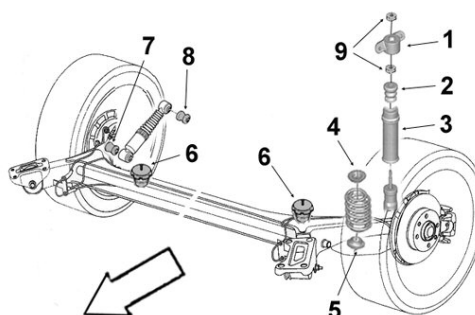

2656042

Support suspension

OE 8K0513353E

Suspension mounting



1

2.0 TFSi	4WD	10/08-
2.0 TDi	/4WD	10/08-
3.0 TDi	4WD	10/08-
3.2 FSi	4WD	10/08-

2656050

Butée de suspension

OE 8K0512131

Shock bush



2

H 145

2.0 TFSi	4WD	10/08-
2.0 TDi	/4WD	10/08-
3.0 TDi	4WD	10/08-
3.2 FSi	4WD	10/08-

Q7 ...

Eléments DIRECTION

Steering parts
Elementos Direcciones
Elementy uklad kierowniczy
Элементы рулевой системы

G/L  D/R

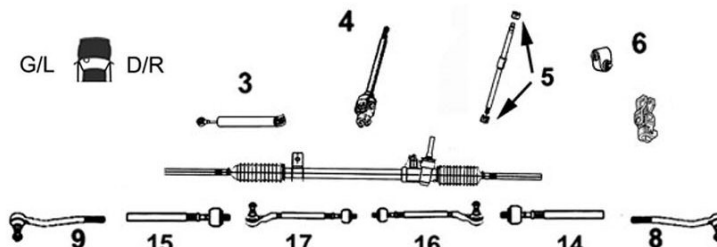

7776024

Axe de bielle G/D

Part/oe 7L0422803D

L/R axial joint



14
15

Côté dir. M16x1.5 Côté rot. M16x1.5 long 288 mm

3.0 TDi	4WD
3.6 FSi	4WD
4.1 TDi	4WD
4.2 FSi	4WD
4.2 TDi	4WD
6.0 TDi	4WD

03/06-
10/06-
03/07-04/09
03/06-
04/09-
10/08-

... Q7

Eléments DIRECTION

Steering parts

Elementos Direcciones

Elementy uklad kierowniczy

Элементы рулевой системы

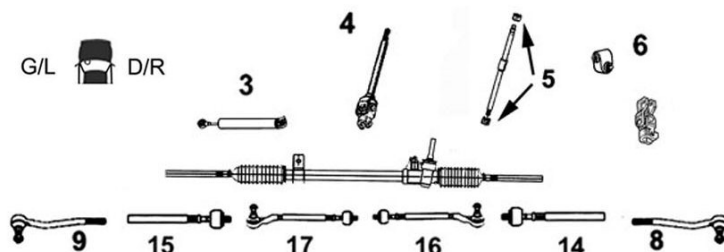

7676022

Rotule de direction G

OE 7L0422817D

Left tie rod end



9

M16 x 1.5

3.0 TDi	4WD	03/06-
3.6 FSi	4WD	10/06-
4.1 TDi	4WD	03/07-
4.2 FSi	4WD	03/06-
4.2 TDi	4WD	04/09-
6.0 TDi	4WD	10/08-

7676021

Rotule de direction D

OE 7L0422818D

Right tie rod end



8

M16 x 1.5

3.0 TDi	4WD	03/06-
3.6 FSi	4WD	10/06-
4.1 TDi	4WD	03/07-
4.2 FSi	4WD	03/06-
4.2 TDi	4WD	04/09-
6.0 TDi	4WD	10/08-

Bras & Triangle de suspension

Control arm

Brazo y triángulo

Wahacz

Рычаг подвески

G/L D/R

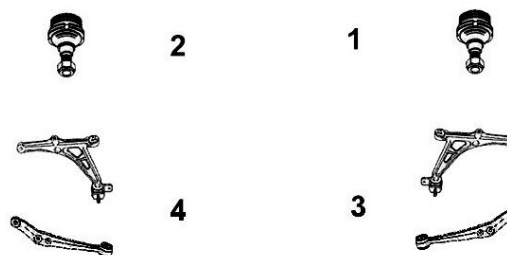

7476034

Triangle de susp. G/D

OE 7L0407021B

L/R track control arm



3

Avec rotule With ball joint

4

3.0 TDi	4WD	03/06-
3.6 FSi	4WD	10/06-
4.1 TDi	4WD	03/07-
4.2 FSi	4WD	03/06-
4.2 TDi	4WD	04/09-
6.0 TDi	4WD	10/08-

TT ...

Eléments DIRECTION

Steering parts

Elementos Direcciones

Elementy uklad kierowniczy

Элементы рулевой системы

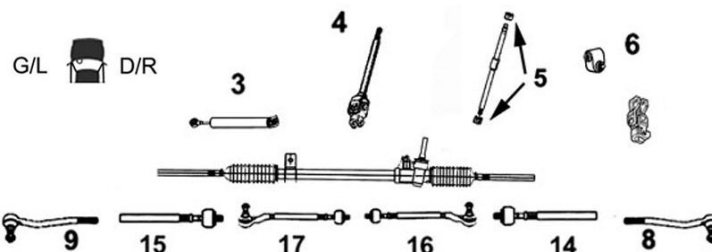

7776078

Axe de bielle G/D

OE 4H0422810A

L/R axial joint

NEW



14

15

Côté dir. M16x1.5 Côté rot. M16x1.5 long 226 mm

1.8 TFSi		01/07-04/10
2.0 TFSi	/4WD	01/07-04/10
2.0 TDi	4WD	01/07-04/10
3.2 FSi	4WD	01/07-04/10

... TT ...

SASIC

AUDI



Barre stabilisatrice
 Stabilizer bar
 Barra estabilizadora
 Drażek stabilizatora
 стабилизатор поперечной устойчивости

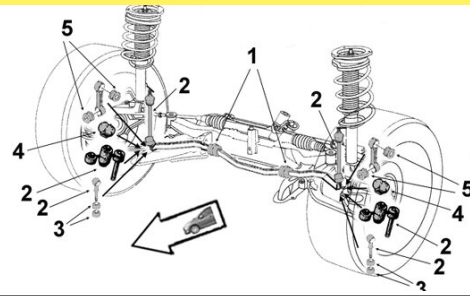

2306007 **Biellette barre stab. G**
 OE 1J0411315D *Left stabilizer bar stub axle*



2

1.8i 20v. Turbo /4WD 07/00-08/05
 3.2i V6 4WD Roadster 01/04-09/06

2306008 **Biellette barre stab. D**
 OE 1J0411316D *Right stabilizer bar stub axle*



2

1.8i 20v. Turbo /4WD 07/00-08/05
 3.2i V6 4WD 01/04-09/06

2306010 **Biellette barre stab. G/D**
 OE 1K0411315P *L/R stabilizer bar stub axle*



2

1.8 TFSi 07/08-04/10
 2.0 TFSi /4WD 09/06-04/10
 2.0 TDi 4WD 04/08-04/10
 3.2 FSi 4WD /Roadster 09/06-04/10

2306134 **Palier de barre**
 OE 1J0411314S *Bar main bearing*

NEW



1

Ø 17
 1.8i Turbo /4WD 10/98-12/02



Eléments SUSPENSION
 Suspension parts
 Elementos suspensión
 Elementy zawieszenie
 Элементы подвески

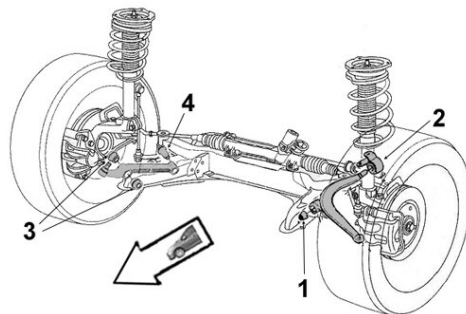

9001759 **Articulation AV**
 OE 1K0407182 *Front bush*



1 Ø int.12 Ø ext.40 coll.48 long. tube int.54 ext.33 ep. coll.6

1.8 TFSi 04/10-
 2.0 TFSi /4WD 04/10-
 2.0 TSi /4WD 04/10-
 2.0 TDi 4WD 04/10-
 2.5i 4WD 04/10-
 3.2 FSi 4WD 04/10-

... TT ...



Support d'amortisseur
Suspension mounting
Soporte amortiguador
Poduszka amortyzatora
Опора амортизатора

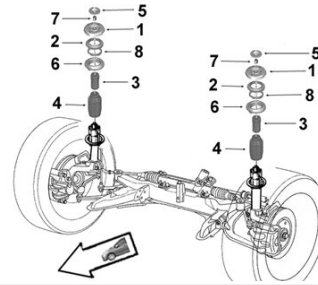

AUDI



9005622 **Support suspension G/D**
 OE 1K0412331B *L/R suspension mounting*



1

1.8 TFSi		04/10-
2.0 TFSi	/4WD /Châssis sport	08/06-
2.0 TSi		04/10-
2.0 TDi	4WD Châssis sport	04/10-
3.2 FSI	4WD /Roadster	08/06-06/10

9005352 **Butée à billes G/D**
 OE 1J0412249 *L/R ball bearing*



2

1.8i 20v. Turbo /4WD		10/98-09/06
----------------------	--	-------------

9005338 **Butée de suspension**
 OE 1H0412303B *Shock bush*



3 H64

1.8i 20v. Turbo		10/98-08/05
-----------------	--	-------------

2656003 **Butée de suspension**
 OE 1J0412303 *Shock bush*



3 H53

1.8i 20v. Turbo /4WD		10/98-08/05
----------------------	--	-------------

... TT ...

SASIC

AUDI



Support d'amortisseur
 Suspension mounting
 Soporte amortiguador
 Poduszka amortyzatora
 Опора амортизатора

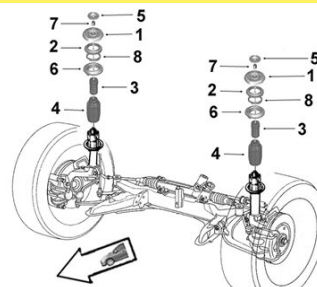

2656053 **Protecteur amortisseur G/D**
 OE 6N0413175A L/R shock absorber protector



4 H206		
1.8 TFSi		04/08-
2.0 TFSi	/4WD	09/06-
2.0 TSi	/4WD	04/10-
2.0 TDi	/4WD	04/08-
2.5i	4WD/RS	04/10-
3.2 FSi	4WD	09/06-



Barre stabilisatrice
 Stabilizer bar
 Barra estabilizadora
 Drażek stabilizatora
 стабилизатор поперечной устойчивости

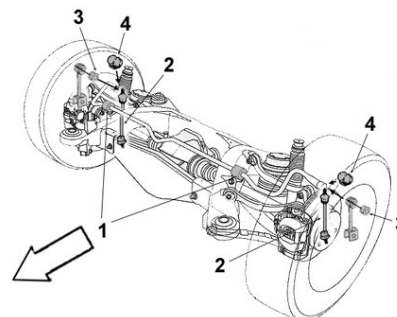

2306009 **Biellette barre stab. G/D**
 OE 1J0505466B L/R stabilizer bar stub axle



2		
1.8i Turbo	4WD	07/00-09/06
3.2i V6	4WD	01/04-09/06

9005094 **Biellette barre stab. G/D**
 OE 1K0505465K L/R stabilizer bar stub axle



2		
1.8 TFSi		07/08-
2.0 TFSi	/4WD	09/06-
2.0 TSi	/4WD	04/10-
2.0 TDi	4WD	04/08-
2.5i	4WD	07/09-
3.2 FSi	4WD	09/06-04/10

9001739 **Palier de barre milieu**
 OE 1K0511327AP Middle bar main bearing



1 Barre Ø 18.5		
1.8 TFSi		07/08-
2.0 TFSi	/4WD	09/06-
2.0 TSi		04/10-
2.0 TDi	4WD	04/08-
3.2 FSi	4WD	09/06-04/10

Eléments TRAIN ARRIERE

Rear axle parts

Tren TRAS

Elementy zawieszenia tylnego

элементы задней оси.

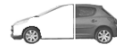

9001786

Articulation essieu G/D inf.

OE 1K0505553A

Lower L/R axle bush

Ø int. 12 Ø ext. 37 long. tube int. 50 ext. 28



1.8 TFSi
2.0 TFSi

07/08-04/10
09/06-04/10

Série 1 E81 E87 ...

Eléments DIRECTION

Steering parts

Elementos Direcciones

Elementy układ kierowniczy

Элементы рулевой системы

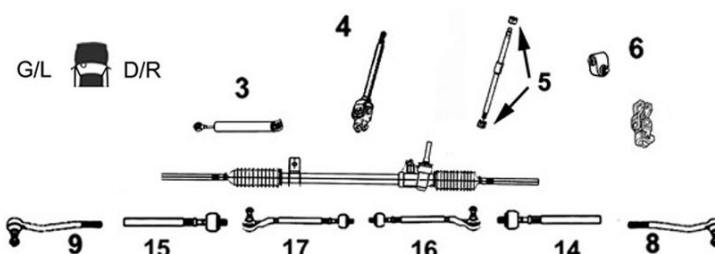

9006811 Axe de bielle G/D

Part/oe 32216762244 L/R axial joint

14 Côté dir. M18x1.5 Côté rot. M14x1.5 long 247 mm
15

1.6i 116i			
2.0i 118 E87	Direction ZF		12/04-12/06
2.0i 120i		BVM6	
2.0i 120i		BVA6	
2.0i 120i			05/04-12/06
2.0 D 118		BVM6	
2.0 D 118		BVA6	07/08-
2.0 D 120		BVM6	
2.0 D 120		BVA6	
2.0 D 123			02/09-
2.0 TD 116			02/09-
2.0 TD 118			05/04-
2.0 TD 120			05/04-
2.0 TD 123			07/07-



7776018 Axe de bielle G/D

Part/oe 32106765236 L/R axial joint

14 Côté dir. M18x1.5 Côté rot. M14x1.5 long 255 mm
15

1.6i E81 E87	Direction ZF		07/07-
2.0i 116	Direction ZF		02/09-
2.0i 118 E81 E87	Direction ZF		01/07-
2.0i 120 E81 E87	Direction ZF		01/07-
2.0 D 118 E81 E87	Direction ZF		07/08-
2.0 D 120 E81 E87	Direction ZF		07/08-
2.0 TD 116			02/09-
2.0 TD 118 E81 E87	Direction ZF		01/07-
2.0 TD 120 E81	Direction ZF		01/07-
2.0 TD 120 E87			05/04-12/06
2.0 TD 120 E87	Direction ZF		01/07-
2.0 TD 123 E81 E87	Direction ZF		07/07-
2.0 TD 318 E87	Direction ZF		05/04-12/06
3.0i 130 E81	Direction ZF		01/07-
3.0i 130 E87	Direction ZF		09/05-



... Série 1 E81 E87 ...

7676017 OE 32106765089	Rotule de direction G <i>Left tie rod end</i>		7676015 OE 32106765090	Rotule de direction D <i>Right tie rod end</i>	
	9 M14 x 1.5			8 M14 x 1.5	
	1.6i E81	Direction ZF 07/07-05/04-		1.6i E81	Direction ZF 07/07-05/04-
	1.6i E87	Direction ZF 01/09-		1.6i E87	Direction ZF 01/09-
	2.0i 116	Direction ZF 01/09-		2.0i 116	Direction ZF 01/09-
	2.0i 118 E81	Direction ZF 01/07-		2.0i 118 E81	Direction ZF 01/07-
	2.0i 118 E87	Direction ZF 12/04-		2.0i 118 E87	Direction ZF 12/04-
	2.0i 120 E81	Direction ZF 01/07-		2.0i 120 E81	Direction ZF 01/07-
	2.0i 120 E87	05/04-09/12		2.0i 120 E87	05/04-09/12
	2.0 D 118 E81/87	Direction ZF 07/08-		2.0 D 118 E81/87	Direction ZF 07/08-
	2.0 D 120 E81/87	Direction ZF 07/08-		2.0 D 120 E81/87	Direction ZF 07/08-
	2.0 TD 116	Direction ZF 02/09-		2.0 TD 116	Direction ZF 02/09-
	2.0 TD 118 E81	Direction ZF 01/07-		2.0 TD 118 E81	Direction ZF 01/07-
	2.0 TD 118 E87 BVM	05/04-12/06		2.0 TD 118 E87 BVM	05/04-12/06
	2.0 TD 118 E87	Direction ZF 01/07-		2.0 TD 118 E87	Direction ZF 01/07-
	2.0 TD 120 E81	Direction ZF 01/07-		2.0 TD 120 E81	Direction ZF 01/07-
	2.0 TD 120 E87	05/04-12/06		2.0 TD 120 E87	05/04-12/06
	2.0 TD 123 E81	Direction ZF 07/07-		2.0 TD 123 E81	Direction ZF 07/07-
	2.0 TD 123 E87	Direction ZF 07/07-		2.0 TD 123 E87	Direction ZF 07/07-
	3.0i 130 E81	Direction ZF 01/07-		3.0i 130 E81	Direction ZF 01/07-
	3.0i 130 E87	Direction ZF 09/05-		3.0i 130 E87	Direction ZF 09/05-

BMW

SASIC



Barre stabilisatrice
Stabilizer bar
Barra estabilizadora
Drażek stabilizatora
стабилизатор поперечной устойчивости

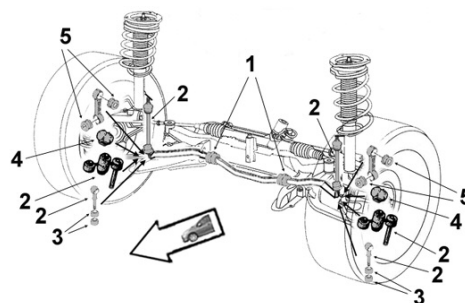

2306062 OE 31356765933	Biellette barre stab. G <i>Left stabilizer bar stub axle</i>		2306061 OE 31356765934	Biellette barre stab. D <i>Right stabilizer bar stub axle</i>	
	2			2	
	1.6i 116	05/04-		1.6i 116	05/04-
	2.0i 116	01/09-		2.0i 116	01/09-
	2.0i 118 120	05/04-		2.0i 118 120	05/04-
	2.0 D 118D 120D 123D	07/08-		2.0 D 118D 120D 123D	07/08-
	2.0 TD 116 BVM	02/09-		2.0 TD 116 BVM	02/09-
	2.0 TD 118 120 123	05/04-		2.0 TD 118 120 123	05/04-
	3.0i 130	01/07-		3.0i 130	01/07-
3.0i 130	01/06-	3.0i 130	01/06-		



Eléments SUSPENSION
Suspension parts
Elementos suspensión
Elementy zawieszenie
Элементы подвески

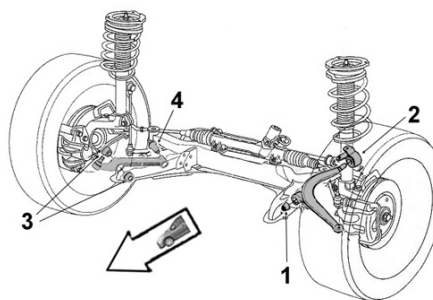

9003106 OE 31120393540	Articulation AV Bras <i>Arm front bush</i>			
	4	Ø int.12 Ø ext.70 long. tube int.76 ext.64		
	1.6i 116			09/04-
	2.0i 118 120		BVM6 BVA6	09/04-
	2.0 D 118D		BVM6	09/04-
	2.0 D 118D		BVA	07/08-
	2.0 D 120D 123D		BVM6 BVA6	09/04-
	2.0 TD 118			01/07-
	2.0 TD 120 123			05/04-
	3.0i 130			01/07-

... Série 1 E81 E87...

SASIC

BMW

Bras & Triangle de suspension

Control arm
Brazo y triángulo
Wahacz
Рычаг подвески

G/L  D/R

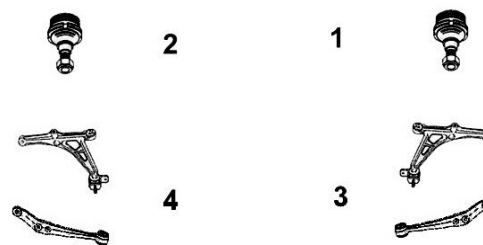

7476093

Bras de susp. AR inf. G

OE 31126770849 *Left rear lower track control arm*

NEW



3 Avec rotule With ball joint

BVM6 BVA6

1.6i 116	05/04-07/11
2.0i 116 118 120	05/04-07/11
2.0 D 116 118 120 123	07/08-07/11
2.0 TD 116 118 120 123	05/04-07/11
3.0i 130 E81/ E87	09/05-07/11

7476094

Bras de susp. AR inf. D

OE 31126770850 *Right rear lower track control arm*

NEW



3 Avec rotule With ball joint

BVM6 BVA6

1.6i 116	05/04-07/11
2.0i 116 118 120	05/04-07/11
2.0 D 116 118 120 123	07/08-07/11
2.0 TD 116 118 120 123	05/04-07/11
3.0i 130 E81/ E87	09/05-07/11

7476009

Bras de susp. AV inf. G

OE 31126769797 *L front lower track control arm*

4 Avec rotule With ball joint



1.6i E81	07/07-
1.6i E87	05/04-
2.0i 116	01/09-
2.0i 118 120 E81	01/07-
2.0i 118 E87	12/04-
2.0i 120 E87 150hp 110kw	05/04-12/06
2.0i 120 E87 170hp 125kw	01/07-
2.0 D 118 E81 E87	07/08-
2.0 D 120 E81 E87	07/08-
2.0 TD 116	02/09-
2.0 TD 118 E81 E87	01/07-
2.0 TD 118 E87 BVM	05/04-12/06
2.0 TD 120 E81	01/07-
2.0 TD 120 E87	05/04-
2.0 TD 123 E81 E87	07/07-
3.0i 130 E81	01/07-
3.0i 130 E87	09/05-

7476008

Bras de susp. AV inf. D

OE 31126769798 *R front lower track control arm*

3 Avec rotule With ball joint



1.6i E81	07/07-
1.6i E87	05/04-
2.0i 116	01/09-
2.0i 118 120 E81	01/07-
2.0i 118 E87	12/04-
2.0i 120 E87 150hp 110kw	05/04-12/06
2.0i 120 E87 170hp 125kw	01/07-
2.0 D 118 E81 E87	07/08-
2.0 D 120 E81 E87	07/08-
2.0 TD 116	02/09-
2.0 TD 118 E81 E87	01/07-
2.0 TD 118 E87 BVM	05/04-12/06
2.0 TD 120 E81	01/07-
2.0 TD 120 E87	05/04-
2.0 TD 123 E81 E87	07/07-
3.0i 130 E81	01/07-
3.0i 130 E87	09/05-



Support d'amortisseur

Suspension mounting
Soporte amortiguador
Poduszka amortyzatora
Опора амортизатора

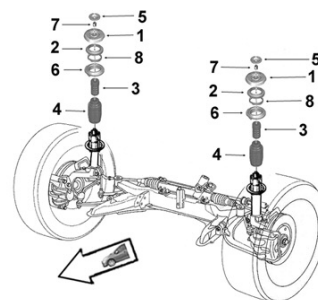

9001422

Support suspension G/D

OE 31336752735 *L/R suspension mounting*



1 Avec roulement With bearing

1.6i 116	09/04-
2.0i 116 118	09/04-
2.0i 120	09/04-
2.0 D 118D	09/04-
2.0 D 120D	09/04-
2.0 D 123D	07/07-
2.0 TD 116	02/09-

9001422

Support suspension G/D

OE 31336770568 *L/R suspension mounting*



1 Avec roulement With bearing

2.0 TD 123	04/08-
3.0i 130	09/09-

... Série 1 E81 E87



Barre stabilisatrice
 Stabilizer bar
 Barra estabilizadora
 Drażek stabilizatora
 стабилизатор поперечной устойчивости

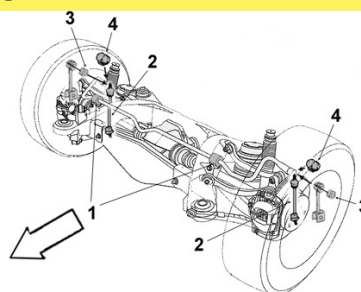

9005029 **Biellette barre stab.**
 OE 33556764428 *Stabilizer bar stub axle*



2	1.6i 116	BVM6 BVA6	09/04-
	2.0i 116 118 120	BVM6	09/04-
	2.0 D 118D	BVM6 BVA6	09/04-
	2.0 D 118D 120D 123D	BVM	02/09-
	2.0 TD 116		05/04-12/06
	2.0 TD 120		01/07-
	2.0 TD 118 120 123	BVA	01/06-12/06
	3.0i 130	BVM	09/05-
	3.0i 130		
	3.0i 130		



Eléments SUSPENSION
 Suspension parts
 Elementos suspensión
 Elementy zawieszenie
 Элементы подвески

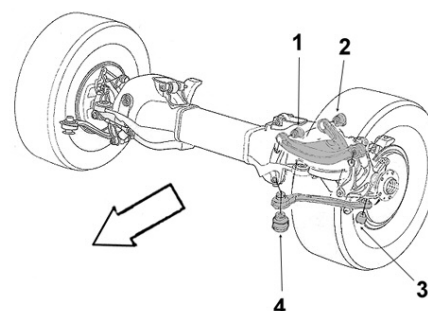

9001778 **Articulation bras inf.**
 OE 33326775552 *Lower arm bush*



3	Ø int.14 Ø ext.47 long. tube int.55 ext.25		09/04-
	1.6i 116	BVM BVA	09/04-
	2.0i 116 118 120	BVM6	09/04-
	2.0 D 118D	BVA	07/08-
	2.0 D 118D	BVM6 BVA6	09/04-
	2.0 D 120D 123D	BVM	02/09-
	2.0 TD 116		01/07-
	2.0 TD 118		05/04-
	2.0 TD 120 123		01/06-
	3.0i 130		

Série 1 E82 ...

Eléments DIRECTION
 Steering parts
 Elementos Direcciones
 Elementy układu kierowniczy
 Элементы рулевой системы

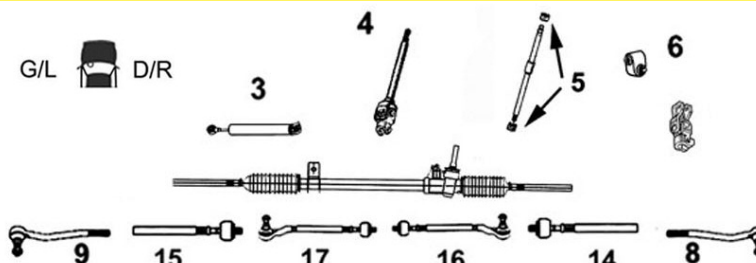

7776018 **Axe de bielle G/D**
 Part/oe 32106765236 *L/R axial joint*



14	Côté dir. M18x1.5 Côté rot. M14x1.5 15 long 255 mm Direction ZF	2.0i 120	10/09-
		2.0 D 118	10/09-
		2.0 D 120	07/08-
		2.0 D 123	11/07-
		2.0 TD 120	11/07-
		3.0i 125	03/08-
		3.0i Turbo 135	11/07-

9006811 **Axe de bielle G/D**
 Part/oe 32216762244 *L/R axial joint*



14	Côté dir. M18x1.5 Côté rot. M14x1.5 15 long 247 mm Direction ZF	2.0 D 118	10/09-
		2.0 D 120	07/08-
		2.0 D 123	11/07-
		2.0 TD 120	11/07-

... Série 1 E82 ...

SASIC

BMW

Eléments DIRECTION
Steering parts
Elementos Direcciones
Elementy układ kierowniczy
Элементы рулевой системы

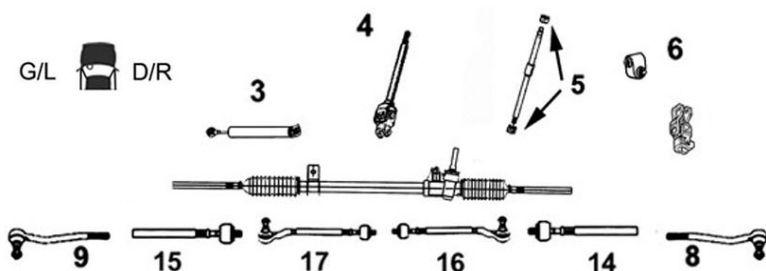

7676017 Rotule de direction G

OE 32106765089 *Left tie rod end*

NEW



9 M14 x 1.5 Direction ZF

2.0i 120	10/09-
2.0 D 118	10/09-
2.0 D 120	07/08-
2.0 D 123	11/07-
2.0 TD 120	11/07-
3.0i 125	03/08-
3.0i Turbo 135	11/07-

7676015 Rotule de direction D

OE 32106765090 *Right tie rod end*



8 M14 x 1.5 Direction ZF

2.0i 120	10/09-
2.0 D 118	10/09-
2.0 D 120	07/08-
2.0 D 123	11/07-
2.0 TD 120	11/07-
3.0i 125	03/08-
3.0i Turbo 135	11/07-



Barre stabilisatrice
Stabilizer bar
Barra estabilizadora
Drażek stabilizatora
стабилизатор поперечной устойчивости

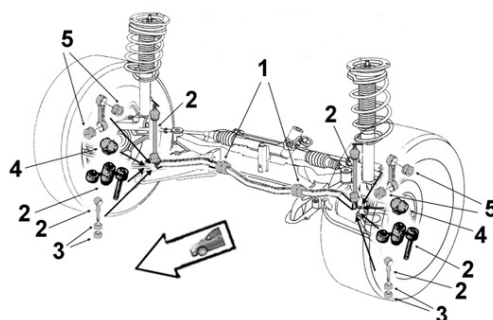

2306062 Bielle barre stab. G

OE 31356765933 *Left stabilizer bar stub axle*



2

2.0i 120	10/09-
2.0 D 118	10/09-
2.0 D 123	11/07-
2.0 TD 120	11/07-
3.0i 125	03/08-
3.0i Turbo 135	11/07-

2306061 Bielle barre stab. D

OE 31356765934 *Right stabilizer bar stub axle*



2

2.0i 120	10/09-
2.0 D 118	10/09-
2.0 D 123	11/07-
2.0 TD 120	11/07-
3.0i 125	03/08-
3.0i Turbo 135	11/07-



Eléments SUSPENSION
Suspension parts
Elementos suspensión
Elementy zawieszenie
Элементы подвески

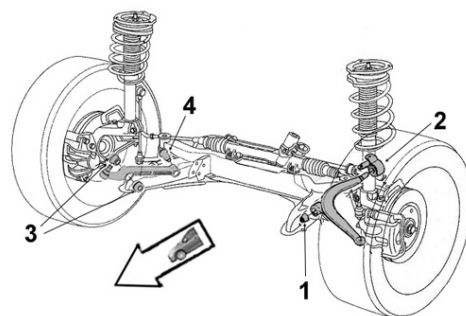

9003106 Articulation AV Bras

OE 31120393540 *Arm front bush*



4 Ø int.12 Ø ext.70 long. tube int.76 ext.64

2.0 D 120D 123D	11/07-
2.0 TD 120	11/07-
3.0i 125 135	11/07-

... Série 1 E82 ...

Bras & Triangle de suspension

Control arm
Brazo y triángulo
Wahacz
Рычаг подвески

G/L  D/R

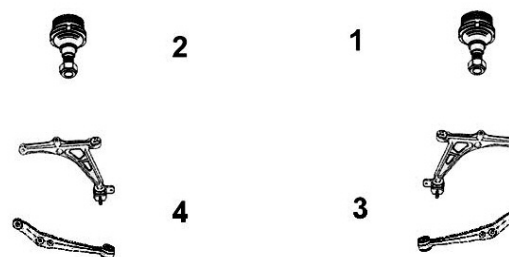

BMW

SASIC

7476093

Bras de susp. AR inf. G

OE 31126770849 *Left rear lower track control arm*

NEW



3 Avec rotule With ball joint

2.0i 120	10/09-
2.0 D 118 120 123	11/07-
2.0 TD 120	11/07-
3.0i 125	03/08-
3.0i Turbo 135	11/07-

7476094

Bras de susp. AR inf. D

OE 31126770850 *Right rear lower track control arm*

NEW



3 Avec rotule With ball joint

2.0i 120	10/09-
2.0 D 118 120 123	11/07-
2.0 TD 120	11/07-
3.0i 125	03/08-
3.0i Turbo 135	11/07-

7476009

Bras de susp. AV inf. G

OE 31126769797 *L front lower track control arm*



4 Avec rotule With ball joint

2.0i 120 Direction ZF	10/09-
2.0 D 118	10/09-
2.0 D 120	07/08-
2.0 D 123	11/07-
2.0 TD 120	11/07-
3.0i 125	03/08-
3.0i Turbo 135	11/07-

7476008

Bras de susp. AV inf. D

OE 31126769798 *R front lower track control arm*



3 Avec rotule With ball joint

2.0i 120 Direction ZF	10/09-
2.0 D 118	10/09-
2.0 D 120	07/08-
2.0 D 123	11/07-
2.0 TD 120	11/07-
3.0i 125	03/08-
3.0i Turbo 135	11/07-



Support d'amortisseur

Suspension mounting
Soporte amortiguador
Poduszka amortyzatora
Опора амортизатора

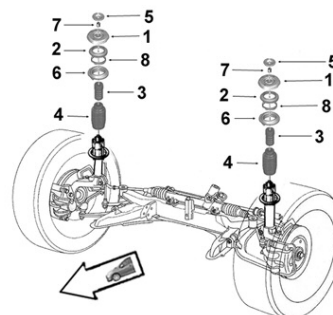

9001422

Support suspension G/D

OE 31336770568 *L/R suspension mounting*



1 Avec roulement With bearing

2.0i 120	10/09-
2.0 D 118	10/09-
2.0 D 123	04/08-
3.0i Turbo 135	04/08-

... Série 1 E82



Barre stabilisatrice
 Stabilizer bar
 Barra estabilizadora
 Drażek stabilizatora
 стабилизатор поперечной устойчивости

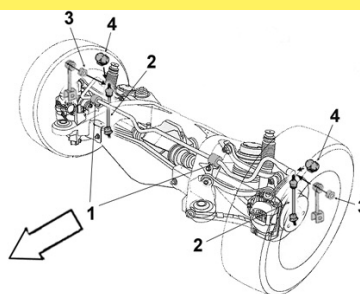

9005029 **Biellette barre stab.**
 OE 33556764428 *Stabilizer bar stub axle*



2

2.0i 120
 2.0 D 118
 2.0 D 120 123
 2.0 TD 120
 3.0i 125 135
 3.0i Turbo 135

10/09-
 11/07-
 11/07-
 11/07-
 11/07-
 11/07-
 03/10-



Eléments SUSPENSION
 Suspension parts
 Elementos suspensión
 Elementy zawieszenie
 Элементы подвески

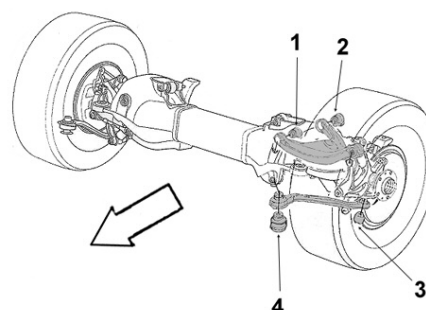

9001778 **Articulation bras inf.**
 OE 33326775552 *Lower arm bush*



3 Ø int.14 Ø ext.47 long.tube int.55 ext.25

2.0i 120 E82
 2.0 D 118 120 123
 2.0 TD 120
 3.0i 125
 3.0i Turbo 135

10/09-
 11/07-
 11/07-
 03/08-
 11/07-

Série 1 E88 ...

Eléments DIRECTION
 Steering parts
 Elementos Direcciones
 Elementy układ kierowniczy
 Элементы рулевой системы

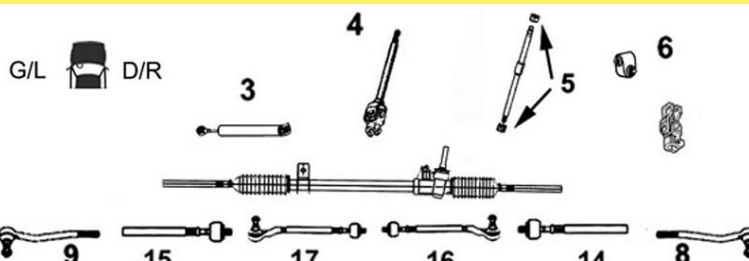

7776018 **Axe de bielle G/D**
 Part/oe 32106765236 *L/R axial joint*



14 Côté dir. M18x1.5 Côté rot. M14x1.5
 15 long 255 mm Direction ZF

2.0i 118
 2.0i 120
 2.0 D 118 120 123
 2.0 TD 120
 3.0i 125
 3.0i Turbo 135

03/08-
 03/08-
 03/08-
 03/08-09/08
 03/08-
 03/08-

9006811 **Axe de bielle G/D**
 Part/oe 32216762244 *L/R axial joint*



14 Côté dir. M18x1.5 Côté rot. M14x1.5
 15 long 247 mm Direction ZF

2.0 D 118 120 123
 2.0 TD 120

07/08-
 03/08-09/08

... Série 1 E88 ...

BMW

SASIC

7676017 OE 32106765089	Rotule de direction G <i>Left tie rod end</i>	7676015 OE 32106765090	Rotule de direction D <i>Right tie rod end</i>
	9 M14x1.5 Direction ZF 2.0i 118 03/08- 2.0i 120 03/08- 2.0 D 118 120 07/08- 2.0 D 123 03/08- 2.0 TD 120 03/08-09/08 3.0i 125 03/08- 3.0i Turbo 135 03/08-		8 M14x1.5 Direction ZF 2.0i 118 03/08- 2.0i 120 03/08- 2.0 D 118 120 07/08- 2.0 D 123 03/08- 2.0 TD 120 03/08-09/08 3.0i 125 03/08- 3.0i Turbo 135 03/08-

Barre stabilisatrice
Stabilizer bar
Barra estabilizadora
Drażek stabilizatora
стабилизатор поперечной устойчивости

2306062 OE 31356765933	Biellette barre stab. G <i>Left stabilizer bar stub axle</i>	2306061 OE 31356765934	Biellette barre stab. D <i>Right stabilizer bar stub axle</i>
	2 2.0i 118 120 03/08- 2.0 D 118 120 07/08- 2.0 D 123 07/08- 2.0 TD 120 03/08-09/08 3.0i 125 03/08- 3.0i Turbo 135 03/08-		2 2.0i 118 120 03/08- 2.0 D 118 120 07/08- 2.0 D 123 07/08- 2.0 TD 120 03/08-09/08 3.0i 125 03/08- 3.0i Turbo 135 03/08-

Eléments SUSPENSION
Suspension parts
Elementos suspensión
Elementy zawieszenie
Элементы подвески

9003106 OE 31120393540	Articulation AV Bras <i>Arm front bush</i>
	4 Ø int.12 Ø ext.70 long. tube int.76 ext.64 2.0i 118 120 03/08- 2.0 D 123 03/08- 2.0 TD 120 03/08-09/08 3.0i 125 03/08- 3.0i Turbo 135 03/08-

... Série 1 E88 ...

SASIC

BMW

Bras & Triangle de suspension

Control arm
Brazo y triángulo
Wahacz
Рычаг подвески

G/L  D/R

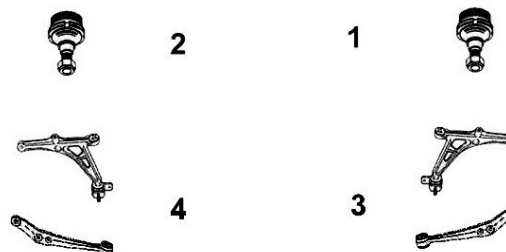

7476093

Bras de susp. AR inf. G

OE 31126770849

Left rear lower track control arm

NEW



4 Avec rotule *With ball joint*

2.0i 118 120	03/08-
2.0 D 118 120 123	03/08-
2.0 TD 120	03/08-09/08
3.0i 125/ Turbo 135	03/08-

7476094

Bras de susp. AR inf. D

OE 31126770850

Right rear lower track control arm

NEW



3 Avec rotule *With ball joint*

2.0i 118 120	03/08-
2.0 D 118 120 123	03/08-
2.0 TD 120	03/08-09/08
3.0i 125/ Turbo 135	03/08-

7476009

Bras de susp. AV inf. G

OE 31126769797

L front lower track control arm



4 Avec rotule *With ball joint*

2.0i 118	03/08-
2.0i 120	03/08-
2.0i 120 170hp 125kw	03/08-
2.0 D 118 120 123	07/08-
2.0 TD 120	03/08-09/08
3.0i 125	03/08-
3.0i Turbo 135	03/08-

7476008

Bras de susp. AV inf. D

OE 31126769798

R front lower track control arm



3 Avec rotule *With ball joint*

2.0i 118	03/08-
2.0i 120	03/08-
2.0i 120 170hp 125kw	03/08-
2.0 D 118 120 123	07/08-
2.0 TD 120	03/08-09/08
3.0i 125	03/08-
3.0i Turbo 135	03/08-



Support d'amortisseur

Suspension mounting
Soporte amortiguador
Poduszka amortyzatora
Опора амортизатора

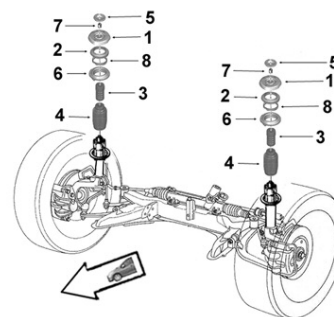

9001422

Support suspension G/D

OE 31336770568

L/R suspension mounting



1 Avec roulement *With bearing*

2.0i 118 120	03/08-
2.0 D 118 120 123	07/08-
2.0 TD 120	03/88-09/08
3.0i 125	03/08-
3.0i Turbo 135	03/08-

... Série 1 E88



Barre stabilisatrice
 Stabilizer bar
 Barra estabilizadora
 Drażek stabilizatora
 стабилизатор поперечной устойчивости

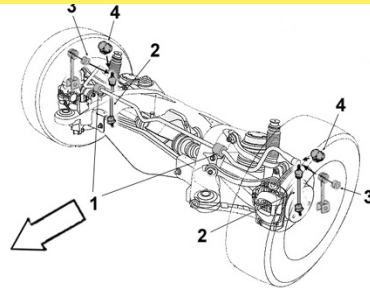

9005029 **Biellette barre stab.**
 OE 33556764428 *Stabilizer bar stub axle*



2

2.0i 118 120
 2.0 D 118 120
 2.0 D 123
 2.0 TD 120
 3.0i 125
 3.0i Turbo 135

03/08-
 07/08-
 03/08-
 03/08-09/08
 03/08-
 03/08-



Eléments SUSPENSION
 Suspension parts
 Elementos suspensión
 Elementy zawieszenie
 Элементы подвески

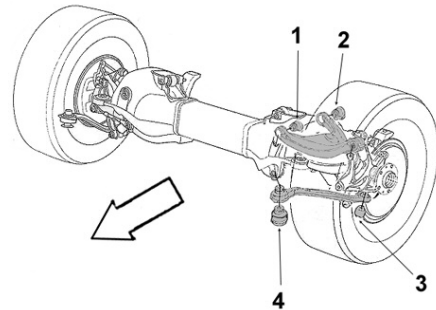

9001778 **Articulation bras inf.**
 OE 33326775552 *Lower arm bush*



3

Ø int.14 Ø ext.47 long.tube int.55 ext.25

2.0i 118 120
 2.0 D 118 120
 2.0 D 123
 2.0 TD 120
 3.0i 125
 3.0i Turbo 135

03/08-
 07/08-
 03/08-
 03/08-09/08
 03/08-
 03/08-

Série 3 E21

Bras & Triangle de suspension

Control arm
 Brazo y triángulo
 Wahacz
 Рычаг подвески

G/L D/R

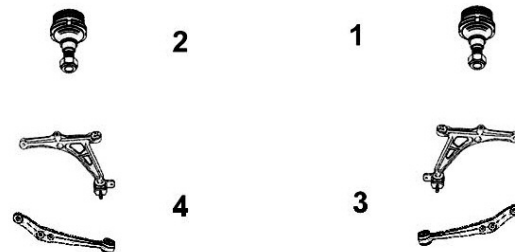

9005163 **Bras de susp. G**
 OE 31121123025 *Left track control arm*



4

Avec rotule *With ball joint*

TT /all models 10/78-12/83

9005162 **Bras de susp. D**
 OE 31121123026 *Right track control arm*



3

Avec rotule *With ball joint*

TT /all models 10/78-12/83

Série 3 E30 ...

Eléments DIRECTION

Steering parts

Elementos Direcciones

Elementy układ kierowniczy

Элементы рулевой системы

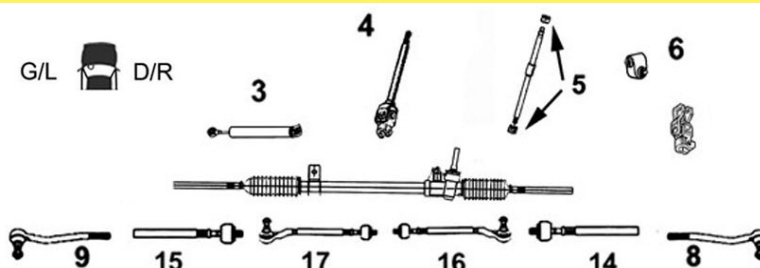

9006253

Axe de bielle G

OE 32111130449

Left axial joint

15 Côté dir. M18x1.5 Côté rot. M14x1.5
long 229 mm

TT /all models Sauf 325 iX 4WD



9006254

Axe de bielle D

OE 32111130451

Right axial joint

14 Côté dir. M18x1.5 Côté rot. M14x1.5
long 228 mm

TT /all models Sauf 325 iX 4WD



9006320

Rotule de direction G/D

OE 32111126757

L/R tie rod end

8
9 M14 x 1.5

TT /all models Sauf 4WD



Barre stabilisatrice

Stabilizer bar

Barra estabilizadora

Drażek stabilizatora

стабилизатор поперечной устойчивости

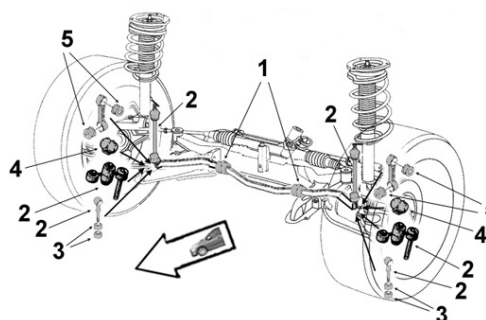

9005053

Biellette barre stab.

OE 31351091764

Stabilizer bar stub axle

2

TT /all models sauf M3



9001566

Palier de barre milieu

OE 31351127414

Middle bar main bearing

1 Barre Ø 18.5

TT /all models sauf M3 -06/91



9001567

Palier de barre milieu

OE 31351129139

Middle bar main bearing

1 Barre Ø 20

TT /all models sauf M3

-06/91



... Série 3 E30 ...



Eléments SUSPENSION
Suspension parts
Elementos suspensión
Elementy zawieszenie
Элементы подвески

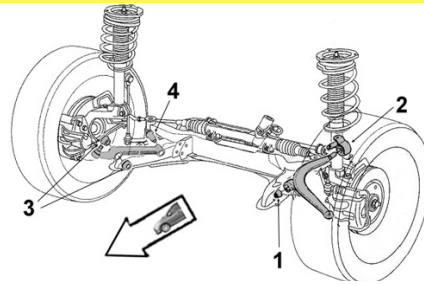

BMW



9001555 Articulation AR

OE 31129058815 *Rear bush*



2 Ø int.18 Ø ext.60 long. tube int.33 ext.33

TT /all models

Bras & Triangle de suspension

Control arm
Brazo y triángulo
Wahacz
Рычаг подвески

G/L D/R



9005166 Triangle de susp. G

OE 31121127725 *Left track control arm*



4 Avec rotule With ball joint

TT /all models Sauf 325 iX 4WD

9005164 Triangle de susp. D

OE 31121127726 *Right track control arm*



3 Avec rotule With ball joint

TT /all models Sauf 325 iX 4WD

9005220 Rotule de susp. inf. G/D Ext.

OE 31121126254 *Outer L/R lower susp. ball joint*



1
2

TT /all models Sauf 325 iX 4WD

9005221 Rotule de susp. inf. G/D

OE 31121126253 *L/R lower suspension ball joint*



1
2

TT /all models Sauf 325 iX 4WD

... Série 3 E30 ...

SASIC



Support d'amortisseur
 Suspension mounting
 Soporte amortiguador
 Poduszka amortyzatora
 Опора амортизатора

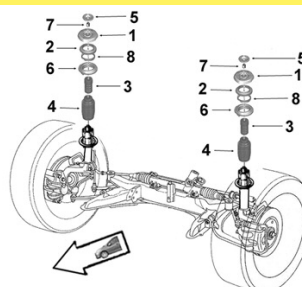

9001420 **Support suspension G/D**
 OE 31331139452 L/R suspension mounting

1 Avec roulement With bearing



TT /all models sauf M3

-10/93



Barre stabilisatrice
 Stabilizer bar
 Barra estabilizadora
 Drażek stabilizatora
 стабилизатор поперечной устойчивости

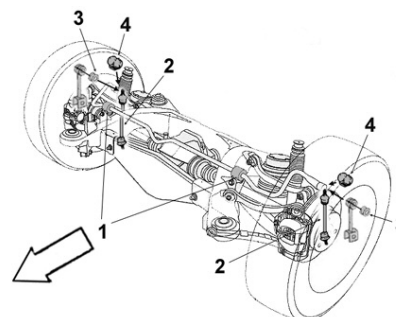

9005060 **Biellette barre stab.**
 OE 33551126932 Stabilizer bar stub axle

2



TT /all models

Eléments TRAIN ARRIERE

Rear axle parts
 Tren TRAS
 Elementy zawieszenia tylnego
 элементы задней оси.



9001560 **Articulation AR**
 OE 33329061945 Rear bush

Ø int.12 Ø ext.29 coll.35
 long. tube int.70 ext.48 ep. coll.7



TT /all models

9001557 **Articulation essieu AR**
 OE 33311129144 Rear axle bush

Ø int.15 Ø ext.59 coll.77
 long. tube int.104 ext.72 ep. coll.6



TT /all models

... Série 3 E30

9001417 Articulation essieu AR

OE 33171135242 *Rear axle bush*



Ø int.13 Ø ext.84 long. tube int.34 ext.30

TT /all models

Série 3 E36 ...

Eléments DIRECTION

Steering parts

Elementos Direcciones

Elementy układ kierowniczy

Элементы рулевой системы

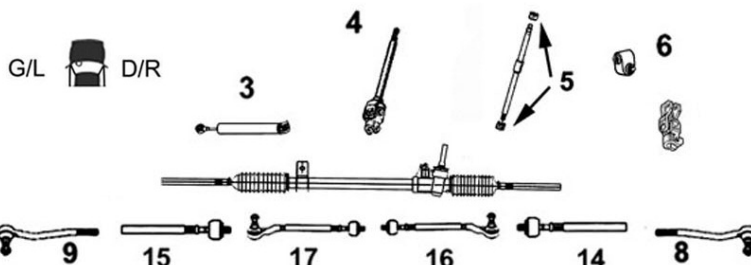

9006257 Axe de bielle G/D

Part/oe 32111139316 *L/R axial joint*

14 Côté dir. M18x1.5 Côté rot. M14x1.5
15 long 205 mm



TT /all models DA



Barre stabilisatrice

Stabilizer bar

Barra estabilizadora

Drażek stabilizatora

стабилизатор поперечной устойчивости

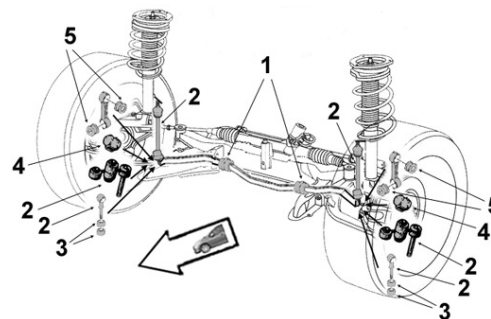

9005058 Biellette barre stab.

OE 31351134582 *Stabilizer bar stub axle*



2

1.6i 316	-10/91
1.8i 318/i	-10/91
2.0i 24v. 320	-10/91
2.5i 24v. 323i	
2.5i 24v. 325i /Coupé	-10/91
2.8i 24v. 328 /Cab.	-10/91

9005053 Biellette barre stab.

OE 31351091764 *Stabilizer bar stub axle*



2

1.6i 316 /Touring /Coupé	11/91-
1.7 TDs 318 /Touring	11/91-
1.8i 318 /Touring /Cab.	11/91-
1.8i 318i /16v. 318i	11/91-
1.9i 16v. 318iS /Coupé	
2.0i 24v. 320	11/91-
2.5i 24v. 323Ti /Touring /Coupé	
2.5i 24v. 325i	11/91-
2.5 TDS 325TDS /Touring	10/91-04/98
2.8i 24v. 328	11/91-

... Série 3 E36 ...



Eléments SUSPENSION

Suspension parts

Elementos suspensión

Elementy zawieszenie

Элементы подвески

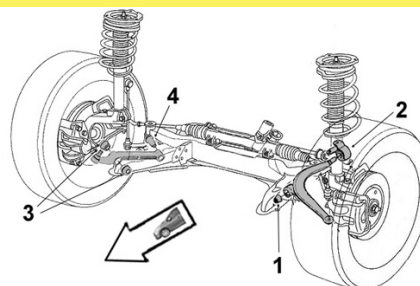

SASIC

BMW

9001777

Articulation AR

OE 31129059288

Rear bush



2 Ø int.18 Ø ext.60.5 long. tube int.34 ext.33

1.6i 316
1.7 TDS 318
1.8i 16v. 318i /is /Ti
1.9i 16v. 318is
2.0i 24v. 320
2.5i 323 /Ti 2.5i 325
2.5 TDS 325TDS
2.8i 328

Bras & Triangle de suspension

Control arm
Brazo y triángulo
Wahacz
Рычаг подвески

G/L  D/R

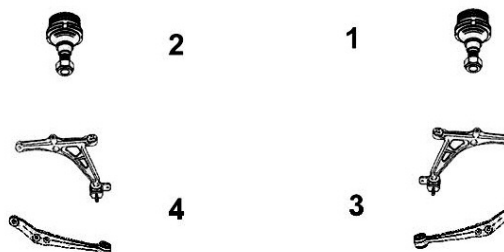

7476021

Triangle de susp. G

OE 31126758513

Left track control arm

4 Avec rotule With ball joint

1.6i 316 /Touring /Coupé 09/90-06/99
1.7 TDS 318 /Touring 10/94-12/00
1.8i 318 12/90-02/98
1.8i 16v. 318 /Touring /Cab. /Coupé 07/94-02/98
1.9i 316 07/99-12/00
1.9i 16v. 318 /Coupé 01/96-06/99
2.0i 320 /Touring /Cab. /Coupé 05/91-02/98
2.5i 323 /Touring /Coupé 06/95-12/00
2.5i 325 Coupé 03/92-06/95
2.5 TDs 325 /Touring 10/91-04/98
2.8i 328 /Cab. /Coupé 01/91-06/95



7476020

Triangle de susp. D

OE 31126758514

Right track control arm

3 Avec rotule With ball joint

1.6i 316 /Touring /Coupé 09/90-06/99
1.7 TDS 318 /Touring 10/94-12/00
1.8i 318 12/90-02/98
1.8i 16v. 318 /Touring /Cab. /Coupé 07/94-02/98
1.9i 316 07/99-12/00
1.9i 16v. 318 /Coupé 01/96-06/99
2.0i 320 /Touring /Cab. /Coupé 05/91-02/98
2.5i 323 /Touring /Coupé 06/95-12/00
2.5i 325 Coupé 03/92-06/95
2.5 TDs 325 /Touring 10/91-04/98
2.8i 328 /Cab. /Coupé 01/91-06/95



9005222

Rotule de susp. inf. G/D Ext.

OE 31121140398

Outer L/R lower susp. ball joint

1/2

TT /all models

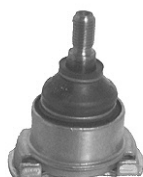

9005223

Rotule de susp. inf. G/D

OE 31121139131

L/R lower suspension ball joint

1/2

TT /all models



... Série 3 E36 ...





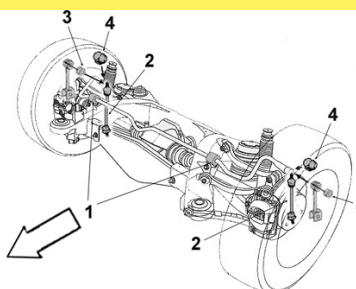

Barre stabilisatrice
 Stabilizer bar
 Barra estabilizadora
 Drażek stabilizatora
 стабилизатор поперечной устойчивости



BMW



9005060 Biellette barre stab. OE 33551126932 <i>Stabilizer bar stub axle</i>	
 2	1.6i 316 /Touring /Coupé 1.7 TDS 318 /Touring 1.8i 318 /Touring /Cab. /Coupé 1.8i 318is 1.9i 318/is 2.0i 320 2.5i 323i 325i 2.5 TDS 325TDS
	2.8i 328i 3.0i M3 3.0i M3 Cab. 3.0i M3 Coupé 3.2i M3 3.2i M3 Cab. 3.2i M3 Coupé
	11/94-06/95 07/94-01/96 02/93-06/95 07/95-02/98 07/96-04/00 11/95-04/99
9005061 Biellette barre stab. OE 33551135307 <i>Stabilizer bar stub axle</i>	
 2	1.9i 318ti 2.5i 323Ti
9001570 Palier de barre milieu OE 33551131155 <i>Middle bar main bearing</i>	
 1	Barre Ø 15 1.6i 316 Touring 1.7 TDS 318 Touring 1.8i 318i /is 1.9i 316i 318i/is 2.0i 320i 2.5i 323i 325i 2.5 TDS 325TDS 2.8i 328i /Touring 3.2i 24v. M3
9001572 Palier de barre milieu OE 33551138104 <i>Middle bar main bearing</i>	
 1	Barre Ø 18 1.6i 316 1.8i 318 /16v. 318i 1.9i 316i 1.9i 16v. 318iS 2.0i 320i 2.5i 24v. 323i 325i 2.5 TDS 325TDS 2.8i 24v. 328i

Eléments TRAIN ARRIERE

Rear axle parts
 Tren TRAS
 Elementy zawieszenia tylnego
 элементы задней оси.

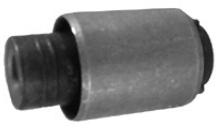

2256059 Articulation AR sup. côté ext. OE 33326775551 <i>Upper rear bush Outer side</i>	
 1	Ø int.12 Ø ext.45 long. tube int.56.5 ext.24 1.6i 316 09/90-08/00 1.7 TDS 318 01/95-08/00 1.8i 318i /IS /TI 12/90-08/00 2.0 320i 09/90-02/98 2.5i 323i /Ti 03/95-08/00 2.5i 325i 09/90-09/95 2.5 TDS 325 TDS 09/91-02/98 2.8 328i 01/95-02/98 3.0i M3 10/92-09/95 3.2i M3 09/95-04/99
9001563 Articulation AR sup. côté int. OE 33321092247 <i>Upper rear bush Inner side</i>	
 1	Ø int.12 Ø ext.35 long. tube int.66 ext.42 1.7 TDS 318 -04/99 1.8i 16v. 318i -04/99 2.0i 24v. 320i -04/99 2.5i 24v. 323i 325i -04/99 2.5 TDS 325TDS -04/99 2.8i 24v. 328i -04/99 3.0i 24v. M3 -04/99 3.2i 24v. M3 -04/99

... Série 3 E36

SASIC

Eléments TRAIN ARRIERE

Rear axle parts

Tren TRAS

Elementy zawieszenia tylnego

элементы задней оси.



BMW

9001564 Articulation AR inf. coté int.

OE 33326770824 Lower rear bush inner side



Ø int.12 Ø ext.35 long. tube int.57 ext.42

1.6i 316	-04/99
1.7 TDS 318	-04/99
1.8i 318i / 16v. 318i	-04/99
1.9i 16v. 318i	-04/99
2.0i 24v. 320i	-04/99
2.5i 24v. 323i 325i	-04/99
2.5 TDS 325TDS	-04/99
2.8i 24v. 328i	-04/99
3.0i 24v. M3	-04/99
3.2i 24v. M3	-04/99

9001414 Articulation AR G/D

OE 33326770786 L/R rear bush



Ø int.12.5 Ø ext.61.5 long. tube int.49 ext.40

1.6i 316	09/90-04/99
1.7 TDS 318	10/94-04/98
1.8i 318i/ 16v. 318i	09/90-04/99
1.9i 16v. 318i	09/90-04/99
2.0i 24v. 320i	09/90-04/99
2.5i 24v. 323i 325i	09/90-04/99
2.5 TDS 325TDS	10/91-04/98
2.8i 24v. 328i	09/90-04/99
3.0i 24v. M3	09/90-04/99

9001559 Articulation inf. AR coté ext.

OE 33326771828 Rear lower bush Outer side



Ø int.12 Ø ext.45 long. tube int.57 ext.31

1.6i 316	-04/99
1.7 TDS 318	-04/99
1.8i 318i /16v. 318i	-04/99
1.9i 16v. 318i	-04/99
2.0i 24v. 320i	-04/99
2.5i 24v. 323i 325i	-04/99
2.5 TDS 325TDS	-04/99
2.8i 24v. 328i	-04/99
3.0i 24v. M3	-04/99
3.2i 24v. M3	-04/99

9001563 Articulation AR sup. côté int.

OE 33321092247 Upper rear bush Inner side



Ø int.12 Ø ext.35 long. tube int.66 ext.42

1.6i 316	-04/99
1.8i 318i	-04/99
1.9i 16v. 318i	-04/99

9001419 Art. support pont

OE 33171134872 Axle mounting bush



Ø int.13 Ø ext.50 long. tube int.30 ext.30

1.6i 316	
1.7 TDS 318	
1.8i 318i	
1.9i 316i 318i	
2.0i 320i	
2.5i 323i 325i	
2.5 TDS 325TDS	
2.8i 328i	
3.2i 24v. M3	

Série 3 E46 ...

Eléments DIRECTION

Steering parts

Elementos Direcciones

Elementy układ kierowniczy

Элементы рулевой системы

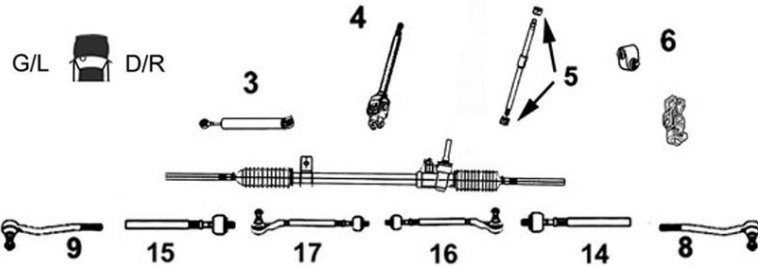

9006817 Axe de bielle G/D

Part/oe 32106777503 L/R axial joint

14 Côté dir. M18x1.5 Côté rot. M14x1.5 long 207 mm
15



1.6i 316 Coupé	07/99-03/03
1.8i 316/ 318 /Compact /Touring	09/98-
1.9i 316 4ptes	09/98-
1.9i 318 / Touring /4ptes /Coupé	09/98-
2.0i 318 4ptes	
2.0i Compact 318 /Touring	09/98-
2.0i 318Ci Coupé /Cab.	09/98-
2.0i 320 Touring / 4ptes	09/98-
2.0 TD 318D 4ptes	
2.0 TD Compact 318d	9/98-
2.0 TD 318D Touring	
2.0 TD 320D 4ptes	09/98-
2.0 TD Compact 320d	09/98-
2.0 TD 320CD Coupé	
2.0 TD 320D Touring	09/01-09/05
2.2i 320 /Touring / Coupé	09/98-
2.2i 320 /Cab.	
2.5i 323	09/98-
2.5i 325	09/98-
2.5i Compact 325	09/98-
2.5i 325Ci Coupé	09/98-
2.5i 325 /Touring	
2.8i 328 Touring / Coupé	09/98-
3.0i 330 4ptes	
3.0i 330Ci Coupé	09/98-
3.0i 330 /Touring /Cab.	09/98-
3.0 D 330d 4ptes	
3.0 D 330 /Touring /Coupé	
3.0 D 330d Touring	

9006257 Axe de bielle G/D

Part/oe 32211095956 L/R axial joint

14 Côté dir. M18x1.5 Côté rot. M14x1.5 long 205 mm
15



1.9i 318 4ptes	-09/98
2.0i 320 4ptes	-09/98
2.0 TD 320D 4ptes	-09/98
2.5i 323 4ptes	-09/98
2.8i 328 4ptes	-09/98

... Série 3 E46 ...

Eléments DIRECTION

Steering parts

Elementos Direcciones

Elementy układ kierowniczy

Элементы рулевой системы

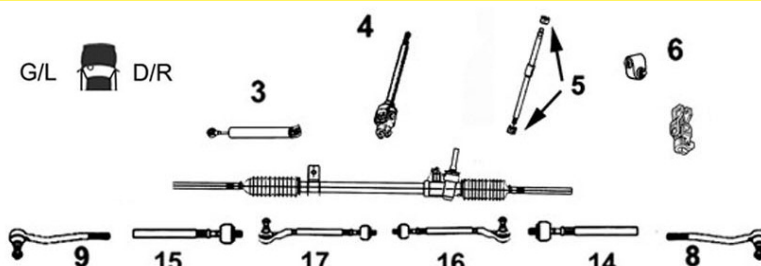

9006429

Rotule de direction G

OE 32106774220

Left tie rod end

9

M14 x 1.5

1.6i Ci Coupé 07/99-03/03
 1.8i Compact 316
 1.9i 316 4ptes
 1.9i 318 Ci Coupé
 1.9i 318 Touring
 2.0i 318 4ptes
 2.0i 318 Compact
 2.0i 318Ci Coupé
 2.0i 318 Touring
 2.0i 320 4ptes
 2.0i 320Ci Coupé
 2.0i 320 Touring
 2.0 D 320 Touring
 2.0 TD 318D 4ptes
 2.0 TD Compact 318d
 2.0 TD 318D Touring
 2.0 TD 320D 4ptes
 2.0 TD Compact 320d
 2.0 TD 320CD Coupé
 2.0 TD 320D Touring
 2.2i 320 4ptes
 2.2i 320 Cab.
 2.2i 320Ci Coupé
 2.2i 320 Touring
 2.5i 323 325 4ptes
 2.5i 323 325Ci Coupé
 2.5i 323 325 Cab.
 2.5i 325 Touring / 4ptes Séq.
 2.5i Compact 325
 2.8i /Ci Coupé
 3.0i 330 Touring / 4ptes
 3.0i 330Ci Coupé /Cab.
 3.0 D 330d 4ptes /Touring
 3.0 D 330d Coupé



9006428

Rotule de direction D

OE 32106774221

Right tie rod end

8

M14 x 1.5

1.6i Ci Coupé 07/99-03/03
 1.8i Compact 316
 1.9i 316 4ptes
 1.9i 318 Ci Coupé
 1.9i 318 Touring
 2.0i 318 4ptes
 2.0i 318 Compact
 2.0i 318Ci Coupé
 2.0i 318 Touring
 2.0i 320 4ptes
 2.0i 320Ci Coupé
 2.0i 320 Touring
 2.0 D 320 Touring
 2.0 TD 318D 4ptes
 2.0 TD Compact 318d
 2.0 TD 318D Touring
 2.0 TD 320D 4ptes
 2.0 TD Compact 320d
 2.0 TD 320CD Coupé
 2.0 TD 320D Touring
 2.2i 320 4ptes
 2.2i 320 Cab.
 2.2i 320Ci Coupé
 2.2i 320 Touring
 2.5i 323 325 4ptes
 2.5i 323 325Ci Coupé
 2.5i 323 325 Cab.
 2.5i 325 Touring / 4ptes Séq.
 2.5i Compact 325
 2.8i /Ci Coupé
 3.0i 330 Touring / 4ptes
 3.0i 330Ci Coupé /Cab.
 3.0 D 330d 4ptes /Touring
 3.0 D 330d Coupé



Barre stabilisatrice

Stabilizer bar

Barra estabilizadora

Drażek stabilizatora

стабилизатор поперечной устойчивости

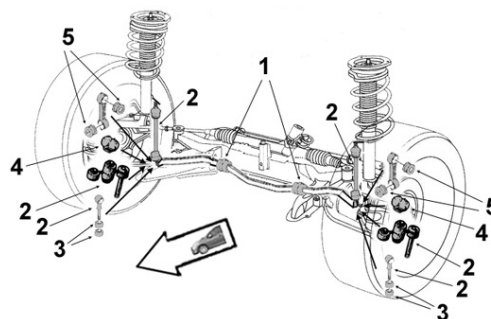

9005057

Biellette barre stab.

OE 31356780847

Stabilizer bar stub axle

2

1.6i 316 /Compact /Touring /Cab. /Coupé 07/99-
 1.8i 316 Compact
 1.8i 318 /Touring
 1.9i 316 02/98-
 1.9i 318 02/98-
 1.9i 318 /Compact
 2.0i 318
 2.0i 318 /Compact /Cab.
 2.0i 318Ci Coupé
 2.0i 320 02/98-



Suite ...

... Série 3 E46 ...

... 9005057

Biellette barre stab.

OE 31356780847

Stabilizer bar stub axle



2.0 D 318	11/01-03/05
2.0 D 320 Touring	07/99-09/01
2.0 TD 318D /Touring	
2.0 TD 318TD Compact	
2.0 TD 320D	02/98-
2.0 TD 320D Touring	
2.0 TD 320TD Compact	
2.0 TD 320CD	
2.2i 320Ci /Touring	02/98-
2.2i 320	
2.5i 323	02/98-
2.5i 325/Compact	
2.5i 325Ci Coupé	
2.8i 328	02/98-
3.0i 330	
3.0i 330Ci Coupé	
3.0 D 330 /Touring	
3.0 D 330D Touring	
3.0 D 330CD Coupé	
3.2i M3 /Cab. /Coupé	09/00-03/03



Eléments SUSPENSION

Suspension parts

Elementos suspensión

Elementy zawieszenia

Элементы подвески

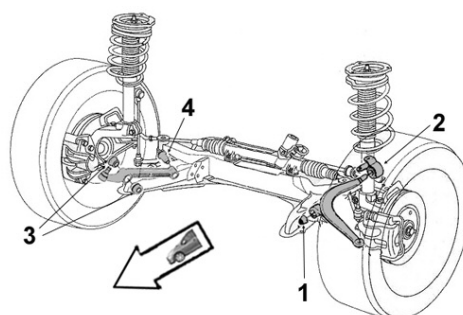

9003109

Articulation triangle G

Part/oe 31126757623 *Left Track control arm bush*

2



1.6i 316 /Compact /Coupé	07/99-
1.8i 316 Compact N42	
1.8i 318 /Touring N45	
1.9i 316	02/01-
1.9i 316 318 M43 BVM	02/01-
1.9i 318 /Compact Coupé Cab. BVM	
1.9i 318 Touring BVA	07/99-09/01
2.0i 318 N46 BVM	
2.0i 318 /Compact /Touring /Cab. N42	03/01-03/04
2.0i 318 Touring N46 BVA	01/04-09/05
2.0i 318Ci Coupé /Cab. N46 BVM	
2.0i 320 M52	
2.0 D 318 M47	11/01-03/05
2.0 D 320 Touring M47	07/99-09/01
2.0 TD 318D M47	
2.0 TD 318D Touring M47	
2.0 TD 318TD Compact	
2.0 TD 320CD Coupé	
2.0 TD 320D M47	
2.0 TD 320D Touring M47	
2.0 TD 320TD Compact	
2.2i 320 M54	
2.2i 320Ci Coupé M54	
2.5i 323 325Ci Coupé Cab.	
2.5i 325 /Cab. Séquentielle	
2.5i 325 Compact	
2.8i 328 /Touring	
2.5i 325Ci Coupé BV5	
3.0i 330 / Séquentielle	
3.0i 330Ci Coupé BVM	
3.0 D 330 BVM	
3.0 D 330 /Touring	
3.0 D 330CD Coupé BVM	

9003108

Articulation triangle D

Part/oe 31126757623 *Right track control arm bush*

2



1.6i 316 /Compact /Coupé	07/99-
1.8i 316 Compact N42	
1.8i 318 /Touring N45	
1.9i 316	02/01-
1.9i 316 318 M43 BVM	02/01-
1.9i 318 /Compact Coupé Cab. BVM	
1.9i 318 Touring BVA	07/99-09/01
2.0i 318 N46 BVM	
2.0i 318 /Compact /Touring /Cab. N42	03/01-03/04
2.0i 318 Touring N46 BVA	01/04-09/05
2.0i 318Ci Coupé /Cab. N46 BVM	
2.0i 320 M52	
2.0 D 318 M47	11/01-03/05
2.0 D 320 Touring M47	07/99-09/01
2.0 TD 318D M47	
2.0 TD 318D Touring M47	
2.0 TD 318TD Compact	
2.0 TD 320CD Coupé	
2.0 TD 320D M47	
2.0 TD 320D Touring M47	
2.0 TD 320TD Compact	
2.2i 320 M54	
2.2i 320Ci Coupé M54	
2.5i 323 325Ci Coupé Cab.	
2.5i 325 /Cab. Séquentielle	
2.5i 325 Compact	
2.8i 328 /Touring	
2.5i 325Ci Coupé BV5	
3.0i 330 / Séquentielle	
3.0i 330Ci Coupé BVM	
3.0 D 330 BVM	
3.0 D 330 /Touring	
3.0 D 330CD Coupé BVM	

... Série 3 E46 ...

Bras & Triangle de suspension

Control arm
Brazo y triángulo
Wahacz
Рычаг подвески

G/L  D/R

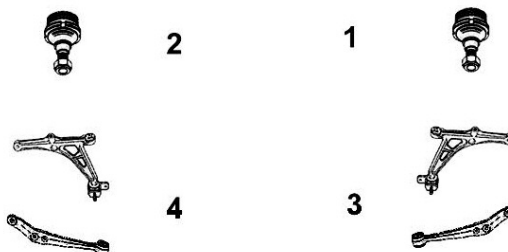

BMW

9005683

Triangle de susp. G

OE 31126777851

Left track control arm

4 Avec rotule With ball joint

1.6i 316 Coupé N40B16 M43B16 11/02-
1.8i Compact 316 sauf Sport N42 N46 BVM BVA
1.9i 318 Ci Coupé M43 BVM BVA 11/99-09/01
2.0i 318 4ptes N42 N46
2.0i 318Ci Coupé sauf Sport N46
2.0i 318 Touring N42 N46 09/01-
2.0i 320 4ptes M52 BVM 07/99-
2.0i 320 4ptes M52 BVA
2.0i 320Ci Coupé M52 04/99-
2.0i 320 Touring M52 BVM BVA 07/99-07/00
2.0 D 318d 4ptes M47D
2.0 D 318 320 Touring M47D 07/99-02/05
2.0 TD 318D 4ptes M47 -07/99
2.0 TD Compact 318d -07/99
2.0 TD 318D Touring M47N -03/03
2.0 TD Compact 320d -02/05
2.0 TD 320CD Coupé BVM
2.2i 320 4ptes M54 BVM 07/99-
2.2i 320 /Touring /Cab. /Coupé M54 BVM BVA
2.5i 323 Ci Coupé BVM BVA 04/99-03/03
2.5i 323 325 Cab. 04/00-03/03
2.5i 325 4ptes
2.5i Compact 325 BVM BVA
2.8i 328/Touring/4ptes/Coupé BVM
3.0i 330 4ptes
3.0i Cab.
3.0 D 330d 4ptes M57 BVM BVA
3.0 D 330CD Coupé BVM
3.0 D 330d Touring M57



OE 31122282121

1.8i Compact 316 Sport N42 N46 BVM
1.8i Compact 316 Sport N42 N46 BVA 07/99-
2.0i Compact 318 N42 BVM BVA
2.0i 318Ci Sport Coupé N46 BVM
3.0i 330Ci Coupé

OE 31126770247

1.9i 316 4ptes BVM BVA
1.9i 318 4ptes M43 BVM BVA
2.0 TD 320D 4ptes M47 -09/01
2.5i 323 4ptes BVM BVA
2.8i 328 4ptes BVA

9005682

Triangle de susp. D

OE 31126777852

Right track control arm

3 Avec rotule With ball joint

1.6i 316 Coupé N40B16 M43B16 11/02-
1.8i Compact 316 sauf Sport N42 N46 BVM BVA
1.9i 318 Ci Coupé M43 BVM BVA 11/99-09/01
2.0i 318 4ptes N42 N46
2.0i 318Ci Coupé sauf Sport N46
2.0i 318 Touring N42 N46 09/01-
2.0i 320 4ptes M52 BVM 07/99-
2.0i 320 4ptes M52 BVA
2.0i 320Ci Coupé M52 04/99-
2.0i 320 Touring M52 BVM BVA 07/99-07/00
2.0 D 318d 4ptes M47D
2.0 D 318 320 Touring M47D 07/99-02/05
2.0 TD 318D 4ptes M47 -07/99
2.0 TD Compact 318d -07/99
2.0 TD 318D Touring M47N -03/03
2.0 TD Compact 320d -02/05
2.0 TD 320CD Coupé BVM
2.2i 320 4ptes M54 BVM 07/99-
2.2i 320 /Touring /Cab. /Coupé M54 BVM BVA
2.5i 323 Ci Coupé BVM BVA 04/99-03/03
2.5i 323 325 Cab. 04/00-03/03
2.5i 325 4ptes
2.5i Compact 325 BVM BVA
2.8i 328/Touring/4ptes/Coupé BVM
3.0i 330 4ptes
3.0i Cab.
3.0 D 330d 4ptes M57 BVM BVA
3.0 D 330CD Coupé BVM
3.0 D 330d Touring M57



OE 31122282122

1.8i Compact 316 Sport N42 N46 BVM
1.8i Compact 316 Sport N42 N46 BVA 07/99-
2.0i 318Ci Sport Coupé N42 N46 BVM
3.0i 330Ci Coupé

OE 31126770248

1.9i 316 4ptes BVM BVA
1.9i 318 4ptes M43 BVM BVA
2.0 TD 320D 4ptes M47 -09/01
2.5i 323 4ptes BVM BVA
2.8i 328 4ptes BVA

... Série 3 E46 ...



Support d'amortisseur

Suspension mounting
Soporte amortiguador
Poduszka amortyzatora
Опора амортизатора

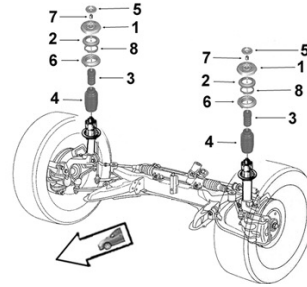

BMW



9001422

Support suspension G/D

OE 31336770568

L/R suspension mounting

1 Avec roulement With bearing

1.6i 316 /Touring /Coupé			06/00-
1.8i 316			
1.8i 316 Compact	N42		-11/03
1.9i 316			-11/03
1.9i 318	M43		
2.0i 318 / Compact /Cab. /Coupé	N42		-11/03
2.0i 318/ Ci Coupé			11/03-
2.0i 320 /Touring	M52		-11/03
2.0i 320CD Coupé /Cab.			-11/03
2.0i 320	M52		11/03-
2.0 D 318D 320D	M47		-11/03
2.0 TD 318TD Compact			-11/03
2.0 TD 318D Touring	M47		-11/03
2.0 TD 318TD Compact			11/03-
2.0 TD 320	M47		
2.0 TD 320 Compact			
2.0 TD 320 Touring	BVM	M47	-11/03
2.2i 320		M54	
2.2i 320Ci Touring Coupé /Cab.		M54	-11/03
2.5i 323 Coupé /Cab.			
2.5i 325 / Compact			
2.5i 325Ci Coupé	BV5		
2.8i 328			
3.0i 330			-11/03
3.0i 330 Séquentielle			
3.0i 330Ci Coupé	BVM		
3.0 D 330D /XD			
3.0 D 330CD	BVM		
3.0 D 330D /XD Touring			-11/03



2656020

Butée de suspension

OE 31336750892

Shock bush

3 H91

1.8i 316 Compact			06/01-12/04
1.8i 316 Touring			01/02-03/04
1.9i 318 Touring	M43		
2.0i 318 /Compact			03/01-12/04
2.0i 318 Touring			09/01-09/05
2.0i 320 Touring			07/99-07/00
2.0 D 318			11/01-03/03
2.0 D 318 320 Touring			07/99-09/01
2.0 TD 318 Touring			01/02-09/05
2.0 TD 320 /compact			09/01-12/04
2.0 TD 320 Touring			09/01-09/05
2.2i 320			09/01-03/05
2.2i 320 Touring			07/00-09/05
2.5i 325			09/01-03/05
2.5i 325 Compact			06/01-03/03
2.5i 325 Touring /4WD			07/00-10/03
2.8i 328 Touring			07/99-09/01
3.0i 330			07/00-09/01
3.0i 330 Touring			09/01-09/05
3.0 D 330			07/99-09/01
3.0 D 330 Touring			09/01-09/05



... Série 3 E46 ...



Barre stabilisatrice

Stabilizer bar

Barra estabilizadora

Drażek stabilizatora

стабилизатор поперечной устойчивости

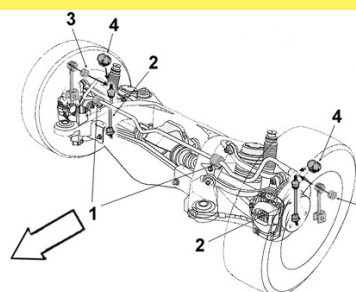

9005030

Biellette barre stab.

OE 33551094619

Stabilizer bar stub axle

- 2**
- 1.6i 316 /Compact /Touring /Cab. /Coupé
 - 1.8i 316 Compact
 - 1.8i 318 /Touring
 - 1.9i 316
 - 1.9i 318
 - 2.0i 318
 - 2.0i 318 Compact Coupé Cab.
 - 2.0i 318/Ci Coupé /Cab.
 - 2.0i 320
 - 2.0 D 318
 - 2.0 D 320 Touring
 - 2.0 TD 318D
 - 2.0 TD 318D Touring
 - 2.0 TD 318TD Compact
 - 2.0 TD 320D
 - 2.0 TD 320D Touring
 - 2.0 TD 320TD Compact
 - 2.0 TD 320CD Coupé
 - 2.2i 320 /Touring /Cab.
 - 2.2i 320Ci Coupé
 - 2.5i 323 /Cab. /Coupé
 - 2.5i 323
 - 2.5i 325 / Séquentielle
 - 2.5i 325 Compact
 - 2.5i 325Ci Coupé
 - 2.8i 32
 - 3.0i 330 /4WD Touring
 - 3.0i 330 Séquentielle
 - 3.0i 330Ci Coupé
 - 3.0 D 330 /Touring /4WD
 - 3.0 D 330D Touring
 - 3.0 D 330XD
 - 3.0 D 330XD Touring
 - 3.0 D 330CD Coupé

11/01-03/05
07/99-09/01

05/98-03/03



9001572

Palier de barre milieu

OE 33551136491

Middle bar main bearing

1 Barre Ø 18

- 1.6i 316 /Coupé
- 1.9i 318 /Coupé
- 2.0i 318 /Coupé

07/99-
07/99-
06/01-

OE 33551138104

- 2.0i 318Ci Coupé /Sport
- 2.0i 320
- 2.0 D 318
- 2.0 TD 320D / Touring
- 2.0 TD 320CD Coupé
- 2.0 TD 320TD
- 2.2i 320
- 2.2i 320Ci Coupé
- 2.5i 325
- 2.5i 325Ci Coupé
- 2.8i 328
- 3.0i 330
- 3.0i 330Ci Coupé
- 3.0 D 330CD Coupé
- 3.0 D 330D/ Touring Sauf XD

06/00-

03/03-

09/01-
09/01-

04/01-



... Série 3 E46 ...

Eléments TRAIN ARRIERE

Rear axle parts

Tren TRAS





Elementy zawieszenia tylnego

элементы задней оси.



BMW



<p>9001563 OE 33321092247</p> 	<p>Articulation AR sup. côté int. <i>Upper rear bush Inner side</i></p> <p>Ø int.12 Ø ext.35 long. tube int.66 ext.42 1.6i /Compact /Touring /Coupé 04/00- 1.8i 316 1.9i 316 318 2.0i 318/ Compact 2.0i 318Ci Coupé 2.0i 320 2.0 D 318 M47 11/01-03/05 2.0 D 320 Touring M47 07/99-09/01 2.0 D Touring 2.0 TD 318D /Touring /TD Compact 2.0 TD 320CD Coupé 2.0 TD 320D /Compact /Touring 2.2i 320 /Ci Coupé 2.5i 323 2.5i 325 /Compact 2.5i 325Ci Coupé 2.8i 328 3.0i 330 /4WD Touring 3.0i 330Ci Coupé 3.0 D 330 /Touring /4WD 3.0 D 330CD Coupé 3.2i M3 /Cab. /Coupé</p>	<p>2256059 OE 33326775551</p> 	<p>Articulation AR sup. côté ext. <i>Upper rear bush Outer side</i></p> <p>Ø int.12 Ø ext.45 long. tube int.56.5 ext.24 1.6i 316 /Touring 06/02-02/05 1.6i 316 Ci Coupé 04/00- 1.8i 316 /Touring 09/98-02/05 1.9i 316 09/98-02/05 1.9i 318i /Ci /Touring /Coupé 02/98-09/01 2.0i 318 /Touring 09/01-02/05 2.0i 318Ci Coupé /Cab. 04/00- 2.0i 320 Ci Coupé /Cab. 08/99-09/00 2.0i 320i /Touring 03/98-09/00 2.0 D 318 320 /Touring 09/01-02/05 2.0 TD 320 /Touring 04/98-02/05 2.0 TD 320CD Coupé /Cab. 11/03- 2.2i 320 /Touring 09/00-02/05 2.2i 320Ci /Coupé Cab. 09/00- 2.5 325 /Xi /Touring 09/00-02/05 2.5 325 Ci Coupé Cab. 09/00- 2.5i 323 /Ci /Cab. /Coupé 03/98-09/00 2.8i 328 /Ci /Touring /Coupé 02/98-06/00 3.0i 330 /Xi /Touring 06/00-02/05 3.0i 330 Ci /Xi /Coupé /Cab. 06/00- 3.0 D 330 /XD /Touring 10/99-02/05 3.0 D 330 CD Coupé 03/03- 3.0 D 330D /XD /Touring 03/03-02/05 3.2 M3 Coupé /Cab. 06/00-</p>
<p>9001414 OE 33326770786</p> 	<p>Articulation AR G/D sup. côté ext. <i>Upper L/R rear bush Outer side</i></p> <p>Ø int.12.5 Ø ext.61.5 long. tube int.49 ext.40 1.8i 316 318 /Compact /Touring N42 N45 2.2i 320 /Touring /Cab. 2.5i 323 /Cab. 2.5i 325 /4WD /Touring /Compact /Cab. 2.5i 325 xi 4WD 3.0 D 330 /4WD /Touring</p>		
<p>9001564 OE 33326770824</p> 	<p>Articulation AR inf. côté int. <i>Lower rear bush inner side</i></p> <p>Ø int.12 Ø ext.35 long. tube int.57 ext.42 1.6i 316 /Compact /Touring /Coupé 04/00- 1.8i 316 1.9i 316 318 2.0i 318/ Compact /Ci Compact 2.0i 320 2.0 D 318 M47 11/01-03/05 2.0 D 320 Touring M47 07/99-09/01 2.0 TD 318D /Touring 2.0 TD 318TD Compact 2.0 TD 320D /CD Coupé 2.0 TD 320D Touring /TD Compact 2.2i 320/ Ci Coupé 2.5i 323 2.5i 325/ Compact 2.5i 325Ci Coupé 2.8i 328 3.0i 330 /4WD Touring 3.0i 330Ci Coupé 3.0 D 330 /Touring /4WD 3.0 D 330CD Coupé 3.2i M3 /Cab. /Coupé</p>	<p>9001559 OE 33326771828</p> 	<p>Articulation inf. AR coté ext. <i>Rear lower bush Outer side</i></p> <p>Ø int.12 Ø ext.45 long. tube int.57 ext.31 1.6i 316 /Compact /Touring /Coupé 1.8i 316 318 /Compact /Touring N42 N45 1.9i 316 318 /Touring 05/98-05/02 2.0i 318 /Compact /Cab. 2.0i 320 /Touring 2.0 D 318 M47 11/01-03/05 2.0 D 318 320 Touring M47 07/99-09/01 2.0 TD 320D /Compact 2.2i 320 /Touring /Cab. 2.5i 323 /Cab. 2.5i 325 /4WD /Touring /Compact /Coupé Cab. 2.5i 325 xi 4WD 2.8i 328 /Touring 3.0i 330 /4WD /Touring /Cab. 3.0 D 330 /4WD /Touring 3.2i M3 /Cab. /Coupé</p>

... Série 3 E46

SASIC

BMW

Eléments TRAIN ARRIERE

Rear axle parts

Tren TRAS

Elementy zawieszenia tylnego

элементы задней оси.



9001414 Articulation AR G/D

OE 33326770786 L/R rear bush



Ø int.12.5 Ø ext.61.5 long. tube int.49 ext.40

1.6i 316 /Compact /Touring /Coupé
 1.9i 316 318 /Touring
 2.0i 318 /Compact /Cab.
 2.0i 320 /Touring
 2.0 D 318
 2.0 D 318 Touring
 2.0 D 320 Touring
 2.0 TD 320D /Compact
 2.5i 325 /Compact /Touring / Coupé /Cab.
 2.8i 328 /Touring
 3.0i 330 /4WD /Touring /Cab.

04/00-
05/98-05/02

M47

11/01-03/05

M47

07/99-09/01

9001792 Articulation AV G essieu

OE 33316770783 Axle left front bush



**Ø int. 12 Ø ext.70 coll.81
long. tube int.58 ext.51 ep. coll.8**

1.8i 316 N42
 1.9i 316
 1.9i 318 M43
 2.0i 318 N42/6 BVM
 2.0i 318 Compact N42
 2.0i 318Ci Coupé BVM
 2.0i 320 M52
 2.0 TD 318D /Touring M47
 2.0 TD 318TD Compact
 2.0 TD 320CD Coupé BVM
 2.0 TD 320D /Touring M47 BVM
 2.0 TD 320TD Compact
 2.2i 320 M54 BVM
 2.2i 320Ci Coupé M54 BVM
 2.5i 323
 2.5i 325 /Séquentielle /Compact
 2.5i 325Ci Coupé BV5
 2.8i 328
 3.0i 330 /Séquentielle
 3.0i 330Ci Coupé BVM
 3.0 D 330D M57
 3.0 D 330CD Coupé BVM
 3.0 D 330D/XD /Touring M57 BVM

9001790 Articulation AV D essieu

OE 33316770784 Axle right front bush



**Ø ext.70 coll.81 long. tube int.58
ext.51 ep. coll.8**

1.8i 316 N42
 1.9i 316
 1.9i 318 M43
 2.0i 318 N42/6 BVM
 2.0i 318 Compact N42
 2.0i 318Ci Coupé BVM
 2.0i 320 M52
 2.0 TD 318D /Touring M47
 2.0 TD 318TD Compact
 2.0 TD 320CD Coupé BVM
 2.0 TD 320D /Touring M47 BVM
 2.0 TD 320TD Compact
 2.2i 320 M54 BVM
 2.2i 320Ci Coupé M54 BVM
 2.5i 323
 2.5i 325 /Séquentielle /Compact
 2.5i 325Ci Coupé BV5
 2.8i 328
 3.0i 330 /Séquentielle
 3.0i 330Ci Coupé BVM
 3.0 D 330D M57
 3.0 D 330CD Coupé BVM
 3.0 D 330D/XD /Touring M57 BVM

9003110 Articulation AR essieu G/D

OE 33316770781 L/R axle rear bush



Ø int.20 Ø ext.72 coll.82 long. tube int.61.5 ext.49 ep. coll.9

1.8i 316 N42
 1.9i 316
 1.9i 318 M43
 2.0i 318 N42 N46
 2.0i 318 Compact N42
 2.0i 318Ci Coupé N46
 2.0i 320 M52
 2.0 TD 318D /Touring M47
 2.0 TD 318TD Compact
 2.0 TD 320D /Touring M47 BVM
 2.0 TD 320TD Compact BVM
 2.0 TD 320CD Coupé BVM
 2.2i 320 M54 BVM
 2.2i 320Ci Coupé M54 BVM
 2.5i 323
 2.5i 325 /Séquentielle
 2.5i 325 Compact
 2.5i 325Ci Coupé BV5
 2.8i 328
 3.0i 330 /Séquentielle
 3.0i 330Ci Coupé BVM
 3.0 D 330D/XD M57
 3.0 D 330CD Coupé BVM
 3.0 D 330D/XD Touring M57 BVM

Série 3 E90 ...

Eléments DIRECTION

Steering parts

Elementos Direcciones

Elementy układ kierowniczy

Элементы рулевой системы

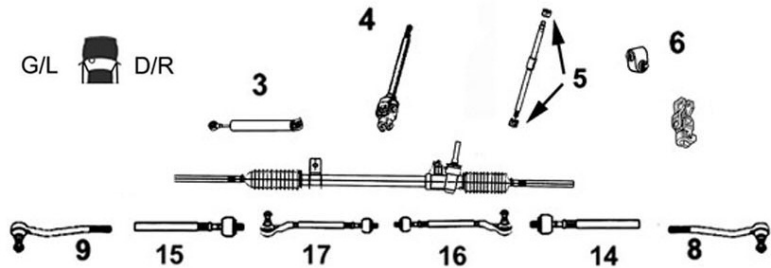

7776018 Axe de bielle G/D

Part/oe 32106765236 L/R axial joint



14 Côté dir. M18x1.5 Côté rot. M14x1.5 long 255 mm Direction ZF

15	1.6i 316	BVM	07/07-	2.5i 325	03/05-09/07
	2.0i 318		09/07-	3.0i 325	03/05-
	2.0i 320		09/07-	3.0i 330	03/05-
	2.0 D 316	BVM	09/09-	3.0i Turbo 335	09/07-
	2.0 D 318	BVM	03/07-09/07	3.0 D 325	09/06-
	2.0 D 318		09/07-	3.0 D 330	07/05-
	2.0 D 320 F		03/05-12/11	3.0 D 335	BVA 09/06-

9006811 Axe de bielle G/D

Part/oe 32216762244 L/R axial joint



14 Côté dir. M18x1.5 Côté rot. M14x1.5

15 long 247 mm

2.0 318 320 03/05-09/07

Part/oe 32216762243

2.0 D 318D 320D 09/08-

7776080 Axe de bielle G/D

OE 3210676907

L/R axial joint



14 Côté dir. M18x1.5 Côté rot. M14x1.5

15 long 260 mm

2.0 D 3204WD XD /X Drive	09/07-12/11
2.5i 325 4WD Xi /X Drive	01/05-12/11
3.0i 4WD Xi / X Drive	01/05-12/11
3.0i Turbo 4WD 335 Xi / X Drive	09/07-12/11
3.0 D 4WD 330 XD /X Drive	01/09-12/11

7676017 Rotule de direction G

OE 32106765089

Left tie rod end



9 M14 x 1.5

Direction ZF

1.6i 316	BVM	07/07-
2.0i 318		07/05-12/11
2.0i 320 150hp 110kw		03/05-12/11
2.0 D 316	BVM	09/09-
2.0 D 318		03/07-
2.0 D 320		09/05-
2.5i 325		03/05-09/07
3.0i 325		03/05-
3.0i 330		03/05-
3.0i Turbo 335		09/07-
3.0 D 325		09/06-
3.0 D 330		07/05-
3.0 D 335	BVA	09/06-
4.0i M3		10/07-

7676015 Rotule de direction D

OE 32106765090

Right tie rod end



8 M14 x 1.5

Direction ZF

1.6i 316	BVM	07/07-
2.0i 318		07/05-12/11
2.0i 320 150hp 110kw		03/05-12/11
2.0 D 316	BVM	09/09-
2.0 D 318		03/07-
2.0 D 320		09/05-
2.5i 325		03/05-09/07
3.0i 325		03/05-
3.0i 330		03/05-
3.0i Turbo 335		09/07-
3.0 D 325		09/06-
3.0 D 330		07/05-
3.0 D 335	BVA	09/06-
4.0i M3		10/07-

7676062 Rotule de direction G

OE 32106793623

Left tie rod end



9 M14 x 1.5

2.0 D 4WD 320 XD /X Drive	09/07-12/11
2.5i 325 4WD Xi	01/05-12/11
3.0i 4WD 325 /330 iX/ X Drive	01/05-
3.0i Turbo 4WD 335 XI / X Drive	09/07-12/11
3.0 D 4WD 330 XD X Drive	09/05-12/11

7676063 Rotule de direction D

OE 32106793624

Right tie rod end



8 M14 x 1.5

2.0 D 4WD 320 XD /X Drive	09/07-12/11
2.5i 325 4WD Xi	01/05-12/11
3.0i 4WD 325 /330 iX/ X Drive	01/05-
3.0i Turbo 4WD 335 XI / X Drive	09/07-12/11
3.0 D 4WD 330 XD X Drive	09/05-12/11

... Série 3 E90 ...

SASIC

BMW



Barre stabilisatrice
 Stabilizer bar
 Barra estabilizadora
 Drażek stabilizatora
 стабилизатор поперечной устойчивости

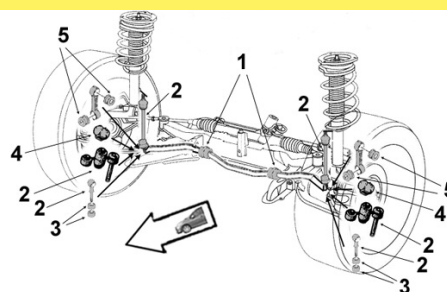

2306062 **Biellette barre stab. G**
 OE 31356765933 *Left stabilizer bar stub axle*



2	1.6i 316	BVM	07/07-
	2.0i 318		09/05-
	2.0i 320		03/05-09/08
	2.0 D 318	BVM	03/07-09/08
	2.0 D 320		03/05-09/08
	2.5i 325		03/05-09/07
	3.0i 325 330		03/05-09/08
	3.0i Turbo 335		09/07-09/08
	3.0 D 325 335		09/06-09/08
	3.0 D 330		07/05-09/08

2306061 **Biellette barre stab. D**
 OE 31356765934 *Right stabilizer bar stub axle*



2	1.6i 316	BVM	07/07-
	2.0i 318		09/05-
	2.0i 320		03/05-09/08
	2.0 D 318	BVM	03/07-09/08
	2.0 D 320		03/05-09/08
	2.5i 325		03/05-09/07
	3.0i 325 330		03/05-09/08
	3.0i Turbo 335		09/07-09/08
	3.0 D 325 335		09/06-09/08
	3.0 D 330		07/05-09/08



Eléments SUSPENSION
 Suspension parts
 Elementos suspensión
 Elementy zawieszenie
 Элементы подвески

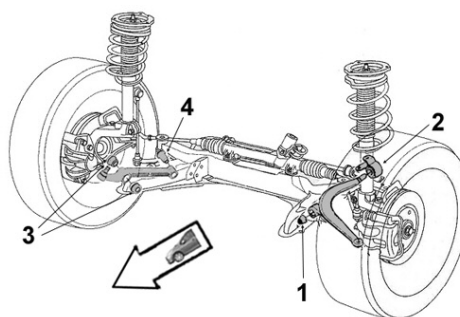

9003106 **Articulation AV Bras G/D**
 OE 31120393540 *L/R arm front bush*



4	Ø int.12 Ø ext.70 long. tube int.76 ext.64		
	1.6i 316	BVM	07/07-09/08
	2.0i 318 320		07/05-09/08
	2.0 D 318	BVM	03/07-09/08
	2.0 D 320		03/05-09/08
	2.5i 325		03/05-09/07
	3.0i 325		03/05-09/08
	3.0i 330		03/05-
	3.0i Turbo 335		09/07-09/08
	3.0 D 325 330		07/05-09/08
3.0 D 335	BVA	09/06-09/08	

Bras & Triangle de suspension

G/L D/R

Control arm
 Brazo y triángulo
 Wahacz
 Рычаг подвески

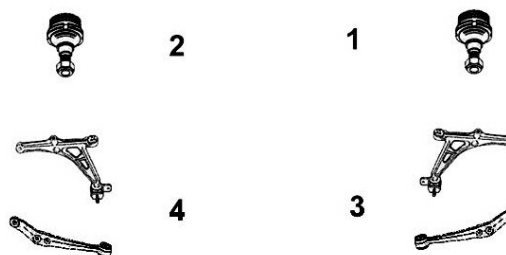

7476093 **Bras de susp. AR inf. G**
 OE 31126770849 *Left rear lower track control arm*



4	Avec rotule With ball joint		
	1.6i 316	BVM6	07/07-12/11
	2.0i 318/320	BVM6 BVA6	03/05-12/11
	2.0 D 316/318/320	BVM6 BVA6	03/05-12/11
	2.5i 325	BVM6 BVA6	03/05-12/11
	3.0i 325/ 330/ Turbo 335	BVM6 BVA6	03/05-12/11
	3.0 D 325/ 330/ 335	BVM6 BVA6	07/05-12/11

7476094 **Bras de susp. AR inf. D**
 OE 31126770850 *Right rear lower track control arm*





3	Avec rotule With ball joint		
	1.6i 316	BVM6	07/07-12/11
	2.0i 318/320	BVM6 BVA6	03/05-12/11
	2.0 D 316/318/320	BVM6 BVA6	03/05-12/11
	2.5i 325	BVM6 BVA6	03/05-12/11
	3.0i 325/ 330/ Turbo 335	BVM6 BVA6	03/05-12/11
	3.0 D 325/ 330/ 335	BVM6 BVA6	07/05-12/11

... Série 3 E90 ...

BMW

SASIC

7476009	Bras de susp. AV inf. G		7476008	Bras de susp. AV inf. D	
OE 31126769797	<i>L front lower track control arm</i>		OE 31126769798	<i>R front lower track control arm</i>	
	4 Avec rotule With ball joint			3 Avec rotule With ball joint	
	1.6i 316 BVM	07/07-		1.6i 316 BVM	07/07-
	2.0i 318	07/05-		2.0i 318	07/05-
	2.0i 320	03/05-		2.0i 320	03/05-
	2.0 D 316 BVM	09/09-		2.0 D 316 BVM	09/09-
	2.0 D 318 BVM	03/06-09/07		2.0 D 318 BVM	03/06-09/07
	2.0 D 318	09/07-		2.0 D 318	09/07-
	2.0 D 320	03/05-		2.0 D 320	03/05-
	3.0i 325	09/08-		3.0i 325	09/08-
	3.0i 330	03/05-		3.0i 330	03/05-
3.0i Turbo 335	09/07-	3.0i Turbo 335	09/07-		
3.0 D 325	09/06-	3.0 D 325	09/06-		
3.0 D 330	09/05-	3.0 D 330	09/05-		
3.0 D 335 BVA	09/06-	3.0 D 335 BVA	09/06-		

7576030	Rotule de susp. inf. G/D			
OE 31126768988	<i>L/R lower suspension ball joint</i>			
	1	2.0 D 4WD 320 XD /X Drive		09/07-12/11
	2	2.5i 4WD 325 Xi		03/05-12/11
		3.0i 4WD 325 330 Xi /X Drive		09/05-12/11
		3.0i Turbo 4WD 335 Xi / X Drive		09/07-12/11
		3.0 D 4WD 330 XD /X Drive		07/05-12/11



Support d'amortisseur
Suspension mounting
Soporte amortiguador
Poduszka amortyzatora
Опора амортизатора

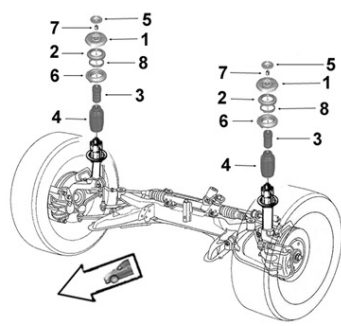

9001422	Support suspension G/D			
OE 31336760943	<i>L/R suspension mounting</i>			
	1 Avec roulement With bearing			
	1.6i 316			
	2.0i 318			
	2.0i 320			
	2.0 D 316 318 320			
	3.0i 325 330			
	3.0i Turbo 335			
	3.0 D 325 330 335			

2656044	Butée de suspension			
OE 31336771352	<i>Shock bush</i>			
	3 H80 Susp. normale			
	1.6i 316	N43B16A	BVM6	07/07-12/11
	2.0i 318	N46B20B		07/05-09/07
	2.0i 318 320	N43B20A		09/07-12/11
	2.0i 320	N46B20B		03/05-09/07
	2.0 D 316	N47D20C	BVM6	09/09-12/11
	2.0 D 318	M47DTU2D20 (204D4)	BVM6	03/07-09/07
	2.0 D 320	M47DTU2D20 (204D4)		03/05-09/07
	2.0 D 320	N47D20A		07/07-09/08
	2.0 D 320	N47D20C		09/08-12/11

suite...

... Série 3 E90



Support d'amortisseur
Suspension mounting
Soporte amortiguador
Poduszka amortyzatora
Опора амортизатора

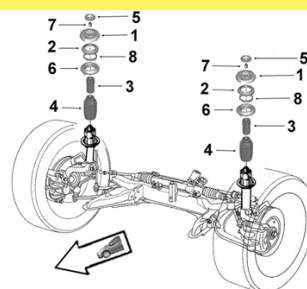

... 2656044 Butée de suspension

OE 31336771352 *Shock bush*



3 H 80 Susp. normale

2.5i 325	N52B25A	03/05-09/07
3.0i 325	N53B30A	03/05-12/11
3.0i 330	N52B30A	03/05-09/07
3.0i 330	N53B30A	09/07-12/11
3.0i Turbo 335	N54B30A	09/07-12/11
3.0 D 325	M57D30 (306D3)	09/06-12/11
3.0 D 330	M57D30 (306D3)	07/05-09/08
3.0 D 330	N57D30A	09/08-12/11
3.0 D 335	BVA6 M57D30 (306D5)	09/06-12/11



Barre stabilisatrice
Stabilizer bar
Barra estabilizadora
Drążek stabilizatora
стабилизатор поперечной устойчивости

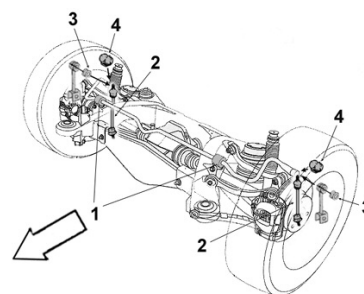

9005029 Bielle barre stab. G/D

OE 33556764428 *L/R stabilizer bar stub axle*



2 1.6i 316 BVM	07/07-	2.5i 325 /4WD	03/05-09/07
2.0i 318	07/05-	3.0i 325 /4WD	03/05-
2.0i 320 150hp 110kw	03/05-09/07	3.0i 330 /4WD	03/05-
2.0i 320 170hp 125kw	09/07-	3.0i Turbo 335 /4WD	09/07-
2.0i 320 175hp 127kw	12/05-09/06	3.0 D 325 335	09/06-
2.0 D 316 BVM	09/09-	3.0 D 330 /4WD	07/05-
2.0 D 318 BVM	03/07-09/08	4.0i M3	10/07-
2.0 D 318	09/08-		
2.0 D 320 /4WD	03/05-		



Eléments SUSPENSION
Suspension parts
Elementos suspensión
Elementy zawieszenie
Элементы подвески

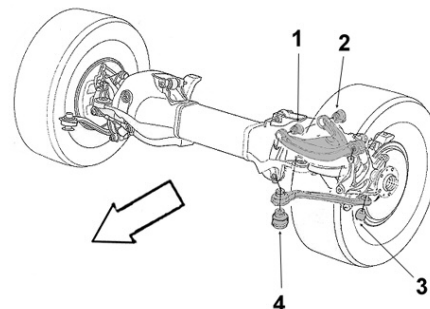

9001778 Articulation bras inf.

OE 33326775552 *Lower arm bush*



3 Ø int.14 Ø ext.47 long. tube int.55 ext.25

1.6i 316 BVM	07/07-	2.5i 325 /4WD	03/05-
2.0i 318	07/05-	3.0i 325 330 /4WD	03/05-
2.0i 320 150hp	03/05-09/07	3.0i Turbo 335 /4WD	09/07-
2.0i 320 170hp	09/07-	3.0 D 325 330 /4WD	07/05-
2.0i 320 175hp BVM	12/05-09/06	3.0 D 335 BVA	09/06-09/08
2.0 D 316 BVM	09/09-	4.0i M3 BVM /BV Rob.	09/08-
2.0 D 318 BVM	09/07-09/08		
2.0 D 318	09/08-		
2.0 D 320 /4WD	03/05-		

Série 3 E91 ...

Eléments DIRECTION

Steering parts

Elementos Direcciones

Elementy układ kierowniczy

Элементы рулевой системы

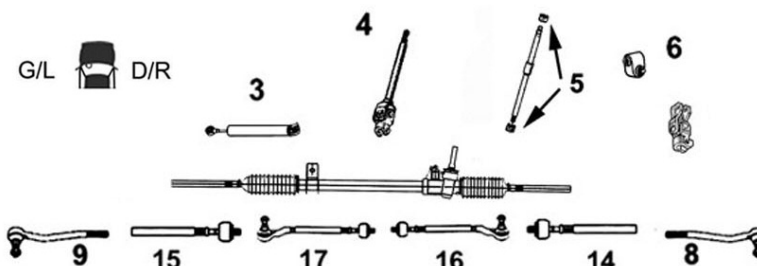

9006811

Axe de bielle G/D

Part/oe 32216762244 L/R axial joint



14 Côté dir. M18x1.5 Côté rot. M14x1.5
15 long 247 mm

2.0 318 320 Touring 03/06-09/07

2.0 D 318D 320D Touring 03/06-09/07

7776080

Axe de bielle G/D

OE 3210676907 L/R axial joint



14 Côté dir. M18x1.5 Côté rot. M14x1.5
15 long 260 mm

2.0 D 320 4WD 320 XD /X Drive 09/07-

2.5i 325 Touring 4WD Xi 09/05-

3.0i 325 Touring 4WD Xi /Xdrive 09/07-

3.0i 330 Touring 4WD Xi/X Drive 09/05-

3.0i Turbo 335 Touring 4WD Xi / X Drive 09/07-

3.0 D 330 Touring XD 09/05-

7776018

Axe de bielle G/D

Part/oe 32106765236 L/R axial joint



14 Côté dir. M18x1.5 Côté rot. M14x1.5 long 255 mm Direction ZF
15

2.0i 318 320 Touring 09/07-

2.0 D 318 Touring 03/06-

2.0 D 320 Touring 09/05-

2.5i 325 Touring 09/05-09/07

3.0i 325 Touring 09/07-

3.0i 330 Touring 09/05-

3.0i Turbo 335 Touring 09/06-

3.0 D 325 Touring 200hp 145kw 09/06-

3.0 D 330 Touring 09/05-

3.0 D 335 Touring BVA 09/06-

7676017

Rotule de direction G

OE 32106765089 Left tie rod end



9 M14 x 1.5

2.0i 318 Touring 03/06-

2.0i 320 Touring 09/05-

2.0 D 318 Touring 09/05-

2.0 D 320 Touring 09/05-

Direction ZF

2.5i 325 Touring 09/05-09/07

3.0i 325 Touring 09/07-

3.0i 330 Touring 09/05-

3.0i Turbo 335 Touring 09/06-

3.0 D 325 Touring 09/06-04/10

3.0 D 330 Touring 09/05-

3.0 D Turbo 335 Touring BVA 09/06-

7676015

Rotule de direction D

OE 32106765090 Right tie rod end



8 M14 x 1.5

2.0i 318 Touring 03/06-

2.0i 320 Touring 09/05-

2.0 D 318 Touring 09/05-

2.0 D 320 Touring 09/05-

Direction ZF

2.5i 325 Touring 09/05-09/07

3.0i 325 Touring 09/07-

3.0i 330 Touring 09/05-

3.0i Turbo 335 Touring 09/06-

3.0 D 325 Touring 09/06-04/10

3.0 D 330 Touring 09/05-

3.0 D Turbo 335 Touring BVA 09/06-

7676062

Rotule de direction G

OE 32106793623 Left tie rod end



9 M14 x 1.5

2.0 D 320 Touring 4WD XD /X Drive 09/07-

2.5i 325 Touring 4WD XI 09/05-

3.0i 325 330 Touring 4WD Xi /X Drive 09/05-

3.0i Turbo 335 Touring 4WD Xi /X Drive 09/07-

3.0 D 330 Touring 4WD XD 09/05-

7676063

Rotule de direction D

OE 32106793624 Right tie rod end



8 M14 x 1.5

2.0 D 320 Touring 4WD XD /X Drive 09/07-

2.5i 325 Touring 4WD XI 09/05-

3.0i 325 330 Touring 4WD Xi /X Drive 09/05-

3.0i Turbo 335 Touring 4WD Xi /X Drive 09/07-

3.0 D 330 Touring 4WD XD 09/05-

... Série 3 E91 ...

SASIC

BMW



Barre stabilisatrice
 Stabilizer bar
 Barra estabilizadora
 Drażek stabilizatora
 стабилизатор поперечной устойчивости

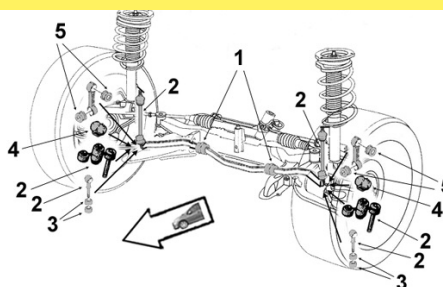

2306062 **Biellette barre stab. G**
 OE 31356765933 *Left stabilizer bar stub axle*



2	2.0i 318 Touring	03/06-10/08
	2.0i 320 Touring	09/05-10/08
	2.0 D 318 Touring BVM	03/06-10/08
	2.0 D 320 Touring	09/05-10/08
	2.5i 325 Touring	09/05-10/08
	3.0i 325/330 Touring	09/05-10/08
	3.0i Turbo 335 Touring	09/06-10/08
	3.0 D 325 Touring	09/06-10/08
	3.0 D 330 Touring	09/05-10/08
	3.0 D 335 Touring BVA	09/06-10/08

2306061 **Biellette barre stab. D**
 OE 31356765934 *Right stabilizer bar stub axle*



2	2.0i 318 Touring	03/06-10/08
	2.0i 320 Touring	09/05-10/08
	2.0 D 318 Touring BVM	03/06-10/08
	2.0 D 320 Touring	09/05-10/08
	2.5i 325 Touring	09/05-10/08
	3.0i 325/330 Touring	09/05-10/08
	3.0i Turbo 335 Touring	09/06-10/08
	3.0 D 325 Touring	09/06-10/08
	3.0 D 330 Touring	09/05-10/08
	3.0 D 335 Touring BVA	09/06-10/08



Eléments SUSPENSION
 Suspension parts
 Elementos suspensión
 Elementy zawieszenie
 Элементы подвески

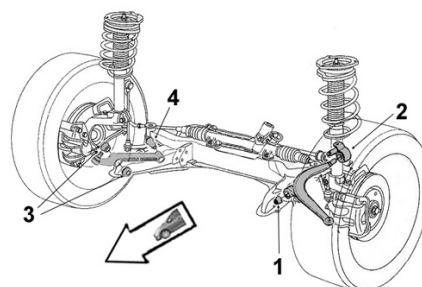

9003106 **Articulation AV Bras G/D**
 OE 31120393540 *L/R arm front bush*



4	Ø int.12 Ø ext.70 long. tube int.76 ext.64	
	2.0i 318 Touring	03/06-09/08
	2.0i 320 Touring	09/05-09/08
	2.0 D 318 Touring	03/06-09/08
	2.0 D 320 Touring	09/05-
	2.5i 325 Touring	09/05-09/07
	3.0i 325 Touring	09/07-09/08
	3.0i 330 Touring	09/05-
	3.0i Turbo 335 Touring	09/06-09/08
	3.0 D 325 335 Touring	09/06-09/08
	3.0 D 330 Touring	09/05-09/08

Bras & Triangle de suspension

Control arm
 Brazo y triángulo
 Wahacz
 Рычаг подвески

G/L D/R

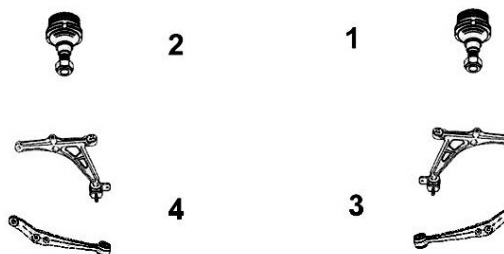

7476093 **Bras de susp. AR inf. G**
 OE 31126770849 *Left rear lower track control arm*

NEW



4	Avec rotule With ball joint	
	BVM6 BVA6	
	2.0i 318/ 320 Touring	09/05-12/11
	2.0 D 318 320 Touring	09/05-12/11
	2.5i 325 Touring	09/05-09/07
	3.0i 325/ 330/ Turbo 335 Touring	09/05-12/11
	3.0 D 325/ 330/ 335 Touring	09/05-12/11

7476094 **Bras de susp. AR inf. D**
 OE 31126770850 *Right rear lower track control arm*

NEW





3	Avec rotule With ball joint	
	BVM6 BVA6	
	2.0i 318/ 320 Touring	09/05-12/11
	2.0 D 318 320 Touring	09/05-12/11
	2.5i 325 Touring	09/05-09/07
	3.0i 325/ 330/ Turbo 335 Touring	09/05-12/11
	3.0 D 325/ 330/ 335 Touring	09/05-12/11

... Série 3 E91 ...

BMW

SASIC

7476009	Bras de susp. AV inf. G	7476008	Bras de susp. AV inf. D	
OE 31126769797	<i>L front lower track control arm</i>	OE 31126769798	<i>R front lower track control arm</i>	
4	Avec rotule <i>With ball joint</i>	3	Avec rotule <i>With ball joint</i>	
	2.0i 318 Touring	03/06-	2.0i 318 Touring	03/06-
	2.0i 320 Touring	09/05-	2.0i 320 Touring	09/05-
	2.0 D 318 Touring BVM	03/06-	2.0 D 318 Touring BVM	03/06-
	2.0 D 318 Touring	09/07-	2.0 D 318 Touring	09/07-
	2.0 D 320 Touring	09/05-	2.0 D 320 Touring	09/05-
	2.5i 325 Touring	09/05-	2.5i 325 Touring	09/05-
	3.0i 325 Touring	09/07-	3.0i 325 Touring	09/07-
	3.0i 330 Touring	09/05-	3.0i 330 Touring	09/05-
	3.0i Turbo 335 Touring	09/06-	3.0i Turbo 335 Touring	09/06-
	3.0 D 325 Touring	09/06-	3.0 D 325 Touring	09/06-
3.0 D 330 Touring	09/05-	3.0 D 330 Touring	09/05-	
3.0 D 335 Touring BVA	09/06-	3.0 D 335 Touring BVA	09/06-	

7576030	Rotule de susp. inf. G/D	
OE 31126768988	<i>L/R lower suspension ball joint</i>	
1		
	2.0 D 4WD 320 Touring XD /X Drive	09/07-
	2.5i 4WD 325 Touring XI /X Drive	09/05-
	3.0i 4WD 325 330 Touring Xi /X Drive	09/05-
	3.0i Turbo 4WD 335 Touring Xi / X Drive	09/07-
	3.0 D 4WD 330 Touring XD /X Drive	09/05-



Support d'amortisseur
Suspension mounting
Soporte amortiguador
Poduszka amortyzatora
Опора амортизатора

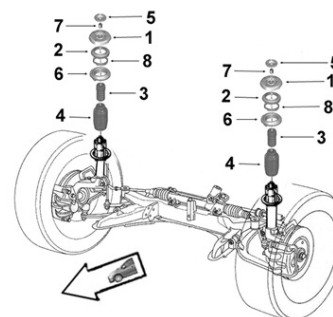

9001422	Support suspension G/D	
OE 31336760943	<i>L/R suspension mounting</i>	
1	Avec roulement <i>With bearing</i>	
	2.0i 318 Touring	
	2.0i 320 Touring	
	2.0 D 318 320 Touring	
	2.5i 325 Touring	
	3.0i 325 330 Touring	
	3.0i Turbo 335 Touring	
	3.0 D 325 Touring	
3.0 D 330 335 Touring		

... Série 3 E91

SASIC



Barre stabilisatrice
 Stabilizer bar
 Barra estabilizadora
 Drażek stabilizatora
 стабилизатор поперечной устойчивости

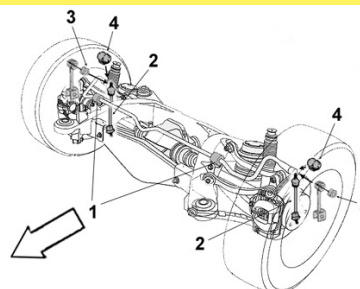

9005029

Biellette barre stab. G/D

OE 33556764428

L/R stabilizer bar stub axle



2

2.0i 318 Touring	03/06-	3.0i 325 Touring /4WD Touring	09/07-
2.0i 320 Touring	09/05-	3.0i 330 Touring /4WD Touring	09/05-
2.0 D 318 Touring BVM	09/07-09/08	3.0i Turbo 335 Touring	01/07-
2.0 D 318 Touring	10/08-	3.0i Turbo 335 4WD Touring	01/07-
2.0 D 320 Touring	09/05-	3.0 D 325 Touring	09/06-
2.0 D 320 4WD Touring	10/08-	3.0 D 330 Touring /4WD Touring	09/05-
2.5i 325 Touring	09/05-09/07	3.0 D 335 Touring	09/06-
2.5i 325 4WD Touring	09/05-09/07		



Eléments SUSPENSION

Suspension parts
 Elementos suspensión
 Elementy zawieszenie
 Элементы подвески

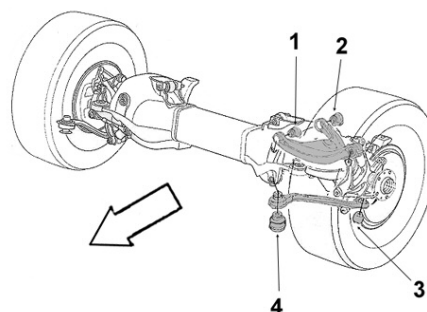

9001778

Articulation bras inf.

OE 33326775552

Lower arm bush



3

Ø int.14 Ø ext.47 long. tube int.55 ext.25

2.0i 318 Touring	03/06-
2.0i 320 Touring	09/05-
2.0 D 318 Touring	09/07-
2.0 D 318 Touring	03/06-09/07
2.0 D 320 Touring	09/05-
2.0 D 320 4WD Touring	10/08-
2.5i 325 Touring	09/05-09/07
2.5i 325 4WD Touring	09/05-09/07
3.0i 325 Touring	09/07-
3.0i 325 4WD Touring	09/07-
3.0i 330 Touring	09/05-
3.0i 330 4WD Touring	09/05-
3.0i Turbo 335 Touring	09/06-
3.0i Turbo 335 4WD Touring	01/07-
3.0 D 325 Touring	09/06-
3.0 D 330 Touring	09/05-
3.0 D 330 4WD Touring	09/05-
3.0 D 335 Touring	09/06-

Série 3 E92 ...

Éléments DIRECTION

Steering parts

Elementos Direcciones

Elementy układ kierowniczy

Элементы рулевой системы

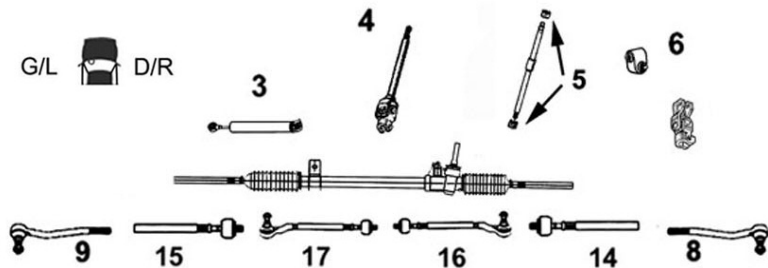

7776018 Axe de bielle G/D

Part/oe 32106765236 L/R axial joint



14 Côté dir. M18x1.5 Côté rot. M14x1.5 long 255 mm Direction ZF

15	2.0i 320	03/07-
	2.0 D 320	03/07-03/10
	2.5i 325	09/06-03/10
	3.0i 325	07/07-
	3.0i 330	09/06-
	3.0i Turbo 335	09/06-
	3.0 D 325	03/07-
	3.0 D 330	09/06-
	3.0 D 335 BVA	09/06-

9006811 Axe de bielle G/D

Part/oe 32216762244 L/R axial joint



14 Côté dir. M18x1.5 Côté rot. M14x1.5
15 long 247 mm

2.0 D 320	Direction TRW	03/07-
-----------	---------------	--------

7776080 Axe de bielle G/D

OE 3210676907

L/R axial joint



14 Côté dir. M18x1.5 Côté rot. M14x1.5
15 long 260 mm

2.0 D 320 4WD XD /X Drive	03/07-
2.5i 325 4WD Xi /X Drive	09/06-
3.0i 325 330 4WD Xi /X Drive	09/06-
3.0i Turbo 335 4WD Xi /X Drive	09/06-
3.0 D 330 4WD XD /X Drive	01/09-

7676017 Rotule de direction G

OE 32106765089

Left tie rod end



9 M14 x 1.5 Direction ZF

2.0i 320	03/07-
2.0 D 320	03/07-
2.5i 325	09/06-
3.0i 325	07/07-
3.0i 330	09/06-
3.0i Turbo 335	09/06-
3.0 D 325	03/07-
3.0 D 330	09/06-
3.0 D 335 BVA	09/06-
4.0i M3	01/08-

7676015 Rotule de direction D

OE 32106765090

Right tie rod end



8 M14 x 1.5 Direction ZF

2.0i 320	03/07-
2.0 D 320	03/07-
2.5i 325	09/06-
3.0i 325	07/07-
3.0i 330	09/06-
3.0i Turbo 335	09/06-
3.0 D 325	03/07-
3.0 D 330	09/06-
3.0 D 335 BVA	09/06-
4.0i M3	01/08-

7676062 Rotule de direction G

OE 32106793623

Left tie rod end



9 M14 x 1.5

2.0 D 320 4WD XD /X drive	03/07-
2.5i 325 4WD IX	09/06-
3.0i 325 4WD XI /Xdrive	09/07-
3.0i 330 4WD XI /X Drive	09/06-
3.0i Turbo 335 4WD XI /X Drive	09/06-
3.0 D 330 4WD XD /X Drive	09/06-

7676063 Rotule de direction D

OE 32106793624

Right tie rod end



8

2.0 D 320 4WD XD /X drive	03/07-
2.5i 325 4WD IX	09/06-
3.0i 325 4WD XI /Xdrive	09/07-
3.0i 330 4WD XI /X Drive	09/06-
3.0i Turbo 335 4WD XI /X Drive	09/06-
3.0 D 330 4WD XD /X Drive	09/06-

... Série 3 E92 ...



Barre stabilisatrice
 Stabilizer bar
 Barra estabilizadora
 Drażek stabilizatora
 стабилизатор поперечной устойчивости

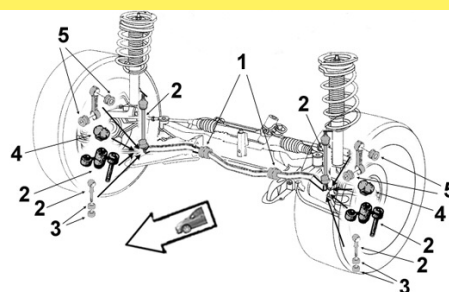

2306062 **Biellette barre stab. G**
 OE 31356765933 *Left stabilizer bar stub axle*



2	2.0i 320	03/07-
	2.0 D 320	03/07-
	2.5i 325	09/06-
	3.0i 325	07/07-
	3.0i 330	09/06-
	3.0i Turbo 335	09/06-
	3.0 D 325	03/07-
	3.0 D 330 335	09/06-

2306061 **Biellette barre stab. D**
 OE 31356765934 *Right stabilizer bar stub axle*



2	2.0i 320	03/07-
	2.0 D 320	03/07-
	2.5i 325	09/06-
	3.0i 325	07/07-
	3.0i 330	09/06-
	3.0i Turbo 335	09/06-
	3.0 D 325	03/07-
	3.0 D 330 335	09/06-



Eléments SUSPENSION
 Suspension parts
 Elementos suspensión
 Elementy zawieszenie
 Элементы подвески

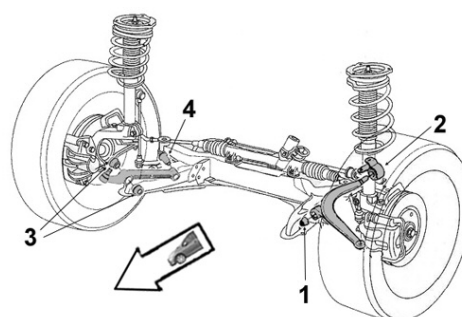

9003106 **Articulation AV Bras G/D**
 OE 31120393540 *L/R arm front bush*



4	Ø int.12 Ø ext.70 long. tube int.76 ext.64	
	2.0i 320	03/07-03/10
	2.0 D 320	03/07-03/10
	2.5i 325	09/06-03/10
	3.0i 325	07/07-03/10
	3.0i 330	09/06-03/10
	3.0i Turbo 335	09/06-03/10
	3.0 D 325 330	03/07-03/10
	3.0 D 335	09/06-03/10

Bras & Triangle de suspension

Control arm
 Brazo y triángulo
 Wahacz
 Рычаг подвески

G/L D/R



7476093 **Bras de susp. AR inf. G**
 OE 31126770849 *Left rear lower track control arm*



4	Avec rotule With ball joint	
	2.0i 320	03/07-
	2.0 D 320 BVM6 BVA6	03/07-
	2.5i 325 BVM6 BVA6	09/06-03/10
	3.0i 325/ 330 BVM6 BVA6	09/06-
	3.0i Turbo 335	09/06-
	3.0 D 330/ 325/ 335 BVM6 BVA6	09/06-

7476094 **Bras de susp. AR inf. D**
 OE 31126770850 *Right rear lower track control arm*





3	Avec rotule With ball joint	
	2.0i 320	03/07-
	2.0 D 320 BVM6 BVA6	03/07-
	2.5i 325 BVM6 BVA6	09/06-03/10
	3.0i 325/ 330 BVM6 BVA6	09/06-
	3.0i Turbo 335	09/06-
	3.0 D 330/ 325/ 335 BVM6 BVA6	09/06-

... Série 3 E92 ...

BMW

SASIC

<p>7476009 Bras de susp. AV inf. G OE 31126769797 <i>L front lower track control arm</i></p>  <p>4 Avec rotule <i>With ball joint</i></p> <table style="width: 100%; border-collapse: collapse;"> <tr><td>2.0i 320</td><td>03/07-</td></tr> <tr><td>2.0 D 320</td><td>03/07-</td></tr> <tr><td>2.5i 325</td><td>09/06-</td></tr> <tr><td>3.0i 325</td><td>07/07-</td></tr> <tr><td>3.0i 330</td><td>09/06-</td></tr> <tr><td>3.0i Turbo 335</td><td>09/06-</td></tr> <tr><td>3.0 D 325</td><td>03/07-</td></tr> <tr><td>3.0 D 330</td><td>09/06-</td></tr> <tr><td>3.0 D 335 BVA</td><td>09/06-</td></tr> </table>	2.0i 320	03/07-	2.0 D 320	03/07-	2.5i 325	09/06-	3.0i 325	07/07-	3.0i 330	09/06-	3.0i Turbo 335	09/06-	3.0 D 325	03/07-	3.0 D 330	09/06-	3.0 D 335 BVA	09/06-	<p>7476008 Bras de susp. AV inf. D OE 31126769798 <i>R front lower track control arm</i></p>  <p>3 Avec rotule <i>With ball joint</i></p> <table style="width: 100%; border-collapse: collapse;"> <tr><td>2.0i 320</td><td>03/07-</td></tr> <tr><td>2.0 D 320</td><td>03/07-</td></tr> <tr><td>2.5i 325</td><td>09/06-</td></tr> <tr><td>3.0i 325</td><td>07/07-</td></tr> <tr><td>3.0i 330</td><td>09/06-</td></tr> <tr><td>3.0i Turbo 335</td><td>09/06-</td></tr> <tr><td>3.0 D 325</td><td>03/07-</td></tr> <tr><td>3.0 D 330</td><td>09/06-</td></tr> <tr><td>3.0 D 335 BVA</td><td>09/06-</td></tr> </table>	2.0i 320	03/07-	2.0 D 320	03/07-	2.5i 325	09/06-	3.0i 325	07/07-	3.0i 330	09/06-	3.0i Turbo 335	09/06-	3.0 D 325	03/07-	3.0 D 330	09/06-	3.0 D 335 BVA	09/06-
2.0i 320	03/07-																																				
2.0 D 320	03/07-																																				
2.5i 325	09/06-																																				
3.0i 325	07/07-																																				
3.0i 330	09/06-																																				
3.0i Turbo 335	09/06-																																				
3.0 D 325	03/07-																																				
3.0 D 330	09/06-																																				
3.0 D 335 BVA	09/06-																																				
2.0i 320	03/07-																																				
2.0 D 320	03/07-																																				
2.5i 325	09/06-																																				
3.0i 325	07/07-																																				
3.0i 330	09/06-																																				
3.0i Turbo 335	09/06-																																				
3.0 D 325	03/07-																																				
3.0 D 330	09/06-																																				
3.0 D 335 BVA	09/06-																																				

<p>7576030 Rotule de susp. inf. G/D OE 31126768988 <i>L/R lower suspension ball joint</i></p>  <p>NEW</p> <p>1</p> <table style="width: 100%; border-collapse: collapse;"> <tr><td>2..0 D 4WD 320 XD /X Drive</td><td>03/07-</td></tr> <tr><td>2.5i 4WD 325 XI /X Drive</td><td>09/06-</td></tr> <tr><td>3.0i 4WD 325 330 Xi / X Drive</td><td>09/06-</td></tr> <tr><td>3.0i Turbo 4WD 335 Xi / X Drive</td><td>09/06-</td></tr> <tr><td>3.0 D 4WD 330 XD /X Drive</td><td>09/06-</td></tr> </table>	2..0 D 4WD 320 XD /X Drive	03/07-	2.5i 4WD 325 XI /X Drive	09/06-	3.0i 4WD 325 330 Xi / X Drive	09/06-	3.0i Turbo 4WD 335 Xi / X Drive	09/06-	3.0 D 4WD 330 XD /X Drive	09/06-	
2..0 D 4WD 320 XD /X Drive	03/07-										
2.5i 4WD 325 XI /X Drive	09/06-										
3.0i 4WD 325 330 Xi / X Drive	09/06-										
3.0i Turbo 4WD 335 Xi / X Drive	09/06-										
3.0 D 4WD 330 XD /X Drive	09/06-										



Support d'amortisseur
Suspension mounting
Soporte amortiguador
Poduszka amortyzatora
Опора амортизатора

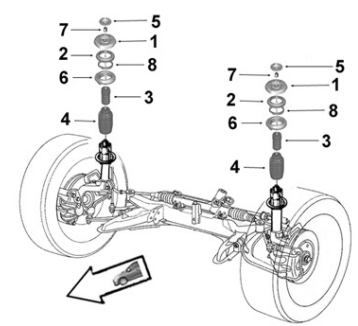

<p>2656044 Butée de suspension OE 31336771352 <i>Shock bush</i></p>  <p>3 H 80 Susp. normale</p> <table style="width: 100%; border-collapse: collapse;"> <tr><td>2.0i 320</td><td>N43B20A</td><td>03/10-</td></tr> <tr><td>2.0 D 320</td><td>N47D20C</td><td>03/10-</td></tr> <tr><td>3.0i 325 330</td><td>N53B30A</td><td>03/10-</td></tr> <tr><td>3.0i Turbo 335</td><td>N55B30A</td><td>03/10-</td></tr> <tr><td>3.0 D 325 330</td><td>N57D30A</td><td>03/10-</td></tr> </table>	2.0i 320	N43B20A	03/10-	2.0 D 320	N47D20C	03/10-	3.0i 325 330	N53B30A	03/10-	3.0i Turbo 335	N55B30A	03/10-	3.0 D 325 330	N57D30A	03/10-	
2.0i 320	N43B20A	03/10-														
2.0 D 320	N47D20C	03/10-														
3.0i 325 330	N53B30A	03/10-														
3.0i Turbo 335	N55B30A	03/10-														
3.0 D 325 330	N57D30A	03/10-														



Barre stabilisatrice
Stabilizer bar
Barra estabilizadora
Drażek stabilizatora
стабилизатор поперечной устойчивости

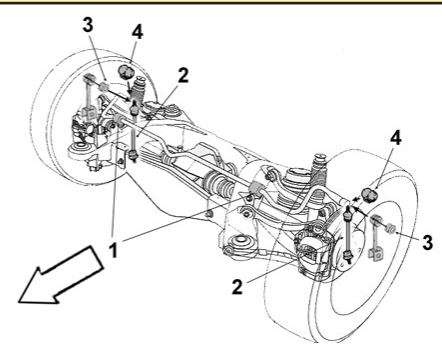

<p>9005029 Biellette barre stab. G/D OE 33556764428 <i>L/R stabilizer bar stub axle</i></p>  <p>2</p> <table style="width: 100%; border-collapse: collapse;"> <tr><td>2.0i 320</td><td>03/07-</td></tr> <tr><td>2.0 D 320</td><td>03/07-</td></tr> <tr><td>2.0 D 320 4WD</td><td>10/08-03/10</td></tr> <tr><td>2.5i 325 /4WD</td><td>09/06-03/10</td></tr> <tr><td>3.0i 325 /4WD</td><td>07/07-</td></tr> <tr><td>3.0i 330 /4WD</td><td>09/06-</td></tr> <tr><td>3.0i Turbo 335 /4WD</td><td>09/06-</td></tr> <tr><td>3.0 D 325</td><td>03/07-</td></tr> <tr><td>3.0 D 330 /330 4WD /335</td><td>09/06-</td></tr> <tr><td>4.0i M3</td><td>09/07-</td></tr> </table>	2.0i 320	03/07-	2.0 D 320	03/07-	2.0 D 320 4WD	10/08-03/10	2.5i 325 /4WD	09/06-03/10	3.0i 325 /4WD	07/07-	3.0i 330 /4WD	09/06-	3.0i Turbo 335 /4WD	09/06-	3.0 D 325	03/07-	3.0 D 330 /330 4WD /335	09/06-	4.0i M3	09/07-	
2.0i 320	03/07-																				
2.0 D 320	03/07-																				
2.0 D 320 4WD	10/08-03/10																				
2.5i 325 /4WD	09/06-03/10																				
3.0i 325 /4WD	07/07-																				
3.0i 330 /4WD	09/06-																				
3.0i Turbo 335 /4WD	09/06-																				
3.0 D 325	03/07-																				
3.0 D 330 /330 4WD /335	09/06-																				
4.0i M3	09/07-																				

Les réf. constructeurs (OE) ne servent qu'à identifier les pièces et sont données à titre indicatif.

... Série 3 E92



Eléments SUSPENSION

Suspension parts
Elementos suspensión
Elementy zawieszenie
Элементы подвески

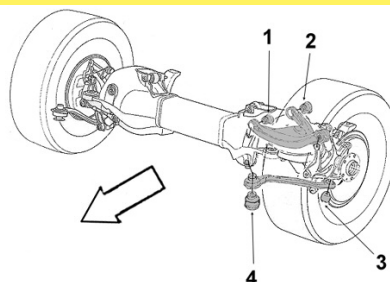

9001778

Articulation bras inf.

OE 33326775552

Lower arm bush

3 Ø int.14 Ø ext.47 long.tube int.55 ext.25



2.0i 320	03/07-	3.0i Turbo 335 4WD	09/07-
2.0 D 320	03/07-	3.0 D 325	03/07-
2.0 D 320 4WD	10/08-	3.0 D 330 /4WD	03/07-
2.5i 325 /4WD	09/06-	3.0 D 335 /4WD	09/06-
3.0i 325 /4WD	07/07-	4.0i M3	03/07-
3.0i 330 /4WD	09/06-		
3.0i Turbo 335	09/06-		

Série 3 E93 ...

Eléments DIRECTION

Steering parts
Elementos Direcciones
Elementy układ kierowniczy
Элементы рулевой системы

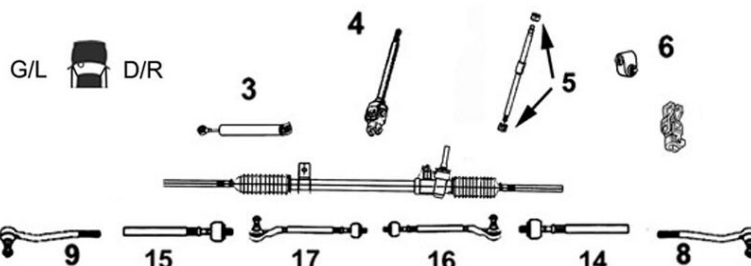

7776018

Axe de bielle G/D

Part/oe 32106765236 L/R axial joint

14 Côté dir. M18x1.5 Côté rot. M14x1.5
15 long 255 mm Direction ZF



2.0i 320	03/07-
2.0 D 320	01/08-03/10
3.0i 325	01/07-
3.0i 330	01/07-
3.0i Turbo 335	10/08-03/10
3.0 D 325	09/07-
3.0 D 330	01/07-

9006811

Axe de bielle G/D

Part/oe 32216762244 L/R axial joint

14 Côté dir. M18x1.5 Côté rot. M14x1.5
15 long 247 mm Direction TRW



2.0 D 320	03/07-
-----------	--------

7676017

Rotule de direction G

OE 32106765089 Left tie rod end

9 M14 x 1.5
Direction ZF



2.0i 320	01/07-
2.0 D 320	01/08-
3.0i 325 330	01/07-
3.0i Turbo 335	01/07-
3.0 D 325	09/07-
3.0 D 330	01/07-
4.0i M3	01/08-

7676015

Rotule de direction D

OE 32106765090 Right tie rod end

8 M14 x 1.5
Direction ZF

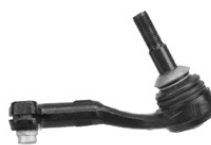

2.0i 320	01/07-
2.0 D 320	01/08-
3.0i 325 330	01/07-
3.0i Turbo 335	01/07-
3.0 D 325	09/07-
3.0 D 330	01/07-
4.0i M3	01/08-

... Série 3 E93 ...



Barre stabilisatrice
 Stabilizer bar
 Barra estabilizadora
 Drażek stabilizatora
 стабилизатор поперечной устойчивости

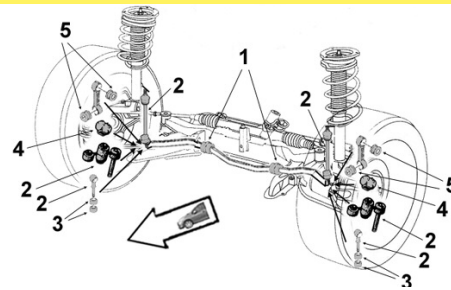

2306062 **Biellette barre stab. G**
 OE 31356765933 *Left stabilizer bar stub axle*



2			
	2.0i 320	BVM	01/07-
	2.0 D 320		01/08-
	3.0i 325 /330		01/07-
	3.0i Turbo 335		01/07-
	3.0 D 325 330		01/07-

2306061 **Biellette barre stab. D**
 OE 31356765934 *Right stabilizer bar stub axle*



2			
	2.0i 320	BVM	01/07-
	2.0 D 320		01/08-
	3.0i 325 /330		01/07-
	3.0i Turbo 335		01/07-
	3.0 D 325 330		01/07-



Eléments SUSPENSION
 Suspension parts
 Elementos suspensión
 Elementy zawieszenie
 Элементы подвески

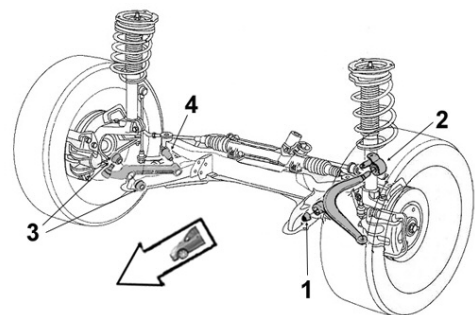

9003106 **Articulation AV Bras G/D**
 OE 31120393540 *L/R arm front bush*



4	Ø int.12 Ø ext.70 long. tube int.76 ext.64		
	2.0i 320		01/07-03/10
	2.0 D 320		01/08-03/10
	3.0i 325 330		01/07-03/10
	3.0i Turbo 335		01/07-03/10
	3.0 D 325		09/07-03/10
	3.0 D 330		01/07-03/10

Bras & Triangle de suspension
 Control arm
 Brazo y triángulo
 Wahacz
 Рычаг подвески

G/L D/R

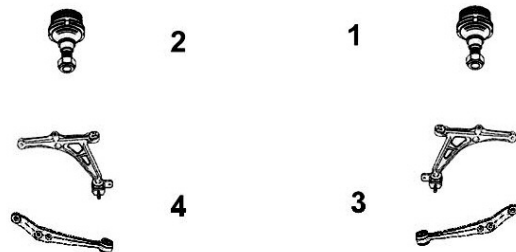

7476093 **Bras de susp. AR inf. G**
 OE 31126770849 *Left rear lower track control arm*

NEW



4	Avec rotule With ball joint		
	2.0i 320	BVM6 BVA6	01/07-
	2.0 D 320	BVM6 BVA6	01/08-
	3.0i 325/ 330	BVM6 BVA6	01/07-
	3.0i Turbo 330/335		01/07-
	3.0 D 325/ 330	BVM6 BVA6	01/07-

7476094 **Bras de susp. AR inf. D**
 OE 31126770850 *Right rear lower track control arm*

NEW



3	Avec rotule With ball joint		
	2.0i 320	BVM6 BVA6	01/07-
	2.0 D 320	BVM6 BVA6	01/08-
	3.0i 325/ 330	BVM6 BVA6	01/07-
	3.0i Turbo 330/335		01/07-
	3.0 D 325/ 330	BVM6 BVA6	01/07-

... Série 3 E93

SASIC

BMW

Bras & Triangle de suspension

Control arm
Brazo y triángulo
Wahacz
Рычаг подвески

G/L  D/R

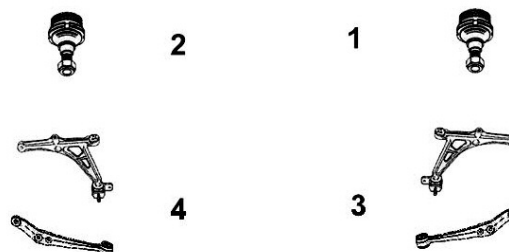

7476009 Bras de susp. AV inf. G
OE 31126769797 L front lower track control arm

4 Avec rotule With ball joint

2.0i 320	01/07-
2.0 D 320	01/08-
3.0i 325	01/07-
3.0i 330	01/07-
3.0i Turbo 335	01/07-
3.0 D 325	09/07-
3.0 D 330	01/07-



7476008 Bras de susp. AV inf. D
OE 31126769798 R front lower track control arm

3 Avec rotule With ball joint

2.0i 320	01/07-
2.0 D 320	01/08-
3.0i 325	01/07-
3.0i 330	01/07-
3.0i Turbo 335	01/07-
3.0 D 325	09/07-
3.0 D 330	01/07-



Barre stabilisatrice

Stabilizer bar
Barra estabilizadora
Drażek stabilizatora
стабилизатор поперечной устойчивости

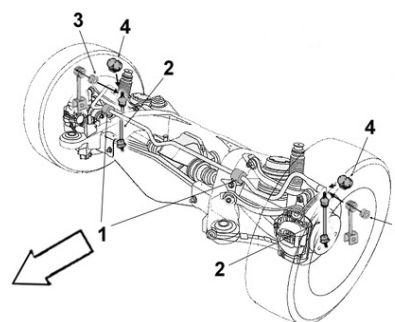

9005029 Biellette barre stab.
OE 33556764428 Stabilizer bar stub axle

2

2.0i 320	01/07-
2.0 D 320	03/07-
3.0i 325 /330	01/07-
3.0i Turbo 335	01/07-03/10
3.0 D 325 330	01/07-
4.0i M3	01/08-



Eléments SUSPENSION

Suspension parts
Elementos suspensión
Elementy zawieszenie
Элементы подвески

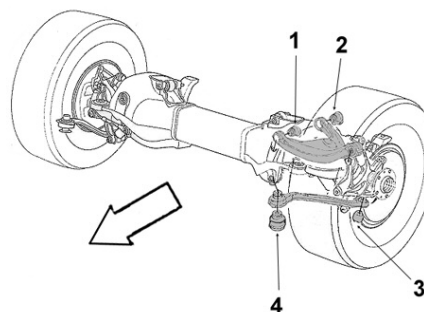

9001778 Articulation bras inf.
OE 33326775552 Lower arm bush

3 Ø int.14 Ø ext.47 long. tube int.55 ext.25

2.0i 320	01/07-
2.0 D 320	01/08-
3.0i 325 330	01/07-
3.0i Turbo 335	01/07-
3.0 D 325	09/07-
3.0 D 330	01/07-
4.0i M3	03/07-



Série 5 E28

Eléments DIRECTION

Steering parts

Elementos Direcciones

Elementy uklad kierowniczy

Элементы рулевой системы

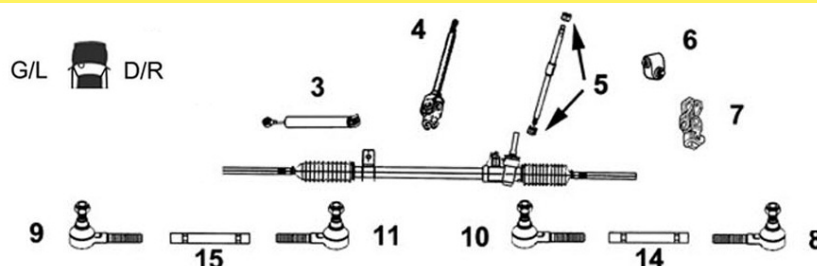

9006255 Bielle de direction G/D

OE 3221113566 /R steering rod



8 M14 x 1.5
9
10
11 TT /all models
14
15

9006323 Rotule de direction G/D Int.

OE 32211135819 L/R inner tie rod end



10 Filetage pas à gauche Left-hand thread
11 M14 x 1.5
TT /all models

9006324 Rotule de direction G/D

OE 32211135820 L/R tie rod end



8 Filetage pas à droite Right-hand thread
9 M14 x 1.5
TT /all models

Série 5 E34 ...

Eléments DIRECTION

Steering parts

Elementos Direcciones

Elementy uklad kierowniczy

Элементы рулевой системы

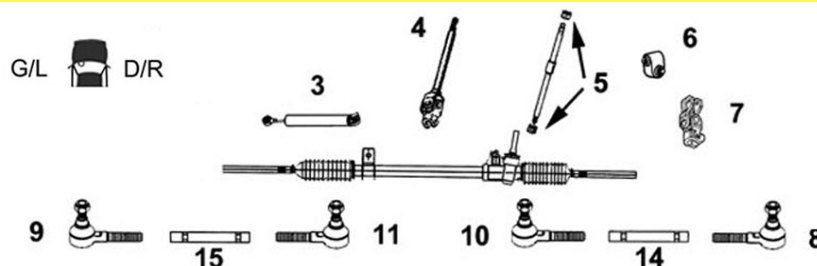

9006255 Bielle de direction G/D

OE 32211135666 L/R steering rod



8 M14 x 1.5
9
10
11 TT /all models
14
15

9006323 Rotule de direction G/D Int.

OE 32211135819 L/R inner tie rod end



10 Filetage pas à gauche Left-hand thread
11 M14 x 1.5
TT /all models

9006324 Rotule de direction G/D Ext.

OE 32211135820 L/R outer tie rod end



8 Filetage pas à droite Right-hand thread
9 M14 x 1.5
TT /all models

... Série 5 E34 ...

SASIC

BMW



Barre stabilisatrice
 Stabilizer bar
 Barra estabilizadora
 Drażek stabilizatora
 стабилизатор поперечной устойчивости

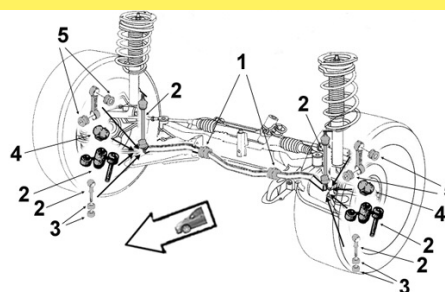

9005058 **Biellette barre stab.**
 OE 31351134582 *Stabilizer bar stub axle*



2 1.8i 518
 2.0i 520
 2.0i 24v. 520
 2.4 TD 524
 2.5i /24v. 525
 2.5 TD/S 525
 3.0i 530
 3.5i 535
 3.8i M5
 3.8i M5 Touring
 4.0i 540 V8

03/92-01/96
 02/93-01/96

9001568 **Palier de barre milieu**
 OE 31351135805 *Middle bar main bearing*



1 Barre Ø 23
 1.8i 518 -09/95
 2.0i /24v. 520 -09/95
 2.4 TD 524 -09/95
 2.5i 525 -09/95
 2.5i 24v. 525 -09/95
 2.5 TD/S 525 -09/95
 3.0i 530 /V8 -09/95
 3.5i 535 -09/95
 4.0i 540 V8 -09/95

9001573 **Palier de barre milieu**
 OE 31351133738 *Middle bar main bearing*



1 Barre Ø 24
 1.8i 518 -09/95
 2.0i /24v. 520 -09/95
 2.4 TD 524 -09/95
 2.5i 525 -09/95
 2.5i 24v. 525 -09/95
 2.5 TD/S 525 -09/95
 3.0i 530 -09/95
 3.5i 535 -09/95

9001574 **Palier de barre milieu**
 OE 31351140193 *Middle bar main bearing*



1 Barre Ø 25
 2.0i 24v. 520 -09/95
 2.0i 520 Touring -01/97
 2.4 TD 524 M21D24WA (246TB) 01/09/91-30/09/91
 2.5i 24v. 525 -09/95
 2.5i 24v. 525 Touring M50 -01/97
 2.5 TD/S 525 Touring M51 -01/97
 3.0i 530 V8 -09/95
 3.0i 530 V8 Touring -01/97
 3.5i 535 -09/95
 4.0i 540 V8 -09/95



Support d'amortisseur
 Suspension mounting
 Soporte amortiguador
 Poduszka amortyzatora
 Опора амортизатора

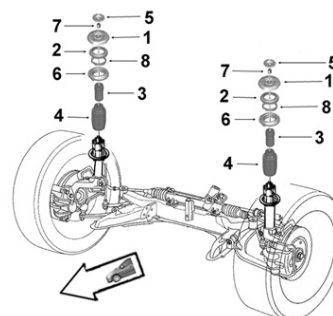

9001420 **Support suspension G/D**
 OE 31331139452 *L/R suspension mounting*



1 Avec roulement With bearing
 1.8i 518 09/92-09/95
 2.0i 520 09/92-01/97
 2.0i 24v. 520 09/92-09/95
 2.4 TD 524
 2.5i 525 24v. 09/92-09/95
 2.5 TD 525 09/92-01/97
 2.5 TDS 525 09/92-09/95

... Série 5 E34 ...



Barre stabilisatrice
 Stabilizer bar
 Barra estabilizadora
 Drażek stabilizatora
 стабилизатор поперечной устойчивости

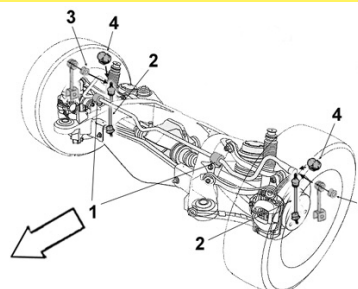

9005061 **Biellette barre stab.**
 OE 33551135307 *Stabilizer bar stub axle*



2 1.8i 518
 2.0i 520
 2.0i 24v. 520
 2.4 TD 524
 2.5i /24v. 525
 2.5 TD/S 525
 2.5 TDS 525 Touring
 3.0i 530
 3.5i 535
 4.0i 540 V8

9001570 **Palier de barre milieu**
 OE 33551131155 *Middle bar main bearing*



1 Barre Ø 15			
1.8i 518	-09/95	2.5i 24v. 525 Touring	-01/97
2.0i 520	-09/95	2.5 TD/S 525	-09/95
2.0i 24v. 520	-09/95	2.5 TD/S 525 Touring	-01/97
2.0i 520 Touring	-01/97	3.0i 530 /V8	-09/95
2.0i 24v. 520 Touring	-01/97	3.0i 530 V8 Touring	-01/97
2.4 TD 524	-09/95	3.5i 535	-09/95
2.5i / 24v. 525	-09/95	4.0i 540 V8	-09/95
2.5i 525 Touring	-01/97		

9001572 **Palier de barre milieu**
 OE 33551138104 *Middle bar main bearing*



1 Barre Ø 18		
2.0i 520		
2.0i 24v. 520 /Touring		
2.4 TD 524		
2.5i 525 /24v. 525		
2.5i 24v. 525ix Touring		-01/97
2.5 TDS 525/ Touring		
3.0i 530 V8		
3.5i 535		
4.0i 540 V8		



Support d'amortisseur
 Suspension mounting
 Soporte amortiguador
 Poduszka amortyzatora
 Опора амортизатора

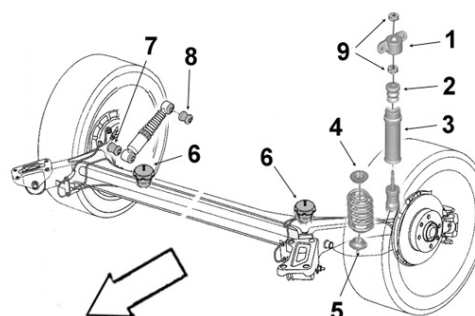

9005351 **Butée de suspension AR G/D**
 OE 33531135624 *L/R rear suspension bush*



2	1.8i 518	M40 M43	-01/97
	2.0i 520	M50	-01/97
	2.0i 24v. 520		-09/95
	2.4 TD 524		-09/95
	2.5i 24v. 525 /Touring		-09/95
	2.5 TD/S 525	M51	-01/97
	3.0i 530 V8		-09/95
	3.5i 535		-09/95
	4.0i 540 V8		-09/95

... Série 5 E34

Eléments TRAIN ARRIERE

Rear axle parts

Tren TRAS

Elementy zawieszenia tylnego

элементы задней оси.



9001558

Articulation essieu AR G/D

OE 33311128670

L/R Rear axle bush

Ø int.15 Ø ext.80 coll.92 long. tube int.85 ext.80 ep. coll.5



1.8i 518	-09/95	3.0i 530 /V8	-09/95
2.0i 520	-09/95	3.5i M5	-09/95
2.0i 24v. 520 /Touring	-09/95	3.5i 535	-09/95
2.4 TD 524	-09/95	3.8i M5	-09/95
2.5i 525 /24v. 525	-09/95	4.0i 540 V8	-09/95
2.5 TD/S 525	-09/95		
2.5 TDS 525 Touring	-09/95		

Série 5 E39 ...

Eléments DIRECTION

Steering parts

Elementos Direcciones

Elementy układ kierowniczy

Элементы рулевой системы

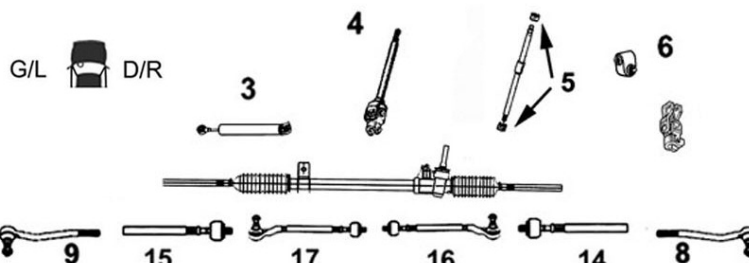

9006818

Axe de bielle G/D

Part/oe 32111094674

L/R axial joint



14 Côté dir. M18x1.5 Côté rot. M16x1.0 L 173mm

15 2.0i 520	BVM BVA-08/00	2.5 TD 525	-08/00
2.0i 520 4ptes/ Touring	BVM BVA 09/00-	2.5 TD 525 4ptes/Touring	BVM BVA 09/00-
2.0 D 520D	-08/00	2.5 TDS 525	BVM BVA -08/00
2.0 D 520D 4ptes/Touring	BVM 09/00-	2.8i 528	BVM BVA -08/00
2.2i	07/00-07/03	3.0i 530 4ptes/Touring	BVM BVA 09/00-
2.2i Touring	07/00-03/04	3.0D 530 4ptes/Touring	BVM BVA 09/00-
2.5i 523	BVM BVA -08/00		
2.5i 525 4ptes/Touring	BVM BVA 09/00-		

9006423

Rotule de direction G

Part/oe 32111094673

Left tie rod end



9 M16 x 1.0

2.0i 520	BVM BVA-08/00
2.0i 520 4ptes/ Touring	BVM BVA 09/00-
2.0 D 520	-08/00
2.0 D 520 4ptes/Touring	BVM 09/00-
2.2i 520 4ptes /Touring	
2.5i 523 /Touring	BVM BVA -08/00
2.5i 525 4ptes /Touring	BVM BVA 09/00-
2.5 D 525 /Touring	BVM BVA 04/00-
2.5 TD/S 525	BVM BVA -08/00
2.8i 528	BVM BVA-08/00
3.0i 530 4ptes	BVM BVA 09/00-
3.0i 530 Touring	BVM BVA 09/00-
3.0 D 530 /Touring	BVM BVA 08/98-
3.0 D 530 Touring	BVM BVA 09/00-

9006422

Rotule de direction D

Part/oe 32111094674

Right tie rod end



8 M16 x 1.0

2.0i 520	BVM BVA-08/00
2.0i 520 4ptes/ Touring	BVM BVA 09/00-
2.0 D 520	-08/00
2.0 D 520 4ptes/Touring	BVM 09/00-
2.2i 520 4ptes /Touring	
2.5i 523 /Touring	BVM BVA -08/00
2.5i 525 4ptes /Touring	BVM BVA 09/00-
2.5 D 525 /Touring	BVM BVA 04/00-
2.5 TD/S 525	BVM BVA -08/00
2.8i 528	BVM BVA-08/00
3.0i 530 4ptes	BVM BVA 09/00-
3.0i 530 Touring	BVM BVA 09/00-
3.0 D 530 /Touring	BVM BVA 08/98-
3.0 D 530 Touring	BVM BVA 09/00-

... Série 5 E39 ...



Barre stabilisatrice
 Stabilizer bar
 Barra estabilizadora
 Drążek stabilizatora
 стабилизатор поперечной устойчивости

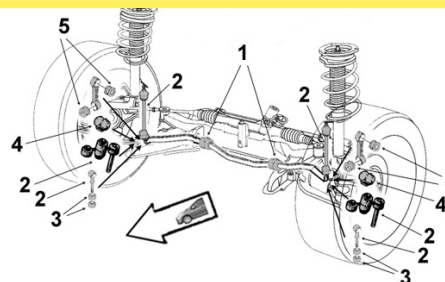

BMW



9005054	Biellette barre stab. G	9005056	Biellette barre stab. D
OE 31351095661	<i>Left stabilizer bar stub axle</i>	OE 31351095662	<i>Right stabilizer bar stub axle</i>
	2		2
	2.0 520i /Touring		2.0 520i /Touring
	2.0 D 520D /Touring BVM		2.0 D 520D /Touring BVM
	2.2 520i /Touring 07/00-		2.2 520i /Touring 07/00-
	2.5 523i -08/00		2.5 523i -08/00
	2.5 525i BVM /Touring 07/00-		2.5 525i BVM /Touring 07/00-
	2.5 D 525 /Touring 04/00-07/00		2.5 D 525 /Touring 04/00-07/00
	2.5 TD 525 BVM 08/00		2.5 TD 525 BVM 08/00
	2.5 TD 525D /Touring 01/00-		2.5 TD 525D /Touring 01/00-
	2.5 TDS 525TDS -08/00		2.5 TDS 525TDS -08/00
	2.8 528i -08/00		2.8 528i -08/00
	3.0 530i /Touring		3.0 530i /Touring
	3.0 D 530D /Touring		3.0 D 530D /Touring



Autres pièces
 Other parts
 Otras piezas
 Inne części
 другие части

9001565	Art. tirant de chasse	
OE 31129068753	<i>Rod bushing</i>	
	Ø int.12 Ø ext.58 long. tube int.68 ext.60	
	2.0 520i /Touring	
	2.0 D 520D	
	2.0 D 520D Touring	BVM
	2.5 523i	-08/00
	2.5 525i BVM /Touring	07/00-
	2.5 TD 525D /Touring	01/00-
	2.5 TD/S 525TD/S	-08/00
	2.8 528i	-08/00
	3.0 530i /Touring	07/00-
3.0 D 530D /Touring		

... Série 5 E39 ...

SASIC

BMW

Bras & Triangle de suspension

Control arm
Brazo y triángulo
Wahacz
Рычаг подвески

G/L  D/R



7476011

Bras de susp. AR inf. G

OE 31121094233

Left rear lower track control arm

4	Avec rotule With ball joint	
	2.0i 520 150hp 110kw /Touring	07/96-07/00
	2.0 D 520 /Touring BVM	04/00-07/03
	2.2i 520 /Touring	07/00-03/04
	2.5i 523 /Touring	12/95-07/00
	2.5i 525 /Touring	07/00-03/04
	2.5 D 525 /Touring	04/00-07/03
	2.5 TD 525 BVM	09/97-06/03
	2.5 TDS 325 /Touring	02/96-05/04
	2.5 TDS 525 Touring	03/97-04/00
	2.8i 528 /Touring	12/95-07/00
	3.0i 530 /Touring	07/00-03/04
	3.0 D 530 /Touring	10/98-07/03



7476010

Bras de susp. AR inf. D

OE 31121094234

Right rear lower track control arm

3	Avec rotule With ball joint	
	2.0i 520 150hp 110kw /Touring	07/96-07/00
	2.0 D 520 /Touring BVM	04/00-07/03
	2.2i 520 /Touring	07/00-03/04
	2.5i 523 /Touring	12/95-07/00
	2.5i 525 /Touring	07/00-03/04
	2.5 D 525 /Touring	04/00-07/03
	2.5 TD 525 BVM	09/97-06/03
	2.5 TDS 325 /Touring	02/96-05/04
	2.5 TDS 525 Touring	03/97-04/00
	2.8i 528 /Touring	12/95-07/00
	3.0i 530 /Touring	07/00-03/04
	3.0 D 530 /Touring	10/98-07/03



7476025

Bras de susp. AV inf. G

OE 31121141717

L front lower track control arm

4	Avec rotule With ball joint	
	2.0i 520 /Touring	07/96-05/04
	2.0 D 520 /Touring	04/00-09/03
	2.2i 520 /Touring	07/00-03/04
	2.5i 523 /Touring	12/95-07/00
	2.5i 525 /Touring	07/00-03/04
	2.5 D 525 /Touring	04/00-03/04
	2.5 TD 525	09/97-04/00
	2.5 TDS 525 /Touring	02/96-05/04
	2.8i 528 /Touring	12/95-07/00
	3.0i 530 /Touring	07/00-03/04
	3.0 D 530 Touring	10/98-03/04



7476024

Bras de susp. AV inf. D

OE 31121141718

R front lower track control arm

3	Avec rotule With ball joint	
	2.0i 520 /Touring	07/96-05/04
	2.0 D 520 /Touring	04/00-09/03
	2.2i 520 /Touring	07/00-03/04
	2.5i 523 /Touring	12/95-07/00
	2.5i 525 /Touring	07/00-03/04
	2.5 D 525 /Touring	04/00-03/04
	2.5 TD 525	09/97-04/00
	2.5 TDS 525 /Touring	02/96-05/04
	2.8i 528 /Touring	12/95-07/00
	3.0i 530 /Touring	07/00-03/04
	3.0 D 530 Touring	10/98-03/04



Support d'amortisseur

Suspension mounting
Soporte amortiguador
Poduszka amortyzatora
Опора амортизатора

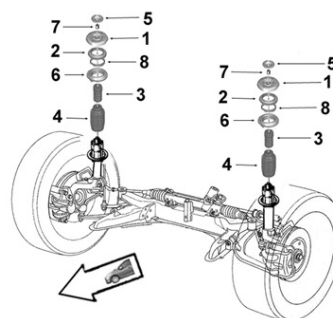

9005629

Support suspension G/D

OE 31331091709

L/R suspension mounting

1		
	2.0i 520	-08/97
	2.5i 523	-08/97
	2.5 TD 525TD	-08/97
	2.5 TDS 525	-08/97
	2.8i 528	-08/97



9001422

Support suspension G/D

OE 31336770568

L/R suspension mounting

1	Avec roulement With bearing	
	2.0i 520 /Touring	09/97-
	2.0 D 520D /Touring BVM	09/97-
	2.2i 520 /Touring	09/97-
	2.5i 525 BVM /Touring	09/97-
	2.5 TD 525D /Touring	09/97-
	3.0i 530 /Touring	09/97-
	3.0 D 530D /Touring	09/97-



... Série 5 E39

BMW

SASIC

2656033

Protecteur amortisseur G/D

OE 31331091868

L/R shock absorber protector



4

2.0i 520	M52B20 (206S3/4)	BVM5	07/96-07/00
2.0 D 520	M47D20 (204D1)		04/00-07/00
2.5i 523	M52B25 (256S4)		12/95-07/00
2.5 D 525	M57 (256D1)		04/00-07/00
2.5 TD 525	M51D25 (256T1)	BVM5	10/95-04/00
2.5 TDS 525 Berline	M51D25 (256T1)		02/96-04/00
2.5 TDS 525 Touring	M51TU (256T1)		03/97-04/00
2.8i 528	M52B28 (286S1/2)		12/95-07/00
3.0 D 530	M57D30 (306D1)		10/98-07/00
3.5i 535	M62 (358S1)		07/96-06/98



Barre stabilisatrice

Stabilizer bar

Barra estabilizadora

Drażek stabilizatora

стабилизатор поперечной устойчивости

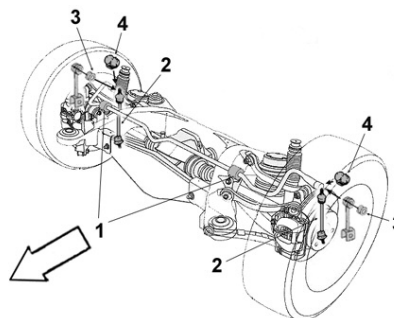

9005059

Biellette barre stab.

OE 33551095532

Stabilizer bar stub axle



2

2.0 520i /Touring		2.8 528i	-08/00
2.0 D 520D BVM /Touring	BVM	3.0 530i /Touring	07/00-
2.2 520i /Touring	07/00-	3.0 D 530D /Touring	
2.5 523i	-08/00	3.5 535i	
2.5 525i /Touring	07/00-	4.4 540i /Touring	
2.5 TD 525 BVM	-08/00		
2.5 TD 525D /Touring	01/00-		
2.5 TDS 525TDS	-08/00		

Eléments TRAIN ARRIERE

Rear axle parts

Tren TRAS

Elementy zawieszenia tylnego

элементы задней оси.



9001418

Art. support pont G/D AR

OE 33171093008

Rear L R axle mounting bush



Ø int.13 Ø ext.69 long. tube int.59 ext.42

2.0 520i /Touring		2.5 TD 525D Touring	01/00-
2.0 D 520D BVM /Touring	BVM	2.5 TDS 525TDS	
2.2 520i /Touring	07/00-	2.8 528i	-08/00
2.5 523i	-08/00	3.0 530i /Touring	
2.5 525i BVM /Touring	BVM	3.0 D 530D /Touring	
2.5 TD 525D	01/00-	3.5 535i	
2.5 TD 525TD BVM		4.4 540i /Touring	

9001556

Articulation essieu AR G/D

OE 33311091422

L/R Rear axle bush



Ø int.19 Ø ext.80 coll.92 long. tube int.85 ext.80 ep. coll.10

2.0 520i		2.8 528i	-08/00
2.0 D 520D		3.0 530i	07/00-
2.2 520i /Touring	07/00-	3.0 D 530D	
2.5 523i	-08/00	3.5 535i	
2.5 525i	07/00-	4.4 540i	
2.5 TD 525D/TD			
2.5 TDS 525TDS	-08/00		

Série 5 E60 ...

Eléments DIRECTION

Steering parts

Elementos Direcciones

Elementy uklad kierowniczy

Элементы рулевой системы

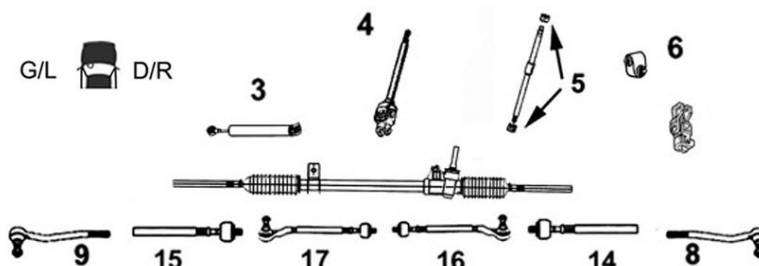

7776020 Axe de bielle G/D

Part/oe 32106777479 L/R axial joint



14 Côté dir. M18x1.5 Côté rot. M16x1.5 long 240 mm

15	2.0i 520	09/07-12/09	3.0i 530	07/03-12/09
	2.0 D 520	09/05-12/09	3.0 D 525 535	03/07-12/09
	2.2i 520	03/04-03/05	3.0 D 530	07/03-12/09
	2.5i 523	03/07-12/09	4.0i 540	07/05-12/09
	2.5i 525	09/03-03/07	4.4i 545	09/03-09/05
	2.5 D 525	06/04-03/07	4.8i 550	09/05-12/09
	3.0i 525	03/07-12/09	5.0i V10 40v.	M5 09/04-12/09

7676018 Rotule de direction G/D

OE 32106776946 L/R tie rod end



8 M16 x 1.5

9	2.0i 520	07/05-	3.0 D 530	07/03-
	2.0 D 520	09/05-	3.0 D 525	03/07-
	2.2i 520	03/04-	3.0 D 535	09/04-
	2.5i 523	03/05-	4.0i 540	09/05-
	2.5i 525	09/03-	4.4i 545	09/03-
	2.5 D 525	03/04-	4.8i 550	09/05-
	3.0i 525	03/07-	5.0i V10 40v.	M5 09/04-
	3.0i 530	06/04-		



Barre stabilisatrice

Stabilizer bar

Barra estabilizadora

Drażek stabilizatora

стабилизатор поперечной устойчивости

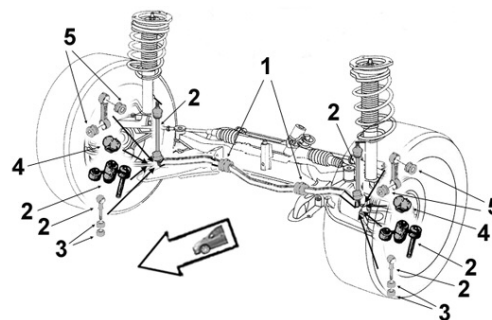

2306064 Biellette barre stab. G

OE 31306781547 Left stabilizer bar stub axle



2	2.0i 520	07/07-12/09
	2.0 D 520 DPF	09/05-12/09
	2.2i 520	03/04-03/05
	2.5i 523	03/05-12/09
	2.5i 525	09/03-03/07
	2.5 D 525 DPF	03/04-03/07
	3.0i 525	03/07-12/09
	3.0i 530	07/03-12/09
	3.0 D 525	03/07-12/09
	3.0 D 530 /FAP /DPF	07/03-12/09
	3.0 D 530 4WD DPF	09/05-03/07
	3.0 D 535	03/07-12/09
	4.0i 540	09/05-12/09
	4.4i 545	09/03-09/05
	4.8i 550	09/05-12/09
	5.0i V10 40v. M5	09/04-12/09

2306063 Biellette barre stab. D

OE 31306781548 Right stabilizer bar stub axle



2	2.0i 520	07/07-12/09
	2.0 D 520 DPF	09/05-12/09
	2.2i 520	03/04-03/05
	2.5i 523	03/05-12/09
	2.5i 525	09/03-03/07
	2.5 D 525 DPF	03/04-03/07
	3.0i 525	03/07-12/09
	3.0i 530	07/03-12/09
	3.0 D 525	03/07-12/09
	3.0 D 530 /FAP /DPF	07/03-12/09
	3.0 D 530 4WD DPF	09/05-03/07
	3.0 D 535	03/07-12/09
	4.0i 540	09/05-12/09
	4.4i 545	09/03-09/05
	4.8i 550	09/05-12/09
	5.0i V10 40v. M5	09/04-12/09

... Série 5 E60 ...

2306108
Palier de barre milieu

OE 31356761591

Middle bar main bearing

1
Ø 24

2.0i 520	03/04-12/09
2.0 D 520	05/03-12/09
2.2i 520	03/04-03/05
2.5i 523	03/05-12/09
2.5i 525	09/03-03/10
2.5 D 525	03/04-03/10

3.0i 525	03/07-12/09
3.0i 530	07/03-12/09
3.0 D 525 535	03/07-12/09
3.0 D 530 /4WD	07/03-12/0
4.0i 540	03/07-12/09
4.8i 550	03/07-12/09

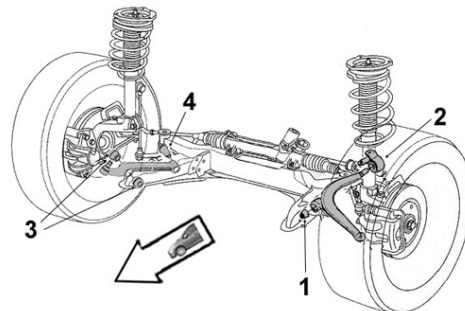
Eléments SUSPENSION
Suspension parts
Elementos suspensión
Elementy zawieszenia
Элементы подвески

2256039
Articulation AV

OE 31120305612

Front bush

1
Ø int. 12 Ø ext. 70 long. tube int. 76 ext 65

2.0i 520	07/07-12/09
2.0 D 520 /DPF	03/07-12/09
2.2i 520	03/04-03/05
2.5i 523	03/07-12/09
2.5i 525	09/03-03/05
3.0i 525	03/07-12/09
3.0i 530	07/03-12/09

3.0 D 525	03/07-12/09
3.0 D 530	07/03-12/09
3.0 D 535	03/07-12/09
4.0i 540	03/07-12/09
4.4i 545	09/03-09/05
4.8i 550	03/07-12/09
5.0i V10 40v. M5	03/07-12/09

Bras & Triangle de suspension
Control arm
Brazo y triángulo
Wahacz
Рычаг подвески

G/L D/R

7476028
Bras de susp. AR inf. G

OE 31126768297

Left rear lower track control arm
4
Avec rotule With ball joint

2.0i 520	07/03-12/09
2.0 D 520	07/05-12/09
2.5i 523	07/05-12/09
2.5i 525	09/03-12/09
2.5 D 525	09/03-12/09
3.0i 525	03/07-12/09
3.0i 530	07/03-12/09
3.0 D 525	01/07-12/09
3.0 D 530	07/03-12/09
3.0 D 535	09/04-12/09
4.0i 540	07/05-12/09
4.4i 545	09/03-12/09
4.8i 550	07/05-12/09
5.0i V10 40v. M5	09/04-12/09

OE 31126760181

2.2i 520	03/04-03/05
----------	-------------

7476027
Bras de susp. AR inf. D

OE 31126768298

Right rear lower track control arm
3
Avec rotule With ball joint

2.0i 520	07/03-12/09
2.0 D 520	07/05-12/09
2.5i 523	07/05-12/09
2.5i 525	09/03-12/09
2.5 D 525	06/04-12/09
3.0i 525	03/07-12/09
3.0i 530	07/03-12/09
3.0 D 525	01/07-12/09
3.0 D 530	07/03-12/09
3.0 D 535	09/04-12/09
4.0i 540	07/05-12/09
4.4i 545	09/03-12/09
4.8i 550	07/05-12/09
5.0i V10 40v. M5	09/04-12/09

OE 31126760182

2.2i 520	03/04-03/05
----------	-------------

... Série 5 E60 ...

SASIC

BMW

Bras & Triangle de suspension

Control arm
Brazo y triángulo
Wahacz
Рычаг подвески

G/L  D/R

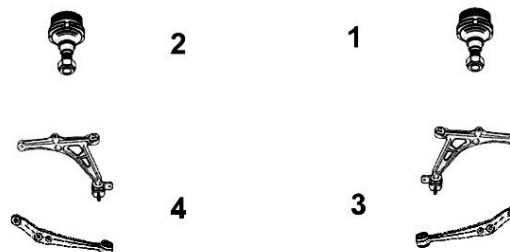

7476013

Bras de susp. AV inf. G

OE 31126774825

L front lower track control arm

4 Avec rotule With ball joint

2.0i 520	07/07-12/09
2.0 D 520	09/05-12/09
2.2i 520	03/04-03/05
2.5i 523	03/05-12/09
2.5i 525	09/03-03/07
2.5 D 525	03/04-03/07
3.0i 525	03/07-12/09
3.0i 530	07/03-12/09
3.0 D 525 BVA	03/07-12/09
3.0 D 530 /4WD	07/03-12/09
3.0 D 535 BVA	09/04-12/09
4.0i 540	09/05-12/09
4.4i 545	09/03-09/05
4.8i 550	09/05-12/09
5.0i V10 40v. M5 BV robotisée	09/04-12/09



7476012

Bras de susp. AV inf. D

OE 31126774826

R front lower track control arm

3 Avec rotule With ball joint

2.0i 520	07/07-12/09
2.0 D 520	09/05-12/09
2.2i 520	03/04-03/05
2.5i 523	03/05-12/09
2.5i 525	09/03-03/07
2.5 D 525	03/04-03/07
3.0i 525	03/07-12/09
3.0i 530	07/03-12/09
3.0 D 525 BVA	03/07-12/09
3.0 D 530 /4WD	07/03-12/09
3.0 D 535 BVA	09/04-12/09
4.0i 540	09/05-12/09
4.4i 545	09/03-09/05
4.8i 550	09/05-12/09
5.0i V10 40v. M5 BV robotisée	09/04-12/09



Support d'amortisseur

Suspension mounting
Soporte amortiguador
Poduszka amortyzatora
Опора амортизатора

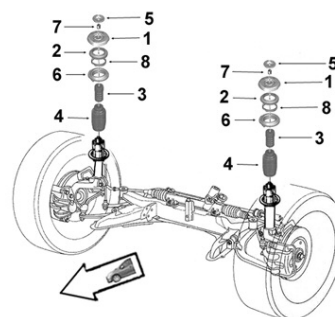

9001422

Support suspension G/D

OE 31336770568

L/R suspension mounting

1 Avec roulement With bearing

2.0i 520	07/07-
2.0 D 520	07/05-
2.2i 520	03/04-
2.5i 523	03/07-
2.5i 525	09/03-
2.5 D 525	06/04-03/10
3.0i 525 /4WD	03/07-
3.0i 530 /4WD	07/03-
3.0 D 525 /4WD	03/07-
3.0 D 530	03/07-
3.0 D 530 /4WD	07/03-
3.0 D 535	03/07-
4.0i 540	07/05-
4.4i 545	09/03-
4.8i 550	07/05-



... Série 5 E60



Barre stabilisatrice

Stabilizer bar
Barra estabilizadora
Drażek stabilizatora
стабилизатор поперечной устойчивости

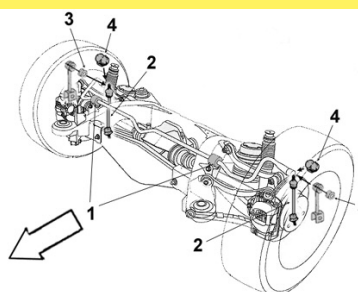

2306065

Biellette barre stab.

OE 33506781540

Stabilizer bar stub axle



2

2.0i 520	07/03-	3.0 D 525 /4WD	06/04-
2.0 D 520	07/05-	3.0 D 530 /4WD	07/03-
2.2i 520	07/03-	3.0 D 535	09/04-
2.5i 523	07/05-	4.0i 540	09/05-
2.5i 525 /4WD	09/03-	4.4i 545	09/03-
2.5 D 525	12/04-	4.8i 550	09/05-
3.0i 525 /4WD	09/03-	5.0i V10 40v. M5	09/04-
3.0i 530 /4WD	07/03-		

Série 5 E61 ...

Eléments DIRECTION

Steering parts
Elementos Direcciones
Elementy układ kierowniczy
Элементы рулевой системы

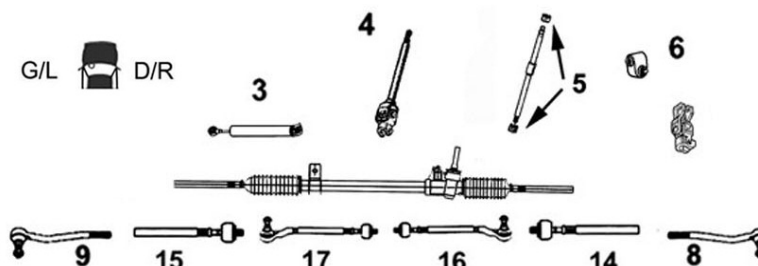

7776020

Axe de bielle G/D

Part/oe 32106777479 L/R axial joint



14

15

Côté dir. M18x1.5 Côté rot. M16x1.5 long 240 mm

2.0i 520 Touring	09/07-
2.0 D 520 Touring /DPF Touring	07/05-
2.2i 520 Touring	06/04-
2.5i 523 Touring	07/05-
2.5i 525 Touring	03/04-03/07
2.5i 525 4WD Touring	03/05-03/07
2.5 D 525 Touring	06/04-
3.0i 525 Touring	03/07-
3.0i 530 Touring	06/04-
3.0i 530 4WD Touring	03/05-03/07
3.0 D 525 Touring	03/07-
3.0 D 530 DPF Touring	03/04-
3.0 D 530 Touring	03/04-
3.0 D 530 4WD DPF Touring	07/05-03/07
3.0 D 535 Touring /DPF Touring	09/04-
4.4i 545 Touring	06/04-
4.8i 550 Touring	07/05-
5.0i V10 40v. M5 Touring	03/07-

7676018

Rotule de direction G/D

OE 32106776946 L/R tie rod end



8

9

M16 x 1.5

2.0i 520 Touring	06/04-
2.0 D 520 Touring /DPF Touring	07/05-
2.5i 523 Touring	07/05-
2.5i 525 Touring /4WD Touring	03/05-03/07
2.5 D 525 DPF Touring	03/04-03/07
3.0i 525 Touring	06/04-
3.0i 530 Touring /4WD	03/05-
3.0 D 525 Touring /4WD	06/04-
3.0 D 530 Touring /DPF Touring	03/04-
3.0 D 530 DPF Touring	03/04-03/07
3.0 D 530 4WD DPF Touring	07/05-03/07
3.0 D 535 Touring /DPF Touring	09/04-
4.4i 545i Touring	06/04-
4.8i 550 Touring	07/05-
5.0i V10 40v. M5 Touring	03/07-

... Série 5 E61 ...

SASIC

BMW



Barre stabilisatrice
 Stabilizer bar
 Barra estabilizadora
 Drażek stabilizatora
 стабилизатор поперечной устойчивости

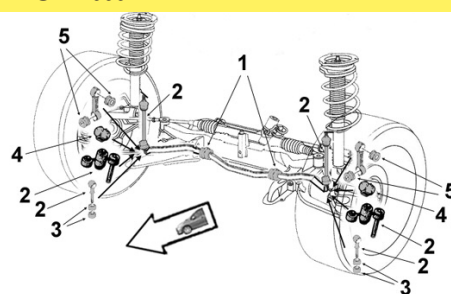

2306064 **Biellette barre stab. G**
 OE 31306781547 *Left stabilizer bar stub axle*

	2	2.0i 520 Touring	09/07-
		2.0 D 520 Touring /DPF Touring	09/05-
		2.5i 523 Touring	03/05-
		2.5i 525 Touring /DPF Touring	03/04-03/07
		2.5 D 525 DPF Touring	03/04-03/07
		3.0i 525 Touring	03/07-
		3.0i 530 Touring	03/05-
		3.0 D 525 Touring	03/07-
		3.0 D 530 Touring /DPF Touring	03/04-
		3.0 D 535 Touring /DPF Touring	09/04-
		4.4i 545 Touring	03/04-03/07
		4.8i 550 Touring	09/05-
	5.0i V10 40v. M5 Touring	03/07-	

2306063 **Biellette barre stab. D**
 OE 31306781548 *Right stabilizer bar stub axle*

	2	2.0i 520 Touring	09/07-
		2.0 D 520 Touring /DPF Touring	09/05-
		2.5i 523 Touring	03/05-
		2.5i 525 Touring /DPF Touring	03/04-03/07
		2.5 D 525 DPF Touring	03/04-03/07
		3.0i 525 Touring	03/07-
		3.0i 530 Touring	03/05-
		3.0 D 525 Touring	03/07-
		3.0 D 530 Touring /DPF Touring	03/04-
		3.0 D 535 Touring /DPF Touring	09/04-
		4.4i 545 Touring	03/04-03/07
		4.8i 550 Touring	09/05-
	5.0i V10 40v. M5 Touring	03/07-	

2306108 **Palier de barre milieu**
 OE 31356761591 *Middle bar main bearing*

	1	Ø 24	
		2.0i 520	09/07-05/10
		2.0 D 520	09/05-05/10
		2.5i 523	03/05-05/10
		2.5i 525	03/04-03/07
		2.5 D 525	03/04-03/07
		3.0i 525	03/07-05/10
		3.0i 530	03/05-05/10
		3.0 D 525 535	03/07-05/10
		3.0 D 530	03/04-05/10
	4.8i 550	03/07-05/10	



Eléments SUSPENSION
 Suspension parts
 Elementos suspensión
 Elementy zawieszenie
 Элементы подвески

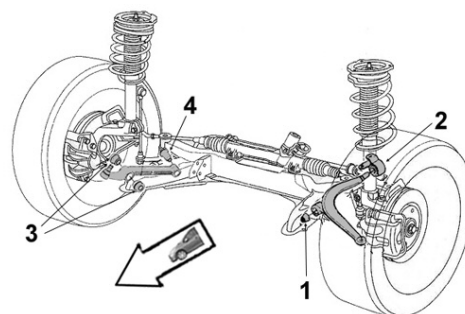

2256039 **Articulation AV**
 OE 31120305612 *Front bush*

	1	Ø int. 12 Ø ext. 70 long. tube int. 76 ext 65	
		2.0i 520 Touring	09/07-
		2.0 D 520 Touring /DPF Touring	03/07-
		2.5i 523 Touring	03/07-
		3.0i 525 Touring	03/07-
		3.0i 530 Touring	03/07-
		3.0 D 525 530 535 Touring	03/07-
		4.8i 550 Touring	03/07-
	5.0i V10 40v. M5 Touring	03/07-	

... Série 5 E61 ...

Bras & Triangle de suspension



Control arm
Brazo y triángulo
Wahacz
Рычаг подвески

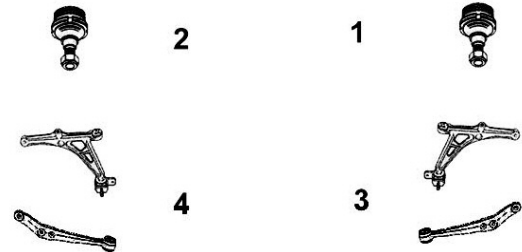

G/L  D/R



BMW



7476028	Bras de susp. AR inf. G OE 31126768297	Left rear lower track control arm	7476027	Bras de susp. AR inf. D OE 31126768298	Right rear lower track control arm				
	4	Avec rotule <i>With ball joint</i>		3	Avec rotule <i>With ball joint</i>				
						2.0i 520 Touring	06/04-	2.0i 520 Touring	06/04-
						2.0 D 520 Touring	07/05-	2.0 D 520 Touring	07/05-
						2.5i 523 Touring	07/05-	2.5i 523 Touring	07/05-
						2.5i 525 Touring	06/04-	2.5i 525 Touring	06/04-
						2.5 D 525 Touring	06/04-	2.5 D 525 Touring	06/04-
						3.0i 525 Touring	03/07-	3.0i 525 Touring	03/07-
						3.0i 530 Touring	06/04-	3.0i 530 Touring	06/04-
						3.0 D 525 Touring	03/07-	3.0 D 525 Touring	03/07-
						3.0 D 530 Touring	06/04-	3.0 D 530 Touring	06/04-
3.0 D 535 Touring	09/04-	3.0 D 535 Touring	09/04-						
4.4i 545 Touring	06/04-	4.4i 545 Touring	06/04-						
4.8i 550 Touring	07/05-	4.8i 550 Touring	07/05-						
5.0i V10 40v. M5	03/07-	5.0i V10 40v. M5	03/07-						

7476013	Bras de susp. AV inf. G OE 31126774825	L front lower track control arm	7476012	Bras de susp. AV inf. D OE 31126774826	R front lower track control arm				
	4	Avec rotule <i>With ball joint</i>		3	Avec rotule <i>With ball joint</i>				
						2.0i 520 Touring	06/04-	2.0i 520 Touring	06/04-
						2.0 D 520 Touring /DPF Touring	06/04-	2.0 D 520 Touring /DPF Touring	06/04-
						2.5i 523 Touring	07/05-	2.5i 523 Touring	07/05-
						2.5i 525 Touring	03/04-03/07	2.5i 525 Touring	03/04-03/07
						2.5 D 525 DPF Touring	03/04-03/07	2.5 D 525 DPF Touring	03/04-03/07
						3.0i 525 Touring	01/07-	3.0i 525 Touring	01/07-
						3.0i 530 Touring	06/04-	3.0i 530 Touring	06/04-
						3.0 D 525 Touring	06/04-	3.0 D 525 Touring	06/04-
						3.0 D 530 Touring /DPF Touring	03/04-	3.0 D 530 Touring /DPF Touring	03/04-
3.0 D 535 Touring /DPF Touring BVA	09/04-	3.0 D 535 Touring /DPF Touring BVA	09/04-						
4.4i 545 Touring	03/04-03/07	4.4i 545 Touring	03/04-03/07						
4.8i 550 Touring	07/05-	4.8i 550 Touring	07/05-						
5.0i V10 40v. M5 Touring BV rob.	03/07-	5.0i V10 40v. M5 Touring BV rob.	03/07-						

... Série 5 E61

SASIC



Support d'amortisseur
 Suspension mounting
 Soporte amortiguador
 Poduszka amortyzatora
 Опора амортизатора

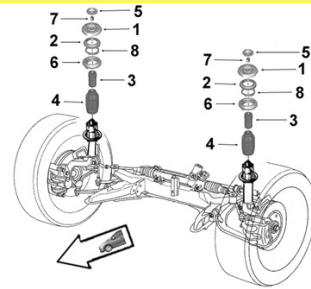

9001422

Support suspension G/D

OE 31336770568

L/R suspension mounting



1 Avec roulement With bearing

2.0i 520 Touring	03/07-
2.0 D 520 Touring	07/05-
2.5i 523 525 Touring	06/04-
2.5 D 525 Touring	06/04-
3.0i 525 Touring /4WD	03/07-
3.0i 530 Touring /4WD	06/04-

3.0 D 525 Touring /4WD	03/07-
3.0 D 530 Touring /4WD	06/04-
3.0 D 535 Touring	09/04-
4.4 545 Touring	06/04-
4.8i 550 Touring	07/05-



Barre stabilisatrice

Stabilizer bar
 Barra estabilizadora
 Drążek stabilizatora
 стабилизатор поперечной устойчивости

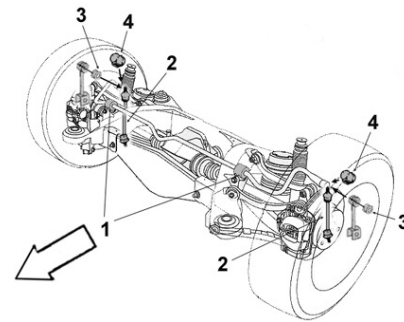

2306065

Biellette barre stab.

OE 33506781540

Stabilizer bar stub axle



2 2.0i 520 Touring	06/04-
2.0 D 520 Touring /DPF Touring	07/05-
2.5i 523 Touring	07/05-
2.5i 525 Touring /DPF Touring /4WD	06/04-
2.5 D 525 DPF Touring	03/04-03/07
3.0i 525 Touring	03/07-
3.0i 530 Touring /4WD	06/04-

3.0 D 525 Touring /4WD	01/07-
3.0 D 530 Touring /DPF Touring /4WD	03/04-
3.0 D 535 Touring	09/04-
4.4i 545 Touring	06/04-
4.8i 550 Touring	07/05-
5.0i V10 40v. M5 Touring	03/07-

Série 6 E63 ...

Eléments DIRECTION

Steering parts
 Elementos Direcciones
 Elementy układu kierowniczy
 Элементы рулевой системы

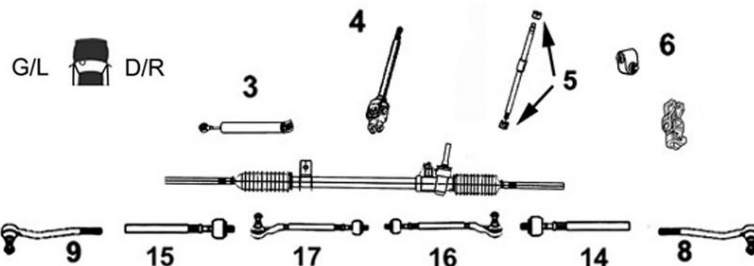

7776020

Axe de bielle G/D

Part/oe 32106777479 L/R axial joint



14 Côté dir. M18x1.5	Côté rot. M16x1.5
15 long 240 mm	
3.0i 630	09/04-
3.0 D 635	07/07-
4.4i 645	09/03-
4.8i 650	07/05-
5.0i V10 40v. M6	09/05-

7676018

Rotule de direction G/D

OE 32106776946

L/R tie rod end



8	M16 x 1.5
9	
3.0i 630	09/04-
3.0 D 635	07/07-
4.4i 645	09/03-
4.8i 650	07/05-
5.0i V10 40v. M6	09/05-

... Série 6 E63



Barre stabilisatrice
 Stabilizer bar
 Barra estabilizadora
 Drażek stabilizatora
 стабилизатор поперечной устойчивости

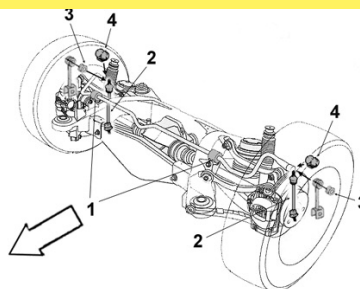

2306065 **Biellette barre stab.**
 OE 33506781540 *Stabilizer bar stub axle*



2

3.0i 630
 3.0 D 635
 4.4i 645 /M6
 4.8i 650
 5.0i V10 40v. M6

09/04-
 09/07-
 09/03-
 07/05-
 09/05-

Série 6 E64

Eléments DIRECTION
 Steering parts
 Elementos Direcciones
 Elementy układu kierowniczy
 Элементы рулевой системы

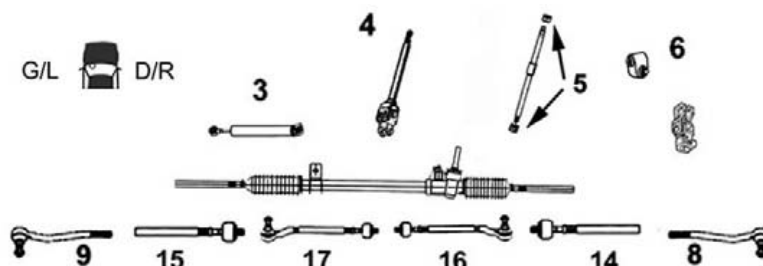

7776020 **Axe de bielle G/D**
 Part/oe 32106777479 *L/R axial joint*



14 Côté dir. M18x1.5 Côté rot. M16x1.5
 15 long 240 mm

3.0i 630 09/04-
 3.0 D 635 07/07-
 4.4i 645 04/04-
 4.8i 650 07/05-
 5.0i V10 40v. M6 07/06-

7676018 **Rotule de direction G/D**
 OE 32106776946 *L/R tie rod end*



8
 9 M16 x 1.5

3.0i 630 09/04-
 3.0 D 635 07/07-
 4.4i 645 04/04-
 4.8i 650 07/05-
 5.0i V10 40v. M6 07/06-



Barre stabilisatrice
 Stabilizer bar
 Barra estabilizadora
 Drażek stabilizatora
 стабилизатор поперечной устойчивости

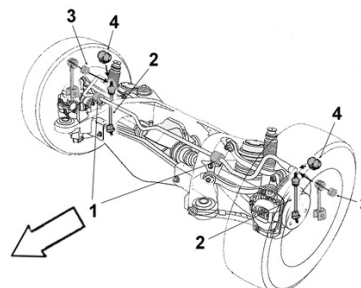

2306065 **Biellette barre stab.**
 OE 33506781540 *Stabilizer bar stub axle*



2

3.0i 630
 3.0 D 635
 4.4i 645
 4.8i 650
 5.0i V10 40v. M6

07/07-
 09/07-
 04/04-
 09/05-
 09/06-

Série 7 E32

Eléments DIRECTION

Steering parts

Elementos Direcciones

Elementy uklad kierowniczy

Элементы рулевой системы

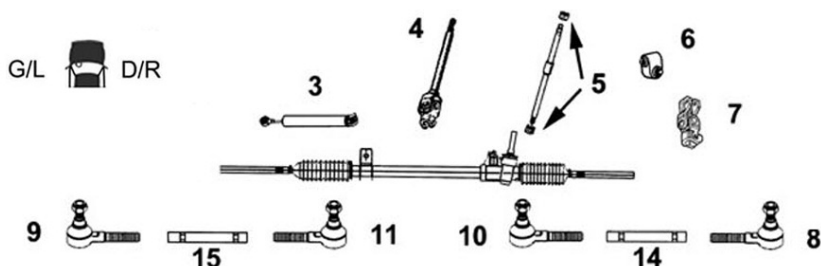

9006255 Bielle de direction G/D

OE 32211135666 L/R steering rod



8 M14 x 1.5
9
10
11
14 TT /all models
15

9006323 Rotule de direction G/D Int.

OE 32211135819 L/R inner tie rod end



10 Filetage pas à gauche left-hand thread
11 M14 x 1.5
TT /all models

9006324 Rotule de direction G/D

OE 32211135820 L/R tie rod end



8 Filetage pas à droite Right-hand thread
9 M14 x 1.5
TT /all models

Série 7 E65

Eléments DIRECTION

Steering parts

Elementos Direcciones

Elementy uklad kierowniczy

Элементы рулевой системы

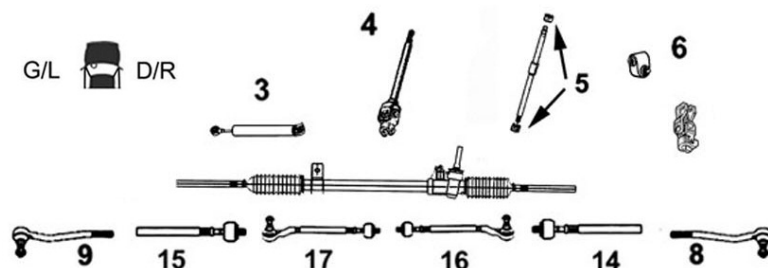

7676018 Rotule de direction G/D

OE 32106776946 L/R tie rod end



8 M16 x 1.5
9 3.0i 730
3.0 D 730
3.6i 735
4.0i 740
4.0 D 740
4.4i 745
4.4 D 745
4.8i 750
6.0i 760

Série 7 E66

Eléments DIRECTION

Steering parts

Elementos Direcciones

Elementy układu kierowniczy

Элементы рулевой системы

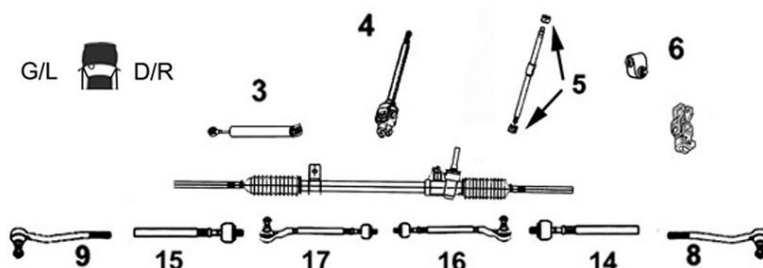

7676018

Rotule de direction G/D

OE 32106776946

L/R tie rod end



8
9

M16 x 1.5

3.0i 730	Limousine
3.0 D 730	Limousine
4.0i 740	Limousine
4.8i 750	Limousine
6.0i 760	Limousine

X1 ...

Eléments DIRECTION

Steering parts

Elementos Direcciones

Elementy układu kierowniczy

Элементы рулевой системы

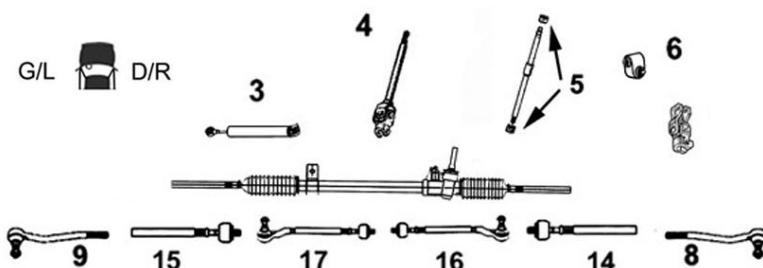

9006811

Axe de bielle G/D

Part/oe 32216762244

L/R axial joint



14
15

Côté dir. M18x1.5 Côté rot. M14x1.5
long 247 mm

2.0i	03/10-
2.0 D	07/09-

7776080

Axe de bielle G/D

OE 3210676907

L/R axial joint

NEW



14
15

Côté dir. M18x1.5 Côté rot. M14x1.5
long 260 mm

2.0i 4WD X Drive	09/11-
2.0 D 4WD X Drive	10/09-
3.0i 4WD X Drive	10/09-

7676017

Rotule de direction G

OE 32106765089

Left tie rod end



9

M14 x 1.5

2.0i	03/10-
2.0 D	07/09-

7676015

Rotule de direction D

OE 32106765090

Right tie rod end



8

M14 x 1.5

2.0i	03/10-
2.0 D	07/09-

7676062

Rotule de direction G

OE 32106793623

Left tie rod end



NEW

9

M14 x 1.5

2.0i 4WD X Drive	04/11-
2.0 D 4WD X Drive	10/09-
3.0i 4WD X Drive	10/09-

7676063

Rotule de direction D

OE 32106793624

Right tie rod end



NEW

8

M14 x 1.5

2.0i 4WD X Drive	04/11-
2.0 D 4WD X Drive	10/09-
3.0i 4WD X Drive	10/09-

... X1 ...

SASIC

BMW



Barre stabilisatrice
 Stabilizer bar
 Barra estabilizadora
 Drażek stabilizatora
 стабилизатор поперечной устойчивости

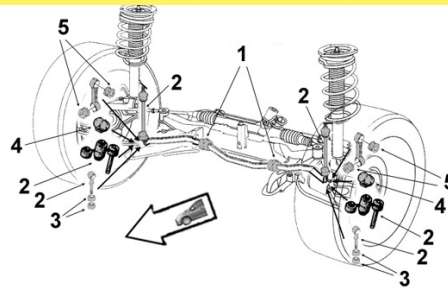

2306062 **Biellette barre stab. G**
 OE 31356765933 *Left stabilizer bar stub axle*



2
 2.0i 03/10-
 2.0 D 07/09-

2306061 **Biellette barre stab. D**
 OE 31356765934 *Right stabilizer bar stub axle*



2
 2.0i 03/10-
 2.0 D 07/09-

Bras & Triangle de suspension

Control arm
 Brazo y triángulo
 Wahacz
 Рычаг подвески

G/L D/R

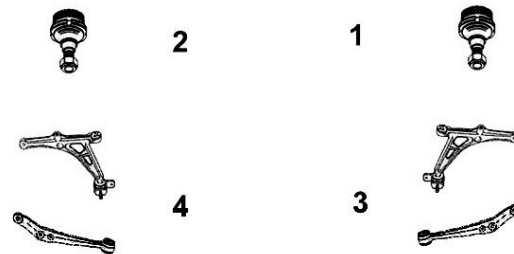

7476093 **Bras de susp. AR inf. G**
 OE 31126770849 *Left rear lower track control arm*

NEW



4 Avec rotule With ball joint
 2.0i BVM6 BVA6 03/10-
 2.0 D FAP BVM6 BVA6 07/09-

7476094 **Bras de susp. AR inf. D**
 OE 31126770850 *Right rear lower track control arm*

NEW



3 Avec rotule With ball joint
 2.0i BVM6 BVA6 03/10-
 2.0 D FAP BVM6 BVA6 07/09-

7476009 **Bras de susp. AV inf. G**
 OE 31126769797 *L front lower track control arm*



4 Avec rotule With ball joint
 2.0i 07/09-
 2.0 D 07/09-

7476008 **Bras de susp. AV inf. D**
 OE 31126769798 *R front lower track control arm*



3 Avec rotule With ball joint
 2.0i 07/09-
 2.0 D 07/09-

7576030 **Rotule de susp. inf. G/D**
 OE 31126768988 *L/R lower suspension ball joint*

NEW



1
2
 2.0i 4WD X Drive 04/11-
 2.0 D 4WD X Drive 10/09-
 3.0i 4WD X Drive 10/09-

... X1



Support d'amortisseur
Suspension mounting
Soporte amortiguador
Poduszka amortyzatora
Опора амортизатора

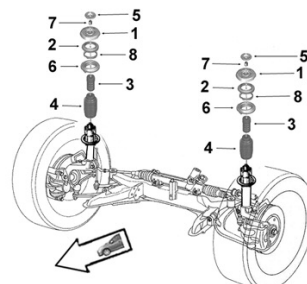

BMW

SASIC

9001422

Support suspension G/D

OE 31336770568

L/R suspension mounting

1 Avec roulement *With bearing*



2.0i
 2.0 D /4WD
 3.0i 4WD

03/10-
 07/09-
 03/10-



Eléments SUSPENSION

Suspension parts
Elementos suspensión
Elementy zawieszenie
Элементы подвески

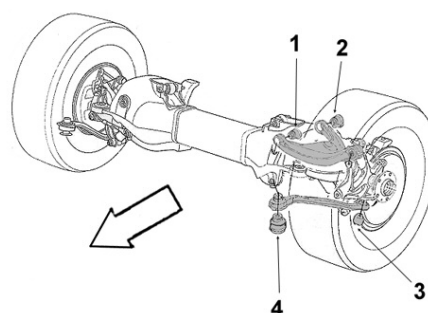

9001778

Articulation bras inf.

OE 33326775552

Lower arm bush

3 Ø int.14 Ø ext.47 long. tube int.55 ext.25



2.0i
 2.0 D /4WD
 3.0i 4WD

03/10-
 07/09-
 07/09-

X3 ...

Eléments DIRECTION

Steering parts
Elementos Direcciones
Elementy układ kierowniczy
Элементы рулевой системы

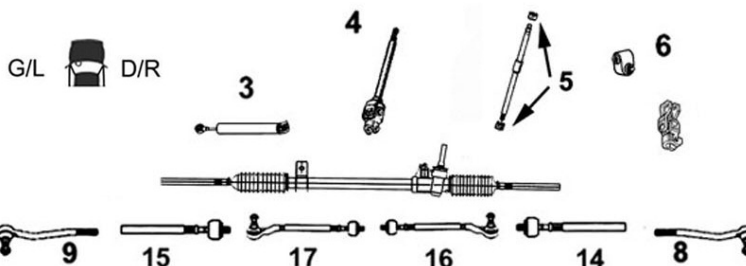

9006819

Axe de bielle G/D

Part/oe 32216751277

L/R axial joint

14 Côté dir. M18x1.5 Côté rot. M14x1.5
15 long 220 mm



2.0i
 2.0 D
 2.0 TD
 2.5i
 3.0i
 3.0 D

09/05-08/10
 09/07-08/10
 09/05-09/07
 09/05-08/10
 01/04-08/10
 01/04-08/10

... X3 ...

SASIC

BMW

Eléments DIRECTION
Steering parts
Elementos Direcciones
Elementy układ kierowniczy
Элементы рулевой системы

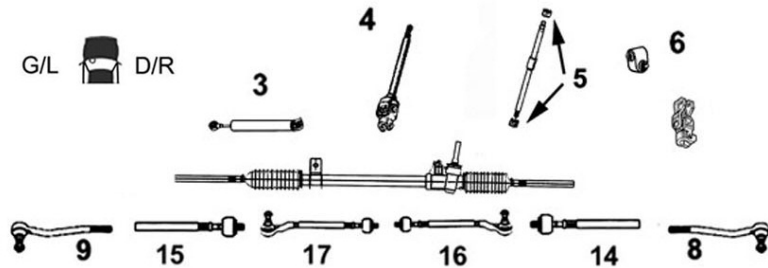

7676057 Rotule de direction G/D

OE 32303418202 L/R tie rod end

NEW



8	M14 x 1.5		
9	2.0i 4WD 150hp 110kw	N46B20B	09/05-08/10
	2.0 D 4WD 142hp 105kw 180hp 130kw	N47D20A/C	09/07-08/10
	2.0 TD 4WD 150hp 110kw	M47DTUD20	09/05-09/07
	2.5i 4WD 190hp 141kw	M54	09/05-08/06
	2.5i 4WD 220hp 160kw	N52B25A	08/06-08/10
	3.0i 4WD 230hp 170kw	M54	01/04-08/06
	3.0i 4WD 270hp 200kw	N52B30A	08/06-08/10
	3.0 D 4WD 205hp 150kw 220hp 160kw	M57D30	01/04-08/06
	3.0 D 4WD 220hp 160kw 280hp 210kw	M57D30	08/06-08/10



Barre stabilisatrice
Stabilizer bar
Barra estabilizadora
Drażek stabilizatora
стабилизатор поперечной устойчивости

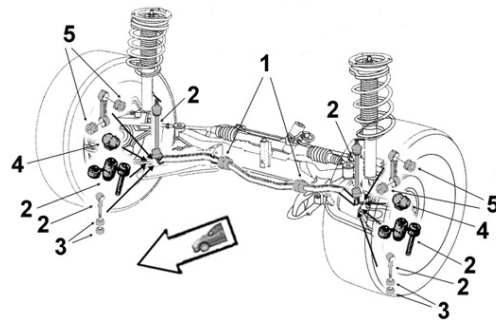

2306059 Bielle barre stab. G

OE 31303414299 Left stabilizer bar stub axle



2		
	2.0i 4WD	09/05-
	2.0 D 4WD	08/06-
	2.0 TD 4WD	09/05-09/07
	2.5i 4WD	09/05-
	3.0i 4WD	01/04-
	3.0 D 4WD	01/04-

2306058 Bielle barre stab. D

OE 31303414300 Right stabilizer bar stub axle



2		
	2.0i 4WD	09/05-
	2.0 D 4WD	08/06-
	2.0 TD 4WD	09/05-09/07
	2.5i 4WD	09/05-
	3.0i 4WD	01/04-
	3.0 D 4WD	01/04-



Eléments SUSPENSION
Suspension parts
Elementos suspensión
Elementy zawieszenie
Элементы подвески

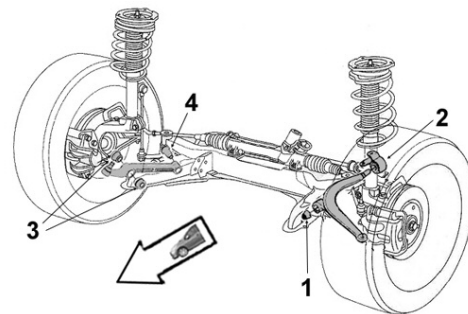

2256040 Articulation bras AV

OE 31120307882 Front arm bush



4	Ø int.14 Ø ext.66 long. tube int. 76 ext.63		
	2.0i 4WD	BVM	09/05-
	2.0 D 4WD		09/07-
	2.0 TD 4WD	BVM	09/05-
	2.5i 4WD		09/05-
	3.0i 4WD		01/04-
	3.0 D 4WD		01/04-

... X3 ...

Bras & Triangle de suspension







Control arm
Brazo y triángulo
Wahacz
Рычаг подвески

G/L  D/R



BMW

sasic

7476138		Bras de susp. AR inf. G		7476139		Bras de susp. AR inf. D		
OE 31103451881		<i>Left rear lower track control arm</i>		OE 31103451882		<i>Right rear lower track control arm</i>		
	NEW	4	Avec rotule <i>With ball joint</i>		NEW	3	Avec rotule <i>With ball joint</i>	
			2.0i 4WD 150hp 110kw N46B20B 09/05-				2.0i 4WD 150hp 110kw N46B20B 09/05-	
			2.0 D 4WD 142hp 105kw N47D20C 04/09-08/10				2.0 D 4WD 142hp 105kw N47D20C 04/09-08/10	
			2.0 D 4WD 180hp 130kw N47D20A/C 09/07-08/10				2.0 D 4WD 180hp 130kw N47D20A/C 09/07-08/10	
			2.0 TD 4WD 150hp 110kw M47DTUD20 09/05-09/07				2.0 TD 4WD 150hp 110kw M47DTUD20 09/05-09/07	
			2.5i 4WD 190hp 141kw M54 09/05-08/06				2.5i 4WD 190hp 141kw M54 09/05-08/06	
			2.5i 4WD 220hp 160kw N52B25A 08/06-08/10				2.5i 4WD 220hp 160kw N52B25A 08/06-08/10	
			3.0i 4WD 230hp 170kw 270hp 200kw N52B30A M54 01/04-08/10				3.0i 4WD 230hp 170kw 270hp 200kw N52B30A M54 01/04-08/10	
			3.0 D 4WD 205hp 150kw M57D30 01/04-09/05				3.0 D 4WD 205hp 150kw M57D30 01/04-09/05	
			3.0 D 4WD 220hp 160kw M57D30 09/05-08/10				3.0 D 4WD 220hp 160kw M57D30 09/05-08/10	
		3.0 D 4WD 280hp 210kw M57D30 08/06-08/10			3.0 D 4WD 280hp 210kw M57D30 08/06-08/10			
7476144		Bras de susp. AV inf. G		7476143		Bras de susp. AV inf. D		
OE 31103443127		<i>L front lower track control arm</i>		OE 31103443128		<i>R front lower track control arm</i>		
	NEW	4	Sans rotule <i>Without ball joint</i>		NEW	3	Sans rotule <i>Without ball joint</i>	
			Cône Ø 15.7- Ø 19.8					Cône Ø 15.7- Ø 19.8
			2.0i 4WD N46B20B 01/07-				2.0i 4WD N46B20B 01/07-	
			2.0i Turbo 4WD N20B20A 09/10-				2.0i Turbo 4WD N20B20A 09/10-	
			2.0 D 4WD N47D20A /C 01/07-				2.0 D 4WD N47D20A /C 01/07-	
			2.0 D FAP N47D20C 09/10-				2.0 D FAP N47D20C 09/10-	
			2.0 TD 4WD M47DTUD20 01/07-				2.0 TD 4WD M47DTUD20 01/07-	
			2.5i 4WD N52B25A 01/07-				2.5i 4WD N52B25A 01/07-	
			3.0i 4WD N52B30A 01/07-				3.0i 4WD N52B30A 01/07-	
			3.0i Turbo 4WD N55B30A 09/10-				3.0i Turbo 4WD N55B30A 09/10-	
		3.0 D 4WD /FAP M57D30 /A/B 01/07-			3.0 D 4WD /FAP M57D30 /A/B 01/07-			
7576023		Rotule de susp. inf. G/D						
OE 31103418341		<i>L/R lower suspension ball joint</i>						
	NEW	1	Cône Ø 18-19.5 H14					
		2						
			2.0i 4WD 150hp 110kw N46B20B -12/06					
			2.0 TD 4WD 150hp 110kw M47DTUD20 -12/06					
			2.5i 4WD N52B25A -12/06					
			3.0i 4WD 230hp 170kw M54 -12/06					
			3.0i 4WD 270hp 200kw N52B30A -12/06					
			3.0 D 4WD 205hp 150kw M57D30 -12/06					
		3.0 D 4WD 220hp 160kw 280hp M57D30 -12/06						
7576029		Rotule de susp. inf. G/D						
OE 31103438623		<i>L/R lower suspension ball joint</i>						
	NEW	1	Cône Ø 17-19.5 H24					
		2						
			2.0i 4WD /X Drive 12/06-					
			2.0 D 4WD /X Drive 12/06-					
			2.0 TD 4WD /X Drive 12/06-09/07					
			2.5i 4WD /X Drive 12/06-					
			3.0i 4WD / X Drive 12/06-					
		3.0 D 4WD /X Drive 12/06-						

... X3 ...

SASIC



Support d'amortisseur
 Suspension mounting
 Soporte amortiguador
 Poduszka amortyzatora
 Опора амортизатора

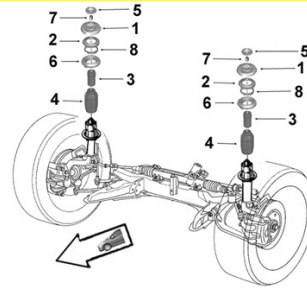

9001422 **Support suspension G/D**
 OE 31336770568 *L/R suspension mounting*



1 Avec roulement *With bearing*

2.0i 4WD
 2.0 D 4WD
 2.0 TD 4WD
 2.5i 4WD
 3.0i 4WD
 3.0 D 4WD

BVM

09/05-

BVM

09/07-
 09/05-09/07
 09/05-
 01/04-
 01/04-



Barre stabilisatrice
 Stabilizer bar
 Barra estabilizadora
 Drążek stabilizatora
 стабилизатор поперечной устойчивости

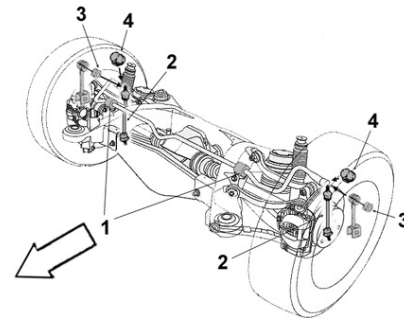

2306060 **Biellette barre stab. G/D**
 OE 33503414297 *L/R stabilizer bar stub axle*



2

2.0i 4WD
 2.0 D 4WD
 2.0 TD 4WD
 2.5i 4WD
 3.0i 4WD
 3.0 D 4WD

BVM

09/05-

BVM

08/06-
 09/05-09/07
 09/05-
 01/04-
 01/04-



Eléments SUSPENSION
 Suspension parts
 Elementos suspensión
 Elementy zawieszenie
 Элементы подвески

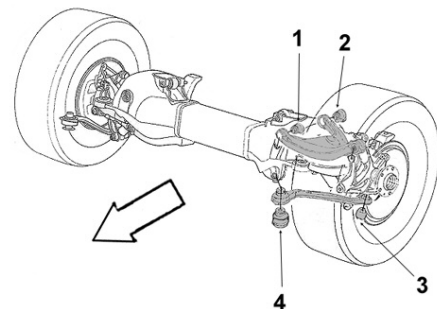

9001563 **Articulation AR int. bras sup.**
 OE 33321092247 *Inner rear bush upper arm*



4 Ø int.12 Ø ext.35 long.tube int.66 ext.42

2.0i 16v.	E83	08/06-
2.0i 4WD	E83	BVM 09/05-08/06
2.0 D 4WD	E83	09/07-
2.0 TD 4WD	E83	BVM 08/06-09/07
2.5i 4WD	E83	09/05-
3.0i 4WD	E83	01/04-
3.0 D 4WD	E83	01/04-

9001564 **Articulation AR inf. côté int.**
 OE 33326770824 *Lower rear bush inner side*



4 Ø int.12 Ø ext.35 long.tube int.57 ext.42

2.0i 4WD	E83	BVM	09/05-
2.0 D 4WD	E83		09/07-
2.0 TD 4WD	E83	BVM	09/05-09/07
2.5i 4WD	E83		09/05-
3.0i 4WD	E83		01/04-
3.0 D 4WD	E83		01/04-

... X3

9001559 Articulation inf. AR coté ext.

OE 33326771828 *Rear lower bush Outer side*



3 Ø int.12 Ø ext.45 long. tube int.57 ext.31

2.0i 4WD	E83	BVM	09/05-
2.0 D 4WD	E83		09/07-
2.0 TD 4WD	E83	BVM	09/05-09/07
2.5i 4WD	E83		09/05-
3.0i 4WD	E83		01/04-
3.0 D 4WD	E83		01/04-

Eléments TRAIN ARRIERE

Rear axle parts

Tren TRAS

Elementy zawieszenia tylnego

элементы задней оси.

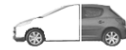

9001414 Articulation AR G/D

OE 33326770786 *L/R rear bush*



Ø int.12.5 Ø ext.61.5 long. tube int.49 ext.40

2.0i 4WD	E83	BVM	09/05-
2.0 D 4WD	E83		09/07-
2.0 TD 4WD	E83	BVM	09/05-09/07
2.5i 4WD	E83		09/05-
3.0i 4WD	E83		01/04-
3.0 D 4WD	E83		01/04-

2606010 Art. inf. porte moyeu

OE 33306786980 *Lower hub seat bush*



Ø int.12 Ø ext.45 long. tube int.48 ext.30

2.0 D 4WD	185hp	135kw	N47D20C
	BVM6	BVA8	09/10-

X5

Eléments DIRECTION

Steering parts

Elementos Direcciones

Elementy uklad kierowniczy

Элементы рулевой системы

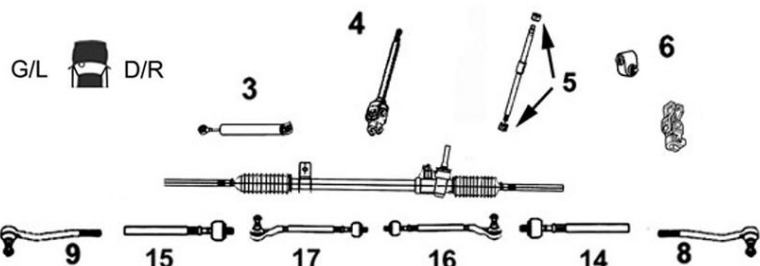

9006819 Axe de bielle G/D

Part/oe 32216751277 *L/R axial joint*



14 Côté dir. M18x1.5 Côté rot. M14x1.5 long 220 mm

15

3.0					
3.0 D					
4.4	E53	M62 N62	BVA	05/00-12/06	
4.6is			BVA	-10/03	
4.8is				02/04-12/06	

9006430 Rotule de direction G/D

OE 32211096327 *L/R tie rod end*



8 M14 x 1.5

9

3.0				-10/03
3.0 D	M57			-10/03
4.4	M62	BVA		-10/03
4.6is		BVA		-10/03

7676057 Rotule de direction G/D

OE 32413413476 *L/R tie rod end*



8 M14 x 1.5

9

3.0i 4WD	270hp	200kw	N52B30A
	BVA		03/07-03/10
3.0 D 4WD	235hp	173kw	M57D30
	BVA		02/07-03/10
4.8i 4WD	355hp	261kw	N62B48B
	BVA		02/07-03/10

X6

Eléments DIRECTION

Steering parts

Elementos Direcciones

Elementy układ kierowniczy

Элементы рулевой системы

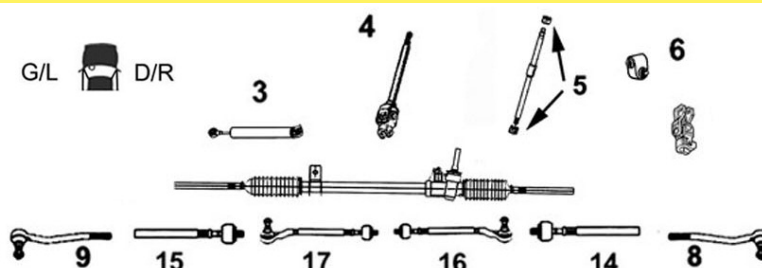

7676057

Rotule de direction G/D

OE 32413413476

L/R tie rod end



8
9

M14 x 1.5

3.0i Turbo 4WD 305hp 225kw

N54B30A

BVA 06/08-

3.0 D 4WD 235hp 173kw 280hp 210kw

M57D30

BVA 06/08-

4.4i Turbo Active hybride 4WD 410hp 300kw

N63B44A

BVA 06/08-

Z1

Eléments TRAIN ARRIERE

Rear axle parts

Tren TRAS

Elementy zawieszenia tylnego

элементы задней оси.



2256059

Articulation AR Sup. côté ext.

OE 33326775551

Upper rear bush Outer side



Ø int.12 Ø ext.45 long. tube int.56.5 ext.24

2.5i

09/90-06/91

Z3

Bras & Triangle de suspension

Control arm

Brazo y triángulo

Wahacz

Рычаг подвески

G/L D/R

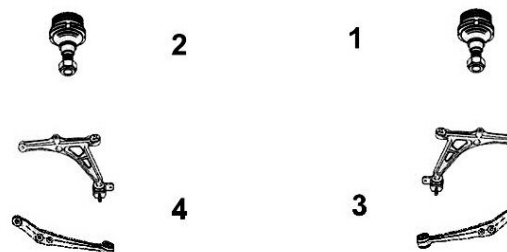

7476021

Triangle de susp. G

OE 31126758513

Left track control arm



4

Avec rotule With ball joint

1.8i

01/96-10/98

1.9i

09/00-12/02

1.9i S 16v.

01/96-06/99

2.0i

07/99-09/00

2.2i

09/00-12/02

2.8i

07/98-09/00

3.0i

09/00-12/02

7476020

Triangle de susp. D

OE 31126758514

Right track control arm



3

Avec rotule With ball joint

1.8i

01/96-10/98

1.9i

09/00-12/02

1.9i S 16v.

01/96-06/99

2.0i

07/99-09/00

2.2i

09/00-12/02

2.8i

07/98-09/00

3.0i

09/00-12/02





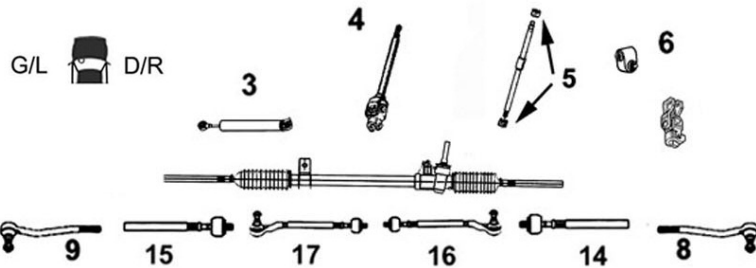



Z4 ...

Eléments DIRECTION
Steering parts
Elementos Direcciones
Elementy uklad kierowniczy
Элементы рулевой системы

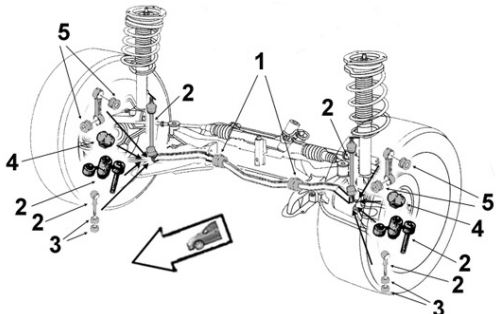

BMW

SAFIC

<p>9006817 Axe de bielle G/D Part/oe 32106777503 <i>L/R axial joint</i></p>  <p>14 Côté dir. M18x1.5 Côté rot. M14x1.5 15 long 207 mm</p> <p>2.2i 09/03-12/05 2.5i 02/03-12/05 3.0i 02/03-12/05</p>	<p>7776018 Axe de bielle G/D Part/oe 32106765236 <i>L/R axial joint</i></p>  <p>14 Côté dir. M18x1.5 Côté rot. M14x1.5 15 long 255 mm</p> <p>Direction ZF</p> <p>2.5i 03/09- 3.0i 03/09- 3.0i Turbo 03/09-</p>
<p>9006429 Rotule de direction G OE 32106774220 <i>Left tie rod end</i></p>  <p>9 M14 x 1.5</p> <p>2.0i 01/06-04/09 2.2i 09/03-12/05 2.5i 02/03-04/09 3.0i 02/03-04/09 3.2i 03/06-04/09</p>	<p>9006428 Rotule de direction D OE 32106774221 <i>Right tie rod end</i></p>  <p>8 M14 x 1.5</p> <p>2.0i 01/06-04/09 2.2i 09/03-12/05 2.5i 02/03-04/09 3.0i 02/03-04/09 3.2i 03/06-04/09</p>
<p>7676017 Rotule de direction G OE 32106765089 <i>Left tie rod end</i></p>  <p>9 M14 x 1.5</p> <p>Direction ZF</p> <p>2.5i 03/09- 3.0i 03/09- 3.0i Turbo 03/09-</p>	<p>7676015 Rotule de direction D OE 32106765090 <i>Right tie rod end</i></p>  <p>8 M14 x 1.5</p> <p>Direction ZF</p> <p>2.5i 03/09- 3.0i 03/09- 3.0i Turbo 03/09-</p>
<div style="display: flex; justify-content: space-between;"> <div style="width: 45%;">  <p>Barre stabilisatrice <i>Stabilizer bar</i> <i>Barra estabilizadora</i> <i>Drażek stabilizatora</i> стабилизатор поперечной устойчивости</p> </div> <div style="width: 50%;">  </div> </div>	
<p>2306062 Biellette barre stab. G OE 31356765933 <i>Left stabilizer bar stub axle</i></p>  <p>2</p> <p>Direction ZF</p> <p>2.5i 03/09- 3.0i 03/09- 3.0i Turbo 03/09-</p>	<p>2306061 Biellette barre stab. D OE 31356765934 <i>Right stabilizer bar stub axle</i></p>  <p>2</p> <p>Direction ZF</p> <p>2.5i 03/09- 3.0i 03/09- 3.0i Turbo 03/09-</p>

... Z4

SASIC

BMW

Bras & Triangle de suspension

Control arm
Brazo y triángulo
Wahacz
Рычаг подвески

G/L  D/R

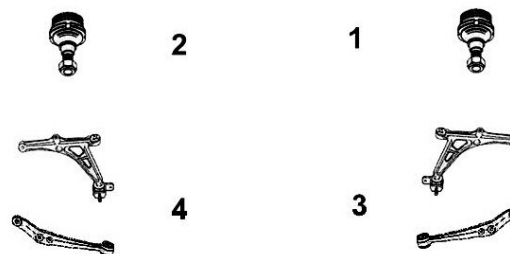

9005683

Triangle de susp. G

OE 31126777851

Left track control arm



4	Avec rotule With ball joint
2.0i	01/06-04/09
2.2i	09/03-12/05
2.5i	02/03-04/09
3.0i	02/03-04/09

OE 31126774819

3.2i	03/06-04/09
------	-------------

9005682

Triangle de susp. D

OE 31126777852

Right track control arm



3	Avec rotule With ball joint
2.0i	01/06-04/09
2.2i	09/03-12/05
2.5i	02/03-04/09
3.0i	02/03-04/09

OE 31126774820

3.2i	03/06-04/09
------	-------------

7476009

Bras de susp. AV inf. G

OE 31126769797

L front lower track control arm



4	Avec rotule With ball joint
2.5i	03/09-
3.0i	03/09-
3.0i Turbo	03/09-

7476008

Bras de susp. AV inf. D

OE 31126769798

R front lower track control arm



3	Avec rotule With ball joint
2.5i	03/09-
3.0i	03/09-
3.0i Turbo	03/09-

Éléments TRAIN ARRIERE

Rear axle parts
Tren TRAS
Elementy zawieszenia tylnego
элементы задней оси.



2256059

Articulation AR Sup. côté ext.

OE 33326775551

Upper rear bush Outer side

Ø int.12 Ø ext.45 long.tube int.56.5 ext.24



2.0i	E85	04/05-
2.2i	E85	10/03-
2.5i /Si	E85	02/03-
2.5i 23i S Drive	E89	05/09-
3.0 Si	E86	03/06-
3.0i /Si	E85	02/03-
3.0i 30i 35i S Drive	E89	05/09-
3.2 M	E85	03/06-
3.2 M	E86	03/06-

Aveo ...

Eléments DIRECTION

Steering parts

Elementos Direcciones

Elementy układ kierowniczy

Элементы рулевой системы

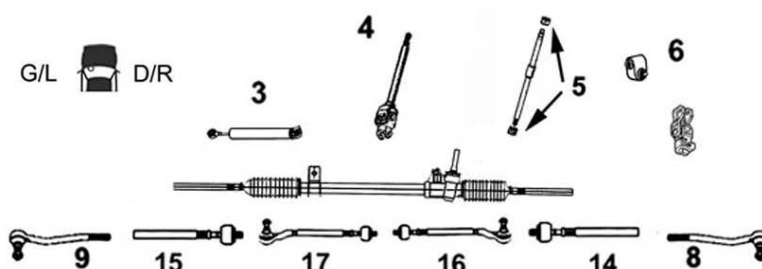

7676005

Rotule de direction G

OE 93740722

Left tie rod end



9

1.2i 05/08-
1.2i GPL 05/08-
1.4i 05/08-

7676007

Rotule de direction D

OE 93740723

Right tie rod end



8

1.2i 05/08-
1.2i GPL 05/08-
1.4i 05/08-



Barre stabilisatrice

Stabilizer bar

Barra estabilizadora

Drażek stabilizatora

стабилизатор поперечной устойчивости

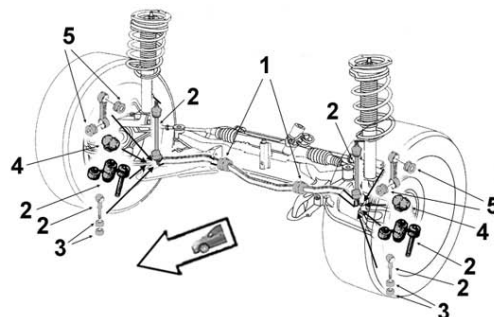

2306074

Biellette barre stab.

OE 96391875

Stabilizer bar stub axle



2

1.2i 03/06-
1.4i 03/06-

Bras & Triangle de suspension

Control arm

Brazo y triángulo

Wahacz

Рычаг подвески

G/L D/R

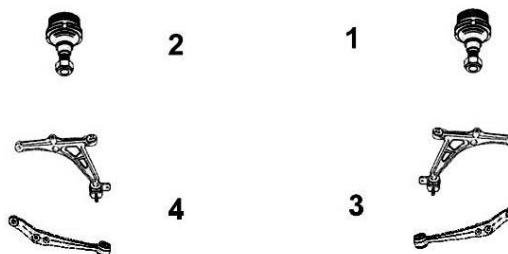

7476040

Triangle de susp. G

OE 96870465

Left track control arm



4

Avec rotule With ball joint

1.2i 03/06-
1.2i 16v. 03/06-
1.4i 16v. 03/06-
1.5 05/05-

7476039

Triangle de susp. D

OE 96870466

Right track control arm



3

Avec rotule With ball joint

1.2i 03/06-
1.2i 16v. 03/06-
1.4i 16v. 03/06-
1.5 05/05-

... Aveo

Bras & Triangle de suspension
Control arm
Brazo y triángulo
Wahacz
Рычаг подвески

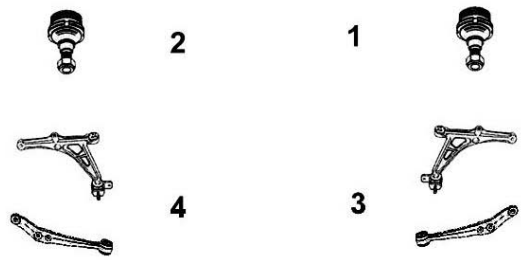

7576003 **Rotule de susp. inf. G/D**
 OE 96535089 *L/R lower suspension ball joint*



1 2	1.2	03/06-
	1.4 16v.	03/06-
	1.5	05/05-

Captiva

Bras & Triangle de suspension
Control arm
Brazo y triángulo
Wahacz
Рычаг подвески

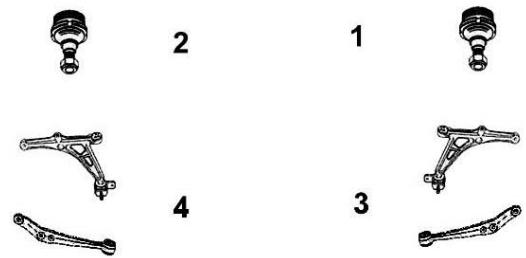

7476171 **Triangle de susp. G**
 OE 96819161 *Left track control arm*



4	Avec rotule <i>With ball joint</i>	
	2.0 VCDi FAP	Z20D1 03/11-
	2.0 VCDi FAP /4WD	Z20S 09/06-01/11
	2.4i 4WD / GPL	Z24SED 09/06-01/11
	3.2i 4WD	10HM 09/06-01/11

7476170 **Triangle de susp. D**
 OE 96819162 *Right track control arm*



3	Avec rotule <i>With ball joint</i>	
	2.0 VCDi FAP	Z20D1 03/11-
	2.0 VCDi FAP /4WD	Z20S 09/06-01/11
	2.4i 4WD / GPL	Z24SED 09/06-01/11
	3.2i 4WD	10HM 09/06-01/11

7576047 **Rotule de susp. G/D**
 Part/oe 96626236 *L/R suspension ball joint*



1 2	2.0 VCDi FAP	Z20D1	03/11-
	2.0 VCDi FAP /4WD	Z20S	09/06-01/11
	2.4i 4WD / GPL	Z24SED	09/06-01/11
	3.2i 4WD	10HM	09/06-01/11

Cruze

Eléments DIRECTION

Steering parts

Elementos Direcciones

Elementy uklad kierowniczy

Элементы рулевой системы

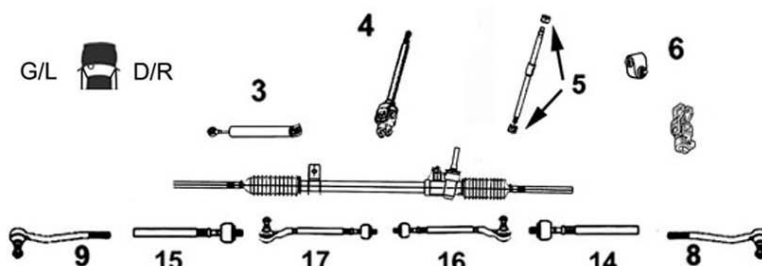

7776091

OE 13278358

Axe de bielle G/D

L/R axial joint

NEW



14 Côté dir. M16x1.5 Côté rot. M16x1.5
15 long 293 mm

1.4i Turbo	06/11-
1.6i	03/09-
1.7 VCDi	01/12-
1.8i	03/09-
2.0 VCDi	03/09-

7676069

OE 13278359

Rotule de direction G/D

L/R tie rod end

NEW



8
9 M16 x 1.5

1.6i	03/09-
1.8i	03/09-
2.0 VCDi FAP	03/09-

Bras & Triangle de suspension

Control arm

Brazo y triángulo

Wahacz

Рычаг подвески

G/L D/R

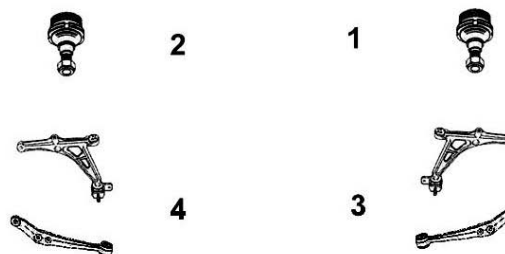

7476215

OE 352492

Triangle de susp. G

Left track control arm

NEW



4 Avec rotule With ball joint Ø 20

1.4i	06/12-
1.6i	03/09-
1.7 VCDi	01/12-
1.8i	05/09-
2.0 VCDi	05/09-

7476214

OE 13334023

Triangle de susp. D

Right track control arm

NEW



3 Avec rotule With ball joint Ø 20

1.4i	06/12-
1.6i	03/09-
1.7 VCDi	01/12-
1.8i	05/09-
2.0 VCDi	05/09-

Kalos ...

Eléments DIRECTION

Steering parts

Elementos Direcciones

Elementy uklad kierowniczy

Элементы рулевой системы

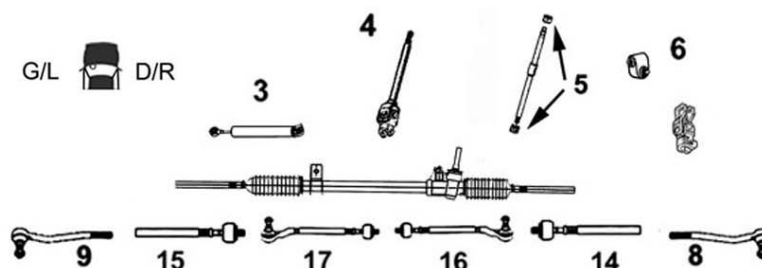

7676005

OE 93740722

Rotule de direction G

Left tie rod end



9

1.2i	01/05-05/08
1.4i	01/05-05/08

7676007

OE 93740723

Rotule de direction D

Right tie rod end



8

1.2i	01/05-05/08
1.4i	01/05-05/08

... Kalos

Bras & Triangle de suspension

Control arm
Brazo y triángulo
Wahacz
Рычаг подвески

G/L  D/R

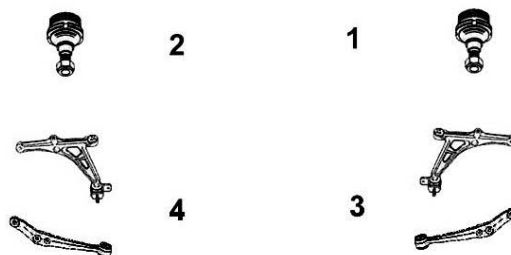

7476040

OE 96870465

Triangle de susp. G

Left track control arm

7476039

OE 96870466

Triangle de susp. D

Right track control arm



4 Avec rotule With ball joint

1.2i	03/05-05/08
1.4i	03/05-05/08
1.4i 16v.	03/05-05/08



3 Avec rotule With ball joint

1.2i	03/05-05/08
1.4i	03/05-05/08
1.4i 16v.	03/05-05/08

7576003

OE 96535089

Rotule de susp. inf. G/D

L/R lower suspension ball joint



1
2

1.2i	03/05-
1.4i	03/05-
1.4i 16v.	03/05-

Lacetti

Bras & Triangle de suspension

Control arm
Brazo y triángulo
Wahacz
Рычаг подвески

G/L  D/R

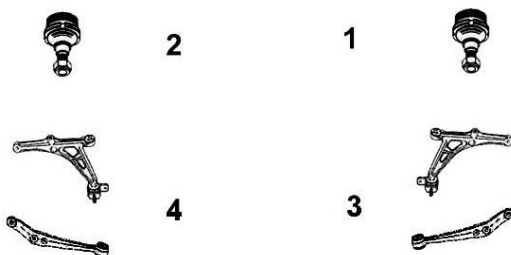

7476162

OE 96415063

Triangle de susp. G

Left track control arm

7476161

OE 96415064

Triangle de susp. D

Right track control arm

NEW

4 Avec rotule With ball joint Ø 18

1.4i 95hp 70kw F14D3	01/05-01/07
1.6i 110hp 80kw F16D3	01/05-12/09
1.8i 120hp 90kw T18SED	01/05-09/07



NEW

3 Avec rotule With ball joint Ø 18

1.4i 95hp 70kw F14D3	01/05-01/07
1.6i 110hp 80kw F16D3	01/05-12/09
1.8i 120hp 90kw T18SED	01/05-09/07



Matiz

Eléments DIRECTION

Steering parts

Elementos Direcciones

Elementy uklad kierowniczy

Элементы рулевой системы

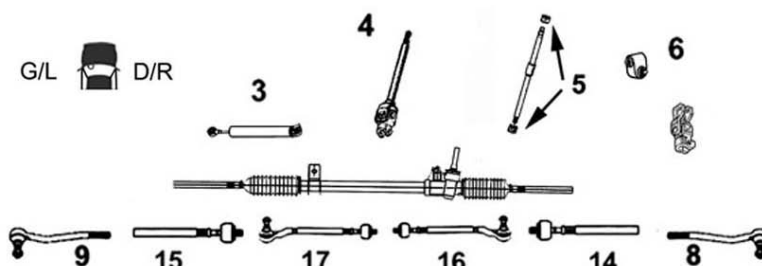

7776068

OE 93741074

Axe de bielle G/D

L/R axial joint

NEW



14 Côté dir. M16x1.5 Côté rot. M12x1.5
15 long 252 mm

Pour pneus 145 / 155 & Sans DA

0.8i
1.0i

F8CV
B10S /1

7776063

OE 521257

Axe de bielle G/D

L/R axial joint

NEW



14 Côté dir. M16x1.5 Côté rot. M12x1.5
15 long 256 mm

Pour pneus 175 & Sans DA

0.8i
1.0i

F8CV
B10S /1

7776064

OE 93741092

Axe de bielle G/D

L/R axial joint

NEW



14 Côté dir. M16x1.5 Côté rot. M12x1.5
15 long 251 mm

Avec DA

0.8i
1.0i

F8CV
B10S /1

7676023

OE 48810A78B00000

Rotule de direction G/D

L/R tie rod end



8 M12 x 1.5
9

0.8i
1.0i

06/05-
06/05-

Bras & Triangle de suspension

Control arm

Brazo y triángulo

Wahacz

Рычаг подвески

G/L  D/R

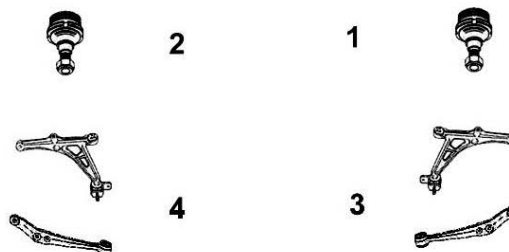

7476041

OE 96611265

Bras de susp. AV inf. G/D

L/R front lower track control arm

3 Ø 15 Avec rotule With ball joint
4



0.8i / GPL

03/05-09/09

1.0i/ GPL

03/05-09/09

Nubira

Bras & Triangle de suspension

Control arm
Brazo y triángulo
Wahacz
Рычаг подвески

G/L  D/R

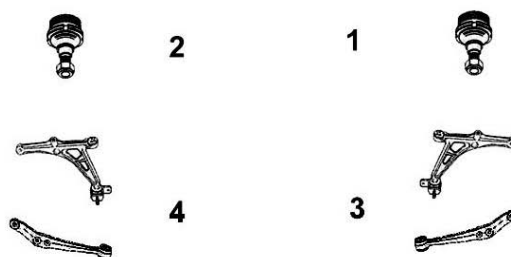

7476162

OE 96415063

Triangle de susp. G

Left track control arm

4 Avec rotule With ball joint Ø 18

1.6i /SW 110hp 80kw F16D3
01/05-09/09
1.6i SW 110hp 80kw / GPL F16D3
01/05-09/09
1.8i /SW 120hp 90kw T18SED
01/05-09/07



7476161

OE 96415064

Triangle de susp. D

Right track control arm

3 Avec rotule With ball joint Ø 18

1.6i /SW 110hp 80kw F16D3
01/05-09/09
1.6i SW 110hp 80kw / GPL F16D3
01/05-09/09
1.8i /SW 120hp 90kw T18SED
01/05-09/07



Orlando

Eléments DIRECTION

Steering parts
Elementos Direcciones
Elementy układ kierowniczy
Элементы рулевой системы

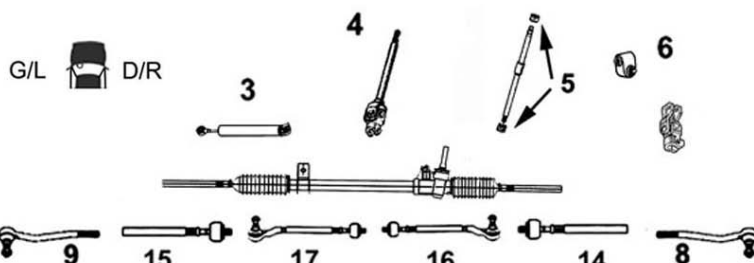

7676069

OE 13278359

Rotule de direction G/D

L/R tie rod end

8
9 M16 x 1.5

2.0 VCDi FAP 01/11-



Spark

Eléments DIRECTION

Steering parts
Elementos Direcciones
Elementy układ kierowniczy
Элементы рулевой системы

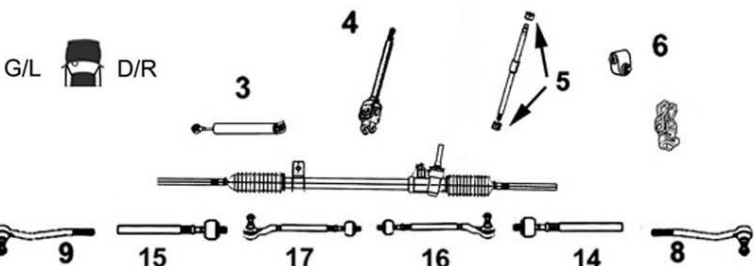

7676107

OE 95967285

Rotule de direction G/D

L/R tie rod end

8
9 M12 x 1.25

1.0i 03/10-
1.2i 03/10-



AX...

Eléments DIRECTION

Steering parts

Elementos Direcciones

Elementy układ kierowniczy

Элементы рулевой системы

G/L  D/R

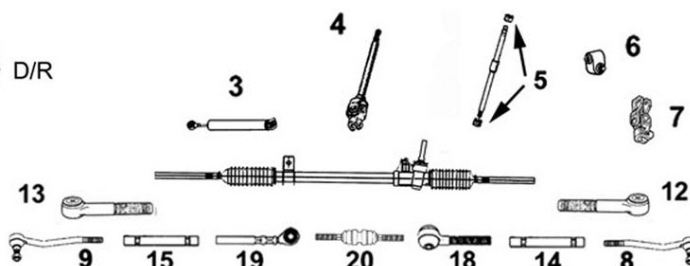

CITROEN



...AX...



CITROEN



Barre stabilisatrice
 Stabilizer bar
 Barra estabilizadora
 Drażek stabilizatora
 стабилизатор поперечной устойчивости

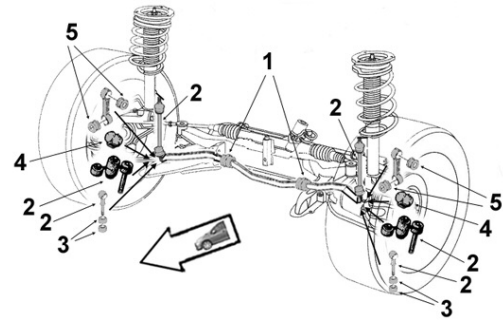

2005271 **Palier de barre milieu/bout**
 OE 96064489 *Middle/End bar main bearing*



1 Barre Ø 19
 TT /all models Essence
 sauf 1360cm3 inj. -12/89

2005271 **Palier de barre milieu**
 OE 96064489 *Middle bar main bearing*



1 Barre Ø 19
 1.4 D TUD3 -01/01/90

0945565 **Palier de barre milieu**
 OE 509456 *Middle bar main bearing*



1 Barre Ø 19
 TT /all models Essence
 sauf 1360cm3 inj. 01/90-
 1.4 D TUD3 02/01/90-
 1.5 D TUD5

0945575 **Palier de barre milieu**
 OE 509457 *Middle bar main bearing*



1 Barre Ø 21
 1.3 Sport 02/01/90-12/90
 1.4 GT / 4WD 02/01/90-

0945595 **Palier de barre bout**
 OE 509459 *End bar main bearing*



4 Barre Ø 19 noir
 TT /all models Essence
 sauf 1360cm3 inj. 01/90-
 1.4 D TUD3 02/01/90-
 1.5 D TUD5

0945605 **Palier de barre bout**
 OE 509460 *End bar main bearing*



4 Barre Ø 21 blanc
 1.3 Sport 02/01/90-12/90
 1.4 GT / 4WD 02/01/90-



Eléments SUSPENSION
 Suspension parts
 Elementos suspensión
 Elementy zawieszenie
 Элементы подвески

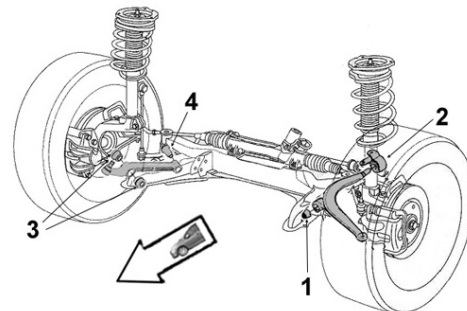

2005252 **Articulation AV**
 OE 95603308 *Front bush*



















1 Ø int.12 Ø ext.34 long. tube int.48 ext.30
 TT /all models Essence
 1.4 D TUD3
 1.5 D TUD5

2005253 **Articulation AR**
 OE 96133255 *Rear bush*



2 Ø int.14 Ø ext.36 long. tube int.53 ext.38
 1.0 -21/04/91
 1.1 -21/04/91
 1.3 Sport -12/90
 1.4 Carbu. -21/04/91
 1.4 D TUD3 -21/04/91

...AX...

2005254 OE 96106474 		Articulation AR <i>Rear bush</i> 2 Ø int.17 TT /all models 4WD Essence sauf 1360cm3 inj. 1.0i 22/04/91- 1.1 22/04/91- 1.4 Carbu. 22/04/91- 1.4 D TUD3 22/04/91- 1.5 D TUD5		2005251 OE 96050338 		Articulation AR <i>Rear bush</i> 2 Ø int.17 1.4i	
Bras & Triangle de suspension Control arm Brazo y triángulo Wahacz Рычаг подвески		G/L  D/R		 2		 1	
		 4		 3		 3	
2005301 OE 96133608 		Triangle de susp. G <i>Left track control arm</i> 4 Avec rotule With ball joint TT /all models Sauf GTi 1360i 09/86-12/92		2005300 OE 96133609 		Triangle de susp. D <i>Right track control arm</i> 3 Avec rotule With ball joint TT /all models Sauf GTi 1360i 09/86-12/92	
5203783 OE 352078 		Triangle de susp. G <i>Left track control arm</i> 4 Avec rotule With ball joint TT /all models Sauf GTi 1360i 01/92-		5203793 OE 352079 		Triangle de susp. D <i>Right track control arm</i> 3 Avec rotule With ball joint TT /all models Sauf GTi 1360i 01/92-	
5203923 OE 352080 		Triangle de susp. G <i>Left track control arm</i> 4 Avec rotule With ball joint 1.4 GTi 09/86-02/04/93		5203933 OE 352081 		Triangle de susp. D <i>Right track control arm</i> 3 Avec rotule With ball joint 1.4 GTi 09/86-02/04/93	
5203923 OE 352092 		Triangle de susp. G <i>Left track control arm</i> 4 Avec rotule With ball joint 1.4 GTi 03/04/93-		5203933 OE 352093 		Triangle de susp. D <i>Right track control arm</i> 3 Avec rotule With ball joint 1.4 GTi 03/04/93-	

...AX...

Bras & Triangle de suspension

Control arm
Brazo y triángulo
Wahacz
Рычаг подвески

G/L  D/R



...AX...



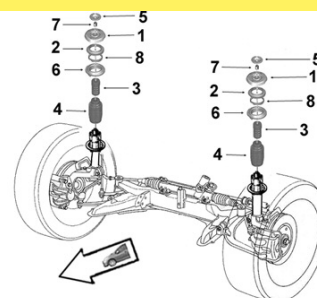

Support d'amortisseur
 Suspension mounting
 Soporte amortiguador
 Poduszka amortyzatora
 Опора амортизатора



CITROEN

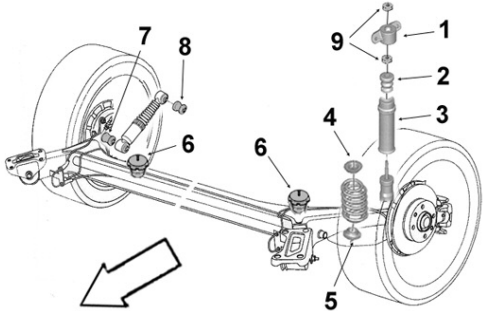

2001003 OE 503852	Support suspension G/D <i>L/R suspension mounting</i>	0355275 OE 503563	Butée à billes G/D <i>L/R ball bearing</i>
	1 TT /all models Essence 1.4 D TUD3 1.5 D TUD5		2 TT /all models Essence 1.4 D TUD3 1.5 D TUD5
0335365 OE 503336	Butée de suspension G/D <i>L/R suspension bush</i> 3 H90 TT /all models inj.	2545185 OE 525418	Protecteur amortisseur G/D <i>L/R shock absorber protector</i> 4 TT /all models 09/86-
1005260 OE -	Kit rép. suspension G ou D <i>L/R stabilizing bar repair kit</i> TT /all models 09/86-		
 <p>Support d'amortisseur Suspension mounting Soporte amortiguador Poduszka amortyzatora Опора амортизатора</p>			
1665375 OE 516637	Butée de talonnage <i>Bushing</i> 6 H48 <u>Sauf susp. réhaussée -11/92</u> 1.0 sauf 4WD 1.1 Sauf 4WD 1.4 Carbu. sauf GT / 4WD ou TU3FM 05/01/93- <u>susp. normale</u> 1.3 Sport GT -21/04/91 1.4 D TUD3 1.5 D TUD5		

... AX

Eléments TRAIN ARRIERE

Rear axle parts

Tren TRAS

Elementy zawieszenia tylnego

элементы задней оси.



CITROEN



1315655

OE 513165

Articulation traverse AR

Rear cross bar bush

Ø int.12 Ø ext.33 coll.57 long. tube int.47
ext.25.5 ep. coll.13

TT /all models Essence
sauf 1360i et 4WD 28/08/90-

1.4 D TUD3 28/08/90-
1.5 D TUD5 28/08/90-



1315635

OE 513163

Articulation traverse

Cross bar bush

Ø int.12 Ø ext.33 coll.57 long. tube int.47
ext.25.5 ep. coll.13

TT /all models 4WD
Essence sauf 1360cm3 inj.

1.4i



Berlingo VL...

Eléments DIRECTION

Steering parts

Elementos Direcciones

Elementy układ kierowniczy

Элементы рулевой системы

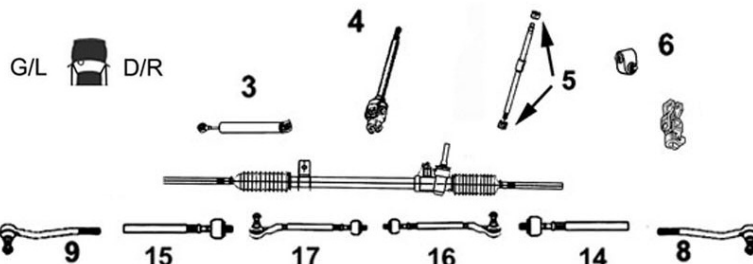

0114444

OE 401144

Vérin dir. assistée

Power steering jack

3

1.1i TU1M+ TU1JP -10/02
1.4i TU3JP -10/02
1.4i TU3JP TU3A 11/02-05/08
1.6i 16v. TU5JP4 -05/08
1.8i XU7JB -10/02
1.9 D XUD9 DW8/B -10/02
1.9 D DW8B 11/02-05/08



0114654

OE 401165

Vérin dir. assistée

Power steering jack

3

1.6 HDi DV6ATED4 11/02-05/08
1.6 HDi DV6BTED4 11/02-05/08
2.0 HDi DW10TD -05/08



2006021

OE 96048007581

Axe de bielle G/D

L/R axial joint

14

15

Côté dir. M12x1.0
Côté rot. M14x1.5 long 340 mm
1.1i TU1M+/1JP -10/02
1.4i TU3JP -05/08
1.4i TU3A 11/02-05/08
1.6i 16v. TU5JP4 -05/08
1.8i DNA DA XU7JB -10/02
1.9 DDNA DA XUD9 DW8/B -10/02
1.9 D DW8B 11/02-05/08
2.0 HDi DNA DW10TD -10/02



7770004

Part/oe 3812F4

Axe de bielle G/D

L/R axial joint

14

15

Côté dir. M14x1.5
Côté rot. M14x1.5 long 262 mm
1.6i 16v. EP6C /B 05/08-
1.6i 16v. TU5JP4/B 05/08-
1.6 HDi DV6D/ETED M 05/08-
1.6 HDi FAP DV6TED4/B 05/08-
1.6 HDi DV6A/BTED4 05/08-
1.6 HDi DV6C 05/08-
1.6 HDi DV6DTED/4 05/08-



7770009

OE 3812E4

Axe de bielle G/D

L/R axial joint

14

15

Côté dir. M12x1.0
Côté rot. M14x1.5 long 336 mm
1.6 HDi DV6ATED4 11/02-05/08
1.6 HDi DV6BTED4 11/02-05/08
2.0 HDi DW10TD 12/04/04-05/08



3008155

Part/oe 3812C6

Axe de bielle G/D

L/R axial joint



14



15

Côté dir. M12x1.0
Côté rot. M14x1.5 long 330 mm
2.0 HDi DA DW10TD -10/02
2.0 HDi DW10TD 11/02-11/04/04



...Berlingo VL...



2006105 OE - 	Bielle de direction G/D <i>L/R steering rod</i> 16 Côté pignon 17 <table style="width: 100%; border-collapse: collapse;"> <tr><td>1.1</td><td>DA</td><td>TU1M+/JP</td><td>-10/02</td></tr> <tr><td>1.4i</td><td>DA</td><td>TU3JP</td><td>-10/02</td></tr> <tr><td>1.4i</td><td></td><td>TU3A/JP</td><td>11/02-05/08</td></tr> <tr><td>1.6i 16v.</td><td>DA</td><td>TU5JP4</td><td>-05/08</td></tr> <tr><td>1.8</td><td>DA</td><td>XU7JB</td><td>-10/02</td></tr> <tr><td>1.9 D</td><td>DA</td><td>XUD9</td><td>-10/02</td></tr> <tr><td>1.9 D</td><td>DA</td><td>DW8/B</td><td>-05/08</td></tr> </table>	1.1	DA	TU1M+/JP	-10/02	1.4i	DA	TU3JP	-10/02	1.4i		TU3A/JP	11/02-05/08	1.6i 16v.	DA	TU5JP4	-05/08	1.8	DA	XU7JB	-10/02	1.9 D	DA	XUD9	-10/02	1.9 D	DA	DW8/B	-05/08	8173183 OE 381750 	Rotule de direction G/D <i>L/R tie rod end</i> 8 M14 x 1.5 9 <table style="width: 100%; border-collapse: collapse;"> <tr><td>1.1i</td><td>TU1M+</td><td>-10/02</td></tr> <tr><td>1.4i</td><td>TU3JP</td><td>-05/08</td></tr> <tr><td>1.4i</td><td>TU3A</td><td>11/02-05/08</td></tr> <tr><td>1.6i 16v.</td><td>TU5JP4</td><td>-05/08</td></tr> <tr><td>1.6 HDi</td><td>DV6A/BTED4</td><td>11/02-05/08</td></tr> <tr><td>1.8i</td><td>XU7JB</td><td>-10/02</td></tr> <tr><td>1.9 D</td><td>XUD9</td><td>-10/02</td></tr> <tr><td>1.9 D</td><td>DW8/B</td><td>-05/08</td></tr> <tr><td>2.0 HDi</td><td>DW10TD</td><td>-05/08</td></tr> </table>	1.1i	TU1M+	-10/02	1.4i	TU3JP	-05/08	1.4i	TU3A	11/02-05/08	1.6i 16v.	TU5JP4	-05/08	1.6 HDi	DV6A/BTED4	11/02-05/08	1.8i	XU7JB	-10/02	1.9 D	XUD9	-10/02	1.9 D	DW8/B	-05/08	2.0 HDi	DW10TD	-05/08
1.1	DA	TU1M+/JP	-10/02																																																							
1.4i	DA	TU3JP	-10/02																																																							
1.4i		TU3A/JP	11/02-05/08																																																							
1.6i 16v.	DA	TU5JP4	-05/08																																																							
1.8	DA	XU7JB	-10/02																																																							
1.9 D	DA	XUD9	-10/02																																																							
1.9 D	DA	DW8/B	-05/08																																																							
1.1i	TU1M+	-10/02																																																								
1.4i	TU3JP	-05/08																																																								
1.4i	TU3A	11/02-05/08																																																								
1.6i 16v.	TU5JP4	-05/08																																																								
1.6 HDi	DV6A/BTED4	11/02-05/08																																																								
1.8i	XU7JB	-10/02																																																								
1.9 D	XUD9	-10/02																																																								
1.9 D	DW8/B	-05/08																																																								
2.0 HDi	DW10TD	-05/08																																																								



7670017 OE 381789 	Rotule de direction G <i>Left tie rod end</i> 9 M14 x 1.5 <table style="width: 100%; border-collapse: collapse;"> <tr><td>1.6i 16v.</td><td>TU5JP4/B</td><td>05/08-</td></tr> <tr><td>1.6i 16v.</td><td>EP6C /B</td><td>05/08-</td></tr> <tr><td>1.6 HDi</td><td>DV6ETED4/M</td><td>05/08-</td></tr> <tr><td>1.6 HDi</td><td>DV6DTED/M</td><td>05/08-</td></tr> <tr><td>1.6 HDi</td><td>DV6C</td><td>05/08-</td></tr> <tr><td>1.6 HDi</td><td>DV6A/BTED4</td><td>05/08-</td></tr> <tr><td>1.6 HDi FAP</td><td>DV6TED4/B</td><td>05/08-</td></tr> </table>	1.6i 16v.	TU5JP4/B	05/08-	1.6i 16v.	EP6C /B	05/08-	1.6 HDi	DV6ETED4/M	05/08-	1.6 HDi	DV6DTED/M	05/08-	1.6 HDi	DV6C	05/08-	1.6 HDi	DV6A/BTED4	05/08-	1.6 HDi FAP	DV6TED4/B	05/08-	7670016 OE 381788 	Rotule de direction D <i>Right tie rod end</i> 8 M14 x 1.5 <table style="width: 100%; border-collapse: collapse;"> <tr><td>1.6i 16v.</td><td>TU5JP4/B</td><td>05/08-</td></tr> <tr><td>1.6i 16v.</td><td>EP6C/B</td><td>05/08-</td></tr> <tr><td>1.6 HDi</td><td>DV6ETED4/M</td><td>05/08-</td></tr> <tr><td>1.6 HDi</td><td>DV6DTED/M</td><td>05/08-</td></tr> <tr><td>1.6 HDi</td><td>DV6C</td><td>05/08-</td></tr> <tr><td>1.6 HDi</td><td>DV6A/BTED4</td><td>05/08-</td></tr> <tr><td>1.6 HDi FAP</td><td>DV6TED4/B</td><td>05/08-</td></tr> </table>	1.6i 16v.	TU5JP4/B	05/08-	1.6i 16v.	EP6C/B	05/08-	1.6 HDi	DV6ETED4/M	05/08-	1.6 HDi	DV6DTED/M	05/08-	1.6 HDi	DV6C	05/08-	1.6 HDi	DV6A/BTED4	05/08-	1.6 HDi FAP	DV6TED4/B	05/08-
1.6i 16v.	TU5JP4/B	05/08-																																											
1.6i 16v.	EP6C /B	05/08-																																											
1.6 HDi	DV6ETED4/M	05/08-																																											
1.6 HDi	DV6DTED/M	05/08-																																											
1.6 HDi	DV6C	05/08-																																											
1.6 HDi	DV6A/BTED4	05/08-																																											
1.6 HDi FAP	DV6TED4/B	05/08-																																											
1.6i 16v.	TU5JP4/B	05/08-																																											
1.6i 16v.	EP6C/B	05/08-																																											
1.6 HDi	DV6ETED4/M	05/08-																																											
1.6 HDi	DV6DTED/M	05/08-																																											
1.6 HDi	DV6C	05/08-																																											
1.6 HDi	DV6A/BTED4	05/08-																																											
1.6 HDi FAP	DV6TED4/B	05/08-																																											

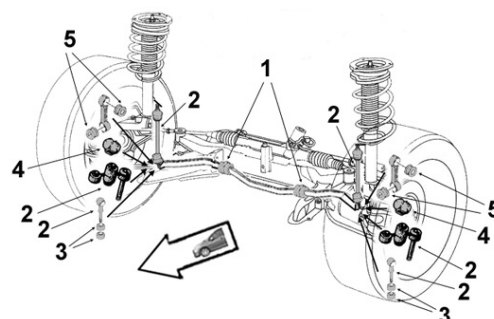



Barre stabilisatrice
Stabilizer bar
Barra estabilizadora
Drażek stabilizatora
стабилизатор поперечной устойчивости



0875395 OE 508761 	Biellette barre stab. <i>Stabilizer bar stub axle</i> 2 <table style="width: 100%; border-collapse: collapse;"> <tr><td>TT /all models</td><td></td><td>07/96-11/02</td></tr> <tr><td>1.4i</td><td>TU3 TU3A</td><td>11/02-05/08</td></tr> <tr><td>1.6i 16v.</td><td>TU5JP4</td><td>11/02-05/08</td></tr> <tr><td>1.6 HDi</td><td>DV6A/BTED4</td><td>11/02-05/08</td></tr> <tr><td>1.9 D</td><td>DW8B</td><td>11/02-05/08</td></tr> <tr><td>2.0 HDi</td><td>DW10TD</td><td>11/02-05/08</td></tr> </table>	TT /all models		07/96-11/02	1.4i	TU3 TU3A	11/02-05/08	1.6i 16v.	TU5JP4	11/02-05/08	1.6 HDi	DV6A/BTED4	11/02-05/08	1.9 D	DW8B	11/02-05/08	2.0 HDi	DW10TD	11/02-05/08	2300030 OE 508757 	Biellette barre stab. <i>Stabilizer bar stub axle</i> 2 <table style="width: 100%; border-collapse: collapse;"> <tr><td>1.6i 16v.</td><td>EP6C/DTR</td><td>05/08-</td></tr> <tr><td>1.6i 16v.</td><td>TU5JP4/B</td><td>05/08-</td></tr> <tr><td>1.6 HDi</td><td>DV6A/BTED4</td><td>05/08-</td></tr> <tr><td>1.6 HDi</td><td>DV6C</td><td>05/08-</td></tr> <tr><td>1.6 HDi</td><td>DV6DTED</td><td>05/08-</td></tr> <tr><td>1.6 HDi</td><td>DV6ETED4</td><td>05/08-</td></tr> <tr><td>1.6 HDi FAP</td><td>DV6TED4/B</td><td>05/08-</td></tr> </table>	1.6i 16v.	EP6C/DTR	05/08-	1.6i 16v.	TU5JP4/B	05/08-	1.6 HDi	DV6A/BTED4	05/08-	1.6 HDi	DV6C	05/08-	1.6 HDi	DV6DTED	05/08-	1.6 HDi	DV6ETED4	05/08-	1.6 HDi FAP	DV6TED4/B	05/08-
TT /all models		07/96-11/02																																								
1.4i	TU3 TU3A	11/02-05/08																																								
1.6i 16v.	TU5JP4	11/02-05/08																																								
1.6 HDi	DV6A/BTED4	11/02-05/08																																								
1.9 D	DW8B	11/02-05/08																																								
2.0 HDi	DW10TD	11/02-05/08																																								
1.6i 16v.	EP6C/DTR	05/08-																																								
1.6i 16v.	TU5JP4/B	05/08-																																								
1.6 HDi	DV6A/BTED4	05/08-																																								
1.6 HDi	DV6C	05/08-																																								
1.6 HDi	DV6DTED	05/08-																																								
1.6 HDi	DV6ETED4	05/08-																																								
1.6 HDi FAP	DV6TED4/B	05/08-																																								

0945655 OE 509465 	Palier de barre milieu <i>Middle bar main bearing</i> 1 Barre Ø 21 <table style="width: 100%; border-collapse: collapse;"> <tr><td>TT /all models familiale</td><td></td><td>07/96-11/02</td></tr> <tr><td>Susp. normale/réhaussée</td><td></td><td></td></tr> <tr><td>Susp. renforcée AV AR</td><td></td><td></td></tr> <tr><td>1.6 HDi</td><td>DV6BTED4</td><td>10/05-05/08</td></tr> </table>	TT /all models familiale		07/96-11/02	Susp. normale/réhaussée			Susp. renforcée AV AR			1.6 HDi	DV6BTED4	10/05-05/08	0945895 OE 5094E3 	Palier de barre milieu <i>Middle bar main bearing</i> 1 Barre Ø 23 <table style="width: 100%; border-collapse: collapse;"> <tr><td>1.6i 16v.</td><td>TU5JP4/B</td><td>05/08-</td></tr> <tr><td>1.6i 16v.</td><td>EP6C</td><td>05/08-</td></tr> <tr><td>1.6 HDi FAP</td><td>DV6TED4</td><td>05/08-</td></tr> <tr><td>1.6 HDi FAP</td><td>DV6TED4B</td><td>05/08-</td></tr> <tr><td>1.6 HDi</td><td>DV6A/BTED4</td><td>05/08-</td></tr> <tr><td>1.6 HDi</td><td>DV6C/DTED</td><td>06/10-</td></tr> </table>	1.6i 16v.	TU5JP4/B	05/08-	1.6i 16v.	EP6C	05/08-	1.6 HDi FAP	DV6TED4	05/08-	1.6 HDi FAP	DV6TED4B	05/08-	1.6 HDi	DV6A/BTED4	05/08-	1.6 HDi	DV6C/DTED	06/10-
TT /all models familiale		07/96-11/02																															
Susp. normale/réhaussée																																	
Susp. renforcée AV AR																																	
1.6 HDi	DV6BTED4	10/05-05/08																															
1.6i 16v.	TU5JP4/B	05/08-																															
1.6i 16v.	EP6C	05/08-																															
1.6 HDi FAP	DV6TED4	05/08-																															
1.6 HDi FAP	DV6TED4B	05/08-																															
1.6 HDi	DV6A/BTED4	05/08-																															
1.6 HDi	DV6C/DTED	06/10-																															

2300035 OE 5094E4 	Palier de barre milieu <i>Middle bar main bearing</i> 1 Barre Ø 24 <table style="width: 100%; border-collapse: collapse;"> <tr><td>1.6i 16v.</td><td>TU5JP4/B</td><td>05/08-</td></tr> <tr><td>1.6i 16v.</td><td>EP6C DTR</td><td>05/08-</td></tr> <tr><td>1.6i 16v.</td><td>EP6C</td><td>05/08-</td></tr> <tr><td>1.6 HDi</td><td>DV6DTED/M</td><td>05/08-</td></tr> <tr><td>1.6 HDi</td><td>DV6ETED4</td><td>05/08-</td></tr> <tr><td>1.6 HDi FAP</td><td>DV6TED4/B</td><td>05/08-</td></tr> <tr><td>1.6 HDi</td><td>DV6A/BTED4</td><td>05/08-</td></tr> <tr><td>1.6 HDi</td><td>DV6C</td><td>05/08-</td></tr> </table>	1.6i 16v.	TU5JP4/B	05/08-	1.6i 16v.	EP6C DTR	05/08-	1.6i 16v.	EP6C	05/08-	1.6 HDi	DV6DTED/M	05/08-	1.6 HDi	DV6ETED4	05/08-	1.6 HDi FAP	DV6TED4/B	05/08-	1.6 HDi	DV6A/BTED4	05/08-	1.6 HDi	DV6C	05/08-	2300036 OE 5094E7 	Palier de barre milieu <i>Middle bar main bearing</i> 1 Barre Ø 25 <table style="width: 100%; border-collapse: collapse;"> <tr><td>1.6i 16v.</td><td>TU5JP4/B</td><td>05/08-</td></tr> <tr><td>1.6i 16v.</td><td>EP6C DTR</td><td>05/08-</td></tr> <tr><td>1.6i 16v.</td><td>EP6C</td><td>05/08-</td></tr> <tr><td>1.6 HDi</td><td>DV6DTED/M</td><td>05/08-</td></tr> <tr><td>1.6 HDi</td><td>DV6ETED4</td><td>05/08-</td></tr> <tr><td>1.6 HDi FAP</td><td>DV6TED4/B</td><td>05/08-</td></tr> <tr><td>1.6 HDi</td><td>DV6A/BTED4</td><td>05/08-</td></tr> <tr><td>1.6 HDi</td><td>DV6C</td><td>05/08-</td></tr> </table>	1.6i 16v.	TU5JP4/B	05/08-	1.6i 16v.	EP6C DTR	05/08-	1.6i 16v.	EP6C	05/08-	1.6 HDi	DV6DTED/M	05/08-	1.6 HDi	DV6ETED4	05/08-	1.6 HDi FAP	DV6TED4/B	05/08-	1.6 HDi	DV6A/BTED4	05/08-	1.6 HDi	DV6C	05/08-
1.6i 16v.	TU5JP4/B	05/08-																																																	
1.6i 16v.	EP6C DTR	05/08-																																																	
1.6i 16v.	EP6C	05/08-																																																	
1.6 HDi	DV6DTED/M	05/08-																																																	
1.6 HDi	DV6ETED4	05/08-																																																	
1.6 HDi FAP	DV6TED4/B	05/08-																																																	
1.6 HDi	DV6A/BTED4	05/08-																																																	
1.6 HDi	DV6C	05/08-																																																	
1.6i 16v.	TU5JP4/B	05/08-																																																	
1.6i 16v.	EP6C DTR	05/08-																																																	
1.6i 16v.	EP6C	05/08-																																																	
1.6 HDi	DV6DTED/M	05/08-																																																	
1.6 HDi	DV6ETED4	05/08-																																																	
1.6 HDi FAP	DV6TED4/B	05/08-																																																	
1.6 HDi	DV6A/BTED4	05/08-																																																	
1.6 HDi	DV6C	05/08-																																																	

...Berlingo VL...



Eléments SUSPENSION
Suspension parts
Elementos suspensión
Elementy zawieszenie
Элементы подвески

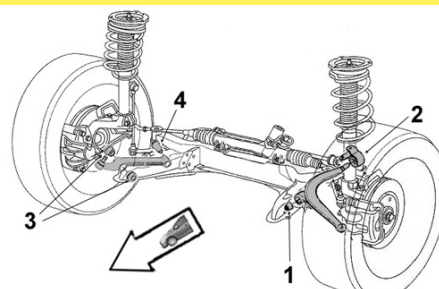

CITROËN

SASIC

2005250

OE 96110483

Articulation AV

Front bush

1 Ø int.12 Ø ext.33 coll.44 long. tube int.31
ext.27 ep. coll.4.5

TT /all models 07/96-11/02



5233913

OE 352391

Articulation AV

Front bush

1 Ø int.14 Ø ext.55 long. tube int.56 ext.32

1.6i 16v.	TU5JP4/B	05/08-
1.6i 16v.	EP6C	05/08-
1.6 HDi	DV6A/BTED4	05/08-
1.6 HDi FAP	DV6TED4	05/08-
1.6 HDi FAP	DV6C	06/10-
1.6 HDi FAP	DV6DTED	10/10-
1.6 HDi FAP	DV6TED4B	05/08-
90hp 66kw		



5233623

OE 352375

Articulation AR

Rear bush

2 Ø int.19

TT /all models Susp. renforcée AV AR 07/96-03/10/99



5233833

OE 352383

Articulation AR

Rear bush

2 Ø int.18

TT /all models	Susp. renforcée AV AR		04/10/99-11/02
1.4i	susp. renforcée AV AR ou réhaussée	TU3A	11/02-05/08
1.6i 16v.	susp. renforcée AV AR ou réhaussée	TU5JP4	11/02-05/08
1.6 HDi	Susp. normale /renforcée AV AR ou réhaussée	DV6A/BTED4	11/02-05/08
1.9 D	Avec pavillon multifonction susp. normale	DW8/B	-11/02
1.9 D	Susp. renforcée AV AR /normale réhaussée	DW8B	11/02-05/08
2.0 HDi		DW10TD	-11/02
2.0 HDi	Susp. normale /renforcée AV AR ou réhaussée	DW10TD	11/02-05/08



5233923

OE 352392

Articulation AR

Rear bush

2 Ø int.14 Ø ext.55 coll.62 long. tube int.49 ext.25 ep. coll.3

1.6i 16v.	TU5JP4/B	05/08-
1.6i 16v.	EP6C	05/08-
1.6 HDi	DV6A/BTED4	05/08-
1.6 HDi FAP	DV6TED4	05/08-
1.6 HDi FAP	DV6C	06/10-
1.6 HDi FAP	DV6DTED	10/10-
1.6 HDi FAP 90hp 66kw	DV6TED4B	05/08-



...Berlingo VL...

Bras & Triangle de suspension

Control arm
Brazo y triángulo
Wahacz
Рычаг подвески

G/L  D/R



CITROEN



5203F73

OE 3520H5

Triangle de susp. G

Left track control arm



4 Sans rotule Without tie rod end

1.1	Susp. normale /réhaussée	TU1M+/1JP	-10/02
1.4i	Susp. normale /réhaussée	TU3JP	-05/08
1.4i	Susp. normale	TU3A	11/02-05/08
1.6i 16v.	Susp. normale /réhaussée	TU5JP4	-10/02
1.6i 16v.	Susp. normale	TU5JP4	11/02-05/08
1.8	Susp. normale /réhaussée	XU7JB	-10/02
1.9 D	Susp. normale /réhaussée	XUD9	-10/02
1.9 D	Susp. réhaussée	DW8/B	-10/02
1.9 D	Susp. normale Sans pavillon multifonction	DW8B	-05/08

5213A73

OE 3521E5

Triangle de susp. D

Right track control arm



3 Sans rotule Without tie rod end

1.1	Susp. normale /réhaussée	TU1M+/1JP	-10/02
1.4i	Susp. normale /réhaussée	TU3JP	-05/08
1.4i	Susp. normale	TU3A	11/02-05/08
1.6i 16v.	Susp. normale /réhaussée	TU5JP4	-10/02
1.6i 16v.	Susp. normale	TU5JP4	11/02-05/08
1.8	Susp. normale /réhaussée	XU7JB	-10/02
1.9 D	Susp. normale /réhaussée	XUD9	-10/02
1.9 D	Susp. réhaussée	DW8/B	-10/02
1.9 D	Susp. normale Sans pavillon multifonction	DW8B	-05/08

5203F73

OE 3520K7

Triangle de susp. G

Left track control arm



4 Sans rotule Without tie rod end Susp. renforcée AV AR

1.1	TU1M+	-19/10/98
1.4i	TU3JP	-19/10/98
1.6i 16v.	TU5JP4	-19/10/98
1.8	XU7JB	-19/10/98
1.9 D	XUD9	-19/10/98

5213A73

OE 3521G7

Triangle de susp. D

Right track control arm



3 Sans rotule Without tie rod end Susp. renforcée AV AR

1.1	TU1M+	-19/10/98
1.4i	TU3JP	-19/10/98
1.6i 16v.	TU5JP4	-19/10/98
1.8	XU7JB	-19/10/98
1.9 D	XUD9	-19/10/98

7470017

OE (2oe)3520H5+364043

Triangle de susp. G

Left track control arm

NEW



4 Avec rotule With ball joint Ø 16 Susp. normale /réhaussée

1.1	TU1M+	-06/09/98
1.4i	TU3JP	-06/09/98
1.6i 16v.	TU5JP4	-06/09/98
1.8	XU7JB	-06/09/98
1.9 D	XUD9	-06/09/98

7470016

OE (2oe)3521E5+364043

Triangle de susp. D

Right track control arm

NEW



3 Avec rotule With ball joint Ø 16 Susp. normale /réhaussée

1.1	TU1M+	-06/09/98
1.4i	TU3JP	-06/09/98
1.6i 16v.	TU5JP4	-06/09/98
1.8	XU7JB	-06/09/98
1.9 D	XUD9	-06/09/98

...Berlingo VL...

Bras & Triangle de suspension

Control arm
Brazo y triángulo
Wahacz
Рычаг подвески

G/L  D/R



CITROEN

SASIC

7470019 Triangle de susp. G

OE (2oe)3520H5+364051 Left track control arm

NEW



4 Avec rotule With ball joint Ø 18

1.1		Susp. normale /réhaussée	TU1M+/1JP	-10/02
1.4i		Susp. normale	TU3A	11/02-05/08
1.4i		Susp. normale /réhaussée	TU3JP	07/09/98-10/02
1.6i 16v.		Susp. normale /réhaussée	TU5JP4	07/09/98-10/02
1.6i 16v.		Susp. normale	TU5JP4	11/02-05/08
1.8		Susp. normale /réhaussée	XU7JB	07/09/98-10/02
1.9 D		Susp. normale /réhaussée	XUD9	07/09/98-10/02
1.9 D		Susp. normale Sans pavillon multifonction/réhaussée DW8/B		-10/02
1.9 D		Susp. normale Sans pavillon multifonction	DW8B	11/02-05/08

7470018 Triangle de susp. D

OE (2oe)3521E5+364050 Right track control arm

NEW



3 Avec rotule With ball joint Ø 18

1.1		Susp. normale /réhaussée	TU1M+/1JP	-10/02
1.4i		Susp. normale	TU3A	11/02-05/08
1.4i		Susp. normale /réhaussée	TU3JP	07/09/98-10/02
1.6i 16v.		Susp. normale /réhaussée	TU5JP4	07/09/98-10/02
1.6i 16v.		Susp. normale	TU5JP4	11/02-05/08
1.8		Susp. normale /réhaussée	XU7JB	07/09/98-10/02
1.9 D		Susp. normale /réhaussée	XUD9	07/09/98-10/02
1.9 D		Susp. normale Sans pavillon multifonction/réhaussée DW8/B		-10/02
1.9 D		Susp. normale Sans pavillon multifonction	DW8B	11/02-05/08

5203J33 Triangle de susp. G

OE 3520J4 Left track control arm



4 Avec rotule With ball joint

1.1	DNA	Susp. renforcée AV AR	TU1M+ /1JP	04/10/99-10/02
1.4i	DNA	Susp. renforcée AV AR	TU3JP	04/10/99-10/02
1.6i 16v.	DNA	Susp. renforcée AV AR	TU5JP4	04/10/99-10/02
1.8	DNA	Susp. renforcée AV AR	XU7JB	04/10/99-10/02
1.9 D	DNA	Susp. normale Avec pavillon multifonction	DW8/B	-10/02
2.0 HDi	DNA		DW10TD	-10/02

5213F33 Triangle de susp. D

OE 3521F4 Right track control arm



3 Avec rotule With ball joint

1.1	DNA	Susp. renforcée AV AR	TU1M+/1JP	04/10/99-10/02
1.4i	DNA	Susp. renforcée AV AR	TU3JP	04/10/99-10/02
1.6i 16v.	DNA	Susp. renforcée AV AR	TU5JP4	04/10/99-10/02
1.8	DNA	Susp. renforcée AV AR	XU7JB	04/10/99-10/02
1.9 D	DNA	Susp. normale Avec pavillon multifonction	DW8/B	-10/02
2.0 HDi	DNA		DW10TD	-10/02

5203J33 Triangle de susp. G

OE 3520Q5 Left track control arm





4 Avec rotule With ball joint

1.1		Susp. renforcée AV AR	TU1M+	20/10/98-03/10/99
1.1	DA	Susp. renforcée AV AR	TU1M+	04/10/99-10/02
1.1	DA	Susp. renforcée AV AR	TU1JP	04/10/99-10/02
1.4i		Susp. normale réhaussée ou renforcée AV AR	TU3A	11/02-05/08
1.4i		Susp. renforcée AV AR	TU3JP	20/10/98-03/10/99
1.4i	DA	Susp. renforcée AV AR	TU3JP	04/10/99-10/02
1.4i		Susp. normale réhaussée ou renforcée AV AR	TU3JP	11/02-05/08
1.6i 16v.		Susp. renforcée AV AR	TU5JP4	20/10/98-03/10/99
1.6i 16v.	DA	Susp. renforcée AV AR	TU5JP4	04/10/99-10/02
1.6i 16v.		Susp. normale réhaussée ou renforcée AV AR	TU5JP4	11/02-05/08
1.6 HDi		Susp. normale/réhaussée ou renforcée AV AR	DV6ATED4	11/02-05/08
1.6 HDi			DV6BTED4	11/02-05/08
1.8		Susp. renforcée AV AR	XU7JB	20/10/98-03/10/99
1.8	DA	Susp. renforcée AV AR	XU7JB	04/10/99-10/02 ...

...Berlingo VL...

... 5203J33		Triangle de susp. G	
OE 3520Q5		<i>Left track control arm</i>	
	4	Avec rotule With ball joint	
	1.9 D		Susp. renforcée AV AR XUD9 20/10/98-03/10/99
	1.9 D	DA	Susp. normale Avec pavillon multifonction DW8/B -10/02
	1.9 D		Susp. normale Avec pavillon multifonction DW8B 11/02-05/08
	1.9 D		Susp. normale réhaussée ou renforcée AV AR DW8B 11/02-05/08
	2.0 HDi	DA	Susp. normale/réhaussée ou renforcée AV AR DW10TD -10/02
	2.0 HDi		susp. normale/réhaussée ou renforcée AV AR DW10TD 11/02-05/08
	TT Elec. /All models Electric		Susp. normale réhaussée SA18 11/02-05/08
			Susp. renforcée AV AR SA18 11/02-05/08

5213F33		Triangle de susp. D	
OE 3521R4		<i>Right track control arm</i>	
	3	Avec rotule With ball joint	
	1.1		Susp. renforcée AV AR TU1M+ 20/10/98-03/10/99
	1.1	DA	Susp. renforcée AV AR TU1M+ 04/10/99-10/02
	1.1	DA	Susp. renforcée AV AR TU1JP 04/10/99-10/02
	1.4i		Susp. normale réhaussée ou renforcée AV AR TU3A 11/02-05/08
	1.4i		Susp. renforcée AV AR TU3JP 20/10/98-03/10/99
	1.4i	DA	Susp. renforcée AV AR TU3JP 04/10/99-10/02
	1.4i		Susp. normale réhaussée ou renforcée AV AR TU3JP 11/02-05/08
	1.6i 16v.		Susp. renforcée AV AR TU5JP4 20/10/98-03/10/99
	1.6i 16v.	DA	Susp. renforcée AV AR TU5JP4 04/10/99-10/02
	1.6i 16v.		Susp. normale réhaussée ou renforcée AV AR TU5JP4 11/02-05/08
	1.6 HDi		Susp. normale/réhaussée ou renforcée AV AR DV6ATED4 11/02-05/08
	1.6 HDi		Susp. normale/réhaussée ou renforcée AV AR DV6BTED4 11/02-05/08
	1.8		Susp. renforcée AV AR XU7JB 20/10/98-03/10/99
	1.8	DA	Susp. renforcée AV AR XU7JB 04/10/99-10/02
	1.9 D		Susp. renforcée AV AR XUD9 20/10/98-03/10/99
	1.9 D	DA	Susp. normale Avec pavillon multifonction DW8/B -10/02
	1.9 D		Susp. normale Avec pavillon multifonction DW8B 11/02-05/08
	1.9 D		Susp. normale réhaussée ou renforcée AV AR DW8B 11/02-05/08
	2.0 HDi	DA	Susp. normale/réhaussée ou renforcée AV AR DW10TD -10/02
2.0 HDi		susp. normale/réhaussée ou renforcée AV AR DW10TD 11/02-05/08	
TT Elec. /All models Electric		Susp. normale réhaussée SA18 11/02-05/08	
		Susp. renforcée AV AR SA18 11/02-05/08	

5203K83		Triangle de susp. inf. G		5213G83		Triangle de susp. inf. D	
OE 3520S2		<i>Lower left track control arm</i>		OE 3521P3		<i>Lower right track control arm</i>	
	4	Sans rotule Without ball joint			3	Sans rotule Without ball joint	
	1.6i 16v.	EP6C/B	05/08-		1.6i 16v.	EP6C/B	05/08-
	1.6i 16v.	TU5JP4/B	05/08-		1.6i 16v.	TU5JP4/B	05/08-
	1.6 HDi	DV6D/ETED M	05/08-		1.6 HDi	DV6D/ETED M	05/08-
	1.6 HDi	DV6C	05/08-		1.6 HDi	DV6C	05/08-
	1.6 HDi	DV6A/BTED4	05/08-		1.6 HDi	DV6A/BTED4	05/08-
	1.6 HDi	DV6DTED	05/08-		1.6 HDi	DV6DTED	05/08-
	1.6 HDi	DV6ETED4	05/08-		1.6 HDi	DV6ETED4	05/08-
	1.6 HDi FAP	DV6TED4/B	05/08-		1.6 HDi FAP	DV6TED4/B	05/08-

2005113		Rotule de susp. inf. G/D	
OE 364043		<i>L/R lower suspension ball joint</i>	
	1	Ø 16	
	2	Susp. normale /réhaussée	
	1.1		TU1M+/JP -06/09/98
	1.4i		TU3JP -06/09/98
	1.6i 16v.		TU5JP4 -06/09/98
	1.8		XU7JB -06/09/98
1.9 D		XUD9 -06/09/98	

6403513		Rotule de susp. inf. G/D	
OE 364051		<i>L/R lower suspension ball joint</i>	
	1	Ø 18	
	2	Susp. normale /réhaussée	
	1.1		TU1M+TU1JP 07/09/98-10/02
	1.4i		TU3JP 07/09/98-05/08
	1.4i		Susp. normale TU3A 11/02-05/08
	1.6i 16v.		Susp. normale /réhaussée TU5JP4 07/09/98-10/02
	1.6i 16v.		Susp. normale TU5JP4 11/02-05/08
	1.8		Susp. normale /réhaussée XU7JB 07/09/98-10/02
	1.9 D		Susp. normale /réhaussée XUD9 07/09/98-10/02
1.9 D		Susp. normale Sans pavillon multifonction DW8/B -10/02	
1.9 D		Susp. réhaussée DW8/B -10/02	

...Berlingo VL...

SASIC

CITROEN

Bras & Triangle de suspension

Control arm
Brazo y triángulo
Wahacz
Рычаг подвески

G/L  D/R

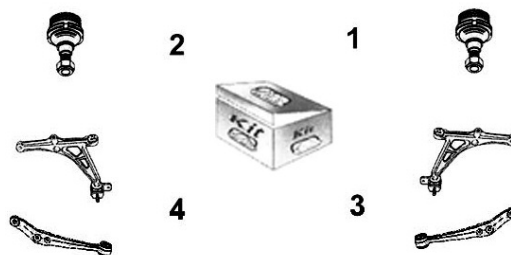

6403533

OE 364068

Rotule de susp. inf. G/D

L/R lower suspension ball joint



1			
2	1.6i 16v.	EP6C/B	05/08-
	1.6i 16v.	TU5JP4/B	05/08-
	1.6 HDi	DV6D/ETED M	05/08-
	1.6 HDi	DV6A/BTED4	05/08-
	1.6 HDi	DV6C	05/08-
	1.6 HDi	DV6DTED	05/08-
	1.6 HDi	DV6ETED4	05/08-
	1.6 HDi FAP	DV6TED4/B	05/08-

1003562

OE -

Kit rép. triangle susp. G ou D

L or R track control arm bearing repair kit



Avec visserie With screws and bolts
Articulation AR Ø 19

1.1	TU1M+ TU1JP	-10/02
1.4i	TU3JP	-10/02
1.6i 16v.	TU5JP4	-10/02
1.8	XU7JB	-10/02
1.9 D	XUD9 DW8/B	-10/02
2.0 HDi	DW10TD	-10/02

1073562B

OE -

Kit rép. train AV complet

Front axle complete repair kit



Avec visserie With screws and bolts Barre Ø 21 Art. AR Ø 19

Susp. normale /réhaussée /renforcée AV AR

1.1	TU1M+ TU1JP	-10/02
1.4i	TU3JP	-10/02
1.6i 16v.	TU5JP4	-10/02
1.8	XU7JB	-10/02
1.9 D	XUD9 DW8/B	-10/02
2.0 HDi	DW10TD	-10/02

107A562S

OE -

Kit rép. train AV

Front axle repair kit



Sans visserie Without screws and bolts Barre Ø 21 Art. AR Ø 19
Susp. normale /réhaussée /renforcée AV AR

1.1	TU1M+ TU1JP	-10/02
1.4i	TU3JP	-10/02
1.6i 16v.	TU5JP4	-10/02
1.8	XU7JB	-10/02
1.9 D	XUD9 DW8/B	-10/02
2.0 HDi	DW10TD	-10/02



Support d'amortisseur

Suspension mounting
Soporte amortiguador
Poduszka amortyzatora
Опора амортизатора

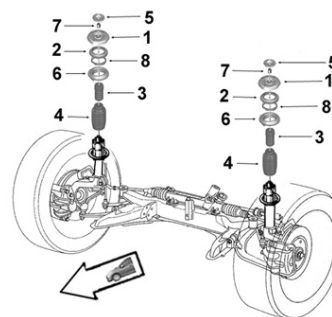

0385235

OE 503876

Support suspension G/D

L/R suspension mounting



1		
	TT /all models familiale	
	DNA susp. normale /réhaussée	
	/R renforcée AV AR	07/96-11/02
	sauf 2.0 HDi Mot. DW10TD	09/09/02-

0385245

OE 503878





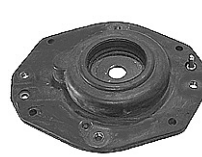

Support suspension G/D

L/R suspension mounting



1	TT /all models familiale	
	DA susp. normale /réhaussée /renforcée	
	ou Pavillon multifonction	07/96-11/02
	sauf 2.0 HDi Mot. DW10TD	09/09/02-
	1.1i	TU1M 07/96-11/02
	1.4i GNV /essence sans plomb	
		TU3JP 07/96-11/02
	1.4i	TU3A/JP 11/02-05/08
	1.6 HDi	DV6A/BTED4 11/02-05/08
	1.9 D	DW8B 11/02-05/08
	2.0 HDi	DW10TD 11/02-05/08

...Berlingo VL...

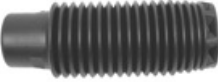
<p>0385855 OE 5038G0</p> 	<p>Support suspension G/D <i>L/R suspension mounting</i></p> <p>1</p> <table style="width: 100%; border-collapse: collapse;"> <tr><td style="width: 33%;">1.6i 16v.</td><td style="width: 33%;">TU5JP4/B</td><td style="width: 33%;">05/08-</td></tr> <tr><td>1.6i 16v.</td><td>EP6C</td><td>05/08-</td></tr> <tr><td>1.6 HDi</td><td>DV6A/BTED4</td><td>05/08-</td></tr> <tr><td>1.6 HDi 90hp</td><td>66kw FAP DV6TED4B</td><td>05/08-</td></tr> <tr><td>1.6 HDi FAP</td><td>DV6TED4</td><td>05/08-</td></tr> </table>	1.6i 16v.	TU5JP4/B	05/08-	1.6i 16v.	EP6C	05/08-	1.6 HDi	DV6A/BTED4	05/08-	1.6 HDi 90hp	66kw FAP DV6TED4B	05/08-	1.6 HDi FAP	DV6TED4	05/08-	<p>0385935 OE 503893</p> 	<p>Support suspension G/D <i>L/R suspension mounting</i></p> <p>1</p> <p>2.0 HDi Pavillon multifonction DW10TD 09/09/02-11/02</p> <p>2.0 HDi familiale susp. normale /réhaussée /susp. renforcée AV AR DW10TD 09/09/02-11/02</p>																																																			
1.6i 16v.	TU5JP4/B	05/08-																																																																			
1.6i 16v.	EP6C	05/08-																																																																			
1.6 HDi	DV6A/BTED4	05/08-																																																																			
1.6 HDi 90hp	66kw FAP DV6TED4B	05/08-																																																																			
1.6 HDi FAP	DV6TED4	05/08-																																																																			
<p>0355275 OE 503563</p> 	<p>Butée à billes G/D <i>L/R ball bearing</i></p> <p>2</p> <table style="width: 100%; border-collapse: collapse;"> <tr><td style="width: 33%;">1.1i</td><td style="width: 33%;">TU1M+ /JP</td><td style="width: 33%;">07/96-11/02</td></tr> <tr><td>1.4i</td><td>TU3JP</td><td>07/96-11/02</td></tr> <tr><td>1.4i</td><td>TU3JP/3A</td><td>11/02-05/08</td></tr> <tr><td>1.6i 16v.</td><td>TU5JP4</td><td>07/96-11/02</td></tr> <tr><td>1.6i 16v.</td><td>TU5JP4/B</td><td>05/08-</td></tr> <tr><td>1.6i 16v.</td><td>EP6C/DTR</td><td>05/08-</td></tr> <tr><td>1.6 HDi</td><td>DV6A/BTED4</td><td>11/02-</td></tr> <tr><td>1.6 HDi</td><td>DV6C</td><td>05/08-</td></tr> <tr><td>1.6 HDi</td><td>DV6DTED/4</td><td>05/08-</td></tr> <tr><td>1.6 HDi FAP</td><td>DV6TED4/B</td><td>05/08-</td></tr> <tr><td>1.8i</td><td>XU7JB</td><td>07/96-11/02</td></tr> <tr><td>1.9 D</td><td>XUD9 DW8/B</td><td>07/96-11/02</td></tr> <tr><td>1.9 D</td><td>DW8B</td><td>11/02-05/08</td></tr> <tr><td>2.0 HDi</td><td>DW10TD</td><td>07/96-05/08</td></tr> </table>	1.1i	TU1M+ /JP	07/96-11/02	1.4i	TU3JP	07/96-11/02	1.4i	TU3JP/3A	11/02-05/08	1.6i 16v.	TU5JP4	07/96-11/02	1.6i 16v.	TU5JP4/B	05/08-	1.6i 16v.	EP6C/DTR	05/08-	1.6 HDi	DV6A/BTED4	11/02-	1.6 HDi	DV6C	05/08-	1.6 HDi	DV6DTED/4	05/08-	1.6 HDi FAP	DV6TED4/B	05/08-	1.8i	XU7JB	07/96-11/02	1.9 D	XUD9 DW8/B	07/96-11/02	1.9 D	DW8B	11/02-05/08	2.0 HDi	DW10TD	07/96-05/08	<p>2650035 OE 503151</p> 	<p>Coupelle amortisseur G/D <i>L/R shock absorber cup</i></p> <p>6</p> <table style="width: 100%; border-collapse: collapse;"> <tr><td style="width: 33%;">1.6i 16v.</td><td style="width: 33%;">EP6C/DTR</td><td style="width: 33%;">05/08-</td></tr> <tr><td>1.6i 16v.</td><td>TU5JP4/B</td><td>05/08-</td></tr> <tr><td>1.6 HDi</td><td>DV6A/BTED4</td><td>05/08-</td></tr> <tr><td>1.6 HDi</td><td>DV6C</td><td>05/08-</td></tr> <tr><td>1.6 HDi</td><td>DV6DTED /M</td><td>05/08-</td></tr> <tr><td>1.6 HDi</td><td>DV6ETED M</td><td>05/08-</td></tr> <tr><td>1.6 HDi</td><td>DV6ETED4</td><td>05/08-</td></tr> <tr><td>1.6 HDi FAP</td><td>DV6TED4/B</td><td>05/08-</td></tr> </table>	1.6i 16v.	EP6C/DTR	05/08-	1.6i 16v.	TU5JP4/B	05/08-	1.6 HDi	DV6A/BTED4	05/08-	1.6 HDi	DV6C	05/08-	1.6 HDi	DV6DTED /M	05/08-	1.6 HDi	DV6ETED M	05/08-	1.6 HDi	DV6ETED4	05/08-	1.6 HDi FAP	DV6TED4/B	05/08-
1.1i	TU1M+ /JP	07/96-11/02																																																																			
1.4i	TU3JP	07/96-11/02																																																																			
1.4i	TU3JP/3A	11/02-05/08																																																																			
1.6i 16v.	TU5JP4	07/96-11/02																																																																			
1.6i 16v.	TU5JP4/B	05/08-																																																																			
1.6i 16v.	EP6C/DTR	05/08-																																																																			
1.6 HDi	DV6A/BTED4	11/02-																																																																			
1.6 HDi	DV6C	05/08-																																																																			
1.6 HDi	DV6DTED/4	05/08-																																																																			
1.6 HDi FAP	DV6TED4/B	05/08-																																																																			
1.8i	XU7JB	07/96-11/02																																																																			
1.9 D	XUD9 DW8/B	07/96-11/02																																																																			
1.9 D	DW8B	11/02-05/08																																																																			
2.0 HDi	DW10TD	07/96-05/08																																																																			
1.6i 16v.	EP6C/DTR	05/08-																																																																			
1.6i 16v.	TU5JP4/B	05/08-																																																																			
1.6 HDi	DV6A/BTED4	05/08-																																																																			
1.6 HDi	DV6C	05/08-																																																																			
1.6 HDi	DV6DTED /M	05/08-																																																																			
1.6 HDi	DV6ETED M	05/08-																																																																			
1.6 HDi	DV6ETED4	05/08-																																																																			
1.6 HDi FAP	DV6TED4/B	05/08-																																																																			
<p>0335655 OE 503365</p> 	<p>Butée de suspension G/D <i>L/R suspension bush</i></p> <p>3 H109 susp. normale</p> <table style="width: 100%; border-collapse: collapse;"> <tr><td style="width: 33%;">1.4i</td><td style="width: 33%;">TU3JP</td><td style="width: 33%;">11/02-05/08</td></tr> <tr><td>1.4i</td><td>TU3A</td><td>11/02-05/08</td></tr> <tr><td>1.6i 16v.</td><td>TU5JP4</td><td>11/02-05/08</td></tr> <tr><td>1.9 D</td><td>DW8B</td><td>11/02-05/08</td></tr> <tr><td>2.0 HDi</td><td>DW10TD</td><td>11/02-05/08</td></tr> </table> <p>Susp. normale réhaussée</p> <table style="width: 100%; border-collapse: collapse;"> <tr><td style="width: 33%;">1.6 HDi</td><td style="width: 33%;">DV6A/BTED4</td><td style="width: 33%;">11/02-05/08</td></tr> </table>	1.4i	TU3JP	11/02-05/08	1.4i	TU3A	11/02-05/08	1.6i 16v.	TU5JP4	11/02-05/08	1.9 D	DW8B	11/02-05/08	2.0 HDi	DW10TD	11/02-05/08	1.6 HDi	DV6A/BTED4	11/02-05/08	<p>0335275 OE 503327</p> 	<p>Butée de suspension G/D <i>L/R suspension bush</i></p> <p>3 H97 TT /all models 07/96-11/02</p> <p>Susp. renforcée AV AR</p> <table style="width: 100%; border-collapse: collapse;"> <tr><td style="width: 33%;">1.6i 16v.</td><td style="width: 33%;">TU5JP4</td><td style="width: 33%;">11/02-05/08</td></tr> <tr><td>1.6 HDi</td><td>DV6ATED4</td><td>11/02-05/08</td></tr> <tr><td>1.9 D</td><td>DW8B</td><td>11/02-05/08</td></tr> </table> <p>Susp. renforcée AV AR ou réhaussée</p> <table style="width: 100%; border-collapse: collapse;"> <tr><td style="width: 33%;">2.0 HDi</td><td style="width: 33%;">DW10TD</td><td style="width: 33%;">11/02-05/08</td></tr> </table>	1.6i 16v.	TU5JP4	11/02-05/08	1.6 HDi	DV6ATED4	11/02-05/08	1.9 D	DW8B	11/02-05/08	2.0 HDi	DW10TD	11/02-05/08																																				
1.4i	TU3JP	11/02-05/08																																																																			
1.4i	TU3A	11/02-05/08																																																																			
1.6i 16v.	TU5JP4	11/02-05/08																																																																			
1.9 D	DW8B	11/02-05/08																																																																			
2.0 HDi	DW10TD	11/02-05/08																																																																			
1.6 HDi	DV6A/BTED4	11/02-05/08																																																																			
1.6i 16v.	TU5JP4	11/02-05/08																																																																			
1.6 HDi	DV6ATED4	11/02-05/08																																																																			
1.9 D	DW8B	11/02-05/08																																																																			
2.0 HDi	DW10TD	11/02-05/08																																																																			
<p>2545135 OE 525413</p> 	<p>Protecteur amortisseur G/D <i>L/R shock absorber protector</i></p> <p>4</p> <table style="width: 100%; border-collapse: collapse;"> <tr><td style="width: 33%;">1.1i</td><td style="width: 33%;">TU1M+ / TU1JP</td><td style="width: 33%;">07/96-11/02</td></tr> <tr><td>1.4i</td><td>TU3JP</td><td>07/96-11/02</td></tr> <tr><td>1.6i 16v.</td><td>TU5JP4</td><td>07/96-11/02</td></tr> <tr><td>1.8i</td><td>XU7JB</td><td>07/96-11/02</td></tr> <tr><td>1.9 D</td><td>XUD9 DW8/B</td><td>07/96-11/02</td></tr> <tr><td>2.0 HDi</td><td>DW10TD</td><td>07/96-11/02</td></tr> </table>			1.1i	TU1M+ / TU1JP	07/96-11/02	1.4i	TU3JP	07/96-11/02	1.6i 16v.	TU5JP4	07/96-11/02	1.8i	XU7JB	07/96-11/02	1.9 D	XUD9 DW8/B	07/96-11/02	2.0 HDi	DW10TD	07/96-11/02																																																
1.1i	TU1M+ / TU1JP	07/96-11/02																																																																			
1.4i	TU3JP	07/96-11/02																																																																			
1.6i 16v.	TU5JP4	07/96-11/02																																																																			
1.8i	XU7JB	07/96-11/02																																																																			
1.9 D	XUD9 DW8/B	07/96-11/02																																																																			
2.0 HDi	DW10TD	07/96-11/02																																																																			
<p>2545335 OE 525433</p> 	<p>Protecteur amortisseur G/D <i>L/R shock absorber protector</i></p> <p>4</p> <table style="width: 100%; border-collapse: collapse;"> <tr><td style="width: 33%;">1.4i</td><td style="width: 33%;">TU3JP TU3A</td><td style="width: 33%;">11/02-05/08</td></tr> <tr><td>1.6i 16v.</td><td>TU5JP4</td><td>11/02-05/08</td></tr> <tr><td>1.6 HDi</td><td>DV6BTED4</td><td>11/02-05/08</td></tr> <tr><td>1.6 HDi</td><td>DV6ATED4</td><td>11/02-05/08</td></tr> <tr><td>1.9 D</td><td>DW8B</td><td>11/02-05/08</td></tr> <tr><td>2.0 HDi</td><td>DW10TD</td><td>11/02-05/08</td></tr> </table>			1.4i	TU3JP TU3A	11/02-05/08	1.6i 16v.	TU5JP4	11/02-05/08	1.6 HDi	DV6BTED4	11/02-05/08	1.6 HDi	DV6ATED4	11/02-05/08	1.9 D	DW8B	11/02-05/08	2.0 HDi	DW10TD	11/02-05/08																																																
1.4i	TU3JP TU3A	11/02-05/08																																																																			
1.6i 16v.	TU5JP4	11/02-05/08																																																																			
1.6 HDi	DV6BTED4	11/02-05/08																																																																			
1.6 HDi	DV6ATED4	11/02-05/08																																																																			
1.9 D	DW8B	11/02-05/08																																																																			
2.0 HDi	DW10TD	11/02-05/08																																																																			

...Berlingo VL...

SASIC

CITROEN



Support d'amortisseur
Suspension mounting
Soporte amortiguador
Poduszka amortyzatora
Опора амортизатора

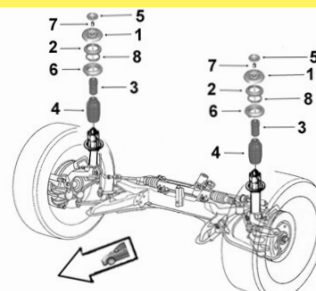

1005270

Kit rép. suspension

OE -

Susp. mounting repair kit



1.1	DA susp. normale /réhaussée /renf. AV AR	TU1M+	-10/02
1.1	Pavillon multifonction	TU1JP	-10/02
1.4i	Pavillon multifonction	TU3JP	-10/02
1.4i	Pavillon multifonction	TU3JP	11/02-05/08
1.6i 16v.	DA susp. normale /réhaussée /susp. renforcée AV AR	TU5JP4	-10/02
1.6i 16v.	Pavillon multifonction	TU5JP4	-10/02
1.6i 16v.	Pavillon multifonction	TU5JP4	11/02-05/08
1.8	DA susp. normale /réhaussée /renforcée AV AR	XU7JB	-10/02
1.8	Pavillon multifonction	XU7JB	-10/02
1.9 D	DA susp. normale /susp. réhaussée /renforcée AV AR	XUD9	-10/02
1.9 D	Pavillon multifonction	XUD9	-10/02
1.9 D	DA susp. normale	DW8/B	-10/02
1.9 D	DA susp. réhaussée	DW8/B	-10/02
1.9 D	DA susp. renforcée AV AR	DW8/B	-10/02
1.9 D	Pavillon multifonction	DW8/B	-10/02
1.9 D	Pavillon multifonction	DW8B	11/02-05/08
2.0 HDi	DA susp. normale /réhaussée /renforcée AV AR	DW10TD	-09/09/02
2.0 HDi	Pavillon multifonction	DW10TD	-09/09/02
2.0 HDi	Pavillon multifonction	DW10TD	11/02-05/08

1005269

Kit rép. suspension G ou D

OE -

L/R stabilizing bar repair kit



DNA susp. normale /réhaussée /renforcée AV AR

1.1	TU1M+ TU1JP	-10/02
1.4i	TU3JP	-10/02
1.6i 16v.	TU5JP4	-10/02
1.8	XU7JB	-10/02
1.9 D	XUD9 DW8/B	-10/02
2.0 HDi	DW10TD	-09/09/02



Support d'amortisseur
Suspension mounting
Soporte amortiguador
Poduszka amortyzatora
Опора амортизатора

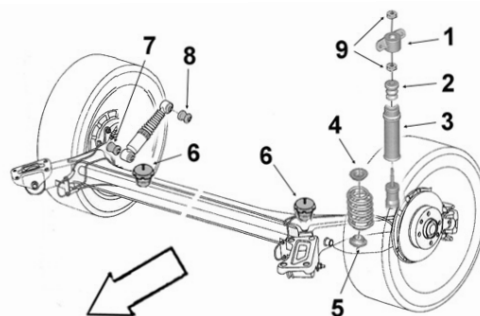

1715125

Articulation amort. sup.

OE 517112









Upper shock absorber bush



8 Ø int.16 Ø ext.33 coll.37 x2 long. tube int.45 ext.21 ep. coll.4x2

1.1i	TU1M+ TU1JP	07/96-11/02
1.4i	TU3JP	07/96-11/02
1.4i	TU3JP TU3A	11/02-05/08
1.6i 16v.	TU5JP4	07/96-05/08
1.6 HDi	DV6A/BTED4	11/02-05/08
1.8i	XU7JB	07/96-11/02
1.9 D	XUD9 DW8/B	07/96-11/02
1.9 D	DW8B	11/02-05/08
2.0 HDi	DW10TD	07/96-05/08

...Berlingo VL...

...Berlingo VL...			
1715115 OE 517111	Articulation amort. inf. <i>Lower shock absorber bush</i>		
	7 Ø int.16 Ø ext.34 coll.37 x2 long. tube int.45 ext.21 ep. coll.4x2 1.1i TU1M+/ TU1JP 07/96-11/02 1.4i TU3JP 07/96-05/08 1.4i TU3A 11/02-05/08 1.6i 16v. TU5JP4 07/96-05/08 1.6 HDi DV6A/BTED4 11/02-05/08 1.8i XU7JB 07/96-11/02 1.9 D XUD9 DW8/B 07/96-11/02 1.9 D DW8B 11/02-05/08 2.0 HDi DW10TD 07/96-05/08		
2001026 Part/oe 516672	Butée de talonnage <i>Bushing</i>	1665635 OE 516663	Butée de talonnage <i>Bushing</i>
	6 Ø 55 H 74 1.1i TU1JP 08/09/03-05/08 1.4i TU3A TU3JP 08/09/03-05/08 1.6i 16v. TU5JP4 08/09/03-05/08 1.6 HDi DV6A/BTED4 08/09/03-05/08 1.9 D DW8B 08/09/03-05/08 2.0 HDi DW10TD 08/09/03-05/08		6 Ø 55 H 82 1.1i TU1M+/ TU1JP 07/96-11/02 1.4i TU3JP 07/96-07/09/03 1.4i TU3A 11/02-07/09/03 1.6i 16v. TU5JP4 07/96-07/09/03 1.6 HDi DV6A/BTED4 11/02-07/09/03 1.8i XU7JB 07/96-11/02 1.9 D XUD9 DW8/B 07/96-11/02 1.9 D DW8B 11/02-07/09/03 2.0 HDi DW10TD 07/96-07/09/03
2001025 Part/oe 516673	Butée de talonnage <i>Bushing</i>		
	6 Ø 55 H 93 1.4i TU3JP TU3A 08/09/03-05/08 1.6i 16v. TU5JP4 08/09/03-05/08 1.6 HDi DV6A/BTED4 08/09/03-05/08 1.9 D DW8B 08/09/03-05/08 2.0 HDi DW10TD 08/09/03-05/08		
Eléments TRAIN ARRIERE <i>Rear axle parts</i> <i>Tren TRAS</i> <i>Elementy zawieszenia tylnego</i> <i>элементы задней оси.</i>			
1315475 OE 513147	Articulation AV Bras <i>Arm front bush</i>	1525625 OE 515264	Support train AR <i>Rear axle mounting</i>
	Ø int.12.2 Ø ext. 46.9 coll. 54.5 long. tube int.27.5 ext.17 ep. coll.10 susp. renforcée AV AR ou réhaussée 1.6i 16v. TU5JP4 11/02-05/08		1.1i TU1M+/ 1JP 07/96-11/02 Susp. normale 1.4i TU3JP 07/96-05/08 1.4i TU3A 11/02-05/08 1.6i 16v. TU5JP4 07/96-05/08 1.6 HDi DV6A/BTED4 11/02-05/08 1.8i XU7JB 07/96-11/02 1.9 D XUD9 DW8/B 07/96-11/02 1.9 D DW8B 11/02-05/08 2.0 HDi DW10TD 07/96-05/08
2600004 OE 5131F2	Articulation essieu <i>Axle bush</i>		
	Ø int. 14 Ø ext. 80 coll. 87 long. tube int. 79 ext. 59 ep. coll.7 1.6i 16v. Susp. normale Haute moyenne Moyenne basse Sup. basse plus Sans assise supplémentaire TU5JP4/B EP6C 05/08-04/04/10 1.6 HDi Susp. normale Haute moyenne Moyenne basse Sup. basse plus Sans assise supplémentaire DV6A/BTED4 05/08-04/04/10 1.6 HDi Susp. normale Sauf basse moyenne DV6DTED/M DV6ETED M 06/10/08- 1.6 HDi FAP Susp. normale Haute moyenne Moyenne basse Sup. basse plus Sans assise supplémentaire DV6TED4/B 05/08-04/04/10		

...Berlingo VL

Eléments TRAIN ARRIERE

Rear axle parts

Tren TRAS

Elementy zawieszenia tylnego

элементы задней оси.



SASIC

CITROËN

2600007

Articulation essieu

OE 5131H1

Axle bush



Ø int. 14 Ø ext. 82 coll. 90 long. tube int.79 ext.54 ep. Coll.7

1.6i 16v.	Susp. renforcée AV AR	TU5JP4 TU5JP4B EP6C	05/08-04/04/10
1.6i 16v.		EP6C DTR	06/10/08-
1.6i 16v.	Susp. normale Basse basse/moyenne sans assise supplémentaire	TU5JP4/B	05/08-04/04/10
		EP6C	05/08-04/04/10
1.6i 16v.	Susp. normale 2 sièges séparés supplémentaires	TU5JP4/B EP6C	05/08-04/04/10
1.6i 16v.		TU5JP4/B EP6C	05/04/10-
1.6 HDi	Susp. renforcée AV AR	DV6A/BTED4	05/08-04/04/10
1.6 HDi		DV6DTED	06/10/08-
1.6 HDi	Susp. renforcée AV AR	DV6ETED M	06/10/08-
1.6 HDi		DV6C DV6ETED4	06/10/08-
1.6 HDi	Susp. normale Basse basse/moyenne sans assise suppl.	DV6A/BTED4	05/08-04/04/10
1.6 HDi	Susp. normale Basse moyenne	DV6D/ETED M	06/10/08-
1.6 HDi	Susp. normale 2 sièges séparés supplémentaires	DV6A/BTED4	05/08-04/04/10
1.6 HDi		DV6A/BTED4	05/04/10-
1.6 HDi	Susp. renforcée AV AR	DV6DTED M	06/10/08-
1.6 HDi FAP	Susp. renforcée AV AR	DV6TED4/B	05/08-04/04/10
1.6 HDi FAP	Susp. normale Basse basse/moyenne sans assise supplémentaire	DV6TED4/B	05/08-04/04/10
		DV6TED4/B	05/08-04/04/10
1.6 HDi FAP	Susp. normale 2 sièges séparés suppl.	DV6TED4/B	05/08-04/04/10
1.6 HDi FAP		DV6TED4/B	05/04/10-

1005127

Kit rép. train AR G ou D

OE -

L/R rear axle repair kit



1.1	TU1M+	-10/02
1.1	TU1JP	-10/02
1.4i	TU3JP	-10/02
1.6i 16v.	TU5JP4	-10/02
1.8	XU7JB	-10/02
1.9 D	XUD9	-10/02
1.9 D	DW8/B	-10/02
2.0 HDi	DW10TD	-10/02

BX...

Eléments DIRECTION

Steering parts

Elementos Direcciones

Elementy układ kierowniczy

Элементы рулевой системы

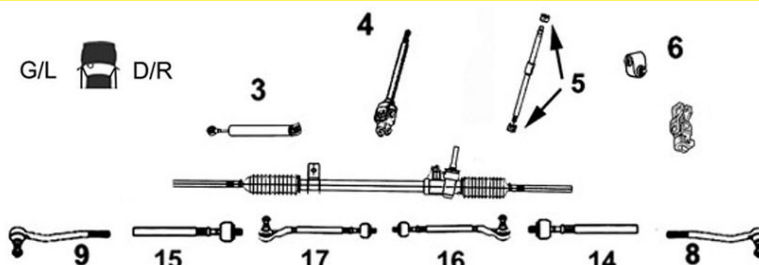

2006020

Axe de bielle G/D

OE 95495440







L/R axial joint

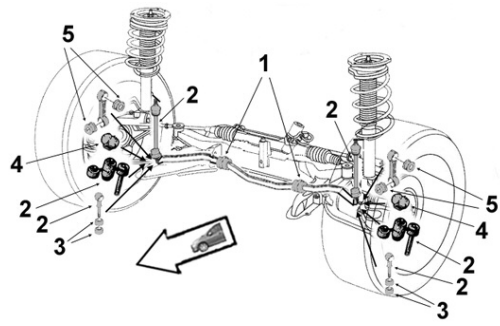

14 Côté dir. M12x1.0 Côté rot. M14x1.5 long 124 mm
15

TT /all models 09/82-

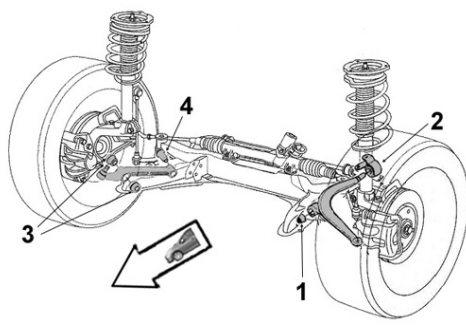
...BX...

2006030 OE 95496044	Rotule de direction G <i>Left tie rod end</i>	2006031 OE 95496045	Rotule de direction D <i>Right tie rod end</i>
	9 M14x1.5 TT /all models 09/82-		8 M14x1.5 TT /all models 09/82-
	Barre stabilisatrice <i>Stabilizer bar</i> <i>Barra estabilizadora</i> <i>Drażek stabilizatora</i> стабилизатор поперечной устойчивости		
2005200 OE 95597955	Biellette barre stab. <i>Stabilizer bar stub axle</i>		
	2 1.1 05/05/88- 1.4 /i 05/05/88- 1.6 /i 1.8 D 1.8 TD 1.9 Carbu. 1.9 D		
	Eléments SUSPENSION <i>Suspension parts</i> <i>Elementos suspensión</i> <i>Elementy zawieszenia</i> Элементы подвески		
2005256 OE 95637690	Articulation AV <i>Front bush</i>		2005257 OE 96070064
	1 Ø int.16 Ø ext.40 long. tube int.46 ext.32 1.1 05/05/88- 1.4 /i 05/05/88- 1.6 /i 1.8 D 1.8 TD 1.9 Carbu. 1.9 D		
		2 Ø int.16 Ø ext.40 coll.50 long. tube int.50 ext.41 ep. coll.6 1.1 05/05/88- 1.4 /i 05/05/88- 1.6 /i 1.8 D 1.8 TD 1.9 Carbu. 1.9 D	

... BX

Bras & Triangle de suspension

Control arm
Brazo y triángulo
Wahacz
Рычаг подвески

G/L  D/R



6403213
OE 364021

Rotule de susp. inf. G/D
L/R lower suspension ball joint



1
2 Ø 12 x 1.25
TT /all models 09/82-

1003577
OE -

Kit rép. triangle susp. G ou D
L or R track control arm bearing repair kit

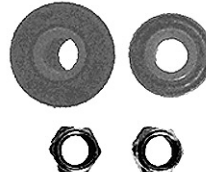

Avec visserie With screws and bolts
TT /all models 09/82-

Eléments TRAIN ARRIERE
Rear axle parts
Tren TRAS
Elementy zawieszenia tylnego
элементы задней оси.



2005261
OE 95632592

Support AVG traverse AR
Rear cross bar left front mounting

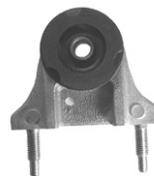

1.1 05/05/88-
1.4 /i 05/05/88-
1.6 /i
1.8 D
1.8 TD
1.9 Carbu.
1.9 D

2005262
OE 95632593

Support AVD traverse AR
Rear cross bar right front mounting



1.1 05/05/88-
1.4 /i 05/05/88-
1.6 /i
1.8 D
1.8 TD
1.9 Carbu.
1.9 D

2005150
OE -

Kit rép. train AR G ou D
L/R rear axle repair kit



TT /all models 09/82-

C-Crosser...

Eléments DIRECTION

Steering parts
Elementos Direcciones
Elementy układ kierowniczy
Элементы рулевой системы

G/L  D/R

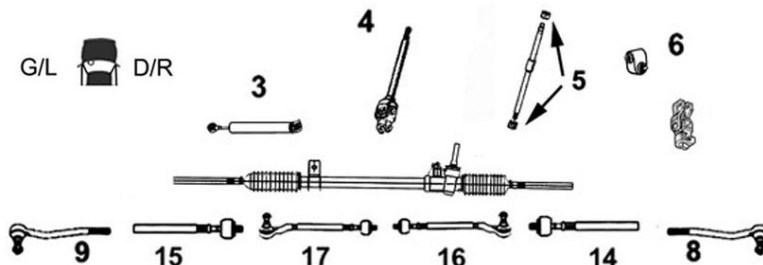

7770021
OE 3812F1

Axe de bielle G/D
L/R axial joint

NEW



14 Côté dir. M14x1.5 Côté rot. M14x1.5
15 long 342 mm
2.0i
2.2 HDi FAP
2.4i

7670007
Part/oe 381774

Rotule de direction G/D
L/R tie rod end



8
9 M14 x 1.5
2.0i
2.2 HDi FAP
2.4i

...C-Crosser...



Barre stabilisatrice
Stabilizer bar
Barra estabilizadora
Drażek stabilizatora
 стабилизатор поперечной устойчивости

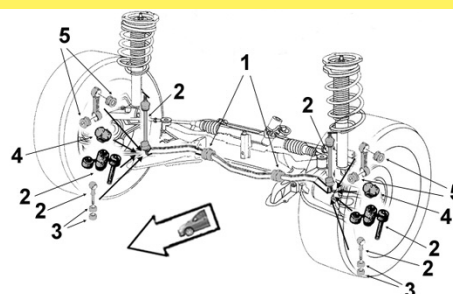

2300018

OE 508758

Biellette barre stab.

Stabilizer bar stub axle



2

2.2 HDi FAP

DW12MTED4

2.4i



Eléments SUSPENSION

Suspension parts

Elementos suspensión

Elementy zawieszenie

Элементы подвески

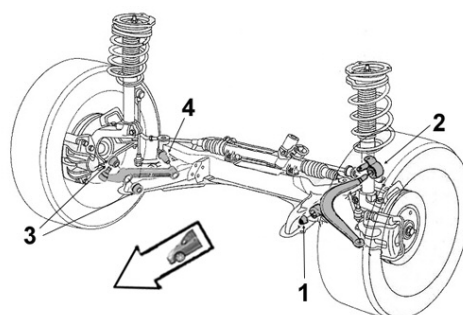

2250021

OE 3523CS

Articulation AR

Rear bush

NEW

2 Ø int.14.3 Ø ext.60 long. tube int.54 ext.27



2.0

2.2 HDi

2.4



Support d'amortisseur

Suspension mounting

Soporte amortiguador

Poduszka amortyzatora

Опора амортизатора

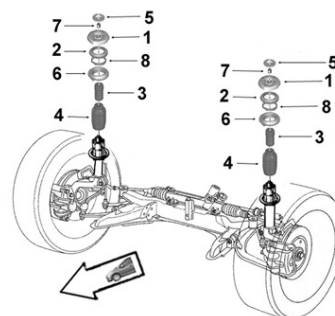

2650036

OE 5038F8

Support suspension

Suspension mounting



1 **Sans roulement** *Without bearing*

2.0i

2.2 HDi FAP

2.4i

... C-Crosser



Barre stabilisatrice
 Stabilizer bar
 Barra estabilizadora
 Drążek stabilizatora
 стабилизатор поперечной устойчивости

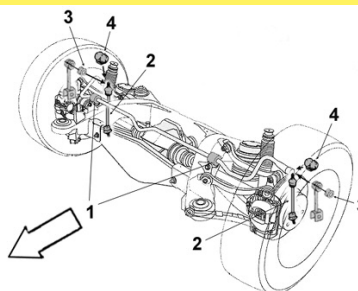

CITROËN



2300021
 OE 517848

Biellette barre stab. G
Left stabilizer bar stub axle



2

2.2 HDi FAP DW12MTED4
 2.4i

2300022
 OE 517849

Biellette barre stab. D
Right stabilizer bar stub axle



2

2.2 HDi FAP DW12MTED4
 2.4i

2300046
 OE 517258

Palier de barre milieu
Middle bar main bearing

NEW



1 Ø 19

2.2 HDi FAP
 2.4i

07/07-
 10/07-

C-Elysée ...

Eléments DIRECTION
Steering parts
Elementos Direcciones
Elementy układ kierowniczy
Элементы рулевой системы

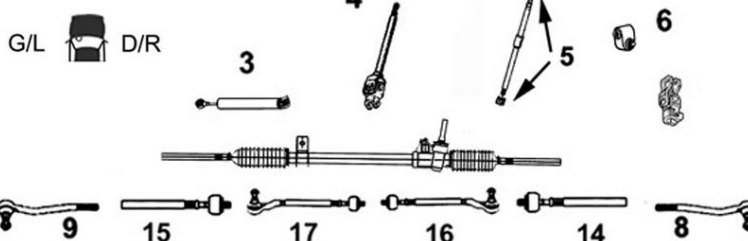

7770015
 OE 1608652180

Axe de bielle G/D
L/R axial joint

NEW



14 Côté dir. M16x1.5 Côté rot. M12x1.0 long 230 mm
15

1.2i
 1.6i
 1.6 HDi /FAP

EB2 M
 EC5
 DV6DTED/M

8173673
 OE 381767

Rotule de direction G
Left tie rod end



9

M16 x 1.5

1.2i EB2 M
 1.6i EC5
 1.6 HDi DV6DTED
 1.6 HDi DV6DTED M

8173683
 OE 381768

Rotule de direction D
Right tie rod end



8

M16 x 1.5

1.2i EB2 M
 1.6i EC5
 1.6 HDi DV6DTED
 1.6 HDi DV6DTED M

... C-Elysée ...



Barre stabilisatrice
 Stabilizer bar
 Barra estabilizadora
 Drażek stabilizatora
 стабилизатор поперечной устойчивости

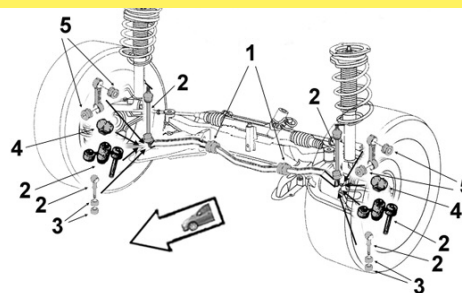

CITROEN



2300013
 OE 508769

Biellette de barre stab. G
Left stabilizer bar stub axle



2

1.2i
 1.6i
 1.6 HDi

2300012
 OE 508768

Biellette de barre stab. D
Right stabilizer bar stub axle



2

1.2i
 1.6i
 1.6 HDi



Support d'amortisseur
 Suspension mounting
 Soporte amortiguador
 Poduszka amortyzatora
 Опора амортизатора

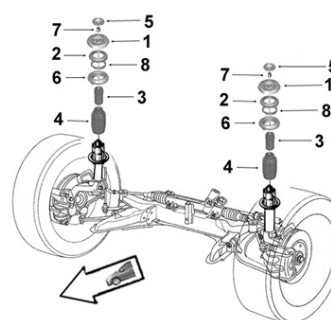

2650038
 OE 503375

Coupelle rebond.
Spring cup



5

1.2i EB2 M
 1.6i EC5
 1.6 HDi DV6DTED/M

2650021
 OE 5038G6

Support suspension
Suspension mounting



1

1.2i
 1.6i
 1.6 HDi

0355275
 OE 503563

Butée à billes G/D
L/R ball bearing



2

1.2i
 1.6i
 1.6 HDi

2650043
 OE 5033C3

Coupelle amortisseur G/D
L/R shock absorber cup

NEW



6

1.2i EB2 M
 1.6i EC5
 1.6 HDi DV6DTED/M

2650042
 OE 9677609080

Butée de suspension
Shock bush

NEW



3

H 75.5
 1.2i EB2 M -09/01/13
 1.6i EC5 -09/01/13
 1.6 HDi DV6DTED M -09/01/13
 1.6 HDi DV6DTED -09/01/13

2650044
 OE 525448

Protecteur amortisseur G/D
L/R shock absorber protector

NEW



4

1.2i EB2 M
 1.6i EC5
 1.6 HDi FAP DV6DTED M

...C-Elysée



CITROEN

Eléments TRAIN ARRIERE

Rear axle parts

Tren TRAS

Elementy zawieszenia tylnego

элементы задней оси.



2600009

Articulation essieu

OE 5131H4

Axle bush

Ø int. 12 Ø ext. 72 coll. 83 long. tube int. 83 ext. 60 ep. coll.5.5



1.2i
1.6i
1.6 HDi

C1...

Eléments DIRECTION

Steering parts

Elementos Direcciones

Elementy układ kierowniczy

Элементы рулевой системы

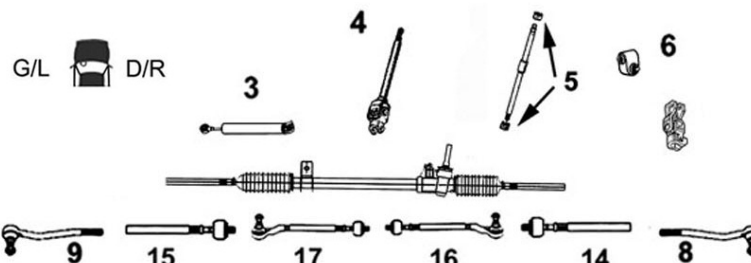

7770011

Axe de bielle G/D

Part/oe 400133

L/R axial joint

NEW



14 Côté dir. M14x1.5 Côté rot. M12x1.25 long 223 mm
15

1.0i 12v.
1.4 HDi 55hp 40kw

384F
DV4TD

06/05-
06/05-

8173633

Rotule de direction G

OE 381763

Left tie rod end

9 M12 x 1.25



1.0i 12v. 384F 06/05-
1.4 HDi 55hp 40kw DV4TD 06/05-

8173643

Rotule de direction D

OE 381764

Right tie rod end

8 M12 x 1.25



1.0i 12v. 384F 06/05-
1.4 HDi 55hp 40kw DV4TD 06/05-

...C1...



Barre stabilisatrice
 Stabilizer bar
 Barra estabilizadora
 Drażek stabilizatora
 стабилизатор поперечной устойчивости

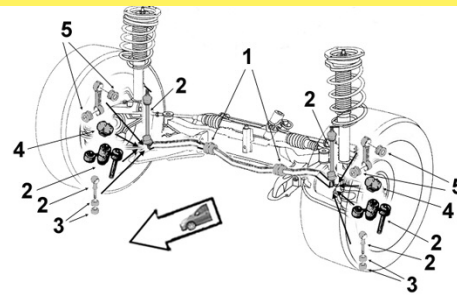

2300016
 OE 5094A8

Palier de barre milieu
 Middle bar main bearing



1

1.0i 12v. 384F
 1.4 HDi 55hp 40kw DV4TD

2300044
 OE 5094A7

Liaison élastique
 Elastic link



3

1.0i 12v. 384F
 1.4 HDi 55hp 40kw DV4TD



Eléments SUSPENSION
 Suspension parts
 Elementos suspensión
 Elementy zawieszenie
 Элементы подвески

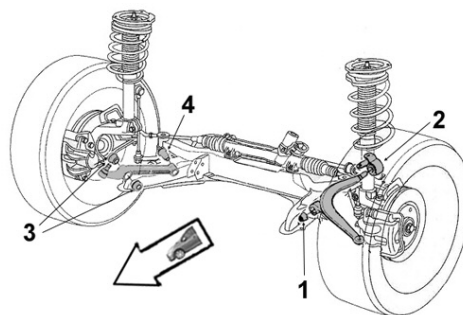

2250003
 Part/oe 3520Q2

Articulation AV
 Front bush



1

Ø int. 12 Ø ext. 33 coll. 34
 long. tube int. 53 ext. 31 ep. coll. 6X2

1.0i 12v. 384F
 1.4 HDi 55hp 40kw DV4TD

2250006
 Part/oe 3520Q2

Articulation AR
 Rear bush



2

Ø int. 19 Ø ext. 57 long. tube int. 62 ext. 26

1.0i 12v. 384F
 1.4 HDi 55hp 40kw DV4TD

Bras & Triangle de suspension

Control arm
 Brazo y triángulo
 Wahacz
 Рычаг подвески

G/L D/R

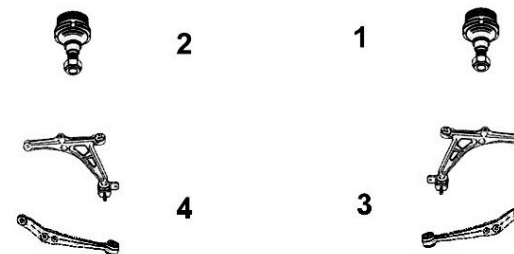

5203Q23
 OE 3520Q2

Triangle de susp. inf. G
 Lower left track control arm



4

Avec rotule With ball joint

1.0i 12v. 384F 06/05-
 1.4 HDi 55hp 40kw DV4TD 06/05-

5213L33
 OE 3521L3

Triangle de susp. inf. D
 Lower right track control arm



3

Avec rotule With ball joint

1.0i 12v. 384F 06/05-
 1.4 HDi 55hp 40kw DV4TD 06/05-

...C1...

Bras & Triangle de suspension

Control arm
Brazo y triángulo
Wahacz
Рычаг подвески

G/L  D/R

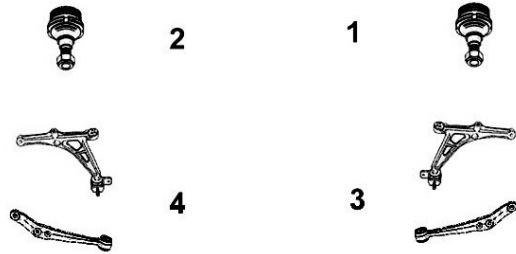

7570002

Rotule de susp. inf. G/D

Part/oe 3521L3

L/R lower suspension ball joint



1
2

1.0i 12v. 384F 06/05-
1.4 HDi 55hp 40kw DV4TD 06/05-



Support d'amortisseur

Suspension mounting
Soporte amortiguador
Poduszka amortyzatora
Опора амортизатора

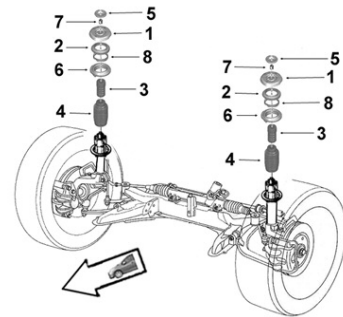

2650022

Support suspension G/D

OE 5038F6

L/R suspension mounting



1 **Sans roulement** Without bearing

1.0i 12v. 384F
1.4 HDi 55hp 40kw DV4TD

2650004

Butée à billes G/D

OE 503557

L/R ball bearing



2

1.0i 12v. 384F
1.4 HDi 55hp 40kw DV4TD

2650008

Butée de suspension G/D

OE 503396

L/R suspension bush



3

1.0i 12v. 384F 06/05-
1.4 HDi 55hp 40kw DV4TD 06/05-

Eléments TRAIN ARRIERE

Rear axle parts

Tren TRAS

Elementy zawieszenia tylnego

элементы задней оси.



2600003

Articulation essieu

OE 5131C9

Axle bush



Ø int. 12 Ø ext. 60 coll. 75
long. tube int.85 ext.53 ep. coll.6

1.0i 12v. 384F
1.4 HDi 55hp 40kw DV4TD

C2 ...

Eléments DIRECTION
Steering parts
Elementos Direcciones
Elementy układ kierowniczy
Элементы рулевой системы

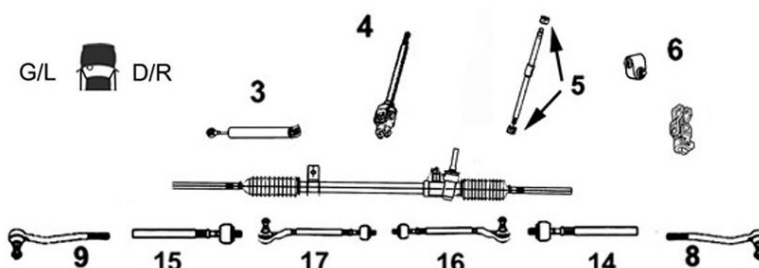

CITROËN



3008080

Axe de bielle G/D

Part/oe 3812E1

L/R axial joint

14 Côté dir. M12x1.0 Côté rot. M14x1.5 long 239 mm
15



1.1i
 1.4i
 1.4i 16v.
 1.4 HDi
 1.6i 16v.
 1.6i 16v. VTS
 1.6 HDi FAP

8173553

Rotule de direction G

OE 381755

Left tie rod end

9



1.1i
 1.4i
 1.4i 16v.
 1.4 HDi
 1.6i 16v.
 1.6i 16v. VTS
 1.6 HDi FAP

8173563

Rotule de direction D

OE 381756

Right tie rod end

8



1.1i
 1.4i
 1.4i 16v.
 1.4 HDi
 1.6i 16v.
 1.6i 16v. VTS
 1.6 HDi FAP



Barre stabilisatrice

Stabilizer bar

Barra estabilizadora

Drażek stabilizatora

стабилизатор поперечной устойчивости

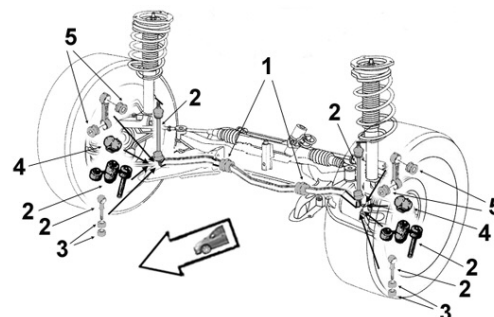

0875455

Biellette barre stab.

OE 508759

Stabilizer bar stub axle

2



1.1i
 1.4i
 1.4i 16v.
 1.4 HDi
 1.6i 16v.
 1.6i 16v. VTS
 1.6 HDi FAP

0875455QT réservée à l'export
(for export only)

2300001

Palier de barre milieu

OE 509497

Middle bar main bearing

1

Barre Ø 18
 Sauf République Chinoise



1.1i TU1JP -02/05/04
 1.4i TU3JP -02/05/04
 1.4 HDi DV4TD -02/05/04

2300002

Palier de barre milieu

OE 509496

Middle bar main bearing

1

Barre Ø 20
 Sauf République Chinoise



1.6i 16v. TU5JP4 -02/05/04

... C2 ...

SASIC

CITROEN



Barre stabilisatrice
 Stabilizer bar
 Barra estabilizadora
 Drażek stabilizatora
 стабилизатор поперечной устойчивости

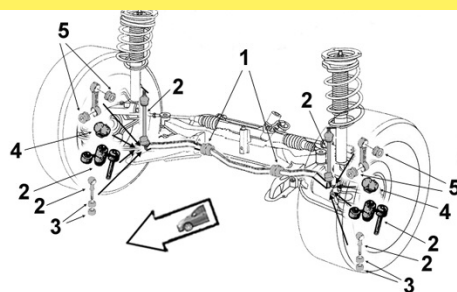

2300006
OE 509495

Palier de barre milieu
Middle bar main bearing



1 Barre Ø 21

République Chinoise

1.4i TU3AF
1.6i 16v. TU5JP4

2300026
OE 5094A6

Palier de barre milieu
Middle bar main bearing



1 Barre Ø 19/20

Sauf République Chinoise

1.6i 16v. TU5JP4 03/05/04-
1.6 HDi FAP DV6TED4



Eléments SUSPENSION
 Suspension parts
 Elementos suspensión
 Elementy zawieszenie
 Элементы подвески

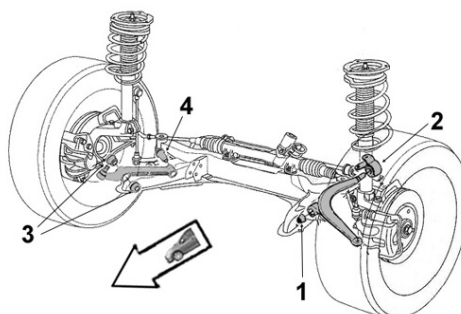

5233983
OE 352398

Articulation AV
Front bush



1 Ø int.18 Ø ext.56 coll.73 long. tube int.48 ext.20 ep. coll.10

Susp. normale

1.1i	TU1JP TU1A	-20/11/06
1.4i	TU3JP TU3A	-20/11/06
1.4i 16v.	ET3J4	-20/11/06
1.4 HDi	DV4TD	-12/11/06
1.4 HDi	DV4TD	-08/10/06
1.6i 16v.	TU5JP4	-17/10/06
1.6i 16v.	TU5JP4S	-17/10/06

Susp. renforcée AV AR Susp. AR renforcée

1.1i	TU1JP TU1A	-17/10/06
1.4i	TU3JP TU3A	-17/10/06
1.4i 16v.	ET3J4	-17/10/06
1.4 HDi	DV4TD	-17/10/06
1.6i 16v.	TU5JP4	-17/10/06
1.6i 16v.	TU5JP4S	-17/10/06

2250001
OE 3523AG

Articulation AV
Front bush



1 Ø int.15 Ø ext.55 long. tube int.50 ext.32

République Chinoise

1.4i TU3AF
1.6i 16v. TU5JP4

5233AA3
OE 3523AA

Articulation AR
Rear bush



2 Ø int.18 Ø ext.57 coll.73 long. tube int.48 ext.20 ep. coll.9 Susp. normale

1.1i	TU1A/JP	-20/11/06
1.4i /16v.	TU3A/JP ET3J4	-20/11/06
1.4 HDi	jantes 14/15 pouces	
	DV4TD	-12/11/06
1.6i 16v.	jantes 14/15 pouces	
	TU5JP4	-17/10/06

... C2 ...

5233993

Articulation AR

OE 352399

Rear bush



2 Ø int.18 Ø ext.55 coll.73 long.tube int.48 ext.20 ep.coll.9

1.1i	Susp. renforcée AV AR ou Susp. AR renforcée	TU1JP TU1A	-17/10/06
1.4i/16v.	Susp. renforcée AV AR ou Susp. AR renforcée	TU3JP TU3A ET3J4	-17/10/06
1.4 HDi	Susp. renforcée AV AR ou Susp. AR renforcée	DV4TD	-17/10/06
1.6i 16v.	Susp. normale jantes 16 pouces	TU5JP4	-17/10/06
1.6i 16v.	Susp. renforcée AV AR ou Susp. AR renforcée	TU5JP4	-17/10/06
1.6i 16v.	Susp. normale	TU5JP4S	-17/10/06

Bras & Triangle de suspension

Control arm
Brazo y triángulo
Wahacz
Рычаг подвески

G/L  D/R

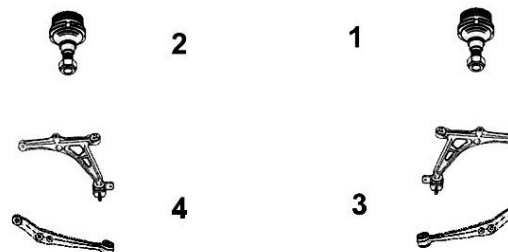

5203T33

Triangle de susp. G Left track control arm

OE 3520L9 3520P9 3520R2 3520R3 3520R4 3520V1



4 Sans rotule Without ball joint

Susp. normale

1.1i	TU1JP TU1A	-20/11/06
1.4i	TU3JP TU3A	-20/11/06
1.4i 16v.	ET3J4	-20/11/06
1.4 HDi	DV4TD	-09/10/05
1.4 HDi jantes 14/15 pouces	DV4TD	10/10/05-12/11/06
1.4 HDi jantes 16 pouces	DV4TD	05/06/06-
1.6i 16v.	TU5JP4	-09/10/05
1.6i 16v. jantes 14/15 pouces	TU5JP4	10/10/05-17/10/06
1.6i 16v. jantes 16 pouces	TU5JP4	10/10/05-
1.6i 16v. VTS	TU5JP4S	
1.6 HDi FAP	DV6TED4	

Susp. renforcée AV AR /AR renforcée

1.1i	TU1JP TU1A	
1.4i	TU3JP TU3A	
1.4i 16v.	ET3J4	
1.4 HDi	DV4TD	
1.6i 16v.	TU5JP4	
1.6i 16v. VTS	TU5JP4S	
1.6 HDi FAP	DV6TED4	10/10/05-

5213Q43

Triangle de susp. D Right track control arm

OE 3521J1 3521J2 3521K8 3521N4 3521N5



3 Sans rotule Without ball joint

Susp. normale

1.1i	TU1JP TU1A	-20/11/06
1.4i	TU3JP TU3A	-20/11/06
1.4i 16v.	ET3J4	-20/11/06
1.4 HDi	DV4TD	-09/10/05
1.4 HDi jantes 14/15 pouces	DV4TD	10/10/05-12/11/06
1.4 HDi jantes 16 pouces	DV4TD	05/06/06-
1.6i 16v.	TU5JP4	-09/10/05
1.6i 16v. jantes 14/15 pouces	TU5JP4	10/10/05-17/10/06
1.6i 16v. jantes 16 pouces	TU5JP4	10/10/05-
1.6i 16v. VTS	TU5JP4S	
1.6 HDi FAP	DV6TED4	

Susp. renforcée AV AR /AR renforcée

1.1i	TU1JP TU1A	
1.4i	TU3JP TU3A	
1.4i 16v.	ET3J4	
1.4 HDi	DV4TD	
1.6i 16v.	TU5JP4	
1.6i 16v. VTS	TU5JP4S	
1.6 HDi FAP	DV6TED4	10/10/05-

... C2 ...

Bras & Triangle de suspension

Control arm
Brazo y triángulo
Wahacz
Рычаг подвески

G/L  D/R

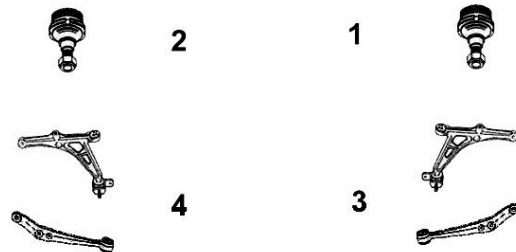

6403623
OE 364062

Rotule de susp. inf. G/D
L/R lower suspension ball joint



1	2	1.1i	Susp. normale /renforcée AV AR /AR renforcée	TU1JP TU1A	
		1.4i	Susp. normale	TU3JP	
		1.4i	Susp. renforcée AV AR /AR renforcée	TU3JP	10/10/05-
		1.4i	Susp. normale /renforcée AV AR /AR renforcée	TU3A	
		1.4i 16v.	Susp. normale /renforcée AV AR /AR renforcée	ET3J4	
		1.4 HDi	Susp. normale	DV4TD	-09/10/05
		1.4 HDi	Susp. normale jantes 14/15 pouces	DV4TD	10/10/05-
		1.4 HDi	Susp. normale jantes 16 pouces	DV4TD	05/06/06-
		1.4 HDi	Susp. renforcée AV AR /AR renforcée	DV4TD	
		1.6i 16v.	Susp. normale	TU5JP4	-09/10/05
		1.6i 16v.	Susp. normale jantes 14/15 pouces	TU5JP4	10/10/05-
		1.6i 16v.	Susp. normale jantes 16 pouces	TU5JP4	10/10/05-
		1.6i 16v.	Susp. renforcée AV AR /AR renforcée	TU5JP4	
		1.6i 16v. VTS	Susp. renforcée AV AR /AR renforcée	TU5JP4S	
		1.6 HDi FAP	Susp. renforcée AV AR /AR renforcée	DV6TED4	10/10/05-

6403663
OE 364066

Rotule de susp. inf. G/D
L/R lower suspension ball joint



1	2	Susp. normale	
		1.6i 16v. VTS	TU5JP4S
		1.6 HDi FAP	DV6TED4



Support d'amortisseur
Suspension mounting
Soporte amortiguador
Poduszka amortyzatora
Опора амортизатора

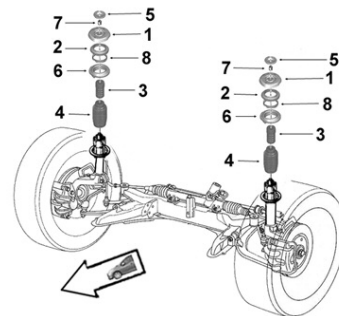

2650038
OE 503375

Coupelle rebond.
Spring cup



5	TT /all models
----------	----------------

2650005
OE 503891

Support suspension G/D
L/R suspension mounting











1	Sans roulement <i>Without bearing</i>
1.1i	TU1JP -29/08/04
1.4i	TU3JP -29/08/04
1.4 HDi	DV4TD -29/08/04
1.6i 16v.	TU5JP4 -29/08/04
1.6i 16v.	TU5JP4S -29/08/04

... C2 ...

CITROEN

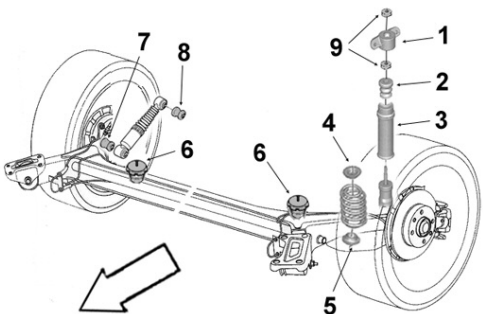

2650015 OE 5038F5	Support suspension <i>Suspension mounting</i>	0355275 OE 503563	Butée à billes G/D <i>L/R ball bearing</i>
	1 1.1i TU1A 1.1i TU1JP 30/08/04- 1.4i TU3A 1.4i TU3JP 30/08/04- 1.4i 16v. ET3J4 1.4 HDi DV4TD 30/08/04- 1.6i 16v. TU5JP4/S 30/08/04- 1.6 HDi FAP DV6TED4		2 1.1i TU1JP TU1A 1.4i TU3JP TU3A 1.4i 16v. ET3J4 1.4 HDi DV4TD 1.6i 16v. TU5JP4 1.6i 16v. VTS TU5JP4S 1.6 HDi FAP DV6TED4
2650011 OE 503174	Coupelle amortisseur G/D <i>L/R shock absorber cup</i>	0335825 OE 503382	Butée de suspension G/D <i>L/R suspension bush</i>
	6 1.1i TU1JP TU1A 1.4i TU3A TU3JP 1.4i 16v. ET3J4 1.4 HDi DV4TD 1.6i 16v. TU5JP4 1.6i 16v. VTS TU5JP4S 1.6 HDi FAP DV6TED4		3 1.1i TU1JP 1.1i TU1A 1.4i TU3JP 1.4i TU3A 1.4i 16v. ET3J4 1.4 HDi DV4TD
2650007 OE 503360	Butée de suspension G/D <i>L/R suspension bush</i>	0335845 OE 503384	Butée de suspension G/D <i>L/R suspension bush</i>
	3 H80 1.4i Chine TU3AF 1.6i 16v. Chine TU5JP4		3 1.6i 16v. Sauf Chine TU5JP4
	Support d'amortisseur <i>Suspension mounting</i> <i>Soporte amortiguador</i> <i>Poduszka amortyzatora</i> <i>Опора амортизатора</i>		
1665685 OE 516695	Butée de talonnage G/D <i>L/R bushing</i>		
	6 H85 Susp. AR renforcée 1.1i TU1JP TU1A -26/02/06 1.4i TU3JP TU3A -26/02/06 1.4i 16v. ET3J4 -26/02/06 1.4 HDi DV4TD -26/02/06 1.6 HDi FAP DV6TED4 -26/02/06		
1665675 OE 516694	Butée de talonnage G/D <i>L/R bushing</i>		
	6 H78 1.1i Susp. normale ou Susp. renforcée AV AR TU1JP TU1A 1.1i Susp. AR renforcée TU1JP TU1A 27/02/06- 1.4i Susp. normale ou Susp. renforcée AV AR TU3JP TU3A 1.4i Susp. AR renforcée TU3JP TU3A 27/02/06- 1.4i 16v. Susp. normale /renforcée AV AR ET3J4 1.4i 16v. Susp. AR renforcée ET3J4 27/02/06- 1.4 HDi DV4TD 1.4 HDi Susp. normale ou Susp. renforcée AV AR DV4TD 27/02/06- 1.6i 16v. TU5JP4 09/03-05/08 1.6 HDi FAP Susp. normale ou Susp. renforcée AV AR DV6TED4 1.6 HDi FAP Susp. AR renforcée DV6TED4 27/02/06-		

... C2



CITROEN



Support d'amortisseur
Suspension mounting
Soporte amortiguador
Poduszka amortyzatora
Опора амортизатора

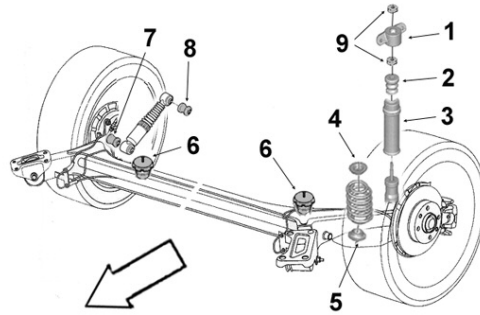

1665745

Butée de talonnage G/D

OE 516696

L/R bushing



6 H85

Disques AR

1.6i 16v.
 1.6i 16v. VTS
 1.6 HDi FAP

TU5JP4
 TU5JP4S
 DV6TED4

05/07/04-

Monte pneu 16 pouces

Eléments TRAIN ARRIERE

Rear axle parts

Tren TRAS

Elementy zawieszenia tylnego

элементы задней оси.



1315C15

Articulation essieu

OE 5131C1

Axle bush



Ø int.13 Ø ext.61 coll.70 long. tube int.68 ext.46 ep. Coll.7

Susp. normale

1.1i
 1.4i
 1.4i 16v.
 1.4 HDi
 1.6i 16v.
 1.6 HDi FAP

TU1JP TU1A
 TU3JP TU3A
 ET3J4
 DV4TD
 TU5JP4/S
 DV6TED4

1315C25

Articulation essieu

OE 5131C2

Axle bush



Ø int.13 Ø ext.61 coll.70 long. tube int.68 ext.46 ep. Coll.7

1.1i	Susp. AR renforcée ou renforcée AV AR /normale réhaussée	TU1JP TU1A
1.4i	Susp. AR renforcée ou renforcée AV AR /normale réhaussée	TU3JP TU3A
1.4i 16v.	Susp. renforcée AV AR /AR renforcée /normale réhaussée	ET3J4
1.4 HDi	Susp. AR renforcée ou renforcée AV AR /normale réhaussée	DV4TD
1.6i 16v.	Susp. AR renforcée ou renforcée AV AR /normale réhaussée	TU5JP4 TU5JP4S
1.6 HDi FAP	Susp. AR /AV AR renforcée /normale réhaussée	DV6TED4

C3 ...

Eléments DIRECTION

Steering parts

Elementos Direcciones

Elementy układ kierowniczy

Элементы рулевой системы

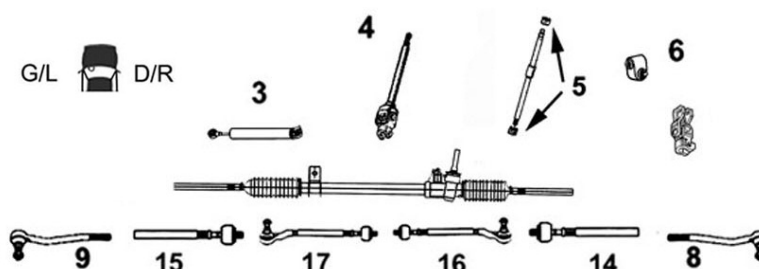

CITROËN

SASIC

3008080

Axe de bielle G/D

Part/oe 3812E1

L/R axial joint

14 Côté dir. M12x1.0 Côté rot. M14x1.5 long 239 mm

1.1i		TU1JP	-10/05
1.1i	Course mécanisme dir. 144	TU1A	10/05-10/09
1.4i		TU3JP	-10/05
1.4i	Course mécanisme dir. 128 144	TU3JP TU3A	10/05-10/09
1.4i 16v.		ET3J4	-10/05
1.4i 16v.	Course mécanisme dir. 128 144	ET3J4	10/05-10/09
1.4 HDi		DV4TD	-10/05
1.4 HDi	Course mécanisme dir. 128 144	DV4TD	10/05-10/09
1.4 HDi		DV4TED4	-10/05
1.6i 16v.		TU5JP4	-10/05
1.6i 16v.	Course mécanisme dir. 128 144	TU5JP4	10/05-10/09
1.6 HDi		DV6ATED4	-10/05
1.6 HDi	Course mécanisme dir. 144	DV6ATED4	10/05-10/09
1.6 HDi FAP	Course mécanisme dir. 144	DV6TED4	10/05-10/09

7770018

Axe de bielle G/D

OE 3812E6

L/R axial joint

14 Côté dir. M12x1.0
15 Côté rot. M16x1.5 long 236 mm
Course mécanisme dir. 128

1.6i 16v. BVA	TU5JP4	10/05-10/09
1.6 HDi	DV6ATED4	10/05-10/09
1.6 HDi FAP	DV6TED4	10/05-10/09

7770001

Axe de bielle G/D

OE 3812F6

L/R axial joint

14 Côté dir. M12x1.0
15 Côté rot. M14x1.5 long 246 mm

1.0i	EB0	11/09-
1.1i	TU1AE5	11/09-
1.2 VTi	EB2	11/09-
1.4i /VTi	TU3A/E5 EP3C	11/09-
1.4 HDi	DV4C DV4TD	11/09-
1.6i 16v.	EP6C	11/09-
1.6 HDi	DV6ATED4 DV6C	11/09-
1.6 HDi	DV6DTED	11/09-
1.6 HDi	DV6D/ETED M	11/09-

8173553

Rotule de direction G

OE 381755

Left tie rod end

1.1i		TU1JP	-10/05
1.1i	Course mécanisme dir. 144	TU1A	10/05-10/09
1.4i /16v.		TU3JP ET3J4	-10/05
1.4i /16v.	Course mécanisme dir. 128 144	TU3JP TU3A ET3J4	10/05-10/09
1.4 HDi		DV4TD DV4TED4	-10/05
1.4 HDi	Course mécanisme dir. 128 144	DV4TD	10/05-10/09
1.6i 16v.		TU5JP4	-10/05
1.6i 16v.	Course mécanisme dir. 128	TU5JP4 BVM	10/05-10/09
1.6i 16v.	Course mécanisme dir. 144	TU5JP4	10/05-10/09
1.6 HDi		DV6ATED4	-10/05
1.6 HDi /FAP	Course mécanisme dir. 144	DV6ATED4 DV6TED4	10/05-10/09

8173563

Rotule de direction D

OE 381756

Right tie rod end

1.1i		TU1JP	-10/05
1.1i	Course mécanisme dir. 144	TU1A	10/05-10/09
1.4i /16v.		TU3JP ET3J4	-10/05
1.4i /16v.	Course mécanisme dir. 128 144	TU3JP TU3A ET3J4	10/05-10/09
1.4 HDi		DV4TD DV4TED4	-10/05
1.4 HDi	Course mécanisme dir. 128 144	DV4TD	10/05-10/09
1.6i 16v.		TU5JP4	-10/05
1.6i 16v.	Course mécanisme dir. 128	TU5JP4 BVM	10/05-10/09
1.6i 16v.	Course mécanisme dir. 144	TU5JP4	10/05-10/09
1.6 HDi		DV6ATED4	-10/05
1.6 HDi /FAP	Course mécanisme dir. 144	DV6ATED4 DV6TED4	10/05-10/09

... C3 ...

Eléments DIRECTION

Steering parts

Elementos Direcciones

Elementy układ kierowniczy

Элементы рулевой системы

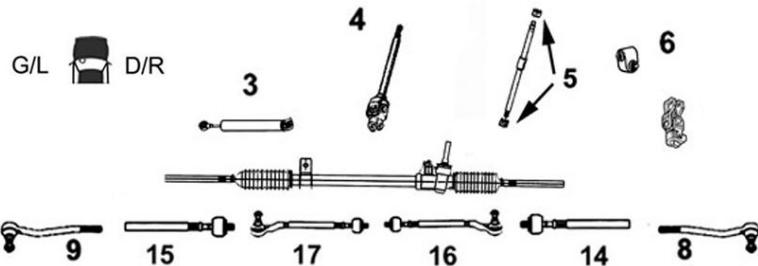

7670003

Rotule de direction G

OE 381792

Left tie rod end



9 M14 x 1.5

1.0i	EB0	11/09-
1.1i	TU1AE5	11/09-
1.2 VTi	EB2	11/09-
1.4i	TU3A TU3AE5	11/09-
1.4 VTi	EP3C	11/09-
1.4 HDi	DV4C DV4TD	11/09-
1.6i 16v.	EP6C	11/09-
1.6 HDi	DV6ATED4	11/09-
1.6 HDi	DV6C	11/09-
1.6 HDi	DV6DTED/M	11/09-
1.6 HDi	DV6ETED M	11/09-

7670004

Rotule de direction D

OE 381791

Right tie rod end



8 M14 x 1.5

1.0i	EB0	11/09-
1.1i	TU1AE5	11/09-
1.2 VTi	EB2	11/09-
1.4i	TU3A TU3AE5	11/09-
1.4 VTi	EP3C	11/09-
1.4 HDi	DV4C DV4TD	11/09-
1.6i 16v.	EP6C	11/09-
1.6 HDi	DV6ATED4	11/09-
1.6 HDi	DV6C	11/09-
1.6 HDi	DV6DTED/M	11/09-
1.6 HDi	DV6ETED M	11/09-



Barre stabilisatrice

Stabilizer bar

Barra estabilizadora

Drażek stabilizatora

стабилизатор поперечной устойчивости

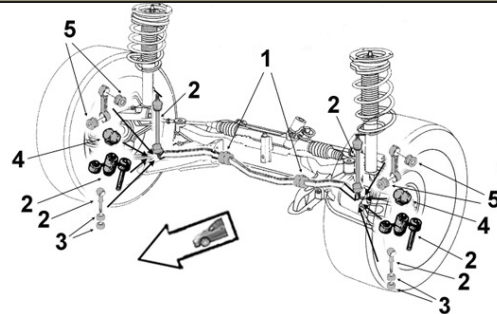

0875455

Biellette barre stab.

OE 508759

Stabilizer bar stub axle



2

1.1i	TU1JP	-10/05
1.1i	TU1A	10/05-10/09
1.4i	TU3A	10/05-10/09
1.4i	TU3JP	-10/09
1.4i 16v.	ET3J4	-10/09
1.4 HDi	DV4TED4	-10/05
1.4 HDi	DV4TD	-10/09
1.6i 16v.	TU5JP4	-10/09
1.6 HDi	DV6ATED4	-10/09
1.6 HDi FAP	DV6TED4	10/05-10/09

Pays grand froid

1.1i	TU1AE5	10/10-
1.4i	TU3AE5	10/10-
1.4i VTi	EP3C	10/10-
1.4 HDi	DV4C/TD	10/10-
1.6i 16v.	EP6C	10/10-
1.6 HDi	DV6	10/10-

**0875455QT réservée à l'export
(for export only)**

... C3 ...

2300003

Palier de barre milieu

OE 509491

Middle bar main bearing

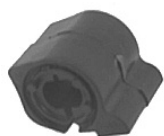

1 Barre Ø 19

1.1i	TU1JP	-02/05/04
1.4i	TU3JP ET3J4	-02/05/04
1.4 HDi	DV4TD	-02/05/04
1.4 HDi	DV4TED4	-02/05/04
1.6i 16v.	TU5JP4	-02/05/04

2300026

Palier de barre milieu

OE 5094A6

Middle bar main bearing



1 Barre Ø 19/20

1.1i	TU1JP	03/05/04-10/05
1.1i	TU1A	10/05-10/09
1.4i	TU3JP ET3J4	03/05/04-10/09
1.4i /16v.	TU3A ET3J4	10/05-10/09
1.4 HDi	DV4TD	03/05/04-10/09
1.4 HDi	DV4TED4	03/05/04-10/05
1.6i 16v.	TU5JP4	03/05/04-10/05
1.6i 16v.	TU5JP4	10/05-10/09
1.6 HDi	DV6ATED4	10/05-10/09
1.6 HDi FAP	DV6TED4 BVM MA/Pilotée	10/05-10/09



Eléments SUSPENSION

Suspension parts
Elementos suspensión
Elementy zawieszenia
Элементы подвески

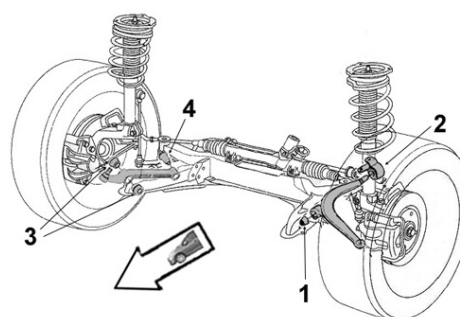

5233983

Articulation AV

OE 352398

Front bush



1 Ø int.18 Ø ext.56 coll.73 long. tube int.48 ext.20 ep. coll.10

1.1i	Susp. normale	Susp. AR renforcée	TU1JP	-10/05
1.1i	Susp. renforcée	AV AR	TU1JP	05/11/01-10/05
1.1i			TU1A	10/05-24/09/06
1.4i	Susp. normale	Susp. AR renforcée	TU3JP	-10/05
1.4i	Susp. renforcée	AV AR	TU3JP	05/11/01-10/05
1.4i			TU3JP TU3A	10/05-24/09/06
1.4i 16v.	Susp. normale	Susp. AR renforcée	ET3J4	-10/05
1.4i 16v.			ET3J4	10/05-24/09/06
1.4 HDi	Susp. normale	/AR renforcée	DV4TD/TED4	-10/05
1.4 HDi	Susp. renforcée	AV AR	DV4TD/TED4	05/11/01-10/05
1.4 HDi			DV4TD	10/05-24/09/06
1.6i 16v.	Susp. normale	susp. AR renforcée	TU5JP4	-10/05
1.6i 16v.			TU5JP4	10/05-24/09/06
1.6 HDi	Susp. normale	Susp. AR renforcée	DV6ATED4	-10/05
1.6 HDi	Susp. renforcée	AV AR	DV6ATED4	05/11/01-10/05
1.6 HDi			DV6ATED4	10/05-24/09/06
1.6 HDi FAP			DV6TED4	10/05-24/09/06

5233AA3

Articulation AR

OE 3523AA

Rear bush



2 Ø int.18 Ø ext.57 coll.73 long. tube int.48 ext.20 ep. coll.9

1.1i	Susp. normale		TU1JP	-28/03/04
1.4i	Susp. normale		TU3JP	-28/03/04
1.4i 16v.	Susp. normale		ET3J4	-28/03/04
1.4 HDi	Susp. normale		DV4TD	-28/03/04
1.4 HDi	Susp. renforcée		DV4TD	-10/05
1.4 HDi	Susp. normale		DV4TED4	-28/03/04
1.4 HDi	Susp. renforcée		DV4TED4	-10/05
1.6i 16v.	Susp. normale		TU5JP4	-28/03/04
1.6 HDi	Susp. renforcée		DV6ATED4	-10/05

... C3 ...



Eléments SUSPENSION

Suspension parts

Elementos suspensión

Elementy zawieszenie

Элементы подвески

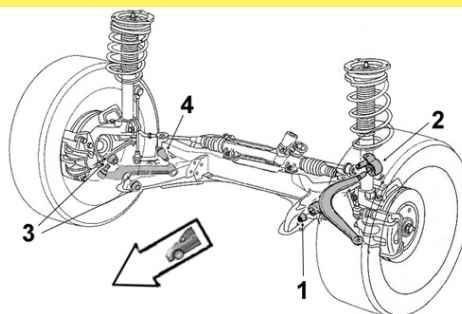

CITROËN

SASIC

2250017

Articulation AR

OE 3523AT

Rear bush

2 Ø int.18 Ø ext.56 coll.73 long. tube int.48 ext.21 ep. coll.9



1.1i	Susp. normale		TU1JP	29/03/04-10/05
1.1i	Susp. normale		TU1A	10/05-24/09/06
1.4i	Susp. normale		TU3JP	29/03/04-24/09/06
1.4i	Susp. normale		TU3A	10/05-24/09/06
1.4i 16v.	Susp. normale		ET3J4	29/03/04-10/05
1.4i 16v.	Susp. normale	Sauf monte pneus 16 pouces	ET3J4	10/05-24/09/06
1.4 HDi	Susp. normale		DV4TD	29/03/04-24/09/06
1.4 HDi	Susp. normale		DV4TED4	29/03/04-10/05
1.6i 16v.	Susp. normale		TU5JP4	29/03/04-10/05
1.6i 16v.	Susp. normale		TU5JP4 BVM MA/pilotée	10/05-24/09/06
1.6 HDi	Susp. normale	Sauf monte pneus 16 pouces	DV6ATED4	10/05-24/09/06

5233993

Articulation AR

OE 352399

Rear bush

2 Ø int.18 Ø ext.55 coll.73 long. tube int.48 ext.20 ep. coll.9



1.1i	Susp. renforcée AV AR		TU1JP	05/11/01-10/05
1.1i	Susp. renforcée AR		TU1JP	-10/05
1.4i	Susp. renforcée AV AR		TU3JP ET3J4	05/11/01-10/05
1.4i	Susp. renforcée AR		TU3JP	-10/05
1.4i 16v.	Susp. normale	Monte pneu 16 pouces	ET3J4	10/05-24/09/06
1.4i 16v.	susp. renforcée AV AR ou réhaussée		ET3J4	10/05-24/09/06
1.6i 16v.	Susp. renforcée AV AR		TU5JP4	05/11/01-10/05
1.6i 16v.	Susp. renforcée AR		TU5JP4	-10/05
1.6i 16v.	Susp. normale		TU5JP4	BVA AL4
1.6i 16v.	Susp. normale	Monte pneu 16 pouces	TU5JP4	BVM
1.6i 16v.	Susp. renforcée AV AR /AR /réhaussée		TU5JP4	10/05-24/09/06
1.6 HDi	Susp. normale	Monte pneu 16 pouces	DV6ATED4	10/05-24/09/06
1.6 HDi	Susp. renforcée AV AR /AR /réhaussée		DV6ATED4 DV6TED4	10/05-24/09/06
1.6 HDi FAP	Susp. normale	Monte pneu 16 pouces	DV6TED4	10/05-24/09/06

... C3 ...

Bras & Triangle de suspension

Control arm
Brazo y triángulo
Wahacz
Рычаг подвески

G/L  D/R

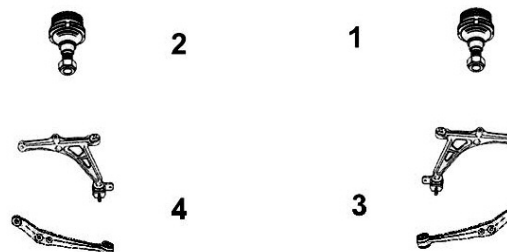

CITROEN



7470026

Triangle de susp. G

OE 3520W7

Left track control arm



NEW

4 Avec rotule With ball joint Ø 18

TT /all models	Susp. normale	11/09-29/01/12
TT /all models	Susp. normale Liaison au sol Loi 1/2/2P	30/01/12-
TT /all models	Susp. renforcée AR Liaison au sol Loi 2	30/01/12-30/06/13
TT /all models	Susp. réhaussée Liaison au sol Loi 2 Pivot roue Ø72 EB	30/01/12-30/06/13

7470025

Triangle de susp. D

OE 3521S9

Right track control arm



NEW

3 Avec rotule With ball joint Ø 18

TT /all models	Susp. normale	11/09-29/01/12
TT /all models	Susp. normale Liaison au sol Loi 1/2/2P	30/01/12-
TT /all models	Susp. renforcée AR Liaison au sol Loi 2	30/01/12-30/06/13
TT /all models	Susp. réhaussée Liaison au sol Loi 2 Pivot roue Ø72 EB	30/01/12-30/06/13

5203L43

Bras de suspension G

OE 3520L3 3520R1

Left track control arm



4 Avec rotule With ball joint

1.1i	Susp. normale	TU1JP	-28/03/04
1.1i	Susp. renforcée	TU1JP	-10/05
1.1i	Susp. normale réhaussée / renforcée AV AR / AR renforcée	TU1A	10/05-24/09/06
1.4i	Susp. normale	TU3JP	-28/03/04
1.4i	Susp. renforcée	TU3JP	-10/05
1.4i	Susp. normale réhaussée / renforcée AV AR / AR renforcée	TU3JP TU3A	10/05-24/09/06
1.4i 16v.	Susp. normale	ET3J4	-28/03/04
1.4i 16v.	Susp. normale réhaussée / renforcée AV AR / AR renforcée	ET3J4	10/05-24/09/06
1.4 HDi	Susp. normale	DV4TD	-28/03/04
1.4 HDi	Susp. renforcée	DV4TD	-10/05
1.4 HDi	Susp. normale réhaussée / renforcée AV AR / AR renforcée	DV4TD	10/05-24/09/06
1.4 HDi		DV4TED4	-28/03/04
1.4 HDi	Susp. renforcée	DV4TED4	-10/05
1.6i 16v.	Susp. normale	TU5JP4	-28/03/04
1.6i 16v.	Susp. renforcée	TU5JP4	-10/05
1.6i 16v.	Susp. normale réhaussée / renforcée AV AR / AR renforcée	TU5JP4	10/05-24/09/06
1.6 HDi	Susp. normale	DV6ATED4	-28/03/04
1.6 HDi	Susp. renforcée	DV6ATED4	-10/05
1.6 HDi	Susp. normale réhaussée / renforcée AV AR / AR renforcée	DV6ATED4	10/05-24/09/06
1.6 HDi FAP	Susp. normale réhaussée / renforcée AV AR / AR renforcée	DV6TED4	10/05-24/09/06

5213H63

Bras de suspension D

OE 3521H5 3521N2

Right track control arm



3 Avec rotule With ball joint

1.1i	Susp. normale	TU1JP	-28/03/04
1.1i	Susp. renforcée	TU1JP	-10/05
1.1i	Susp. normale réhaussée / renforcée AV AR / AR renforcée	TU1A	10/05-24/09/06
1.4i	Susp. normale	TU3JP	-28/03/04
1.4i	Susp. renforcée	TU3JP	-10/05
1.4i	Susp. normale réhaussée / renforcée AV AR / AR renforcée	TU3JP TU3A	10/05-24/09/06
1.4i 16v.	Susp. normale	ET3J4	-28/03/04
1.4i 16v.	Susp. normale réhaussée / renforcée AV AR / AR renforcée	ET3J4	10/05-24/09/06
1.4 HDi	Susp. normale	DV4TD	-28/03/04
1.4 HDi	Susp. renforcée	DV4TD	-10/05
1.4 HDi	Susp. normale réhaussée / renforcée AV AR / AR renforcée	DV4TD	10/05-24/09/06
1.4 HDi		DV4TED4	-28/03/04
1.4 HDi	Susp. renforcée	DV4TED4	-10/05
1.6i 16v.	Susp. normale	TU5JP4	-28/03/04
1.6i 16v.	Susp. renforcée	TU5JP4	-10/05
1.6i 16v.	Susp. normale réhaussée / renforcée AV AR / AR renforcée	TU5JP4	10/05-24/09/06
1.6 HDi	Susp. normale	DV6ATED4	-28/03/04
1.6 HDi	Susp. renforcée	DV6ATED4	-10/05
1.6 HDi	Susp. normale réhaussée / renforcée AV AR / AR renforcée	DV6ATED4	10/05-24/09/06
1.6 HDi FAP	Susp. normale réhaussée / renforcée AV AR / AR renforcée	DV6TED4	10/05-24/09/06

... C3 ...

Bras & Triangle de suspension

Control arm
Brazo y triángulo
Wahacz
Рычаг подвески

G/L  D/R

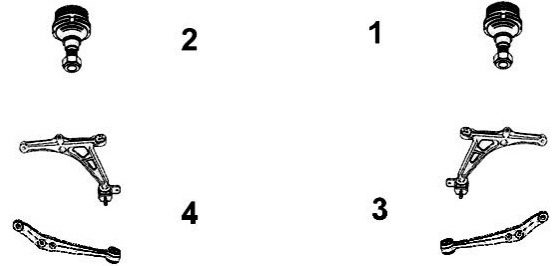

5203T33 Triangle de susp. G Left track control arm
OE 3520L9 3520N1 3520R3 3520Q0 3520R4 3520V1



4	Sans rotule Without ball joint		
1.1i	Susp. normale	TU1JP	29/03/04-08/05
1.1i	Susp. normale	TU1A	10/10/05-10/09
1.1i	Susp. normale réhaussée/renforcée AV AR / AR renforcée	TU1A	25/09/06-10/09
1.4i	Susp. normale	TU3JP	29/03/04-08/05
1.4i	Susp. normale	TU3JP	10/10/05-10/09
1.4i	Susp. normale réhaussée/renforcée AV AR / AR renforcée	TU3JP	25/09/06-10/09
1.4i	Susp. normale	TU3A	10/10/05-10/09
1.4i	Susp. normale réhaussée/renforcée AV AR / AR renforcée	TU3A	25/09/06-10/09
1.4i 16v.	Susp. normale	ET3J4	29/03/04-08/05
1.4i 16v.	Susp. normale	ET3J4	10/05-10/09
1.4i 16v.	Susp. normale réhaussée / renforcée AV AR / AR renforcée	ET3J4	25/09/06-10/09
1.4 HDi	Susp. normale	DV4TD	29/03/04-08/05
1.4 HDi	Susp. normale	DV4TD	10/10/05-10/09
1.4 HDi	Susp. normale réhaussée / renforcée AV AR / AR renforcée	DV4TD	25/09/06-10/09
1.4 HDi		DV4TED4	29/03/04-08/05
1.6i 16v.	Susp. normale	TU5JP4	29/03/04-08/05
1.6i 16v.	Susp. normale	TU5JP4	10/05-09/10/05
1.6i 16v.	Susp. normale BVA AL4	TU5JP4	10/05-10/09
1.6i 16v.	Susp. normale BVM MA Pilotée	TU5JP4	10/10/05-24/09/06
1.6i 16v.	Susp. normale BVM MA	TU5JP4	25/09/06-10/09
1.6i 16v.	Susp. normale	TU5JP4	25/09/06-10/09
1.6i 16v.	Susp. normale réhaussée/renforcée AV AR / AR renforcée	TU5JP4	25/09/06-10/09
1.6 HDi	Susp. normale	DV6ATED4	29/03/04-08/05
1.6 HDi	Susp. normale	DV6ATED4	10/10/05-10/09
1.6 HDi	Susp. normale réhaussée/renforcée AV AR / AR renforcée	DV6ATED4	25/09/06-10/09
1.6 HDi FAP	Susp. normale	DV6TED4	10/05-10/09
1.6 HDi FAP	Susp. normale réhaussée/renforcée AV AR / AR renforcée	DV6TED4	25/09/06-10/09

5213Q43 Triangle de susp. D Right track control arm
OE 3521Q3 3521N3 3521N4 3521L1 3521N53521Q9



3	Sans rotule Without ball joint		
1.1i	Susp. normale	TU1JP	29/03/04-08/05
1.1i	Susp. normale	TU1A	10/10/05-10/09
1.1i	Susp. normale réhaussée/renforcée AV AR / AR renforcée	TU1A	25/09/06-10/09
1.4i	Susp. normale	TU3JP	29/03/04-08/05
1.4i	Susp. normale	TU3JP	10/10/05-10/09
1.4i	Susp. normale réhaussée/renforcée AV AR / AR renforcée	TU3JP	25/09/06-10/09
1.4i	Susp. normale	TU3A	10/10/05-10/09
1.4i	Susp. normale réhaussée/renforcée AV AR / AR renforcée	TU3A	25/09/06-10/09
1.4i 16v.	Susp. normale	ET3J4	29/03/04-08/05
1.4i 16v.	Susp. normale	ET3J4	10/05-10/09
1.4i 16v.	Susp. normale réhaussée / renforcée AV AR / AR renforcée	ET3J4	25/09/06-10/09
1.4 HDi	Susp. normale	DV4TD	29/03/04-08/05
1.4 HDi	Susp. normale	DV4TD	10/10/05-10/09
1.4 HDi	Susp. normale réhaussée / renforcée AV AR / AR renforcée	DV4TD	25/09/06-10/09
1.4 HDi		DV4TED4	29/03/04-08/05
1.6i 16v.	Susp. normale	TU5JP4	29/03/04-08/05
1.6i 16v.	Susp. normale	TU5JP4	10/05-09/10/05
1.6i 16v.	Susp. normale BVA AL4	TU5JP4	10/05-10/09
1.6i 16v.	Susp. normale BVM MA Pilotée	TU5JP4	10/10/05-24/09/06
1.6i 16v.	Susp. normale BVM MA	TU5JP4	25/09/06-10/09
1.6i 16v.	Susp. normale	TU5JP4	25/09/06-10/09
1.6i 16v.	Susp. normale réhaussée/renforcée AV AR / AR renforcée	TU5JP4	25/09/06-10/09
1.6 HDi	Susp. normale	DV6ATED4	29/03/04-08/05
1.6 HDi	Susp. normale	DV6ATED4	10/10/05-10/09
1.6 HDi	Susp. normale réhaussée/renforcée AV AR / AR renforcée	DV6ATED4	25/09/06-10/09
1.6 HDi FAP	Susp. normale	DV6TED4	10/05-10/09
1.6 HDi FAP	Susp. normale réhaussée/renforcée AV AR / AR renforcée	DV6TED4	25/09/06-10/09

... C3 ...

6403563

OE 364065

Rotule de susp. inf. G/D

L/R lower suspension ball joint



1 2	1.1i	Susp. normale	TU1JP	29/03/04-08/05
	1.1i	Susp. normale	TU1A	-10/09
	1.1i	Susp. normale réhaussée / renforcée AV AR / AR renforcée	TU1A	25/09/06-10/09
	1.4i	Susp. normale	TU3A	10/10/05-10/09
	1.4i	Susp. normale réhaussée / renforcée AV AR / AR renforcée	TU3A	25/09/06-10/09
	1.4i	Susp. normale	TU3JP	29/03/04-08/05
	1.4i	Susp. normale	TU3JP	10/10/05-10/09
	1.4i	Susp. normale réhaussée / renforcée AV AR / AR renforcée	TU3JP	25/09/06-10/09
	1.4i 16v.	Susp. normale	ET3J4	29/03/04-08/05
	1.4i 16v.	Susp. normale Sauf monte pneus 16 pouces	ET3J4	10/05-10/09
	1.4i 16v.	Susp. normale réhaussée / renforcée AV AR / AR renforcée	ET3J4	25/09/06-10/09
	1.4 HDi	Susp. normale	DV4TD	29/03/04-08/05
	1.4 HDi	Susp. normale	DV4TD	10/05-10/09
	1.4 HDi	Susp. normale réhaussée / renforcée AV AR / AR renforcée	DV4TD	25/09/06-10/09
	1.4 HDi	Susp. normale	DV4TED4	29/03/04-08/05
	1.6i 16v.	Susp. normale	TU5JP4	29/03/04-08/05
	1.6i 16v.	Susp. normale Sauf monte pneus 16 pouces	TU5JP4	10/05-09/10/05
	1.6i 16v.	Susp. normale BVM MA Pilotée	TU5JP4	10/10/05-24/09/06
	1.6i 16v.	Susp. normale BVM MA	TU5JP4	25/09/06-10/09
	1.6i 16v.	Susp. normale Sauf monte pneus 16 pouces	TU5JP4	25/09/06-10/09
	1.6i 16v.	Susp. normale réhaussée/renforcée AV AR / AR renforcée	TU5JP4	25/09/06-10/09
	1.6 HDi	Susp. normale	DV6ATED4	29/03/04-08/05
	1.6 HDi	Susp. normale Sauf monte pneus 16 pouces	DV6ATED4	10/05-10/09
	1.6 HDi	Susp. normale réhaussée / renforcée AV AR / AR renforcée	DV6ATED4	25/09/06-10/09
	1.6 HDi FAP	Susp. normale réhaussée / renforcée AV AR / AR renforcée	DV6TED4	25/09/06-10/09

6403663

OE 364066

Rotule de susp. inf. G/D

L/R lower suspension ball joint



1 2	1.4i 16v.	Susp. normale Monte pneus 16 pouces	ET3J4	10/05-10/09
	1.6i 16v.	Susp. normale BVA AL4	TU5JP4	10/05-10/09
	1.6i 16v.	Susp. normale Monte pneus 16 pouces	TU5JP4	10/05-10/09
	1.6 HDi	Susp. normale Monte pneu 16 pouces	DV6ATED4	10/05-10/09
	1.6 HDi FAP	Susp. normale	DV6TED4	10/05-10/09



Support d'amortisseur

Suspension mounting
Soporte amortiguador
Poduszka amortyzatora
Опора амортизатора

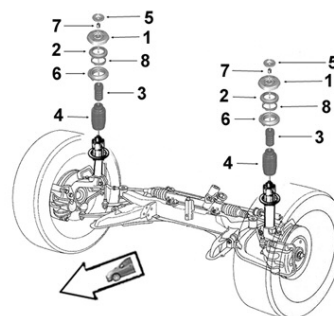

2650038

OE 503375

Coupelle rebond.

Spring cup



5	TT /all models			-10/05
	TT /all models	Sauf DV6ATED4		10/05-10/09
	1.0i	EB0		11/09-
	1.1i	TU1AE5		11/09-
	1.2 VTi	EB2		11/09-
	1.4i /VTi	TU3A/E5 EP3C		11/09-
	1.4 HDi	DV4C DV4TD		11/09-
	1.6i 16v.	EP6C		11/09-
	1.6 HDi	DV6ATED4 DV6C DV6DTED/M DV6ETED M		11/09-

... C3 ...



CITROEN



Support d'amortisseur
Suspension mounting
Soporte amortiguador
Poduszka amortyzatora
Опора амортизатора

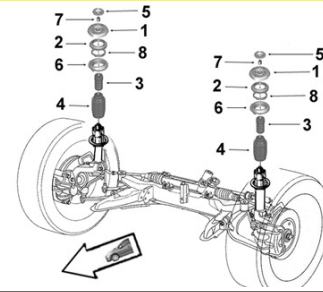

2650005 **Support suspension G/D**
 OE 503891 *L/R suspension mounting*



1 **Sans roulement** *Without bearing*

1.1i	Susp. normale /réhaussée /renforcée AV AR	TU1JP	-29/08/04
1.4i	Susp. normale	TU3JP	-29/08/04
1.4i	Susp. renforcée AV AR	TU3JP	-10/05
1.4i 16v.	Susp. normale /réhaussée	ET3J4	-29/08/04
1.4 HDi	Susp. normale /réhaussée	DV4TD DV4TED4	-29/08/04
1.4 HDi	Susp. renforcée AV AR	DV4TD DV4TED4	-10/05
1.4 HDi VU	Susp. renforcée AR	DV4TD DV4TED4	-29/08/04
1.6i 16v.	Susp. normale /réhaussée	TU5JP4	-29/08/04
1.6i 16v.	Susp. renforcée AV AR	TU5JP4	-10/05

2650015 **Support suspension**
 OE 5038F5 *Suspension mounting*



1

1.1i		TU1JP	30/08/04-10/05
1.1i		TU1A	10/05-10/09
1.4i	Susp. normale	TU3JP	30/08/04-10/09
1.4i	Susp. renforcée AV AR	TU3JP	30/08/04-23/10/05
1.4i 16v.	Susp. normale /réhaussée	ET3J4	30/08/04-10/05
1.4i 16v.	Susp. renforcée AV AR	ET3J4	30/08/04-23/10/05
1.4i 16v.	Susp. normale	ET3J4	10/05-10/09
1.4 HDi		DV4TD	30/08/04-10/09
1.4 HDi 16v.	Susp. normale réhaussée	DV4TED4	30/08/04-10/05
1.6i 16v.	Susp. normale /réhaussée	TU5JP4	30/08/04-10/05
1.6i 16v.	Susp. renforcée AV AR	TU5JP4	30/08/04-23/10/05
1.6i 16v.		TU5JP4	10/05-10/09
1.6 HDi	Susp. normale	DV6ATED4	-10/05
1.6 HDi		DV6ATED4	10/05-10/09
1.6 HDi FAP		DV6TED4	10/05-10/09

2650021 **Support suspension**
 OE 5038G6 *Suspension mounting*



1

1.1i		TU1AE5	11/09-
1.4i		TU3A/E5	11/09-
1.4 VTi		EP3C	11/09-
1.4 HDi		DV4C DV4TD	11/09-
1.6i 16v.		EP6C	11/09-
1.6 HDi		DV6ATED4	11/09-
1.6 HDi		DV6C	11/09-
1.6 HDi		DV6DTED	11/09-



0355275 **Butée à billes G/D**
 OE 503563 *L/R ball bearing*





2

1.1i	BVM	TU1JP	-10/05
1.1i		TU1A	10/05-10/09
1.1i		TU1AE5	11/09-
1.4i	BVM BVA	TU3JP	-10/05
1.4i		TU3A TU3JP	10/05-10/09
1.4i / GPL		TU3AE5	11/09-
1.4i 16v.		ET3J4	-10/09
1.4 VTi 16v.		EP3C	11/09-
1.4 HDi		DV4TD	-10/09
1.4 HDi		DV4TED4	-10/05
1.4 HDi		DV4C /TD	11/09-
1.6i 16v.		TU5JP4	-10/09
1.6i 16v.		EP6C	11/09-
1.6 HDi		DV6ATED4	
1.6 HDi		DV6DTED DV6C	11/09-
1.6 HDi FAP		DV6TED4	-10/09

... C3 ...

2650011 OE 503174	Coupelle amortisseur G/D <i>L/R shock absorber cup</i>		2650043 OE 5033C3	Coupelle amortisseur G/D <i>L/R shock absorber cup</i>
	6	1.1i TU1A 10/05-10/09	NEW 	1.0i EB0 11/09-
		1.1i TU1JP -10/05		1.1i TU1AE5 11/09-
		1.4i /16v. TU3A/P ET3J4 -10/09		1.2 VTi EB2 11/09-
		1.4 HDi DV4TD 10/05-10/09		1.4i /VTi TU3A/E5 EP3C 11/09-
		1.4 HDi DV4TED4 -10/05		1.4 HDi DV4C DV4TD 11/09-
		1.6i 16v. TU5JP4 -10/09		1.6i 16v. EP6C 11/09-
		1.6 HDi DV6ATED4 -10/09		1.6 HDi DV6C DV6ETED M 11/09-
		1.6 HDi FAP DV6TED4 10/05-10/09		1.6 HDi DV6DTEM 11/09-
				1.6 HDi DV6ATED4 11/09-

0335725 OE 503372	Butée de suspension G/D <i>L/R suspension bush</i>			
	3	1.1i TU1JP BVM -10/05		
		1.1i TU1A 10/05-10/09		
		1.4i Sauf susp. renforcée AV AR TU3JP BVM BVA -10/05		
		1.4i Sauf susp. renforcée AV AR TU3JP TU3A 10/05-10/09		
		1.4i 16v. ET3J4 -10/05		
		1.4i 16v. Jante Ø 14/15 pouces ET3J4 10/05-10/09		
		1.4 HDi sauf susp. renforcée AV AR DV4TD -10/05		
		1.4 HDi DV4TD 10/05-10/09		
		1.4 HDi DV4TED4 -10/05		
		1.6i 16v. Sauf susp. renforcée AV AR TU5JP4 -10/05		
		1.6i 16v. Jante Ø 15 pouces TU5JP4 BVM 10/05-10/09		
		1.6 HDi DV6ATED4 -10/05		
1.6 HDi Jante Ø 15 pouces DV6ATED4 10/05-10/09				

2650044 OE 525448	Protecteur amortisseur G/D <i>L/R shock absorber protector</i>		
NEW 	4	1.0i EB0 05/12-	
		1.1i / GPL TU1AE5 11/09-	
		1.2 VTi EB2 11/09-	
		1.4i / GPL TU3A/AE5 11/09-	
		1.4i VTi / GPL EP3C 11/09-	
		1.4 HDi /FAP DV4C DV4TD 11/09-	
		1.6i 16v. EP6C 11/09-	
		1.6 HDi DV6ATED4 /DTEM /ETEDM DV6C/DTED 11/09-	



Support d'amortisseur
Suspension mounting
Soporte amortiguador
Poduszka amortyzatora
Опора амортизатора

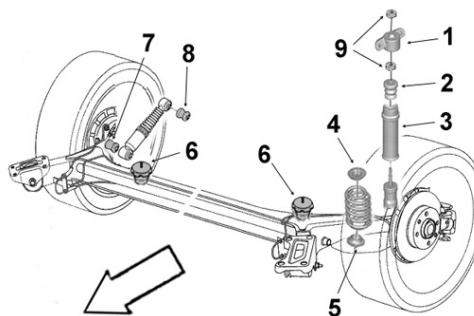

1665675 OE 516694	Butée de talonnage G/D <i>L/R bushing</i>			
	6	H78		
		TT /all models Berline comm. 5ptes		-16/11/03
		TT /all models Susp. normale		-10/05
		1.1i Tambour AR Disques AR	TU1A	10/05-10/09
		1.4i Tambour AR Disques AR	TU3A	10/05-10/09
		1.4i sauf GNV Tambour AR Susp. normale	Disques AR TU3JP	10/05-10/09
		1.4i 16v. Tambour AR Susp. normale	Disques AR ET3J4	10/05-10/09
		1.4 HDi Tambour AR Susp. normale	Disques AR DV4TD	10/05-10/09
		1.6i 16v. Tambour AR Susp. normale	Disques AR TU5JP4	10/05-10/09
		1.6 HDi Tambour AR Susp. normale	Disques AR DV6ATED4	10/05-10/09
1.6 HDi FAP Tambour AR Susp. normale	Disques AR DV6TED4	10/05-10/09		

... C3 ...

SASIC

CITROEN



Support d'amortisseur
Suspension mounting
Soporte amortiguador
Poduszka amortyzatora
Опора амортизатора

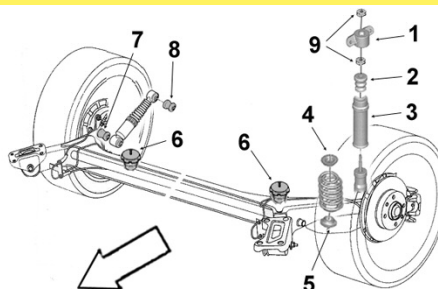

1665685

OE 516695

Butée de talonnage G/D

L/R bushing



6

H85

TT /all models	Susp. normale réhaussée	Susp. renforcée AV AR	Ponts et chaussée	-10/05
1.1i	Tambour AR	Susp. renforcée AV AR	/Normale réhaussée	TU1A 10/05-10/09
1.4i	Tambour AR	susp. renforcée AV AR	ou réhaussée	TU3A/JP 10/05-10/09
1.4i 16v.	Tambour AR	susp. renforcée AV AR	ou réhaussée	ET3J4 10/05-10/09
1.4 HDi	Tambour AR	Susp. renforcée AV AR	/Normale réhaussée	DV4TD 10/05-10/09
1.6i 16v.	Tambour AR	Susp. renforcée AV AR	/réhaussée	TU5JP4 10/05-10/09
1.6 HDi	Tambour AR	Susp. renforcée AV AR	/réhaussée	DV6ATED4 10/05-10/09
1.6 HDi FAP	Tambour AR	Susp. renforcée AV AR	/Normale réhaussée	DV6TED4 10/05-10/09

1665745

OE 516696

Butée de talonnage G/D

L/R bushing



6

H85

TT /all models	Berline comm. 5ptes			17/11/03-10/05
1.1i	Tambour AR	Susp. AR renforcée	TU1A	10/05-10/09
1.4i	Tambour AR	Susp. AR renforcée	TU3A/JP	10/05-10/09
1.4i 16v.	Tambour AR	Susp. AR renforcée	ET3J4	10/05-10/09
1.4i GNV	Susp. normale	Tambours AR	TU3JP	10/05-10/09
1.4 HDi	Tambour AR	Susp. AR renforcée	DV4TD	10/05-10/09
1.6i 16v.	Tambour AR	Susp. AR renforcée	TU5JP4	10/05-10/09
1.6 HDi	Tambour AR	Susp. AR renforcée	DV6ATED4/TED4	10/05-10/09

Eléments TRAIN ARRIERE

Rear axle parts

Tren TRAS

Elementy zawieszenia tylnego

элементы задней оси.



1315C15

OE 5131C1

Articulation essieu

Axle bush



Ø int.13 Ø ext.61 coll.70 long. tube int.68 ext.46 ep. Coll.7

1.1i	Susp. normale	TU1JP	-28/03/04
1.1i	Susp. renforcée AV AR	TU1JP	06/01/03-10/05
1.4i /16v.	Susp. normale	TU3JP ET3J4	-28/03/04
1.4i /16v.	Susp. renforcée AV AR	TU3JP ET3J4	06/01/03-10/05
1.4 HDi	Susp. normale	DV4TD/ED4	-28/03/04
1.4 HDi	Susp. renforcée AV AR	DV4TD/ED4	06/01/03-10/05
1.6i 16v.	Susp. normale	TU5JP4	-28/03/04
1.6i 16v.	Susp. renforcée AV AR	TU5JP4	06/01/03-10/05
1.6 HDi	Susp. renforcée AV AR	DV6ATED4	06/01/03-10/05

2600013

OE 5131C6

Articulation essieu



Axle bush



Ø int. 12 Ø ext. 61 coll. 70 long. tube int.68 ext.46 ep. Coll.7.6

1.1i	Susp. normale	TU1JP TU1A	29/03/04-10/09
1.4i	Susp. normale	TU3JP	29/03/04-10/05
1.4i	Susp. normale /AR renforcée	TU3JP	10/05-10/09
1.4i		TU3A	10/05-10/09
1.4i 16v.	Susp. normale	ET3J4	29/03/04-10/05
1.4i 16v.		ET3J4	10/05-10/09
1.4 HDi	Susp. normale	DV4TED4	29/03/04-10/05
1.4 HDi	Susp. normale	DV4TD	29/03/04-10/09
1.6i 16v.	Susp. normale	TU5JP4	29/03/04-10/05
1.6i 16v.		TU5JP4	10/05-10/09
1.6 HDi	Susp. normale	DV6ATED4	-10/05
1.6 HDi /FAP		DV6ATED4 DV6TED4	10/05-10/09

... C3



... C3																						
1315C25 OE 5131C2	Articulation essieu <i>Axle bush</i>																					
	<p>Ø int.13 Ø ext.61 coll.70 long. tube int.68 ext.46 ep. Coll.7</p> <table border="0"> <tr> <td>TT /all models</td> <td>Susp. renforcée AV AR</td> <td></td> <td>05/11/01-10/05</td> </tr> <tr> <td>TT /all models</td> <td>Susp. normale réhaussée</td> <td>Susp. AR renforcée</td> <td>-10/05</td> </tr> <tr> <td>1.1i</td> <td>Susp. renforcée AV AR</td> <td>TU1A</td> <td>10/05-10/09</td> </tr> <tr> <td>1.4i</td> <td>Susp. renforcée AV AR</td> <td>TU3JP</td> <td>10/05-10/09</td> </tr> <tr> <td>1.4 HDi</td> <td>Susp. renforcée AV AR</td> <td>DV4TD</td> <td>10/05-10/09</td> </tr> </table>	TT /all models	Susp. renforcée AV AR		05/11/01-10/05	TT /all models	Susp. normale réhaussée	Susp. AR renforcée	-10/05	1.1i	Susp. renforcée AV AR	TU1A	10/05-10/09	1.4i	Susp. renforcée AV AR	TU3JP	10/05-10/09	1.4 HDi	Susp. renforcée AV AR	DV4TD	10/05-10/09	
TT /all models	Susp. renforcée AV AR		05/11/01-10/05																			
TT /all models	Susp. normale réhaussée	Susp. AR renforcée	-10/05																			
1.1i	Susp. renforcée AV AR	TU1A	10/05-10/09																			
1.4i	Susp. renforcée AV AR	TU3JP	10/05-10/09																			
1.4 HDi	Susp. renforcée AV AR	DV4TD	10/05-10/09																			
2600009 OE 5131H4	Articulation essieu <i>Axle bush</i>																					
	<p>Ø int. 12 Ø ext. 72 coll. 83 long. tube int. 83 ext. 60 ep. coll.5.5</p> <table border="0"> <tr> <td>1.1i</td> <td>TU1AE5</td> <td>11/09-</td> </tr> <tr> <td>1.2 VTi</td> <td>EB2</td> <td>11/09-</td> </tr> <tr> <td>1.4i</td> <td>TU3A TU3AE5</td> <td>11/09-</td> </tr> <tr> <td>1.4 VTi</td> <td>EP3C</td> <td>11/09-</td> </tr> <tr> <td>1.4 HDi</td> <td>DV4C DV4TD</td> <td>11/09-</td> </tr> <tr> <td>1.6i 16v.</td> <td>EP6C</td> <td>11/09-</td> </tr> <tr> <td>1.6 HDi</td> <td>DV6ATED4 DV6C DV6DTED/M DV6ETED M</td> <td>11/09-</td> </tr> </table>	1.1i	TU1AE5	11/09-	1.2 VTi	EB2	11/09-	1.4i	TU3A TU3AE5	11/09-	1.4 VTi	EP3C	11/09-	1.4 HDi	DV4C DV4TD	11/09-	1.6i 16v.	EP6C	11/09-	1.6 HDi	DV6ATED4 DV6C DV6DTED/M DV6ETED M	11/09-
1.1i	TU1AE5	11/09-																				
1.2 VTi	EB2	11/09-																				
1.4i	TU3A TU3AE5	11/09-																				
1.4 VTi	EP3C	11/09-																				
1.4 HDi	DV4C DV4TD	11/09-																				
1.6i 16v.	EP6C	11/09-																				
1.6 HDi	DV6ATED4 DV6C DV6DTED/M DV6ETED M	11/09-																				

C3 Picasso ...

Eléments DIRECTION

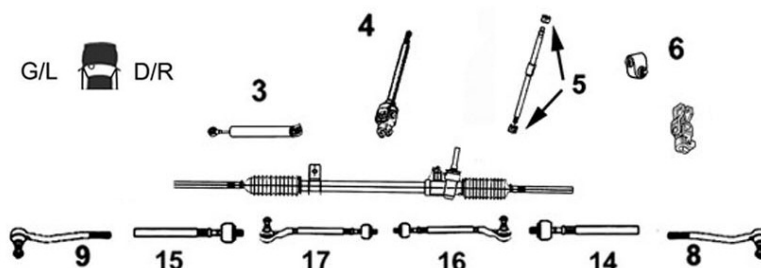
Steering parts
Elementos Direcciones
Elementy uklad kierowniczy
Элементы рулевой системы



8123E83 OE 3812E8		Axe de bielle G/D <i>L/R axial joint</i>																					
	<p>14 Côté dir. M12x1.0 Côté rot. M16x1.5 long 213 mm 15</p> <table border="0"> <tr> <td>1.4 VTi 16v.</td> <td>EP3 EP3C</td> </tr> <tr> <td>1.6i 16v.</td> <td>EP6C EP6</td> </tr> <tr> <td>1.6 HDi</td> <td>DV6ATED4 DV6C DV6DTED</td> </tr> <tr> <td>1.6 HDi FAP</td> <td>DV6TED4</td> </tr> </table>	1.4 VTi 16v.	EP3 EP3C	1.6i 16v.	EP6C EP6	1.6 HDi	DV6ATED4 DV6C DV6DTED	1.6 HDi FAP	DV6TED4														
1.4 VTi 16v.	EP3 EP3C																						
1.6i 16v.	EP6C EP6																						
1.6 HDi	DV6ATED4 DV6C DV6DTED																						
1.6 HDi FAP	DV6TED4																						
8173673 OE 381767		8173683 OE 381768																					
Rotule de direction G <i>Left tie rod end</i>		Rotule de direction D <i>Right tie rod end</i>																					
	<p>9 M16 x 1.5</p> <table border="0"> <tr> <td>1.4 VTi 16v.</td> <td>EP3 EP3C</td> </tr> <tr> <td>1.6i 16v.</td> <td>EP6C EP6</td> </tr> <tr> <td>1.6 HDi</td> <td>DV6ATED4 DV6C</td> </tr> <tr> <td>1.6 HDi</td> <td>DV6DTED</td> </tr> <tr> <td>1.6 HDi FAP</td> <td>DV6TED4</td> </tr> </table>	1.4 VTi 16v.	EP3 EP3C	1.6i 16v.	EP6C EP6	1.6 HDi	DV6ATED4 DV6C	1.6 HDi	DV6DTED	1.6 HDi FAP	DV6TED4		<p>8 M16 x 1.5</p> <table border="0"> <tr> <td>1.4 VTi 16v.</td> <td>EP3 EP3C</td> </tr> <tr> <td>1.6i 16v.</td> <td>EP6C EP6</td> </tr> <tr> <td>1.6 HDi</td> <td>DV6ATED4 DV6C</td> </tr> <tr> <td>1.6 HDi</td> <td>DV6DTED</td> </tr> <tr> <td>1.6 HDi FAP</td> <td>DV6TED4</td> </tr> </table>	1.4 VTi 16v.	EP3 EP3C	1.6i 16v.	EP6C EP6	1.6 HDi	DV6ATED4 DV6C	1.6 HDi	DV6DTED	1.6 HDi FAP	DV6TED4
1.4 VTi 16v.	EP3 EP3C																						
1.6i 16v.	EP6C EP6																						
1.6 HDi	DV6ATED4 DV6C																						
1.6 HDi	DV6DTED																						
1.6 HDi FAP	DV6TED4																						
1.4 VTi 16v.	EP3 EP3C																						
1.6i 16v.	EP6C EP6																						
1.6 HDi	DV6ATED4 DV6C																						
1.6 HDi	DV6DTED																						
1.6 HDi FAP	DV6TED4																						

... C3 Picasso ...

CITROEN

SASIC



Barre stabilisatrice
 Stabilizer bar
 Barra estabilizadora
 Drażek stabilizatora
 стабилизатор поперечной устойчивости

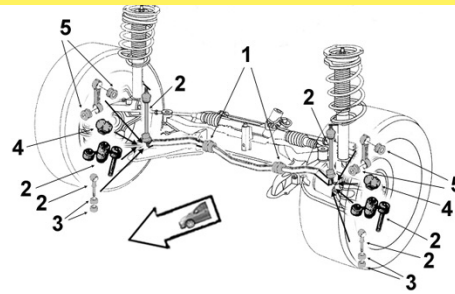

2300013
 OE 508769

Biellette de barre stab. G
Left stabilizer bar stub axle



2

1.4 VTi 16v. EP3 BVM BE4R
 1.6i 16v. EP6 BVM BE4R
 1.6 HDi DV6ATED4
 1.6 HDi FAP DV6TED4
 1.6 HDi FAP DV6DTED

2300012
 OE 508768

Biellette de barre stab. D
Right stabilizer bar stub axle



2

1.4 VTi 16v. EP3 BVM BE4R
 1.6i 16v. EP6 BVM BE4R
 1.6 HDi DV6ATED4
 1.6 HDi FAP DV6TED4
 1.6 HDi FAP DV6DTED

2300032
 OE 5094C5

Palier de barre milieu
Middle bar main bearing



1 Barre Ø 23

1.4 VTi 16v. EP3 EP3C
 1.6i 16v. EP6 EP6C
 1.6 HDi DV6ATED4 DV6C
 1.6 HDi DV6DTED
 1.6 HDi FAP DV6TED4



Eléments SUSPENSION
 Suspension parts
 Elementos suspensión
 Elementy zawieszenia
 Элементы подвески

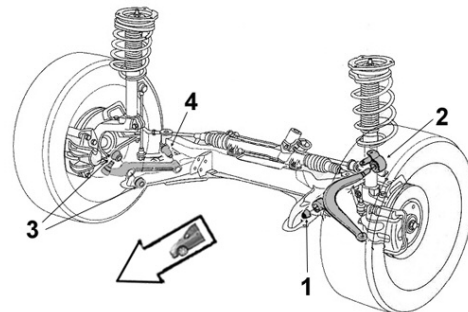

2250015
 Part/oe 3520W5

Articulation AV
Front bush



1 Ø int.14 Ø ext.56 long. tube int.48 ext.30
 Susp. normale

1.4 VTi 16v. EP3 /C
 1.6i 16v. EP6/C
 1.6 HDi DV6ATED4
 1.6 HDi DV6C
 1.6 HDi DV6DTED
 1.6 HDi FAP DV6TED4

2250012
 Part/oe 3520R7

Articulation AV
Front bush



1 Ø int. 14 Ø ext. 56 long. tube int.48 ext.30
 Susp. AR renforcée

1.4 VTi 16v. EP3 BVM BE4R
 1.6i 16v. EP6 BVM BE4R
 1.6 HDi DV6ATED4
 1.6 HDi FAP DV6TED4

2250016
 Part/oe 3520W5

Articulation AR
Rear bush



2 Ø int.14 Ø ext.56 long. tube int. 48 ext. 27
 Susp. normale

1.4 VTi 16v. EP3 EP3C
 1.6i 16v. EP6 EP6C
 1.6 HDi DV6ATED4 DV6C
 1.6 HDi DV6DTED
 1.6 HDi FAP DV6TED4

2250007
 Part/oe 3520R7

Articulation AR
Rear bush



2 Ø int. 14 Ø ext. 56 long. tube int. 48 ext. 28
 Susp. AR renforcée

1.4 VTi 16v. EP3 BVM BE4R
 1.6i 16v. EP6 BVM BE4R
 1.6 HDi DV6ATED4
 1.6 HDi FAP DV6TED4

...C3 Picasso...

Bras & Triangle de suspension

Control arm
Brazo y triángulo
Wahacz
Рычаг подвески

G/L  D/R

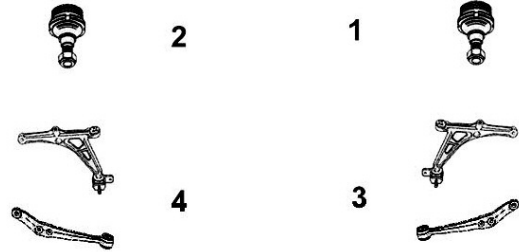

5203Q93
OE 3520R7

Triangle de susp. inf. G
Lower left track control arm



4 Avec rotule With ball joint
Susp. AR renforcée

1.4 VTi 16v.	EP3/C
1.6i 16v.	EP6/C
1.6 HDi FAP	DV6TED4
1.6 HDi	DV6ATED4
1.6 HDi	DV6C
1.6 HDi	DV6DTED

5213N03
OE 3521N8

Triangle de susp. inf. D
Lower right track control arm



3 Avec rotule With ball joint
Susp. AR renforcée

1.4 VTi 16v.	EP3/C
1.6i 16v.	EP6/C
1.6 HDi FAP	DV6TED4
1.6 HDi	DV6ATED4
1.6 HDi	DV6C
1.6 HDi	DV6DTED

6403563
OE 364065

Rotule de susp. inf. G/D
L/R lower suspension ball joint



1
2 Susp. normale

1.4 VTi 16v.	EP3/C
1.6i 16v.	EP6/C
1.6 HDi FAP	DV6TED4
1.6 HDi	DV6ATED4
1.6 HDi	DV6C
1.6 HDi	DV6DTED

6403623
OE 364062

Rotule de susp. inf. G/D
L/R lower suspension ball joint



1
2 Susp. AR renforcée

1.4 VTi 16v.	EP3/C
1.6i 16v.	EP6/C
1.6 HDi FAP	DV6TED4
1.6 HDi	DV6ATED4
1.6 HDi	DV6C
1.6 HDi	DV6DTED



Support d'amortisseur

Suspension mounting
Soporte amortiguador
Poduszka amortyzatora
Опора амортизатора

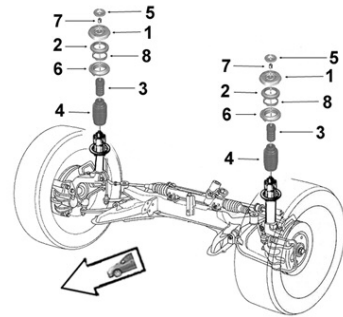

2650038
OE 503375

Coupelle rebond.
Spring cup



5

1.4 VTi 16v.	EP3/C/G
1.6i 16v.	EP6/C
1.6 HDi	DV6ATED4
1.6 HDi	DV6C
1.6 HDi	DV6DTED
1.6 HDi FAP	DV6TED4

2650021
OE 5038G6

Support suspension
Suspension mounting



1

1.4 VTi 16v.	EP3/C
1.6i 16v.	EP6/C
1.6 HDi	DV6ATED4
1.6 HDi	DV6C
1.6 HDi	DV6DTED
1.6 HDi FAP	DV6TED4

0355275
OE 503563

Butée à billes G/D
L/R ball bearing



2

1.4 VTi 16v. Susp. normale	EP3
1.6i 16v.	EP6
1.6 HDi Susp. normale	DV6ATED4
1.6 HDi FAP	DV6TED4
1.6 HDi FAP	DV6DTED

2650043
OE 5033C3

Coupelle amortisseur G/D
L/R shock absorber cup

NEW



6

1.4 VTi 16v.	EP3/C
1.6i 16v.	EP6/C
1.6 HDi	DV6DTED
1.6 HDi	DV6C
1.6 HDi	DV6ATED4
1.6 HDi FAP	DV6TED4

...C3 Picasso

CITROEN

SASIC



Support d'amortisseur
Suspension mounting
Soporte amortiguador
Poduszka amortyzatora
Опора амортизатора

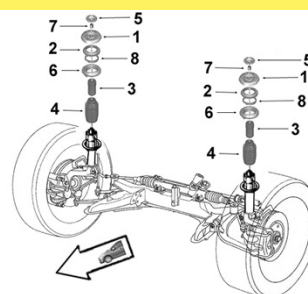

2650013
OE 5033E5

Butée de suspension
Shock bush



3

1.4 VTi 16v. Susp. normale EP3
1.6i 16v. EP6
1.6 HDi Susp. normale DV6ATED4
1.6 HDi FAP DV6TED4
1.6 HDi FAP 03/10- DV6DTED

2650044
OE 525448

Protecteur amortisseur G/D
L/R shock absorber protector

NEW



4

1.4i VTi EP3 02/09-
1.6i /16v. EP6 02/09-
1.6 HDi /FAP DV6 02/09-

Eléments TRAIN ARRIERE

Rear axle parts
Tren TRAS
Elementy zawieszenia tylnego
элементы задней оси.



2600009
OE 5131H4

Articulation essieu
Axle bush



Ø int. 12 Ø ext. 72 coll. 83
long. tube int. 83 ext. 60 ep. coll.5.5

Susp. normale

1.4 VTi 16v. EP3 EP3C
1.6i 16v. EP6 EP6C
1.6 HDi DV6ATED4 DV6C
DV6DTED
1.6 HDi FAP DV6TED4

2600006
OE 5131E9

Articulation essieu
Axle bush



Ø int. 12.2 Ø ext. 72 coll. 83
long. tube int. 82.7 ext. 60 ep. coll.6.7

Susp. AR renforcée

1.4 VTi 16v. EP3/C
1.6i 16v. EP6/C
1.6 HDi DV6ATED4 DV6C
DV6DTED
1.6 HDi FAP DV6TED4

C3 Pluriel ...

Eléments DIRECTION

Steering parts
Elementos Direcciones
Elementy uklad kierowniczy
Элементы рулевой системы

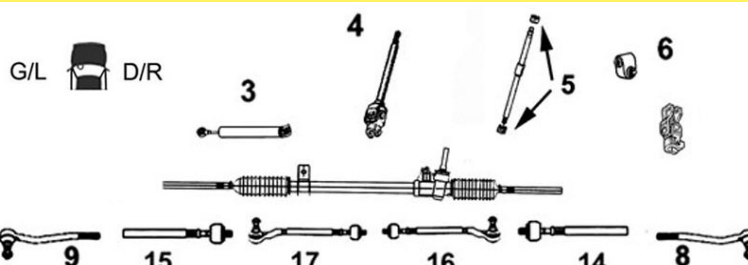

3008080

Axe de bielle G/D

Part/oe 3812E1

L/R axial joint





14 Côté dir. M12x1.0 Côté rot. M14x1.5 long 239 mm
15

1.4i
1.4 HDi
1.6i 16v.

... C3 Pluriel ...

CITROEN





8173553 OE 381755	Rotule de direction G <i>Left tie rod end</i>	8173563 OE 381756	Rotule de direction D <i>Right tie rod end</i>
	9 1.4i 1.4 HDi 1.6i 16v.		8 1.4i 1.4 HDi 1.6i 16v.

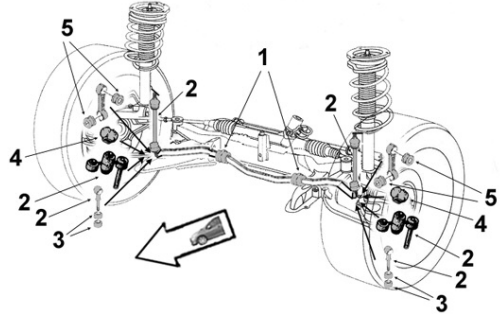

Barre stabilisatrice
Stabilizer bar
Barra estabilizadora
Drażek stabilizatora
стабилизатор поперечной устойчивости





0875455 OE 508759	Biellette barre stab. <i>Stabilizer bar stub axle</i>	
	2 1.4i 1.4i 1.4 HDi 1.6i 16v.	0875455QT réservée à l'export <i>(for export only)</i>

2300002 OE 509496	Palier de barre milieu <i>Middle bar main bearing</i>	2300026 OE 5094A6	Palier de barre milieu <i>Middle bar main bearing</i>
	1 Barre Ø 20 1.4i 1.4 HDi 1.6i 16v. -02/05/04 -02/05/04 -02/05/04		1 Barre Ø 19/20 1.4i 1.4 HDi 1.6i 16v. 03/05/04- 03/05/04- 03/05/04-

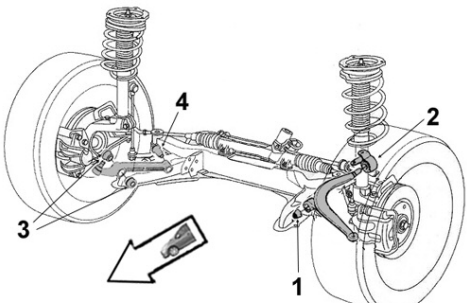

Eléments SUSPENSION
Suspension parts
Elementos suspensión
Elementy zawieszenie
Элементы подвески



5233983 OE 352398	Articulation AV <i>Front bush</i>	5233AA3 OE 3523AA	Articulation AR <i>Rear bush</i>
	1 Ø int.18 Ø ext.56 coll.73 long. tube int.48 ext.20 ep. coll.10 1.4i 1.4 HDi 1.6i 16v. -28/11/06 -28/11/06 -28/11/06		2 Ø int.18 Ø ext.57 coll.73 long. tube int.48 ext.20 ep. coll.9 1.4i 1.4 HDi 1.6i 16v. -28/11/06 -28/11/06 -28/11/06

...C3 Pluriel...

Bras & Triangle de suspension

Control arm
Brazo y triángulo
Wahacz
Рычаг подвески

G/L  D/R

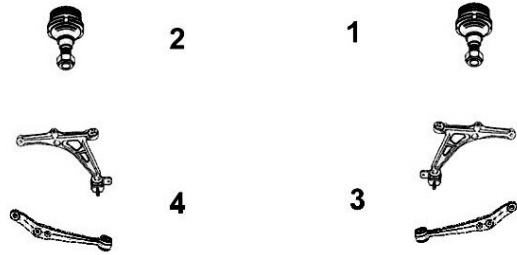

5203L43
OE 3520R1

Bras de suspension G
Left track control arm



4 Avec rotule *With ball joint*

1.4i -09/10/05
1.4 HDi -09/10/05
1.6i 16v. -09/10/05

5213H63
OE 3521N2

Bras de suspension D
Right track control arm



3 Avec rotule *With ball joint*

1.4i -09/10/05
1.4 HDi -09/10/05
1.6i 16v. -09/10/05

5203T33
OE 3520R0

Triangle de susp. G
Left track control arm



4 Sans rotule *Without ball joint*

1.4i 10/10/05-28/11/06
1.4 HDi 10/10/05-28/11/06
1.6i 16v. 10/10/05-28/11/06

5213Q43
OE 3521J2

Triangle de susp. D
Right track control arm



3 Sans rotule *Without ball joint*

1.4i 10/10/05-28/11/06
1.4 HDi 10/10/05-28/11/06
1.6i 16v. 10/10/05-28/11/06

6403563
OE 364065

Rotule de susp. inf. G/D
L/R lower suspension ball joint



1
2

1.4i 10/10/05-28/11/06
1.4 HDi 10/10/05-28/11/06
1.6i 16v. 10/10/05-28/11/06



Support d'amortisseur

Suspension mounting
Soporte amortiguador
Poduszka amortyzatora
Опора амортизатора

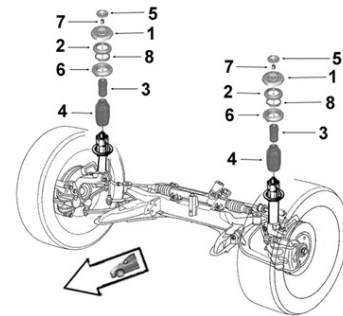

2650038
OE 503375

Coupelle rebond.
Spring cup



5

TT /all models

2650005
OE 503891

Support suspension G/D
L/R suspension mounting



1 Sans roulement *Without bearing*

1.4i TU3JP -29/08/04
1.4 HDi DV4TD -29/08/04
1.6i 16v. TU5JP4 -29/08/04

...C3 Pluriel

CITROEN





2650015 OE 5038F5	Support suspension <i>Suspension mounting</i>	0355275 OE 503563	Butée à billes G/D <i>L/R ball bearing</i>
	1 1.4i TU3JP 30/08/04- 1.4i TU3A 1.4 HDi DV4TD 30/08/04- 1.6i 16v. TU5JP4 30/08/04-		2 1.4i 1.4 HDi 1.6i 16v.

2650011 OE 503174	Coupelle amortisseur G/D <i>L/R shock absorber cup</i>	0335725 OE 503372	Butée de suspension G/D <i>L/R suspension bush</i>
	6 1.4i 1.4 HDi 1.6i 16v.		3 1.4i 1.4 HDi 1.6i 16v.

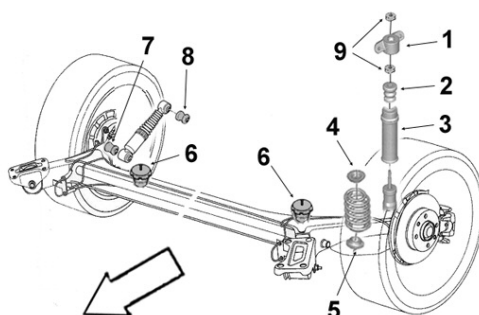

Support d'amortisseur
Suspension mounting
Soporte amortiguador
Poduszka amortyzatora
Опора амортизатора



1665685 OE 516695	Butée de talonnage G/D <i>L/R bushing</i>		
	6 H85 1.4i 1.4 HDi 1.6i 16v.		

Eléments TRAIN ARRIERE
Rear axle parts
Tren TRAS
Elementy zawieszenia tylnego
элементы задней оси.



1315C25 OE 5131C2	Articulation essieu <i>Axle bush</i>		
	Ø int.13 Ø ext.61 coll.70 long. tube int.68 ext.46 ep. Coll.7 1.4i 1.4i 1.4 HDi 1.6i 16v.		

C4...

Eléments DIRECTION

Steering parts

Elementos Direcciones

Elementy układ kierowniczy

Элементы рулевой системы

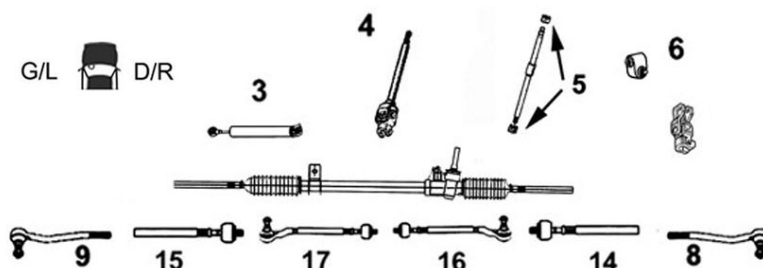
**3008159****Axe de bielle G/D**

Part/oe 3812E0

L/R axial joint



14 Côté dir. M14x1.5 Côté rot. M14x1.5 long 322 mm

15	1.4i 16v.	ET3J4	-30/01/05
	1.6i 16v.	TU5JP4	-30/01/05
	1.6 HDi	DV6ATED4	-30/01/05
	1.6 HDi	DV6TED4	-30/01/05
	2.0i 16v.	EW10A	-30/01/05
	2.0i 16v.	EW10J4/S	-30/01/05
	2.0 HDi	DW10BTED4	-30/01/05

8123E53**Axe de bielle G/D**

OE 3812E5

L/R axial joint



14 Côté dir. M14x1.5 Côté rot. M14x1.5 long 340 mm

15	1.4i 16v.	ET3J4	31/01/05-10/10
	1.6i 16v./THP	EP6D/T	31/01/05-10/10
	1.6i 16v.	TU5JP4	31/01/05-10/10
	1.6 HDi	DV6C M	31/01/05-10/10
	1.6 HDi /FAP	DV6TED4B DV6ATED4 DV6TED4	31/01/05-10/10
	2.0i 16v.	EW10J4/S EW10A	31/01/05-10/10
	2.0 HDi	DW10BTED4	31/01/05-10/10
	2.0 HDi sans FAP	DW10ATED	31/01/05-10/10

7770002**Axe de bielle G/D**

OE 3812F2

L/R axial joint



14 Côté dir. M14x1.5 Côté rot. M14x1.5 long 278 mm

15	1.2 VTi	EB2DTS	10/10-
	1.4 VTi	EP3C	10/10-
	1.6i 16v.	TU5JP4 EP6C	10/10-
	1.6i 16v. THP	EP6CDT MD EP6CDT/X EP6CDT M	10/10-
	1.6 HDi	DV6C	10/10-
	1.6 HDi	DV6DTEB DV6DTEB M	10/10-
	2.0 HDi FAP	DW10CB DTR DW10CTED4 DTR	10/10-
	2.0 HDi FAP	DW10CTED4	10/10-

8173313**Rotule de direction G**

OE 381742

Left tie rod end



9 M14 x 1.5

	1.4i 16v.	ET3J4	-30/01/05
	1.6i 16v.	TU5JP4	-30/01/05
	1.6 HDi	DV6ATED4	-30/01/05
	1.6 HDi	DV6TED4	-30/01/05
	2.0i 16v.	EW10A	-30/01/05
	2.0i 16v.	EW10J4/S	-30/01/05
	2.0 HDi	DW10BTED4	-30/01/05

8173303**Rotule de direction D**

OE 381741

Right tie rod end



8 M14 x 1.5

	1.4i 16v.	ET3J4	-30/01/05
	1.6i 16v.	TU5JP4	-30/01/05
	1.6 HDi	DV6ATED4	-30/01/05
	1.6 HDi	DV6TED4	-30/01/05
	2.0i 16v.	EW10A	-30/01/05
	2.0i 16v.	EW10J4/S	-30/01/05
	2.0 HDi	DW10BTED4	-30/01/05

8173183**Rotule de direction G/D**

OE 381750



L/R tie rod end



8 M14 x 1.5

9	1.4i 16v.	ET3J4	31/01/05-10/10
	1.6i 16v.	TU5JP4 EP6	31/01/05-10/10
	1.6i 16v. THP	EP6DT	31/01/05-10/10
	1.6 HDi	DV6ATED4 DV6TED4 DV6C M	31/01/05-10/10
	1.6 HDi FAP	DV6TED4B	31/01/05-10/10
	2.0i 16v.	EW10A EW10J4 EW10J4S	31/01/05-10/10
	2.0 HDi	DW10BTED4	31/01/05-10/10
	2.0 HDi sans FAP	DW10ATED	31/01/05-10/10

...C4...

7670017 OE 381789	Rotule de direction G <i>Left tie rod end</i>	7670016 OE 381788	Rotule de direction D <i>Right tie rod end</i>
NEW	9 M14 x 1.5	NEW	8 M14 x 1.5
	1.2 VTi EB2DTS 10/10- 1.4 VTi EP3C 10/10- 1.6i 16v. TU5JP4 EP6C 10/10- 1.6i 16v. THP EP6CDT/X/M/MD 10/10- 1.6 HDi DV6DTED/M DV6C 10/10- 2.0 HDi/FAP DW10CTED4 /DTR DW10CB DTR 10/10-		1.2 VTi EB2DTS 10/10- 1.4 VTi EP3C 10/10- 1.6i 16v. TU5JP4 EP6C 10/10- 1.6i 16v. THP EP6CDT/X/M/MD 10/10- 1.6 HDi DV6DTED/M DV6C 10/10- 2.0 HDi/FAP DW10CTED4 /DTR DW10CB DTR 10/10-



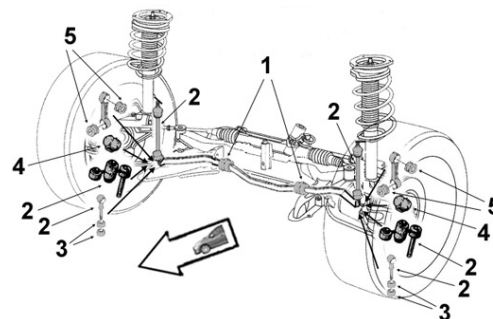

Barre stabilisatrice
Stabilizer bar
Barra estabilizadora
Drążek stabilizatora
 стабилизатор поперечной устойчивости





CITROËN



0875505 OE 508777	Biellette barre stab. <i>Stabilizer bar stub axle</i>			
	2	1.4i 16v. ET3J4 -10/10 1.6i 16v. TU5JP4 -10/10 1.6i 16v. EP6 -10/10 1.6i 16v. Turbo EP6DT -10/10 1.6 HDi DV6TED4 -03/03/10 1.6 HDi DV6ATED4 -10/10 1.6 HDi DV6TED4B -10/10	2.0i 16v. EW10 -10/10 2.0i 16v. EW10A -10/10 2.0i 16v. EW10J4S -10/10 2.0 HDi DW10BTED4 -10/10 2.0 HDi DW10ATED -03/03/10	

2300019 OE 508764	Biellette barre stab. <i>Stabilizer bar stub axle</i>			
	2	1.4i VTi EP3C 10/10- 1.6i 16v. /Turbo EP6C /DT 10/10- 1.6 HDi FAP DV6C 10/10- 2.0 HDi FAP DW10CTED4 10/10-		

0945885 OE 5094E0	Palier de barre milieu <i>Middle bar main bearing</i>			
	1	Barre Ø 22		
		1.4i 16v. ET3J4 -10/10 1.4 VTi EP3C 10/10- 1.6i 16v. TU5JP4 07/06/04- 1.6i 16v. EP6 -10/10 1.6i 16v. EP6C/G 10/10- 1.6i 16v. THP EP6CDT/X EP6CDT M/MD 10/10- 1.6i 16v. Turbo EP6DT -10/10 1.6 HDi DV6TED4 DV6ATED4 DV6C M -10/10 1.6 HDi DV6C DV6DTED/M 10/10- 1.6 HDi FAP 90hp 66kw DV6TED4B -10/10 2.0i 16v. EW10J4/S EW10A -10/10 2.0 HDi FAP DW10CTED4 /DTR 10/10- 2.0 HDi FAP 136hp 100kw DW10CB DTR 10/10-		

2300027 OE 5094E2	Palier de barre milieu <i>Middle bar main bearing</i>			
	1	Barre Ø 22.5		
		1.4i 16v. ET3J4 03/03/08-10/10 1.6i 16v. TU5JP4 03/03/08-10/10 1.6 HDi DV6TED4 DV6ATED4 03/03/08-10/10 1.6 HDi FAP 90hp 66kw DV6TED4B 03/03/08-10/10 2.0i 16v. EW10A EW10J4 EW10J4S 03/03/08-10/10 2.0 HDi DW10BTED4 -10/10		

...C4...



CITROEN



Barre stabilisatrice
 Stabilizer bar
 Barra estabilizadora
 Drażek stabilizatora
 стабилизатор поперечной устойчивости

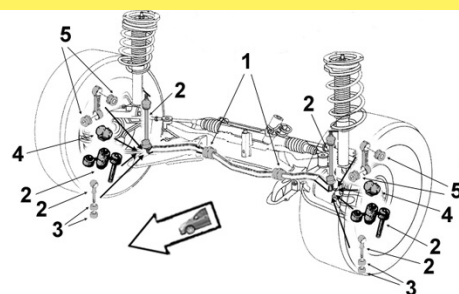

0945895

Palier de barre milieu

OE 5094E3

Middle bar main bearing



1 Barre Ø 23

1.4 VTi	EP3C	10/10-
1.6i 16v.	EP6C/G	10/10-
1.6i 16v.	TU5JP4	08/01/07-
1.6i 16v. THP	EP6CDT/X EP6CDT M/MD	10/10-
1.6 HDi	DV6C M	-10/10
1.6 HDi	DV6C DV6DTED/M	10/10-
2.0i 16v. Susp. renforcée AV AR	EW10A	08/01/07-10/10
2.0 HDi FAP	DW10CTED4 /DTR	10/10-
2.0 HDi FAP 136hp 100kw	DW10CB DTR	10/10-
2.0 HDi Sans FAP	DW10ATED	-10/10

2300035

Palier de barre milieu

OE 5094E4

Middle bar main bearing



1 Barre Ø 24

1.4 VTi	EP3C	10/10-
1.6i 16v.	EP6C/G TU5JP4	10/10-
1.6i 16v. THP	EP6CDT/X/M/MD	10/10-
1.6 HDi	DV6C DV6DTED/M	10/10-
2.0 HDi FAP	DW10CTED4 /DTR	10/10-
2.0 HDi FAP 136hp 100kw	DW10CB DTR	10/10-



Eléments SUSPENSION
 Suspension parts
 Elementos suspensión
 Elementy zawieszenie
 Элементы подвески

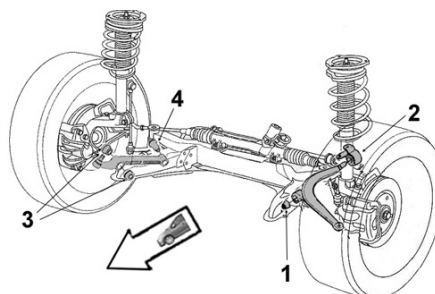

5233913

Articulation AV

OE 352391

Front bush



1 Ø int.14 Ø ext.55 long. tube int.56 ext.32

1.4i 16v.	ET3J4	
1.4i VTi	EP3C	10/10-
1.6i 16v.	TU5JP4 EP6	
1.6i 16v. /Turbo	EP6DT EP6CDT	
1.6i 16v.	EP6C	10/10-
1.6 HDi	DV6ATED4 DV6TED4/B	
1.6 HDi FAP	DV6C DV6DTED	10/10-
2.0i 16v.	EW10A EW10J4/S	
2.0 HDi	DW10A/B/CTED4	

5233923

Articulation AR

OE 352392

Rear bush



2 Ø int.14 Ø ext.55 coll.62 long. tube int.49 ext.25 ep. coll.3

1.4i 16v.	ET3J4	
1.4i VTi	EP3C	10/10-
1.6i 16v. /Turbo	TU5JP4 EP6 EP6DT P6CDT	
1.6i 16v.	EP6C	10/10-
1.6 HDi	DV6ATED4 DV6TED4 DV6TED4B	
1.6 HDi FAP	DV6C DV6DTED	
2.0i 16v.	EW10A EW10J4 EW10J4S	
2.0 HDi	DW10ATED DW10BTED4 /CTED4	

...C4...

Bras & Triangle de suspension

Control arm
Brazo y triángulo
Wahacz
Рычаг подвески

G/L  D/R

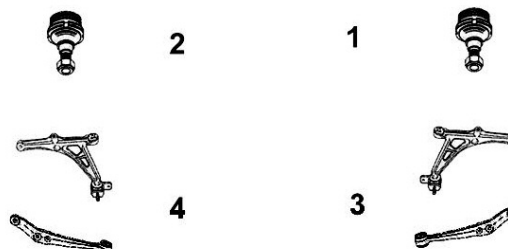

CITROEN



5203K83

OE 3520S2

Triangle de susp. inf. G

Lower left track control arm



4 Sans rotule Without tie rod end

1.4i 16v.	ET3J4	-10/10
1.6i 16v.	TU5JP4 EP6	-10/10
1.6i 16v. THP	EP6DT	-10/10
1.6 HDi	DV6ATED4 DV6TED4 DV6C M	-10/10
1.6 HDi FAP	DV6TED4B	-10/10
2.0i 16v.	EW10J4 EW10J4S EW10A	-10/10
2.0 HDi	DW10BTED4	-10/10
2.0 HDi sans FAP	DW10ATED	-10/10

5213G83

OE 3521P3

Triangle de susp. inf. D

Lower right track control arm



3 Sans rotule Without tie rod end

1.4i 16v.	ET3J4	-10/10
1.6i 16v.	TU5JP4 EP6	-10/10
1.6i 16v. THP	EP6DT	-10/10
1.6 HDi	DV6ATED4 DV6TED4 DV6C M	-10/10
1.6 HDi FAP	DV6TED4B	-10/10
2.0i 16v.	EW10J4 EW10J4S EW10A	-10/10
2.0 HDi	DW10BTED4	-10/10
2.0 HDi sans FAP	DW10ATED	-10/10

7470003

OE 3520V2

Triangle de susp. inf. G

Lower left track control arm



4 Sans rotule Without tie rod end

1.2 VTi	EB2DTS	10/10-
1.4 VTi	EP3C	10/10-
1.6i 16v.	TU5JP4 EP6C	10/10-
1.6i 16v. THP	EP6CDT MD EP6CDT/X EP6CDT M	10/10-
1.6 HDi	DV6C DV6DTED DV6DTED M	10/10-
2.0 HDi FAP	DW10CTED4 DW10CTED4 DTR	10/10-
2.0 HDi FAP	DW10CB DTR	10/10-

7470004

OE 3521R3

Triangle de susp. inf. D

Lower right track control arm



3 Sans rotule Without tie rod end

1.2 VTi	EB2DTS	10/10-
1.4 VTi	EP3C	10/10-
1.6i 16v.	TU5JP4 EP6C	10/10-
1.6i 16v. THP	EP6CDT MD EP6CDT/X EP6CDT M	10/10-
1.6 HDi	DV6C DV6DTED DV6DTED M	10/10-
2.0 HDi FAP	DW10CTED4 DW10CTED4 DTR	10/10-
2.0 HDi FAP	DW10CB DTR	10/10-

6403533

OE 364073

Rotule de susp. inf. G/D

L/R lower suspension ball joint



1	1.2 VTi	EB2DTS	10/10-
2	1.4i 16v.	ET3J4	-10/10
	1.4 VTi	EP3C	10/10-
	1.6i 16v.	EP6 EP6C	10/10-
	1.6i 16v. THP	EP6CDT M/MD EP6CDT/X EP6DT	-10/10
	1.6i 16v.	TU5JP4	
	1.6 HDi	DV6ATED4 DV6C M DV6TED4	-10/10
	1.6 HDi	DV6C DV6DTED DV6DTED M	10/10-
	1.6 HDi FAP	DV6TED4B	-10/10
	2.0i 16v.	EW10A EW10J4 EW10J4S	-10/10
	2.0 HDi sans FAP	DW10ATED	-10/10
	2.0 HDi	DW10BTED4	-10/10
	2.0 HDi FAP	DW10CB DTR DW10CTED4 /DTR	10/10-

...C4...



CITROEN



Support d'amortisseur

Suspension mounting
Soporte amortiguador
Poduszka amortyzatora
Опора амортизатора

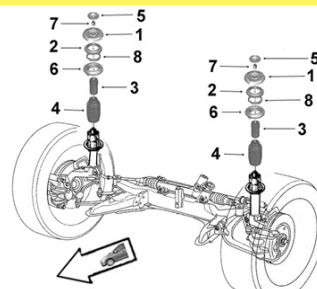

2650038

OE 503375

Coupelle rebond.

Spring cup

5



TT /all models -10/10

0385855

OE 5038G0

Support suspension G/D

L/R suspension mounting

1



1.4i 16v.	ET3J4 TU5JP4	-27/07/06
1.6 HDi Susp. normale	DV6ATED4	-24/10/06
1.6 HDi Susp. renforcée AV AR	DV6ATED4	-27/07/06
1.6 HDi FAP	DV6TED4	31/05/04-24/10/06
1.6 HDi sans FAP	DV6TED4	-27/07/06
2.0i 16v.	EW10J4	-10/10
2.0i 16v.	EW10A EW10J4S	-27/07/06
2.0 HDi	DW10BTED4	-27/07/06

2650028

OE 5038F7

Support suspension G/D

L/R suspension mounting

1



1.4i 16v.	ET3J4	28/07/06-10/10
1.6i 16v.	TU5JP4	28/07/06-10/10
1.6i 16v.	EP6	-10/10
1.6i 16v. THP Susp. normale	EP6DT	-10/10
1.6 HDi Susp. normale	DV6ATED4	25/10/06-10/10
1.6 HDi Susp. renforcée AV AR	DV6ATED4	28/07/06-10/10
1.6 HDi	DV6C M	-10/10
1.6 HDi FAP	DV6TED4	25/10/06-10/10
1.6 HDi sans FAP	DV6TED4	28/07/06-10/10
1.6 HDi FAP Susp. normale	DV6TED4B	-10/10
2.0i 16v.	EW10A EW10J4S	28/07/06-10/10
2.0 HDi	DW10BTED4	28/07/06-10/10
2.0 HDi sans FAP	DW10ATED	-10/10

2650037

OE 5038G4

Support suspension G/D

L/R suspension mounting

1



1.4 VTi	EP3C	10/10-
1.6i 16v.	EP6C/G	10/10-
1.6i 16v.	TU5JP4	10/10-
1.6i 16v. THP	EP6CDT	10/10-
1.6i 16v. THP	EP6CDT M	10/10-
1.6i 16v. THP	EP6CDT MD	10/10-
1.6i 16v. THP	EP6CDTX	10/10-
1.6 HDi	DV6C	10/10-
1.6 HDi	DV6DTEd	10/10-
1.6 HDi	DV6DTEd M	10/10-
2.0i 16v.	EW10A	10/10-
2.0 HDi FAP /DTR	DW10CTED4	10/10-
2.0 HDi FAP DTR	DW10CB	10/10-

...C4...

0355275

Butée à billes G/D

OE 503563

L/R ball bearing

2



1.4i 16v.	ET3J4	-10/10
1.4i VTi	EP3C	10/10-
1.6i 16v.	TU5JP4	-10/10
1.6i 16v. Susp. normale	EP6	-10/10
1.6i 16v. /THP	EP6C /DT	10/10-
1.6i 16v. THP Susp. normale	EP6DT	-10/10
1.6 HDi	DV6ATED4 DV6TED4	-10/10
1.6 HDi 90hp 66kw Susp. normale	DV6TED4B	-10/10
1.6 HDi	DV6C /DTED	10/10-
2.0i 16v.	EW10J4 EW10J4S	-10/10
2.0i 16v.	EW10A	-10/10
2.0 HDi	DW10BTED4	-10/10
2.0 HDi	DW10CTED4	10/10-
2.0 HDi sans FAP	DW10ATED	-10/10

2650035

Coupelle amortisseur G/D

OE 503151

L/R shock absorber cup

6



1.4i 16v.	ET3J4	-10/10
1.4 VTi	EP3C	10/10-
1.6i 16v.	EP6 TU5JP4	-10/10
1.6i 16v.	EP6C EP6C G TU5JP4	10/10-
1.6i 16v. THP	EP6CDT EP6CDT M/MD EP6CDTX	10/10-
1.6i 16v. Turbo	EP6DT	-10/10
1.6 HDi	DV6ATED4 DV6C M DV6TED4	-10/10
1.6 HDi	DV6C DV6DTED DV6DTED M	10/10-
1.6 HDi FAP	DV6TED4B	-10/10
2.0i 16v.	EW10A EW10J4 EW10J4S	-10/10
2.0 HDi	DW10BTED4	-10/10
2.0 HDi FAP	DW10CTED4 DTR DW10CB DTR	10/10-
2.0 HDi Sans FAP	DW10ATED	-10/10

2650001

Butée de suspension G/D

OE 503370

L/R suspension bush

3 H96



1.4i 16v.	ET3J4	-10/10
1.4 VTi	EP3C	10/10-
1.6i 16v.	TU5JP4	-10/10
1.6i 16v. Susp. normale	EP6	
1.6i 16v. THP Susp. normale	EP6DT	-10/10
1.6i 16v. Turbo	EP6CDT	10/10-
1.6 HDi	DV6ATED4 DV6TED4	-10/10
1.6 HDi 90hp 66kw FAP Susp. normale	DV6TED4B	-10/10
1.6 HDi FAP	DV6C	10/10-
1.6 HDi FAP	DV6DTED	10/10-
1.6 HDi FAP	DV6DTED	10/10-
2.0i 16v.	EW10J4	-10/10
2.0i 16v. Susp. normale	EW10A	-10/10
2.0i 16v. Susp. renforcée AV AR	EW10A	-01/01/06
2.0 HDi	DW10BTED4	-10/10
2.0 HDi FAP	DW10CTED4	10/10-
2.0 HDi sans FAP	DW10ATED	-10/10

2650018

Butée de suspension G/D

OE 503385

L/R suspension bush

3 H86



2.0i 16v. Susp. renforcée AV AR	EW10A	02/01/06-13/05/07
2.0i 16v. EW10J4S		-04/03/07

2650024

Butée de suspension G/D

OE 5033C6

L/R suspension bush

3 H86



2.0i 16v. Susp. renforcée AV AR	EW10A	14/05/07-10/10
2.0i 16v. EW10J4S		05/03/07-10/10

...C4...



Support d'amortisseur
Suspension mounting
Soporte amortiguador
Poduszka amortyzatora
Опора амортизатора

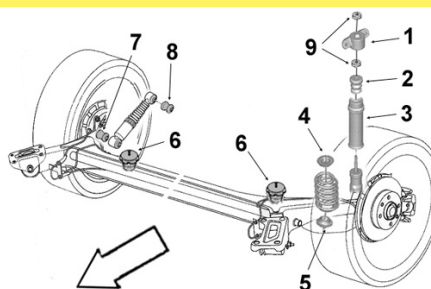

2650041

Protecteur amortisseur G/D

OE 525442

L/R shock absorber protector



2
3

1.4i 16v.	ET3J4	-10/10
1.4 VTi	EP3C	10/10-
1.6i 16v.	TU5JP4	
1.6i 16v.	EP6	-10/10
1.6i 16v.	EP6C/ G	10/10-
1.6i 16v. THP	EP6DT	-10/10
1.6i 16v. THP	EP6CDT/X/M/MD	10/10-
1.6 HDi	DV6A/TED4	-10/10
1.6 HDi	DV6C M	-10/10
1.6 HDi	DV6C DV6DTED DV6DTED M	10/10-
1.6 HDi FAP	DV6TED4B	-10/10
2.0i 16v.	EW10J4 EW10A	-10/10
2.0i 16v.	EW10A	10/10-
2.0i 16v.	EW10J4S	-10/10
2.0 HDi	DW10BTED4	-10/10
2.0 HDi FAP	DW10CTED4/DTR DW10CB DTR	10/10-
2.0 HDi sans FAP	DW10ATED	-10/10

Éléments TRAIN ARRIERE

Rear axle parts

Tren TRAS

Elementy zawieszenia tylnego

элементы задней оси.



2600001

Articulation traverse

OE 5131A4

Cross bar bush



Ø int. 16.8 Ø ext. 71.5 coll. 84 long. tube int. 82 ext. 60 ep. coll. 5

1.4i 16v.	ET3J4	-10/10
1.6i 16v. Susp. normale	TU5JP4	-10/10
1.6i 16v. Susp. renforcée AV AR	TU5JP4	03/01/05-10/10
1.6i 16v. /Turbo Susp. normale	EP6 EP6DT	-10/10
1.6 HDi	DV6ATED4	-10/10
1.6 HDi FAP	DV6TED4	-22/11/09
1.6 HDi sans FAP	DV6TED4	-10/10
1.6 HDi FAP 90hp 66kw Susp. normale	DV6TED4B	-10/10
2.0i 16v. Susp. normale	EW10A	-10/10
2.0i 16v. Susp. renforcée AV AR	EW10A	07/06/04-10/10
2.0i 16v.	EW10J4/S DW10BTED4	-10/10

2600011

Articulation essieu

OE 5131G4

Axle bush



Ø ext. 72 coll. 81 long. tube int. 83 ext. 60 ep. coll. 8.4

1.4 VTi	EP3C	10/10-
1.6i 16v. Susp. renforcée AV AR	TU5JP4	23/11/09-10/10
1.6i 16v.	EP6C/G TU5JP4	0/10-
1.6i 16v. THP	EP6CDT/M/MD EP6CDTX	10/10-
1.6 HDi	DV6C DV6DTED DV6DTED M	10/10-
1.6 HDi FAP	DV6TED4	23/11/09-10/10
2.0i 16v. Susp. renforcée AV AR	EW10A	23/11/09-10/10
2.0i 16v.	EW10A	10/10-
2.0 HDi FAP /DTR	DW10CTED4 DW10CB	10/10-
2.0 HDi sans FAP	DW10ATED	23/11/09-10/10

...C4

2600002

Articulation essieu

OE 5131A5

Axle bush



Ø int. 12.5 Ø ext. 72 coll. 83 long. tube int. 82 ext. 60 ep. coll.5

1.6i 16v. Susp. renforcée AV AR TU5JP4
2.0i 16v. Susp. renforcée AV AR EW10A
2.0 HDi sans FAP DW10ATED

08/01/07-22/11/09
08/01/07-22/11/09
-22/11/09

C4 Aircross...

Eléments DIRECTION

Steering parts

Elementos Direcciones

Elementy uklad kierowniczy

Элементы рулевой системы

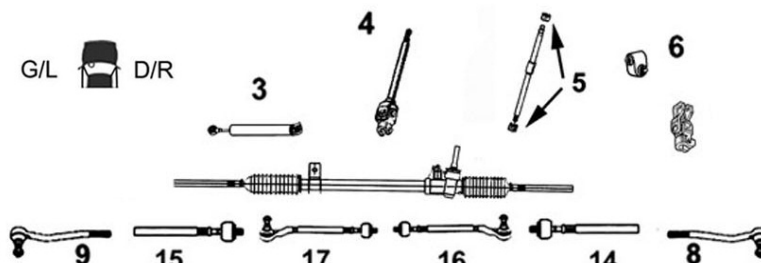

7770014

Axe de bielle G/D

Part/oe 1608532180

L/R axial joint

NEW



14 Côté dir. M14x1.5 Côté rot. M14x1.5 long 341 mm

1.6i 4A92
1.6 HDi DV6C
1.8 HDi 4N13
2.0i MMC

7670018

Rotule de direction G/D

OE 1607502480

L/R tie rod end

NEW



8 M14 x 1.5

1.6i 4A92
1.6 HDi DV6C
1.8 HDi 4N13
2.0i MMC



Barre stabilisatrice

Stabilizer bar

Barra estabilizadora

Drażek stabilizatora

стабилизатор поперечной устойчивости

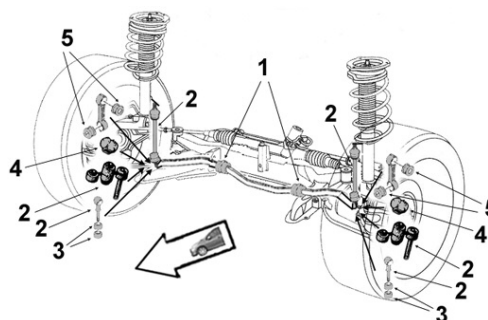

2300018

Biellette barre stab.

OE 508758

Stabilizer bar stub axle



2

1.6i 4WD 4A92
1.8 HDi 4WD 4N13

...C4 Aircross



Eléments SUSPENSION

Suspension parts
Elementos suspensión
Elementy zawieszenie
Элементы подвески

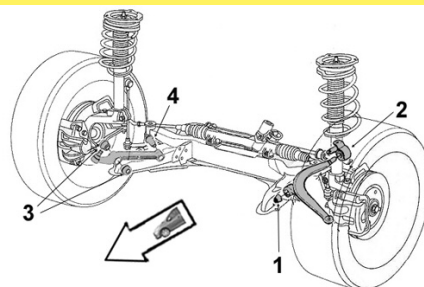

2250021

Articulation AR

OE 3523CS

Rear bush

NEW

2 Ø int.14.3 Ø ext.60 long. tube int.54 ext.27



1.6i
1.8 HDi

-24/09/12
-24/09/12



Support d'amortisseur

Suspension mounting
Soporte amortiguador
Poduszka amortyzatora
Опора амортизатора

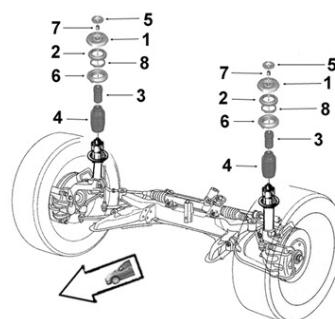

2650036

Support suspension

OE 5038F8

Suspension mounting

1 Sans roulement Without bearing



1.6i
1.6 HDi
1.8 HDi 2WD
1.8 HDi 4WD
2.0i

4A92
DV6C
4N13
4N13
MMC



Barre stabilisatrice

Stabilizer bar
Barra estabilizadora
Drażek stabilizatora
стабилизатор поперечной устойчивости

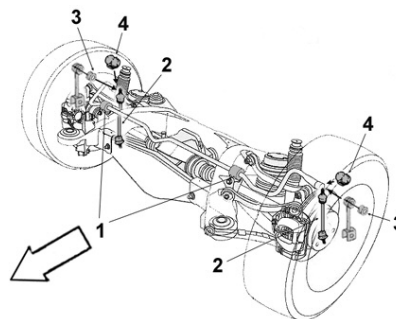

2300022

Biellette barre stab. G/D

OE 517849

L/R stabilizer bar stub axle

2



1.6i 4WD
1.8 HDi 4WD

4A92
N13

C4 Picasso -06/13...

Eléments DIRECTION

Steering parts

Elementos Direcciones

Elementy układ kierowniczy

Элементы рулевой системы

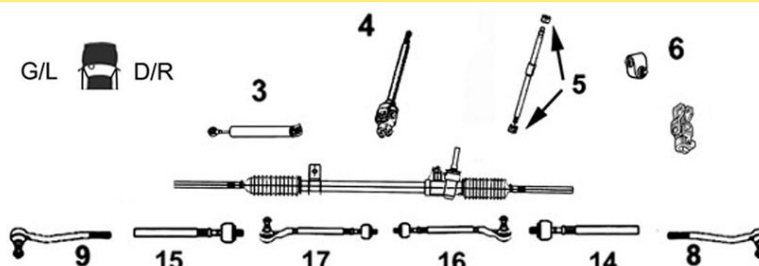

CITROEN



7770005

Axe de bielle G/D

OE 3812E9

L/R axial joint



14 Côté dir. M14x1.5 Côté rot. M16x1.5 long 314 mm

15

1.6i 16v.
1.6i 16v. THP
1.6 HDi
1.8i 16v.
2.0i 16v.
2.0 HDi FAP

7670013

Rotule de direction G

OE 381771

Left tie rod end



9 M16 x 1.5

1.6i 16v.
1.6i 16v. THP
1.6 HDi
1.8i 16v.
2.0i 16v.
2.0 HDi FAP

7670012

Rotule de direction D

OE 381772

Right tie rod end



8 M16 x 1.5

1.6i 16v.
1.6i 16v. THP
1.6 HDi
1.8i 16v.
2.0i 16v.
2.0 HDi FAP



Barre stabilisatrice

Stabilizer bar

Barra estabilizadora

Drażek stabilizatora

стабилизатор поперечной устойчивости

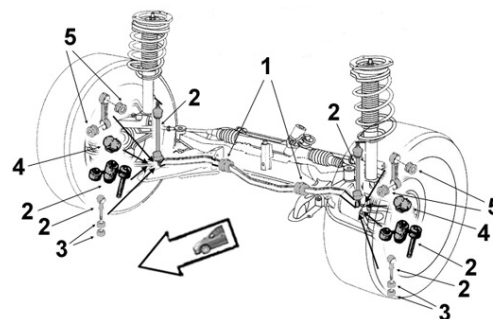

2300030

Biellette barre stab.

OE 508757

Stabilizer bar stub axle



2

1.6i 16v.
1.6i 16v. THP
1.6 HDi
1.8i 16v.
2.0i 16v.
2.0 HDi FAP

0945885

Palier de barre milieu

OE 5094E0

Middle bar main bearing



1 Barre Ø 22

1.6i 16v. Turbo	EP6DT EP6CDT
1.6i Turbo	EP6
1.6 HDi	DV6TED4
1.8i 16v.	EW7A
2.0i 16v.	EW10A
2.0 HDi FAP	DW10BTED4
2.0 HDi FAP	DW10CTED4

2300027

Palier de barre milieu

OE 5094E2

Middle bar main bearing



1 Barre Ø 22.5

1.6i 16v.	EP6DT
1.6i Turbo	EP6 EP6CDT
1.6 HDi	DV6TED4
1.8i 16v.	EW7A
2.0i 16v.	EW10A
2.0 HDi FAP	DW10BTED4
2.0 HDi FAP	DW10CTED4

0945895

Palier de barre milieu

OE 5094E3

Middle bar main bearing



1 Barre Ø 23

1.6i 16v. Turbo	EP6DT
1.6i Turbo	EP6CDT
1.6 HDi	DV6TED4
1.8i 16v.	EW7A
2.0i 16v.	EW10A
2.0 HDi FAP	DW10BTED4
2.0 HDi FAP	DW10CTED4

...C4 Picasso -06/13...



Eléments SUSPENSION

Suspension parts
Elementos suspensión
Elementy zawieszenie
Элементы подвески

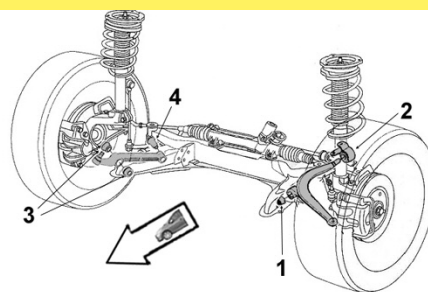

CITROEN



5233913

OE 352391

Articulation AV

Front bush

1 Ø int.14 Ø ext.55 long. tube int.56 ext.32

1.6i Turbo	EP6 EP6CDT	
1.6i 16v. Turbo	EP6DT	
1.6 HDi FAP	DV6C	
1.6 HDi	DV6TED4	
1.8i 16v.	EW7A	BVM
2.0i 16v.	EW10A	
2.0 HDi FAP	DW10B/CTED4	



5233923

OE 352392

Articulation AR

Rear bush

2 Ø int.14 Ø ext.55 coll.62
long. tube int.49 ext.25 ep. coll.3

1.6i Turbo	EP6 EP6CDT	
1.6i 16v. Turbo	EP6DT	
1.6 HDi FAP	DV6C	
1.6 HDi	DV6TED4	
1.8i 16v.	EW7A	BVM
2.0i 16v.	EW10A	
2.0 HDi FAP	DW10B/CTED4	



Bras & Triangle de suspension

Control arm
Brazo y triángulo
Wahacz
Рычаг подвески

G/L D/R

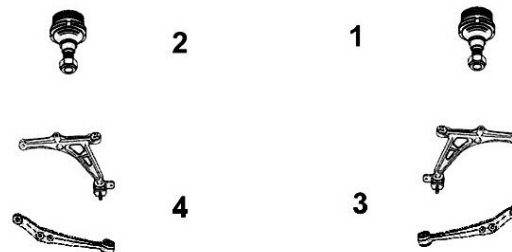

5203K83

OE 3520S2

Triangle de susp. inf. G

Lower left track control arm

4 Sans rotule Without tie rod end

1.6i 16v.
1.6i 16v. THP
1.6 HDi
1.8i 16v.
2.0i 16v.
2.0 HDi FAP



5213G83

OE 3521P3

Triangle de susp. inf. D

Lower right track control arm

3 Sans rotule Without tie rod end

1.6i 16v.
1.6i 16v. THP
1.6 HDi
1.8i 16v.
2.0i 16v.
2.0 HDi FAP



6403533

OE 364068

Rotule de susp. inf. G/D

L/R lower suspension ball joint

1
2

1.6i 16v.
1.6i 16v. THP
1.6 HDi
1.8i 16v.
2.0i 16v.
2.0 HDi FAP



...C4 Picasso -06/13





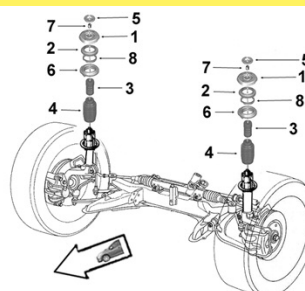

Support d'amortisseur
 Suspension mounting
 Soporte amortiguador
 Poduszka amortyzatora
 Опора амортизатора



CITROËN



<p>2650038 OE 503375</p> 	<p>Coupelle rebond. <i>Spring cup</i></p> <p>5</p> <p>1.6i 16v. 1.6i 16v. THP 1.6 HDi 1.8i 16v. 2.0i 16v. 2.0 HDi FAP</p>	<p>0385855 OE 5038G0</p> 	<p>Support suspension G/D <i>L/R suspension mounting</i></p> <p>1</p> <p>1.6i 16v. THP EP6DT Susp. normale 1.6i 16v. EP6C -09/12 1.6i 16v. THP EP6CDT -09/12 1.6i Turbo EP6 Susp. normale 1.6 HDi DV6C -09/12 1.6 HDi DV6TED4 1.8i 16v. EW7A Susp. normale 2.0i 16v. EW10A -09/12 2.0 HDi FAP DW10BTED4 2.0 HDi FAP DW10CTED4 -09/12</p>				
<p>0355275 OE 503563</p> 	<p>Butée à billes G/D <i>L/R ball bearing</i></p> <p>2</p> <p>1.6i 16v. 1.6i 16v. THP 1.6 HDi 1.8i 16v. 2.0i 16v. 2.0 HDi FAP</p>	<p>2650035 OE 503151</p> 	<p>Coupelle amortisseur G/D <i>L/R shock absorber cup</i></p> <p>6</p> <p>1.6i 16v. 1.6i 16v. THP 1.6 HDi 1.8i 16v. 2.0i 16v. 2.0 HDi FAP</p>				
<p>2650001 OE 503370</p> <p>Butée de suspension G/D <i>L/R suspension bush</i></p> <p>3</p> <table border="0" style="width: 100%;"> <tr> <td style="vertical-align: top;">  </td> <td style="vertical-align: top;"> <p>H96</p> <p>1.6i 16v. 1.6i 16v. THP 1.6i 16v. THP 1.6i Turbo 1.6 HDi 1.8i 16v. 2.0i 16v. 2.0 HDi FAP 2.0 HDi FAP</p> </td> <td style="vertical-align: top;"> <p>Susp. normale Susp. normale Susp. normale Susp. normale Susp. normale Susp. normale</p> </td> <td style="vertical-align: top;"> <p>EP6C EP6DT EP6CDT EP6 DV6C DV6TED4 EW7A EW10A DW10BTED4 DW10CTED4</p> </td> </tr> </table>					<p>H96</p> <p>1.6i 16v. 1.6i 16v. THP 1.6i 16v. THP 1.6i Turbo 1.6 HDi 1.8i 16v. 2.0i 16v. 2.0 HDi FAP 2.0 HDi FAP</p>	<p>Susp. normale Susp. normale Susp. normale Susp. normale Susp. normale Susp. normale</p>	<p>EP6C EP6DT EP6CDT EP6 DV6C DV6TED4 EW7A EW10A DW10BTED4 DW10CTED4</p>
	<p>H96</p> <p>1.6i 16v. 1.6i 16v. THP 1.6i 16v. THP 1.6i Turbo 1.6 HDi 1.8i 16v. 2.0i 16v. 2.0 HDi FAP 2.0 HDi FAP</p>	<p>Susp. normale Susp. normale Susp. normale Susp. normale Susp. normale Susp. normale</p>	<p>EP6C EP6DT EP6CDT EP6 DV6C DV6TED4 EW7A EW10A DW10BTED4 DW10CTED4</p>				
<p>Eléments TRAIN ARRIERE <i>Rear axle parts</i> <i>Tren TRAS</i> <i>Elementy zawieszenia tylnego</i> <i>элементы задней оси.</i></p> 		<p>2600004 OE 5131F2</p> 	<p>Articulation essieu <i>Axle bush</i></p> <p>Ø int. 14 Ø ext. 80 coll. 87 long. tube int. 79 ext. 59 ep. coll.7</p> <p>Susp. normale</p> <p>1.6i 16v. EP6/DT 1.6 HDi DV6TED4 1.8i 16v. EW7A 2.0i 16v. EW10A 2.0 HDi FAP DW10B/CTED4</p>				
<p>2600005 OE 5131K0</p> 		<p>Articulation essieu <i>Axle bush</i></p> <p>Ø int. 14 Ø ext. 81 coll. 97 long. tube int. 79 ext. 54 ep. coll.8</p> <table border="0" style="width: 100%;"> <tr> <td style="vertical-align: top;"> <p>1.6i 16v. 1.6i 16v. 1.6i 16v. 1.6 HDi 1.6 HDi FAP 1.8i 16v. 2.0i 16v. 2.0 HDi FAP 2.0 HDi FAP</p> </td> <td style="vertical-align: top;"> <p>Susp. métallique Susp. métallique renforcée AV AR Susp. métallique AV Pneumatique AR renforcée AV AR Susp. métallique renforcée AV AR Susp. métallique renforcée AV AR Susp. métallique renforcée AV AR Susp. métallique AV Pneumatique AR renforcée AV AR Susp. métallique renforcée AV AR</p> </td> <td style="vertical-align: top;"> <p>EP6C EP6CDT EP6/DT DV6C DV6TED4 EW7A EW10A DW10CTED4 DW10BTED4</p> </td> </tr> </table>		<p>1.6i 16v. 1.6i 16v. 1.6i 16v. 1.6 HDi 1.6 HDi FAP 1.8i 16v. 2.0i 16v. 2.0 HDi FAP 2.0 HDi FAP</p>	<p>Susp. métallique Susp. métallique renforcée AV AR Susp. métallique AV Pneumatique AR renforcée AV AR Susp. métallique renforcée AV AR Susp. métallique renforcée AV AR Susp. métallique renforcée AV AR Susp. métallique AV Pneumatique AR renforcée AV AR Susp. métallique renforcée AV AR</p>	<p>EP6C EP6CDT EP6/DT DV6C DV6TED4 EW7A EW10A DW10CTED4 DW10BTED4</p>	
<p>1.6i 16v. 1.6i 16v. 1.6i 16v. 1.6 HDi 1.6 HDi FAP 1.8i 16v. 2.0i 16v. 2.0 HDi FAP 2.0 HDi FAP</p>	<p>Susp. métallique Susp. métallique renforcée AV AR Susp. métallique AV Pneumatique AR renforcée AV AR Susp. métallique renforcée AV AR Susp. métallique renforcée AV AR Susp. métallique renforcée AV AR Susp. métallique AV Pneumatique AR renforcée AV AR Susp. métallique renforcée AV AR</p>	<p>EP6C EP6CDT EP6/DT DV6C DV6TED4 EW7A EW10A DW10CTED4 DW10BTED4</p>					

C4 Picasso 06/13-

Eléments DIRECTION

Steering parts

Elementos Direcciones

Elementy układ kierowniczy

Элементы рулевой системы

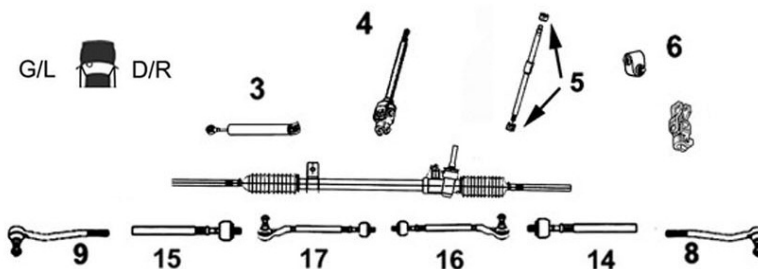

7670019

Rotule de direction G

OE 1610817780

Left tie rod end

NEW



9

M14 x 1.5

1.6i 16v.	EP6C
1.6i 16v. THP	EP6CDT
1.6 HDi	DV6C
1.6 HDi	DV6DTED
2.0 HDi FAP	DW10FD

7670021

Rotule de direction D

OE 1610817880

Right tie rod end

NEW



8

M14 x 1.5

1.6i 16v.	EP6C
1.6i 16v. THP	EP6CDT
1.6 HDi	DV6C
1.6 HDi	DV6DTED
2.0 HDi FAP	DW10FD

C5 ...

Eléments DIRECTION

Steering parts

Elementos Direcciones

Elementy układ kierowniczy

Элементы рулевой системы

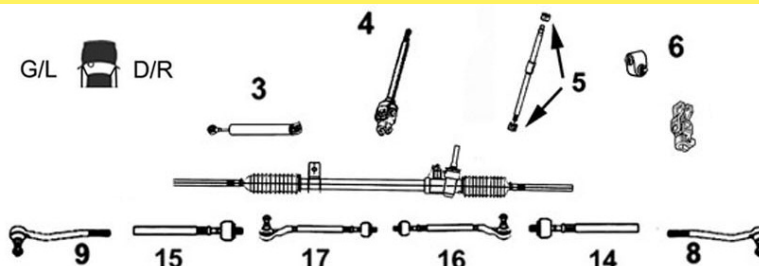

3008079

Axe de bielle G/D

Part/oe3812C8

L/R axial joint



14

15

Côté dir. M16x1.5	Côté rot. M16x1.5	long 183 mm	
1.6 HDi	DV6TED4		09/04-02/08
1.8i 16v.	EW7J4		-02/08
1.8i 16v.	EW7A		09/04-02/08
2.0i 16v.	EW10J4 EW10A		-02/08
2.0 HDi	DW10 DW10BTED4		-02/08
2.0 HPi	EW10D		-08/04
2.2 HDi	DW12TED4		-02/08
2.2 HDi FAP	DW12BTED4		09/04-02/08
3.0i V6	ES9J4S		-08/04
3.0i V6	ES9A		09/04-02/08

7770006

Axe de bielle G/D

Part/oe3812F3

L/R axial joint



14

15

Côté dir. M16x1.5	Côté rot. M14x1.5	long 129 mm	
1.6i 16v. THP	EP6CDT / M		03/08-
1.6 VTi 16v.	EP6C		03/08-
1.6 HDi	DV6C		03/08-
1.6 HDi FAP	DV6TED4		03/08-
1.8i 16v.	EW7A		03/08-
2.0i 16v.	EW10A		03/08-
2.0 HDi	DW10BTED4		03/08-
2.0 HDi FAP	DW10CTED4		03/08-
2.2 HDi FAP	DW12BTED4 DW12C		03/08-
2.7 HDi	DT17TED4		03/08-
3.0i V6	ES9A		03/08-
3.0 HDi	DT20C		03/08-

8173533

Rotule de direction G

OE 381759

Left tie rod end



9

1.6 HDi	DV6TED4	09/04-02/08
1.8i 16v.	EW7A	09/04-02/08
1.8i 16v.	EW7J4	-02/08
2.0i 16v.	EW10J4	-08/04
2.0i 16v.	EW10A	09/04-02/08
2.0 HDi	DW10	-08/04
2.0 HDi	DW10BTED4	09/04-02/08
2.0 HPi	EW10D	-08/04
2.2 HDi	DW12TED4	-02/08
2.2 HDi FAP	DW12BTED4	09/04-02/08
3.0i V6	ES9J4S ES9A	-02/08

8173543

Rotule de direction D

OE 381760

Right tie rod end



8

1.6 HDi	DV6TED4	09/04-02/08
1.8i 16v.	EW7A	09/04-02/08
1.8i 16v.	EW7J4	-02/08
2.0i 16v.	EW10J4	-08/04
2.0i 16v.	EW10A	09/04-02/08
2.0 HDi	DW10	-08/04
2.0 HDi	DW10BTED4	09/04-02/08
2.0 HPi	EW10D	-08/04
2.2 HDi	DW12TED4	-02/08
2.2 HDi FAP	DW12BTED4	09/04-02/08
3.0i V6	ES9J4S ES9A	-02/08

...C5...

7670015 Rotule de direction G

OE 1609948280 *Left tie rod end*



9 M14 x 1.5

1.6i 16v. THP	EP6CDT /M	03/08-
1.6 VTi 16v.	EP6C	03/08-
1.6 HDi	DV6C	03/08-
1.6 HDi FAP	DV6TED4	03/08-
1.8i 16v.	EW7A	03/08-
2.0i 16v.	EW10A	03/08-
2.0 HDi	DW10B/0CTED4	03/08-
2.2 HDi FAP	DW12BTED4 DW12C	03/08-
2.7 HDi	DT17TED4	03/08-
3.0i V6	ES9A	03/08-
3.0 HDi	DT20C	03/08-

7670014 Rotule de direction D

OE 1609948380 *Right tie rod end*



8 M14 x 1.5

1.6i 16v. THP	EP6CDT /M	03/08-
1.6 VTi 16v.	EP6C	03/08-
1.6 HDi	DV6C	03/08-
1.6 HDi FAP	DV6TED4	03/08-
1.8i 16v.	EW7A	03/08-
2.0i 16v.	EW10A	03/08-
2.0 HDi	DW10B/0CTED4	03/08-
2.2 HDi FAP	DW12BTED4 DW12C	03/08-
2.7 HDi	DT17TED4	03/08-
3.0i V6	ES9A	03/08-
3.0 HDi	DT20C	03/08-



Barre stabilisatrice

Stabilizer bar

Barra estabilizadora

Drażek stabilizatora

стабилизатор поперечной устойчивости

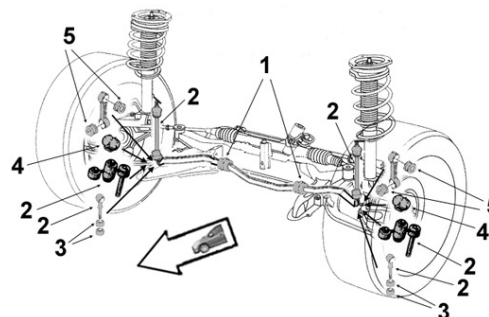

0875485 Bielle barre stab.

OE 508760 *Stabilizer bar stub axle*



2 M12 x 175

1.6 HDi	DV6TED4	-02/08
1.8i 16v.	EW7J4 /A	-02/08
2.0i 16v.	EW10	-02/08
2.0 HDi	DW10TD/ATED/BTED4	-02/08
2.0 HPi	EW10D	-02/08
2.2 HDi	DW12TED4/BTED4	-02/08
3.0i V6	ES9J4S /9A	-02/08

2300011 Bielle barre stab. G

OE 508752 *Left stabilizer bar stub axle*



2	1.6i 16v.	EP6CDT	03/08-
	1.6 HDi FAP	DV6TED4	03/08-
	1.6 HDi FAP	DV6C	03/10-
	1.8i 16v.	EW7A	03/08-
	2.0i 16v.	EW10A	03/08-
	2.0 HDi FAP	DW10BCTED4	03/08-
	2.2 HDi FAP	DW12BTED4	03/08-
	2.7 HDi	DT17TED4	03/08-
	3.0i V6	ES9A	03/08-
	3.0 HDi	DT20C	03/08-

2300009 Bielle barre stab. D

OE 508753 *Right stabilizer bar stub axle*



2	1.6i 16v.	EP6CDT	03/08-
	1.6 HDi FAP	DV6TED4	03/08-
	1.6 HDi FAP	DV6C	03/10-
	1.8i 16v.	EW7A	03/08-
	2.0i 16v.	EW10A	03/08-
	2.0 HDi FAP	DW10BCTED4	03/08-
	2.2 HDi FAP	DW12BTED4	03/08-
	2.7 HDi	DT17TED4	03/08-
	3.0i V6	ES9A	03/08-
	3.0 HDi	DT20C	03/08-

...C5...



CITROEN



Barre stabilisatrice
 Stabilizer bar
 Barra estabilizadora
 Drążek stabilizatora
 стабилизатор поперечной устойчивости

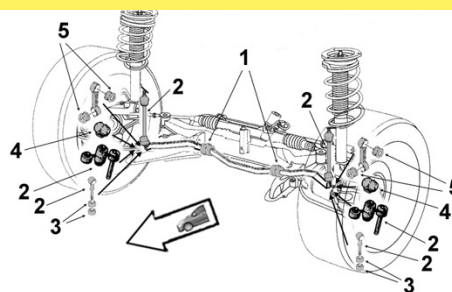

0945835

OE 509483

Palier de barre milieu

Middle bar main bearing



1 Barre Ø 23.5

TT /all models Berline 5ptes sauf 3.0 V6 Mot. ES9J4S -02/08

TT /all models SW 5ptes -02/08

2300023

OE 509498

Palier de barre milieu

Middle bar main bearing

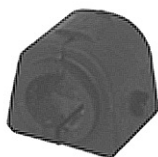

1 Barre Ø 23.5

1.6i 16v. THP	EP6CDT	03/08-
1.6 VTi	EP6C	03/08-
1.6 HDi	DV6C	03/08-
1.6 HDi FAP	DV6TED4	03/08-
1.8i 16v.	EW7A	03/08-
2.0i 16v.	EW10A	03/08-
2.0 HDi	DW10B/CTED4	03/08-
2.2 HDi FAP	DW12BTED4 DW12C	03/08-
2.7 HDi	DT17TED4	03/08-
3.0i V6	ES9A	03/08-
3.0 HDi	DT20C	03/08-

2300004

OE 509499

Palier de barre milieu

Middle bar main bearing



1 Barre Ø 24

1.6i 16v. THP	EP6CDT	03/08-
1.6 VTi	EP6C	03/08-
1.6 HDi	DV6C	03/08-
1.6 HDi FAP	DV6TED4	03/08-
1.8i 16v.	EW7A	03/08-
2.0i 16v.	EW10A	03/08-
2.0 HDi	DW10BTED4	03/08-
2.0 HDi FAP	DW10CTED4	03/08-
2.2 HDi FAP	DW12BTED4 DW12C	03/08-
2.7 HDi	DT17TED4	03/08-
3.0i V6	ES9A	03/08-
3.0 HDi	DT20C	03/08-

2300024

OE 5094A0

Palier de barre milieu

Middle bar main bearing

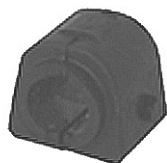

1 Barre Ø 24.5

1.6i 16v. THP	EP6CDT	03/08-
1.6 VTi	EP6C	03/08-
1.6 HDi	DV6C	03/08-
1.6 HDi FAP	DV6TED4	03/08-
1.8i 16v.	EW7A	03/08-
2.0i 16v.	EW10A	03/08-
2.0 HDi	DW10BTED4	03/08-
2.0 HDi FAP	DW10CTED4	03/08-
2.2 HDi FAP	DW12BTED4 DW12C	03/08-
2.7 HDi	DT17TED4	03/08-
3.0i V6	ES9A	03/08-
3.0 HDi	DT20C	03/08-

...C5...

2300008

Palier de barre milieu

OE 5094A1

Middle bar main bearing



1	Barre Ø 25		
	1.6i 16v. THP	EP6CDT	03/08-
	1.6 VTi	EP6C	03/08-
	1.6 HDi	DV6C	03/08-
	1.6 HDi FAP	DV6TED4	03/08-
	1.8i 16v.	EW7A	03/08-
	2.0i 16v.	EW10A	03/08-
	2.0 HDi	DW10BTED4	03/08-
	2.0 HDi FAP	DW10CTED4	03/08-
	2.2 HDi FAP	DW12BTED4 DW12C	03/08-
	2.7 HDi	DT17TED4	03/08-
	3.0i V6	ES9A	03/08-
	3.0 HDi	DT20C	03/08-

0945905

Palier de barre milieu

OE 509490

Middle bar main bearing



1	Barre Ø 24.5		
	2.2 HDi Fap Break	DW12BTED4	09/04-02/08
	3.0i V6 Berline 5ptes	ES9J4S	-08/04
	3.0i V6 Break	ES9A	09/04-02/08



Eléments SUSPENSION

Suspension parts

Elementos suspensión

Elementy zawieszenie

Элементы подвески

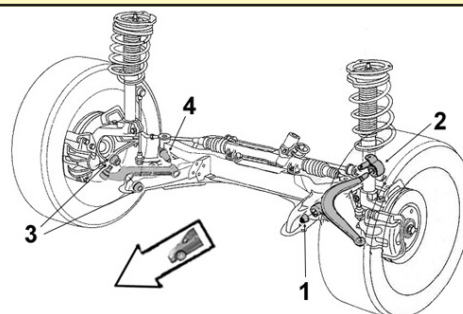

2250019

Art. bras sup.

OE 3523CA

Upper arm bush



1	Ø int.10.3 Ø ext. 32 coll. 39 long. tube int. 34 ext. 22 ep. coll.6.2		
2			
	1.6i 16v. THP	EP6CDT/ M	03/08-
	1.6 VTi 16v.	EP6C	03/08-
	1.6 HDi	DV6C	03/08-
	1.6 HDi FAP	DV6TED4	03/08-
	1.8i 16v.	EW7A	03/08-
	2.0i 16v.	EW10A	03/08-
	2.0 HDi	DW10BTED4	03/08-
	2.0 HDi FAP	DW10CTED4	03/08-
	2.2 HDi FAP	DW12BTED4	03/08-
	2.2 HDi FAP	DW12C	03/08-
	2.7 HDi	DT17TED4	03/08-
	3.0i V6	ES9A	03/08-
	3.0 HDi	DT20C	03/08-

...C5...



Eléments SUSPENSION

Suspension parts

Elementos suspensión

Elementy zawieszenie

Элементы подвески

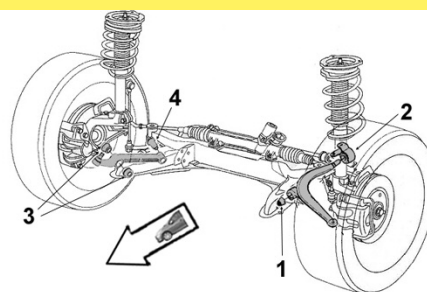

CITROËN

SASIC

2250014

OE 3523AZ

Art. sup. support pivot

pivot mounting upper bush

Ø int. 12 Ø ext. 33 coll. 40 long. tube int. 82 ext. 21.5 ep. coll.6.3



1.6i 16v. THP	EP6CDT/M	03/08-
1.6i VTi 16v.	EP6C	03/08-
1.6 HDi	DV6C	03/08-
1.6 HDi FAP	DV6TED4	03/08-
1.8i 16v.	EW7A	03/08-
2.0i 16v.	EW10A	03/08-
2.0 HDi	DW10BTED4	03/08-
2.0 HDi FAP	DW10CTED4	03/08-
2.2 HDi FAP	DW12BTED4	03/08-
2.2 HDi FAP	DW12C	03/08-
2.7 HDi	DT17TED4	03/08-
3.0i V6	ES9A	03/08-
3.0 HDi	DT20C	03/08-

2250013

Part/oe 365604

Art. inf. support pivot

lower bush pivot mounting

Ø int. 12 Ø ext. 40 coll. 45.4 long. tube int. 38 ext. 27 ep. coll.2.3



1.6i 16v. THP	EP6CDT/M	03/08-
1.6i VTi 16v.	EP6C	03/08-
1.6 HDi	DV6C	03/08-
1.6 HDi FAP	DV6TED4	03/08-
1.8i 16v.	EW7A	03/08-
2.0i 16v.	EW10A	03/08-
2.0 HDi	DW10BTED4	03/08-
2.0 HDi FAP	DW10CTED4	03/08-
2.2 HDi FAP	DW12BTED4	03/08-
2.2 HDi FAP	DW12C	03/08-
2.7 HDi	DT17TED4	03/08-
3.0i V6	ES9A	03/08-
3.0 HDi	DT20C	03/08-

5233843

OE 352384

Articulation AV triangle inf.

Lower front track control arm front bush

1 Ø int.14 Ø ext. 40 coll.49 long. tube int.38 ext.24 ep. coll.7



1.6 HDi	DV6TED4	09/04-02/08
1.8i 16v.	EW7J4	-08/04
1.8i 16v.	EW7J4	09/04-02/08
1.8i 16v.	EW7A	09/04-02/08
2.0i 16v.	EW10J4	-08/04
2.0i 16v.	EW10A	09/04-02/08
2.0 HDi	DW10TD/ATED	-08/04
2.0 HDi	DW10BTED4	09/04-02/08
2.0 HPi	EW10D	-08/04
2.2 HDi	DW12TED4	-08/04
2.2 HDi	DW12TED4	09/04-02/08
2.2 HDi FAP	DW12BTED4	09/04-02/08
3.0i V6	ES9J4S	-08/04
3.0i V6	ES9A	09/04-02/08

...C5...

2250002

Articulation AV triangle inf.

OE 3523AQ

Lower front track control arm front bush

1 Ø int.14 Ø ext.56 long. tube int.32 ext 50



1.6i Turbo	EP6CDT	03/08-
1.6 HDi FAP	DV6C /TED4	03/08-
1.8i 16v.	EW7A	03/08-
2.0i 16v.	EW10A	03/08-
2.0 HDi	DW10BTED4	03/08-
2.0 HDi FAP	DW10CTED4	03/08-
2.2 HDi FAP	DW12BTED4	03/08-
2.7 HDi	DT17TED4	03/08-
3.0i V6	ES9A	03/08-
3.0 HDi	DT20C	03/08-

5233AR3

Articulation AR triangle inf.

OE 352395 3523AR

Track control arm rear bush

2 Ø int.18

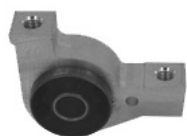

1.6 HDi	DV6TED4	09/04-02/08
1.8i 16v.	EW7A	09/04-02/08
1.8i 16v.	EW7J4	-02/08
2.0i 16v.	EW10A	09/04-02/08
2.0i 16v.	EW10J4	-08/04
2.0 HDi	DW10TD/ATED	-08/04
2.0 HDi	DW10BTED4	09/04-02/08
2.0 HPi	EW10D	-08/04
2.2 HDi	DW12BTED4	09/04-02/08
2.2 HDi	DW12TED4	-02/08
3.0i V6	ES9J4S	-08/04
3.0i V6	ES9A	09/04-02/08

Bras & Triangle de suspension

Control arm
Brazo y triángulo
Wahacz
Рычаг подвески

G/L  D/R

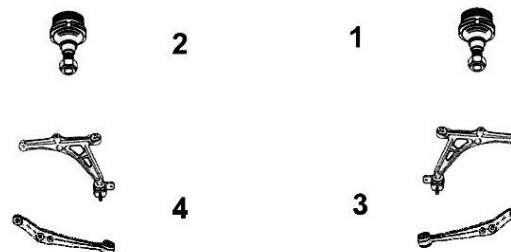

5203K33

Triangle de susp. G

OE 3520K3 / 3520P0

Left track control arm

4 Sans rotule Without ball joint



1.6 HDi	DV6TED4	09/04-02/08
1.8i 16v.	EW7A	09/04-02/08
1.8i 16v.	EW7J4	-02/08
2.0i 16v.	EW10J4	-08/04
2.0i 16v.	EW10A	09/04-02/08
2.0 HDi	DW10	-08/04
2.0 HDi	DW10BTED4	09/04-02/08
2.0 HPi	EW10D	-08/04
2.2 HDi	DW12TED4	-02/08
2.2 HDi FAP	DW12BTED4	09/04-02/08
3.0i V6	ES9J4S	-08/04
3.0i V6	ES9A	09/04-02/08

...C5...

SASIC

CITROEN

Bras & Triangle de suspension

Control arm
Brazo y triángulo
Wahacz
Рычаг подвески

G/L  D/R

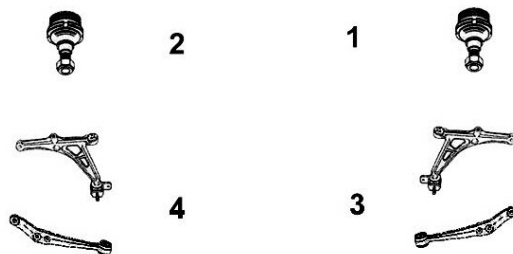

5213G33

Triangle de susp. D

OE 3521G3 / 3521K0 Right track control arm



3 Sans rotule Without ball joint

1.6 HDi	DV6TED4	09/04-02/08
1.8i 16v.	EW7A	09/04-02/08
1.8i 16v.	EW7J4	-02/08
2.0i 16v.	EW10J4	-08/04
2.0i 16v.	EW10A	09/04-02/08
2.0 HDi	DW10	-08/04
2.0 HDi	DW10BTED4	09/04-02/08
2.0 HPi	EW10D	-08/04
2.2 HDi	DW12TED4	-02/08
2.2 HDi FAP	DW12BTED4	09/04-02/08
3.0i V6	ES9J4S	-08/04
3.0i V6	ES9A	09/04-02/08

5203N63

Triangle de susp. inf. G

OE 3520W1 Lower left track control arm



4 Sans rotule Without ball joint

Sans susp. hydraulique et susp. métallique

1.6i 16v. THP	EP6CDT /M	03/08-30/08/09
1.6 HDi	DV6C	03/08-30/08/09
1.6 HDi FAP	DV6TED4	03/08-30/08/09
1.8i 16v.	EW7A	03/08-30/08/09
2.0i 16v.	EW10A	03/08-30/08/09
2.0 HDi	DW10BTED4	03/08-30/08/09
2.0 HDi FAP	DW10CTED4	03/08-30/08/09
2.2 HDi FAP	DW12BTED4	03/08-30/08/09
2.2 HDi FAP	DW12C	03/08-30/08/09
2.7 HDi	DT17TED4	03/08-30/08/09
3.0i V6	ES9A	03/08-30/08/09
3.0 HDi	DT20C	03/08-30/08/09

Berceau alu avec cadre Sans susp. hydraulique et susp. métallique

1.6i 16v. THP	EP6CDT /M	31/08/09-
1.6 VTi 16v.	EP6C	31/08/09-
1.6 HDi	DV6C	31/08/09-
1.6 HDi FAP	DV6TED4	31/08/09-
1.8i 16v.	EW7A	31/08/09-
2.0i 16v.	EW10A	31/08/09-
2.0 HDi	DW10BTED4	31/08/09-
2.0 HDi FAP	DW10CTED4	31/08/09-
2.2 HDi FAP	DW12BTED4	31/08/09-
2.2 HDi FAP	DW12C	31/08/09-
2.7 HDi	DT17TED4	31/08/09-
3.0i V6	ES9A	31/08/09-
3.0 HDi	DT20C	31/08/09-

5213J63

Triangle de susp. inf. D...

OE 3521S4 Lower right track control arm







3 Sans rotule Without ball joint

Sans susp. hydraulique et susp. métallique

1.6i 16v. THP	EP6CDT /M	03/08-30/08/09
1.6 HDi	DV6C	03/08-30/08/09
1.6 HDi FAP	DV6TED4	03/08-30/08/09
1.8i 16v.	EW7A	03/08-30/08/09
2.0i 16v.	EW10A	03/08-30/08/09
2.0 HDi	DW10BTED4	03/08-30/08/09
2.0 HDi FAP	DW10CTED4	03/08-30/08/09
2.2 HDi FAP	DW12BTED4	03/08-30/08/09
2.2 HDi FAP	DW12C	03/08-30/08/09
2.7 HDi	DT17TED4	03/08-30/08/09
3.0i V6	ES9A	03/08-30/08/09
3.0 HDi	DT20C	03/08-30/08/09

Suite ...

...C5...

...C5...					
5213J63 ...Triangle de susp. inf. D					
OE 3521S4 <i>Lower right track control arm</i>					
	3	Sans rotule <i>Without ball joint</i> Berceau alu avec cadre Sans susp. hydractive et susp. métallique			
		1.6i 16v. THP	EP6CDT /M	31/08/09-	
		1.6 VTi 16v.	EP6C	31/08/09-	
		1.6 HDi	DV6C	31/08/09-	
		1.6 HDi FAP	DV6TED4	31/08/09-	
		1.8i 16v.	EW7A	31/08/09-	
		2.0i 16v.	EW10A	31/08/09-	
		2.0 HDi	DW10BTED4	31/08/09-	
		2.0 HDi FAP	DW10CTED4	31/08/09-	
		2.2 HDi FAP	DW12BTED4 DW12C	31/08/09-	
		2.7 HDi	DT17TED4	31/08/09-	
		3.0i V6	ES9A	31/08/09-	
3.0 HDi	DT20C	31/08/09-			
7470028 Triangle de susp. inf. G					
OE 3520X6 <i>Lower left track control arm</i>					
	4	Sans rotule <i>Without ball joint</i> Berceau acier avec cadre			
		1.6i 16v. THP		31/08/09-	
		1.6i VTi 16v.		31/08/09-	
		1.6 HDi FAP		31/08/09-	
		1.8i 16v.		31/08/09-	
		2.0i 16v. /ETH		31/08/09-	
		2.0 HDi FAP		31/08/09-	
		2.2 HDi FAP		31/08/09-	
		2.7 HDi FAP		31/08/09-	
		3.0i V6 24v.		31/08/09-	
		3.0 HDi /FAP		31/08/09-	
		7470027 Triangle de susp. inf. D			
OE 3521T7 <i>Lower right track control arm</i>					
	3	Sans rotule <i>Without ball joint</i> Berceau acier avec cadre			
		1.6i 16v. THP		31/08/09-	
		1.6i VTi 16v.		31/08/09-	
		1.6 HDi FAP		31/08/09-	
		1.8i 16v.		31/08/09-	
		2.0i 16v. /ETH		31/08/09-	
		2.0 HDi FAP		31/08/09-	
		2.2 HDi FAP		31/08/09-	
		2.7 HDi FAP		31/08/09-	
		3.0i V6 24v.		31/08/09-	
		3.0 HDi /FAP		31/08/09-	
		6403573 Rotule de susp. sup. G/D			
OE 364074 <i>L/R upper susp. ball joint</i>					
	1	1.6i 16v. THP	EP6CDT /M	03/08-	
		2	1.6 VTi 16v.	EP6C	03/08-
			1.6 HDi /FAP	DV6C DV6TED4	03/08-
		1.8i 16v.	EW7A	03/08-	
		2.0i 16v.	EW10A	03/08-	
		2.0 HDi /FAP	DW10B/CTED4 DW12BTED4	03/08-	
		2.2 HDi FAP	DW12C	03/08-	
		2.7 HDi	DT17TED4	03/08-	
		3.0i V6	ES9A	03/08-	
		3.0 HDi	DT20C	03/08-	
6403343 Rotule de susp. inf. G/D					
OE 364071 <i>L/R lower suspension ball joint</i>					
	1	M14 x 1.5			
		2	1.6 HDi	DV6TED4	09/04-02/08
			1.8i 16v.	EW7A	09/04-02/08
			1.8i 16v.	EW7J4	-02/08
			2.0i 16v.	EW10J4	-08/04
			2.0i 16v.	EW10A	09/04-02/08
			2.0 HDi	DW10	-08/04
			2.0 HDi	DW10BTED4	09/04-02/08
			2.0 HPi	EW10D	-08/04
			2.2 HDi	DW12TED4	-02/08
			2.2 HDi FAP	DW12BTED4	09/04-02/08
			3.0i V6	ES9J4S	-08/04
3.0i V6	ES9A	09/04-02/08			

...C5...

Bras & Triangle de suspension

Control arm
Brazo y triángulo
Wahacz
Рычаг подвески

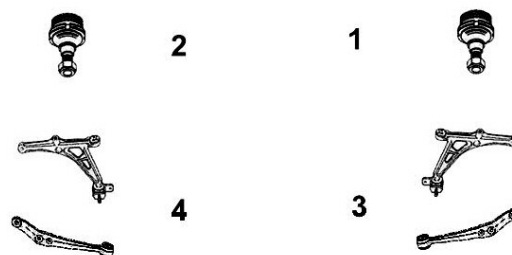
G/L  D/R**7570003****Rotule de susp. inf. G/D**

OE 364069

L/R lower suspension ball joint

1	1.6i 16v. THP	EP6CDT /M	03/08-
2	1.6 VTi 16v.	EP6C	03/08-
	1.6 HDi	DV6C	03/08-
	1.6 HDi FAP	DV6TED4	03/08-
	1.8i 16v.	EW7A	03/08-
	2.0i 16v.	EW10A	03/08-
	2.0 HDi	DW10BTED4	03/08-
	2.0 HDi FAP	DW10CTED4	03/08-
	2.2 HDi FAP	DW12BTED4 DW12C	03/08-
	2.7 HDi	DT17TED4	03/08-
	3.0i V6	ES9A	03/08-
	3.0 HDi	DT20C	03/08-

**Support d'amortisseur**

Suspension mounting
Soporte amortiguador
Poduszka amortyzatora
Опора амортизатора

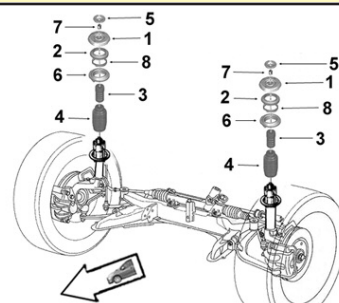
**2650003****Support suspension G/D**

OE 5038E6

L/R suspension mounting

1	Susp. métallique		
	1.6i 16v. THP	EP6CDT	03/05/10-
	1.6 HDi	DV6C	03/08-
	1.6 HDi FAP	DV6TED4	03/05/10-
	1.8i 16v.	EW7A	03/05/10-
	2.0i 16v.	EW10A	03/05/10-
	2.0 HDi	DW10BTED4	03/05/10-
	2.0 HDi FAP	DW10CTED4	03/05/10-

0335665**Butée de suspension G/D**

OE 503366

L/R suspension bush

3	1.6 HDi	Susp. hydraulique 3/Plus réglage auto	DV6TED4	09/04-02/08
	1.8i 16v.	Susp. hydraulique 3/Plus réglage auto	EW7A	09/04-02/08
	1.8i 16v.	Susp. hydraulique 3	EW7J4	-08/04
	1.8i 16v.	Susp. hydraulique 3/Plus réglage auto	EW7J4	09/04-02/08
	2.0i 16v.	Susp. hydraulique 3 /Plus	EW10J4	-08/04
	2.0i 16v.	Susp. hydraulique 3/Plus réglage auto	EW10A	09/04-02/08
	2.0 HDi	Susp. hydraulique 3 /Plus	DW10TD	-08/04
	2.0 HDi	Susp. hydraulique 3/Plus réglage auto	DW10BTED4	09/04-02/08
	2.0 HDi FAP	Susp. hydraulique 3	DW10ATED	-08/04
	2.0 HPi	Susp. hydraulique 3 /Plus	EW10D	-08/04
	2.2 HDi	Susp. hydraulique 3 Plus	DW12B /TED4	-02/08
	3.0i V6	Susp. hydraulique 3 Plus	ES9J4S	-08/04



Barre stabilisatrice
 Stabilizer bar
 Barra estabilizadora
 Drażek stabilizatora
 стабилизатор поперечной устойчивости

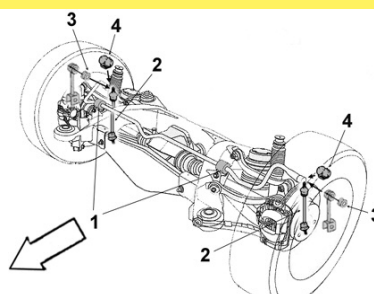

2300017 **Biellette barre stab. AR**
 OE 517852 *Rear stabilizer bar stub axle*



2	1.6i 16v.	EP6CDT	03/08-
	1.6 HDi FAP	DV6C DV6TED4	03/08-
	1.8i 16v.	EW7A	03/08-
	2.0i 16v.	EW10A	03/08-
	2.0 HDi	DW10BTED4	03/08-
	2.0 HDi FAP	DW10CTED4	03/08-
	2.2 HDi FAP	DW12BTED4	03/08-
	2.7 HDi	DT17TED4	03/08-
	3.0i V6	ES9A	03/08-
	3.0 HDi	DT20C	03/08-



Eléments SUSPENSION
 Suspension parts
 Elementos suspensión
 Elementy zawieszenie
 Элементы подвески

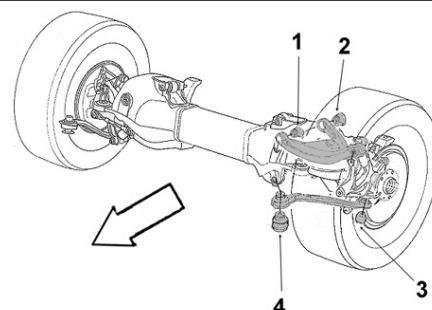

2250011 **Articulation triangle**
 OE 5131E0 *Track control arm bush*



1 2	Ø int. 12 Ø ext. 34 coll. 45 long. tube int. 45 ext. 27 ep. coll.8		
	1.6i Turbo	EP6CDT	03/08-
	1.6 HDi FAP	DV6C /TED4	03/08-
	1.8i 16v.	EW7A	03/08-
	2.0i 16v.	EW10A	03/08-
	2.0 HDi	DW10BTED4	03/08-
	2.0 HDi FAP	DW10CTED4	03/08-
	2.2 HDi FAP	DW12BTED4	03/08-
	2.7 HDi	DT17TED4	03/08-
	3.0i V6	ES9A	03/08-
	3.0 HDi	DT20C	03/08-

Bras & Triangle de suspension

Control arm
 Brazo y triángulo
 Wahacz
 Рычаг подвески

G/L  D/R

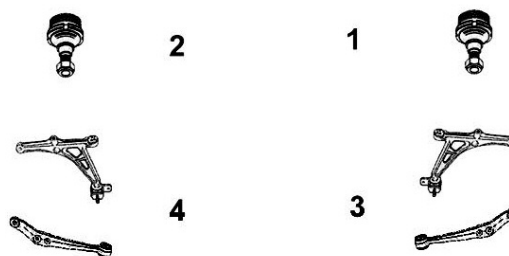

1755CF5 **Bras de susp. inf. G/D**
 OE 5175CF *L/R lower track control arm*



3 4	1.6i 16v. THP	EP6CDT /M	03/08-
	1.6 VTi 16v.	EP6C	03/08-
	1.6 HDi	DV6C	03/08-
	1.6 HDi FAP	DV6TED4	03/08-
	1.8i 16v.	EW7A	03/08-
	2.0i 16v.	EW10A	03/08-
	2.0 HDi	DW10BTED4	03/08-
	2.0 HDi FAP	DW10CTED4	03/08-
	2.2 HDi FAP	DW12BTED4 DW12C	03/08-
	2.7 HDi	DT17TED4	03/08-
	3.0i V6	ES9A	03/08-
	3.0 HDi	DT20C	03/08-

...C5



Support d'amortisseur

Suspension mounting
Soporte amortiguador
Poduszka amortyzatora
Опора амортизатора

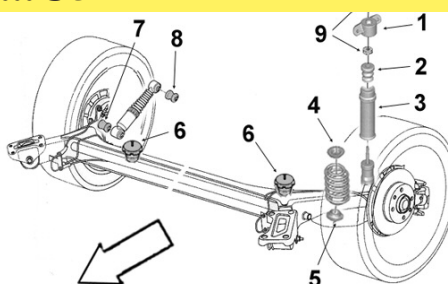

CITROËN



2650039

OE 516533

Coupelle sup. ressort AR

Rear spring upper cup



4 Susp. métallique

1.6i 16v. THP EP6CDT/ M	03/08-
1.6 VTi 16v. EP6C	03/08-
1.6 HDi DV6C	03/08-
1.6 HDi FAP DV6TED4	03/08-
1.8i 16v. EW7A	03/08-
2.0i 16v. EW10A	03/08-
2.0 HDi DW10BTED4	03/08-
2.0 HDi FAP DW10CTED4	03/08-
2.2 HDi FAP DW12BTED4 DW12C	03/08-
2.7 HDi DT17TED4	03/08-
3.0i V6 ES9A	03/08-
3.0 HDi DT20C	03/08-

1665665

OE 516666

Butée de talonnage

Bushing



6 H64 Bras AR

1.8i 16v. EW7J4	-08/04
2.0i 16v. EW10J4	-08/04
2.0 HDi DW10TD/ATED	-08/04
2.0 HPi EW10D	-08/04
2.2 HDi DW12TED4	-08/04
3.0i V6 ES9J4S	-08/04

Eléments TRAIN ARRIERE

Rear axle parts

Tren TRAS

Elementy zawieszenia tylnego

элементы задней оси.



1315C75

OE 5131C7

Art. AV essieu AR

Rear axle front bush



Ø int.15 Ø ext.75 coll.95 long. tube int.59 ext.43 ep. Coll.25

1.6 HDi DV6TED4	09/04-02/08
1.8i 16v. EW7J4	-02/08
1.8i 16v. EW7A	09/04-02/08
2.0i 16v. EW10J4	-08/04
2.0i 16v. EW10A	09/04-02/08
2.0 HDi DW10TD/ATED	-08/04
2.0 HDi DW10BTED4	09/04-02/08
2.0 HPi EW10D	-08/04
2.2 HDi DW12TED4	-02/08
2.2 HDi FAP DW12BTED4	09/04-02/08
3.0i V6 ES9J4S	-08/04
3.0i V6 ES9A	09/04-02/08

1315C85

OE 5131C8

Support AR

Rear mounting



1.6 HDi DV6TED4	09/04-02/08
1.8i 16v. EW7J4	-02/08
1.8i 16v. EW7A	09/04-02/08
2.0i 16v. EW10J4	-08/04
2.0i 16v. EW10A	09/04-02/08
2.0 HDi DW10TD/ATED	-08/04
2.0 HDi DW10BTED4	09/04-02/08
2.0 HPi EW10D	-08/04
2.2 HDi DW12TED4	-02/08
2.2 HDi FAP DW12BTED4	09/04-02/08
3.0i V6 ES9J4S	-08/04
3.0i V6 ES9A	09/04-02/08

2600015

OE 517847

Biellette de suspension

Suspension link rod



1.6i 16v. THP EP6CDT/ M	03/08-
1.6 VTi 16v. EP6C	03/08-
1.6 HDi DV6C	03/08-
1.6 HDi FAP DV6TED4	03/08-
1.8i 16v. EW7A	03/08-
2.0i 16v. EW10A	03/08-
2.0 HDi DW10BTED4	03/08-
2.0 HDi FAP DW10CTED4	03/08-
2.2 HDi FAP DW12BTED4	03/08-
2.2 HDi FAP DW12C	03/08-
2.7 HDi DT17TED4	03/08-
3.0i V6 ES9A	03/08-
3.0 HDi DT20C	03/08-

C6...

Eléments DIRECTION

Steering parts

Elementos Direcciones

Elementy układ kierowniczy

Элементы рулевой системы

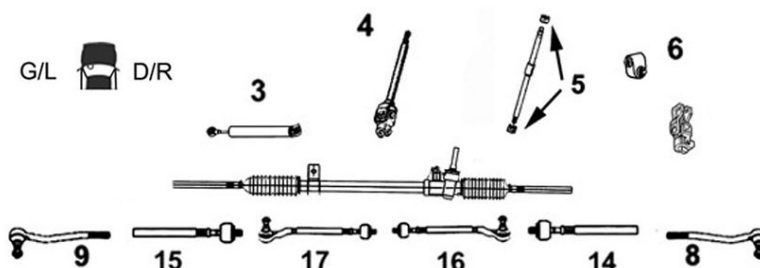

CITROËN



8123E73

Axe de bielle G/D

OE 3812E7

L/R axial joint



14 Côté dir. M16x1.5
15 Côté rot. M14x1.5 long 105 mm

2.2 HDi FAP
2.7 HDi
3.0i V6
3.0 HDi

7670005

Rotule de direction G

OE 381765

Left tie rod end



9 M14 x 1.5

2.2 HDi FAP
2.7 HDi
3.0i V6
3.0 HDi

7670006

Rotule de direction D

OE 381766

Right tie rod end



8 M14 x 1.5

2.2 HDi FAP
2.7 HDi
3.0i V6
3.0 HDi



Barre stabilisatrice

Stabilizer bar

Barra estabilizadora

Drażek stabilizatora

стабилизатор поперечной устойчивости

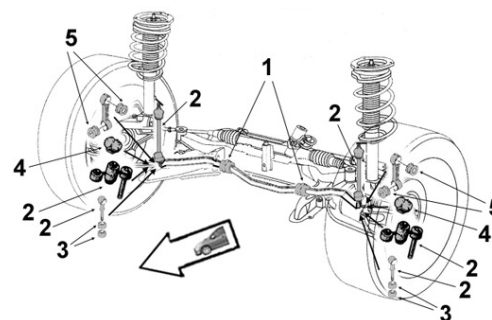

2300011

Biellette barre stab. G

OE 508752

Left stabilizer bar stub axle



2

2.2 HDi FAP
2.7 HDi
3.0i V6
3.0 HDi

2300009

Biellette barre stab. D

OE 508753

Right stabilizer bar stub axle



2

2.2 HDi FAP
2.7 HDi
3.0i V6
3.0 HDi

2300004

Palier de barre milieu

OE 509499

Middle bar main bearing



1 Barre Ø 24

2.2 HDi FAP
2.7 HDi
3.0i V6
3.0 HDi

...C6...



Eléments SUSPENSION
Suspension parts
Elementos suspensión
Elementy zawieszenie
Элементы подвески

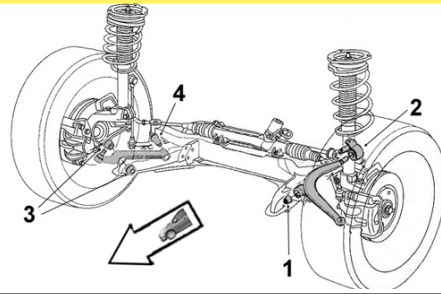

CITROËN



2250019

OE 3523CA

Art. bras sup.

Upper arm bush



1 Ø int.10.3 Ø ext. 32 coll. 39
2 long. tube int. 34 ext. 22 ep. coll.6.2

2.2 HDi FAP
 2.7 HDi
 3.0i V6
 3.0 HDi

2250014

OE 3523AZ

Art. sup. support pivot

pivot mounting upper bush



Ø int. 12 Ø ext. 33 coll. 40
 long. tube int. 82 ext. 21.5 ep. coll.6.3

2.2 HDi FAP
 2.7 HDi
 3.0i V6
 3.0 HDi

2250013

Part/oe 365604

Art. inf. support pivot

lower bush pivot mounting



Ø int. 12 Ø ext. 40 coll. 45.4
 long. tube int. 38 ext. 27 ep. coll.2.3

2.2 HDi FAP
 2.7 HDi
 3.0i V6
 3.0 HDi

2250002

OE 3523AQ

Articulation AV triangle inf.

Lower front track control arm front bush



1 Ø int.14 Ø ext.56 long. tube int.32 ext 50

2.2 HDi FAP Susp. renforcée AV AR

Susp. active réglage auto.

2.7 HDi
 3.0i V6
 3.0 HDi

2250008

Part/oe 3520Q1

Articulation AR triangle inf.

Track control arm rear bush



2 Ø int. 20

2.2 HDi FAP
 2.7 HDi
 3.0i V6

Susp. renforcée AV AR
 Susp. active réglage auto.
 Susp. active réglage auto.

-29/01/07

-29/01/07

-29/01/07

Bras & Triangle de suspension

Control arm
Brazo y triángulo
Wahacz
Рычаг подвески

G/L D/R

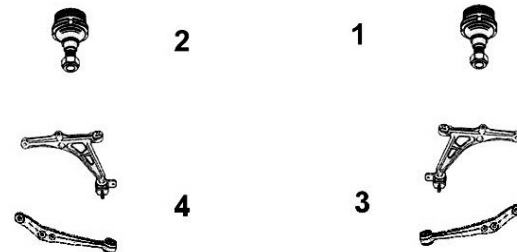

5203N63

OE 3520Q1/W1

Triangle de susp. inf. G

Lower left track control arm



4 Sans rotule Without ball joint

OE 3520Q1

2.2 HDi FAP -29/01/07
 2.7 HDi -29/01/07
 3.0i V6 -29/01/07

OE 3520W1

2.2 HDi FAP 19/05/08-

5213J63

OE 3521L2/SA

Triangle de susp. inf. D

Lower right track control arm



3 Sans rotule Without ball joint

OE 3521L2

2.2 HDi FAP -29/01/07
 2.7 HDi -29/01/07
 3.0i V6 -29/01/07

OE 3521S4

2.2 HDi FAP 19/05/08-

...C6...

CITROEN





6403573 OE 364074	Rotule de susp. sup. G/D <i>L/R upper susp. ball joint</i>	6403723 OE 364072	Rotule de susp. inf. G/D <i>L/R lower suspension ball joint</i>
	1 2 2.2 HDi FAP 2.7 HDi 3.0i V6 3.0 HDi		1 2 2.2 HDi FAP 2.7 HDi 3.0i V6 -03/12/06 -03/12/06 -03/12/06

7570003 OE 364069	Rotule de susp. inf. G/D <i>L/R lower suspension ball joint</i>		
	1 2 2.2 HDi FAP 2.7 HDi 3.0i V6 3.0 HDi	04/12/06- 04/12/06- 04/12/06-	

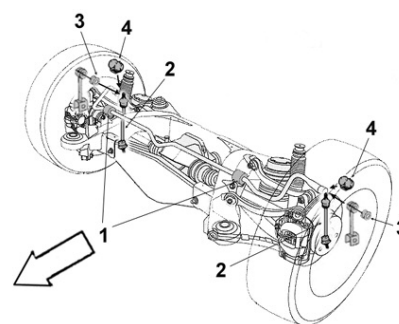

Barre stabilisatrice
Stabilizer bar
Barra estabilizadora
Drażek stabilizatora
стабилизатор поперечной устойчивости



2300017 OE 517852	Biellette barre stab. AR <i>Rear stabilizer bar stub axle</i>		
	2 2.2 HDi FAP 2.7 HDi 3.0i V6 3.0 HDi		



Eléments SUSPENSION
Suspension parts
Elementos suspensión
Elementy zawieszenie
Элементы подвески

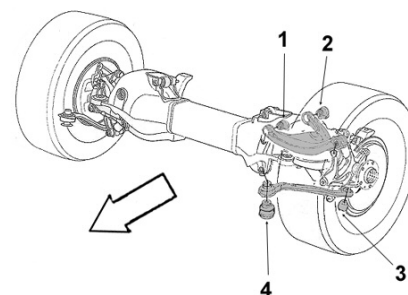

2250011 OE 5131E0	Articulation triangle <i>Track control arm bush</i>		
	1 2 Ø int. 12 Ø ext. 34 coll. 45 long. tube int. 45 ext. 27 ep. coll.8 2.2 HDi FAP 2.7 HDi 3.0i V6 3.0 HDi		

...C6

Bras & Triangle de suspension

Control arm
Brazo y triángulo
Wahacz
Рычаг подвески

G/L  D/R



1755CF5
OE 5175CF

Bras de susp. inf. G/D
L/R lower track control arm



3
4

2.2 HDi FAP
2.7 HDi
3.0i V6
3.0 HDi

Eléments TRAIN ARRIERE

Rear axle parts
Tren TRAS
Elementy zawieszenia tylnego
элементы задней оси.



2600015
OE 517847

Biellette de suspension
Suspension link rod



2.2 HDi FAP
2.7 HDi
3.0i V6
3.0 HDi

C8...

Eléments DIRECTION

Steering parts
Elementos Direcciones
Elementy układ kierowniczy
Элементы рулевой системы

G/L  D/R

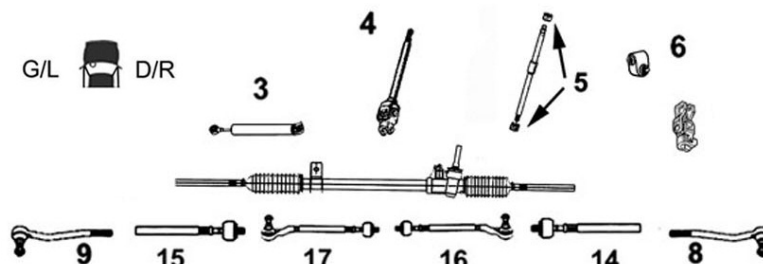

8123E23
OE 3812E2

Axe de bielle G/D
L/R axial joint



14 Côté dir. M14x1.5 Côté rot. M14x1.5 long 309 mm
15

2.0i 16v.	DA variable	EW10A EW10J4	-25/09/05
2.0i 16v.	DA Electro hydraulique	EW10A EW10J4	26/09/05-30/05/10
2.0i 16v.	DA mécanique	EW10A EW10J4	26/09/05-
2.0 HDi	DA variable	DW10ATED4 DW10UTED4	-25/09/05
2.0 HDi	DA Electro hydraulique	DW10ATED4 DW10UTED4	26/09/05-30/05/10
2.0 HDi	DA mécanique	DW10ATED4 DW10UTED4	26/09/05-
2.0 HDi FAP	DA variable	DW10BTED4	-25/09/05
2.0 HDi FAP	DA Electro hydraulique	DW10BTED4 DW10CTED4	26/09/05-30/05/10
2.0 HDi FAP	DA mécanique	DW10BTED4 DW10CTED4	26/09/05-
2.0 HDi FAP 136hp 100kw	DA mécanique	DW10CBDTR	26/09/05-
2.0 HDi FAP 136hp 100kw	DA Electro hydraulique	DW10CBDTR	31/05/10-
2.2i 16v.	DA variable	DW12J4	-25/09/05
2.2 HDi	DA variable	DW12TED4	-25/09/05
2.2 HDi	DA Electro hydraulique	DW12TED4	26/09/05-30/05/10
2.2 HDi	DA mécanique	DW12TED4	26/09/05-
2.2 HDi FAP	DA mécanique	DW12BTED4	26/09/05-
3.0i V6	DA variable	ES9J4S	-25/09/05
3.0i V6	DA Electro hydraulique	ES9J4S	26/09/05-30/05/10
3.0i V6	DA mécanique	ES9J4S	26/09/05-

...C8...

7770003 **Axe de bielle G/D**

Part/oe 3812F0 *L/R axial joint*



14 Côté dir. M16x1.5 Côté rot. M14x1.5 long 304 mm
15 DA Electro hydraulique

2.0 HDi FAP	DW10CTED4	31/05/10-
2.2 HDi FAP	DW12BTED4	-30/05/10

0594124 **Rotule de direction G/D**

OE 405912 *L/R tie rod end*



8 M14 x 1.5

9 2.0i 16v.	DA variable	EW10A EW10J4	-25/09/05
2.0i 16v.	DA Electro hydraulique	EW10A EW10J4	26/09/05-30/05/10
2.0i 16v.	DA mécanique	EW10A EW10J4	26/09/05-
2.0 HDi	DA variable	DW10A/UTED4	-25/09/05
2.0 HDi	DA Electro hydraulique	DW10A/UTED4	26/09/05-30/05/10
2.0 HDi	DA mécanique	DW10A/UTED4	26/09/05-
2.0 HDi FAP	DA variable	DW10BTED4	-25/09/05
2.0 HDi FAP	DA Electro hydraulique	DW10BTED4	26/09/05-30/05/10
2.0 HDi FAP	DA mécanique	DW10BTED4	26/09/05-
2.0 HDi FAP 136hp 100kw	DA mécanique	DW10CBDTR	26/09/05-
2.0 HDi FAP 136hp 100kw	DA Electro hydraulique	DW10CBDTR	31/05/10-
2.0 HDi FAP	DA mécanique	DW10CTED4	26/09/05-
2.0 HDi FAP	DA Electro hydraulique	DW10CTED4	26/09/05-30/05/10
2.2i 16v.	DA variable	EW12J4	-25/09/05
2.2 HDi	DA mécanique	DW12BTED4	26/09/05-
2.2 HDi	DA variable	DW12TED4	-25/09/05
2.2 HDi	DA Electro hydraulique	DW12TED4	26/09/05-30/05/10
2.2 HDi	DA mécanique	DW12TED4	26/09/05-
3.0i V6	DA variable	ES9J4S	-25/09/05
3.0i V6	DA Electro hydraulique	ES9J4S	26/09/05-30/05/10
3.0i V6	DA mécanique	ES9J4S	26/09/05-

7670011 **Rotule de direction G/D**

OE 381773 *L/R tie rod end*



8 M14 x 1.5

9 DA Electro hydraulique

2.0 HDi FAP	DW10CTED4	31/05/10-
2.2 HDi FAP	DW12BTED4	-30/05/10



Barre stabilisatrice
Stabilizer bar
Barra estabilizadora
Drażek stabilizatora
стабилизатор поперечной устойчивости

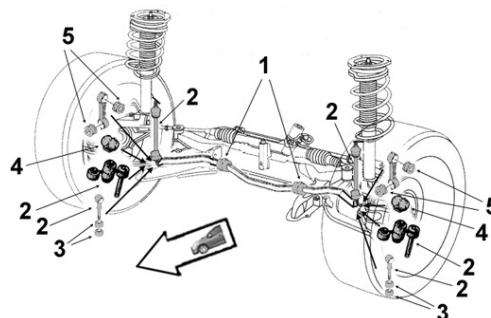

0875515 **Biellette barre stab.**

OE 508751 *Stabilizer bar stub axle*



2

2.0i 16v.	EW10J4 EW10A
2.0 HDi	DW10A/UTED4
2.0 HDi FAP	DW10B/CTED4
2.2i 16v.	EW12J4
2.2 HDi	DW12TED4
2.2 HDi FAP	DW12BTED4
3.0i V6	ES9J4S

...C8...

SASIC

CITROEN

Bras & Triangle de suspension

Control arm
Brazo y triángulo
Wahacz
Рычаг подвески

G/L  D/R

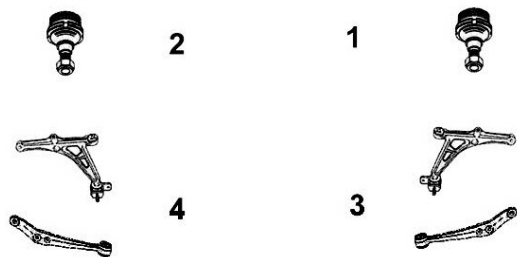

5203P63

OE 3520P6

Triangle de susp. G

Left track control arm

4 Avec rotule With ball joint



2.0i 16v.	EW10A	-27/06/06
2.0i 16v.	EW10J4	
2.0 HDi	DW10A/UTED4	-27/06/06
2.0 HDi FAP	DW10BTED4	-27/06/06
2.2i 16v.	EW12J4	
2.2 HDi	DW12TED4	-27/06/06
3.0i V6	ES9J4S	

5213K63

OE 3521K6

Triangle de susp. D

Right track control arm

3 Avec rotule With ball joint



2.0i 16v.	EW10A	-27/06/06
2.0i 16v.	EW10J4	
2.0 HDi	DW10A/UTED4	-27/06/06
2.0 HDi FAP	DW10BTED4	-27/06/06
2.2i 16v.	EW12J4	
2.2 HDi	DW12TED4	-27/06/06
3.0i V6	ES9J4S	

7470015

OE 1607510680

Triangle de susp. G

Left track control arm

4 Avec rotule With ball joint Ø 17



2.0i 16v.	EW10A	28/06/06-
2.0 HDi	DW10A/UTED4	28/06/06-
2.0 HDi FAP	DW10BTED4	28/06/06-
2.0 HDi FAP	136hp 100kw	
	DW10CBDTR	
2.2 HDi	DW12TED4	28/06/06-

7470014

OE 1607510780

Triangle de susp. D

Right track control arm

3 Avec rotule With ball joint Ø 17



2.0i 16v.	EW10A	28/06/06-
2.0 HDi	DW10A/UTED4	28/06/06-
2.0 HDi FAP	DW10BTED4	28/06/06-
2.0 HDi FAP	136hp 100kw	
	DW10CBDTR	
2.2 HDi	DW12TED4	28/06/06-

7470001

OE 3520V8

Triangle de susp. G

Left track control arm

4 Avec rotule With ball joint



2.0 HDi FAP	DW10CTED4
2.2 HDi FAP	DW12BTED4

7470002

OE 3521S0

Triangle de susp. D

Right track control arm

3 Avec rotule With ball joint



2.0 HDi FAP	DW10CTED4
2.2 HDi FAP	DW12BTED4



Support d'amortisseur

Suspension mounting
Soporte amortiguador
Poduszka amortyzatora
Опора амортизатора

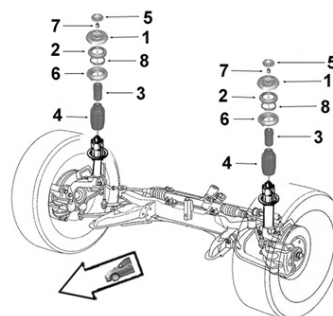

0385165

OE 503868

Support suspension G

Left suspension mounting

1



2.0i 16v.	EW10J4 EW10A
2.0 HDi	DW10A/UTED4
2.0 HDi FAP	DW10BTED4
2.0 HDi FAP	DW10CTED4
2.2i 16v.	EW12J4
2.2 HDi	DW12TED4
2.2 HDi FAP	DW12BTED4
3.0i V6	ES9J4S

0385175

OE 503870

Support suspension D

Right suspension mounting

1







2.0i 16v.	EW10J4 EW10A
2.0 HDi	DW10A/UTED4
2.0 HDi FAP	DW10BTED4
2.0 HDi FAP	DW10CTED4
2.2i 16v.	EW12J4
2.2 HDi	DW12TED4
2.2 HDi FAP	DW12BTED4
3.0i V6	ES9J4S

...C8

CITROEN





0355385 OE 503555	Butée à billes G/D <i>L/R ball bearing</i>	0315505 OE 503150	Coupelle amortisseur G/D <i>L/R shock absorber cup</i>
	2 2.0i 16v. EW10J4 EW10A 2.0 HDi DW10A/UTED4 2.0 HDi FAP DW10B/CTED4 2.2i 16v. EW12J4 2.2 HDi DW12TED4 2.2 HDi FAP DW12BTED4 3.0i V6 ES9J4S		6 2.0i 16v. EW10J4 EW10A 2.0 HDi DW10A/UTED4 2.0 HDi FAP DW10B/CTED4 2.2i 16v. EW12J4 2.2 HDi DW12TED4 2.2 HDi FAP DW12BTED4 3.0i V6 ES9J4S
2650012 OE 5033A5	Butée de suspension G/D <i>L/R suspension bush</i>	2545195 OE 525446	Protecteur amortisseur G/D <i>L/R shock absorber protector</i>
	3 H 111 2.0i 16v. EW10J4 25/05/04- 2.0i 16v. EW10A 2.0 HDi DW10A/UTED4 2.0 HDi FAP DW10B/CTED4 2.2i 16v. EW12J4 25/05/04- 2.2 HDi DW12TED4 2.2 HDi FAP DW12BTED4 3.0i V6 ES9J4S		4 2.0i 16v. EW10J4 EW10A 2.0 HDi DW10A/UTED4 2.0 HDi FAP DW10B/CTED4 2.2i 16v. EW12J4 2.2 HDi DW12TED4 2.2 HDi FAP DW12BTED4 3.0i V6 ES9J4S

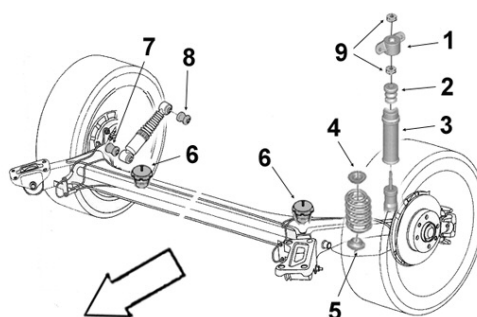

Support d'amortisseur
Suspension mounting
Soporte amortiguador
Poduszka amortyzatora
Опора амортизатора



1645345 OE 516434	Coupelle sup. ressort AR <i>Rear spring upper cup</i>
	4 2.0i 16v. EW10J4 EW10A 2.0 HDi DW10A/UTED4 2.0 HDi FAP DW10B/CTED4 2.2i 16v. EW12J4 2.2 HDi DW12TED4 2.2 HDi FAP DW12BTED4 3.0i V6 ES9J4S
1665475 OE 516647	Butée de talonnage <i>Bushing</i>
	6 Ø 55 H102 2.0i 16v. EW10J4 EW10A 2.0 HDi DW10A/UTED4 2.0 HDi FAP DW10BTED4 2.0 HDi FAP DW10CTED4 2.2i 16v. EW12J4 2.2 HDi DW12TED4 2.2 HDi FAP DW12BTED4
1665695 OE 516669	Butée de talonnage <i>Bushing</i>
	6 H102 3.0i V6 ES9J4S

DS3...

Eléments DIRECTION

Steering parts

Elementos Direcciones

Elementy uklad kierowniczy

Элементы рулевой системы

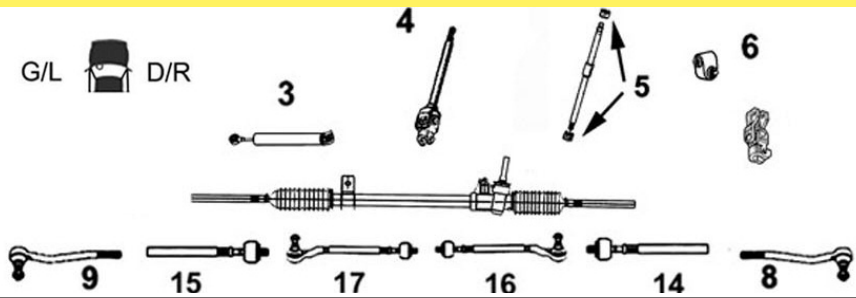

7770001

Axe de bielle G/D

OE 3812F6

L/R axial joint



14 Côté dir. M12x1.0 Côté rot. M14x1.5 long 246 mm

15

1.2i	EB2
1.4i VTi 16v.	EP3C
1.4 HDi	DV4C
1.6i16v. Turbo	EP6CDT/M
1.6i16v. THP	EP6DT/S
1.6iVTi 16v.	EP6C
1.6 HDi	DV6C
1.6 HDi	DV6DTED

7670003

Rotule de direction G

OE 381792

Left tie rod end



9 M14 x 1.5

1.2i	EB2
1.4i VTi 16v.	EP3C
1.4 HDi	DV4C
1.6i16v. Turbo	EP6CDT/M
1.6i16v. THP	EP6DT/S
1.6i VTi 16v.	EP6C
1.6 HDi	DV6C
1.6 HDi	DV6DTED

7670004

Rotule de direction D

OE 381791

Right tie rod end



8 M14 x 1.5

1.2i	EB2
1.4i VTi 16v.	EP3C
1.4 HDi	DV4C
1.6i16v. Turbo	EP6CDT/M
1.6i16v. THP	EP6DT/S
1.6i VTi 16v.	EP6C
1.6 HDi	DV6C
1.6 HDi	DV6DTED



Barre stabilisatrice

Stabilizer bar

Barra estabilizadora

Drażek stabilizatora

стабилизатор поперечной устойчивости

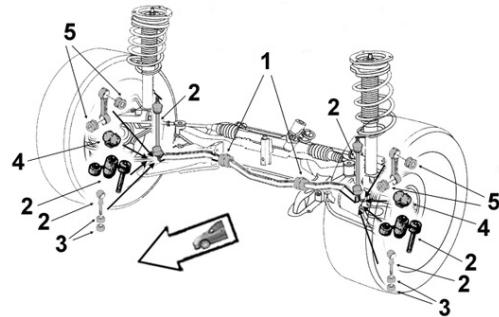

0875455

Biellette barre stab.

OE 508759

Stabilizer bar stub axle



2 Pays grand froid

1.2i	EB2	11/10/10-30/06/13
1.4i VTi 16v.	EP3C	11/10/10-30/06/13
1.4 HDi FAP	DV4C	11/10/10-30/06/13
1.6i 16v. Turbo	EP6CDT	11/10/10-30/06/13
1.6i Turbo /Racing	EP6DT/S	11/10/10-30/06/13

... DS3...

Bras & Triangle de suspension

Control arm
Brazo y triángulo
Wahacz
Рычаг подвески

G/L  D/R

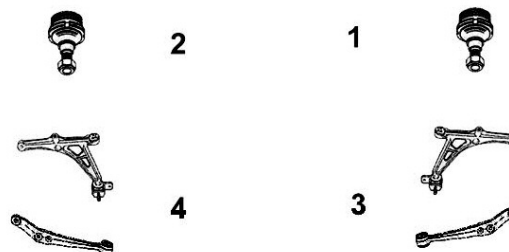

7470026

OE 3520W7

Triangle de susp. G

Left track control arm



NEW

4 Avec rotule With ball joint Ø18

1.6i VTi 16v. Susp. normale
Pivot roue Ø82 EP6C BVA AL4
-01/05/11

7470025

OE 3521S9

Triangle de susp. D

Right track control arm



NEW

3 Avec rotule With ball joint Ø18

1.6i VTi 16v. Susp. normale
Pivot roue Ø82 EP6C BVA AL4
-01/05/11

7570007

OE 364078

Rotule de susp. inf. G/D

L/R lower suspension ball joint



NEW

1 Ø18
2 Pivot roue Ø72

1.2i /VTi
1.4i /GPL VTi /GPL
1.4 HDi FAP
1.6i 16v. /Turbo
1.6i VTi 16v.
1.6 HDi FAP

Pivot roue Ø82

TT /all models sauf BVA AL4 -01/05/11
TT /all models 02/05/11-19/01/14

Pivot roue Ø82 Liaison au sol Loi 4/6

1.2i /VTi 20/01/14-
1.4i /VTi 20/01/14-
1.6i 16v. Turbo 20/01/14-
1.6i Turbo 20/01/14-
1.6i VTi 16v. 20/01/14-



Support d'amortisseur

Suspension mounting
Soporte amortiguador
Poduszka amortyzatora
Опора амортизатора

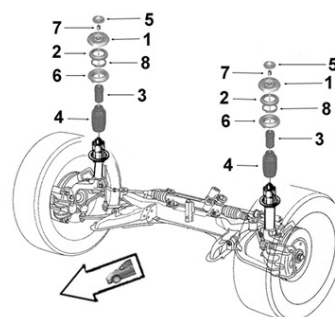

2650038

OE 503375

Coupelle rebond.

Spring cup



5 1.2i 12v. VTi EB2
1.4i VTi EP3C/G
1.4 HDi DV4C
1.6i 16v. EP6DT
1.6i 16v. THP EP6DTS
1.6i 16v. THP EP6CDT/M
1.6i VTi 16v. EP6C
1.6 HDi DV6DTED
1.6 HDi DV6C

0355275

OE 503563

Butée à billes G/D

L/R ball bearing



2 1.2i EB2
1.4i VTi EP3C
1.4 HDi FAP DV4C
1.6i 16v. THP EP6C /DT
1.6i Turbo Racing EP6DTS
1.6i VTi 16v. EP6C
1.6 HDi DV6DTED
1.6 HDi DV6C

2650043

OE 5033C3

Coupelle amortisseur G/D

L/R shock absorber cup



NEW

6 1.2i 12v. VTi EB2
1.4i VTi EP3C
1.4 HDi DV4C
1.6i 16v. THP EP6CDT/M
1.6i 16v. THP EP6DT
1.6i 16v. THP EP6DTS
1.6 VTi 16v. EP6C
1.6 HDi DV6C
1.6 HDi DV6DTED

2650044

OE 525448

Protecteur amortisseur G/D

L/R shock absorber protector



NEW

4 1.2i EB2
1.4i /VTi /16v. / GPL EP3C
1.4 HDi FAP DV4C
1.6i Turbo /16v. Turbo EP6CDT/S
1.6i VTi 16v. EP6C
1.6 HDi FAP DV6C/DTED

...DS3

Eléments TRAIN ARRIERE

Rear axle parts

Tren TRAS

Elementy zawieszenia tylnego

элементы задней оси.



CITROEN



2600009

OE 5131H4

Articulation essieu

Axle bush

Ø int. 12 Ø ext. 72 coll. 83 long. tube int. 83 ext. 60 ep. coll.5.5



1.2i 12v. VTi
1.4i VTi
1.4 HDi
1.6i 16v. THP
1.6 VTi 16v.
1.6 HDi

EB2
EP3C
DV4C
EP6DT/S EP6CDT/M/X
EP6C
DV6C DV6DTED

DS4...

Eléments DIRECTION

Steering parts

Elementos Direcciones

Elementy układ kierowniczy

Элементы рулевой системы

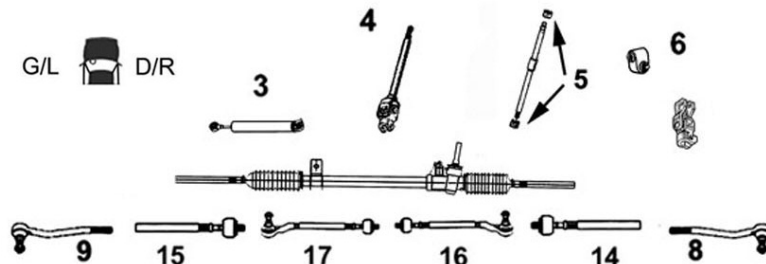

7770002

OE 3812F2

Axe de bielle G/D

L/R axial joint

14 Côté dir. M14x1.5 Côté rot. M14x1.5
15 long 278 mm

1.6i 16v. EP6C
1.6 HDi DV6C
2.0 HDi FAP sauf pneus 19 pouces
DW10CTED4



7770007

OE 3812F8

Axe de bielle G/D

L/R axial joint

14 Côté dir. M14x1.5 Côté rot. M14x1.5
15 long 365mm

1.6i 16v. THP EP6CDTX
2.0 HDi FAP Pneus 19 pouces
DW10CTED4



7670017

OE 381789

Rotule de direction G

Left tie rod end

9 M14 x 1.5

1.6i VTi 16v. EP6C
1.6 HDi FAP DV6C
2.0 HDi FAP Sauf pneus 19 pouces
DW10CTED4 DTR



7670016

OE 381788

Rotule de direction D

Right tie rod end

8 M14 x 1.5

1.6i VTi 16v. EP6C
1.6 HDi FAP DV6C
2.0 HDi FAP Sauf pneus 19 pouces
DW10CTED4 DTR



...DS4...





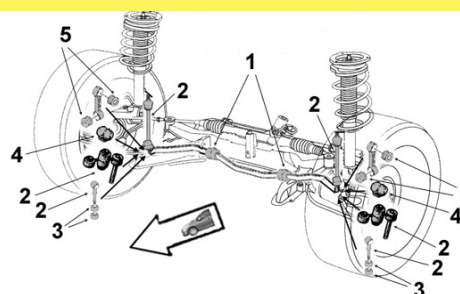

Barre stabilisatrice
 Stabilizer bar
 Barra estabilizadora
 Drążek stabilizatora
 стабилизатор поперечной устойчивости



CITROËN





2300019 OE 508764	Biellette barre stab. <i>Stabilizer bar stub axle</i>	0945885 OE 5094E0	Palier de barre milieu <i>Middle bar main bearing</i>
	2 1.6i 16v. /THP EP6CDT /M /X 1.6i VTi EP6C 1.6 HDi FAP DV6C 2.0 HDi FAP DW10CTED4		1 Barre Ø 22 1.4 VTi EP3C 1.6i 16v. TU5JP4 1.6i 16v./THP EP6CDT/X EP6CDT M/MD 1.6 VTi EP6C/G 1.6 HDi DV6C DV6DTED/M 2.0 HDi FAP DW10CTED4 /DTR 2.0 HDi FAP 136hp 100kw DW10CB DTR
0945895 OE 5094E3	Palier de barre milieu <i>Middle bar main bearing</i>	2300035 OE 5094E4	Palier de barre milieu <i>Middle bar main bearing</i>
	1 Barre Ø 23 1.4 VTi EP3C 1.6i 16v. TU5JP4 1.6i 16v. THP EP6CDT/X EP6CDT M/MD 1.6 VTi EP6C/G 1.6 HDi DV6C DV6DTED/M 2.0 HDi FAP DW10CTED4 /DTR 2.0 HDi FAP 136hp 100kw DW10CB DTR		1 Barre Ø 24 1.4 VTi EP3C 1.6i 16v. TU5JP4 1.6i 16v. THP EP6CDT/X EP6CDT M/MD 1.6 VTi EP6C/G 1.6 HDi DV6C DV6DTED/M 2.0 HDi FAP DW10CTED4 /DTR 2.0 HDi FAP 136hp 100kw DW10CB DTR

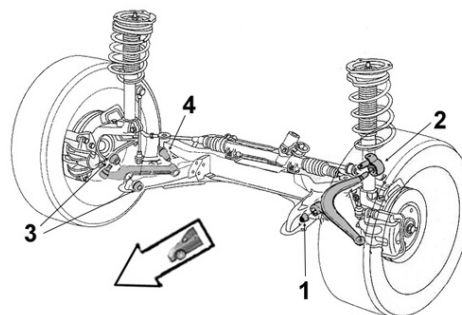

Eléments SUSPENSION
 Suspension parts
 Elementos suspensión
 Elementy zawieszenie
 Элементы подвески



5233913 OE 352391	Articulation AV <i>Front bush</i>	
	1 Ø int.14 Ø ext.55 long. tube int.56 ext.32 1.6i 16v. THP EP6CDTM/ X 1.6i VTi 16v. EP6C 1.6 HDi FAP DV6C DV6DTED 2.0 HDi FAP DW10CTED4 / DTR	
5233923 OE 352392	Articulation AR <i>Rear bush</i>	
	2 Ø int.14 Ø ext.55 coll.62 long. tube int.49 ext.25 ep. coll.3 1.6i 16v. THP EP6CDT/ M/ X 1.6i VTi 16v. EP6C 1.6 HDi FAP DV6C DV6DTED 2.0 HDi FAP DW10CTED4 / DTR	

...DS4...

Bras & Triangle de suspension

Control arm
Brazo y triángulo
Wahacz
Рычаг подвески

G/L  D/R

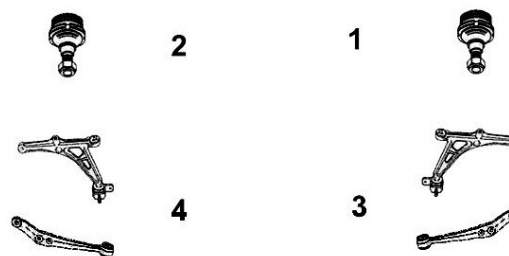

7470003

OE 3520V2

Triangle de susp. inf. G

Lower left track control arm

4 Sans rotule Without tie rod end



1.6i 16v. EP6C -16/06/13
1.6i 16v. THP EP6C/FDTX
1.6i 16v. THP EP6C/FDT -16/06/13
1.6 HDi DV6C -16/06/13
1.6 HDi DV6DTED/M -16/06/13

7470004

OE 3521R3

Triangle de susp. inf. D

Lower right track control arm

3 Sans rotule Without tie rod end



1.6i 16v. EP6C -16/06/13
1.6i 16v. THP EP6C/FDTX
1.6i 16v. THP EP6C/FDT -16/06/13
1.6 HDi DV6C -16/06/13
1.6 HDi DV6DTED/M -16/06/13

6403533

OE 364073

Rotule de susp. inf. G/D

L/R lower suspension ball joint

1
2



1.6 VTi EP6C/G
1.6i 16v. THP EP6CDT/M/MD EP6CDTX
1.6i 16v. THP EP6FDT EP6FDTX
1.6 HDi DV6C DV6DTED/M
2.0i 16v. EW10A
2.0 HDi FAP DW10CB DTR DW10CTED4 /DTR



Support d'amortisseur

Suspension mounting
Soporte amortiguador
Poduszka amortyzatora
Опора амортизатора

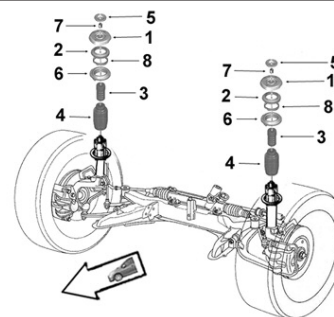

2650037

OE 5038G4

Support suspension G/D

L/R suspension mounting

1



1.4 VTi EP3C
1.6 VTi EP6C/G
1.6i 16v. THP EP6CDT/M/MD
EP6CDTX
1.6 HDi DV6C
DV6DTED/M
2.0i 16v. EW10A
2.0 HDi FAP /DTR DW10CTED4
2.0 HDi FAP DTR DW10CB

0355275

OE 503527

Butée à billes G/D

L/R ball bearing

2



1.6i 16v. /THP EP6
1.6i VTi 16v. EP6C
1.6 HDi DV6C /DTED
2.0 HDi DW10CTED4

2650035

OE 503151

Coupelle amortisseur G/D

L/R shock absorber cup

6



1.4 VTi EP3C
1.6 VTi EP6C
1.6i 16v. EP6C G
1.6i 16v. THP EP6CDT/M/MD
EP6CDTX
1.6 HDi DV6C DV6DTED
DV6ETED M
2.0 HDi FAP DW10CTED4 DTR
DW10CB DTR

2650001

OE 503370

Butée de suspension G/D

L/R suspension bush

3



H96

2.0 HDi FAP DW10CTED4 DTR

...DS4



Support d'amortisseur

Suspension mounting
Soporte amortiguador
Poduszka amortyzatora
Опора амортизатора

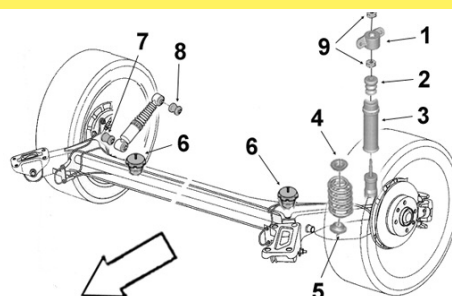

2650041

Protecteur amortisseur G/D

OE 525442

L/R shock absorber protector



2
3

1.4 VTi
1.6i 16v.
1.6i 16v. THP
1.6 HDi
2.0i 16v.
2.0 HDi FAP

EP3C
EP6C/ G
EP6CDT/X EP6CDT M/MD
DV6C DV6DTED/M
EW10A
DW10CTED4/ DTR DW10CB DTR

Eléments TRAIN ARRIERE

Rear axle parts

Tren TRAS

Elementy zawieszenia tylnego

элементы задней оси.



2600011

Articulation essieu

OE 5131G4

Axle bush



Ø ext.72 coll. 81 long. tube int.83
ext.60 ep. coll.8.4

1.4 VTi EP3C
1.6i 16v. TU5JP4
1.6i 16v. THP EP6CDT/M/MD /TX
1.6 VTi EP6C/G
1.6 HDi DV6C DV6DTED/M
2.0i 16v. EW10A
2.0 HDi FAP /DTR DW10CTED4
2.0 HDi FAP DTR DW10CB

DS5...

Eléments DIRECTION

Steering parts

Elementos Direcciones

Elementy uklad kierowniczy

Элементы рулевой системы

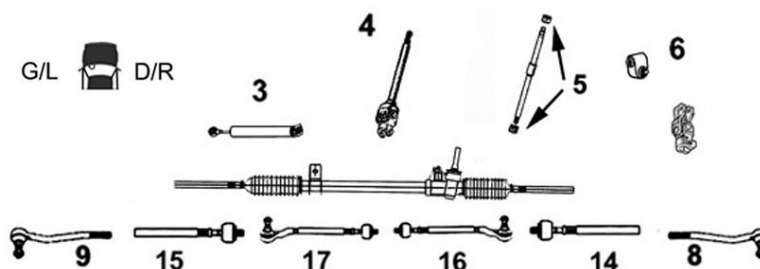

7770012

Axe de bielle G/D

OE 3812F7

L/R axial joint

NEW



14 Côté dir. M14x1.5 Côté rot. M14x1.5
15 Long mm 387 mm

1.6i 16v. THP
1.6 HDi
1.6 HDi FAP
2.0 HDi FAP
2.0 HDi FAP
2.0 HDi FAP

EP6CDT/M/MD/X
DV6C
DV6FC
DW10CB DTR
DW10CTED4
DW10FC

7670022

Rotule de direction G/D

OE 381794

L/R tie rod end

NEW



8 M14 x 1.5
9 Pivot roue Ø82

1.6i 16v. THP
1.6 HDi
1.6 HDi FAP
2.0 HDi FAP
2.0 HDi FAP

EP6CDT /M/MD/X
DV6C
DV6FC
DW10CB DTR
DW10CTED4 DW10FC

...DS5...

SASIC

CITROEN



Barre stabilisatrice
 Stabilizer bar
 Barra estabilizadora
 Drażek stabilizatora
 стабилизатор поперечной устойчивости

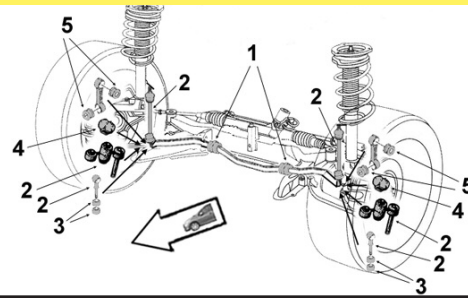

2300030
 OE 508757

Biellette barre stab.
Stabilizer bar stub axle



2

1.6i 16v. THP EP6CDT /X -30/09/12
 1.6 HDi FAP DV6C -30/09/12
 2.0 HDi FAP /4WD
 DW10CTED4 -30/09/12

2300036
 OE 5094E7

Palier de barre milieu
Middle bar main bearing



1

Barre Ø 25

2.0 HDi FAP Hybride
 DW10CTED4



Eléments SUSPENSION
Suspension parts
 Elementos suspensión
 Elementy zawieszenie
 Элементы подвески

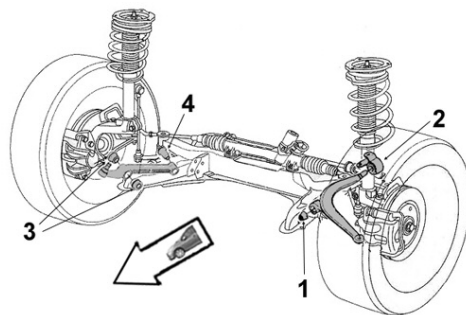

2250018
 OE 3523CW

Articulation AV
Front bush



1

Ø int.14 Ø ext.55.3 long. tube int.56 ext.32

1.6i 16v. THP EP6CDT/M/MD/X
 1.6 HDi DV6C
 2.0 HDi FAP DW10CB DTR
 DW10CTED4

5233923
 OE 352392

Articulation AR
Rear bush



2

Ø int.14 Ø ext.55 coll.62
 long. tube int.49 ext.25 ep. coll.3

1.6i 16v. THP EP6CDT
 1.6i 16v. THP EP6CDT M
 1.6i 16v. THP EP6CDT MD
 1.6i 16v. THP EP6CDTX
 1.6 HDi DV6C
 2.0 HDi FAP DW10CB DTR
 2.0 HDi FAP DW10CTED4

Bras & Triangle de suspension

Control arm
 Brazo y triángulo
 Wahacz
 Рычаг подвески

G/L D/R

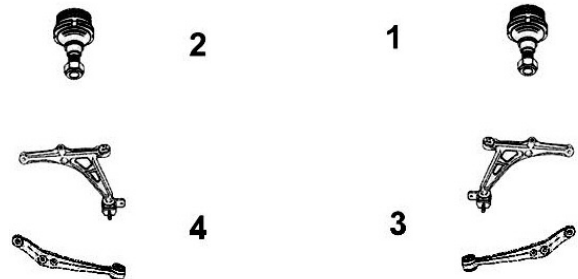

6403533
 OE 364073

Rotule de susp. inf. G/D
L/R lower suspension ball joint



1
2

1.6i 16v. THP EP6CDT /M/MD EP6CDTX
 1.6 HDi DV6C
 1.6 HDi FAP DV6FC
 2.0 HDi FAP DW10CB DTR DW10CTED4 DW10FC

...DS5



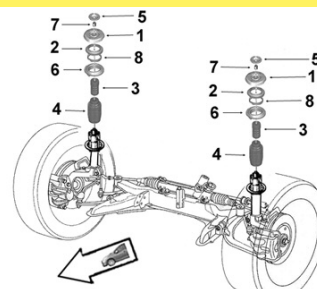

Support d'amortisseur

Suspension mounting
Soporte amortiguador
Poduszka amortyzatora
Опора амортизатора



CITROEN





0355275 OE 503563	Butée à billes G/D <i>L/R ball bearing</i>	2650035 OE 503151	Coupelle amortisseur G/D <i>L/R shock absorber cup</i>
	2 1.6i 16v. /THP EP6CDT /X 1.6 HDi FAP DV6C 2.0 HDi /4WD FAP DW10CTED4		6 1.6i 16v. THP EP6CDT/M/MD/X -29/04/12 1.6 HDi DV6C -29/04/12 2.0 HDi FAP DW10CB DTR -29/04/12 DW10CTED4 2.0 HDi FAP Hybride DW10CTED4 -29/04/12

Eléments TRAIN ARRIERE

Rear axle parts
Tren TRAS
Elementy zawieszenia tylnego
элементы задней оси.







2600004 OE 5131F2	Articulation essieu <i>Axle bush</i>	2600005 OE 5131K0	Articulation essieu <i>Axle bush</i>
	Ø int. 14 Ø ext. 80 coll. 87 long. tube int. 79 ext. 59 ep. coll.7 Bonne route 1.6i 16v. THP EP6CDT /X 1.6 HDi FAP DV6C 2.0 HDi FAP Sauf hybride DW10CTED4		Ø int. 14 Ø ext. 81 coll. 97 long. tube int. 79 ext. 54 ep. coll.8 Route inégale 1.6i 16v. THP EP6CDT/M/MD EP6CDTX 1.6 HDi DV6C 2.0 HDi FAP DW10CB DTR 2.0 HDi FAP Sauf hybride DW10CTED4

Evasion...

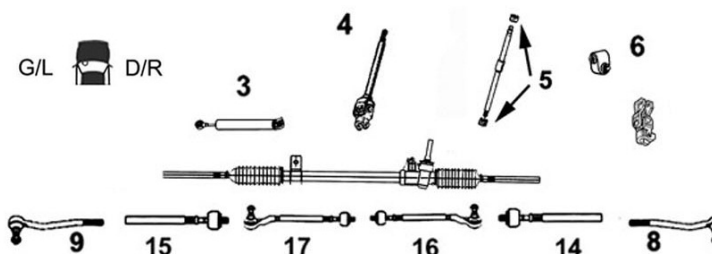
Eléments DIRECTION

Steering parts
Elementos Direcciones
Elementy układ kierowniczy
Элементы рулевой системы



3008069 OE 3812A4	Axe de bielle G/D <i>L/R axial joint</i>	1034F64 OE 4103F6	Axe de volant <i>Steering wheel shaft</i>
	14 15 Côté dir. M14x1.5 Côté rot. M14x1.5 long 306 mm TT /all models 06/94-		4 Conduite à G 1.8i 1.9 TD 2.0i /16v. 2.0i Turbo 2.0 HDi 2.1 TD
0594094 OE 405909	Rotule de direction G/D <i>L/R tie rod end</i>		
	8 9 M14 x 1.5 TT /all models 06/94-		

... Evasion...

SASIC

CITROEN



Barre stabilisatrice
 Stabilizer bar
 Barra estabilizadora
 Drażek stabilizatora
 стабилизатор поперечной устойчивости

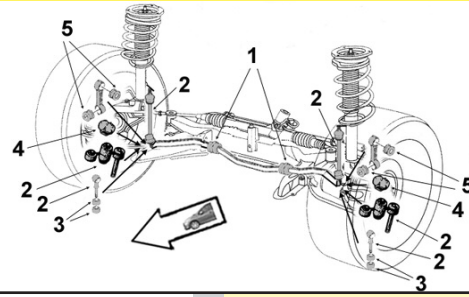

0875355
OE 508735

Biellette barre stab.
Stabilizer bar stub axle



2
1.8i
1.9 TD
2.0i
2.0i Turbo
2.0i 16v.
2.0 HDi sans FAP
2.1 TD

0935155
OE 509315

Liaison élastique
Elastic link



3 Ø int.12.5 Ø ext.37.5
long. tube int.20 ext.22
1.8i
1.9 TD
2.0i
2.0i Turbo
2.0i 16v.
2.0 HDi sans FAP
2.1 TD

0945695
OE 509469

Palier de barre milieu
Middle bar main bearing



1 Barre Ø 24
1.8i
1.9 TD
2.0i
2.0i Turbo
2.0i 16v.
2.0 HDi sans FAP
2.1 TD

Bras & Triangle de suspension

Control arm
Brazo y triángulo
Wahacz
Рычаг подвески

G/L D/R

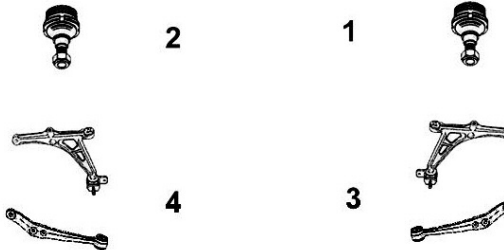

5203943
OE 3520P4

Triangle de susp. G
Left track control arm



4 Avec rotule With ball joint

TT /all models 06/94-

5213643
OE 3521K4

Triangle de susp. D
Right track control arm



3 Avec rotule With ball joint

TT /all models 06/94-

...Evasion...





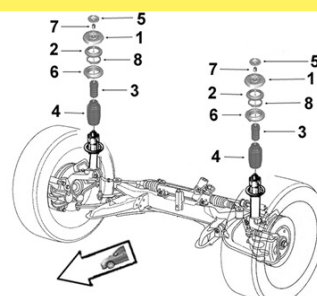



Support d'amortisseur
 Suspension mounting
 Soporte amortiguador
 Poduszka amortyzatora
 Опора амортизатора



CITROEN



<p>0385165 OE 503868</p>	<p>Support suspension G <i>Left suspension mounting</i></p>	<p>0385175 OE 503870</p>	<p>Support suspension D <i>Right suspension mounting</i></p>
	<p>1 1.8i 1.9 TD 2.0i 2.0i 16v. 2.0i Turbo 2.0 HDi sans FAP 2.1 TD</p>		<p>1 1.8i 1.9 TD 2.0i 2.0i 16v. 2.0i Turbo 2.0 HDi sans FAP 2.1 TD</p>
<p>0355385 Butée à billes G/D OE 503543 <i>L/R ball bearing</i></p>			
	<p>2 1.8i 1.9 TD 2.0i 2.0i 16v. 2.0i Turbo 2.0 HDi 2.1 TD</p>		
<p>0335395 Butée de suspension G/D OE 503339 <i>L/R suspension bush</i></p>			
	<p>3 H105 1.8i 1.9 TD 2.0i 2.0i 16v. 2.0i Turbo 2.0 HDi sans FAP 2.1 TD</p>		
<p>2545195 Protecteur amortisseur G/D OE 525446 <i>L/R shock absorber protector</i></p>			
	<p>4 1.8i 1.9 TD 2.0i 2.0i 16v. 2.0i Turbo 2.0 HDi sans FAP 2.1 TD</p>		
<p>1005263 OE -</p>	<p>Kit rép. suspension G <i>Left susp. mounting repair kit</i></p>	<p>1005264 OE -</p>	<p>Kit rép. suspension D <i>Right susp. mounting repair kit</i></p>
	<p>TT /all models DA 06/94-</p>		<p>TT /all models DA 06/94-</p>

...Evasion



Support d'amortisseur
 Suspension mounting
 Soporte amortiguador
 Poduszka amortyzatora
 Опора амортизатора

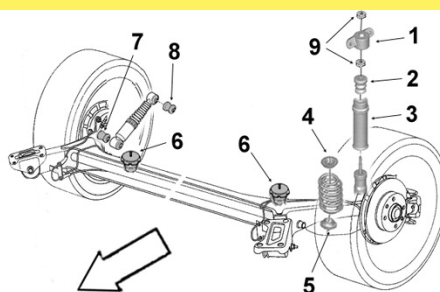

1665475

OE 516647

Butée de talonnage

Bushing

6 Ø 55 H102

1.8i
 1.9 TD
 2.0i
 2.0i Turbo
 2.0i 16v.
 2.0 HDi
 2.1 TD



Eléments TRAIN ARRIERE

Rear axle parts

Tren TRAS

Elementy zawieszenia tylnego

элементы задней оси.



1525615

OE 515261

Articulation essieu AR

Rear axle bush

Ø int.12 Ø ext.46 long. tube int.60 ext.48

1.8i
 1.9 TD
 2.0i
 2.0i Turbo
 2.0i 16v.
 2.0 HDi sans FAP
 2.1 TD



LN LNA...

Eléments DIRECTION

Steering parts

Elementos Direcciones

Elementy uklad kierowniczy

Элементы рулевой системы

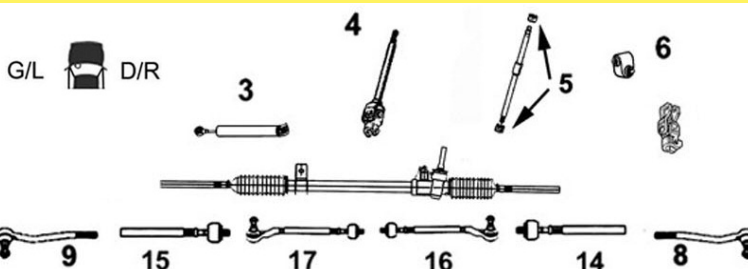

3008153

OE -

Axe de bielle G/D

L/R axial joint

14 Côté dir. M12x1.0
15 Côté rot. M14x1.5 long 262 mm

TT /all models



8123153B1

OE 381215

Bielle de direction G/D

L/R steering rod

16
17

TT /all models



8173183

OE 381750

Rotule de direction G/D

L/R tie rod end

8 M14 x 1.5
9

TT /all models



...LN LNA

Bras & Triangle de suspension

Control arm
Brazo y triángulo
Wahacz
Рычаг подвески

G/L  D/R



5203343

OE 91504358

Bras de suspension G

Left track control arm

4 Avec rotule *With ball joint*



TT /all models

5213233

OE 91504359

Bras de suspension D

Right track control arm

3 Avec rotule *With ball joint*



TT /all models

Nemo VL...

Eléments DIRECTION

Steering parts
Elementos Direcciones
Elementy układ kierowniczy
Элементы рулевой системы

G/L  D/R

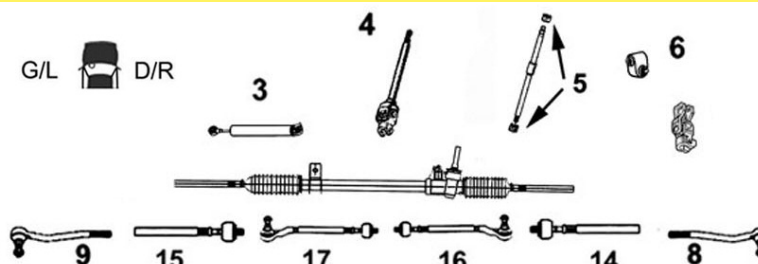

7770013

Part/oe 400177

Axe de bielle G/D

L/R axial joint

NEW



14 Côté dir. M14x1.5 Côté rot. M14x1.5 long 276 mm
15

1.3 HDi FAP
1.4i
1.4i
1.4 HDi

F13DTE5
TU3A
TU3AE5
DV4TED

BVM

7670008

OE 381786

Rotule de direction G

Left tie rod end

9 M14 x 1.5



1.3 HDi FAP F13DTE5

1.4i TU3A
1.4i TU3AE5

1.4 HDi DV4TED

7670009

OE 381787

Rotule de direction D

Right tie rod end

8 M14 x 1.5



1.3 HDi FAP F13DTE5

1.4i TU3A
1.4i TU3AE5

1.4 HDi DV4TED

...Nemo VL...

CITROEN



Barre stabilisatrice
 Stabilizer bar
 Barra estabilizadora
 Drążek stabilizatora
 стабилизатор поперечной устойчивости

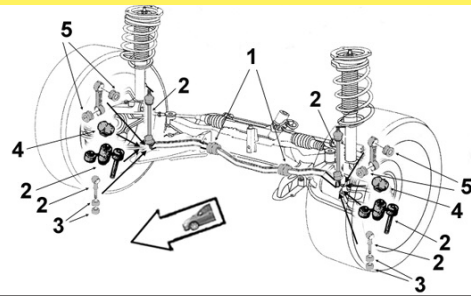

2300043 Palier de barre milieu
 OE 5094C8 Middle bar main bearing



1 Barre Ø 20
 1.3 HDi FAP F13DTE5 -17/12/07
 1.4i TU3A -17/12/07
 1.4i TU3AE5 -17/12/07
 1.4 HDi DV4TED -17/12/07

2300041 Palier de barre milieu
 OE 5094E5 Middle bar main bearing



1 Barre Ø 21
 1.3 HDi FAP F13DTE5 18/12/07-
 1.4i TU3A 18/12/07-
 1.4i TU3AE5 18/12/07-
 1.4 HDi DV4TED 18/12/07-



Eléments SUSPENSION
 Suspension parts
 Elementos suspensión
 Elementy zawieszenie
 Элементы подвески

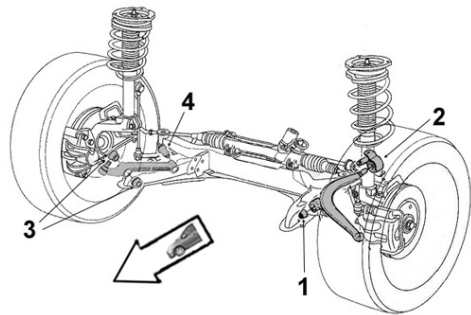

2256032 Articulation AV
 Part/oe 3520Y4 Front bush



1 Ø int. 12.5 Ø ext. 42 coll. 43 coll. 50.5
 long.tube int. 67.5 ext. 41
 1.3 HDi FAP F13DTE5
 1.4i TU3AE5

2256009 Articulation AR
 Part/oe 3520Y4 Rear bush



2 Ø int. 12.5 Ø ext. 73
 long. tube int. 66 ext. 27.5
 1.3 HDi FAP F13DTE5
 1.4i TU3AE5

Bras & Triangle de suspension

Control arm
 Brazo y triángulo
 Wahacz
 Рычаг подвески

G/L D/R

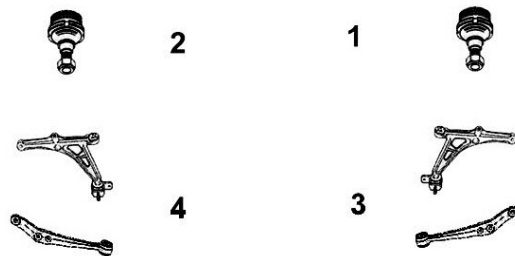

7470005 Triangle de susp. G
 OE 3520Y4 Left track control arm



4 Avec rotule With ball joint
 1.3 HDi FAP F13DTE5
 1.4i TU3A
 1.4i TU3AE5
 1.4 HDi DV4TED

7470006 Triangle de susp. D
 OE 3521V5 Right track control arm



3 Avec rotule With ball joint
 1.3 HDi FAP F13DTE5
 1.4i TU3A
 1.4i TU3AE5
 1.4 HDi DV4TED

...Nemo VL

CITROEN



7570004 Rotule de susp. inf. G/D

Part/oe 3520Y4L/R lower suspension ball joint



1
2

1.3 HDi FAP
1.4i
1.4 HDi

F13DTE5
TU3A/E5
DV4TED



Support d'amortisseur

Suspension mounting
Soporte amortiguador
Poduszka amortyzatora
Опора амортизатора

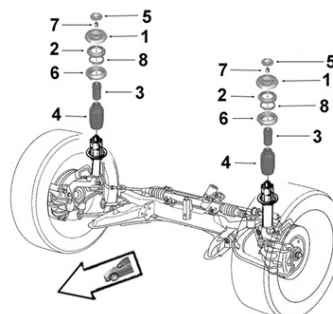

2650031 Support suspension G

OE 1609274780 Left suspension mounting

1



1.3 HDi FAP F13DTE5
1.4i TU3A/E5
1.4 HDi DV4TED

2650032 Support suspension D

OE 1609274680 Right suspension mounting

1



1.3 HDi FAP F13DTE5
1.4i TU3A/E5
1.4 HDi DV4TED

2650025 Butée de suspension G/D

OE 5033F2 L/R suspension bush

3



1.3 HDi FAP
1.4i
1.4 HDi

F13DTE5
TU3A/E5
DV4TED

Eléments TRAIN ARRIERE

Rear axle parts
Tren TRAS
Elementy zawieszenia tylnego
элементы задней оси.



2600012 Articulation essieu

OE 5131G8 Axle bush

Ø int. 13 Ø ext. 69 coll. 80 long. tube int.94 ext. 100 ep. coll. 2.5



1.4i TU3AE5

Saxo...

Eléments DIRECTION

Steering parts

Elementos Direcciones

Elementy układ kierowniczy

Элементы рулевой системы

G/L  D/R

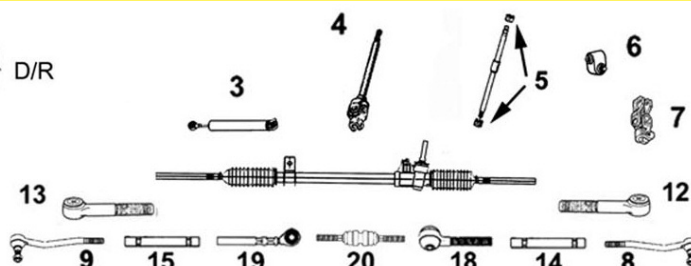

CITROEN

SASIC

3008075

Axe de bielle G/D

Part/oe 3812A0

L/R axial joint



14 Côté dir. M14x1.5 Côté rot. M14x1.5
15 long 380 mm

TT /all models 01/96-

3008074

Embout axe de bielle G/D

OE 381732

L/R nozzle Axial joint



18
19

TT /all models DNA -08/09/96

3008077

Rotule centrale dir.

OE 381747

Middle tie rods end



20

TT /all models DNA 09/09/96-

TT /all models DA 04/96-

8173303

Rotule de direction G

OE 381741

Left tie rod end



9 M14 x 1.5

TT /all models 01/96-

8173313

Rotule de direction D

OE 381742

Right tie rod end



8 M14 x 1.5

TT /all models 01/96-



Barre stabilisatrice

Stabilizer bar

Barra estabilizadora

Drażek stabilizatora

стабилизатор поперечной устойчивости

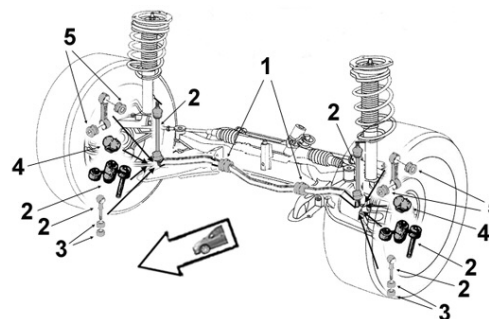

0875405

Biellette barre stab.

OE 508740

Stabilizer bar stub axle



2 1.4i VTS AM98 1/2 TU3JP
1.6i 90hp 66kw susp. normale TU5JP
1.6i 100hp 74kw TU5JP
1.6i 16v. /VTS susp. normale TU5J4

0945595

Palier de barre bout

OE 509459

End bar main bearing







4 **Barre Ø 19 noir**
1.0i susp. normale sans air bag TU9M -30/08/99
1.0i susp. réhaussée TU9M -15/07/97
1.1i susp. normale sauf VTS AM98 1/2 DNA sans ABS sans air bag TU1M+ -30/08/99
1.1i Susp. réhaussée TU1M+ -15/07/97
1.4i GPL/ essence sans plomb TU3JP

... Saxo...

CITROEN



0945605 Palier de barre bout OE 509460 <i>End bar main bearing</i>				
	4 Barre Ø 21 blanc 1.0i susp. normale avec air bag TU9M -30/08/99 1.0i susp. normale TU9M 31/08/99- 1.0i Susp. réhaussée TU9M 16/07/97- 1.0i Berline comm. 3ptes susp. normale TU9M 1.1i susp. normale Sauf VTS AM98 1/2 Dir. assistée ou ABS ou air bag TU1M+ -30/08/99 1.1i susp. normale TU1M+ 31/08/99- 1.1i susp. normale TU1JP 1.1i Susp. réhaussée TU1M+ 16/07/97- 1.1i Berline comm. 3ptes susp. normale TU1M+ TU1JP 1.4i susp. normale sauf VTS AM98 1/2 TU3JP 1.4i Berline comm. 3ptes susp. normale TU3JP 1.5 D TUD5/B 1.5 D Berline comm. 3ptes susp. normale TUD5 TUD5B 1.6i /16v. /VTS Berline comm. 3ptes susp. normale TU5JP TU5J4			
	0945565 Palier de barre milieu OE 509456 <i>Middle bar main bearing</i>			
		1 Barre Ø 19 1.0i susp. normale sans air bag TU9M -30/08/99 1.0i Susp. réhaussée TU9M -15/07/97 1.1i susp. normale sauf VTS AM98 1/2 Dir. mécanique sans ABS sans air bag TU1M+ -30/08/99 1.1i Susp. réhaussée TU1M+ -15/07/97 1.4i GPL/ essence sans plomb TU3JP		
		0945575 Palier de barre milieu OE 509457 <i>Middle bar main bearing</i>		
			1 Barre Ø 21 1.0i susp. normale avec air bag TU9M -30/08/99 1.0i susp. normale TU9M 31/08/99- 1.0i Susp. réhaussée TU9M 16/07/97- 1.0i Berline comm. 3ptes susp. normale TU9M 1.1i sauf VTS AM98 1/2 Dir. assistée ou ABS ou air bag susp. normale TU1M+ -30/08/99 1.1i susp. normale TU1JP 1.1i Susp. réhaussée TU1M+ 16/07/97- 1.1i / GPL susp. normale TU1M+ 31/08/99- 1.1i Berline comm. 3ptes susp. normale TU1M+ TU1JP 1.4i susp. normale sauf VTS AM98 1/2 TU3JP 1.4i Berline comm. 3ptes susp. normale TU3JP 1.5 D TUD5/B 1.6i /16v. /VTS Berline comm. 3ptes susp. normale TU5JP TU5J4	
			0945715 Palier de barre milieu OE 509471 <i>Middle bar main bearing</i>	0945725 Palier de barre milieu OE 509472 <i>Middle bar main bearing</i>
				1 Barre Ø 22 1.4i VTS AM98 1/2 TU3JP 1.6i 100hp 74kw TU5JP 1.6i 16v. /VTS susp. normale TU5J4 1.6i 90hp 66kw susp. normale TU5JP disques AR

...Saxo...



Eléments SUSPENSION
Suspension parts
Elementos suspensión
Elementy zawieszenie
Элементы подвески

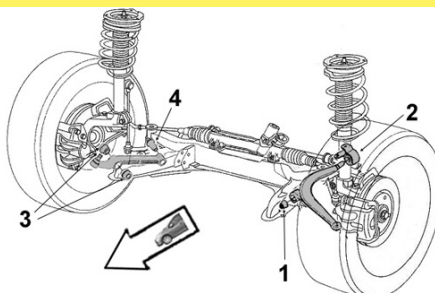

CITROËN

SASIC

5233503

OE 352350

Articulation AV

Front bush



1 Ø int.12 Ø ext.34 coll.28 long. tube int.48.5 ext.30

- 1.0i Berline comm. 3ptes susp. réhaussée
- 1.1i sauf VTS AM98 1/2
- 1.1i
- 1.1i
- 1.4i sauf VTS AM98 1/2
- 1.4i Berline comm. 3ptes susp. réhaussée
- 1.5 D /Berline comm. 3ptes susp. réhaussée
- 1.6i /16v. /VTS Berline comm. 3ptes susp. réhaussée
- Electric

- TU9M
- TU1M+ -30/08/99
- TU1M+ 31/08/99-
- TU1JP
- TU3JP
- TU3JP
- TUD5/B
- TU5JP TU5J4
- Electric 30 (20kw)

5233523

OE 352352

Articulation AV

Front bush



1 Ø int.12 Ø ext.34 coll.44 long. tube int.48 ext.35.5 ep. coll.5

- 1.0i Sauf berline comm. 3ptes susp. réhaussée
- 1.1i Sauf berline comm. 3ptes susp. réhaussée
- 1.4i VTS AM98 1/2
- 1.4i Sauf berline comm. 3ptes susp. réhaussée
- 1.5 D Sauf berline comm. 3ptes susp. réhaussée
- 1.6i 16v. /VTS
- 1.6i Sauf berline comm. 3ptes susp. réhaussée
- 1.6i

- TU9M
- TU1M+ TU1JP
- TU3JP
- TU3JP
- TUD5 TUD5B
- TU5J4
- TU5JP TU5J4
- TU5JP

5233513

OE 352351

Articulation AR

Rear bush



2 Ø int.17

- 1.0i / Berline comm. 3ptes susp. réhaussée
- 1.1i sauf VTS AM98 1/2
- 1.1i
- 1.1i
- 1.1i Berline comm. 3ptes susp. réhaussée
- 1.4i sauf VTS AM98 1/2
- 1.4i Berline comm. 3ptes susp. réhaussée
- 1.5 D /Berline comm. 3ptes susp. réhaussée
- 1.6i /16v. /VTS Susp. normale /Berline comm. 3ptes susp. réhaussée
- Electric

- TU9M
- TU1M+ -30/08/99
- TU1M+ 31/08/99-
- TU1JP
- TU1M+ TU1JP
- TU3JP
- TU3JP
- TUD5 TUD5B
- TU5JP TU5J4
- Electric 30 (20kw)

Bras & Triangle de suspension

Control arm
Brazo y triángulo
Wahacz
Рычаг подвески

G/L D/R



5203783

OE 352078

Triangle de susp. G

Left track control arm



4 Avec rotule With ball joint

- TT /all models
- Sauf 1.6i et VTS mot. TU5JP TU5J4 01/96-

5203793

OE 352079

Triangle de susp. D

Right track control arm











3 Avec rotule With ball joint

- TT /all models
- Sauf 1.6i et VTS mot. TU5JP TU5J4 01/96-

...Saxo...

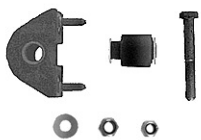
CITROEN

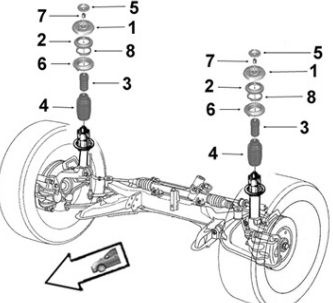

<p>5203923 OE 352092</p> 	<p>Triangle de susp. G <i>Left track control arm</i></p> <p>4 Avec rotule With ball joint</p> <p>1.6i /VTS TU5JP 01/96-</p>	<p>5203933 OE 352093</p> 	<p>Triangle de susp. D <i>Right track control arm</i></p> <p>3 Avec rotule With ball joint</p> <p>1.6i /VTS TU5JP 01/96-</p>																					
<p>6403363 OE 364036</p> 	<p>Rotule de susp. inf. G/D <i>L/R lower suspension ball joint</i></p> <p>1 Ø 16</p> <p>TT /all models 01/96-</p>	<p>1153578 OE -</p> 	<p>Kit rép. train AV <i>Front axle repair kit</i></p> <p>Barre Ø 19</p> <p>TT /all models Sauf 1.6i et VTS mot. TU5JP TU5J4 01/96-</p>																					
<p>1153579 OE -</p> 	<p>Kit rép. train AV <i>Front axle repair kit</i></p> <p>Barre Ø 21</p> <p>TT /all models Sauf 1.6i et VTS mot. TU5JP TU5J4 01/96-</p>	<p>1003561 OE -</p> 	<p>Kit rép. triangle susp. G ou D <i>L or R track control arm bearing repair kit</i></p> <p>Avec visserie With screws and bolts</p> <p>TT /all models Sauf 1.6i et VTS mot. TU5JP TU5J4 01/96-</p>																					
<div style="display: flex; justify-content: space-between;"> <div data-bbox="203 1234 492 1436">  <p>Support d'amortisseur <i>Suspension mounting</i> <i>Soporte amortiguador</i> <i>Poduszka amortyzatora</i> <i>Опора амортизатора</i></p> </div> <div data-bbox="1029 1180 1359 1482">  </div> </div>																								
<p>0385155 OE 503850</p> 	<p>Support suspension G/D <i>L/R suspension mounting</i></p> <p>1</p> <table border="0"> <tr> <td>1.0i</td> <td>Susp. normale</td> <td>TU9M</td> </tr> <tr> <td>1.1i</td> <td>Susp. normale</td> <td>TU1M+ / TU1JP</td> </tr> <tr> <td>1.4i</td> <td>Susp. réhaussée bonne route ou Berline comm. susp. normale</td> <td>TU3JP</td> </tr> <tr> <td>1.5 D</td> <td>Susp. réhaussée bonne route ou Berline comm. susp. normale</td> <td>TUD5 TUD5B</td> </tr> <tr> <td>1.6i</td> <td>Susp. réhaussée bonne route ou Berline comm. susp. normale</td> <td>TU5JP</td> </tr> <tr> <td>1.6i 16v.</td> <td>susp. normale</td> <td>TU5J4</td> </tr> <tr> <td>Electric</td> <td></td> <td>Electric 30 (20kw)</td> </tr> </table>			1.0i	Susp. normale	TU9M	1.1i	Susp. normale	TU1M+ / TU1JP	1.4i	Susp. réhaussée bonne route ou Berline comm. susp. normale	TU3JP	1.5 D	Susp. réhaussée bonne route ou Berline comm. susp. normale	TUD5 TUD5B	1.6i	Susp. réhaussée bonne route ou Berline comm. susp. normale	TU5JP	1.6i 16v.	susp. normale	TU5J4	Electric		Electric 30 (20kw)
1.0i	Susp. normale	TU9M																						
1.1i	Susp. normale	TU1M+ / TU1JP																						
1.4i	Susp. réhaussée bonne route ou Berline comm. susp. normale	TU3JP																						
1.5 D	Susp. réhaussée bonne route ou Berline comm. susp. normale	TUD5 TUD5B																						
1.6i	Susp. réhaussée bonne route ou Berline comm. susp. normale	TU5JP																						
1.6i 16v.	susp. normale	TU5J4																						
Electric		Electric 30 (20kw)																						
<p>0355275 OE 503563</p> 	<p>Butée à billes G/D <i>L/R ball bearing</i></p> <p>2</p> <table border="0"> <tr> <td>1.0i</td> <td>Susp. normale</td> <td>TU9M</td> </tr> <tr> <td>1.1i</td> <td>Susp. normale</td> <td>TU1M+ / TU1JP</td> </tr> <tr> <td>1.4i</td> <td>Susp. réhaussée bonne route ou Berline comm. susp. normale</td> <td>TU3JP</td> </tr> <tr> <td>1.5 D</td> <td>Susp. réhaussée bonne route ou Berline comm. susp. normale</td> <td>TUD5 TUD5B</td> </tr> <tr> <td>1.6i</td> <td>Susp. réhaussée bonne route ou Berline comm. susp. normale</td> <td>TU5JP</td> </tr> <tr> <td>1.6i 16v.</td> <td>susp. normale</td> <td>TU5J4</td> </tr> <tr> <td>Electric</td> <td></td> <td>Electric 30 (20kw)</td> </tr> </table>			1.0i	Susp. normale	TU9M	1.1i	Susp. normale	TU1M+ / TU1JP	1.4i	Susp. réhaussée bonne route ou Berline comm. susp. normale	TU3JP	1.5 D	Susp. réhaussée bonne route ou Berline comm. susp. normale	TUD5 TUD5B	1.6i	Susp. réhaussée bonne route ou Berline comm. susp. normale	TU5JP	1.6i 16v.	susp. normale	TU5J4	Electric		Electric 30 (20kw)
1.0i	Susp. normale	TU9M																						
1.1i	Susp. normale	TU1M+ / TU1JP																						
1.4i	Susp. réhaussée bonne route ou Berline comm. susp. normale	TU3JP																						
1.5 D	Susp. réhaussée bonne route ou Berline comm. susp. normale	TUD5 TUD5B																						
1.6i	Susp. réhaussée bonne route ou Berline comm. susp. normale	TU5JP																						
1.6i 16v.	susp. normale	TU5J4																						
Electric		Electric 30 (20kw)																						

...Saxo...

SASIC

CITROEN



Support d'amortisseur

Suspension mounting
Soporte amortiguador
Poduszka amortyzatora
Опора амортизатора

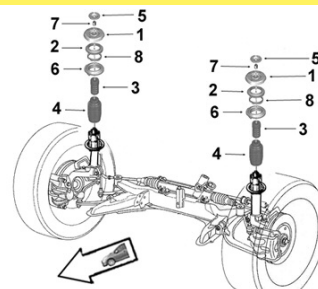

0335355

OE 503335

Butée de suspension G/D

L/R suspension bush



3

H66

1.0i Susp. normale
1.1i susp. normale sauf VTS AM98 1/2
1.1i
1.4i Berline comm. susp. normale
1.5 D Berline comm. susp. normale
1.6i 90hp 66kw Susp. normale Tambours AR
1.6i Berline comm. 3ptes susp. normale
Electric

TU9M
TU1M+ -01/06/98
TU1JP
TU3JP
TUD5 TUD5B
TU5JP
TU5JP
Electric 30 (20kw)

0335365

OE 503336

Butée de suspension G/D

L/R suspension bush



3

H90

1.1i VTS AM98 1/2
1.4i Susp. réhaussée bonne route
1.5 D Susp. réhaussée bonne route
1.6i 90hp 66kw susp. normale Disques AR
1.6i 100hp 74kw susp. normale
1.6i Susp. réhaussée bonne route
1.6i 16v. susp. normale

TU1M+ -01/06/98
TU3JP
TUD5 TUD5B
TU5JP
TU5JP
TU5JP
TU5J4

2545185

OE 525418

Protecteur amortisseur G/D

L/R shock absorber protector



4

1.0i Susp. normale TU9M
1.1i TU1M+/ TU1JP
1.4i Susp. réhaussée bonne route ou
Berl. comm. susp. normale TU3JP
1.5 D Susp. réhaussée bonne route ou
Berl. comm. susp. normale TUD5/B
1.6i Susp. réhaussée bonne route ou
Berl. comm. susp. normale TU5JP
1.6i 16v. Susp. normale TU5J4
Electric Electric 30 (20kw)

1005262

OE -

Kit rép. suspension G ou D

L/R stabilizing bar repair kit



1.0i TU9M 01/96-
1.1i TU1M+ 01/96-
1.4i TU3JP 01/96-
1.5 D TUD5/B 01/96-
1.6i TU5JP 01/96-



Support d'amortisseur

Suspension mounting
Soporte amortiguador
Poduszka amortyzatora
Опора амортизатора

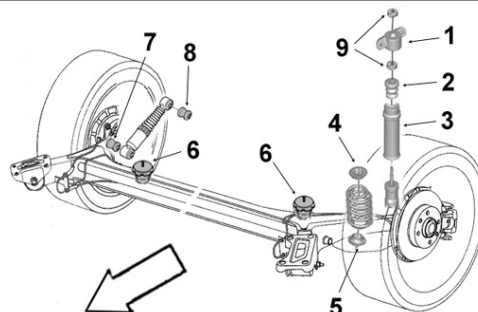

1665375

OE 516637

Butée de talonnage

Bushing



6

H48

1.0i susp. normale sans airbag ou
sans barre stab. TU9M -30/08/99
1.1i sans barre stab. TU1JP -04/12/00
1.1i DNA susp. normale sans ABS
ou sans barre stab. TU1M+ -08/99

1665625

OE 516662

Butée de talonnage

Bushing



6

H56

1.0i Avec barre stab. AV
susp. normale TU9M 03/96-
1.1i Avec barre stab. AV
susp. normale TU1JP/M+ 03/96-
1.4i susp. normale TU3JP 03/96-
1.5 D susp. normale TUD5 03/96-
1.6i /16v. /VTS TU5JP/J2/J4
03/96-

...Saxo

Eléments TRAIN ARRIERE

Rear axle parts

Tren TRAS

Elementy zawieszenia tylnego

элементы задней оси.



CITROËN



1315635

Articulation traverse

OE 513163

Cross bar bush



Ø int.12 Ø ext.33 coll.57 long. tube int.47 ext.25.5 ep. coll.13

1.0i	TU9M
1.1i	TU1M+/ TU1JP
1.4i	TU3JP
1.5 D	TUD5/B
1.6i	TU5JP
1.6i 16v. /VTS	TU5J4

Visa...

Eléments DIRECTION

Steering parts

Elementos Direcciones

Elementy układ kierowniczy

Элементы рулевой системы

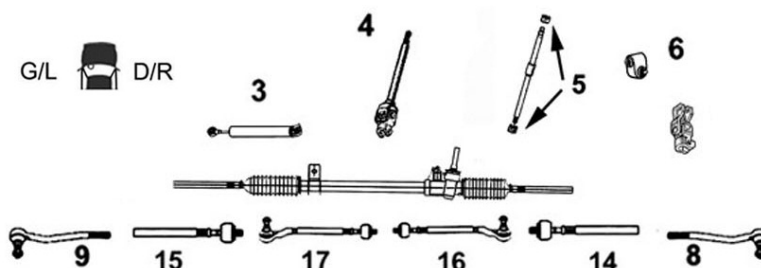

3008153

Axe de bielle G/D

OE -

L/R axial joint



14 Côté dir. M12x1.0
15 Côté rot. M14x1.5 long 262 mm

954 1.0
1124 1.1
1360 1.4

8123953

Axe de bielle G/D

OE 96136394

L/R axial joint



14 Côté dir. M12x1.0
15 Côté rot. M14x1.5 long 314 mm

1.8 D

8123153B1

Bielle de direction G/D

OE 381215

L/R steering rod



16
17
954 1.0
1124 1.1
1360 1.4

8123323B1

Bielle de direction G/D

OE 381295

L/R steering rod



16
17
1.8 D

8173183

Rotule de direction G/D

OE 381750

L/R tie rod end



8
9
M14 x 1.5
954 1.0
1124 1.1
1360 1.4
1.8 D

2004005

Axe de volant

OE 95496537

Steering wheel shaft



4
1.8 D

...Visa...

CITROEN



Barre stabilisatrice
 Stabilizer bar
 Barra estabilizadora
 Drażek stabilizatora
 стабилизатор поперечной устойчивости

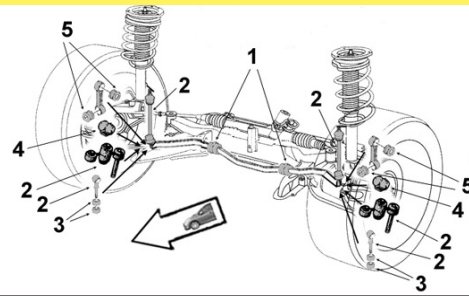

0945335
 OE 509433

Palier de barre
 Bar main bearing



1 Barre Ø 20

TT /all models

0945375
 OE 509437

Palier de barre
 Bar main bearing



1 Barre Ø 22 vert

1.8 D

0935045

OE 91503310

Liaison élastique
 Elastic link



Ø 17.5 x Ø 48 - 11

TT /all models Sauf diesel et GTi



Eléments SUSPENSION
 Suspension parts
 Elementos suspensión
 Elementy zawieszenie
 Элементы подвески

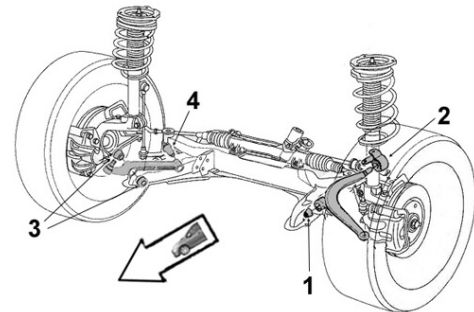

5233143

OE 352314

Articulation ext.
 Outer bush



3 Ø int.14 Ø ext.38 long. tube int.42 ext.24

TT /all models

5233273UN

OE 352349

Articulation ext.
 Outer bush



3 Ø int.12 Ø ext.36 coll.47
 long. tube int.25 ext.15 ep. coll.8.5

TT /all models

5233203

OE 352320

Articulation int.
 Inner bush



4 Ø int.10 Ø ext.28 long. tube int.34 ext.28

TT /all models

5233233

OE 352323

Articulation int.
 Inner bush



4 Ø int.12 Ø ext.31 coll.42
 long. tube int.38 ext.26.5 ep. coll.6.5

TT /all models

...Visa...

Bras & Triangle de suspension

Control arm
Brazo y triángulo
Wahacz
Рычаг подвески

G/L  D/R



CITROEN



...Visa



Support d'amortisseur
Suspension mounting
Soporte amortiguador
Poduszka amortyzatora
Опора амортизатора

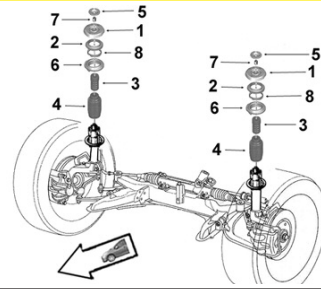

0335275

OE 503327



Butée de suspension G/D

L/R suspension bush

3 H97

1.8 D

0355185

OE 503155



Kit rép. support susp. G/D

L/R susp. mounting repair kit

(Tampon caoutchouc+Butée à billes)
Rubber top + Ball bearing

1.6 GTi
 1.8 D

Xantia...

Eléments DIRECTION

Steering parts

Elementos Direcciones

Elementy uklad kierowniczy

Элементы рулевой системы

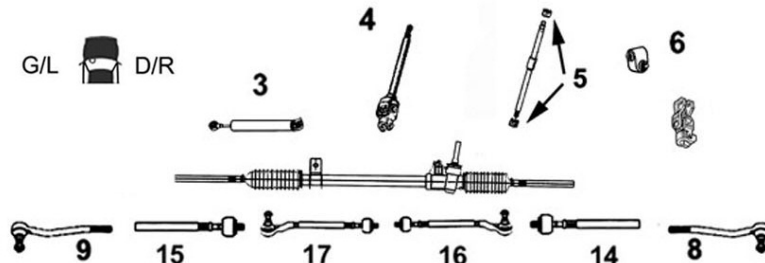

0054A14

OE 4005A1



Vérin dir. assistée

Power steering jack

3 TT /all models sauf 2.0i 16v. mot. XU10J4 Repère X1L -05/95
 Repère X1L Course mécanisme dir. 80.5

1.6i	XU5JP	06/95-12/97
1.8i	XU7JB	02/06/97-12/97
1.8i /16v.	XU7JP/4	06/95-12/97
1.9 D	XUD9A	06/95-01/06/97
1.9 TD	XUD9TE	06/95-12/97
1.9 TD SD	XUD9SD	06/95-12/97
2.0i	XU10J2	06/95-12/97

8123953

Part/oe 381295



Axe de bielle G/D

L/R axial joint

14 Côté dir. M12x1.0
15 Côté rot. M14x1.5 long 314 mm

TT /all models DNA
 TT /all models DA
 Sauf 2.0 Turbo XU10J2TE 01/06/95-
 2.1TD XUD11BTE 01/06/95-
 Sauf 2.0 HDi sans FAP DW10ATED
 12/97-
 Sauf 3.0i V6 ES9J4 14/05/96-

3008154

Part/oe 3812A9



Axe de bielle G/D

L/R axial joint

14 Côté dir. M12x1.0
15 Côté rot. M16x1.5 long 312 mm

2.0i Turbo DA XU10J2TE 06/95-
 2.0 HDi sans FAP DW10ATED 12/97-
 2.1 TD DA XUD11BTE 06/95-
 3.0i V6 DA ES9J4 14/05/96-

2006109

OE -



Bielle de direction G

Left steering rod

17 Rotule M14 x 1.5

TT /all models DNA
 TT /all models DA
 Sauf 2.0 Turbo XU10J2TE 01/06/95-
 Sauf 2.1TD XUD11BTE 01/06/95-
 Sauf 2.0 HDi sans FAP DW10ATED
 12/97-
 Sauf 3.0i V6 ES9J4 14/05/96-

2006110

OE -



Bielle de direction D

Right steering rod











16 Rotule M14 x 1.5

TT /all models DNA
 TT /all models DA
 Sauf 2.0 Turbo XU10J2TE 01/06/95-
 Sauf 2.1TD XUD11BTE 01/06/95-
 Sauf 2.0 HDi sans FAP DW10ATED
 12/97-
 Sauf 3.0i V6 ES9J4 14/05/96-

... Xantia ...

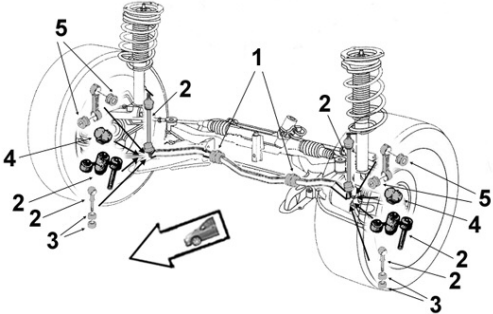
CITROEN

SASIC

8173303 OE 381741	Rotule de direction G <i>Left tie rod end</i>	8173313 OE 381742	Rotule de direction D <i>Right tie rod end</i>
	9 M14 x 1.5 TT /all models DNA TT /all models DA Sauf 2.0 Turbo XU10J2TE 01/06/95- Sauf 2.1TD XUD11BTE 01/06/95- Sauf 2.0 HDi sans FAP DW10ATED 12/97- Sauf 3.0i V6 ES9J4 14/05/96-		8 M14 x 1.5 TT /all models DNA TT /all models DA Sauf 2.0 Turbo XU10J2TE 01/06/95- Sauf 2.1TD XUD11BTE 01/06/95- Sauf 2.0 HDi sans FAP DW10ATED 12/97- Sauf 3.0i V6 ES9J4 14/05/96-
8173433 OE 381743	Rotule de direction G <i>Left tie rod end</i>	8173443 OE 381744	Rotule de direction D <i>Right tie rod end</i>
	9 M16 x 1.5 2.0i Turbo DA XU10J2TE 06/95- 2.0 HDi sans FAP DW10ATED 12/97- 2.1 TD DA XUD11BTE 06/95- 3.0i V6 DA ES9J4 14/05/96-		8 M16 x 1.5 2.0i Turbo DA XU10J2TE 06/95- 2.0 HDi sans FAP DW10ATED 12/97- 2.1 TD DA XUD11BTE 06/95- 3.0i V6 DA ES9J4 14/05/96-
2004006 OE 96079308	Axe de volant <i>Steering wheel shaft</i>		
	4 TT /all models DA -12/05/96		
	Barre stabilisatrice Stabilizer bar Barra estabilizadora Drażek stabilizatora стабилизатор поперечной устойчивости		
			
2005202 OE 96145457	Biellette barre stab. <i>Stabilizer bar stub axle</i>	0875405 OE 508740	Biellette barre stab. <i>Stabilizer bar stub axle</i>
	2 M10 TT /all models -18/12/94		2 TT /all models Sans antidevers actif 19/12/94-03/03/99 TT /all models Avec antidevers actif
0875485 OE 508748	Biellette barre stab. <i>Stabilizer bar stub axle</i>	2005276 OE 96089104	Palier de barre <i>Bar main bearing</i>
	2 M12 x 175 TT /all models Sans antidevers actif 04/03/99-		1 Barre Ø 22 TT /all models Berline sans antidevers actif Sauf XU10J4 -31/05/95

... Xantia ...

SASIC

CITROEN



Barre stabilisatrice
 Stabilizer bar
 Barra estabilizadora
 Drażek stabilizatora
 стабилизатор поперечной устойчивости

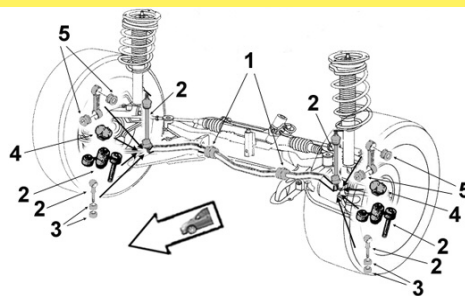

2005277

OE 96089106

Palier de barre

Bar main bearing

1 Barre Ø 23

TT /all models Break
 sans antidevers actif

2.0i 16v. Berline sans antidevers actif
 XU10J4 -05/95



0945735

OE 509473

Palier de barre

Bar main bearing

1 Barre Ø 28

TT /all models Sans antidevers actif



Eléments SUSPENSION

Suspension parts

Elementos suspensión

Elementy zawieszenie

Элементы подвески

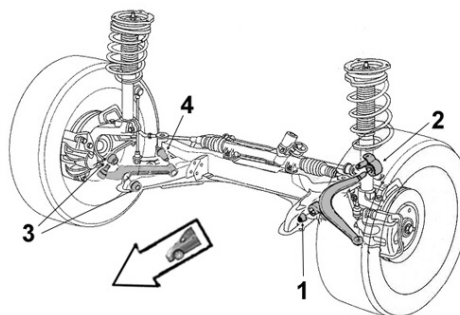

2005260

OE 96083570

Articulation AV G/D

L/R front bush

1 Ø int.12 Ø ext.37 coll.45.5 long. tube int.38 ext.32 ep. coll.5

TT /all models



2005258

OE 352381

Articulation AR G

Left rear bush

2 Ø int.18

TT /all models



2005259

OE 352382

Articulation AR D

Right rear bush

2 Ø int.18

TT /all models



... Xantia ...

Bras & Triangle de suspension

Control arm
Brazo y triángulo
Wahacz
Рычаг подвески

G/L  D/R



CITROEN



...Xantia

Eléments TRAIN ARRIERE







Rear axle parts

Tren TRAS

Elementy zawieszenia tylnego

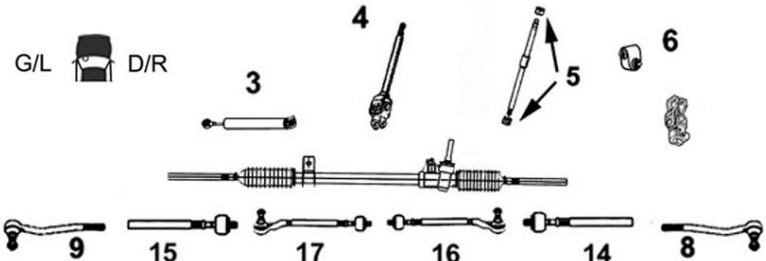
элементы задней оси.







2001012 OE 96176180 	Support AR traverse AR <i>Rear cross bar rear mounting</i> TT /all models 02/05/95-	2001013 OE 96176177 	Articulation AR <i>Rear bush</i> Ø int. 14 Ø ext.68 coll.88 long. tube int.54 ext.39 ep. coll.14 TT /all models 02/05/95-
2005150 OE -  Kit rép. train AR G ou D <i>L/R rear axle repair kit</i> TT /all models			
<div style="text-align: center;"> XM... </div> <div style="display: flex; justify-content: space-between; align-items: flex-start;"> <div style="width: 30%;"> Eléments DIRECTION <i>Steering parts</i> <i>Elementos Direcciones</i> <i>Elementy uklad kierowniczy</i> <i>Элементы рулевой системы</i> </div> <div style="width: 60%; text-align: center;">  <p style="font-size: small;">G/L D/R</p> </div> </div>			
2006161 OE 96168072 	Vérin dir. assistée <i>Power steering jack</i> 3 TT /all models Sauf Diravi -07/94	8123993 Part/oe 381299 	Axe de bielle G/D <i>L/R axial joint</i> 14 Côté dir. M12x1.0 Côté rot. M14x1.5 15 long 295 mm TT /all models Assistance non variable
3008156 Part/oe 3812A6  Axe de bielle G/D <i>L/R axial joint</i> 14 Côté dir. M12x1.0 Côté rot. M16x1.5 15 long 293 mm TT /all models Assistance non variable			

...XM...

CITROEN



<p>8173303 OE 381741</p> 	<p>Rotule de direction G <i>Left tie rod end</i></p> <p>9 M14 x 1.5</p> <p>TT /all models</p>	<p>8173313 OE 381742</p> 	<p>Rotule de direction D <i>Right tie rod end</i></p> <p>8 M14 x 1.5</p> <p>TT /all models</p>
<p>8173433 OE 381743</p> 	<p>Rotule de direction G <i>Left tie rod end</i></p> <p>9 M16 x 1.5</p> <p>TT /all models</p>	<p>8173443 OE 381744</p> 	<p>Rotule de direction D <i>Right tie rod end</i></p> <p>8 M16 x 1.5</p> <p>TT /all models</p>



Barre stabilisatrice
Stabilizer bar
Barra estabilizadora
Drażek stabilizatora
стабилизатор поперечной устойчивости

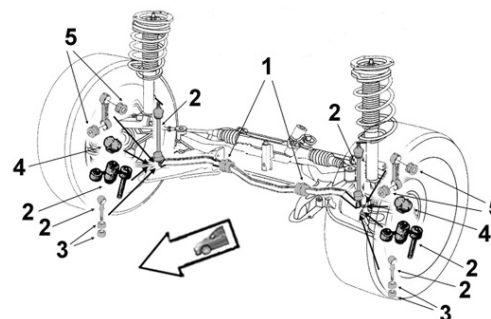



<p>0875415 OE 508749</p> 	<p>Biellette barre stab. <i>Stabilizer bar stub axle</i></p> <p>2</p> <p>TT /all models</p>
---	--

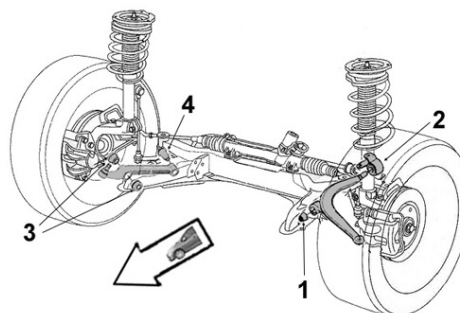

Eléments SUSPENSION
Suspension parts
Elementos suspensión
Elementy zawieszenie
Элементы подвески



<p>5233433 OE 352343</p> 	<p>Articulation AV <i>Front bush</i></p> <p>1 Ø int.14 Ø ext.40 coll.54.5 long. tube int.27.5 ext.27 ep. coll.9</p> <p>TT /all models</p>	<p>5233573 OE 352357</p> 	<p>Articulation AR <i>Rear bush</i></p> <p>2 Ø int.20.2 Ø ext.50 long. tube int.45 ext.40</p> <p>TT /all models</p>
---	--	---	--

... XM...

Bras & Triangle de suspension

Control arm
 Brazo y triángulo
 Wahacz
 Рычаг подвески

G/L  D/R

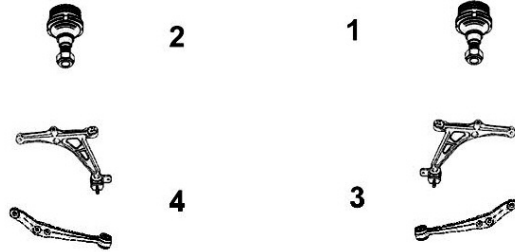

6403343
 OE 364071

Rotule de susp. inf. G/D
L/R lower suspension ball joint



1 M14 x 1.5
2
 TT /all models



Support d'amortisseur
Suspension mounting
 Soporte amortiguador
 Poduszka amortyzatora
 Опора амортизатора

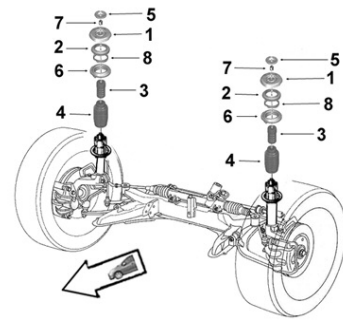

0335455
 OE 503345

Butée de suspension G/D
L/R suspension bush



3 H41.5
 2.0i Turbo XU10J2TE 07/94-
 2.1 TD XUD11ATE 07/94-
 2.1 TD XUD11BTE 07/94-
 2.5 TD DK5ATE 07/94-
 3.0i V6 Susp. hydractive ES9J4 07/94-
 3.0i V6 ZPJ 07/94-



Barre stabilisatrice
Stabilizer bar
 Barra estabilizadora
 Drażek stabilizatora
 стабилизатор поперечной устойчивости

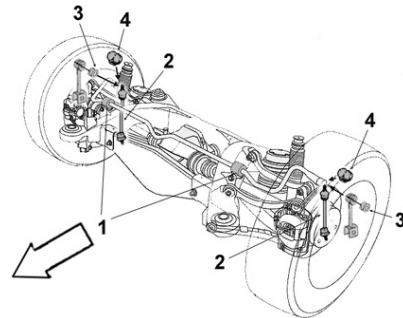

1785435
 OE 517843

Biellette G barre stab. AR
Rear stabilizer bar stub axle left



2
 TT /all models

1785315
 OE 517844

Biellette D barre stab. AR
Rear stabilizer bar stub axle right



2
 TT /all models

...XM

Eléments TRAIN ARRIERE

Rear axle parts

Tren TRAS

Elementy zawieszenia tylnego

элементы задней оси.



CITROEN



2001012 OE 96176180	Support AR traverse AR Rear cross bar rear mounting	2001013 OE 96176177	Articulation AR Rear bush
	TT /all models		Ø int. 14 Ø ext.68 coll.88 long. tube int.54 ext.39 ep. coll.14 TT /all models

Xsara...

Eléments DIRECTION

Steering parts

Elementos Direcciones

Elementy uklad kierowniczy

Элементы рулевой системы

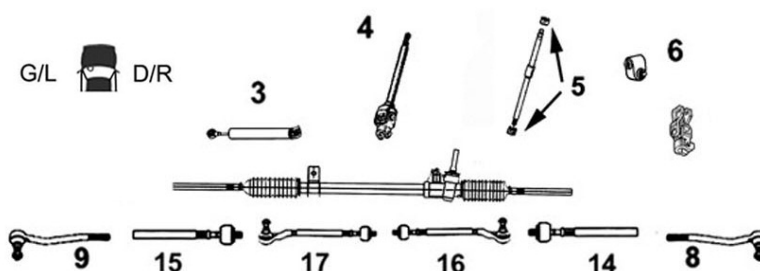

0114444 OE 401144	Vérin dir. assistée Power steering jack
	3 1.4i 1.4 HDi 1.5 D 1.6i 1.6i 16v. 1.8i 1.8i 16v. 1.8 D 1.9 D 1.9 TD 2.0i 16v. 2.0 HDi

2006021 OE 96048007581	Axe de bielle G/D L/R axial joint
	14 Côté dir. M12x1.0 Côté rot. M14x1.5 long 340 mm 15 1.4i 1.4 HDi 1.5 D 1.6i 1.6i 16v. 1.8i 1.8i 16v. 1.8 D 1.9 D 1.9 TD 2.0i 16v. 2.0 HDi

...Xsara...

Eléments DIRECTION
 Steering parts
 Elementos Direcciones
 Elementy układ kierowniczy
 Элементы рулевой системы

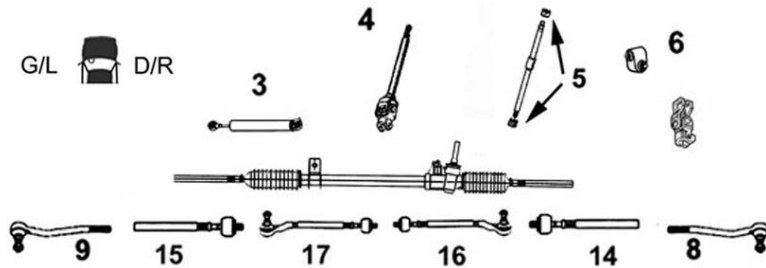

8173183 Rotule de direction G/D
 OE 381750 L/R tie rod end



- 8** M14x1.5
9
 1.4i
 1.4 HDi
 1.5 D
 1.6i
 1.6i 16v.
 1.8i
 1.8i 16v.
 1.8 D
 1.9 D
 1.9 TD
 2.0i 16v.
 2.0 HDi



Barre stabilisatrice
 Stabilizer bar
 Barra estabilizadora
 Drażek stabilizatora
 стабилизатор поперечной устойчивости

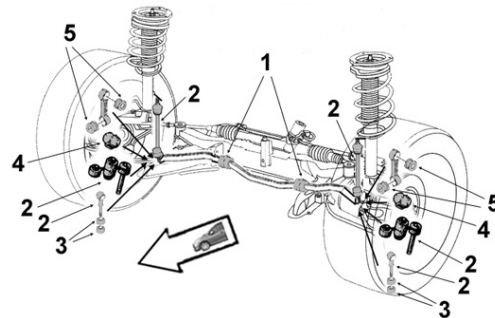

0875395 Bielle barre stab.
 OE 508761 Stabilizer bar stub axle



- 2**
 1.4i
 1.4 HDi
 1.5 D
 1.6i
 1.6i 16v.
 1.8i
 1.8i 16v.
 1.8 D
 1.9 D
 1.9 TD
 2.0i 16v.
 2.0 HDi

2005273 Palier de barre milieu
 OE 96158745 Middle bar main bearing



- 1** Barre Ø 18
- | | | |
|---|----------|-------------|
| 1.4i Berline /Coupé sauf susp. réhaussée | TU3JP | 07/97-08/00 |
| 1.5 D Berline sauf susp. réhaussée | TUD5 | 07/97-08/00 |
| 1.8 D Berline /Coupé sauf susp. réhaussée | XUD7 | 07/97-08/00 |
| 1.9 D Berline sauf susp. réhaussée | DW8 | 07/97-08/00 |
| 1.9 D Berline /Coupé sauf susp. réhaussée | XUD9/BSD | 07/97-08/00 |

...Xsara...

0945665

OE 509466

Palier de barre milieu

Middle bar main bearing



1 Barre Ø 19

1.4i Berline susp. normale ou Berline comm.	TU3JP	09/00-
1.6i 16v. Berline susp. normale	TU5JP4	09/00-
1.6i 90hp 66kw Berline sauf susp. réhaussée	TU5JP4 sauf BVA AL4	07/97-08/00
1.8i 16v. ess. sans plomb Berline sauf susp. réhaussée	XU7JP4	07/97-08/00
1.8i Berline /Coupé sauf susp. réhaussée	XU7JB/P	07/97-08/00
1.9 D Berline susp. normale ou Berline comm.	DW8B	09/00-
1.9 TD Berline /Coupé sauf susp. réhaussée	XUD9TE	07/97-08/00
2.0i 16v. Berline susp. normale	EW10J4 DW10TD	09/00-
2.0 HDi Berline comm.	DW10TD	09/00-
2.0 HDi Berline VP sans FAP susp. normale	DW10ATED	09/00-

0945795

OE 509479

Palier de barre milieu

Middle bar main bearing



1 Barre Ø 20

1.4i Berline susp. normale	TU3JP	04/97-
1.4 HDi Berline susp. normale	DV4TD	09/00-
1.5 D Berline sauf susp. réhaussée	TUD5	10/97-
1.6i 90hp 66kw Berline sauf susp. réhaussée	TU5JP BVA AL4	07/97-08/00
1.8i	XU7JB	04/97-09/00
1.8i 16v. GPL/essence sans plomb Berl. sauf susp. réhaussée	XU7JP4	07/97-08/00
1.8 D	XUD7	04/97-09/00
1.8 TD	XUD7TE	10/97-09/00
1.9 D	DW8	07/98-03/05
1.9 D	XUD9	04/97-09/00
1.9 TD	XUD9TE/Y/BSD	04/94-09/00
2.0i 16v. Berline sauf susp. réhaussée	XU10J4/R/RS	07/97-
2.0 HDi Berline sauf susp. réhaussée	DW10TD	07/97-08/00
TT /all models Break		07/97-08/00
TT /all models Break sauf 1.6i 16v. Mot. TU5JP4 susp. normale	Sauf BVA	09/00-
TT /all models Sauf 1.6i 16v. Mot. TU5JP4 Susp. renforcée AV AR	BVA	09/00-
Sauf 2.0i 16v. Mot. XU10J4RS Susp. réhaussée		07/97-08/00
Sauf 2.0i 16v. Mot. XU10J4RS Susp. renforcée AV AR	BVM	09/00-
Sauf 2.0i 16v. Mot. EW10J4 Susp. renforcée AV AR	BVA	09/00-

0945655

OE 509465

Palier de barre milieu

Middle bar main bearing



1 Barre Ø 21

1.6i 16v. Break Susp. normale	TU5JP4	BVA	09/00-
1.6i 16v. Susp. renforcée AV AR	TU5JP4	BVA	09/00-
2.0i 16v. Berline sauf susp. réhaussée	XU10J4RS		07/97-08/00
2.0i 16v. Susp. réhaussée	XU10J4RS		07/97-08/00
2.0i 16v. Susp. renforcée AV AR	XU10J4RS	BVM	09/00-
2.0i 16v. Susp. renforcée AV AR	EW10J4	BVA	09/00-



Eléments SUSPENSION

Suspension parts

Elementos suspensión

Elementy zawieszenie

Элементы подвески

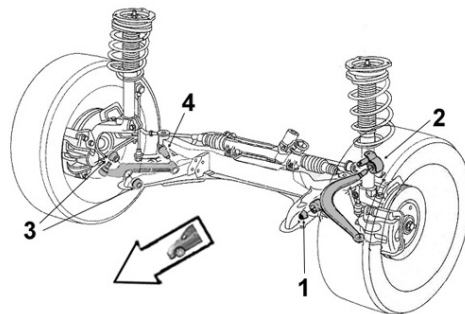

5233623

OE 352375

Articulation AR

Rear bush



2 Ø int.19

Susp. réhaussée

1.9 TD	XUD9TE	-08/11/99
2.0i 16v.	XU10J4R	-08/00
2.0i 16v.	XU10J4RS	-08/11/99
2.0 HDi	DW10TD	-08/00

5233AC3

OE 3523AC

Articulation AR

Rear bush



2 Ø int.19

1.4i	09/00-
1.4 HDi	09/00-
1.6i 16v.	09/00-
1.9 D	09/00-
2.0i 16v.	09/00-
2.0 HDi	09/00-

...Xsara...

CITROEN

SASIC

Bras & Triangle de suspension

Control arm
Brazo y triángulo
Wahacz
Рычаг подвески

G/L  D/R

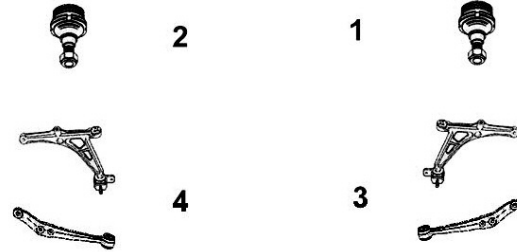

5203F73

OE 3520H4/G2

Triangle de susp. G

Left track control arm

4 Sans rotule Without tie rod end



Sauf susp. réhaussée

1.4i	07/97-08/00
1.5 D	07/97-08/00
1.6i	07/97-08/00
1.8i	07/97-08/00
1.8i16v.	07/97-08/00
1.8 D	07/97-08/00
1.9 D	07/97-08/00
1.9 TD	07/97-08/00
2.0i 16v.	07/97-08/00
2.0 HDi	07/97-08/00

Susp. normale

1.4i	09/00-
1.4 HDi	09/00-
1.6i 16v.	09/00-
1.9 D	09/00-
2.0i 16v. Break	EW10J4 09/00-
2.0i 16v.	XU10J4RS 09/00-
2.0 HDi	DW10TD 09/00-
2.0 HDi sans FAP	DW10ATED 09/00-
BVM	09/00-

5213A73

OE 3521E4/E6

Triangle de susp. D

Right track control arm

3 Sans rotule Without tie rod end



Sauf susp. réhaussée

1.4i	07/97-08/00
1.5 D	07/97-08/00
1.6i	07/97-08/00
1.8i	07/97-08/00
1.8i16v.	07/97-08/00
1.8 D	07/97-08/00
1.9 D	07/97-08/00
1.9 TD	07/97-08/00
2.0i 16v.	07/97-08/00
2.0 HDi	07/97-08/00

Susp. normale

1.4i	09/00-
1.4 HDi	09/00-
1.6i 16v.	09/00-
1.9 D	09/00-
2.0i 16v. Break	EW10J4 09/00-
2.0i 16v.	XU10J4RS 09/00-
2.0 HDi	DW10TD 09/00-
2.0 HDi sans FAP	DW10ATED 09/00-
BVM	09/00-

5203J33

OE 3520J9

Triangle de susp. G

Left track control arm

4 Avec rotule With ball joint



Susp. renforcée AV AR

1.4i	09/00-
1.4 HDi	09/00-
1.6i 16v.	09/00-
1.9 D	09/00-
2.0i 16v.	09/00-
2.0 HDi	09/00-

Susp. normale

2.0 HDi sans FAP DW10ATED BVA 09/00-

5213F33

OE 3521F9

Triangle de susp. D

Right track control arm

3 Avec rotule With ball joint



Susp. renforcée AV AR

1.4i	09/00-
1.4 HDi	09/00-
1.6i 16v.	09/00-
1.9 D	09/00-
2.0i 16v.	09/00-
2.0 HDi	09/00-

Susp. normale

2.0 HDi sans FAP DW10ATED BVA 09/00-

7470017

OE (2oe)3520H5+364043 Left track control arm

Triangle de susp. G

Left track control arm

4 Avec rotule With ball joint Ø 16



Sauf susp. réhaussée

1.4i	07/97-08/00
1.5 D	07/97-08/00
1.6i	07/97-08/00
1.8i	07/97-08/00
1.8i 16v.	07/97-08/00
1.8 D	07/97-08/00
1.9 D	07/97-08/00
1.9 TD	07/97-08/00
2.0i 16v.	07/97-08/00
2.0 HDi	07/97-08/98

Susp. normale

2.0i 16v. Berline 3ptes EW10J4 09/00-

7470016

OE (2oe)3521E5+364043 Right track control arm

Triangle de susp. D

Right track control arm

3 Avec rotule With ball joint Ø 16







Sauf susp. réhaussée

1.4i	07/97-08/00
1.5 D	07/97-08/00
1.6i	07/97-08/00
1.8i	07/97-08/00
1.8i 16v.	07/97-08/00
1.8 D	07/97-08/00
1.9 D	07/97-08/00
1.9 TD	07/97-08/00
2.0i 16v.	07/97-08/00
2.0 HDi	07/97-08/98

Susp. normale

2.0i 16v. Berline 3ptes EW10J4 09/00-

...Xsara...

	7470019 Triangle de susp. G	7470018 Triangle de susp. D																																																																														
	OE (2oe)3520H5+364051 <i>Left track control arm</i>	OE (2oe)3521E5+364050 <i>Right track control arm</i>																																																																														
	<p style="text-align: center;">NEW</p> <p>4 Avec rotule With ball joint Ø 18</p> <p>Sauf susp. réhaussée</p> <table style="width: 100%; border-collapse: collapse;"> <tr><td>1.4i</td><td>07/97-08/00</td></tr> <tr><td>1.5 D</td><td>07/97-08/00</td></tr> <tr><td>1.6i</td><td>07/97-08/00</td></tr> <tr><td>1.8i</td><td>07/97-08/00</td></tr> <tr><td>1.8 D</td><td>07/97-08/00</td></tr> <tr><td>1.9 D</td><td>07/97-08/00</td></tr> <tr><td>1.9 TD</td><td>07/97-08/00</td></tr> <tr><td>2.0i 16v.</td><td>07/97-08/00</td></tr> <tr><td>2.0 HDi</td><td>07/97-08/00</td></tr> </table> <p>Susp. normale</p> <table style="width: 100%; border-collapse: collapse;"> <tr><td>1.4 HDi</td><td>DV4TD</td><td>09/00-</td></tr> <tr><td>1.6i 16v.</td><td>TU5JP4</td><td>09/00-</td></tr> <tr><td>1.9 D</td><td>DW8B</td><td>09/00-</td></tr> <tr><td>2.0i 16v./Break</td><td>EW10J4</td><td></td></tr> <tr><td></td><td>XU10J4RS</td><td>09/00-</td></tr> <tr><td>2.0 HDi</td><td>DW10TD</td><td>09/00-</td></tr> <tr><td>2.0 HDi sans FAP</td><td>DW10ATEDBVM</td><td>09/00-</td></tr> </table>	1.4i	07/97-08/00	1.5 D	07/97-08/00	1.6i	07/97-08/00	1.8i	07/97-08/00	1.8 D	07/97-08/00	1.9 D	07/97-08/00	1.9 TD	07/97-08/00	2.0i 16v.	07/97-08/00	2.0 HDi	07/97-08/00	1.4 HDi	DV4TD	09/00-	1.6i 16v.	TU5JP4	09/00-	1.9 D	DW8B	09/00-	2.0i 16v./Break	EW10J4			XU10J4RS	09/00-	2.0 HDi	DW10TD	09/00-	2.0 HDi sans FAP	DW10ATEDBVM	09/00-	<p style="text-align: center;">NEW</p>  <p>3 Avec rotule With ball joint Ø 18</p> <p>Sauf susp. réhaussée</p> <table style="width: 100%; border-collapse: collapse;"> <tr><td>1.4i</td><td>07/97-08/00</td></tr> <tr><td>1.5 D</td><td>07/97-08/00</td></tr> <tr><td>1.6i</td><td>07/97-08/00</td></tr> <tr><td>1.8i</td><td>07/97-08/00</td></tr> <tr><td>1.8 D</td><td>07/97-08/00</td></tr> <tr><td>1.9 D</td><td>07/97-08/00</td></tr> <tr><td>1.9 TD</td><td>07/97-08/00</td></tr> <tr><td>2.0i 16v.</td><td>07/97-08/00</td></tr> <tr><td>2.0 HDi</td><td>07/97-08/00</td></tr> </table> <p>Susp. normale</p> <table style="width: 100%; border-collapse: collapse;"> <tr><td>1.4 HDi</td><td>DV4TD</td><td>09/00-</td></tr> <tr><td>1.6i 16v.</td><td>TU5JP4</td><td>09/00-</td></tr> <tr><td>1.9 D</td><td>DW8B</td><td>09/00-</td></tr> <tr><td>2.0i 16v./Break</td><td>EW10J4</td><td></td></tr> <tr><td></td><td>XU10J4RS</td><td>09/00-</td></tr> <tr><td>2.0 HDi</td><td>DW10TD</td><td>09/00-</td></tr> <tr><td>2.0 HDi sans FAP</td><td>DW10ATEDBVM</td><td>09/00-</td></tr> </table>	1.4i	07/97-08/00	1.5 D	07/97-08/00	1.6i	07/97-08/00	1.8i	07/97-08/00	1.8 D	07/97-08/00	1.9 D	07/97-08/00	1.9 TD	07/97-08/00	2.0i 16v.	07/97-08/00	2.0 HDi	07/97-08/00	1.4 HDi	DV4TD	09/00-	1.6i 16v.	TU5JP4	09/00-	1.9 D	DW8B	09/00-	2.0i 16v./Break	EW10J4			XU10J4RS	09/00-	2.0 HDi	DW10TD	09/00-	2.0 HDi sans FAP	DW10ATEDBVM	09/00-
1.4i	07/97-08/00																																																																															
1.5 D	07/97-08/00																																																																															
1.6i	07/97-08/00																																																																															
1.8i	07/97-08/00																																																																															
1.8 D	07/97-08/00																																																																															
1.9 D	07/97-08/00																																																																															
1.9 TD	07/97-08/00																																																																															
2.0i 16v.	07/97-08/00																																																																															
2.0 HDi	07/97-08/00																																																																															
1.4 HDi	DV4TD	09/00-																																																																														
1.6i 16v.	TU5JP4	09/00-																																																																														
1.9 D	DW8B	09/00-																																																																														
2.0i 16v./Break	EW10J4																																																																															
	XU10J4RS	09/00-																																																																														
2.0 HDi	DW10TD	09/00-																																																																														
2.0 HDi sans FAP	DW10ATEDBVM	09/00-																																																																														
1.4i	07/97-08/00																																																																															
1.5 D	07/97-08/00																																																																															
1.6i	07/97-08/00																																																																															
1.8i	07/97-08/00																																																																															
1.8 D	07/97-08/00																																																																															
1.9 D	07/97-08/00																																																																															
1.9 TD	07/97-08/00																																																																															
2.0i 16v.	07/97-08/00																																																																															
2.0 HDi	07/97-08/00																																																																															
1.4 HDi	DV4TD	09/00-																																																																														
1.6i 16v.	TU5JP4	09/00-																																																																														
1.9 D	DW8B	09/00-																																																																														
2.0i 16v./Break	EW10J4																																																																															
	XU10J4RS	09/00-																																																																														
2.0 HDi	DW10TD	09/00-																																																																														
2.0 HDi sans FAP	DW10ATEDBVM	09/00-																																																																														
2005113	Rotule de susp. inf. G/D																																																																															
	OE 364042/43	<i>L/R lower suspension ball joint</i>																																																																														
	<p>1 Ø 16</p> <p>2</p> <p>Sauf susp. réhaussée</p> <table style="width: 100%; border-collapse: collapse;"> <tr><td>1.4i</td><td>07/97-08/00</td></tr> <tr><td>1.5 D</td><td>07/97-08/00</td></tr> <tr><td>1.6i</td><td>07/97-08/00</td></tr> <tr><td>1.8i</td><td>07/97-08/00</td></tr> <tr><td>1.8i 16v.</td><td>07/97-08/00</td></tr> <tr><td>1.8 D</td><td>07/97-08/00</td></tr> <tr><td>1.9 D</td><td>07/97-08/00</td></tr> <tr><td>1.9 TD</td><td>07/97-08/00</td></tr> <tr><td>2.0i 16v.</td><td>07/97-08/00</td></tr> <tr><td>2.0 HDi</td><td>-08/98</td></tr> </table> <p>Susp. normale</p> <table style="width: 100%; border-collapse: collapse;"> <tr><td>2.0i 16v. Berline 3ptes</td><td>EW10J4</td><td>09/00-</td></tr> </table>	1.4i	07/97-08/00	1.5 D	07/97-08/00	1.6i	07/97-08/00	1.8i	07/97-08/00	1.8i 16v.	07/97-08/00	1.8 D	07/97-08/00	1.9 D	07/97-08/00	1.9 TD	07/97-08/00	2.0i 16v.	07/97-08/00	2.0 HDi	-08/98	2.0i 16v. Berline 3ptes	EW10J4	09/00-																																																								
1.4i	07/97-08/00																																																																															
1.5 D	07/97-08/00																																																																															
1.6i	07/97-08/00																																																																															
1.8i	07/97-08/00																																																																															
1.8i 16v.	07/97-08/00																																																																															
1.8 D	07/97-08/00																																																																															
1.9 D	07/97-08/00																																																																															
1.9 TD	07/97-08/00																																																																															
2.0i 16v.	07/97-08/00																																																																															
2.0 HDi	-08/98																																																																															
2.0i 16v. Berline 3ptes	EW10J4	09/00-																																																																														
6403513	Rotule de susp. inf. G/D																																																																															
	OE 364051/52	<i>L/R lower suspension ball joint</i>																																																																														
	<p>1 Ø 18</p> <p>2</p> <p>Sauf susp. réhaussée</p> <table style="width: 100%; border-collapse: collapse;"> <tr><td>1.4i</td><td>TU3JP</td><td>07/97-08/00</td></tr> <tr><td>1.5 D</td><td>TUD5</td><td>07/97-08/00</td></tr> <tr><td>1.6i</td><td>TU5JP</td><td>07/97-08/00</td></tr> <tr><td>1.6i 16v.</td><td>TU5JP4</td><td>09/00-</td></tr> <tr><td>1.8</td><td>XU7JB</td><td>07/97-08/00</td></tr> <tr><td>1.8i 16v.</td><td>XU7JP4</td><td>07/97-08/00</td></tr> <tr><td>1.8 D</td><td>XUD7</td><td>07/97-08/00</td></tr> <tr><td>1.9 D</td><td>DW8 XU9A</td><td>07/97-08/00</td></tr> <tr><td>1.9 TD</td><td>XUD9TE</td><td>07/97-08/00</td></tr> <tr><td>1.9 TD SD</td><td>XUD9BSD</td><td>07/97-08/00</td></tr> <tr><td>2.0i 16v.</td><td>XU10J4R/S</td><td>07/97-08/00</td></tr> </table> <p>Susp. normale</p> <table style="width: 100%; border-collapse: collapse;"> <tr><td>1.4i</td><td>TU3JP</td><td>09/00-</td></tr> <tr><td>1.4 HDi</td><td>DV4TD</td><td>09/00-</td></tr> <tr><td>1.9 D</td><td>DW8B</td><td>09/00-</td></tr> <tr><td>2.0i 16v. /Break</td><td>EW10J4</td><td>09/00-</td></tr> <tr><td>2.0i 16v.</td><td>XU10J4RS</td><td>09/00-</td></tr> <tr><td>2.0 HDi</td><td>DW10TD</td><td>09/00-</td></tr> <tr><td>2.0 HDi sans FAP</td><td>DW10ATED BVM</td><td>09/00-</td></tr> </table>	1.4i	TU3JP	07/97-08/00	1.5 D	TUD5	07/97-08/00	1.6i	TU5JP	07/97-08/00	1.6i 16v.	TU5JP4	09/00-	1.8	XU7JB	07/97-08/00	1.8i 16v.	XU7JP4	07/97-08/00	1.8 D	XUD7	07/97-08/00	1.9 D	DW8 XU9A	07/97-08/00	1.9 TD	XUD9TE	07/97-08/00	1.9 TD SD	XUD9BSD	07/97-08/00	2.0i 16v.	XU10J4R/S	07/97-08/00	1.4i	TU3JP	09/00-	1.4 HDi	DV4TD	09/00-	1.9 D	DW8B	09/00-	2.0i 16v. /Break	EW10J4	09/00-	2.0i 16v.	XU10J4RS	09/00-	2.0 HDi	DW10TD	09/00-	2.0 HDi sans FAP	DW10ATED BVM	09/00-																									
1.4i	TU3JP	07/97-08/00																																																																														
1.5 D	TUD5	07/97-08/00																																																																														
1.6i	TU5JP	07/97-08/00																																																																														
1.6i 16v.	TU5JP4	09/00-																																																																														
1.8	XU7JB	07/97-08/00																																																																														
1.8i 16v.	XU7JP4	07/97-08/00																																																																														
1.8 D	XUD7	07/97-08/00																																																																														
1.9 D	DW8 XU9A	07/97-08/00																																																																														
1.9 TD	XUD9TE	07/97-08/00																																																																														
1.9 TD SD	XUD9BSD	07/97-08/00																																																																														
2.0i 16v.	XU10J4R/S	07/97-08/00																																																																														
1.4i	TU3JP	09/00-																																																																														
1.4 HDi	DV4TD	09/00-																																																																														
1.9 D	DW8B	09/00-																																																																														
2.0i 16v. /Break	EW10J4	09/00-																																																																														
2.0i 16v.	XU10J4RS	09/00-																																																																														
2.0 HDi	DW10TD	09/00-																																																																														
2.0 HDi sans FAP	DW10ATED BVM	09/00-																																																																														

...Xsara...



Support d'amortisseur

Suspension mounting
Soporte amortiguador
Poduszka amortyzatora
Опора амортизатора

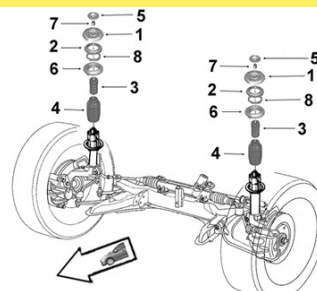

CITROEN

0385235

OE 503823

Support suspension G/D

L/R suspension mounting



1	TT /all models Berline 3/5ptes susp. réhaussée		07/97-08/00
	TT /all models Break comm. susp. normale		07/97-08/00
	TT /all models Berline comm.		07/97-08/00
	TT /all models Susp. renforcée AV AR		07/97-08/00
	1.4i Berline 3ptes	TU3JP	07/97-17/01/99
	1.4i Berline 5ptes susp. normale	TU3JP	07/97-21/02/99
	1.4i Break 5ptes susp. normale	TU3JP	07/97-08/00
	1.4i GPL/ essence sans plomb	TU3JP	07/97-08/00
	1.5 D Berline 3ptes	TUD5	07/97-17/01/99
	1.5 D Berline 5ptes susp. normale	TUD5	07/97-17/01/99
	1.5 D Break 5ptes susp. normale	TUD5	07/97-08/00
	1.6i 90hp 66kw Berline 3ptes	TU5JP	07/97-17/01/99
	1.6i 90hp 66kw Berline 5ptes susp. normale	TU5JP	07/97-11/04/99
	1.8i / GPL Break susp. normale	XU7JB/P	07/97-08/00
	1.8i 16v. Berline 3ptes	XU7JP4	07/97-17/01/99
	1.8i 16v. Berline 5ptes susp. normale	XU7JP4	07/97-11/04/99
	1.8i 16v. Break 5ptes susp. normale	XU7JP4	07/97-08/00
	1.8i Berline 3ptes	XU7JB/P	07/97-17/01/99
	1.8i Berline 5ptes susp. normale	XU7JB/P	07/97-11/04/99
	1.8 D Berline 3ptes susp. normale	XUD7	07/97-11/04/99
	1.8 D Break 5ptes susp. normale	XUD7	07/97-08/00
	1.9 D Berline 3ptes susp. normale	DW8 XUD9A	07/97-17/01/99
	1.9 D Berline 5ptes susp. normale	DW8 XUD9A	07/97-14/02/99
	1.9 D Break 5ptes susp. normale	DW8 XUD9A	07/97-08/00
	1.9 TD Berline 3ptes	XUD9TE	07/97-17/01/99
	1.9 TD Berline 5ptes susp. normale	XUD9TE	07/97-11/04/99
	1.9 TD Break 5ptes susp. normale	XUD9TE	07/97-08/00
	1.9 TD SD Berline 3ptes	XUD9BSD	07/97-17/01/99
	1.9 TD SD Berline 5ptes susp. normale	XUD9BSD	07/97-11/04/99
	1.9 TD SD Break 5ptes susp. normale	XUD9BSD	07/97-08/00
	2.0i 16v. Berline 5ptes susp. normale	XU10J4R	07/97-11/04/99
	2.0i 16v. Break 5ptes susp. normale	XU10J4R	07/97-08/00
	2.0 HDi Berline 5ptes susp. normale	DW10TD	07/97-14/02/99
2.0 HDi Break 5ptes susp. normale	DW10TD	07/97-08/00	

0385245

OE 503824





Support suspension G/D

L/R suspension mounting



1	1.4i Berline 3ptes sauf GPL + essence sans plomb	TU3JP	18/01/99-08/00
	1.4i Berline 5ptes sauf GPL + essence sans plomb	TU3JP	22/02/99-08/00
	1.5 D Berline 5ptes susp. normale	TUD5	18/01/99-08/00
	1.6i 90hp 66kw Berline 5ptes susp. normale	TU5JP	12/04/99-08/00
	1.8i / GPL /Berline 3ptes /Break	XU7JB/P	18/01/99-08/00
	1.8i 16v. Berline 3ptes	XU7JP4	18/01/99-08/00
	1.8i 16v. Berline 5ptes susp. normale	XU7JP4	12/04/99-08/00
	1.8i Berline 5ptes susp. normale	XU7JB/P	12/04/99-08/00
	1.9 D Berline 3ptes susp. normale	DW8	18/01/99-08/00
	1.9 D Berline 5ptes susp. normale	DW8	15/02/99-08/00
	1.9 D Berline 3ptes	XUD9A	18/01/99-08/00
	1.9 D Berline 5ptes susp. normale	XUD9A	12/04/99-08/00
	1.9 TD Berline 3ptes /Break	XUD9TE	18/01/99-08/00
	1.9 TD Berline 5ptes susp. normale	XUD9TE	12/04/99-08/00
	1.9 TD SD Berline 3ptes	XUD9BSD	18/01/99-08/00
	1.9 TD SD Berline 5ptes susp. normale	XUD9BSD	12/04/99-08/00
	2.0i 16v. Berline 5ptes /Break /Coupé susp. normale	XU10J4R	12/04/99-08/00
	2.0 HDi Berline 3ptes susp. normale	DW10TD	18/01/99-08/00
	2.0 HDi Berline 5ptes susp. normale	DW10TD	15/02/99-08/00

...Xsara...

0385275 OE 503827	Support suspension G/D <i>L/R suspension mounting</i>	0385225 OE 503862	Support suspension G/D <i>L/R suspension mounting</i>			
	1 2.0i 16v. Berline 3ptes XU10J4RS 07/97-08/00		1 1.4i 09/00- 1.4 HDi 09/00- 1.6i 16v. 09/00- 1.9 D 09/00- 2.0i 16v. 09/00- 2.0 HDi 09/00-			
0355275 OE 503563	Butée à billes G/D <i>L/R ball bearing</i>					
	<table style="width: 100%; border-collapse: collapse;"> <tr> <td style="width: 20%; vertical-align: top;">2</td> <td style="width: 40%; vertical-align: top;"> 1.4i TU3JP 07/97- 1.4 HDi DV4TD 09/00- 1.5 D TUD5 07/97-08/00 1.6i 90hp 66kw TU5JP 07/97-08/00 1.6i 16v. TU5JP4 09/00- 1.8i /GPL/Break XU7JB/P 07/97-08/00 1.8i 16v. XU7JP4 07/97-08/00 1.8 D XUD7 07/97-08/00 1.9 D XUD9A DW8 07/97-08/00 1.9 D DW8B 09/00- 1.9 TD XUD9TE 07/97-08/00 1.9 TD SD XUD9BSD 07/97-08/00 2.0i 16v. XU10J4R 07/97-08/00 2.0i 16v. EW10J4 09/00- 2.0i 16v. XU10J4RS 07/97- 2.0 HDi DW10TD 07/97- 2.0 HDi sans FAP DW10ATED 09/00- </td> <td style="width: 40%;"></td> </tr> </table>			2	1.4i TU3JP 07/97- 1.4 HDi DV4TD 09/00- 1.5 D TUD5 07/97-08/00 1.6i 90hp 66kw TU5JP 07/97-08/00 1.6i 16v. TU5JP4 09/00- 1.8i /GPL/Break XU7JB/P 07/97-08/00 1.8i 16v. XU7JP4 07/97-08/00 1.8 D XUD7 07/97-08/00 1.9 D XUD9A DW8 07/97-08/00 1.9 D DW8B 09/00- 1.9 TD XUD9TE 07/97-08/00 1.9 TD SD XUD9BSD 07/97-08/00 2.0i 16v. XU10J4R 07/97-08/00 2.0i 16v. EW10J4 09/00- 2.0i 16v. XU10J4RS 07/97- 2.0 HDi DW10TD 07/97- 2.0 HDi sans FAP DW10ATED 09/00-	
2	1.4i TU3JP 07/97- 1.4 HDi DV4TD 09/00- 1.5 D TUD5 07/97-08/00 1.6i 90hp 66kw TU5JP 07/97-08/00 1.6i 16v. TU5JP4 09/00- 1.8i /GPL/Break XU7JB/P 07/97-08/00 1.8i 16v. XU7JP4 07/97-08/00 1.8 D XUD7 07/97-08/00 1.9 D XUD9A DW8 07/97-08/00 1.9 D DW8B 09/00- 1.9 TD XUD9TE 07/97-08/00 1.9 TD SD XUD9BSD 07/97-08/00 2.0i 16v. XU10J4R 07/97-08/00 2.0i 16v. EW10J4 09/00- 2.0i 16v. XU10J4RS 07/97- 2.0 HDi DW10TD 07/97- 2.0 HDi sans FAP DW10ATED 09/00-					
0335275 OE 503327	Butée de suspension G/D <i>L/R suspension bush</i>					
	<table style="width: 100%; border-collapse: collapse;"> <tr> <td style="width: 20%; vertical-align: top;">3 H97</td> <td style="width: 40%; vertical-align: top;"> TT /all models Break comm. susp. normale 07/97-08/00 1.4i Berline 3ptes TU3JP 18/01/99-08/00 1.4i Berline 5ptes susp. normale TU3JP 22/02/99-08/00 1.4i Break 5ptes susp. normale TU3JP 07/97-08/00 1.4i susp. normale TU3JP 09/00- 1.4 HDi Susp. normale DV4TD 09/00- 1.5 D Berline 3ptes TUD5 18/01/99-08/00 1.5 D Berline 5ptes susp. normale TUD5 18/01/99-08/00 1.5 D Break 5ptes susp. normale TUD5 07/97-08/00 1.6i 90hp 66kw susp. normale TU5JP 12/04/99-08/00 1.6i 90hp 66kw Berline 3ptes TU5JP 18/01/99-08/00 1.6i 90hp 66kw Break 5ptes susp. normale TU5JP 07/97-08/00 1.8i 16v. Berline 3ptes XU7JP4 18/01/99-08/00 1.8i 16v. Berline 5ptes sauf GPL XU7JP4 12/04/99-08/00 + essence sans plomb susp. normale XU7JP4 07/97-08/00 1.8i 16v. Break 5ptes susp. normale XU7JP4 18/01/99-08/00 1.8i Berline 3ptes XU7JB/P 1.8i / GPL / Berline 5ptes sauf GPL XU7JB/P 12/04/99-08/00 + essence sans plomb susp. normale XU7JB/P 07/97-08/00 1.8i Break 5ptes susp. normale XUD7 07/97-08/00 1.8 D Break 5ptes susp. normale XUD7 19/04/99-08/00 1.8 D Berline 3ptes susp. normale XUD7 19/04/99-08/00 1.9 D Berline 3ptes susp. normale DW8 18/01/99-08/00 1.9 D Berline 5ptes susp. normale DW8 15/02/99-08/00 1.9 D Break 5ptes susp. normale DW8 07/97-08/00 1.9 D susp. normale DW8B 09/00- 1.9 D Berline 3ptes XUD9A 18/01/99-08/00 1.9 D Berline 5ptes susp. normale XUD9A 19/04/99-08/00 1.9 D Break 5ptes susp. normale XUD9A 07/97-08/00 1.9 TD VTS Berline 3ptes XUD9TE 07/97-08/00 1.9 TD X /P /SX Berline 3ptes XUD9TE 18/01/99-08/00 1.9 TD Berline 5ptes susp. normale XUD9TE 19/04/99-08/00 1.9 TD Break 5ptes susp. normale XUD9TE 07/97-08/00 1.9 TD SD Berline 5ptes susp. normale XUD9BSD 19/04/99-08/00 1.9 TD SD Break 5ptes susp. normale XUD9BSD 07/97-08/00 2.0i 16v. Berline 3ptes XU10J4RS 07/97-08/00 2.0i 16v. Break 5ptes susp. réhaussée XU10J4R 07/97-08/00 2.0i 16v. Break 5ptes susp. normale XU10J4R 07/97-08/00 2.0 HDi Berline 3/5ptes susp. normale DW10TD 07/97-08/00 2.0 HDi Berline 5ptes susp. normale DW10TD 15/02/99-08/00 2.0 HDi Sans FAP susp. normale DW10TD/ATED 09/00- </td> <td style="width: 40%;"></td> </tr> </table>			3 H97	TT /all models Break comm. susp. normale 07/97-08/00 1.4i Berline 3ptes TU3JP 18/01/99-08/00 1.4i Berline 5ptes susp. normale TU3JP 22/02/99-08/00 1.4i Break 5ptes susp. normale TU3JP 07/97-08/00 1.4i susp. normale TU3JP 09/00- 1.4 HDi Susp. normale DV4TD 09/00- 1.5 D Berline 3ptes TUD5 18/01/99-08/00 1.5 D Berline 5ptes susp. normale TUD5 18/01/99-08/00 1.5 D Break 5ptes susp. normale TUD5 07/97-08/00 1.6i 90hp 66kw susp. normale TU5JP 12/04/99-08/00 1.6i 90hp 66kw Berline 3ptes TU5JP 18/01/99-08/00 1.6i 90hp 66kw Break 5ptes susp. normale TU5JP 07/97-08/00 1.8i 16v. Berline 3ptes XU7JP4 18/01/99-08/00 1.8i 16v. Berline 5ptes sauf GPL XU7JP4 12/04/99-08/00 + essence sans plomb susp. normale XU7JP4 07/97-08/00 1.8i 16v. Break 5ptes susp. normale XU7JP4 18/01/99-08/00 1.8i Berline 3ptes XU7JB/P 1.8i / GPL / Berline 5ptes sauf GPL XU7JB/P 12/04/99-08/00 + essence sans plomb susp. normale XU7JB/P 07/97-08/00 1.8i Break 5ptes susp. normale XUD7 07/97-08/00 1.8 D Break 5ptes susp. normale XUD7 19/04/99-08/00 1.8 D Berline 3ptes susp. normale XUD7 19/04/99-08/00 1.9 D Berline 3ptes susp. normale DW8 18/01/99-08/00 1.9 D Berline 5ptes susp. normale DW8 15/02/99-08/00 1.9 D Break 5ptes susp. normale DW8 07/97-08/00 1.9 D susp. normale DW8B 09/00- 1.9 D Berline 3ptes XUD9A 18/01/99-08/00 1.9 D Berline 5ptes susp. normale XUD9A 19/04/99-08/00 1.9 D Break 5ptes susp. normale XUD9A 07/97-08/00 1.9 TD VTS Berline 3ptes XUD9TE 07/97-08/00 1.9 TD X /P /SX Berline 3ptes XUD9TE 18/01/99-08/00 1.9 TD Berline 5ptes susp. normale XUD9TE 19/04/99-08/00 1.9 TD Break 5ptes susp. normale XUD9TE 07/97-08/00 1.9 TD SD Berline 5ptes susp. normale XUD9BSD 19/04/99-08/00 1.9 TD SD Break 5ptes susp. normale XUD9BSD 07/97-08/00 2.0i 16v. Berline 3ptes XU10J4RS 07/97-08/00 2.0i 16v. Break 5ptes susp. réhaussée XU10J4R 07/97-08/00 2.0i 16v. Break 5ptes susp. normale XU10J4R 07/97-08/00 2.0 HDi Berline 3/5ptes susp. normale DW10TD 07/97-08/00 2.0 HDi Berline 5ptes susp. normale DW10TD 15/02/99-08/00 2.0 HDi Sans FAP susp. normale DW10TD/ATED 09/00-	
3 H97	TT /all models Break comm. susp. normale 07/97-08/00 1.4i Berline 3ptes TU3JP 18/01/99-08/00 1.4i Berline 5ptes susp. normale TU3JP 22/02/99-08/00 1.4i Break 5ptes susp. normale TU3JP 07/97-08/00 1.4i susp. normale TU3JP 09/00- 1.4 HDi Susp. normale DV4TD 09/00- 1.5 D Berline 3ptes TUD5 18/01/99-08/00 1.5 D Berline 5ptes susp. normale TUD5 18/01/99-08/00 1.5 D Break 5ptes susp. normale TUD5 07/97-08/00 1.6i 90hp 66kw susp. normale TU5JP 12/04/99-08/00 1.6i 90hp 66kw Berline 3ptes TU5JP 18/01/99-08/00 1.6i 90hp 66kw Break 5ptes susp. normale TU5JP 07/97-08/00 1.8i 16v. Berline 3ptes XU7JP4 18/01/99-08/00 1.8i 16v. Berline 5ptes sauf GPL XU7JP4 12/04/99-08/00 + essence sans plomb susp. normale XU7JP4 07/97-08/00 1.8i 16v. Break 5ptes susp. normale XU7JP4 18/01/99-08/00 1.8i Berline 3ptes XU7JB/P 1.8i / GPL / Berline 5ptes sauf GPL XU7JB/P 12/04/99-08/00 + essence sans plomb susp. normale XU7JB/P 07/97-08/00 1.8i Break 5ptes susp. normale XUD7 07/97-08/00 1.8 D Break 5ptes susp. normale XUD7 19/04/99-08/00 1.8 D Berline 3ptes susp. normale XUD7 19/04/99-08/00 1.9 D Berline 3ptes susp. normale DW8 18/01/99-08/00 1.9 D Berline 5ptes susp. normale DW8 15/02/99-08/00 1.9 D Break 5ptes susp. normale DW8 07/97-08/00 1.9 D susp. normale DW8B 09/00- 1.9 D Berline 3ptes XUD9A 18/01/99-08/00 1.9 D Berline 5ptes susp. normale XUD9A 19/04/99-08/00 1.9 D Break 5ptes susp. normale XUD9A 07/97-08/00 1.9 TD VTS Berline 3ptes XUD9TE 07/97-08/00 1.9 TD X /P /SX Berline 3ptes XUD9TE 18/01/99-08/00 1.9 TD Berline 5ptes susp. normale XUD9TE 19/04/99-08/00 1.9 TD Break 5ptes susp. normale XUD9TE 07/97-08/00 1.9 TD SD Berline 5ptes susp. normale XUD9BSD 19/04/99-08/00 1.9 TD SD Break 5ptes susp. normale XUD9BSD 07/97-08/00 2.0i 16v. Berline 3ptes XU10J4RS 07/97-08/00 2.0i 16v. Break 5ptes susp. réhaussée XU10J4R 07/97-08/00 2.0i 16v. Break 5ptes susp. normale XU10J4R 07/97-08/00 2.0 HDi Berline 3/5ptes susp. normale DW10TD 07/97-08/00 2.0 HDi Berline 5ptes susp. normale DW10TD 15/02/99-08/00 2.0 HDi Sans FAP susp. normale DW10TD/ATED 09/00-					

...Xsara...



CITROEN



Support d'amortisseur
 Suspension mounting
 Soporte amortiguador
 Poduszka amortyzatora
 Опора амортизатора

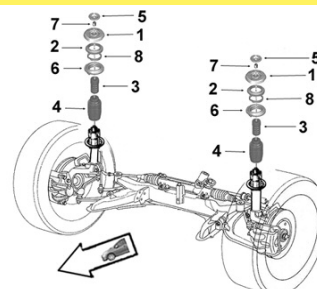

0335515

OE 503351

Butée de suspension G/D

L/R suspension bush



3
4

TT /all models Berline 3ptes susp. réhaussée	07/97-08/00
TT /all models Berline 5ptes susp. réhaussée	07/97-08/00
TT /all models Break 5ptes sauf 2.0i 16v. Mot. XU10J4R susp. réhaussée	07/97-08/00
TT /all models ess. GPL + sans plomb Berline 5ptes susp. normale	XU 07/97-08/00
2.0i 16v.	XU10J4RS 09/00-
2.0i 16v. Berline 5ptes susp. normale	XU10J4R 07/97-08/00

0335655

OE 503365

Butée de suspension G/D

L/R suspension bush



3

H109			
1.4i Berline 3/5ptes	Sauf susp. renforcée AV AR	TU3JP	09/00-
1.4 HDi Berline /Coupé	Sauf susp. renforcée AV AR	DV4TD	09/00-
1.6i 16v.	Susp. renforcée AV AR	TU5JP4	09/00-
1.9 D	Susp. renforcée AV AR	DW8B	09/00-
2.0 HDi	Susp. renforcée AV AR	DW10TD	09/00-
2.0 HDi Sans FAP	Susp. renforcée AV AR	DW10ATED	09/00-

0335405

OE 503340

Butée de suspension G/D

L/R suspension bush



3

Ø 56 H 109	
1.6i 16v. susp. normale	TU5JP4 09/00-28/04/02
2.0i 16v.	EW10J4 09/00-28/04/02

0335595

OE 503359

Butée de suspension G/D

L/R suspension bush



3

Ø 56 H 105	
1.6i 16v. susp. normale	TU5JP4 29/04/02-
2.0i 16v.	EW10J4 29/04/02-

2545135

OE 525413

Protecteur amortisseur G/D

L/R shock absorber protector



4

1.4i	TU3JP	07/97-08/00
1.5 D	TUD5	07/97-08/00
1.6i 90hp 66kw	TU5JP	07/97-08/00
1.8i /GPL /Break	XU7JB/P	07/97-08/00
1.8i 16v.	XU7JP4	07/97-08/00
1.8 D	XUD7	07/97-08/00
1.9 D	DW8 XUD9A	07/97-08/00
1.9 TD /SD	XUD9TE/BSA	07/97-08/00
2.0i 16v.	XU10J4R/S	07/97-08/00
2.0 HDi	DW10TD	07/97-08/00

2545335

OE 525433

Protecteur amortisseur G/D

L/R shock absorber protector



4

1.4i	TU3JP	09/00-
1.4 HDi	DV4TD	09/00-
1.6i 16v.	TU5JP4	09/00-
1.9 D	DW8B	09/00-
2.0i 16v.	EW10J4	09/00-
2.0i 16v.	XU10J4RS	09/00-
2.0 HDi	DW10TD	09/00-
2.0 HDi sans FAP	DW10ATED	09/00-

...Xsara...

1005250

Kit rép. protection amort. G et D

OE -

L/R susp. mounting repair kit



Butée H 97

1.4i Berline 3ptes	TU3JP	18/01/99-08/00
1.4i Berline 5ptes susp. normale	TU3JP	22/02/99-08/00
1.4i Break 5ptes /comm. susp. normale	TU3JP	07/97-08/00
1.5 D Berline 3ptes	TUD5	18/01/99-08/00
1.5 D Berline 5ptes susp. normale	TUD5	18/01/99-08/00
1.5 D Break 5ptes /comm. susp. normale	TUD5	07/97-08/00
1.6i 90hp 66kw Berline 3ptes	TU5JP	18/01/99-08/00
1.6i 90hp 66kw Berline 5ptes susp. normale	TU5JP	12/04/99-08/00
1.6i 90hp 66kw Break 5ptes /comm. susp. normale	TU5JP	07/97-08/00
1.8i Berline 3ptes	XU7JB/P	18/01/99-08/00
1.8i Berline 5ptes sauf GPL + essence sans plomb susp. normale	XU7JB/P	12/04/99-08/00
1.8i Break 5ptes /comm. susp. normale	XU7JB/P	07/97-08/00
1.8i 16v. Berline 3ptes	XU7JP4	18/01/99-08/00
1.8i 16v. Berline 5ptes sauf GPL + essence sans plomb susp. normale	XU7JP4	12/04/99-08/00
1.8i 16v. Break 5ptes /comm. susp. normale	XU7JP4	07/97-08/00
1.8 D Break 5ptes susp. normale	XUD7	07/97-08/00
1.8 D Break comm. susp. normale	XUD7	07/97-08/00
1.9 D Berline 3ptes	XUD9A	18/01/99-08/00
1.9 D Berline 5ptes susp. normale	XUD9A	19/04/99-08/00
1.9 D Break 5ptes /comm. susp. normale	XUD9A	07/97-08/00
1.9 D Berline 3ptes susp. normale	DW8	18/01/99-08/00
1.9 D Berline 5ptes susp. normale	DW8	15/02/99-08/00
1.9 D Break 5ptes /comm. susp. normale	DW8	07/97-08/00
1.9 TD X /P /SX Berline 3ptes	XUD9TE	18/01/99-08/00
1.9 TD VTS Berline 3ptes	XUD9TE	07/97-08/00
1.9 TD Berline 5ptes susp. normale	XUD9TE	19/04/99-08/00
1.9 TD Break 5ptes /comm. susp. normale	XUD9TE	07/97-08/00
1.9 TD SD Berline 5ptes susp. normale	XUD9BSD	19/04/99-08/00
1.9 TD SD Break 5ptes /comm. susp. normale	XUD9BSD	07/97-08/00
2.0i 16v. Berline 3ptes	XU10J4RS	07/97-08/00
2.0i 16v. Break 5ptes /comm. susp. normale	XU10J4R	07/97-08/00
2.0i 16v. Break 5ptes /comm. susp. réhaussée	XU10J4R	07/97-08/00

1005269

Kit rép. suspension G ou D...

OE -

L/R stabilizing bar repair kit



1.4i Berline 3ptes	TU3JP	07/97-17/01/99
1.4i GPL/ essence sans plomb	TU3JP	07/97-08/00
1.4i Berline 5ptes susp. normale	TU3JP	07/97-21/02/99
1.4i Break 5ptes /comm. susp. normale	TU3JP	07/97-08/00
1.4i Berline 3/5ptes susp. réhaussée	TU3JP	07/97-08/00
1.4i Berline comm.	TU3JP	07/97-08/00
1.4i Susp. renforcée AV AR	TU3JP	07/97-08/00
1.5 D Berline 3ptes	TUD5	07/97-17/01/99
1.5 D Berline 5ptes susp. normale	TUD5	07/97-17/01/99
1.5 D Break 5ptes /comm. susp. normale	TUD5	07/97-08/00
1.5 D Berline 3/5ptes susp. réhaussée	TUD5	07/97-08/00
1.5 D Berline comm.	TUD5	07/97-08/00
1.5 D Susp. renforcée AV AR	TUD5	07/97-08/00
1.6i 90hp 66kw Berline 3ptes	TU5JP	07/97-17/01/99
1.6i 90hp 66kw Berline 5ptes susp. normale	TU5JP	07/97-11/04/99
1.6i Berline 3/5ptes susp. réhaussée	TU5JP	07/97-08/00
1.6i Berline comm.	TU5JP	07/97-08/00
1.6i Break comm. susp. normale	TU5JP	07/97-08/00
1.6i Susp. renforcée AV AR	TU5JP	07/97-08/00

Suite ...

...Xsara...

1005269
... Kit rép. suspension G ou D

OE -

L/R stabilizing bar repair kit

CITROEN



1.8 Berline 3/5ptes susp. réhaussée	XU7JB	07/97-08/00
1.8 Berline comm.	XU7JB	07/97-08/00
1.8 Susp. renforcée AV AR	XU7JB	07/97-08/00
1.8i Berline 3ptes	XU7JB/P	07/97-17/01/99
1.8i Berline 5ptes susp. normale	XU7JB/P	07/97-11/04/99
1.8i Break 5ptes /comm. susp. normale	XU7JB/P	07/97-08/00
1.8i Berline 3/5ptes susp. réhaussée	XU7JP	07/97-08/00
1.8i Berline comm.	XU7JP	07/97-08/00
1.8i Susp. renforcée AV AR	XU7JP	07/97-08/00
1.8i 16v. Berline 3ptes	XU7JP4	07/97-17/01/99
1.8i 16v. Berline 5ptes susp. normale	XU7JP4	07/97-11/04/99
1.8i 16v. Break 5ptes /comm. susp. normale	XU7JP4	07/97-08/00
1.8i 16v. Berline 3/5ptes susp. réhaussée	XU7JP4	07/97-08/00
1.8i 16v. Berline comm.	XU7JP4	07/97-08/00
1.8i 16v. Susp. renforcée AV AR	XU7JP4	07/97-08/00
1.8 D Berline 3ptes susp. normale	XUD7	07/97-11/04/99
1.8 D Break 5ptes /comm. susp. normale	XUD7	07/97-08/00
1.8 D Berline 3ptes susp. réhaussée	XUD7	07/97-08/00
1.8 D Berline comm.	XUD7	07/97-08/00
1.8 D Susp. renforcée AV AR	XUD7	07/97-08/00
1.9 D Berline 3ptes susp. normale	DW8	07/97-17/01/99
1.9 D Berline 5ptes susp. normale	DW8	07/97-14/02/99
1.9 D Break 5ptes /comm. susp. normale	DW8	07/97-08/00
1.9 D Berline 3/5ptes susp. réhaussée	DW8	07/97-08/00
1.9 D Berline comm.	DW8	07/97-08/00
1.9 D Susp. renforcée AV AR	DW8	07/97-08/00
1.9 D Berline 3ptes	XUD9A	07/97-17/01/99
1.9 D Berline 5ptes susp. normale	XUD9A	07/97-11/04/99
1.9 D Break 5ptes /comm. susp. normale	XUD9A	07/97-08/00
1.9 D Berline 3/5ptes susp. réhaussée	XUD9A	07/97-08/00
1.9 D Berline comm.	XUD9A	07/97-08/00
1.9 D Susp. renforcée AV AR	XUD9A	07/97-08/00
1.9 TD SD Berline 3ptes	XUD9BSD	07/97-17/01/99
1.9 TD SD Berline 5ptes susp. normale	XUD9BSD	07/97-11/04/99
1.9 TD SD Berline 3/5ptes susp. réhaussée	XUD9BSD	07/97-08/00
1.9 TD SD Berline comm.	XUD9BSD	07/97-08/00
1.9 TD SD Break 5ptes /comm. susp. normale	XUD9BSD	07/97-08/00
1.9 TD SD Susp. renforcée AV AR	XUD9BSD	07/97-08/00
1.9 TD Berline 3ptes	XUD9TE	07/97-17/01/99
1.9 TD Berline 5ptes susp. normale	XUD9TE	07/97-11/04/99
1.9 TD Break 5ptes /comm. susp. normale	XUD9TE	07/97-08/00
1.9 TD Berline 3/5ptes susp. réhaussée	XUD9TE	07/97-08/00
1.9 TD Berline comm.	XUD9TE	07/97-08/00
1.9 TD Susp. renforcée AV AR	XUD9TE	07/97-08/00
2.0i 16v. Berline 5ptes susp. normale	XU10J4R	07/97-11/04/99
2.0i 16v. Break 5ptes /comm. susp. normale	XU10J4R	07/97-08/00
2.0i 16v. Berline 5ptes susp. réhaussée	XU10J4R	07/97-08/00
2.0i 16v. Berline comm.	XU10J4R	07/97-08/00
2.0i 16v. Berline 3ptes susp. réhaussée	XU10J4RS	07/97-08/00
2.0i 16v. Susp. renforcée AV AR	XU10J4R/S	07/97-08/00

...Xsara...

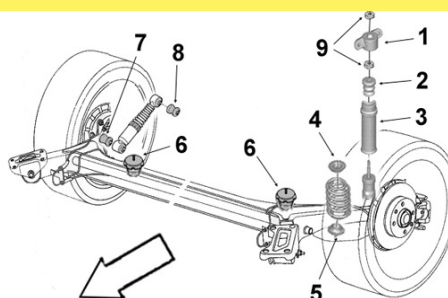

Support d'amortisseur

Suspension mounting
Soporte amortiguador
Poduszka amortyzatora
Опора амортизатора



1715105

OE 517110

Art. sup. amortisseur

Upper shock absorber bush



8 Ø int.12.2 Ø ext.30 coll.33.5 x2 long. tube int.39.8 ext.35 ep. coll.3x2

1.4i
1.4 HDi
1.5 D
1.6i
1.6i 16v.
1.8i
1.8i 16v.
1.8 D
1.9 D
1.9 TD
2.0i 16v.
2.0 HDi

1715095

OE 517109

Art. inf. amortisseur

Lower shock absorber bush



7 Ø int.14.6 Ø ext.34.9 coll.37.5 x2 long. tube int.39.8 ext.33.7 ep. coll.3.2x2

1.4i
1.4 HDi
1.5 D
1.6i
1.6i 16v.
1.8i
1.8i 16v.
1.8 D
1.9 D
1.9 TD
2.0i 16v.
2.0 HDi

1665315

OE 516631

Butée de talonnage

Bushing



6 Ø 49.5 H 63

TT /all models Sauf 2.0i 16v. XU10J4RS berline 06/09/99- susp. normale Disques AR	07/97-08/00
TT /all models Sauf Break 5ptes susp. normale	07/97-08/00
TT /all models Sauf Break 5ptes susp. renforcée AV AR	07/97-08/00
TT /all models Sauf Break comm. susp. normale	07/97-08/00
TT /all models Berline Tambour AR	09/00-
TT /all models susp. normale Disques AR	09/00-

...Xsara...



Support d'amortisseur
Suspension mounting
Soporte amortiguador
Poduszka amortyzatora
Опора амортизатора

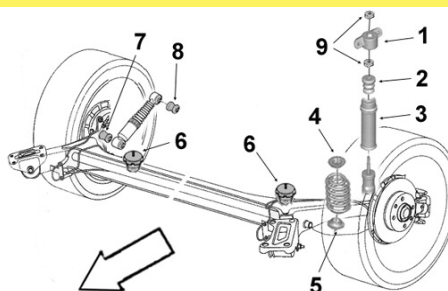

CITROËN

1665635

OE 516663

Butée de talonnage

Bushing



6 Ø 55 H82

2.0i 16v. Berline 3ptes susp. normale Disques AR

XU10J4RS

06/09/99-08/00

TT /all models Break 5ptes susp. normale

07/97-08/00

TT /all models Break comm. susp. normale

07/97-08/00

TT /all models Break 5ptes susp. renforcée AV AR

07/97-08/00

TT /all models Break

09/00-

TT /all models Disques AR susp. renforcée AV AR

09/00-

Eléments TRAIN ARRIERE

Rear axle parts

Tren TRAS

Elementy zawieszenia tylnego

элементы задней оси.



1315695

OE 513182

Support AVG traverse

Cross bar left front mounting



Paulstra

1.4i 07/97-08/00

1.5 D 07/97-08/00

1.6i 07/97-08/00

1.8i 07/97-08/00

1.8 D 07/97-08/00

1.9 D 07/97-08/00

1.9 TD 07/97-08/00

2.0i 16v. 07/97-08/00

2.0 HDi 07/97-08/00

1315705

OE 513183

Support AVD traverse

Cross bar right front mounting



Paulstra

1.4i 07/97-08/00

1.5 D 07/97-08/00

1.6i 07/97-08/00

1.8i 07/97-08/00

1.8 D 07/97-08/00

1.9 D 07/97-08/00

1.9 TD 07/97-08/00

2.0i 16v. 07/97-08/00

2.0 HDi 07/97-08/00

1315715

OE 513171

Support train AR

Rear axle mounting



1.4i Susp. réhaussée 07/97-08/00

1.4i 09/00-

1.4 HDi 09/00-

1.5 D Susp. réhaussée 07/97-08/00

1.6i 16v. 09/00-

1.6i Susp. réhaussée 07/97-08/00

1.8i Susp. réhaussée 07/97-08/00

1.8i 16v. Susp. réhaussée 07/97-08/00

1.8 D Susp. réhaussée 07/97-08/00

1.9 D Susp. réhaussée 07/97-08/00

1.9 D 09/00-

1.9 TD Susp. réhaussée 07/97-08/00



2.0i 16v. Susp. réhaussée 07/97-08/00

2.0i 16v. 09/00-

2.0 HDi Susp. réhaussée 07/97-08/00



2.0 HDi 09/00-

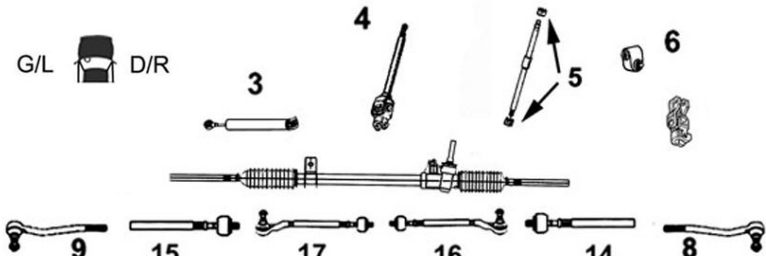

...Xsara

2001022 OE 96102027 	Support AR <i>Rear mounting</i> 2.0i 16v. susp. normale XU10J4RS 07/97-08/00	1005116 OE - 	Kit rép. train AR G ou D <i>L/R rear axle repair kit</i> 1.4i TU3JP 09/00- 1.4 HDi DV4TD 09/00- 1.6i 16v. TU5JP4 09/00- 1.9 D DW8B 09/00- 2.0i 16v. EW10J4 XU10J4RS 09/00- 2.0 HDi DW10TD 09/00- 2.0 HDi DW10ATED 09/00-
--	--	---	---

Xsara Picasso...

Eléments DIRECTION <i>Steering parts</i> Elementos Direcciones Elementy układ kierowniczy Элементы рулевой системы	
---	--

0114654 OE 401165 	Vérin dir. assistée <i>Power steering jack</i> 3 1.6i 1.6i 16v. 1.6 HDi 1.8i 16v. 2.0i 16v. 2.0 HDi	3008155 Part/oe 3812C6 	Axe de bielle G/D <i>L/R axial joint</i> 14 Côté dir. M12x1.0 Côté rot. M14x1.5 15 long 330 mm DA 1.6i /16v. -11/04/04 1.6 HDi -11/04/04 1.8i 16v. -11/04/04 2.0i 16v. -11/04/04 2.0 HDi -11/04/04
---	--	---	--

7770009 OE 3812E4 	Axe de bielle G/D <i>L/R axial joint</i> 14 Côté dir. M12x1.0 Côté rot. M14x1.5 15 long 336 mm DA 1.6i /16v. 12/04/04- 1.6 HDi 12/04/04- 1.8i 16v. 12/04/04- 2.0i 16v. 12/04/04- 2.0 HDi 12/04/04-	8173183 OE 381750 	Rotule de direction G/D <i>L/R tie rod end</i> 8 M14 x 1.5 9 DA 1.6i 1.6i 16v. 1.6 HDi 1.8i 16v. 2.0i 16v. 2.0 HDi
--	--	---	--

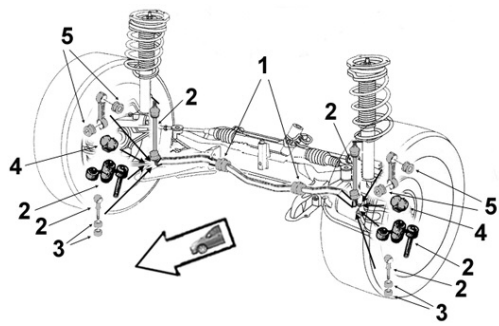
 Barre stabilisatrice <i>Stabilizer bar</i> Barra estabilizadora Drażek stabilizatora стабилизатор поперечной устойчивости	
--	--

0875395 OE 508761 	Biellette barre stab. <i>Stabilizer bar stub axle</i> 2 1.6i 1.6i 16v. 1.6 HDi 1.8i 16v. 2.0i 16v. 2.0 HDi	0945655 OE 509465 	Palier de barre milieu <i>Middle bar main bearing</i> 1 Barre Ø 21 1.6i 1.6i 16v. 1.6 HDi 1.8i 16v. 2.0i 16v. 2.0 HDi
--	---	---	--

...Xsara Picasso...



Eléments SUSPENSION
Suspension parts
Elementos suspensión
Elementy zawieszenie
Элементы подвески

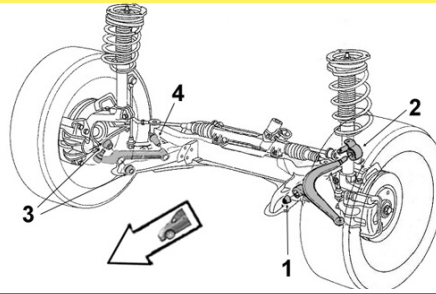

CITROËN

5233833

Articulation AR

OE 352383

Rear bush

2 Ø int.18



1.6i	Susp. normale	-01/09/01
1.6i	Susp. renforcée AV AR	-01/09/01
1.6i 16v.	Susp. normale	-01/09/01
1.6i 16v.	Susp. renforcée AV AR	-01/09/01
1.6 HDi		
1.8i 16v.	Susp. normale	-01/09/01
1.8i 16v.	Susp. renforcée AV AR	-01/09/01
2.0i 16v.		
2.0 HDi		

Bras & Triangle de suspension

Control arm
Brazo y triángulo
Wahacz
Рычаг подвески

G/L D/R

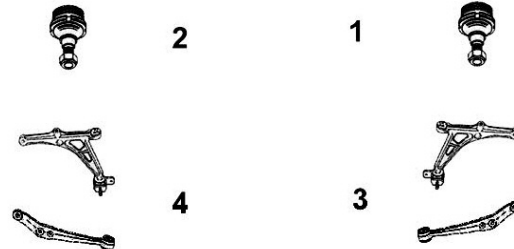

5203J33

Triangle de susp. G

OE 3520V3/V4

Left track control arm

4 Avec rotule With ball joint



Susp. normale	
1.6i /16v.	-01/09/01
1.8i 16v.	-01/09/01
Susp. normale ou renforcée AV AR	
1.6i /16v.	
1.6 HDi	
1.8i 16v.	
2.0i 16v.	
2.0 HDi	

5213F33

Triangle de susp. D

OE 3521R4/R5

Right track control arm

3 Avec rotule With ball joint



Susp. normale	
1.6i /16v.	-01/09/01
1.8i 16v.	-01/09/01
Susp. normale ou renforcée AV AR	
1.6i /16v.	
1.6 HDi	
1.8i 16v.	
2.0i 16v.	
2.0 HDi	

5203F73

Triangle de susp. G

OE 3520K7

Left track control arm

4 Sans rotule Without tie rod end



Susp. normale	
1.6i	02/09/01-
1.6i 16v.	02/09/01-
1.8i 16v.	02/09/01-

5213A73

Triangle de susp. D

OE 3521G7

Right track control arm

3 Sans rotule Without tie rod end



Susp. normale	
1.6i	02/09/01-
1.6i 16v.	02/09/01-
1.8i 16v.	02/09/01-

7470019

Triangle de susp. G

OE (2oe)3520H5+364051 *Left track control arm*

4 Avec rotule With ball joint Ø 18

NEW



Susp. normale	
1.6i	02/09/01-
1.6i 16v.	02/09/01-
1.8i 16v.	02/09/01-

7470018

Triangle de susp. D

OE (2oe)3521E5+364050 *Right track control arm*

3 Avec rotule With ball joint Ø 18

NEW



Susp. normale	
1.6i	02/09/01-
1.6i 16v.	02/09/01-
1.8i 16v.	02/09/01-

...Xsara Picasso...

CITROEN



6403513

OE 364051

Rotule de susp. inf. G/D

L/R lower suspension ball joint



1 Ø 18 Susp. normale

2

1.6i	02/09/01-
1.6i 16v.	02/09/01-
1.8i 16v.	02/09/01-



Support d'amortisseur

Suspension mounting

Soporte amortiguador

Poduszka amortyzatora

Опора амортизатора

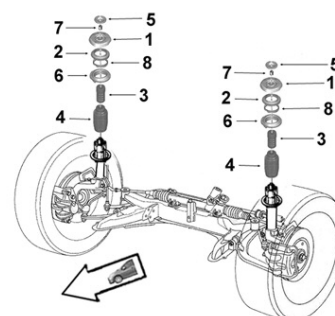

0385245

OE 503878

Support suspension G/D

L/R suspension mounting



1

1.6i	Susp. normale	-09/01
1.6i 16v.	Susp. renf. AV AR	-09/01
1.8i 16v.	Susp. normale	-09/01
2.0i 16v.	Susp. renf. AV AR	-09/01
2.0 HDi	Susp. normale ou renf. AV AR	-09/01

0385935

OE 503893

Support suspension G/D

L/R suspension mounting



1

1.6i	Susp. normale	10/01-
1.6i 16v.	Susp. normale	
1.6i 16v.	Susp. renf. AV AR	10/01-
1.6 HDi		
1.8i 16v.	Susp. normale	10/01-
2.0i 16v.	Susp. normale ou renf. AV AR	10/01-
2.0 HDi	Susp. normale ou renf. AV AR	10/01-

0355275

OE 503563

Butée à billes G/D

L/R ball bearing



2

1.6i
1.6i 16v.
1.6 HDi
1.8i 16v.
2.0i 16v.
2.0 HDi

0335405

OE 503340

Butée de suspension G/D

L/R suspension bush



3

Ø 56 H 109
susp. normale BVM
1.6i -30/01/00
1.8i 16v. -30/01/00

0335655

OE 503365

Butée de suspension G/D

L/R suspension bush



3

H109				
1.6i 90hp 66kw	Susp. normale	BVM	31/01/00-	
1.6i 100hp 74kw		BVM		
1.6i 16v.	Susp. normale	BVM		
1.6i 16v.	Susp. renforcée AV AR	BVM	02/01/01-17/12/06	
1.6i 16v.	Susp. renforcée AV AR		18/12/06-	
1.6 HDi	Susp. normale	BVM		
1.8i 16v.	Susp. normale	BVM	31/01/00-	
2.0i 16v.		BVM		
2.0 HDi		BVM		

0335595

OE 503359

Butée de suspension G/D

L/R suspension bush



3

Ø 56 H 105 BVA			
1.6i 90hp 66kw	Susp. normale		
1.6i 100hp 74kw			
1.6i 16v.	Susp. normale		
1.6i 16v.	Susp. renforcée AV AR	02/01/01-17/12/06	
1.6 HDi	Susp. normale		
1.8i 16v.	Susp. normale		
2.0i 16v.			
2.0 HDi			

...Xsara Picasso...

CITROEN

SASIC



Support d'amortisseur

Suspension mounting
Soporte amortiguador
Poduszka amortyzatora
Опора амортизатора

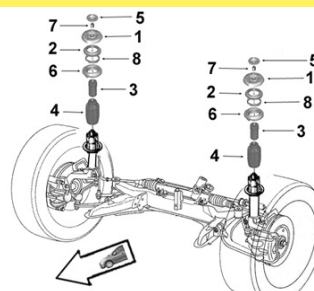

2545135

OE 525413

Protecteur amortisseur G/D

L/R shock absorber protector



4

1.6i /16v.
1.6 HDi
1.8i 16v.
2.0i 16v. Susp. normale
2.0i 16v. Susp. renf. AV AR -02/07/04
2.0 HDi Susp. normale
2.0 HDi Susp. renf. AV AR -02/07/04

2545335

OE 525433

Protecteur amortisseur G/D

L/R shock absorber protector

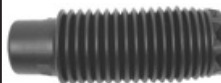

4

Susp. renforcée AV AR

2.0i 16v. 03/07/04-
2.0 HDi 03/07/04-

1005251

OE -

Kit rép. protection amort. G et D

L/R susp. mounting repair kit



Butée H 109 Susp. normale BVM

1.6i -30/01/00
1.6 HDi -30/01/00
1.8i 16v. -30/01/00
2.0i 16v. -30/01/00
2.0 HDi -30/01/00

1005270

OE -

Kit rép. suspension D

Right susp. mounting repair kit



1.6i -09/01
1.8i 16v. -09/01
2.0i 16v. -09/01
2.0 HDi -09/01



Support d'amortisseur

Suspension mounting
Soporte amortiguador
Poduszka amortyzatora
Опора амортизатора

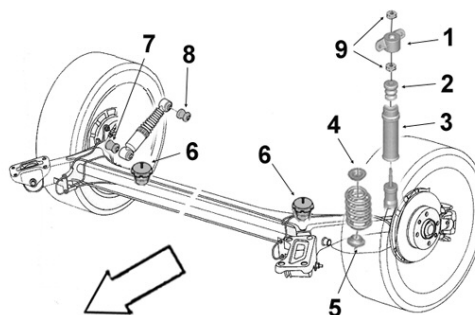

1715125

OE 517112

Articulation amort. sup.

Upper shock absorber bush



8

Ø int.16 Ø ext.33 coll.37 x2
long. tube int.45 ext.21 ep. coll.4x2

1.6i
1.6i 16v.
1.6 HDi
1.8i 16v.
2.0i 16v.
2.0 HDi

1715115

OE 517111

Articulation amort. inf.

Lower shock absorber bush



7

Ø int.16 Ø ext.34 coll.37 x2
long. tube int.45 ext.21 ep. coll.4x2

1.6i
1.6i 16v.
1.6 HDi
1.8i 16v.
2.0i 16v.
2.0 HDi

1665635

OE 516663

Butée de talonnage

Bushing



6

Ø 55 H82

1.6i /16v.	Susp. normale	
1.6i /16v.	Susp. renforcée AV AR	-04/09/05
1.6 HDi	Susp. normale	
1.6 HDi	Susp. renforcée AV AR	-04/09/05
1.8i 16v.	Susp. normale	
1.8i 16v.	Susp. renforcée AV AR	-04/09/05
2.0i 16v.	Susp. normale	
2.0i 16v.	Susp. renforcée AV AR	-04/09/05
2.0 HDi	Susp. normale	
2.0 HDi	Susp. renforcée AV AR	-04/09/05

...Xsara Picasso

Eléments TRAIN ARRIERE

Rear axle parts

Tren TRAS





Elementy zawieszenia tylnego

элементы задней оси.



CITROËN



1315985 OE 513198	Articulation AV Bras <i>Arm front bush</i>	1525625 OE 515264	Support train AR <i>Rear axle mounting</i>
	Ø int.12 Ø ext.53 coll.66 long. tube int.57 ext.48,5 ep. coll.12 Susp. renforcée AV AR 1.6i /16v. 1.6 HDi 1.8i 16v. 2.0i 16v. 2.0 HDi		Susp. normale 1.6i /16v. 1.6 HDi 1.8i 16v. 2.0i 16v. 2.0 HDi
1525625 OE 515262	Support train AR <i>Rear axle mounting</i>	1005127 OE -	Kit rép. train AR G ou D <i>L/R rear axle repair kit</i>
	Susp. renforcée AV AR 1.6i /16v. 1.6 HDi 1.8i 16v. 2.0i 16v. 2.0 HDi		1.6i /16v. 1.6 HDi 1.8i 16v. 2.0i 16v. 2.0 HDi

ZX...

Eléments DIRECTION





Steering parts

Elementos Direcciones

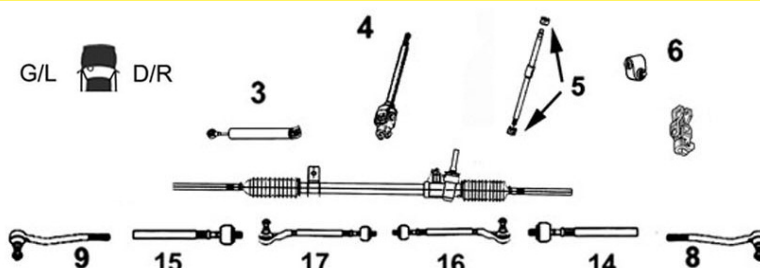
Elementy układ kierowniczy

Элементы рулевой системы



0114444 OE 401144	Vérin dir. assistée <i>Power steering jack</i>	2006021 OE 96048007581	Axe de bielle G/D <i>L/R axial joint</i>
	3 1.4 Carbu. TU32 1.4i TU3M/MC/JP 1.6i XU5JP/5M 1.8i /16v. XU7JP/4 1.9i XU9JA/K 2.0i XU10J2C 2.0i 16v. XU10J4/RS TT /all models		14 Côté dir. M12x1.0 Côté rot. M14x1.5 15 long 340 mm TT /all models
2006105 OE -	Bielle de direction G/D <i>L/R steering rod</i>	8173183 OE 381750	Rotule de direction G/D <i>L/R tie rod end</i>
	16 17 TT /all models		8 9 M14 x 1.5 TT /all models

...ZX...

Eléments DIRECTION

Steering parts

Elementos Direcciones

Elementy uklad kierowniczy

Элементы рулевой системы

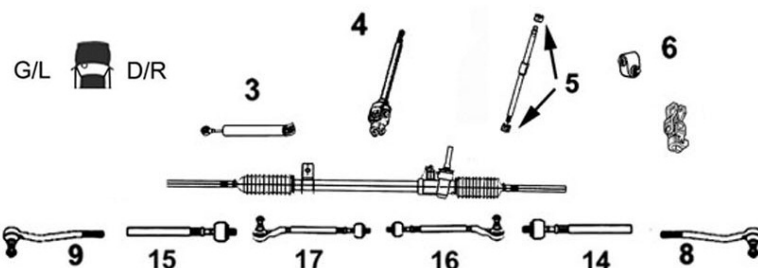

CITROEN

SASIC

1034C94

OE 4103C9

Axe de volant

Steering wheel shaft



4

TT /all models DNA

2004003

OE 96131127

Axe de volant

Steering wheel shaft



4

TT /all models DA



Barre stabilisatrice

Stabilizer bar

Barra estabilizadora

Drażek stabilizatora

стабилизатор поперечной устойчивости

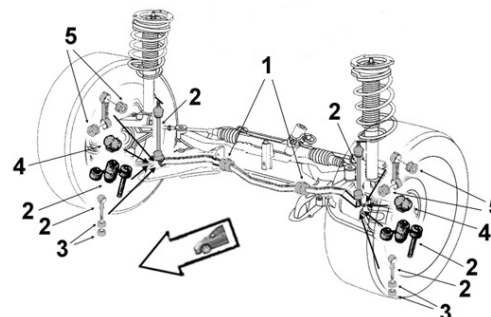

2005201

OE 96052007

Biellette barre stab.

Stabilizer bar stub axle



2

1.1/i	TU1/M	-05/92
1.4	TU32	-05/92
1.4i	TU3JP TU3M/C	-05/92
1.4 D	TUD3	-05/92
1.5 D	TUD5	-05/92
1.6i	XU5M XU5JP	-05/92
1.8i 16v.	XU7JP4	-05/92
1.8 D	XUD7	-05/92
1.9 D	XUD9	-05/92
1.9 TD	XUD9TE	-05/92

0875395

OE 508761

Biellette barre stab.

Stabilizer bar stub axle



2

1.1/i	TU1/M	06/92-
1.4	TU32 /M	06/92-
1.4i	TU3JP TU3M/C	06/92-
1.4 D	TUD3	06/92-
1.5 D	TUD5	06/92-
1.6i	XU5M XU5JP	06/92-
1.8i 16v.	XU7JP	06/92-
1.8 D	XUD7	06/92-
1.9i	XU9JA/Z	06/92-
1.9 D TD	XUD9/TE	06/92-
2.0i	XU10J2/J4/J4RS	06/92-

2005203

OE 96111480

Biellette barre stab.

Stabilizer bar stub axle



2

1.9i	XU9JA/JAZ	-05/92
------	-----------	--------

2005274

OE 96051398

Palier de barre milieu

Middle bar main bearing



1

Barre Ø 24		
1.1/i	TU1/M	-05/92
1.4	TU32	-05/92
1.4i	TU3JP TU3M/C	-05/92
1.4 D	TUD3	-05/92
1.5 D	TUD5	-05/92
1.6i	XU5M XU5JP	-05/92
1.8i 16v.	XU7JP4	-05/92
1.8 D	XUD7	-05/92
1.9 D	XUD9	-05/92
1.9 TD	XUD9TE	-05/92

2005273

OE 96158745

Palier de barre milieu

Middle bar main bearing



1

Barre Ø 18			
2	1.1/i	TU1/M	06/92-
	1.4	TU32 /M	06/92-
	1.4i	TU3JP TU3M/C	06/92-
	1.4 D	TUD3	06/92-
	1.5 D	TUD5	06/92-
	1.6i	XU5M XU5JP	06/92-
	1.8i 16v.	XU7JP	06/92-
	1.8 D	XUD7	06/92-
	1.9 D	XUD9	06/92-
	1.9 TD	XUD9TE	06/92-

0945665

OE 509466

Palier de barre milieu

Middle bar main bearing



1

Barre Ø 19			
1	1.1 Break	TU1	06/92-
	1.1i Break	TU1M	06/92-
	1.4 Break	TU3.2	06/92-
	1.4i Break	TU3JP TU3M/C	06/92-
	1.4 D Break	TUD3	06/92-
	1.5 D Break	TUD5	06/92-
	1.6i	XU5M/JP	
	1.8i 16v.	XU7JP4	
	1.8 D	XUD7	
	1.9 D/TD	XUD9/TE	

...ZX...

0945655

Palier de barre milieu

OE 509465

Middle bar main bearing



1 Barre Ø 21

1.9i
1.9 TD
2.0i 16v.
2.0i 16v.

XU9JA/Z
XUD9TE
XU10J4RS
XU10J4

06/92-



Eléments SUSPENSION

Suspension parts

Elementos suspensión

Elementy zawieszenia

Элементы подвески

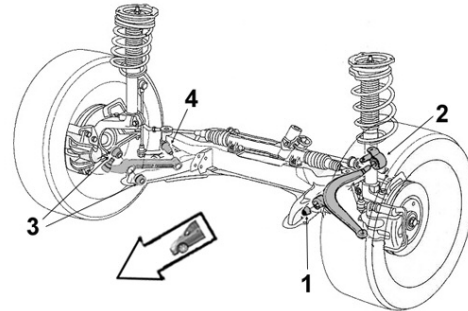

2005250

Articulation AV

OE 96110483

Front bush



1 Ø int.12 Ø ext.33 coll.44
long. tube int.31 ext.27 ep. coll.4.5

1.1/i TU1/M
1.4/i TU32 TU3JP TU3M/C
1.4 D TUD3
1.5 D TUD5
1.6i XU5M XU5JP
1.8i 16v. XU7JP4
1.8 D XUD7
1.9 D TD XUD9/TE

5233623

Articulation AR

OE 352375

Rear bush



2 Ø int.19

1.1/i TU1/M
1.4/i TU32 TU3JP TU3M/C
1.4 D TUD3
1.5 D TUD5
1.6i XU5M XU5JP
1.8i 16v. XU7JP4
1.8 D XUD7
1.9 D TD XUD9/TE

Bras & Triangle de suspension

Control arm
Brazo y triángulo
Wahacz
Рычаг подвески

G/L D/R



5203F73

Triangle de susp. G

OE 3520G7/H5/K7

Left track control arm



4 Sans rotule Without tie rod end

TT /all models -05/09/93
TT /all models Sauf susp. renforcée
06/09/93-

5213A73

Triangle de susp. D

OE 3521A7/E5/G7

Right track control arm



3 Sans rotule Without tie rod end

TT /all models -05/09/93
TT /all models Sauf susp. renforcée
06/09/93-

7470017

Triangle de susp. G

OE (2oe)3520H5+364043

Left track control arm

NEW



4 Avec rotule With ball joint Ø 16

TT /all models 06/09/93-
Sauf susp. renforcée Sauf Chine

7470016

Triangle de susp. D

OE (2oe)3521E5+364043

Right track control arm

NEW



3 Avec rotule With ball joint Ø 16

TT /all models 06/09/93-
Sauf susp. renforcée Sauf Chine

...ZX...

SASIC

CITROEN

Bras & Triangle de suspension

Control arm
Brazo y triángulo
Wahacz
Рычаг подвески

G/L  D/R

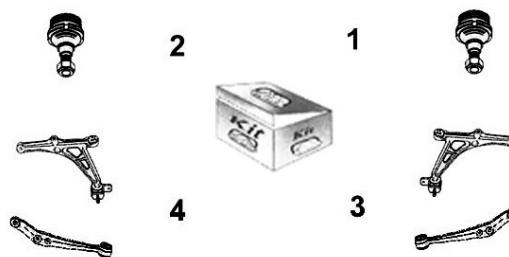

2005113

OE 364038

Rotule de susp. inf. G/D

L/R lower suspension ball joint



1
2

Ø 16

TT /all models -05/09/93

2005113

OE 364043

Rotule de susp. inf. G/D

L/R lower suspension ball joint



1
2

Ø 16

TT /all models 06/09/93-
Sauf susp. renforcée Sauf Chine

105A562S

OE -

Kit rép. train AV

Front axle repair kit



Sans visserie Without screws and bolts
Barre Ø 18 Art. AR Ø 19

TT /all models 06/92-

107A562S

OE -

Kit rép. train AV

Front axle repair kit



Sans visserie Without screws and bolts
Barre Ø 21 Art. AR Ø 19

TT /all models

1073562B

OE -

Kit rép. train AV complet

Front axle complete repair kit



Avec visserie With screws and bolts
Barre Ø 21 Art. AR Ø 19

TT /all models

1003562

OE -

Kit rép. triangle susp. G ou D

L or R track control arm bearing repair kit



Avec visserie With screws and bolts
Articulation AR Ø 19

TT /all models



Support d'amortisseur

Suspension mounting
Soporte amortiguador
Poduszka amortyzatora
Опора амортизатора

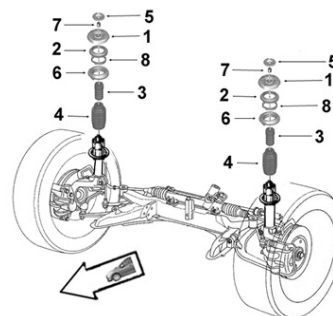

0385235

OE 503876

Support suspension G/D

L/R suspension mounting



1 DNA

1.1/i TU1/M
1.4/i TU32 TU3JP TU3M/C
1.4 D TUD3
1.5 D TUD5
1.6i XU5JP XU5M
1.8/i 16v. XU7JP/4
1.8 D XUD7
1.9 D/ TD XUD9/TE

0385245

OE 503878

Support suspension G/D

L/R suspension mounting













1 DA

1.1/i TU1/M
1.4/i TU32 TU3JP TU3M/C
1.4 D TUD3
1.5 D TUD5
1.6i XU5JP XU5M
1.8/i 16v. XU7JP/4
1.8 D XUD7
1.9i XU9JA
1.9 D TD XUD9/TE
2.0i /16v. XU10J2C XU10J4/S

...ZX...

CITROEN

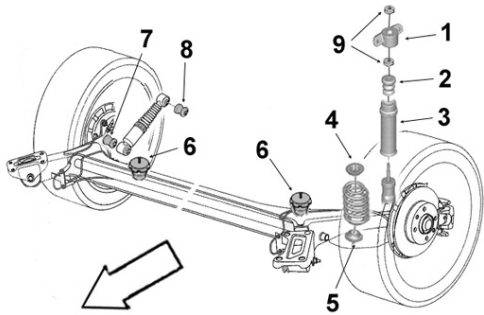

0385275 OE 503827	Support suspension G/D <i>L/R suspension mounting</i>	0355275 OE 503563	Butée à billes G/D <i>L/R ball bearing</i>
	1 2.0i 16v. DA XU10J4 2.0i 16v. XU10J4RS		2 1.1/i 1.4i 1.4 D 1.5 D 1.6i 1.8i /16v. 1.8 D 1.9i 1.9 D /TD 2.0i /16v.
0335235 OE 503323	Butée de suspension G/D <i>L/R suspension bush</i>	0335275 OE 503327	Butée de suspension G/D <i>L/R suspension bush</i>
	3 H57 1.1/i TU1/M 1.4 TU3.2 1.4i TU3JP TU3M/C 1.4 D TUD3 1.5 D TUD5		3 H97 1.1/i TU1/M 1.4 TU32 1.4i /Break TU3JP TU3M/C 1.4 D 1.5 D TUD3/5 1.6i XU5JP XU5M 1.8i 16v. XU7JP4 1.8 D XUD7 1.9i XU9JAL/Z (DKZ) 1.9 D TD XUD9/TE 2.0i XU10J2
0335515 OE 503351	Butée de suspension G/D <i>L/R suspension bush</i>	2545135 OE 525413	Protecteur amortisseur G/D <i>L/R shock absorber protector</i>
	3 4 2.0i 16v. XU10J4 2.0i 16v. XU10J4RS		4 1.1/i TU1/M 02/05/93- 1.4i TU32/JP TU3M/C 02/05/93- 1.4 D TUD3 1.5 D TUD5 1.6i XU5JP XU5M 1.8i /16v. XU7JP/4 1.8 D XUD7 1.9i XU9JA/Z 1.9 D TD XUD9/TE 2.0i XU10J2
1005269 OE -	Kit rép. suspension G ou D <i>L/R stabilizing bar repair kit</i>	1005270 OE -	Kit rép. suspension G ou D <i>L/R susp. mounting repair kit</i>
	DNA 1.1/i TU1/M 1.4/i TU32 TU3JP TU3M/C 1.4 D TUD3 1.5 D TUD5 1.6i XU5JP XU5M 1.8i 16v. XU7JP4 1.8 D XUD7 1.9 D TD XUD9/TE		DA 1.1/i TU1/M 1.4/i TU32 TU3JP TU3M/C 1.4 D TUD3 1.5 D TUD5 1.6i XU5JP XU5M 1.8i 16v. XU7JP4 1.8 D XUD7 1.9 D TD XUD9/TE
	Support d'amortisseur <i>Suspension mounting</i> <i>Soporte amortiguador</i> <i>Poduszka amortyzatora</i> <i>Опора амортизатора</i>		
1665315 OE 516631	Butée de talonnage <i>Bushing</i>	6 Ø49.5 H63 Tambour AR Sauf Break 1.1/i TU1/M 1.4/i TU3.2 TU3JP TU3M/C 1.4 D TUD3 1.5 D TUD5 1.6i XU5JP XU5M 1.8i 16v. XU7JP4 1.8 D XUD7 1.9 D/TD XUD9/TE	
			

...ZX

Eléments TRAIN ARRIERE

Rear axle parts

Tren TRAS

Elementy zawieszenia tylnego

элементы задней оси.



SASIC

CITROEN

1315695 OE 513182	Support AVG traverse <i>Cross bar left front mounting</i>	1315705 OE 513183	Support AVD traverse <i>Cross bar right front mounting</i>
	Paulstra 1.1/i TU1/M 1.4/i TU32/M TU3JP TU3M/C 1.4 D TUD3 1.5 D TUD5 1.6i XU5M XU5JP 1.8i 16v. XU7JP 1.8 D XUD7 1.9i XU9JA/Z 1.9 D TD XUD9/TE 2.0i /16v. XU10J2 XU10J4/RS		Paulstra 1.1/i TU1/M 1.4/i TU32/M TU3JP TU3M/C 1.4 D TUD3 1.5 D TUD5 1.6i XU5M XU5JP 1.8i 16v. XU7JP 1.8 D XUD7 1.9i XU9JA/Z 1.9 D TD XUD9/TE 2.0i /16v. XU10J2 XU10J4/RS
1315715 OE 513171	Support train AR <i>Rear axle mounting</i>	2001022 OE 96102027	Support AR <i>Rear mounting</i>
	1.1/i TU1/M 1.4/i TU32/M TU3JP TU3M/C 1.4 D TUD3 1.5 D TUD5 1.6i XU5M XU5JP 1.8i 16v. XU7JP 1.8 D XUD7 1.9i XU9JA/Z 1.9 D TD XUD9/TE 2.0i XU10J2		2.0i 16v. XU10J4 2.0i 16v. XU10J4RS
1005116 OE -	Kit rép. train AR G ou D <i>L/R rear axle repair kit</i>		
	TT /all models		

Berlingo VU...

Eléments DIRECTION

Steering parts

Elementos Direcciones

Elementy układ kierowniczy

Элементы рулевой системы

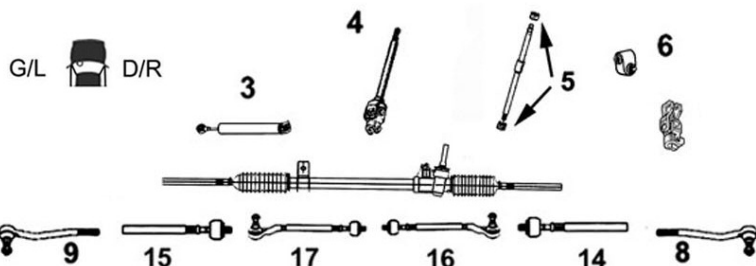





0114444 OE 401144	Vérin dir. assistée <i>Power steering jack</i>	0114654 OE 401165	Vérin dir. assistée <i>Power steering jack</i>
	3 1.1i TU1JP -05/08 1.1i TU1M+ -10/02 1.4 TU32 -10/02 1.4i TU3A 11/02-05/08 1.4i TU3JP -05/08 1.8 D XUD7 -10/02 1.9 D DW8/B -10/02 1.9 D DW8B 11/02-05/08 1.9 D XUD9 -10/02 TT Elec. /Electric SA18 -05/08		3 1.6 HDi DV6ATED4 11/02-05/08 1.6 HDi DV6BTED4 11/02-05/08 2.0 HDi DW10TD -05/08

...Berlingo VU...

CITROEN



...Berlingo VU...				
2006021	Axe de bielle G/D			
OE 96048007581	<i>L/R axial joint</i>			
	14	Côté dir. M12x1.0 Côté rot. M14x1.5 long 340 mm		
	15			
	1.1i	TU1JP	-05/08	
	1.1i	TU1M+	-10/02	
	1.4	TU32	-10/02	
	1.4i	TU3A	11/02-05/08	
	1.4i	TU3JP	-05/08	
	1.8 D	XUD7	-10/02	
	1.9 D	DW8/B	-10/02	
	1.9 D	DW8B	11/02-05/08	
1.9 D	XUD9	-10/02		
2.0 HDi DNA	DW10TD	-10/02		
TT Elec. /All models Electric	SA18	-05/08		
7770009	Axe de bielle G/D		3008155	
OE 3812E4	<i>L/R axial joint</i>		Part/oe 3812C6	
	14	Côté dir. M12x1.0 Côté rot. M14x1.5 long 336 mm		
	15			
	1.6 HDi	DV6ATED4	11/02-05/08	
	1.6 HDi	DV6BTED4	11/02-05/08	
	2.0 HDi	DW10TD	12/04/04-05/08	
TT Elec. /All models Electric	Venturi	11/02-05/08		
	14	Côté dir. M12x1.0 Côté rot. M14x1.5 long 330 mm		
	15			
	2.0 HDi DA	DW10TD	-10/02	
	2.0 HDi	DW10TD	11/02-11/04/04	
	TT Elec. /All models Electric			
7770004	Axe de bielle G/D			
Part/oe 3812F4	<i>L/R axial joint</i>			
	14	Côté dir. M14x1.5 Côté rot. M14x1.5 long 262 mm		
	15			
	1.6i 16v.	EP6CB TU5JP4/B	05/08-	
	1.6 HDi	DV6A/BUTED4	05/08-	
	1.6 HDi	DV6C	05/08-	
	1.6 HDi	DV6DTED/M	05/08-	
	1.6 HDi	DV6ETEDM/D4	05/08-	
	1.6 HDi FAP	DV6TED4BU	05/08-	
	TT Elec. /All models Electric		05/08-	
	2006105	Bielle de direction G/D		
OE -	<i>L/R steering rod</i>			
	16	Côté pignon		
	17			
	1.1	DA	TU1JP	-10/02
	1.1		TU1JP	11/02-05/08
	1.1	DA	TU1M+	-10/02
	1.4	DA	TU32	-10/02
	1.4i	DA	TU3JP	-10/02
	1.4i		TU3A TU3JP	11/02-05/08
	1.8 D	DA	XUD7	-10/02
	1.9 D	DA	DW8/B	-10/02
	1.9 D		DW8B	11/02-05/08
	1.9 D	DA	XUD9	-10/02
	TT Elec. /All models Electric	DA	SA18	-10/02
	TT Elec. /All models Electric		SA18	11/02-05/08

...Berlingo VU...

Eléments DIRECTION

Steering parts

Elementos Direcciones

Elementy układ kierowniczy

Элементы рулевой системы

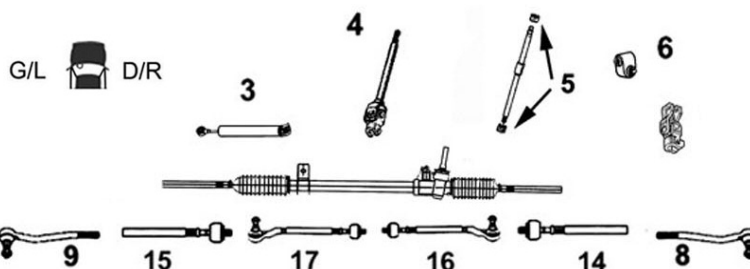

8173183

OE 381750

Rotule de direction G/D

L/R tie rod end



8

9

M14 x 1.5

1.1i
1.1i
1.4
1.4i
1.4i
1.6 HDi
1.8 D 1.9 D
1.9 D
2.0 HDi
TT Elec. /Electric

TU1JP
TU1M+
TU32
TU3A
TU3JP
DV6A/BTED4
XUD7/9
DW8/B
DW10TD
SA18

-05/08
-10/02
-10/02
11/02-05/08
-05/08
11/02-05/08
-10/02
-05/08
-05/08
-05/08

7670017

OE 381789

Rotule de direction G

Left tie rod end

NEW



9

M14 x 1.5

1.6i 16v. EP6C B 05/08-
1.6i 16v. TU5JP4/B 05/08-
1.6 HDi DV6A/BUTED4 05/08-
1.6 HDi DV6C 05/08-
1.6 HDi DV6DTED/M 05/08-
1.6 HDi DV6ETEDM/4 05/08-
1.6 HDi FAP DV6TED4BU 05/08-
TT Elec. /All models Electric 05/08-

7670016

OE 381788

Rotule de direction D

Right tie rod end

NEW



8

M14 x 1.5

1.6i 16v. EP6C B 05/08-
1.6i 16v. TU5JP4/B 05/08-
1.6 HDi DV6A/BUTED4 05/08-
1.6 HDi DV6C 05/08-
1.6 HDi DV6DTED/M 05/08-
1.6 HDi DV6ETEDM/4 05/08-
1.6 HDi FAP DV6TED4BU 05/08-
TT Elec. /All models Electric 05/08-



Barre stabilisatrice

Stabilizer bar

Barra estabilizadora

Drążek stabilizatora

стабилизатор поперечной устойчивости

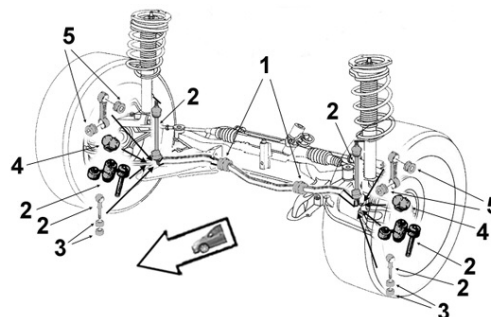

0875395

OE 508761

Biellette barre stab.

Stabilizer bar stub axle



2

TT /all models 07/96-11/02
1.1i TU1JP 11/02-05/08
1.4i TU3/A 11/02-05/08
1.6 HDi DV6A/BTED4 11/02-05/08
1.9 D DW8B 11/02-05/08
2.0 HDi DW10TD 11/02-05/08
TT Elec. /All models Electric 500kg
Fourgon court SA18 11/02-05/08

2300030

OE 508757

Biellette barre stab.

Stabilizer bar stub axle



2

1.6i 16v. TU5JP4B 05/08-
1.6i 16v. EP6C DTR 05/08-
1.6 HDi DV6DTED 05/08-
1.6 HDi DV6ETED4 05/08-
1.6 HDi DV6AUTED4 05/08-
1.6 HDi DV6BUTED4 05/08-
1.6 HDi FAP DV6TED4BU 05/08-

0945655

OE 509465

Palier de barre milieu

Middle bar main bearing



1

Barre Ø 21

TT /all models 475kg 600kg Fourgon court Susp. normale
TT /all models Susp. réhaussée
TT /all models Susp. renforcée AV AR
1.4i 600kg Fourgon court TU3/A
1.6 HDi 600kg Fourgon court DV6A BTED4
1.9 D 600kg Fourgon court DW8B
2.0 HDi 600kg Fourgon court DW10TD
TT Elec. /Electric 500kg Fourgon court SA18

07/96-11/02
07/96-11/02
07/96-11/02
11/02-05/08
11/02-05/08
11/02-05/08
11/02-05/08
11/02-05/08

...Berlingo VU...

0945775

Palier de barre milieu

OE 509477

Middle bar main bearing



1 Barre Ø 22

TT /all models	765kg Plancher cabine court	Susp. normale	07/96-11/02
TT /all models	800kg Fourgon court	Susp. normale	07/96-11/02
1.4i	800kg Fourgon court	TU3A	11/02-05/08
1.4i	800kg Fourgon court	TU3	11/02-05/08
1.6i 16v.	800kg Fourgon court	TU5JP4	11/02-05/08
1.6 HDi	800kg Fourgon court	DV6ATED4	11/02-05/08
1.6 HDi	800kg Fourgon court	DV6BTED4	11/02-05/08
1.9 D	800kg Fourgon court	DW8B	11/02-05/08
2.0 HDi	800kg Fourgon court	DW10TD	11/02-05/08

0945895

Palier de barre milieu

OE 5094E3

Middle bar main bearing



1 Barre Ø 23

1.6i 16v.	TU5JP4	05/08-
1.6i 16v.	TU5JP4B	05/08-
1.6 HDi	DV6BUTED4	05/08-
1.6 HDi	DV6AUTED4	05/08-
1.6 HDi FAP	DV6TED4BU	05/08-

2300035

Palier de barre milieu

OE 5094E4

Middle bar main bearing



1 Barre Ø 24

1.6i 16v.	EP6C DTR	05/08-
1.6i 16v.	TU5JP4/B	05/08-
1.6 HDi	DV6A/BUTED4	05/08-
1.6 HDi	DV6DTED/M	05/08-
1.6 HDi	DV6ETED4	05/08-
1.6 HDi 90hp 66kw	DV6ETEDM	05/08-
1.6 HDi FAP	DV6TED4BU	05/08-

2300034

Palier de barre milieu

OE 5094E6

Middle bar main bearing



1 Barre Ø 24.5

1.6i 16v.	TU5JP4 /B	05/08-
1.6i 16v.	EP6C DTR	05/08-
1.6 HDi	DV6ABUTED4	05/08-
1.6 HDi	DV6DTED/M	05/08-
1.6 HDi	DV6ETED4	05/08-
1.6 HDi 90hp 66kw	DV6ETED M	05/08-
1.6 HDi FAP	DV6TED4BU	05/08-

2300036

Palier de barre milieu

OE 5094E7

Middle bar main bearing



1 Barre Ø 25

1.6i 16v.	EP6C DTR	05/08-
1.6i 16v.	TU5JP4/B	05/08-
1.6 HDi	DV6A/BUTED4	05/08-
1.6 HDi	DV6DTED/M	05/08-
1.6 HDi	DV6ETED4	05/08-
1.6 HDi 90hp 66kw	DV6ETED M	05/08-
1.6 HDi FAP	DV6TED4BU	05/08-



Eléments SUSPENSION

Suspension parts

Elementos suspensión

Elementy zawieszenie

Элементы подвески

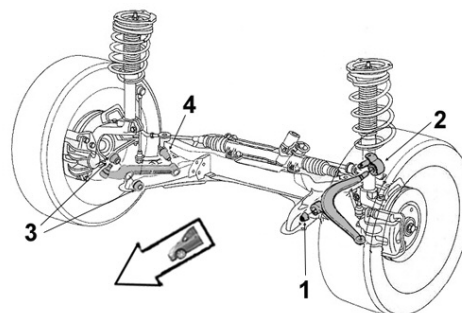

2005250

Articulation AV

OE 96110483

Front bush



**1 Ø int.12 Ø ext.33 coll.44
long. tube int.31 ext.27 ep. coll.4.5**

TT /all models 07/96-11/02

5233913

Articulation AV

OE 352391

Front bush



1 Ø int.14 Ø ext.55 long. tube int.56 ext.32

1.6i 16v.	TU5JP4	05/08-
1.6i 16v.	TU5JP4B	05/08-
1.6 HDi	DV6AUTED4	05/08-
1.6 HDi	DV6BUTED4	05/08-
1.6 HDi FAP	DV6TED4BU	05/08-

...Berlingo VU...



Eléments SUSPENSION
Suspension parts
Elementos suspensión
Elementy zawieszenie
Элементы подвески

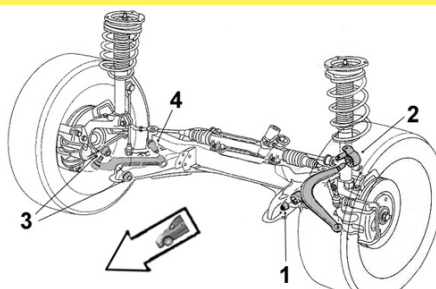

CITROËN



5233623

OE 352375

Articulation AR

Rear bush

2 Ø int.19

TT /all models
 TT Elec. /All models Electric

Susp. renforcée AV AR
 Susp. normale SA18

07/96-03/10/99
 07/96-03/10/99



5233833

OE 352383

Articulation AR

Rear bush

2 Ø int.18

TT /all models
 TT Elec. /All models Electric
 TT Elec. /All models Electric

Susp. renforcée AV AR
 Susp. normale SA18

04/10/99-11/02
 04/10/99-11/02
 11/02-05/08

1.1i	Susp. renforcée AV AR /normale réhaussée	TU1JP	11/02-05/08
1.4i	susp. renforcée AV AR ou réhaussée	TU3A	11/02-05/08
1.4i	800kg Fourgon court Susp. normale	TU3JP	11/02-05/08
1.4i	susp. renforcée AV AR ou réhaussée	TU3JP	11/02-05/08
1.6i 16v.	800kg Fourgon court Susp. normale	TU5JP4	11/02-05/08
1.6 HDi	Susp. normale	DV6ATED4	11/02-05/08
1.6 HDi	Susp. renforcée AV AR ou réhaussée	DV6ATED4	11/02-05/08
1.6 HDi	Susp. normale	DV6BTED4	11/02-05/08
1.6 HDi	Susp. renforcée AV AR ou réhaussée	DV6BTED4	11/02-05/08
1.9 D	Avec pavillon multifonction susp. normale	DW8/B	-11/02
1.9 D	Susp. renforcée AV AR /normale réhaussée	DW8B	11/02-05/08
2.0 HDi		DW10TD	-11/02
2.0 HDi	Susp. normale	DW10TD	11/02-05/08
2.0 HDi	Susp. renforcée AV AR ou réhaussée	DW10TD	11/02-05/08



5233923

OE 352392

Articulation AR

Rear bush

2 Ø int.14 Ø ext.55 coll.62 long. tube int.49 ext.25 ep. coll.3

1.6i 16v.	TU5JP4	05/08-
1.6i 16v.	TU5JP4B	05/08-
1.6 HDi	DV6BUTED4	05/08-
1.6 HDi	DV6AUTED4	05/08-
1.6 HDi FAP	DV6TED4BU	05/08-



...Berlingo VU...

Bras & Triangle de suspension

Control arm
Brazo y triángulo
Wahacz
Рычаг подвески

G/L  D/R



CITROEN



5203F73

OE 3520F8/K7

Triangle de susp. G

Left track control arm

4 Sans rotule Without tie rod end



1.1	Susp. normale /réhaussée	TU1M+	-10/02
1.1	Susp. renforcée AV AR	TU1M+	-19/10/98
1.1	Susp. normale /réhaussée	TU1JP	-10/02
1.1i	susp. normale	TU1JP	11/02-05/08
1.1	Susp. renforcée AV AR	TU1JP	-19/10/98
1.4	Susp. normale /réhaussée	TU32	-10/02
1.4	Susp. renforcée AV AR	TU32	-19/10/98
1.4i	Susp. normale /réhaussée	TU3JP	-10/02
1.4i	Susp. renforcée AV AR	TU3JP	-19/10/98
1.4i	500 600kg Fourgon court Susp. normale	TU3JP/A	11/02-05/08
1.8 D	Susp. normale /réhaussée	XUD7	-10/02
1.8 D	Susp. renforcée AV AR	XUD7	-19/10/98
1.9 D	Susp. normale /réhaussée	XUD9	-10/02
1.9 D	Susp. renforcée AV AR	XUD9	-19/10/98
1.9 D	susp. normale Sans pavillon multifonction Susp. réhaussée	DW8	-06/09/98
1.9 D	susp. normale Sans pavillon multifonction	DW8B	07/09/98-10/02
1.9 D	Susp. réhaussée	DW8B	07/09/98-10/02
1.9 D	500 600kg Fourgon court Susp. normale	DW8B	11/02-05/08
TT Elec. /All models Electric	Susp. normale	SA18	-19/10/98
TT Elec. /All models Electric	500kg Fourgon court	SA18	11/02-05/08

5213A73

OE 3521C2/G7

Triangle de susp. D

Right track control arm

3 Sans rotule Without tie rod end



1.1	Susp. normale /réhaussée	TU1M+	-10/02
1.1	Susp. renforcée AV AR	TU1M+	-19/10/98
1.1	Susp. normale /réhaussée	TU1JP	-10/02
1.1i	susp. normale	TU1JP	11/02-05/08
1.1	Susp. renforcée AV AR	TU1JP	-19/10/98
1.4	Susp. normale /réhaussée	TU32	-10/02
1.4	Susp. renforcée AV AR	TU32	-19/10/98
1.4i	Susp. normale /réhaussée	TU3JP	-10/02
1.4i	Susp. renforcée AV AR	TU3JP	-19/10/98
1.4i	500 600kg Fourgon court Susp. normale	TU3JP/A	11/02-05/08
1.8 D	Susp. normale /réhaussée	XUD7	-10/02
1.8 D	Susp. renforcée AV AR	XUD7	-19/10/98
1.9 D	Susp. normale /réhaussée	XUD9	-10/02
1.9 D	Susp. renforcée AV AR	XUD9	-19/10/98
1.9 D	susp. normale Sans pavillon multifonction Susp. réhaussée	DW8	-06/09/98
1.9 D	susp. normale Sans pavillon multifonction	DW8B	07/09/98-10/02
1.9 D	Susp. réhaussée	DW8B	07/09/98-10/02
1.9 D	500 600kg Fourgon court Susp. normale	DW8B	11/02-05/08
TT Elec. /All models Electric	Susp. normale	SA18	-19/10/98
TT Elec. /All models Electric	500kg Fourgon court	SA18	11/02-05/08

...Berlingo VU...

SASIC

CITROEN

Bras & Triangle de suspension

Control arm
Brazo y triángulo
Wahacz
Рычаг подвески

G/L  D/R



7470017 Triangle de susp. G
OE (2oe)3520H5+364043 Left track control arm

NEW



4 Avec rotule With ball joint Ø 16

Susp. normale /réhaussée

1.1	TU1JP	-06/09/98
1.1	TU1M+	-06/09/98
1.4	TU32	-06/09/98
1.8 D	XUD7	-06/09/98
1.9 D	Sans pavillon multifonction	
	DW8	-06/09/98
1.9 D	XUD9	-06/09/98

7470016 Triangle de susp. D
OE (2oe)3521E5+364043 Right track control arm

NEW



3 Avec rotule With ball joint Ø 16

Susp. normale /réhaussée

1.1	TU1JP	-06/09/98
1.1	TU1M+	-06/09/98
1.4	TU32	-06/09/98
1.8 D	XUD7	-06/09/98
1.9 D	Sans pavillon multifonction	
	DW8	-06/09/98
1.9 D	XUD9	-06/09/98

7470019 Triangle de susp. G
OE (2oe)3520H5+364051 Left track control arm

NEW



4 Avec rotule With ball joint Ø 18

Susp. normale

1.4i 500 600kg Fourgon court	TU3A/JP	11/02-05/08
1.9 D 500 600kg Fourgon court	DW8B	11/02-05/08

Susp. normale /réhaussée

1.1	TU1M+	07/09/98-10/02
1.1i	TU1JP	11/02-05/08
1.4	TU32	07/09/98-10/02
1.4i	TU3JP	07/09/98-10/02
1.8 D	XUD7	07/09/98-10/02
1.9 D	XUD9	07/09/98-10/02
1.9 D	Sans pavillon multifonction	
	DW8B	07/09/98-10/02

TT Elec. /All models Electric		
500kg Fourgon court	SA18	11/02-05/08

7470018 Triangle de susp. D
OE (2oe)3521E5+364050 Right track control arm

NEW



3 Avec rotule With ball joint Ø 18

Susp. normale

1.4i 500 600kg Fourgon court	TU3A/JP	11/02-05/08
1.9 D 500 600kg Fourgon court	DW8B	11/02-05/08

Susp. normale /réhaussée

1.1	TU1M+	07/09/98-10/02
1.1i	TU1JP	11/02-05/08
1.4	TU32	07/09/98-10/02
1.4i	TU3JP	07/09/98-10/02
1.8 D	XUD7	07/09/98-10/02
1.9 D	XUD9	07/09/98-10/02
1.9 D	Sans pavillon multifonction	
	DW8B	07/09/98-10/02

TT Elec. /All models Electric		
500kg Fourgon court	SA18	11/02-05/08

5203J33 Triangle de susp. G
OE 3520J4 Left track control arm



4 Avec rotule With ball joint

1.1	DNA	Susp. renforcée AV AR	TU1M+ TU1JP	04/10/99-10/02
1.4	DNA	Susp. renforcée AV AR	TU32	04/10/99-10/02
1.4i	DNA	Susp. renforcée AV AR	TU3JP	04/10/99-10/02
1.8 D	DNA	Susp. renforcée AV AR	XUD7	04/10/99-10/02
1.9 D	DNA	Susp. renforcée AV AR	XUD9	04/10/99-10/02
1.9 D	DNA	Susp. normale Avec pavillon multifonction	DW8/B	-10/02
2.0 HDi	DNA		DW10TD	-10/02
TT Elec. /Electric	DNA	Susp. renforcée AV AR	SA18	04/10/99-10/02

5213F33 Triangle de susp. D
OE 3521F4 Right track control arm



3 Avec rotule With ball joint

1.1	DNA	Susp. renforcée AV AR	TU1M+ TU1JP	04/10/99-10/02
1.4	DNA	Susp. renforcée AV AR	TU32	04/10/99-10/02
1.4i	DNA	Susp. renforcée AV AR	TU3JP	04/10/99-10/02
1.8 D	DNA	Susp. renforcée AV AR	XUD7	04/10/99-10/02
1.9 D	DNA	Susp. renforcée AV AR	XUD9	04/10/99-10/02
1.9 D	DNA	Susp. normale Avec pavillon multifonction	DW8/B	-10/02
2.0 HDi	DNA		DW10TD	-10/02
TT Elec. /Electric	DNA	Susp. renforcée AV AR	SA18	04/10/99-10/02

...Berlingo VU...

5203J33

OE 3520Q5

Triangle de susp. G

Left track control arm



4 Avec rotule With ball joint

1.1i		Susp. normale réhaussée	TU1JP	11/02-05/08
1.1i		Susp. renforcée AV AR	TU1JP	20/10/98-03/10/99
1.1i		Susp. renforcée AV AR	TU1JP	11/02-05/08
1.1		Susp. renforcée AV AR	TU1M+	20/10/98-03/10/99
1.1	DA	Susp. renforcée AV AR	TU1M+	04/10/99-10/02
1.4		Susp. renforcée AV AR	TU32	20/10/98-03/10/99
1.4	DA	Susp. renforcée AV AR	TU32	04/10/99-10/02
1.4i 800kg		Fourgon court Susp. normale	TU3A	11/02-05/08
1.4i		Susp. normale réhaussée ou renforcée AV AR	TU3A	11/02-05/08
1.4i		800kg Fourgon court Susp. normale	TU3JP	11/02-05/08
1.4i		Susp. normale réhaussée	TU3JP	11/02-05/08
1.4i	DA	Susp. renforcée AV AR	TU3JP	04/10/99-10/02
1.4i		Susp. renforcée AV AR	TU3JP	11/02-05/08
1.6 HDi		Susp. normale/réhaussée ou renforcée AV AR	DV6ATED4	11/02-05/08
1.6 HDi		Susp. normale/réhaussée ou renforcée AV AR	DV6BTED4	11/02-05/08
1.8 D		Susp. renforcée AV AR	XUD7	20/10/98-03/10/99
1.8 D	DA	Susp. renforcée AV AR	XUD7	04/10/99-10/02
1.9 D	DA	Susp. normale Avec pavillon multifonction	DW8/B	-10/02
1.9 D		800kg Fourgon court Susp. normale	DW8B	11/02-05/08
1.9 D		Plancher cabine court type 8 Susp. normale	DW8B	11/02-05/08
1.9 D		Susp. normale réhaussée ou renforcée AV AR	DW8B	11/02-05/08
1.9 D		Susp. renforcée AV AR	XUD9	20/10/98-03/10/99
1.9 D	DA	Susp. renforcée AV AR	XUD9	04/10/99-10/02
2.0 HDi	DA		DW10TD	-10/02
2.0 HDi		Susp. normale/réhaussée ou renforcée AV AR	DW10TD	11/02-05/08
TT Elec. /All models Electric		Susp. normale	SA18	20/10/98-10/02
TT Elec. /All models Electric		Susp. normale réhaussée	SA18	11/02-05/08
TT Elec. /All models Electric		Susp. renforcée AV AR	SA18	11/02-05/08

5213F33

OE 3521R4

Triangle de susp. D

Right track control arm



3 Avec rotule With ball joint

1.1i		Susp. normale réhaussée	TU1JP	11/02-05/08
1.1i		Susp. renforcée AV AR	TU1JP	20/10/98-03/10/99
1.1i		Susp. renforcée AV AR	TU1JP	11/02-05/08
1.1		Susp. renforcée AV AR	TU1M+	20/10/98-03/10/99
1.1	DA	Susp. renforcée AV AR	TU1M+	04/10/99-10/02
1.4		Susp. renforcée AV AR	TU32	20/10/98-03/10/99
1.4	DA	Susp. renforcée AV AR	TU32	04/10/99-10/02
1.4i 800kg		Fourgon court Susp. normale	TU3A	11/02-05/08
1.4i		Susp. normale réhaussée ou renforcée AV AR	TU3A	11/02-05/08
1.4i		800kg Fourgon court Susp. normale	TU3JP	11/02-05/08
1.4i		Susp. normale réhaussée	TU3JP	11/02-05/08
1.4i	DA	Susp. renforcée AV AR	TU3JP	04/10/99-10/02
1.4i		Susp. renforcée AV AR	TU3JP	11/02-05/08
1.6 HDi		Susp. normale/réhaussée ou renforcée AV AR	DV6ATED4	11/02-05/08
1.6 HDi		Susp. normale/réhaussée ou renforcée AV AR	DV6BTED4	11/02-05/08
1.8 D		Susp. renforcée AV AR	XUD7	20/10/98-03/10/99
1.8 D	DA	Susp. renforcée AV AR	XUD7	04/10/99-10/02
1.9 D	DA	Susp. normale Avec pavillon multifonction	DW8/B	-10/02
1.9 D		800kg Fourgon court Susp. normale	DW8B	11/02-05/08
1.9 D		Plancher cabine court type 8 Susp. normale	DW8B	11/02-05/08
1.9 D		Susp. normale réhaussée ou renforcée AV AR	DW8B	11/02-05/08
1.9 D		Susp. renforcée AV AR	XUD9	20/10/98-03/10/99
1.9 D	DA	Susp. renforcée AV AR	XUD9	04/10/99-10/02
2.0 HDi	DA		DW10TD	-10/02
2.0 HDi		Susp. normale/réhaussée ou renforcée AV AR	DW10TD	11/02-05/08
TT Elec. /All models Electric		Susp. normale	SA18	20/10/98-10/02
TT Elec. /All models Electric		Susp. normale réhaussée	SA18	11/02-05/08
TT Elec. /All models Electric		Susp. renforcée AV AR	SA18	11/02-05/08

...Berlingo VU...

SASIC

CITROEN

Bras & Triangle de suspension

Control arm
Brazo y triángulo
Wahacz
Рычаг подвески

G/L  D/R



5203K83

OE 3520S2

Triangle de susp. inf. G

Lower left track control arm



4 Sans rotule Without ball joint

1.6i 16v.	EP6C B	05/08-
1.6i 16v.	TU5JP4/B	05/08-
1.6 HDi	DV6A/BUTED4	05/08-
1.6 HDi	DV6C	05/08-
1.6 HDi	DV6DTED/M	05/08-
1.6 HDi	DV6ETED M	05/08-
1.6 HDi	DV6ETED4	05/08-
1.6 HDi FAP	DV6TED4BU	05/08-
TT Elec. / Electric		05/08-

5213G83

OE 3521P3

Triangle de susp. inf. D

Lower right track control arm



3 Sans rotule Without ball joint

1.6i 16v.	EP6C B	05/08-
1.6i 16v.	TU5JP4/B	05/08-
1.6 HDi	DV6A/BUTED4	05/08-
1.6 HDi	DV6C	05/08-
1.6 HDi	DV6DTED/M	05/08-
1.6 HDi	DV6ETED M	05/08-
1.6 HDi	DV6ETED4	05/08-
1.6 HDi FAP	DV6TED4BU	05/08-
TT Elec. / Electric		05/08-

2005113

OE 364043

Rotule de susp. inf. G/D

L/R lower suspension ball joint



1 2 Ø 16 Susp. normale /réhaussée

1.1		TU1JP	-06/09/98
1.1		TU1M+	-06/09/98
1.4		TU32	-06/09/98
1.8 D		XUD7	-06/09/98
1.9 D	Sans pavillon multifonction	DW8	-06/09/98
1.9 D		XUD9	-06/09/98

6403513

OE 364051

Rotule de susp. inf. G/D

L/R lower suspension ball joint



1 2 Ø 18

1.1	Susp. normale /réhaussée	TU1JP	07/09/98-10/02
1.1i	susp. normale	TU1JP	11/02-05/08
1.1	Susp. normale /réhaussée	TU1M+	07/09/98-10/02
1.4	Susp. normale /réhaussée	TU32	07/09/98-10/02
1.4i	500 600kg Fourgon court Susp. normale	TU3A	11/02-05/08
1.4i	Susp. normale /réhaussée	TU3JP	07/09/98-10/02
1.4i	500 600kg Fourgon court Susp. normale	TU3JP	11/02-05/08
1.8 D	Susp. normale /réhaussée	XUD7	07/09/98-10/02
1.9 D	susp. normale Sans pavillon multifonction	DW8B	07/09/98-10/02
1.9 D	Susp. réhaussée	DW8B	07/09/98-10/02
1.9 D	500 600kg Fourgon court Susp. normale	DW8B	11/02-05/08
1.9 D	Susp. normale /réhaussée	XUD9	07/09/98-10/02
TT Elec. /All models Electric	500kg Fourgon court	SA18	11/02-05/08

6403533

OE 364068

Rotule de susp. inf. G/D

L/R lower suspension ball joint



1 2

1.6i 16v.	EP6C B TU5JP4/B	05/08-
1.6 HDi	DV6AUTED4	05/08-
1.6 HDi	DV6BUTED4	05/08-
1.6 HDi	DV6C	05/08-
1.6 HDi	DV6DTED	05/08-
1.6 HDi	DV6DTED M	05/08-
1.6 HDi	DV6ETED M	05/08-
1.6 HDi	DV6ETED4	05/08-
1.6 HDi FAP	DV6TED4BU	05/08-
TT Elec. /All models Electric		05/08-

...Berlingo VU...

1003562

Kit rép. triangle susp. G ou D

OE - *L or R track control arm bearing repair kit*



Avec visserie *With screws and bolts* **Articulation AR Ø 19**

1.1		TU1JP TU1M+	-10/02
1.4/i		TU32 TU3JP	-10/02
1.8 D		XUD7	-10/02
1.9 D		DW8/B XUD9	-10/02
2.0 HDi		DW10TD	-10/02
TT Elec. /Electric		SA18	-10/02

1073562B

Kit rép. train AV complet

OE - *Front axle complete repair kit*



Avec visserie *With screws and bolts* **Barre Ø 21 Art. AR Ø 19**

1.1	475kg 600kg fourgon court	Susp. normale	TU1JP TU1M+	-10/02
1.1		Susp. réhaussée ou renforcée AV AR	TU1JP TU1M+	-10/02
1.4/i	475kg 600kg Fourgon court	Susp. normale	TU32/P	-10/02
1.4/i		Susp. réhaussée ou renforcée AV AR	TU32/P	-10/02
1.8 D	475kg 600kg Fourgon court	Susp. normale	XUD7	-10/02
1.8 D		Susp. réhaussée ou renforcée AV AR	XUD7	-10/02
1.9 D	475kg 600kg Fourgon court	Susp. normale	DW8/B	-10/02
1.9 D		Susp. réhaussée ou renforcée AV AR	DW8/B	-10/02
1.9 D	475kg 600kg Fourgon court	Susp. normale	XUD9	-10/02
1.9 D		Susp. réhaussée ou renforcée AV AR	XUD9	-10/02
2.0 HDi	475kg 600kg fourgon court	Susp. normale	DW10TD	-10/02
2.0 HDi		Susp. réhaussée ou renforcée AV AR	DW10TD	-10/02
TT Elec. /All models Electric	475kg 600kg Fourgon court	Susp. normale	SA18	-10/02
TT Elec. /All models Electric		Susp. réhaussée	SA18	-10/02
TT Elec. /All models Electric		Susp. renforcée AV AR	SA18	-10/02

107A562S

Kit rép. train AV

OE - *Front axle repair kit*



Sans visserie *Without screws and bolts* **Barre Ø 21 Art. AR Ø 19**

1.1	475kg 600kg fourgon court	Susp. normale	TU1JP TU1M+	-10/02
1.1		Susp. réhaussée ou renforcée AV AR	TU1JP TU1M+	-10/02
1.4/i	475kg 600kg Fourgon court	Susp. normale	TU32/P	-10/02
1.4/i		Susp. réhaussée ou renforcée AV AR	TU32/P	-10/02
1.8 D	475kg 600kg Fourgon court	Susp. normale	XUD7	-10/02
1.8 D		Susp. réhaussée ou renforcée AV AR	XUD7	-10/02
1.9 D	475kg 600kg Fourgon court	Susp. normale	DW8/B	-10/02
1.9 D		Susp. réhaussée ou renforcée AV AR	DW8/B	-10/02
1.9 D	475kg 600kg Fourgon court	Susp. normale	XUD9	-10/02
1.9 D		Susp. réhaussée ou renforcée AV AR	XUD9	-10/02
2.0 HDi	475kg 600kg fourgon court	Susp. normale	DW10TD	-10/02
2.0 HDi		Susp. réhaussée ou renforcée AV AR	DW10TD	-10/02
TT Elec. /All models Electric	475kg 600kg Fourgon court	Susp. normale	SA18	-10/02
TT Elec. /All models Electric		Susp. réhaussée	SA18	-10/02
TT Elec. /All models Electric		Susp. renforcée AV AR	SA18	-10/02

...Berlingo VU...

SASIC

CITROEN



Support d'amortisseur
Suspension mounting
Soporte amortiguador
Poduszka amortyzatora
Опора амортизатора

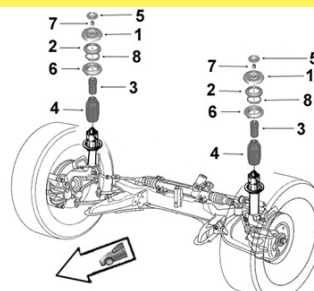

0385235

OE 503876

Support suspension G/D

L/R suspension mounting



1

TT /all models Fourgon court 475kg sauf 2.0 HDi Mot. DW10TD 09/09/02-
Susp. normale /réhaussée

07/96-11/02

TT /all models 600kg Fourgon court sauf 2.0 HDi Mot. DW10TD 09/09/02-
sauf susp. normale réhaussée ou renforcée AV AR DNA

07/96-11/02

TT /all models 800kg Fourgon court sauf 2.0 HDi Mot. DW10TD 09/09/02-
DNA Susp. renforcée AV AR

07/96-11/02

0385245

OE 503878

Support suspension G/D

L/R suspension mounting



1

TT /all models 600kg Fourgon court sauf 2.0 HDi Mot. DW10TD 09/09/02-
susp. normale réhaussée ou renforcée AV AR DA

07/96-11/02

TT /all models 800kg Fourgon court sauf 2.0 HDi Mot. DW10TD 09/09/02-
DA Susp. renforcée AV AR

07/96-11/02

TT /all models 800kg Fourgon court sauf 2.0 HDi Mot. DW10TD 09/09/02-
Susp. normale

07/96-11/02

TT /all models Plancher cabine court sauf 2.0 HDi Mot. DW10TD 09/09/02-

07/96-11/02

TT /all models sauf 2.0 HDi Mot. DW10TD 09/09/02- Pavillon multifonction

07/96-11/02

TT Elec. /All models Electric

SA18

07/96-05/08

1.1i

TU1JP

11/02-05/08

1.1i

TU1M

07/96-11/02

1.4i

TU3JP

11/02-05/08

1.4i

TU3A

11/02-05/08

1.6 HDi

DV6ATED4

11/02-05/08

1.6 HDi

DV6BTED4

11/02-05/08

1.9 D

DW8B

11/02-05/08

2.0 HDi

DW10TD

11/02-05/08

0385855

OE 5038G0

Support suspension G/D

L/R suspension mounting



1

1.6i 16v.

TU5JP4

05/08-

1.6i 16v.

TU5JP4B

05/08-

1.6 HDi

DV6AUTED4

05/08-

1.6 HDi

DV6BUTED4

05/08-

1.6 HDi FAP

DV6TED4BU

05/08-

0385935

OE 503893

Support suspension G/D

L/R suspension mounting



1

2.0 HDi

Pavillon multifonction

DW10TD

09/09/02-11/02

2.0 HDi

600kg Fourgon court susp. normale réhaussée

DW10TD

09/09/02-11/02

2.0 HDi

600kg Fourgon court susp. renforcée AV AR

DW10TD

09/09/02-11/02

2.0 HDi

765kg Plancher cabine court

DW10TD

09/09/02-11/02

2.0 HDi

800kg Fourgon court susp. normale

DW10TD

09/09/02-11/02







2.0 HDi

800kg Fourgon court susp. renforcée AV AR

DW10TD

09/09/02-11/02

...Berlingo VU...

...Berlingo VU...																																											
0355275 OE 503563	Butée à billes G/D <i>L/R ball bearing</i>																																										
	<p>2</p> <table style="width: 100%; border-collapse: collapse;"> <tr> <td style="width: 30%;">1.1i</td> <td style="width: 30%;">TU1M+/ TU1JP</td> <td style="width: 40%;">07/96-11/02</td> </tr> <tr> <td>1.1i</td> <td>TU1JP</td> <td>11/02-05/08</td> </tr> <tr> <td>1.4 Carbu.</td> <td>TU32</td> <td>07/96-11/02</td> </tr> <tr> <td>1.4i</td> <td>TU3JP</td> <td>07/96-05/08</td> </tr> <tr> <td>1.4i</td> <td>TU3A</td> <td>11/02-05/08</td> </tr> <tr> <td>1.6i 16v.</td> <td>TU5JP4/B</td> <td>05/08-</td> </tr> <tr> <td>1.6 HDi</td> <td>DV6A/BTED4</td> <td>11/02-05/08</td> </tr> <tr> <td>1.6 HDi</td> <td>DV6A/BUTED4</td> <td>05/08-</td> </tr> <tr> <td>1.6 HDi FAP</td> <td>DV6TED4BU</td> <td>05/08-</td> </tr> <tr> <td>1.8 D</td> <td>XUD7</td> <td>07/96-11/02</td> </tr> <tr> <td>1.9 D</td> <td>XUD9 DW8/B</td> <td>07/96-11/02</td> </tr> <tr> <td>1.9 D</td> <td>DW8B</td> <td>11/02-05/08</td> </tr> <tr> <td>2.0 HDi</td> <td>DW10TD</td> <td>07/96-05/08</td> </tr> <tr> <td>TT Elec. /All models Electric</td> <td>SA18</td> <td>11/02-05/08</td> </tr> </table>	1.1i	TU1M+/ TU1JP	07/96-11/02	1.1i	TU1JP	11/02-05/08	1.4 Carbu.	TU32	07/96-11/02	1.4i	TU3JP	07/96-05/08	1.4i	TU3A	11/02-05/08	1.6i 16v.	TU5JP4/B	05/08-	1.6 HDi	DV6A/BTED4	11/02-05/08	1.6 HDi	DV6A/BUTED4	05/08-	1.6 HDi FAP	DV6TED4BU	05/08-	1.8 D	XUD7	07/96-11/02	1.9 D	XUD9 DW8/B	07/96-11/02	1.9 D	DW8B	11/02-05/08	2.0 HDi	DW10TD	07/96-05/08	TT Elec. /All models Electric	SA18	11/02-05/08
1.1i	TU1M+/ TU1JP	07/96-11/02																																									
1.1i	TU1JP	11/02-05/08																																									
1.4 Carbu.	TU32	07/96-11/02																																									
1.4i	TU3JP	07/96-05/08																																									
1.4i	TU3A	11/02-05/08																																									
1.6i 16v.	TU5JP4/B	05/08-																																									
1.6 HDi	DV6A/BTED4	11/02-05/08																																									
1.6 HDi	DV6A/BUTED4	05/08-																																									
1.6 HDi FAP	DV6TED4BU	05/08-																																									
1.8 D	XUD7	07/96-11/02																																									
1.9 D	XUD9 DW8/B	07/96-11/02																																									
1.9 D	DW8B	11/02-05/08																																									
2.0 HDi	DW10TD	07/96-05/08																																									
TT Elec. /All models Electric	SA18	11/02-05/08																																									
2650035 OE 503151	Coupelle amortisseur G/D <i>L/R shock absorber cup</i>	0335515 OE 503351	Butée de suspension G/D <i>L/R suspension bush</i>																																								
	<p>6</p> <table style="width: 100%; border-collapse: collapse;"> <tr> <td style="width: 30%;">1.6i</td> <td style="width: 30%;">TU5JP4B</td> <td style="width: 40%;">05/08-</td> </tr> <tr> <td>1.6i 16v.</td> <td>EP6C DTR</td> <td>05/08-</td> </tr> <tr> <td>1.6i 16v.</td> <td>TU5JP4</td> <td>05/08-</td> </tr> <tr> <td>1.6 HDi</td> <td>DV6/BUTED4</td> <td>05/08-</td> </tr> <tr> <td>1.6 HDi</td> <td>DV6DTED/M</td> <td>05/08-</td> </tr> <tr> <td>1.6 HDi</td> <td>DV6ETED M</td> <td>05/08-</td> </tr> <tr> <td>1.6 HDi</td> <td>DV6ETED4</td> <td>05/08-</td> </tr> <tr> <td>1.6 HDi FAP</td> <td>DV6TED4BU</td> <td>05/08-</td> </tr> </table>	1.6i	TU5JP4B	05/08-	1.6i 16v.	EP6C DTR	05/08-	1.6i 16v.	TU5JP4	05/08-	1.6 HDi	DV6/BUTED4	05/08-	1.6 HDi	DV6DTED/M	05/08-	1.6 HDi	DV6ETED M	05/08-	1.6 HDi	DV6ETED4	05/08-	1.6 HDi FAP	DV6TED4BU	05/08-		<p>3 4</p> <table style="width: 100%; border-collapse: collapse;"> <tr> <td style="width: 60%;">TT /all models 800kg</td> <td style="width: 40%;">07/96-06/01/97</td> </tr> <tr> <td colspan="2">Fourgon court susp. normale</td> </tr> <tr> <td>TT Elec. /All models Electric</td> <td>SA18</td> </tr> <tr> <td></td> <td>07/96-11/02</td> </tr> </table>	TT /all models 800kg	07/96-06/01/97	Fourgon court susp. normale		TT Elec. /All models Electric	SA18		07/96-11/02								
1.6i	TU5JP4B	05/08-																																									
1.6i 16v.	EP6C DTR	05/08-																																									
1.6i 16v.	TU5JP4	05/08-																																									
1.6 HDi	DV6/BUTED4	05/08-																																									
1.6 HDi	DV6DTED/M	05/08-																																									
1.6 HDi	DV6ETED M	05/08-																																									
1.6 HDi	DV6ETED4	05/08-																																									
1.6 HDi FAP	DV6TED4BU	05/08-																																									
TT /all models 800kg	07/96-06/01/97																																										
Fourgon court susp. normale																																											
TT Elec. /All models Electric	SA18																																										
	07/96-11/02																																										
0335405 OE 503340	Butée de suspension G/D <i>L/R suspension bush</i>																																										
	<p>3 Ø 56 H 109</p> <table style="width: 100%; border-collapse: collapse;"> <tr> <td style="width: 60%;">TT /all models 765kg</td> <td style="width: 30%;">Plancher cabine court</td> <td style="width: 10%;"></td> <td style="width: 10%;">07/96-11/02</td> </tr> <tr> <td>TT /all models 800kg</td> <td>Fourgon court susp. normale</td> <td></td> <td>07/01/97-11/02</td> </tr> </table>			TT /all models 765kg	Plancher cabine court		07/96-11/02	TT /all models 800kg	Fourgon court susp. normale		07/01/97-11/02																																
TT /all models 765kg	Plancher cabine court		07/96-11/02																																								
TT /all models 800kg	Fourgon court susp. normale		07/01/97-11/02																																								
0335275 OE 503327	Butée de suspension G/D <i>L/R suspension bush</i>																																										
	<p>3 H97</p> <table style="width: 100%; border-collapse: collapse;"> <tr> <td style="width: 60%;">TT /all models 765kg</td> <td style="width: 30%;">Sauf plancher cabine court</td> <td style="width: 10%;">765kg</td> <td style="width: 10%;">07/96-11/02</td> </tr> <tr> <td>TT /all models 800kg</td> <td>Sauf fourgon court</td> <td>susp. normale</td> <td>07/96-11/02</td> </tr> <tr> <td>1.1i</td> <td>Susp. renforcée</td> <td>AV AR</td> <td>TU1JP</td> </tr> <tr> <td>1.4i</td> <td>Susp. renforcée</td> <td>AV AR ou réhaussée</td> <td>TU3JP</td> </tr> <tr> <td>1.6 HDi</td> <td>Susp. renforcée</td> <td>AV AR</td> <td>DV6ATED4</td> </tr> <tr> <td>1.9 D</td> <td>Susp. renforcée</td> <td>AV AR ou réhaussée</td> <td>DW8B</td> </tr> <tr> <td>TT Elec. /All models Electric</td> <td></td> <td></td> <td>SA18</td> </tr> <tr> <td></td> <td></td> <td></td> <td>11/02-05/08</td> </tr> </table>			TT /all models 765kg	Sauf plancher cabine court	765kg	07/96-11/02	TT /all models 800kg	Sauf fourgon court	susp. normale	07/96-11/02	1.1i	Susp. renforcée	AV AR	TU1JP	1.4i	Susp. renforcée	AV AR ou réhaussée	TU3JP	1.6 HDi	Susp. renforcée	AV AR	DV6ATED4	1.9 D	Susp. renforcée	AV AR ou réhaussée	DW8B	TT Elec. /All models Electric			SA18				11/02-05/08								
TT /all models 765kg	Sauf plancher cabine court	765kg	07/96-11/02																																								
TT /all models 800kg	Sauf fourgon court	susp. normale	07/96-11/02																																								
1.1i	Susp. renforcée	AV AR	TU1JP																																								
1.4i	Susp. renforcée	AV AR ou réhaussée	TU3JP																																								
1.6 HDi	Susp. renforcée	AV AR	DV6ATED4																																								
1.9 D	Susp. renforcée	AV AR ou réhaussée	DW8B																																								
TT Elec. /All models Electric			SA18																																								
			11/02-05/08																																								
0335595 OE 503359	Butée de suspension G/D <i>L/R suspension bush</i>	2650001 OE 503370	Butée de suspension G/D <i>L/R suspension bush</i>																																								
	<p>3 Ø 56 H 105</p> <table style="width: 100%; border-collapse: collapse;"> <tr> <td style="width: 30%;">1.1i</td> <td style="width: 30%;">TU1JP</td> <td style="width: 40%;">11/02-05/08</td> </tr> <tr> <td>1.4i</td> <td>TU3JP</td> <td>11/02-05/08</td> </tr> <tr> <td>1.4i Susp. normale</td> <td>TU3A</td> <td>11/02-05/08</td> </tr> <tr> <td>1.6 HDi</td> <td>DV6ATED4</td> <td>11/02-05/08</td> </tr> <tr> <td>1.6 HDi</td> <td>DV6BTED4</td> <td>11/02-05/08</td> </tr> <tr> <td>1.9 D Susp. normale</td> <td>DW8B</td> <td>11/02-05/08</td> </tr> <tr> <td>2.0 HDi Susp. normale</td> <td>DW10TD</td> <td>11/02-05/08</td> </tr> </table>	1.1i	TU1JP	11/02-05/08	1.4i	TU3JP	11/02-05/08	1.4i Susp. normale	TU3A	11/02-05/08	1.6 HDi	DV6ATED4	11/02-05/08	1.6 HDi	DV6BTED4	11/02-05/08	1.9 D Susp. normale	DW8B	11/02-05/08	2.0 HDi Susp. normale	DW10TD	11/02-05/08		<p>3 H96</p> <table style="width: 100%; border-collapse: collapse;"> <tr> <td style="width: 30%;">1.6i 16v.</td> <td style="width: 30%;">TU5JP4</td> <td style="width: 40%;">05/08-</td> </tr> <tr> <td>1.6i 16v.</td> <td>TU5JP4B</td> <td>05/08-</td> </tr> <tr> <td>1.6 HDi</td> <td>DV6AUTED4</td> <td>05/08-</td> </tr> <tr> <td>1.6 HDi</td> <td>DV6BUTED4</td> <td>05/08-</td> </tr> <tr> <td>1.6 HDi FAP</td> <td>DV6TED4BU</td> <td>05/08-</td> </tr> </table>	1.6i 16v.	TU5JP4	05/08-	1.6i 16v.	TU5JP4B	05/08-	1.6 HDi	DV6AUTED4	05/08-	1.6 HDi	DV6BUTED4	05/08-	1.6 HDi FAP	DV6TED4BU	05/08-				
1.1i	TU1JP	11/02-05/08																																									
1.4i	TU3JP	11/02-05/08																																									
1.4i Susp. normale	TU3A	11/02-05/08																																									
1.6 HDi	DV6ATED4	11/02-05/08																																									
1.6 HDi	DV6BTED4	11/02-05/08																																									
1.9 D Susp. normale	DW8B	11/02-05/08																																									
2.0 HDi Susp. normale	DW10TD	11/02-05/08																																									
1.6i 16v.	TU5JP4	05/08-																																									
1.6i 16v.	TU5JP4B	05/08-																																									
1.6 HDi	DV6AUTED4	05/08-																																									
1.6 HDi	DV6BUTED4	05/08-																																									
1.6 HDi FAP	DV6TED4BU	05/08-																																									

...Berlingo VU...

SASIC

CITROEN



Support d'amortisseur
 Suspension mounting
 Soporte amortiguador
 Poduszka amortyzatora
 Опора амортизатора

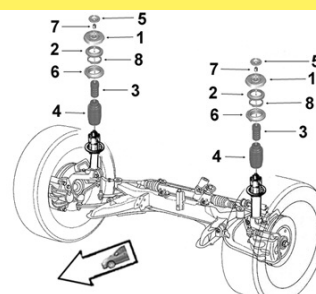

2545135

OE 525413

Protecteur amortisseur G/D

L/R shock absorber protector



4

1.1i	TU1M+ / JP	07/96-11/02
1.4 Carbu.	TU3.2	07/96-11/02
1.4i	TU3JP	07/96-11/02
1.8 D	XUD7	07/96-11/02
1.9 D	XUD9 DW8/B	07/96-11/02
2.0 HDi	DW10TD	07/96-11/02

2545335

OE 525433

Protecteur amortisseur G/D

L/R shock absorber protector

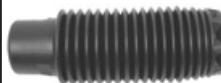

4

1.1i	TU1JP	11/02-05/08
1.4i	TU3JP	11/02-05/08
1.4i	TU3A	11/02-05/08
1.6 HDi	DV6ATED4	11/02-05/08
1.6 HDi	DV6BTED4	11/02-05/08
1.9 D	DW8B	11/02-05/08
2.0 HDi	DW10TD	11/02-05/08
TT Elec. /All models Electric	SA18	11/02-05/08

1005270

OE -

Kit rép. suspension

Susp. mounting repair kit



1.1	600kg Fourgon court	DA susp. normale ou réhaussée	TU1JP TU1M+	-10/02
1.1	600kg Fourgon court	DA susp. renforcée AV AR	TU1JP TU1M+	-10/02
1.1	765kg Plancher cabine court		TU1JP TU1M+	-10/02
1.1	800kg Fourgon court	susp. normale	TU1JP TU1M+	-10/02
1.1	800kg Fourgon court	DA susp. renforcée AV AR	TU1JP TU1M+	-10/02
1.1	Pavillon multifonction		TU1JP TU1M+	-10/02
1.1i			TU1JP	11/02-05/08
1.4/i	600kg Fourgon court	DA susp. normale ou réhaussée	TU32 TU3JP	-10/02
1.4/i	600kg Fourgon court	DA susp. renforcée AV AR	TU32 TU3JP	-10/02
1.4/i	765kg Plancher cabine court		TU32 TU3JP	-10/02
1.4/i	800kg Fourgon court	susp. normale	TU32 TU3JP	-10/02
1.4/i	800kg Fourgon court	DA susp. renforcée AV AR	TU32 TU3JP	-10/02
1.4/i	Pavillon multifonction		TU32 TU3JP	-10/02
1.4i			TU3JP	11/02-05/08
1.6i 16v.	600kg Fourgon court	DA susp. normale ou réhaussée	TU5JP4	-10/02
1.6i 16v.	600kg Fourgon court	DA Susp. renforcée AV AR	TU5JP4	-10/02
1.6i 16v.	765kg Plancher cabine court		TU5JP4	-10/02
1.6i 16v.	800kg Fourgon court	susp. normale	TU5JP4	-10/02
1.6i 16v.	800kg Fourgon court	DA Susp. renforcée AV AR	TU5JP4	-10/02
1.8	600kg Fourgon court	DA susp. normale ou réhaussée	XU7JB	-10/02
1.8	600kg Fourgon court	DA Susp. renforcée AV AR	XU7JB	-10/02
1.8	765kg Plancher cabine court		XU7JB	-10/02
1.8	800kg Fourgon court	susp. normale	XU7JB	-10/02
1.8	800kg Fourgon court	DA Susp. renforcée AV AR	XU7JB	-10/02
1.8 D	600kg Fourgon court	DA susp. normale ou réhaussée	XUD7	-10/02
1.8 D	600kg Fourgon court	DA Susp. renforcée AV AR	XUD7	-10/02
1.8 D	765kg Plancher cabine court		XUD7	-10/02
1.8 D	800kg Fourgon court	susp. normale	XUD7	-10/02
1.8 D	800kg Fourgon court	DA Susp. renforcée AV AR	XUD7	-10/02
1.8 D	Pavillon multifonction		XUD7	-10/02
1.9 D	600kg Fourgon court	DA susp. normale ou réhaussée	DW8/B XUD9	-10/02
1.9 D	600kg Fourgon court	DA Susp. renforcée AV AR	DW8/B XUD9	-10/02
1.9 D	765kg Plancher cabine court		DW8/B XUD9	-10/02
1.9 D	800kg Fourgon court	susp. normale	DW8/B XUD9	-10/02
1.9 D	800kg Fourgon court	DA Susp. renforcée AV AR	DW8/B XUD9	-10/02
1.9 D	Pavillon multifonction		DW8/B XUD9	-10/02
1.9 D			DW8B	11/02-05/08
2.0 HDi	600kg fourgon court	DA susp. normale ou réhaussée	DW10TD	-09/09/02
2.0 HDi	600kg fourgon court	DA Susp. renforcée AV AR	DW10TD	-09/09/02
2.0 HDi	765kg plancher cabine court		DW10TD	-09/09/02
2.0 HDi	800kg fourgon court	susp. normale	DW10TD	-09/09/02
2.0 HDi	800kg fourgon court	DA Susp. renforcée AV AR	DW10TD	-09/09/02
2.0 HDi	Pavillon multifonction		DW10TD	-09/09/02
2.0 HDi			DW10TD	11/02-05/08
TT Elec. /All models Electric			SA18	-10/02
TT Elec. /All models Electric 500kg Fourgon court			SA18	11/02-05/08

...Berlingo VU...

1005269
Kit rép. suspension G ou D

OE -

L/R stabilizing bar repair kit

1.1	475kg Fourgon court	susp. normale	TU1JP	-10/02
1.1	475kg Fourgon court	susp. réhaussée	TU1JP	-10/02
1.1	600kg Fourgon court	DNA susp. normale ou réhaus.	TU1JP	-10/02
1.1	800kg Fourgon court	DNA susp. renforcée AV AR	TU1JP	-10/02
1.1	475kg Fourgon court	susp. normale	TU1M+	-10/02
1.1	475kg Fourgon court	susp. réhaussée	TU1M+	-10/02
1.1	600kg Fourgon court	DNA susp. normale ou réhaus.	TU1M+	-10/02
1.1	600kg Fourgon court	DNA susp. renforcée AV AR	TU1M+	-10/02
1.1	800kg Fourgon court	DNA susp. renforcée AV AR	TU1M+	-10/02
1.4	475kg Fourgon court	susp. normale	TU32	-10/02
1.4	475kg Fourgon court	susp. réhaussée	TU32	-10/02
1.4	600kg Fourgon court	DNA susp. normale ou réhaus.	TU32	-10/02
1.4	600kg Fourgon court	DNA susp. renforcée AV AR	TU32	-10/02
1.4	800kg Fourgon court	DNA susp. renforcée AV AR	TU32	-10/02
1.4i	475kg Fourgon court	susp. normale	TU3JP	-10/02
1.4i	475kg Fourgon court	susp. réhaussée	TU3JP	-10/02
1.4i	600kg Fourgon court	DNA susp. normale ou réhaus.	TU3JP	-10/02
1.4i	600kg Fourgon court	DNA susp. renforcée AV AR	TU3JP	-10/02
1.4i	800kg Fourgon court	DNA susp. renforcée AV AR	TU3JP	-10/02
1.6i 16v.	475kg Fourgon court	susp. normale	TU5JP4	-10/02
1.6i 16v.	475kg Fourgon court	susp. réhaussée	TU5JP4	-10/02
1.6i 16v.	600kg Fourgon court	DNA susp. normale ou réhaus.	TU5JP4	-10/02
1.6i 16v.	600kg Fourgon court	DNA Susp. renforcée AV AR	TU5JP4	-10/02
1.6i 16v.	800kg Fourgon court	DNA Susp. renforcée AV AR	TU5JP4	-10/02
1.8	475kg Fourgon court	susp. normale	XU7JB	-10/02
1.8	475kg Fourgon court	susp. réhaussée	XU7JB	-10/02
1.8	600kg Fourgon court	DNA susp. normale ou réhaus.	XU7JB	-10/02
1.8	600kg Fourgon court	DNA Susp. renforcée AV AR	XU7JB	-10/02
1.8	800kg Fourgon court	DNA Susp. renforcée AV AR	XU7JB	-10/02
1.8 D	475kg Fourgon court	susp. normale	XUD7	-10/02
1.8 D	475kg Fourgon court	susp. réhaussée	XUD7	-10/02
1.8 D	600kg Fourgon court	DNA susp. normale ou réhaus.	XUD7	-10/02
1.8 D	600kg Fourgon court	DNA Susp. renforcée AV AR	XUD7	-10/02
1.8 D	800kg Fourgon court	DNA Susp. renforcée AV AR	XUD7	-10/02
1.9 D	475kg Fourgon court	susp. normale	DW8/B XUD9	-10/02
1.9 D	475kg Fourgon court	susp. réhaussée	DW8/B XUD9	-10/02
1.9 D	600kg Fourgon court	DNA susp. normale ou réhaus.	DW8/B XUD9	-10/02
1.9 D	600kg Fourgon court	DNA Susp. renforcée AV AR	DW8/B XUD9	-10/02
1.9 D	800kg Fourgon court	DNA Susp. renforcée AV AR	DW8/B XUD9	-10/02
2.0 HDi	475kg Fourgon court	susp. normale	DW10TD	-09/09/02
2.0 HDi	475kg Fourgon court	susp. réhaussée	DW10TD	-09/09/02
2.0 HDi	600kg Fourgon court	DNA susp. normale ou réhaus.	DW10TD	-09/09/02
2.0 HDi	600kg Fourgon court	DNA Susp. renforcée AV AR	DW10TD	-09/09/02
2.0 HDi	800kg Fourgon court	DNA Susp. renforcée AV AR	DW10TD	-09/09/02

1005250
Kit rép. protection amort. G et D

OE -

L/R susp. mounting repair kit

Butée H 97

1.1	Sauf fourgon court 800kg	Susp. normale	TU1JP TU1M+	-10/02
1.1	Sauf plancher cabine court 765kg	Susp. normale	TU1JP TU1M+	-10/02
1.4	Sauf fourgon court 800kg	Susp. normale	TU32	-10/02
1.4	Sauf plancher cabine court 765kg	Susp. normale	TU32	-10/02
1.4i	Sauf fourgon court 800kg	Susp. normale	TU3JP	-10/02
1.4i	Sauf plancher cabine court 765kg	Susp. normale	TU3JP	-10/02
1.6i 16v.	Sauf fourgon court 800kg	Susp. normale	TU5JP4	-10/02
1.6i 16v.	Sauf plancher cabine court 765kg	Susp. normale	TU5JP4	-10/02
1.8	Sauf fourgon court 800kg	Susp. normale	XU7JB	-10/02
1.8	Sauf plancher cabine court 765kg	Susp. normale	XU7JB	-10/02
1.8 D	Sauf fourgon court 800kg	Susp. normale	XUD7	-10/02
1.8 D	Sauf plancher cabine court 765kg fourgon court	Susp. normale	XUD7	-10/02
1.9 D	Sauf fourgon court 800kg	Susp. normale	DW8/B	-10/02
1.9 D	Sauf plancher cabine court 765kg	Susp. normale	DW8/B	-10/02
1.9 D	Sauf fourgon court 800kg	Susp. normale	XUD9	-10/02
1.9 D	Sauf plancher cabine court 765kg	Susp. normale	XUD9	-10/02
2.0 HDi	Sauf fourgon court 800kg	Susp. normale	DW10TD	-10/02
2.0 HDi	Sauf plancher cabine court 765kg	Susp. normale	DW10TD	-10/02

...Berlingo VU...

SASIC

CITROEN



Support d'amortisseur

Suspension mounting
Soporte amortiguador
Poduszka amortyzatora
Опора амортизатора

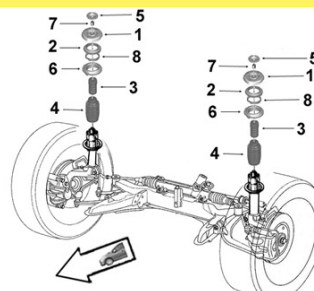

1005251

Kit rép. protection amort. G et D

OE -

L/R susp. mounting repair kit

Butée H 109



1.1	Plancher cabine court 765kg	TU1JP	-10/02
1.1	Fourgon court 800kg susp. normale	TU1JP	07/01/97-10/02
1.1	Plancher cabine court 765kg	TU1M+	-10/02
1.1	Fourgon court 800kg susp. normale	TU1M+	07/01/97-10/02
1.4	Plancher cabine court 765kg	TU32	-10/02
1.4	Fourgon court 800kg susp. normale	TU32	07/01/97-10/02
1.4i	Plancher cabine court 765kg	TU3JP	-10/02
1.4i	Fourgon court 800kg susp. normale	TU3JP	07/01/97-10/02
1.8 D	Plancher cabine court 765kg	XUD7	-10/02
1.8 D	Fourgon court 800kg susp. normale	XUD7	07/01/97-10/02
1.9 D	Plancher cabine court 765kg	DW8/B	-10/02
1.9 D	Fourgon court 800kg susp. normale	DW8/B	07/01/97-10/02
1.9 D	Plancher cabine court 765kg	XUD9	-10/02
1.9 D	Fourgon court 800kg susp. normale	XUD9	07/01/97-10/02
2.0 HDi	Plancher cabine court 765kg	DW10TD	-10/02
2.0 HDi	Fourgon court 800kg susp. normale	DW10TD	07/01/97-10/02



Support d'amortisseur

Suspension mounting
Soporte amortiguador
Poduszka amortyzatora
Опора амортизатора

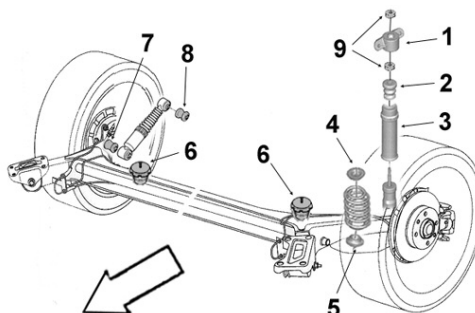

1715125

Articulation amort. sup.

OE 517112

Upper shock absorber bush

8 Ø int.16 Ø ext.33 coll.37 x2 long. tube int.45 ext.21 ep. coll.4x2



1.1i	TU1M+/ TU1JP	07/96-11/02
1.1i	TU1JP	11/02-05/08
1.4 Carbu. 1.4i	TU3.2 TU3JP	07/96-11/02
1.4i	TU3JP TU3A	11/02-05/08
1.6 HDi	DV6ATED4 DV6BTED4	11/02-05/08
1.8 D	XUD7	07/96-11/02
1.9 D	XUD9 DW8/B	07/96-11/02
1.9 D	DW8B	11/02-05/08
2.0 HDi	DW10TD	07/96-05/08
TT Elec. /All models Electric	SA18	11/02-05/08

1715115

Articulation amort. inf.

OE 517111

Lower shock absorber bush

7 Ø int.16 Ø ext.34 coll.37 x2 long. tube int.45 ext.21 ep. coll.4x2



1.1i	TU1M+/ TU1JP	07/96-11/02
1.1i	TU1JP	11/02-05/08
1.4 Carbu. 1.4i	TU3.2 TU3JP	07/96-11/02
1.4i	TU3JP TU3A	11/02-05/08
1.6 HDi	DV6ATED4 DV6BTED4	11/02-05/08
1.8 D	XUD7	07/96-11/02
1.9 D	XUD9 DW8/B	07/96-11/02
1.9 D	DW8B	11/02-05/08
2.0 HDi	DW10TD	07/96-05/08
TT Elec. /All models Electric	SA18	11/02-05/08

...Berlingo VU...

1665635		Butée de talonnage	
OE 516663		<i>Bushing</i>	
	6	Ø 55 H82	
	1.1i		TU1M+/ TU1JP
	1.1i	Susp. normale	TU1JP
	1.4 Carbu.		TU3.2
	1.4i		TU3JP
	1.4i		TU3A
	1.6 HDi		DV6A/BTED4
	1.8 D		XUD7
	1.9 D		XUD9 DW8/B
	1.9 D		DW8B
2.0 HDi		DW10TD	
TT Elec. /All models Electric 500kg Fourgon court		SA18	

2001025		Butée de talonnage	
Part/oe 516673		<i>Bushing</i>	
	6	Ø 55 H93	
	TT Elec. /All models Electric 500kg Fourgon court SA18		08/09/03-05/08

2001026		Butée de talonnage	
Part/oe 516672		<i>Bushing</i>	
	6	Ø 55 H 74	
	1.1i	TU1JP	08/09/03-05/08
	1.4i	TU3A	08/09/03-05/08
	1.4i	TU3JP	08/09/03-05/08
	1.6i 16v.	TU5JP4	08/09/03-05/08
	1.6 HDi	DV6A/BTED4	08/09/03-05/08
	1.9 D	DW8B	08/09/03-05/08
	2.0 HDi	DW10TD	08/09/03-05/08

Eléments TRAIN ARRIERE

Rear axle parts

Tren TRAS

Elementy zawieszenia tylnego

элементы задней оси.



1315985		Articulation AV Bras	
OE 513198		<i>Arm front bush</i>	
	Ø int.12 Ø ext.53 coll.66 long. tube int.57 ext.48,5 ep. coll.12		
	TT /all models 800kg Fourgon court susp. renforcée AV et AR		
	1.1i	susp. renforcée AV AR ou réhaussée	TU1JP
	800kg Plancher cabine court type 8 /fourgon court susp. renforcée AV et AR ou réhaussée		
	1.4i		TU3A/JP
	1.6i 16v.		TU5JP4
	1.6 HDi 800kg		DV6A/BTED4
	1.9 D 800kg		DW8B
2.0 HDi		DW10TD	

...Berlingo VU...

Eléments TRAIN ARRIERE

Rear axle parts

Tren TRAS

Elementy zawieszenia tylnego

элементы задней оси.



SASIC

CITROËN

1315475

OE 513147

Articulation AV Bras

Arm front bush



Ø int.12.2 Ø ext. 46.9 coll. 54.5 long. tube int.27.5 ext.17 ep. coll.10

TT /all models Sauf fourgon court 800 susp. renforcée AV et AR			07/96-11/02
1.1i Fourgon court 500 600 800kg Susp. normale	TU1JP		11/02-05/08
1.1i Plancher cabine court type 8 Susp. normale	TU1JP		11/02-05/08
1.4i 500 600kg Fourgon court Susp. normale	TU3A TU3JP		11/02-05/08
1.4i 800kg Fourgon court Susp. normale	TU3A TU3JP		11/02-05/08
1.4i 800kg Sauf plancher cabine court type 8 / fourgon court susp. renforcée AV AR ou réhaussée	TU3A TU3JP		11/02-05/08
1.4i Plancher cabine court type 8 Susp. normale	TU3A TU3JP		11/02-05/08
1.6i 16v. 800kg Fourgon court Susp. normale	TU5JP4		11/02-05/08
1.6i 16v. Plancher cabine court type 8 Susp. normale	TU5JP4		11/02-05/08
1.6 HDi 500 600kg Fourgon court Susp. normale	DV6A/BTED4		11/02-05/08
1.6 HDi 800kg Fourgon court Susp. normale	DV6A/BTED4		11/02-05/08
1.6 HDi Plancher cabine court type 8 Susp. normale	DV6A/BTED4		11/02-05/08
1.6 HDi Sauf plancher cabine court type 8 / fourgon court 800 susp. renforcée AV AR ou réhaussée	DV6A/BTED4		11/02-05/08
1.9 D 500 600kg fourgon court Susp. normale	DW8B		11/02-05/08
1.9 D 800kg fourgon court Susp. normale	DW8B		11/02-05/08
1.9 D Plancher cabine court type 8 Susp. normale	DW8B		11/02-05/08
1.9 D Sauf plancher cabine court type 8 / fourgon court 800 / fourgon tôle long H1 type 12 susp.renf. AV AR ou réhaussée	DW8B		11/02-05/08
2.0 HDi 500 600kg Fourgon court Susp. normale	DW10TD		11/02-05/08
2.0 HDi 800kg Fourgon court Susp. normale	DW10TD		11/02-05/08
2.0 HDi Plancher cabine court type 8 Susp. normale	DW10TD		11/02-05/08
2.0 HDi Sauf plancher cabine court type 8 / fourgon court 800 susp. renforcée AV AR ou réhaussée	DW10TD		11/02-05/08
TT Elec. /All models Electric 500 600 800kg Fourgon court Susp. normale	SA18		11/02-05/08
TT Elec. /All models Electric Plancher cabine court type 8 Susp. normale	SA18		11/02-05/08

1525625

OE 515264/62

Support train AR

Rear axle mounting



1.1i Susp. normale	TU1M+/ TU1JP		07/96-11/02
1.1i	TU1JP		11/02-05/08
1.4 Carbu. 1.4i	TU3.2 TU3JP		07/96-11/02
1.4i	TU3A		11/02-05/08
1.6 HDi	DV6A/BTED4		11/02-05/08
1.8 D	XUD7		07/96-11/02
1.9 D	XUD9 DW8/B		07/96-11/02
1.9 D	DW8B		11/02-05/08
2.0 HDi	DW10TD		07/96-05/08
TT Elec. /All models Electric	SA18		11/02-05/08

2600007

OE 5131H1

Articulation essieu

Axle bush



Ø int. 14 Ø ext. 82 coll. 90 long. tube int.79 ext.54 ep. Coll.7

1.6i 16v.	EP6C DTR TU5JP4 TU5JP4B		05/08-
1.6 HDi	DV6AUTED4 DV6BUTED4		05/08-
1.6 HDi	DV6DTED/M DV6ETED4		05/08-
1.6 HDi 90hp 66kw	DV6ETED M		05/08-
1.6 HDi FAP	DV6TED4BU		05/08-

...Berlingo VU

1005127
Kit rép. train AR G ou D

OE -

L/R rear axle repair kit

1.1	TU1JP TU1M+	-10/02
1.4	TU32	-10/02
1.4i	TU3JP	-10/02
1.8 D	XUD7	-10/02
1.9 D	DW8/B XUD9	-10/02
2.0 HDi	DW10TD	-10/02
TT Elec. /all models Electric	SA18	-10/02

C15...

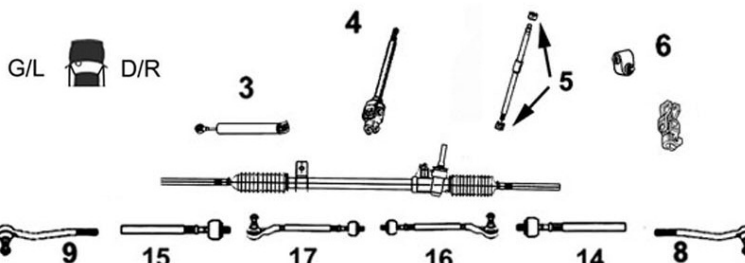
Eléments DIRECTION
Steering parts
Elementos Direcciones
Elementy uklad kierowniczy
Элементы рулевой системы

0114444
Vérin dir. assistée

OE 401144

Power steering jack

3

TT /all models

8123953
Axe de bielle G/D

OE 96136394

L/R axial joint

14 Côté dir. M12x1.0 Côté rot. M14x1.5
15 long 314 mm

TT /all models Sauf DNA 0054524

3008153
Axe de bielle G/D

OE -

L/R axial joint



14 Côté dir. M12x1.0 Côté rot. M14x1.5
15 long 262 mm

DNA 0054524

1.0 -04/05/88
1.1 -04/05/88
1.4 -04/05/88

8123323B1
Bielle de direction G/D

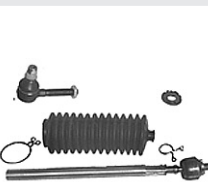
OE 381232

L/R steering rod

16
17

TT /all models Sauf DNA 0054524

8123153B1
Bielle de direction G/D

OE 381215

L/R steering rod

16
17

1.0 DNA 0054524 -04/05/88
1.1 DNA 0054524 -04/05/88
1.1i
1.4 DNA 0054524 -04/05/88

8173183
Rotule de direction G/D

OE 381750

L/R tie rod end

8
9 M14 x 1.5

TT /all models

2004005
Axe de volant

OE 95496537

Steering wheel shaft

4

TT /all models -06/09/89
DNA Pignon avec cannelures

2004002
Axe de volant

OE 96081921

Steering wheel shaft

4

TT /all models 07/09/89-
DNA Pignon avec plats

...C15...

Eléments DIRECTION

Steering parts

Elementos Direcciones

Elementy układ kierowniczy

Элементы рулевой системы

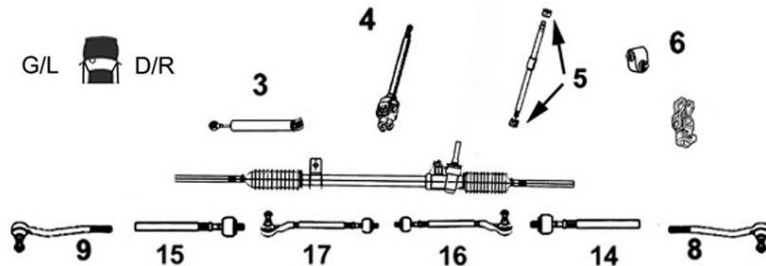

1044194

Axe de volant

OE 410419

Steering wheel shaft



4

TT /all models DA



Barre stabilisatrice

Stabilizer bar

Barra estabilizadora

Drażek stabilizatora

стабилизатор поперечной устойчивости

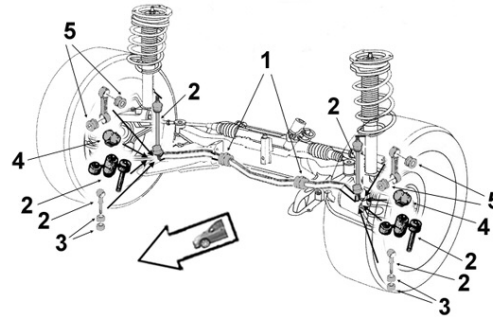

0945405

Palier de barre milieu

OE 509440

Middle bar main bearing



1 Barre Ø 23 bleu foncé

1.0	475kg	600kg	TU9	31/05/88-
1.1	475kg	600kg	E1	
1.1/i	475kg	600kg	TU1	31/05/88-
1.3	475kg	600kg	G1	
1.4/i	475kg	600kg	TU3	31/05/88-
1.8 D	475kg	600kg	XUD7	
1.9 D	475kg	600kg	DW8B	

2005281

Palier de barre milieu

OE 9153952

Middle bar main bearing



1 Barre Ø 24

1.0	760kg	TU9	31/05/88-
1.1	760kg	E1	
1.1/i	760kg	TU1	31/05/88-
1.3	760kg	G1	
1.4/i	760kg	TU3	31/05/88-
1.8 D	760kg	XUD7	
1.9 D	760kg	DW8B	



Eléments SUSPENSION

Suspension parts

Elementos suspensión

Elementy zawieszenie

Элементы подвески

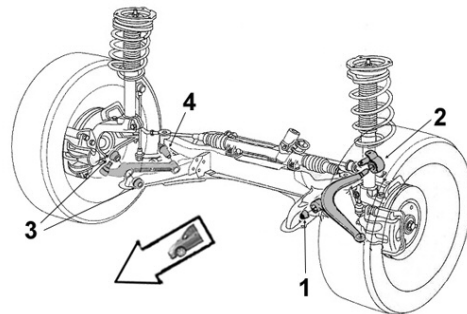

5233143

Articulation ext.

OE 352314

Outer bush



3 Ø int.14 Ø ext.38 long.tube int.42 ext.24

1.0		-04/05/88
1.1	1124	-04/05/88
1.4		-04/05/88

5233273UN

Articulation ext.

OE 352349

Outer bush











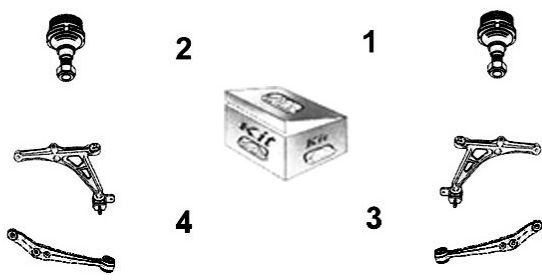

3 Ø int.12 Ø ext.36 coll.47 long.tube int.25 ext.15 ep.coll.8.5

1.0		05/05/88-
1.1	1124	05/05/88-
1.3		07/87-15/06/88
1.4		05/05/88-
1.8 D	XUD7	
1.9 D	DW8/B	

...C15...

CITROEN



5233203		Articulation int.	
OE 352320		<i>Inner bush</i>	
	4	Ø int.10 Ø ext.28 long. tube int.34 ext.28 1.0 1.1 1124 1.3 1.4 1.8 D 1.9 D	05/05/88- 05/05/88- 07/87-15/06/88 05/05/88-
		XUD7 DW8/B	
Bras & Triangle de suspension <i>Control arm</i> <i>Brazo y triángulo</i> <i>Wahacz</i> <i>Рычаг подвески</i>		G/L  D/R	
5203513	Bras de suspension G	5213343	Bras de suspension D
OE 352051	<i>Left track control arm</i>	OE 352134	<i>Right track control arm</i>
	4	3	3
	Avec rotule With ball joint TT /all models Sauf mot. 954 1124 1360cm3 -04/05/88	Avec rotule With ball joint TT /all models Sauf mot. 954 1124 1360cm3 -04/05/88	Avec rotule With ball joint TT /all models Sauf mot. 954 1124 1360cm3 -04/05/88
5203343	Bras de suspension G	5213233	Bras de suspension D
OE 91504358	<i>Left track control arm</i>	OE 91504359	<i>Right track control arm</i>
	4		3
	Avec rotule With ball joint 1.0 954 -04/05/88 1.1 1124 -04/05/88 1.4 1360 -04/05/88		Avec rotule With ball joint 1.0 954 -04/05/88 1.1 1124 -04/05/88 1.4 1360 -04/05/88
1003544	Kit rép. bras susp. G ou D	1003545	Kit rép. bras susp. G ou D
OE -	<i>L or R track control arm bearing repair kit</i>	OE -	<i>L or R track control arm bearing repair kit</i>
	1.0 954 -04/05/88		Avec visserie With screws and bolts
	1.1 1124 -04/05/88 1.4 1360 -04/05/88		1.0 05/05/88- 1.1 1118 1.1 1124 05/05/88- 1.3 1.4 05/05/88- 1.8 D
1003591S	Kit rép. bras susp. G ou D	1173545	Kit rép. train AV
OE -	<i>L or R track control arm bearing repair kit</i>	OE -	<i>Front axle repair kit</i>
	Sans visserie Without screws and bolts		Avec écrous with Nuts Barre Ø 23
	1.0 05/05/88- 1.1 1118 1.1 1124 05/05/88- 1.3 1.4 05/05/88- 1.8 D		TT /all models 475kg 600kg Essence Diesel

...C15...



CITROEN

Bras & Triangle de suspension

Control arm
Brazo y triángulo
Wahacz
Рычаг подвески

G/L D/R

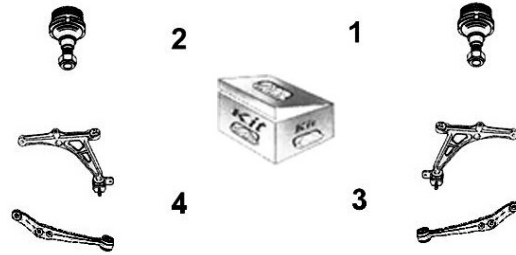

107A545S

OE -



Kit rép. train AV

Front axle repair kit

Sans visserie Without screws and bolts
Barre Ø 23

1.0		05/05/88-
1.1	1118	
1.1	1124	05/05/88-
1.3		
1.4		05/05/88-
1.8 D		

1073545B

OE -



Kit rép. train AV complet

Front axle complete repair kit

Avec visserie With screws and bolts
Barre Ø 23

1.0		05/05/88-
1.1	1118	
1.1	1124	05/05/88-
1.3		
1.4		05/05/88-
1.8 D		



Support d'amortisseur

Suspension mounting
Soporte amortiguador
Poduszka amortyzatora
Опора амортизатора

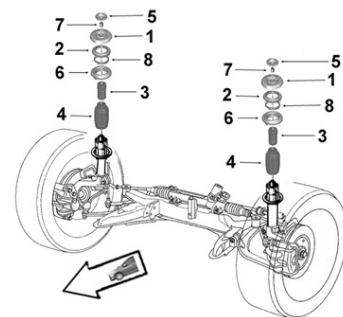

8003208

OE 503733



Tampon suspension G/D

L/R susp. rebound stop

1			
1.0		05/05/88-	
1.1	1118	07/87-15/06/88	
1.1	1124	05/05/88-	
1.3		07/87-15/06/88	
1.4		05/05/88-	
1.8 D	XUD7		
1.9 D	DW8/B		

0355275

OE 503563



Butée à billes G/D

L/R ball bearing

2			
1.0		05/05/88-	
1.1	1118	07/87-15/06/88	
1.1	1124	05/05/88-	
1.3		07/87-15/06/88	
1.4		05/05/88-	
1.8 D	XUD7		
1.9 D	DW8/B		

0335235

OE 503323



Butée de suspension G/D

L/R suspension bush

3	H57		
1.0	TU9	31/05/88-	
1.1	E1		
1.1	TU1	31/05/88-	
1.1i	TU1	31/05/88-	
1.3	G1		
1.4/i	TU3	31/05/88-	
1.8 D	XUD7		
1.9 D	DW8B		

2545135

OE 525413



Protecteur amortisseur G/D

L/R shock absorber protector

4			
1.0		05/05/88-	
1.1	1118	07/87-15/06/88	
1.1	1124	05/05/88-	
1.3		07/87-15/06/88	
1.4		05/05/88-	
1.8 D	XUD7		
1.9 D	DW8/B		

0355185

OE 503155



Kit rép. support susp. G/D

L/R susp. mounting repair kit

(Tampon caoutchouc+Butée à billes)
Rubber top + Ball bearing

1.0		05/05/88-
1.1	1118	07/87-15/06/88
1.1	1124	05/05/88-
1.3		07/87-15/06/88
1.4		05/05/88-
1.8 D	XUD7	
1.9 D	DW8/B	

...C15



Support d'amortisseur

Suspension mounting
Soporte amortiguador
Poduszka amortyzatora
Опора амортизатора

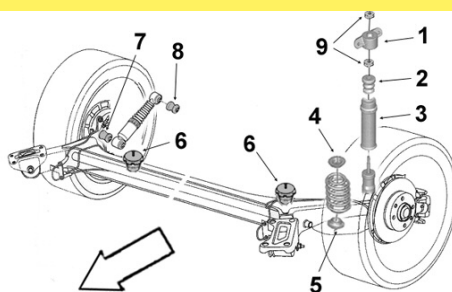

1665105

OE 516610

Butée de talonnage

Bushing



6

H71

1.0
1.0
1.1
1.1
1.1/i
1.3
1.4
1.4/i
1.8 D
1.9 D

XV8
TU9
E1
XW7
TU1
G1
XY7
TU3
XUD7
DW8B

-09/87
31/05/88-
-09/87
31/05/88-
-09/87
31/05/88-

Éléments TRAIN ARRIERE

Rear axle parts

Tren TRAS

Elementy zawieszenia tylnego

элементы задней оси.



2005261

OE 95632592

Support AVG traverse AR

Rear cross bar left front mounting

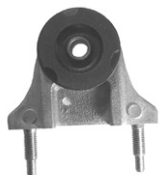

1.0

1.1 1118

1.1 1124

1.3

1.4

1.8 D

1.9 D

XUD7
DW8/B

05/05/88-
07/87-15/06/88
05/05/88-
07/87-15/06/88
05/05/88-

2005262

OE 95632593

Support AVD traverse AR

Rear cross bar right front mounting



1.0

1.1 1118

1.1 1124

1.3

1.4

1.8 D

1.9 D

XUD7
DW8/B

05/05/88-
07/87-15/06/88
05/05/88-
07/87-15/06/88
05/05/88-

2005150

OE -

Kit rép. train AR G ou D

L/R rear axle repair kit



TT /all models

C25...

Eléments DIRECTION

Steering parts

Elementos Direcciones

Elementy uklad kierowniczy

Элементы рулевой системы

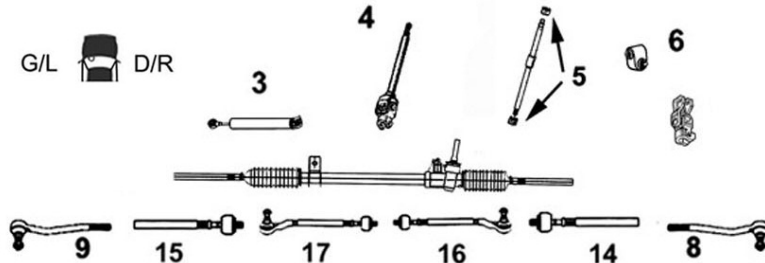

8123273

Axe de bielle G/D

Part/oe 381227

L/R axial joint



14 Côté dir. M16x1.5 Côté rot. M16x1.5
15 long 292 mm

TT /all models DNA 11/81-

3008071

Axe de bielle G/D

Part/oe ZF09941080

L/R axial joint



14 Côté dir. M16x1.5 Côté rot. M16x1.5
15 long 280 mm

TT /all models DA rotule fileté
11/81-

8173113

Rotule de direction G/D

OE 381711

L/R tie rod end



8
9 Ø 12 Ø 16 M16 x 1.5

TT /all models 11/81-

1034534

Axe de volant

OE 410353

Steering wheel shaft



4

TT /all models DNA 11/81-

1034A74

Axe de volant

OE 4103A7

Steering wheel shaft



4

TT /all models DA 11/81-

1264104

Bague de guidage colonne

OE 412610

Ring



5

TT /all models 11/81-



Barre stabilisatrice

Stabilizer bar

Barra estabilizadora

Drażek stabilizatora

стабилизатор поперечной устойчивости

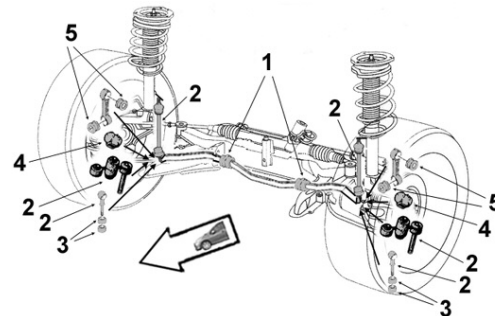

5613083

Palier de barre

OE 356108

Bar main bearing



1 Ø int.22 Ø ext. 48 ep. 24.5

TT /all models Carbu. sauf 4WD
TT /all models Diesel /2.5 TD

...C25...



Eléments SUSPENSION

Suspension parts

Elementos suspensión

Elementy zawieszenia

Элементы подвески

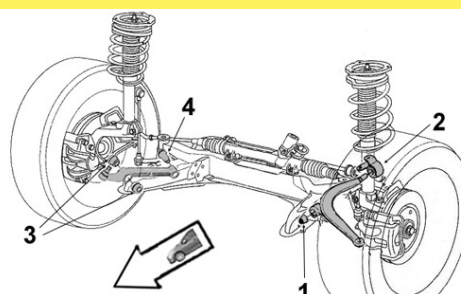

CITROËN



8003200 OE -	Articulation Bush	8003209 OE -	Articulation Bush
	4 Ø int.12 Ø ext.27 coll.43.5 x2 long. tube int.50 ext.28 ep. coll.6x2 TT /all models Sauf 1800kg Carbu. sauf 4WD Diesel /2.5 TD		4 Ø int.12 Ø ext.35 coll.50 x2 long. tube int.50 ext.40 ep. coll.5x2 TT /all models 1800kg Carbu. sauf 4WD Diesel /2.5 TD
<div style="display: flex; justify-content: space-between;"> <div data-bbox="244 890 447 952"> Bras & Triangle de suspension </div> <div data-bbox="591 890 756 936"> G/L D/R </div> </div> <div style="display: flex; justify-content: space-around; margin-top: 10px;"> <div data-bbox="244 957 434 1071"> Control arm Brazo y triángulo Wahacz Рычаг подвески </div> <div data-bbox="883 862 1389 1110"> </div> </div>			
5203413 OE 352041	Bras de suspension G Left track control arm	5213283 OE 352128	Bras de suspension D Right track control arm
	4 Sans rotule Without tie rod end TT /all models Sauf 1800kg 11/81-15/10/84		3 Sans rotule Without tie rod end TT /all models Sauf 1800kg 11/81-15/10/84
5203763 OE 352076	Bras de suspension G Left track control arm	5213523 OE 352152	Bras de suspension D Right track control arm
	4 Sans rotule Without tie rod end TT /all models Sauf 1800kg 16/10/84-		3 Sans rotule Without tie rod end TT /all models Sauf 1800kg 16/10/84-
5203773 OE 352077	Bras de suspension G Left track control arm	5213533 OE 352153	Bras de suspension D Right track control arm
	4 Sans rotule Without tie rod end TT /all models 1800kg 11/81-		3 Sans rotule Without tie rod end TT /all models 1800kg 11/81-

...C25...

SASIC

CITROEN

Bras & Triangle de suspension

Control arm
Brazo y triángulo
Wahacz
Рычаг подвески

G/L  D/R



...C25



Support d'amortisseur

Suspension mounting
Soporte amortiguador
Poduszka amortyzatora
Опора амортизатора

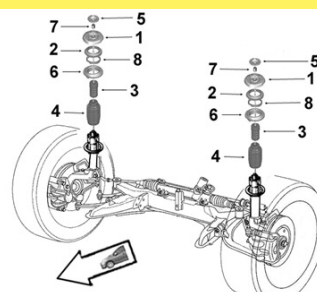

2105205

OE 521020

Support suspension G/D

L/R suspension mounting



1

TT /all models Carbu. sauf 4WD
TT /all models Diesel /2.5 TD

0355175

OE 503517

Butée à billes G/D

L/R ball bearing



2

TT /all models Carbu. sauf 4WD
TT /all models Diesel /2.5 TD

0335285

OE 503328

Butée de suspension G/D

L/R suspension bush



3
4

TT /all models Carbu. sauf 4WD Sauf 1800kg

TT /all models Diesel /2.5 TD Sauf 1800kg

C35

Eléments DIRECTION

Steering parts
Elementos Direcciones
Elementy układu kierowniczy
Элементы рулевой системы

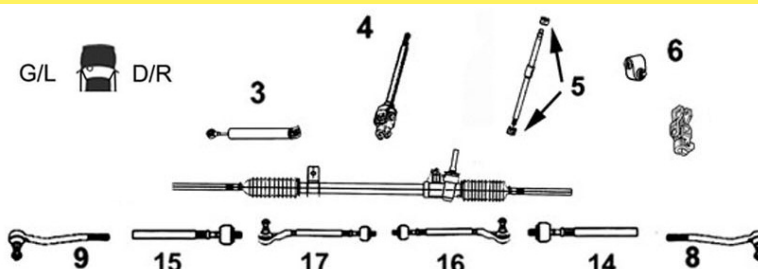

1264104

OE 412610

Bague de guidage colonne

Ring



5

TT /all models 07/83-

Jumper...

Eléments DIRECTION

Steering parts

Elementos Direcciones

Elementy układ kierowniczy

Элементы рулевой системы

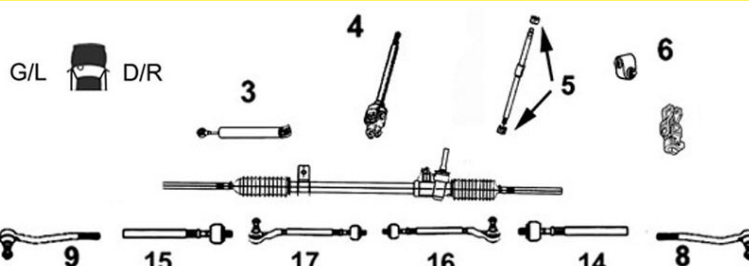

CITROEN

SASIC

3008070

Axe de bielle G/D

OE 4018A4

L/R axial joint



14 Côté dir. M16x1.5 Côté rot. M16x1.5 Long 319 mm
15

1.9 D	XUD9	-01/02
1.9 TD	XUD9TE/F	-01/02
2.0	XU102C XU10J2U	-01/02
2.0	XU10J2	01/02-07/06
2.0 HDi	DW10TD DW10UTD	-07/06
2.2 HDi	DW12UTED	-07/06
2.5 D TD	DJ5/T	-01/02
2.5 TDi	DJ5TED	-01/02
2.8 HDi	8140.63 8140.43S	-07/06
2.8 HDi 146hp 107kw Géométrie variable	8140.43N	01/02-07/06
2.8 TD	8140.43	-01/02
2.8 HDi	8140.43	01/02-07/06

7770008

Axe de bielle G/D

Part/oe 1611075080

L/R axial joint



NEW

14 Conduite à gauche Left hand drive Côté dir. M16x1.5 Côté rot. M16x1.5 Long 261 mm
15

2.2 HDi 100hp 74kw	PUMA 22DT	07/06-
2.2 HDi 110hp 81kw	PUMA C81 Euro 5	07/06-
2.2 HDi 120hp 88kw	PUMA 22DT	07/06-
2.2 HDi 130hp 95kw	PUMA 22DT	07/06-
2.2 HDi 130hp 96kw	PUMA C96 Euro 5	07/06-
2.2 HDi 150hp 110kw	PUMA C110 Euro 5	07/06-
3.0 HDi FAP 145hp 107kw	F30DT Euro 5	07/06-
3.0 HDi 155hp 114kw 175hp 129kw	F30DT Euro 5	07/06-
3.0 HDi 157hp 116kw	F30DT	07/06-

0184H44

Rotule de direction G/D

OE 4018A3

L/R tie rod end











8 M16x1.5
9

1.9 D	XUD9	-01/02
1.9 TD	XUD9TE	-01/02
2.0	XU102C	-01/02
2.0	XU10J2	-01/02
2.0 -ch 17175290	XU10J2	01/02-07/06
2.0 HDi	DW10TD	-01/02
2.0 HDi -ch 17175290	DW10TD	01/02-07/06
2.2 HDi -ch 17175290	DW12UTED	01/02-07/06
2.5 D	DJ5	-01/02
2.5 TD	DJ5T	-01/02
2.5 TDi	DJ5TED	-01/02
2.8 HDi	8140.63	-01/02
2.8 HDi	8140.43S	-01/02
2.8 HDi 147hp 108kw Géométrie variable	8140.43N	01/02-07/06
-ch 17175290	8140.43S	01/02-07/06
2.8 HDi -ch 17175290	8140.43S	01/02-07/06
2.8 HDi -ch 17175290	8140.43	01/02-07/06
2.8 TD	8140.43	-01/02

...Jumper...

CITROEN

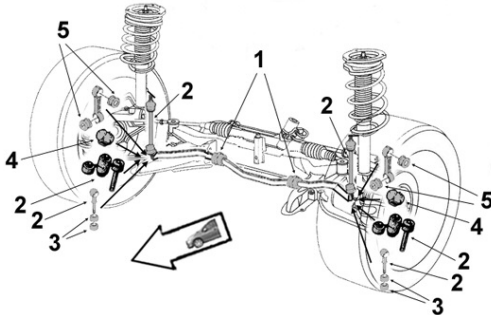

0184E04 OE 4018E0		Rotule de direction G/D <i>L/R tie rod end</i>	
	8	M16 x 1.5	
	9	2.0 /Bus	Ch- 17175291 XU10J2 01/02-07/06
		2.0 HDi	Ch- 17175291 DW10TD 01/02-07/06
		2.2 HDi	Ch- 17175291 DW12UTED 01/02-07/06
		2.8 HDi	Ch- 17175291 8140.43/S 01/02-07/06
		2.8 HDi 147hp 108kw	Géométrie variable Ch- 17175291 8140.43N 01/02-07/06
7670001 OE 1610976480		Rotule de direction G <i>Left tie rod end</i>	
	9		
		2.2 HDi	07/06-
		3.0 HDi	07/06-
7670002 OE 1610976380		Rotule de direction D <i>Right tie rod end</i>	
	8		
		2.2 HDi	07/06-
		3.0 HDi	07/06-
1264104 OE 412610		Bague de guidage colonne <i>Ring</i>	
	5	1.9 D	XUD9 -01/02
		1.9 TD	XUD9TE -01/02
		2.0	XU102C XU10J2 -01/02
		2.0 HDi	DW10TD -01/02
		2.5 D	DJ5 -01/02
		2.5 TD	DJ5T -01/02
		2.5 TDi	DJ5TED -01/02
		2.8 HDi	8140.63 8140.43S -01/02
		2.8 TD	8140.43 -01/02
1034E64 OE 4103E6		Axe de volant <i>Steering wheel shaft</i>	
	4	DNA	
		1.9 D	XUD9 -01/02
		1.9 TD	XUD9TE -01/02
		2.0	XU102C XU10J2 -01/02
		2.0 HDi	DW10TD -01/02
		2.5 D/TD	DJ5/T -01/02
		2.5 TDi	DJ5TED -01/02
		2.8 HDi	8140.63 8140.43S -01/02
		2.8 TD	8140.43 -01/02
1034E44 OE 4103E4		Axe de volant <i>Steering wheel shaft</i>	
	4	DA	
		1.9 D	XUD9 -01/02
		1.9 TD	XUD9TE -01/02
		2.0	XU102C XU10J2 -01/02
		2.0 HDi	DW10TD -01/02
		2.5 D/TD	DJ5/T -01/02
		2.5 TDi	DJ5TED -01/02
		2.8 HDi	8140.63 8140.43S -01/02
	2.8 TD	8140.43 -01/02	
	Barre stabilisatrice <i>Stabilizer bar</i> <i>Barra estabilizadora</i> <i>Drażek stabilizatora</i> стабилизатор поперечной устойчивости		
			
0875375 OE 508737		Biellette barre stab. <i>Stabilizer bar stub axle</i>	
	2	Ø 12 x 125 long. 134	
		TT /all models Sauf 4WD 02/94-07/06	
2300037 Part/oe 5081N9		Biellette barre stab. <i>Stabilizer bar stub axle</i>	
	2		
		2.2 HDi	07/06-
		3.0 HDi	07/06-

...Jumper...



Barre stabilisatrice
 Stabilizer bar
 Barra estabilizadora
 Drażek stabilizatora
 стабилизатор поперечной устойчивости

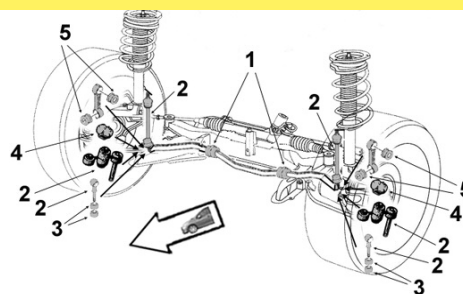

CITROEN

SASIC

0935155

OE 509315/16

Liaison élastique

Elastic link



3 Ø int.12.5 Ø ext.37.5
 long. tube int.20 ext.22

TT /all models Sauf 4WD	02/94-01/02
2.0i XU10J2	01/02-07/06
2.0 HDi DW10TD	01/02-07/06
2.2 HDi DW12UTED	01/02-07/06
2.2 HDi	07/06-
2.8 HDi	01/02-07/06
3.0 HDi	07/06-

8003210

Part/oe 508183

Palier de barre

Bar main bearing



1 Barre Ø 24

TT /all models Sauf 4WD 02/94-02/02

2300038

Part/oe 5081N9

Palier de barre

Bar main bearing



1 Barre Ø 26

2.2 HDi	07/06-
3.0 HDi	07/06-



Eléments SUSPENSION

Suspension parts
Elementos suspensión
Elementy zawieszenie
Элементы подвески

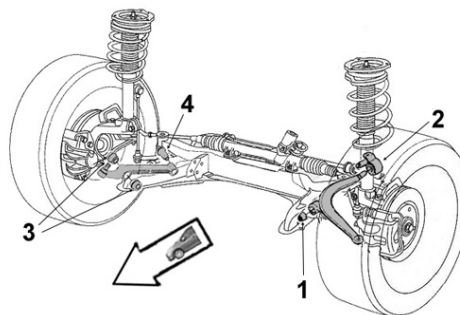

8003202

OE -

Articulation AV

Front bush



1 Ø int.18 Ø ext.45 coll.57.5 x2
 long. tube int.65 ext.49 ep. coll.7x2

TT /all models 02/94-02/02

5233933

OE 352393

Articulation AV

Front bush



1 Ø int.26 Ø ext.48 coll.57
 long. tube int.55 ext.38 ep. coll.6X2

2.0i XU10J2	02/02-07/06
2.0 HDi DW10TD	02/02-07/06
2.2 HDi DW12UTED	02/02-07/06
2.8 HDi Sofim	02/02-07/06
2.8 HDi 146hp 108kw	
Géométrie variable Sofim	02/02-07/06

2250004

Part/oe 3520S0

Articulation AV

Front bush



1 Ø int. 18 Ø ext. 56 coll. 59 long. tube int. 64 ext. 42 ep. coll.3X2 **Charge utile légère**

2.2 HDi 100hp 74kw 110hp 81kw 120hp 88kw 12Q 14Q 16Q	07/06-
2.2 HDi 130hp 96kw 150hp 110kw 12Q 14Q 16Q	07/06-
3.0 HDi 145hp 107kw 12Q 14Q 16Q Euro 5	30DT 07/06-
3.0 HDi 156hp 115kw 12Q 14Q 16Q Euro 5	30DT 07/06-
3.0 HDi 156hp 115kw 12Q 14Q 16Q	F30DT 07/06-
3.0 HDi 180hp 130kw 12Q 14Q 16Q Euro 5	30DT 07/06-

...Jumper...

CITROEN



8003204

Articulation AR

OE 352394

Rear bush



2 Ø int.34

TT /all models
2.0i / GPL
2.0 HDi
2.2 HDi
2.8 HDi

XU10J2
DW10TD
DW12UTED
Sofim

02/94-02/02
02/02-07/06
02/02-07/06
02/02-07/06
02/02-07/06

2250005

Articulation AR

Part/oe 3520S0

Rear bush



2 Ø int. 19 Ø ext. 74 long. tube int. 76 ext. 44

Charge utile légère

2.2 HDi 100hp 74kw 12Q 14Q 16Q
2.2 HDi 120hp 88kw 12Q 14Q 16Q
2.2 HDi 130hp 96kw 12Q 14Q 16Q
3.0 HDi 145hp 107kw 12Q 14Q 16Q
3.0 HDi 156hp 115kw 12Q 14Q 16Q
3.0 HDi 156hp 115kw 12Q 14Q 16Q

Euro 5 30DT
Euro 5 30DT
F30DT

07/06-
07/06-
07/06-
07/06-
07/06-
07/06-

Bras & Triangle de suspension

Control arm
Brazo y triángulo
Wahacz
Рычаг подвески

G/L D/R



5203953

Triangle de susp. G

OE 352095

Left track control arm



4 Sans rotule Without tie rod end

1.9 D/TD 1000kg 1400kg
2.0 1000kg 1400kg
2.0 800 1000 1400kg sauf VIN 935... -ch 17226522
2.0 HDi 1000kg 1400kg
2.0 HDi 800 1000 1400kg sauf VIN 935... -ch 17226522
2.2 HDi 800 1000 1400kg sauf VIN 935... -ch 17226522
2.5 D 1000 1400kg
2.5 TD/TDi 1000kg 1400kg
2.8 HDi 1000kg 1400kg
2.8 HDi 800 1000 1400kg sauf VIN 935... -ch 17226522
2.8 HDi 147hp 800 1000 1400kg sauf VIN 935... -ch 17226522
2.8 HDi 800 1000 1400kg sauf VIN 935... -ch 17226522
2.8 TD 1000kg 1400kg

XUD9/TE -01/02
XU102C/10J2 -01/02
XU10J2 01/02-07/06
DW10TD -01/02
DW10TD 01/02-07/06
DW12UTED 01/02-07/06
DJ5 -01/02
DJ5T/ED -01/02
8140.63/43S -01/02
8140.43S 01/02-07/06
8140.43N 01/02-07/06
8140.43 01/02-07/06
8140.43 -01/02

5213653

Triangle de susp. D

OE 3521H2

Right track control arm



3 Sans rotule Without tie rod end

1.9 D/TD 1000kg 1400kg
2.0 1000kg 1400kg
2.0 800 1000 1400kg sauf VIN 935... -ch 17226522
2.0 HDi 1000kg 1400kg
2.0 HDi 800 1000 1400kg sauf VIN 935... -ch 17226522
2.2 HDi 800 1000 1400kg sauf VIN 935... -ch 17226522
2.5 D 1000 1400kg
2.5 TD/TDi 1000kg 1400kg
2.8 HDi 1000kg 1400kg
2.8 HDi 800 1000 1400kg sauf VIN 935... -ch 17226522
2.8 HDi 147hp 800 1000 1400kg sauf VIN 935... -ch 17226522
2.8 HDi 800 1000 1400kg sauf VIN 935... -ch 17226522
2.8 TD 1000kg 1400kg

XUD9/TE -01/02
XU102C/10J2 -01/02
XU10J2 01/02-07/06
DW10TD -01/02
DW10TD 01/02-07/06
DW12UTED 01/02-07/06
DJ5 -01/02
DJ5T/ED -01/02
8140.63/43S -01/02
8140.43S 01/02-07/06
8140.43N 01/02-07/06
8140.43 01/02-07/06
8140.43 -01/02

...Jumper...

SASIC

CITROEN

Bras & Triangle de suspension

Control arm
Brazo y triángulo
Wahacz
Рычаг подвески

G/L  D/R

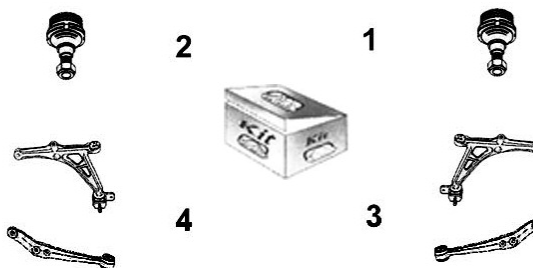

5203N33

OE 3520N3

Triangle de susp. G

Left track control arm

4 Sans rotule Without tie rod end



2.0i / 800 1000 1400kg GPL	sauf VIN 935...	Ch- 17226523	XU10J2	01/02-07/06
2.0 1400kg	VIN : 935...		XU10J2	01/02-07/06
2.0 HDi 800 1000 1400kg	sauf VIN 935...	Ch- 17226523	DW10TD	01/02-07/06
2.0 HDi 1400kg	VIN : 935...		DW10TD	01/02-07/06
2.2 HDi 800 1000 1400kg	sauf VIN 935...	Ch- 17226523	DW12UTED	01/02-07/06
2.2 HDi 1400kg	VIN : 935...		DW12UTED	01/02-07/06
2.8 HDi 147hp 108kw 800 1000 1400kg	Sauf VIN 935...	Ch- 17226523	8140.43N	01/02-07/06
2.8 HDi 147hp 108kw 1400kg	VIN : 935...		8140.43N	01/02-07/06
2.8 HDi 800 1000 1400kg sauf	VIN 935...	Ch- 17226523	8140.43S	01/02-07/06
2.8 HDi 1400kg	VIN : 936...		8140.43S	01/02-07/06
2.8 HDi 800 1000 1400kg sauf	VIN 935...	Ch- 17226523	8140.43	01/02-07/06
2.8 HDi 1400kg	VIN : 936...		8140.43	01/02-07/06

5213J33

OE 3521J3

Triangle de susp. D

Right track control arm

3 Sans rotule Without tie rod end



2.0i / 800 1000 1400kg GPL	sauf VIN 935...	Ch- 17226523	XU10J2	01/02-07/06
2.0 1400kg	VIN : 935...		XU10J2	01/02-07/06
2.0 HDi 800 1000 1400kg	sauf VIN 935...	Ch- 17226523	DW10TD	01/02-07/06
2.0 HDi 1400kg	VIN : 935...		DW10TD	01/02-07/06
2.2 HDi 800 1000 1400kg	sauf VIN 935...	Ch- 17226523	DW12UTED	01/02-07/06
2.2 HDi 1400kg	VIN : 935...		DW12UTED	01/02-07/06
2.8 HDi 147hp 108kw 800 1000 1400kg	Sauf VIN 935...	Ch- 17226523	8140.43N	01/02-07/06
2.8 HDi 147hp 108kw 1400kg	VIN : 935...		8140.43N	01/02-07/06
2.8 HDi 800 1000 1400kg sauf	VIN 935...	Ch- 17226523	8140.43S	01/02-07/06
2.8 HDi 1400kg	VIN : 936...		8140.43S	01/02-07/06
2.8 HDi 800 1000 1400kg sauf	VIN 935...	Ch- 17226523	8140.43	01/02-07/06
2.8 HDi 1400kg	VIN : 936...		8140.43	01/02-07/06

5203963

OE 352096

Triangle de susp. G

Left track control arm

4 Sans rotule Without tie rod end 1800kg



1.9 D	XUD9	-01/01
1.9 TD	XUD9TE	-01/01
2.0	XU102C XU10J2	-01/01
2.5 D	DJ5	-01/01
2.5 TD	DJ5T	-01/01
2.5 TDi	DJ5TED	-01/01
2.8 HDi	8140.63 8140.43S	-01/01
2.8 TD	8140.43	-01/01

5213663

OE 352166

Triangle de susp. D

Right track control arm

3 Sans rotule Without tie rod end 1800kg



1.9 D	XUD9	-01/01
1.9 TD	XUD9TE	-01/01
2.0	XU102C XU10J2	-01/01
2.5 D	DJ5	-01/01
2.5 TD	DJ5T	-01/01
2.5 TDi	DJ5TED	-01/01
2.8 HDi	8140.63 8140.43S	-01/01
2.8 TD	8140.43	-01/01

5203N43

OE 3520N4

Triangle de susp. G

Left track control arm

4 Sans rotule Without tie rod end 1800kg



1.9 D TD	XUD9/TE	02/01-01/02
2.0	XU10J2	02/01-07/06
2.0 HDi	DW10TD	02/01-07/06
2.2 HDi	DW12UTED	01/02-07/06
2.5 D TD	DJ5/T	02/01-01/02
2.5 TDi	DJ5TED	02/01-01/02
2.8 HDi	8140.43S	02/01-07/06
2.8 HDi	147hp 108kw 8140.43N	01/02-07/06
2.8 TD	8140.43	02/01-01/02

5213J43

OE 3521J4

Triangle de susp. D





Right track control arm

3 Sans rotule Without tie rod end 1800kg



1.9 D TD	XUD9/TE	02/01-01/02
2.0	XU10J2	02/01-07/06
2.0 HDi	DW10TD	02/01-07/06
2.2 HDi	DW12UTED	01/02-07/06
2.5 D TD	DJ5/T	02/01-01/02
2.5 TDi	DJ5TED	02/01-01/02
2.8 HDi	8140.43S	02/01-07/06
2.8 HDi	147hp 108kw 8140.43N	01/02-07/06
2.8 TD	8140.43	02/01-01/02

...Jumper...

7470008 OE 3520S0	Triangle de susp. G <i>Left track control arm</i>	7470007 OE 3521P1	Triangle de susp. D <i>Right track control arm</i>
	4 Sans rotule <i>Without tie rod end</i>		3 Sans rotule <i>Without tie rod end</i>
	2.2 HDi 07/06- 3.0 HDi 07/06-		2.2 HDi 07/06- 3.0 HDi 07/06-
6403323 OE 364032	Rotule de susp. inf. G/D <i>L/R lower suspension ball joint</i>		
	1 M16 x 1.5 2		
	1.9 D 1000kg 1400kg Tambour AR -ch 16205754 XUD9 -01/01 Sans ABS 1.9 D 1000kg 1400kg Tambour AR -ch 16206253 XUD9 -01/01 ABS 1.9 TD 1000kg 1400kg Tambour AR -ch 16205754 XUD9TE -01/01 Sans ABS 1.9 TD 1000kg 1400kg Tambour AR -ch 16206253 XUD9TE -01/01 ABS 2.0 1000kg 1400kg Tambour AR -ch 16205754 XU102C -01/01 Sans ABS 2.0 1000kg 1400kg Tambour AR -ch 16206253 XU102C -01/01 ABS 2.0 1000kg 1400kg Tambour AR -ch 16205754 XU10J2 -01/01 Sans ABS 2.0 1000kg 1400kg Tambour AR -ch 16206253 XU10J2 -01/01 ABS 2.5 D TD 1000kg 1400kg Tambour AR -ch 16205754 DJ5/T -01/01 Sans ABS 2.5 D TD 1000kg 1400kg Tambour AR -ch 16206253 DJ5/T -01/01 ABS 2.5 TDi 1000kg 1400kg Tambour AR -ch 16205754 DJ5TED -01/01 Sans ABS 2.5 TDi 1000kg 1400kg Tambour AR -ch 16206253 DJ5TED -01/01 ABS 2.8 HDi 1000kg 1400kg Tambour AR -ch 16205754 8140.43S -01/01 Sans ABS 2.8 HDi 1000kg 1400kg Tambour AR -ch 16206253 8140.43S -01/01 ABS 2.8 HDi 1000kg 1400kg Tambour AR -ch 16205754 8140.63 -01/01 Sans ABS 2.8 HDi 1000kg 1400kg Tambour AR -ch 16206253 8140.63 -01/01 ABS 2.8 TD 1000kg 1400kg Tambour AR -ch 16205754 8140.43 -01/01 Sans ABS 2.8 TD 1000kg 1400kg Tambour AR -ch 16206253 8140.43 -01/01 ABS		
6403553 OE 364055	Rotule de susp. inf. G/D <i>L/R lower suspension ball joint</i>		
	1		
	1.9 D TD 1000kg 1400kg Tambour AR -ch 16205754 XUD9/TE 02/01- Sans ABS 1.9 D TD 1000kg 1400kg Tambour AR Ch- 16205755 XUD9/TE -01/02 Sans ABS 1.9 D TD 1000kg 1400kg Tambour AR -ch 16206253 XUD9/TE 02/01- ABS 1.9 D TD 1000kg 1400kg Tambour AR Ch- 16206254 XUD9/TE -01/02 ABS 1.9 D TD 1000kg 1400kg Disque AR XUD9/TE -01/02 ABS 2.0 1000kg 1400kg Tambour AR -ch 16205754 XU102C XU10J2 02/01- Sans ABS 2.0 1000kg 1400kg Tambour AR Ch- 16205755 XU102C XU10J2 -01/02 Sans ABS 2.0 1000kg 1400kg Tambour AR -ch 16206253 XU102C XU10J2 02/01- ABS 2.0 1000kg 1400kg Tambour AR Ch- 16206254 XU102C XU10J2 -01/02 ABS 2.0 1000kg 1400kg Disque AR XU102C XU10J2 -01/02 ABS 2.0 HDi 1000kg 1400kg Tambour AR -ch 16205754 DW10TD 02/01- Sans ABS 2.0 HDi 1000kg 1400kg Tambour AR Ch- 16205755 DW10TD -01/02 Sans ABS 2.0 HDi 1000kg 1400kg Tambour AR -ch 16206253 DW10TD 02/01- ABS 2.0 HDi 1000kg 1400kg Tambour AR Ch- 16206254 DW10TD -01/02 ABS 2.0 HDi 1000kg 1400kg Disque AR DW10TD -01/02 ABS 2.0 HDi 800 1000 1400kg DW10TD 01/02-07/06 2.2 HDi 800 1000 1400kg DW12UTED 01/02-07/06 2.5 D 1000 1400kg Tambour AR -ch 16205754 DJ5 02/01- Sans ABS 2.5 D 1000 1400kg Tambour AR Ch- 16205755 DJ5 -01/02 Sans ABS 2.5 D 1000 1400kg Tambour AR -ch 16206253 DJ5 02/01- ABS 2.5 D 1000 1400kg Tambour AR Ch- 16206254 DJ5 -01/02 ABS 2.5 D 1000 1400kg Disque AR DJ5 -01/02 ABS 2.5 TD/i 1000kg 1400kg Tambour AR -ch 16205754 DJ5T/ED 02/01- Sans ABS 2.5 TD/i 1000kg 1400kg Tambour AR Ch-16205755 DJ5T/ED -01/02 Sans ABS 2.5 TD/i 1000kg 1400kg Tambour AR -ch 16206253 DJ5T/ED 02/01- ABS 2.5 TD/i 1000kg 1400kg Tambour AR Ch-16206254 DJ5T/ED -01/02 ABS 2.5 TD/i 1000kg 1400kg Disque AR DJ5T/ED -01/02 ABS 2.8 HDi 1000kg 1400kg Tambour AR -ch 16205754 8140.43/S 02/01- Sans ABS 2.8 HDi 1000kg 1400kg Tambour AR -ch 16206253 8140.43/S 02/01- ABS 2.8 HDi 800 1000 1400kg 8140.43/S 01/02-07/06 2.8 HDi 800 1000 1400kg 146hp 107kw 8140.43N 01/02-07/06 2.8 HDi 1000kg 1400kg Disque AR 8140.43S -01/02 ABS 2.8 HDi 1000kg 1400kg Tambour AR -ch 16205754 8140.63 02/01- Sans ABS 2.8 HDi 1000kg 1400kg Tambour AR Ch- 16205755 8140.63 -01/02 Sans ABS 2.8 HDi 1000kg 1400kg Tambour AR -ch 16206253 8140.63 02/01- ABS 2.8 HDi 1000kg 1400kg Tambour AR Ch- 16206254 8140.63 -01/02 ABS 2.8 HDi 1000kg 1400kg Disque AR 8140.63 -01/02 ABS 2.8 TD 1000kg 1400kg Tambour AR Ch- 16205755 8140.43 -01/02 Sans ABS 2.8 TD 1000kg 1400kg Tambour AR Ch- 16206254 8140.43 -01/02 ABS 2.8 TD 1000kg 1400kg Disque AR 8140.43 -01/02 ABS		

...Jumper...

Bras & Triangle de suspension

Control arm
Brazo y triángulo
Wahacz
Рычаг подвески

G/L  D/R



CITROEN



6403333

OE 364033

Rotule de susp. inf. G/D

L/R lower suspension ball joint



1
2

M18x1.5

1.9 D	1800kg	Tambour AR	-ch 16205352	XUD9	-01/01	Sans ABS
1.9 D	1800kg	Tambour AR	-ch 16194399	XUD9	-01/01	ABS
1.9 TD	1800kg	Tambour AR	-ch 16205352	XUD9TE	-01/01	Sans ABS
1.9 TD	1800kg	Tambour AR	-ch 16194399	XUD9TE	-01/01	ABS
2.0	1800kg	Tambour AR	-ch 16205352	XU102C	-01/01	Sans ABS
2.0	1800kg	Tambour AR	-ch 16194399	XU102C	-01/01	ABS
2.0	1800kg	Tambour AR	-ch 16205352	XU10J2	-01/01	Sans ABS
2.0	1800kg	Tambour AR	-ch 16194399	XU10J2	-01/01	ABS
2.5 D	1800kg	Tambour AR	-ch 16205352	DJ5	-01/01	Sans ABS
2.5 D	1800kg	Tambour AR	-ch 16194399	DJ5	-01/01	ABS
2.5 TD	1800kg	Tambour AR	-ch 16205352	DJ5T	-01/01	Sans ABS
2.5 TD	1800kg	Tambour AR	-ch 16194399	DJ5T	-01/01	ABS
2.5 TDi	1800kg	Tambour AR	-ch 16205352	DJ5TED	-01/01	Sans ABS
2.5 TDi	1800kg	Tambour AR	-ch 16194399	DJ5TED	-01/01	ABS
2.8 HDi	1800kg	Tambour AR	-ch 16205352	8140.43S	-01/01	Sans ABS
2.8 HDi	1800kg	Tambour AR	-ch 16194399	8140.43S	-01/01	ABS
2.8 HDi	1800kg	Tambour AR	-ch 16205352	8140.63	-01/01	Sans ABS
2.8 HDi	1800kg	Tambour AR	-ch 16194399	8140.63	-01/01	ABS
2.8 TD	1800kg	Tambour AR	-ch 16205352	8140.43	-01/01	Sans ABS
2.8 TD	1800kg	Tambour AR	-ch 16194399	8140.43	-01/01	ABS

6403543

OE 364054

Rotule de susp. inf. G/D

L/R lower suspension ball joint











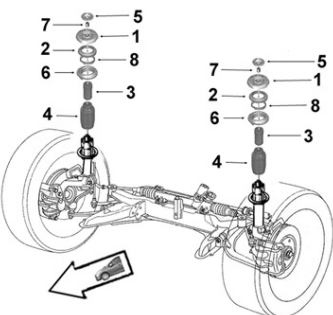

1
2

M18x1.5

1.9 D TD	1800kg	Tambour AR	-ch 16205352	XUD9/TE	01/01-	Sans ABS
1.9 D TD	1800kg	Tambour AR	-ch 16194399	XUD9/TE	01/01-	ABS
1.9 D TD	1800kg	Disques AR	Ch- 16205353	XUD9/TE	-01/02	Sans ABS
1.9 D TD	1800kg	Disques AR	Ch- 16194400	XUD9/TE	-01/02	ABS
2.0	1800kg	Tambour AR	-ch 16205352	XU102C/10J2	01/01-	Sans ABS
2.0	1800kg	Tambour AR	-ch 16194399	XU102C/10J2	01/01-	ABS
2.0	1800kg	Disques AR	Ch- 16205353	XU102C/10J2	-01/02	Sans ABS
2.0	1800kg	Disques AR	Ch- 16194400	XU102C/10J2	-01/02	ABS
2.0	1800kg			XU10J2	01/02-07/06	
2.0 HDi	1800kg	Tambour AR	-ch 16205352	DW10TD	01/01-	Sans ABS
2.0 HDi	1800kg	Tambour AR	-ch 16194399	DW10TD	01/01-	ABS
2.0 HDi	1800kg	Disques AR	Ch- 16205353	DW10TD	-01/02	Sans ABS
2.0 HDi	1800kg	Disques AR	Ch- 16194400	DW10TD	-01/02	ABS
2.0 HDi	1800kg			DW10TD	01/02-07/06	
2.0 HDi	1800kg			DW12UTED	01/02-07/06	
2.5 D	1800kg	Tambour AR	-ch 16205352	DJ5	01/01-	Sans ABS
2.5 D	1800kg	Tambour AR	-ch 16194399	DJ5	01/01-	ABS
2.5 D	1800kg	Disques AR	Ch- 16205353	DJ5	-01/02	Sans ABS
2.5 D	1800kg	Disques AR	Ch- 16194400	DJ5	-01/02	ABS
2.5 TD/i	1800kg	Tambour AR	-ch 16205352	DJ5/TED	01/01-	Sans ABS
2.5 TD/i	1800kg	Tambour AR	-ch 16194399	DJ5/TED	01/01-	ABS
2.5 TD/i	1800kg	Disques AR	Ch- 16205353	DJ5/TED	-01/02	Sans ABS
2.5 TD/i	1800kg	Disques AR	Ch- 16194400	DJ5/TED	-01/02	ABS
2.8 HDi	1800kg	Tambour AR	-ch 16205352	8140.43/S	01/01-	Sans ABS
2.8 HDi	1800kg	Tambour AR	-ch 16194399	8140.43/S	01/01-	ABS
2.8 HDi	1800kg			8140.43/S	01/02-07/06	
2.8 HDi	146hp 107kw 1800kg	Géométrie variable		8140.43N	01/02-07/06	
2.8 HDi	1800kg	Disques AR	Ch- 16205353	8140.43S	-01/02	Sans ABS
2.8 HDi	1800kg	Disques AR	Ch- 16194400	8140.43S	-01/02	ABS
2.8 HDi	1800kg	Tambour AR	-ch 16205352	8140.63	01/01-	Sans ABS
2.8 HDi	1800kg	Tambour AR	-ch 16194399	8140.63	01/01-	ABS
2.8 HDi	1800kg	Disques AR	Ch- 16205353	8140.63	-01/02	Sans ABS
2.8 HDi	1800kg	Disques AR	Ch- 16194400	8140.63	-01/02	ABS
2.8 TD	800kg	Disques AR	Ch- 16205353	8140.43	-01/02	Sans ABS
2.8 TD	1800kg	Disques AR	Ch- 16194400	8140.43	-01/02	ABS

...Jumper...

7570001 OE 364076	Rotule de susp. inf. G/D <i>L/R lower suspension ball joint</i>	1003570 OE -	Kit rép. triangle susp. G ou D <i>L or R track control arm bearing repair kit</i>
	1 2 M16 x 1.5 2.2 HDi 07/06- 3.0 HDi 07/06-		Sans visserie <i>Without screws and bolts</i> 1.9 D TD XUD9/TE -01/02 2.0 XU102C XU10J2 -01/02 2.0 HDi DW10TD -01/02 2.5 D TD DJ5/T -01/02 2.5 TDi DJ5TED -01/02 2.8 HDi 8140.63 8140.43S -01/02 2.8 TD 8140.43 -01/02
 <p>Support d'amortisseur <i>Suspension mounting</i> <i>Soporte amortiguador</i> <i>Poduszka amortyzatora</i> <i>Опора амортизатора</i></p>			
0385185 OE 503818	Support suspension G <i>Left suspension mounting</i>	0385195 OE 503819	Support suspension D <i>Right suspension mounting</i>
	1 TT /all models sauf Sofim diesel -ch 15616153 02/94-02/02		1 TT /all models sauf Sofim diesel -ch 15616153 02/94-02/02
0385195 OE 503874	Support suspension G <i>Left suspension mounting</i>	0385185 OE 503872	Support suspension D <i>Right suspension mounting</i>
	1 TT /all models sauf Sofim diesel Ch- 15616154 02/94-02/02		1 TT /all models sauf Sofim diesel Ch- 15616154 02/94-02/02
0385285 OE 503828	Support suspension G <i>Left suspension mounting</i>	0385295 OE 503829	Support suspension D <i>Right suspension mounting</i>
	1 TT /all models Sofim diesel -ch 15616153 02/94-02/02		1 TT /all models Sofim diesel -ch 15616153 02/94-02/02
0385295 OE 503829	Support suspension G <i>Left suspension mounting</i>	0385285 OE 503828	Support suspension D <i>Right suspension mounting</i>
	1 TT /all models Sofim diesel Ch- 15616154 02/94-02/02 TT /all models 800/1000/1400/1800kg Sauf 4WD Piste 02/02-07/06		1 TT /all models Sofim diesel Ch- 15616154 02/94-02/02 TT /all models 800/1000/1400/1800kg Sauf 4WD Piste 02/02-07/06

...Jumper...

SASIC







CITROEN

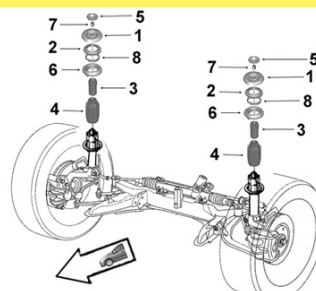

Support d'amortisseur

Suspension mounting
Soporte amortiguador
Poduszka amortyzatora
Опора амортизатора











0385875 OE 5038E3	Support suspension G <i>Left suspension mounting</i>	0385895 OE 5038E2	Support suspension D <i>Right suspension mounting</i>
	1 800 1000 1400 1800kg sauf VIN 935... Sauf piste 2.0i XU10J2 02/02-07/06 2.0 HDi DW10TD 02/02-07/06 2.2 HDi DW12UTED 02/02-07/06 2.8 HDi Sofim 02/02-07/06		1 800 1000 1400 1800kg sauf VIN 935... Sauf piste 2.0i XU10J2 02/02-07/06 2.0 HDi DW10TD 02/02-07/06 2.2 HDi DW12UTED 02/02-07/06 2.8 HDi Sofim 02/02-07/06
2650033 OE 1607691280	Support suspension G <i>Left suspension mounting</i>	2650034 OE 1607690980	Support suspension D <i>Right suspension mounting</i>
	1 2.2 HDi 100hp 74kw 120hp 88kw 130hp 95kw Susp. métallique 07/06-31/03/11 Susp. métallique AV Pneumatique AR 07/06- 2.3 TD 1400 1800kg VIN : 935... Sofim 01/02-07/06 3.0 HDi Susp. métallique 07/06-31/03/11 Susp. métallique AV Pneumatique AR 07/06-		1 2.2 HDi 100hp 74kw 120hp 88kw 130hp 95kw Susp. métallique 07/06-31/03/11 Susp. métallique AV Pneumatique AR 07/06- 2.3 TD 1400 1800kg VIN : 935... Sofim 01/02-07/06 3.0 HDi Susp. métallique 07/06-31/03/11 Susp. métallique AV Pneumatique AR 07/06-
0355395 OE 503547	Butée à billes G/D <i>L/R ball bearing</i>		
	2 TT /all models Sauf 4WD 02/94-02/02 2.0i / 800 1000 1400 1800kg GPL Sauf 4WD Dangel XU10J2 02/02-07/06 2.0 HDi 800 1000 1400 1800kg Sauf 4WD Dangel DW10TD 02/02-07/06 2.2 HDi 800 1000 1400 1800kg Sauf 4WD Dangel DW12UTED 02/02-07/06 2.2 HDi 100hp 74kw 120hp 88kw 130hp 95kw 07/06- 2.8 HDi 800 1000 1400 1800kg Sauf 4WD Dangel Sofim 02/02-07/06 3.0 HDi 145hp 107kw F30DT Euro 5 07/06- 3.0 HDi 156hp 115kw F30DT /Euro 5 07/06- 3.0 HDi 180hp 130kw F30DT Euro 5 07/06-		
0355505 OE 503550	Joint amortisseur G/D <i>L/R shock absorber gasket</i>		
	8 TT /all models 02/94-02/02 2.0i 800 1000 1400 1800kg XU10J2 02/02-07/06 2.0 HDi 800 1000 1400 1800kg DW10TD 02/02-07/06 2.2 HDi 800 1000 1400 1800kg DW12UTED 02/02-07/06 2.2 HDi 100hp 74kw 120hp 88kw 130hp 95kw 07/06- 2.8 HDi 800 1000 1400 1800kg Sofim 02/02-07/06 3.0 HDi 145hp 107kw F30DT Euro 5 07/06- 3.0 HDi 156hp 115kw F30DT/ Euro 5 07/06-		
0335415 OE 503341	Butée de suspension G/D <i>L/R suspension bush</i>		
	3 1.9D TD 1000kg 1400kg XUD9/TE 02/94-02/02 4 2.0i / 800 1000 1400kg GPL sauf VIN 935... sauf piste XU10J2 02/02-07/06 2.0i 1000 1400kg XU10J2 02/94-02/02 2.0 HDi 800 1000 1400kg sauf VIN 935... sauf piste DW10TD 02/02-07/06 2.2 HDi 800 1000 1400kg sauf VIN 935... sauf piste DW12UTED 02/02-07/06 2.5 D/TD 1000kg 1400kg DJ5/T 02/94-02/02 2.5 TDi 1000kg 1400kg DJ5TED 02/94-02/02 2.8 HDi 1000kg 1400kg Sofim 02/94-02/02 2.8 HDi 800 1000 1400kg sauf VIN 935... sauf piste Sofim 02/02-07/06		

...Jumper...

CITROEN



2650009		Butée de suspension	
OE 503342		<i>Shock bush</i>	
	3	H85	
	4	1.9 D TD 1800kg	XUD9/TE 02/94-02/02
		2.0 1800kg	XU10J2 02/94-02/02
		2.5 DTD 1800kg	DJ5/T 02/94-02/02
		2.5 TDi 1800kg	DJ5TED 15/12/94-02/02
		2.8 HDi 1800kg	Sofim 02/94-02/02
		TT /all models 1800kg	Sauf VIN 935... Sauf piste -ch 17287232 02/02-
0335575		Butée de suspension G/D	
OE 503357		<i>L/R suspension bush</i>	
	3		
		2.8 TD Sofim 02/94-02/02	
		2.8 HDi Sofim 02/94-02/02	
	TT /all models 1400kg 1800kg	VIN 935...	02/02-07/06
2650019		Butée de suspension G/D	
OE 5033E6		<i>L/R suspension bush</i>	
	3		
		2.2 HDi 100hp 74kw 16Q 20Q	Charge utile lourde susp. métallique Susp. AR renforcée 07/06-
		2.2 HDi 110hp 81kw 12Q 14Q 16Q	Charge utile légère susp. métallique 01/04/11-
		2.2 HDi 120hp 88kw 12Q 14Q 16Q	Charge utile légère susp. métallique 07/06-
		2.2 HDi 130hp 95kw 12Q 14Q 16Q	Charge utile légère susp. métallique 07/06-
		2.2 HDi 150hp 110kw 12Q 14Q 16Q	Charge utile légère susp. métallique 01/04/11-
		3.0 HDi 145hp 107kw 12Q 14Q 16Q	Charge utile légère F30DT Euro 5 07/06-
		3.0 HDi 155hp 115kw 12Q 14Q 16Q	Charge utile légère F30DT Euro 5 07/06-
	3.0 HDi 180hp 130kw 12Q 14Q 16Q	Charge utile légère F30DT Euro 5 07/06-	
0335285		2545285	
OE 503328		OE 525428	
<i>Butée de suspension G/D</i>		<i>Protecteur amortisseur G/D</i>	
<i>L/R suspension bush</i>		<i>L/R shock absorber protector</i>	
	3		4
	4		TT /all models sauf VIN 935... Piste 800/1000/1400/1800kg 02/02-07/06
2650023		Protecteur amortisseur G/D	
OE 5033A6		<i>L/R shock absorber protector</i>	
	4		
		2.2 HDi 07/06-	
		3.0 HDi 07/06-	
1005272		1005273	
OE -		OE -	
<i>Kit rép. suspension G</i>		<i>Kit rép. suspension D</i>	
<i>Left susp. mounting repair kit</i>		<i>Right susp. mounting repair kit</i>	
			
	2.8 HDi sauf 4WD Piste -ch 15616153 8140.43/S 8140.63		

...Jumper...

SASIC

CITROEN



Support d'amortisseur
 Suspension mounting
 Soporte amortiguador
 Poduszka amortyzatora
 Опора амортизатора

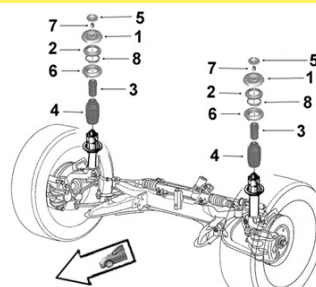

1005273

Kit rép. suspension G

OE -

Left susp. mounting repair kit



2.0	800 1000kg	Sauf 4WD	Route inégale	XU10J2	01/02-07/06
2.0	1400 1800kg	sauf VIN 935...	sauf 4WD Dangel Route inégale	XU10J2	01/02-07/06
2.0	1400kg 1800kg	VIN 935...	Sauf 4WD	XU10J2	01/02-07/06
2.0 HDi	800 1000kg	Sauf 4WD	Route inégale	DW10TD	01/02-07/06
2.0 HDi	1400/1800kg	sauf VIN 935...	sauf 4WD Dangel Route inégale	DW10TD	01/02-07/06
2.0 HDi	1400kg 1800kg	VIN 935...	Sauf 4WD	DW10TD	01/02-07/06
2.2 HDi	800 1000kg	Sauf 4WD	Route inégale	DW12UTED	01/02-07/06
2.2 HDi	1400/1800kg	sauf VIN 935...	sauf 4WD Dangel Route inégale	DW12UTED	01/02-07/06
2.2 HDi	1400kg 1800kg	VIN 935...	Sauf 4WD	DW12UTED	01/02-07/06
2.8 HDi	800 1000kg	sauf 4WD	Route inégale	8140.43	01/02-07/06
2.8 HDi	1400/1800kg	sauf VIN 935...	sauf 4WD Dangel Route inégale	8140.43	01/02-07/06
2.8 HDi	1400kg 1800kg	VIN 935...	Sauf 4WD	8140.43	01/02-07/06
2.8 HDi	146hp 107kw 800 1000kg		Sauf 4WD Géométrie variable Route inégale	8140.43N	01/02-07/06
2.8 HDi	146hp 107kw 1400/1800kg		Sauf 4WD Dangel Sauf VIN : 935... Géométrie variable Route inégale	8140.43N	01/02-07/06
2.8 HDi	146hp 107kw 1400/1800kg		VIN 935... sauf 4WD Géométrie variable	8140.43N	01/02-07/06
2.8 HDi			sauf 4WD Piste Ch- 15616154	8140.43S	-01/02
2.8 HDi	800 1000kg	sauf 4WD	Route inégale	8140.43S	01/02-07/06
2.8 HDi	1400/1800kg	sauf VIN 935...	sauf 4WD Dangel Route inégale	8140.43S	01/02-07/06
2.8 HDi	1400kg 1800kg	VIN 935...	sauf 4WD	8140.43S	01/02-07/06
2.8 HDi	sauf 4WD Piste		Ch- 15616154	8140.63	-01/02
2.8 TD	sauf 4WD Piste		Ch- 15616154	8140.43	-01/02

1005272

Kit rép. suspension D

OE -

Right susp. mounting repair kit



2.0	800 1000kg	Sauf 4WD	Route inégale	XU10J2	01/02-07/06
2.0	1400 1800kg	sauf VIN 935...	sauf 4WD Dangel Route inégale	XU10J2	01/02-07/06
2.0	1400kg 1800kg	VIN 935...	Sauf 4WD	XU10J2	01/02-07/06
2.0 HDi	800 1000kg	Sauf 4WD	Route inégale	DW10TD	01/02-07/06
2.0 HDi	1400/1800kg	sauf VIN 935...	sauf 4WD Dangel Route inégale	DW10TD	01/02-07/06
2.0 HDi	1400kg 1800kg	VIN 935...	Sauf 4WD	DW10TD	01/02-07/06
2.2 HDi	800 1000kg	Sauf 4WD	Route inégale	DW12UTED	01/02-07/06
2.2 HDi	1400/1800kg	sauf VIN 935...	sauf 4WD Dangel Route inégale	DW12UTED	01/02-07/06
2.2 HDi	1400kg 1800kg	VIN 935...	Sauf 4WD	DW12UTED	01/02-07/06
2.8 HDi	800 1000kg	sauf 4WD	Route inégale	8140.43	01/02-07/06
2.8 HDi	1400/1800kg	sauf VIN 935...	sauf 4WD Dangel Route inégale	8140.43	01/02-07/06
2.8 HDi	1400kg 1800kg	VIN 935...	Sauf 4WD	8140.43	01/02-07/06
2.8 HDi	146hp 107kw 800 1000kg		Sauf 4WD Géométrie variable Route inégale	8140.43N	01/02-07/06
2.8 HDi	146hp 107kw 1400/1800kg		Sauf 4WD Dangel Sauf VIN : 935... Géométrie variable Route inégale	8140.43N	01/02-07/06
2.8 HDi	146hp 107kw 1400/1800kg		VIN 935... sauf 4WD Géométrie variable	8140.43N	01/02-07/06
2.8 HDi			sauf 4WD Piste Ch- 15616154	8140.43S	-01/02
2.8 HDi	800 1000kg	sauf 4WD	Route inégale	8140.43S	01/02-07/06
2.8 HDi	1400/1800kg	sauf VIN 935...	sauf 4WD Dangel Route inégale	8140.43S	01/02-07/06
2.8 HDi	1400kg 1800kg	VIN 935...	sauf 4WD	8140.43S	01/02-07/06
2.8 HDi	sauf 4WD Piste		Ch- 15616154	8140.63	-01/02
2.8 TD	sauf 4WD Piste		Ch- 15616154	8140.43	-01/02

1005266

Kit rép. suspension G

OE -

Right susp. mounting repair kit



Sauf 4WD Sauf piste -ch 15616153

1.9 D	XUD9
1.9 TD	XUD9TE
2.0	XU102C XU10J2
2.0 HDi	DW10TD
2.5 D	DJ5
2.5 TD	DJ5T
2.5 TDi	DJ5TED

1005267

Kit rép. suspension D

OE -



Right susp. mounting repair kit



Sauf 4WD Sauf piste -ch 15616153

1.9 D	XUD9
1.9 TD	XUD9TE
2.0	XU102C XU10J2
2.0 HDi	DW10TD
2.5 D	DJ5
2.5 TD	DJ5T
2.5 TDi	DJ5TED

...Jumper...

1005267	Kit rép. suspension G	1005266	Kit rép. suspension D
OE -	<i>Left susp. mounting repair kit</i>	OE -	<i>Right susp. mounting repair kit</i>
	Sauf 4WD Sauf piste Ch- 15616154 1.9 D TD XUD9/TE -01/02 2.0 XU102CXU10J2 -01/02 2.0 HDi DW10TD -01/02 2.5 D DJ5 -01/02 2.5 TD DJ5T -01/02 2.5 TDi DJ5TED -01/02		Sauf 4WD Sauf piste Ch- 15616154 1.9 D TD XUD9/TE -01/02 2.0 XU102CXU10J2 -01/02 2.0 HDi DW10TD -01/02 2.5 D DJ5 -01/02 2.5 TD DJ5T -01/02 2.5 TDi DJ5TED -01/02



Barre stabilisatrice
Stabilizer bar
Barra estabilizadora
Drążek stabilizatora
 стабилизатор поперечной устойчивости

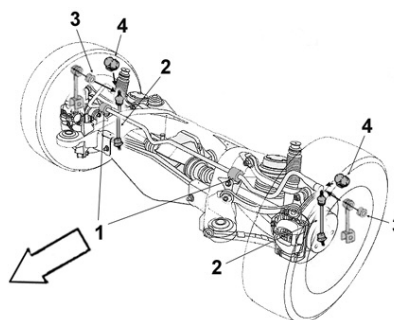



2300039	Biellette barre stab.
Part/oe 5170F5	<i>Stabilizer bar stub axle</i>
	2 2.2 HDi 07/06- 3.0 HDi 07/06-

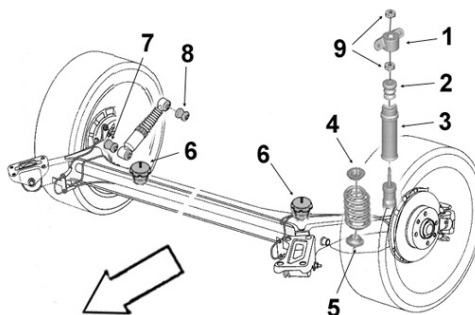

Support d'amortisseur
Suspension mounting
Soporte amortiguador
Poduszka amortyzatora
 Опора амортизатора



2650026	Butée de talonnage
OE 516688	<i>Bushing</i>
	6 2.2 HDi Susp. métallique Sauf susp. AR renforcée Charge utile 12/14/16Q 07/06- 2.2 HDi Susp. métallique Susp. AR renforcée Charge utile lourde 20Q 07/06- Sauf fourgon semi vitré et motrice nue 07/06- 3.0 HDi Susp. métallique Sauf susp. AR renforcée Charge utile 12/14/16Q 07/06- 3.0 HDi Susp. métallique Susp. AR renforcée Charge utile lourde 20Q 07/06- Sauf fourgon semi vitré et motrice nue 07/06-

2650029	Butée de talonnage
OE 516697	<i>Bushing</i>
	6 Susp. métallique Sauf susp. AR renforcée Charge utile lourde 20Q Sauf Fourgon semi vitré et motrice nue 2.2 HDi 07/06- 3.0 HDi 07/06-

...Jumper



Support d'amortisseur
 Suspension mounting
 Soporte amortiguador
 Poduszka amortyzatora
 Опора амортизатора

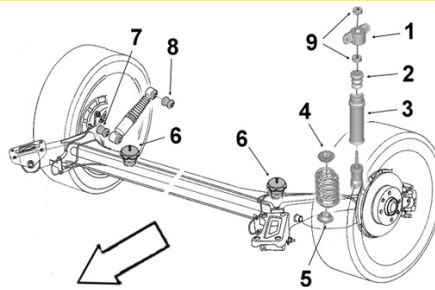

2650027
 OE 5166A3

Butée de talonnage
 Bushing



6 Susp. métallique Susp. AR renforcée Charge utile 12/14/16Q

2.2 HDi
 3.0 HDi

07/06-
 07/06-

Eléments TRAIN ARRIERE

Rear axle parts
 Tren TRAS
 Elementy zawieszenia tylnego
 элементы задней оси.



1315735
 OE 513173

Articulation AV lame
 Front leaf bush



Ø int.16.5 Ø ext.49 coll. 53 x2
 long. tube int. 87 ext.70 coll.3

TT /all models sauf camping car
 -ch 16194399 02/94-02/02
 TT /all models Camping car
 02/94-02/02

1315725
 OE 513172

Articulation AR lame
 Rear leaf bush



Ø int.16 Ø ext.41 coll.57 long. tube int.46.5
 ext.40 coll.5

TT /all models sauf camping car
 -ch 16194399 02/94-02/02
 TT /all models Camping car
 02/94-02/02

Jumpy...

Eléments DIRECTION

Steering parts
 Elementos Direcciones
 Elementy uklad kierowniczy
 Элементы рулевой системы

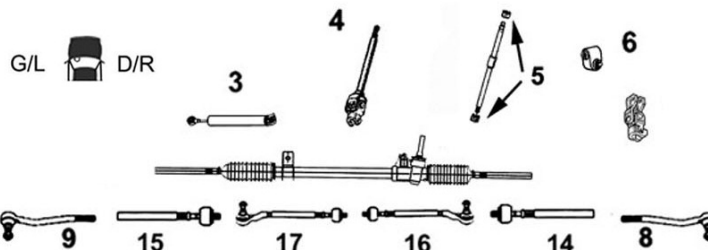

3008069
 OE 3812A4

Axe de bielle G/D
 L/R axial joint



14 Côté dir. M14x1.5 Côté rot. M14x1.5 long 306 mm
15











1.6i
 1.9 D
 1.9 TD
 2.0i 16v.
 2.0 HDi

-12/06
 -12/06
 -12/06
 -12/06
 -12/06

...Jumpy...

CITROEN

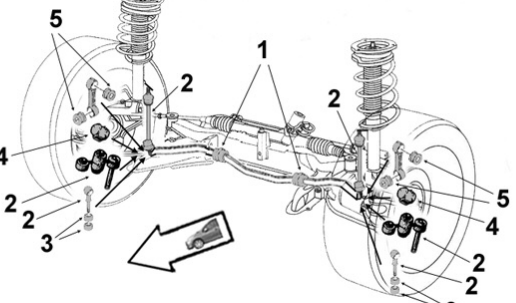
SASIC

7770003 Part/oe 3812F0	Axe de bielle G/D <i>L/R axial joint</i>	0594094 OE 405909	Rotule de direction G/D <i>L/R tie rod end</i>
	14 Côté dir. M16x1.5 Côté rot. M14x1.5 15 long 304 mm 1.6 HDi DV6DU DV6UC 01/07- 1.6 HDi DV6UTED4 01/07- 2.0i 16v. EW10A 01/07- 2.0 HDi FAP DW10CD/E DTR 01/07- 2.0 HDi DW10UTED4 01/07- 2.0 HDi FAP DW10B/CTED4 01/07-		8 M14 x 1.5 9 1.6i -08/03 1.9 D -08/03 1.9 TD -08/03 2.0i 16v. -08/03 2.0 HDi -08/03
0594124 OE 405912	Rotule de direction G/D <i>L/R tie rod end</i>	7670011 OE 381773	Rotule de direction G/D <i>L/R tie rod end</i>
	8 M14 x 1.5 9 1.6i 09/03-12/03 1.9 D 09/03-12/03 1.9 TD 09/03-12/03 2.0i 16v. 09/03-12/03 2.0 HDi 09/03-12/03		8 M14 x 1.5 1.6 HDi DV6DU MDV6UC 01/07- DV6UTED4 01/07- 2.0i 16v. EW10A 01/07- 2.0 HDi FAP DW10CD DTR 01/07- DW10CE DTR 01/07- DW10UTED4 01/07- DW10B/CTED4 01/07-
1234A74 OE 4123A7	Axe de volant <i>Steering wheel shaft</i>	1034F64 OE 4103F6	Axe de volant <i>Steering wheel shaft</i>
	4 DNA 1.6i -12/06 1.9 D Conduite à G -12/06 1.9 TD Conduite à G -12/06 2.0i 16v. Conduite à G -12/06 2.0 HDi Conduite à G -12/06		4 Conduite à G DA 1.6i -12/06 1.9 D -12/06 1.9 TD -12/06 2.0i 16v. -12/06 2.0 HDi -12/06
1034F74 OE 4103F7	Axe de volant <i>Steering wheel shaft</i>		
	4 Conduite à D DA 1.9 D -12/06 1.9 TD -12/06 2.0i 16v. -12/06 2.0 HDi -12/06		
 <p>Barre stabilisatrice Stabilizer bar Barra estabilizadora Drażek stabilizatora стабилизатор поперечной устойчивости</p>			
0875355 OE 508735	Biellette barre stab. <i>Stabilizer bar stub axle</i>	2300028 OE 508756	Biellette barre stab. <i>Stabilizer bar stub axle</i>
	2 1.6i -12/06 1.9 D -12/06 1.9 TD -12/06 2.0i 16v. -12/06 2.0 HDi -12/06		2 BVM 1.6 HDi DV6UTED4 01/07- 2.0i 16v. EW10ABE4 01/07- 2.0 HDi DW10UTED4 01/07- 2.0 HDi FAP DW10BTE4 01/07-

...Jumpy...



Barre stabilisatrice
 Stabilizer bar
 Barra estabilizadora
 Drażek stabilizatora
 стабилизатор поперечной устойчивости

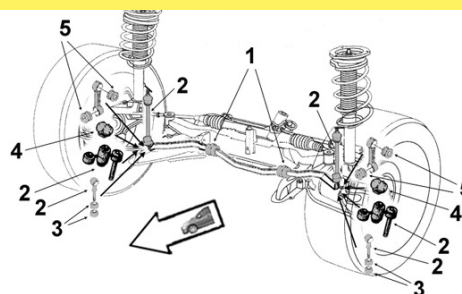

CITROEN

SASIC

0935155
OE 509315

Liaison élastique
Elastic link



3 Ø int.12.5 Ø ext.37.5
long. tube int.20 ext.22

1.6i	-12/06
1.9 D	-12/06
1.9 TD	-12/06
2.0i 16v.	-12/06
2.0 HDi	-12/06

0945695
OE 509469

Palier de barre milieu
Middle bar main bearing



1 Barre Ø 24

1.6i	-12/06
1.9 D	-12/06
1.9 TD	-12/06
2.0i 16v.	-12/06
2.0 HDi	-12/06

2300045

Palier de barre milieu

Part/oe 1440177280 *Middle bar main bearing*



1 Barre Ø 25 2ème montage 01/07-

1.6 HDi	DV6UTED4 DV6DU M DV6UC	12/11-
2.0i 16v.	EW10A	12/11-
2.0 HDi FAP	DW10BTED4 DW10CTED4 DW10UTED4	12/11-
	DW10CD DTR DW10CE DTR	

Bras & Triangle de suspension

Control arm
Brazo y triángulo
Wahacz
Рычаг подвески

G/L D/R

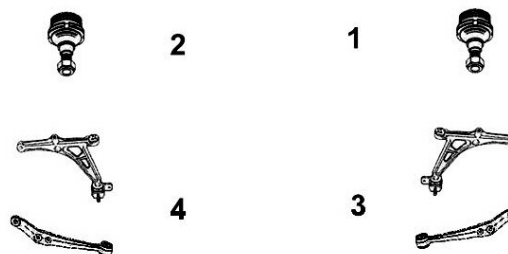

5203943
OE 3520P4

Triangle de susp. G
Left track control arm



4 Avec rotule *With ball joint*

1.6i	-01/05/00
1.9 D XUD9	-01/07/98
1.9 D DW8/B	13/11/95-28/03/06
1.9 TD	-12/10/03
2.0i 16v.	13/11/95-28/03/06
2.0 HDi	13/11/95-28/03/06

5213643
OE 3521K4











Triangle de susp. D
Right track control arm

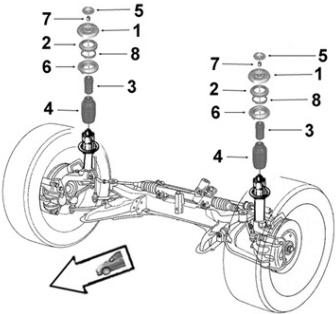

3 Avec rotule *With ball joint*

1.6i	-01/05/00
1.9 D XUD9	-01/07/98
1.9 D DW8/B	13/11/95-28/03/06
1.9 TD	-12/10/03
2.0i 16v.	13/11/95-28/03/06
2.0 HDi	13/11/95-28/03/06

...Jumpy...

7470021 OE 3520S6  NEW	Triangle de susp. G <i>Left track control arm</i> 4 Avec rotule With ball joint Animation gamme U65 2.0 HDi DW10BTED + 04/07/06-12/06 DW10BTED W4	7470022 OE 3521P7  NEW	Triangle de susp. D <i>Right track control arm</i> 3 Avec rotule With ball joint Animation gamme U65 2.0 HDi DW10BTED + 04/07/06-12/06 DW10BTED W4
7470001 OE 3520R8 	Triangle de susp. G <i>Left track control arm</i> 4 Avec rotule With ball joint 1.6 HDi DV6DU M 01/07- DV6UC DV6UTED4 2.0i 16v. EW10A 01/07- 2.0 HDi FAP DW10BTED4 01/07- DW10CD/E DTR DW10CTED4 DW10UTED4	7470002 OE 3521N9 	Triangle de susp. D <i>Right track control arm</i> 3 Avec rotule With ball joint 1.6 HDi DV6DU M 01/07- DV6UC DV6UTED4 2.0i 16v. EW10A 01/07- 2.0 HDi FAP DW10BTED4 01/07- DW10CD/E DTR DW10CTED4 DW10UTED4
 Support d'amortisseur <i>Suspension mounting</i> Soporte amortiguador Poduszka amortyzatora Опора амортизатора			
0385175 OE 503870 	Support suspension G <i>Left suspension mounting</i> 1 TT /all models DNA -12/06	0385165 OE 503868 	Support suspension D <i>Right suspension mounting</i> 1 TT /all models DNA -12/06
0385165 OE 503868 	Support suspension G <i>Left suspension mounting</i> 1 TT /all models DA -12/06	0385175 OE 503870 	Support suspension D <i>Right suspension mounting</i> 1 TT /all models DA -12/06
0355385 OE 503555 	Butée à billes G/D <i>L/R ball bearing</i> 2 TT /all models -12/06 1.6 HDi DV6UTED4 01/07- 2.0i 16v. EW10A 01/07- 2.0 HDi DW10UTED4 01/07- DW10BTED4 DW10CTED4	0315395 OE 503139 	Coupelle amortisseur G/D <i>L/R shock absorber cup</i> 6 TT /all models -07/09/00

...Jumpy...







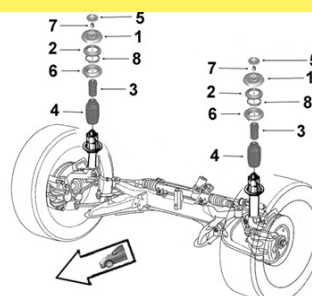

SASIC

CITROEN



Support d'amortisseur
Suspension mounting
Soporte amortiguador
Poduszka amortyzatora
Опора амортизатора



0315505 OE 503150 	Coupelle amortisseur G/D <i>L/R shock absorber cup</i> 6 TT /all models 08/09/00-12/06 1.6 HDi DV6UTED4 01/07- 2.0i 16v. EW10A 01/07- 2.0 HDi DW10UTED4 01/07- DW10BTED4 DW10CTED4	0335395 OE 503339 	Butée de suspension G/D <i>L/R suspension bush</i> 3 H105 TT /all models -12/06
2650012 OE 5033A5 	Butée de suspension G/D <i>L/R suspension bush</i> 3 H111 1.6 HDi Susp. normale DV6UTED4 BVM BE4R 01/07- 1.6 HDi Susp. renforcée AV AR ou Plancher cabine DV6UTED4 01/07- 2.0i 16v. Susp. normale ou Susp. renforcée AV AR EW10A BVM BE4R 01/07- 2.0i 16v. Plancher cabine EW10A 01/07- 2.0 HDi Susp. renforcée AV AR ou Plancher cabine DW10UTED4 01/07- 2.0 HDi Susp. normale DW10B/UTED4 BVM ML6C 01/07- 2.0 HDi Combi susp. normale DW10BTED4 BVM ML6C 01/07- 2.0 HDi FAP Susp. renforcée AV AR ou Plancher cabine DW10BTED4 01/07-		
2545195 OE 525446 	Protecteur amortisseur G/D <i>L/R shock absorber protector</i> 4 TT /all models -12/06 1.6 HDi DV6UTED4 01/07- 2.0i 16v. EW10A 01/07- 2.0 HDi DW10UTED4 DW10BTED4 DW10CTED4 01/07-		
1005264 OE - 	Kit rép. suspension G <i>Left susp. mounting repair kit</i> DNA -12/06 1.6i 1.9 D 1.9 TD 2.0i 16v. 2.0 HDi	1005263 OE - 	Kit rép. suspension D <i>Right susp. mounting repair kit</i> DNA -12/06 1.6i 1.9 D 1.9 TD 2.0i 16v. 2.0 HDi
1005263 OE - 	Kit rép. suspension G <i>Left susp. mounting repair kit</i> DA -12/06 1.6i 1.9 D 1.9 TD 2.0i 16v. 2.0 HDi	1005264 OE - 	Kit rép. suspension D <i>Right susp. mounting repair kit</i> DA -12/06 1.6i 1.9 D 1.9 TD 2.0i 16v. 2.0 HDi

...Jumpy



Support d'amortisseur
 Suspension mounting
 Soporte amortiguador
 Poduszka amortyzatora
 Опора амортизатора

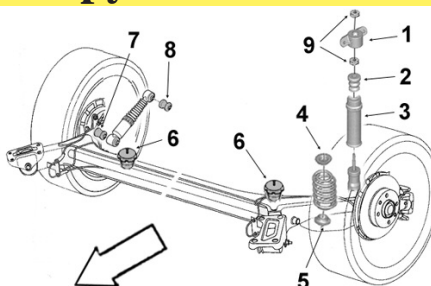

CITROEN



1665475
 OE 516647

Butée de talonnage
 Bushing



6 Ø 55 H102 Sans barre anti devers AV

1.6i		-17/02/98
1.9 D	DW8 XUD9	-17/02/98
1.9 TD		-17/02/98
2.0i 16v.		-17/02/98

1665565
 OE 516656

Butée de talonnage
 Bushing



6 Ø 55 H113

Barre anti devers AV -12/06
 Sans barre anti devers AV 18/02/98-12/06

1.6i		
1.9 D	DW8/B XUD9	
1.9 TD		
2.0i 16v.		
2.0 HDi sans FAP	DW10ATED	-12/06
2.0 HDi	DW10BTEDW3/4	-12/06

Eléments TRAIN ARRIERE

Rear axle parts
 Tren TRAS
 Elementy zawieszenia tylnego
 элементы задней оси.



1525615
 OE 515261

Articulation essieu AR AV
 Front Rear axle bush



Ø int.12 Ø ext.46 long. tube int.60 ext.48

1.6i	1580 SPI	-12/06
1.9 D	XUD9 DW8/B	-12/06
1.9 TD	XUD9TE	-12/06
2.0i 16v.	EW10J4	-12/06
2.0 HDi Sans FAP	DW10A/TED/4 /BTED	-12/06

Nemo VU...

Eléments DIRECTION

Steering parts
 Elementos Direcciones
 Elementy uklad kierowniczy
 Элементы рулевой системы

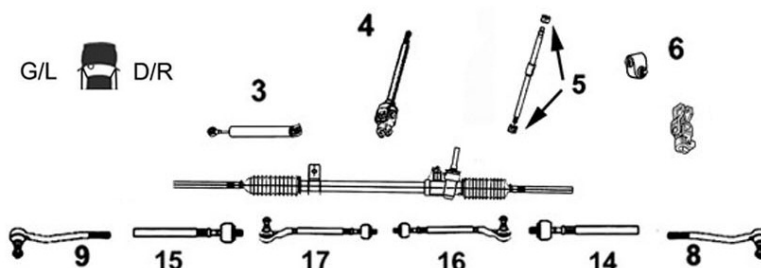

7770013

Axe de bielle G/D

Part/oe 400177

L/R axial joint

NEW



14 Côté dir. M14x1.5 Côté rot. M14x1.5 long 276 mm

1.3 HDi FAP	F13DTE5	BVM
1.4i	TU3A/E5	
1.4 HDi	DV4TED	

...Nemo VU...

Eléments DIRECTION

Steering parts

Elementos Direcciones

Elementy układ kierowniczy

Элементы рулевой системы

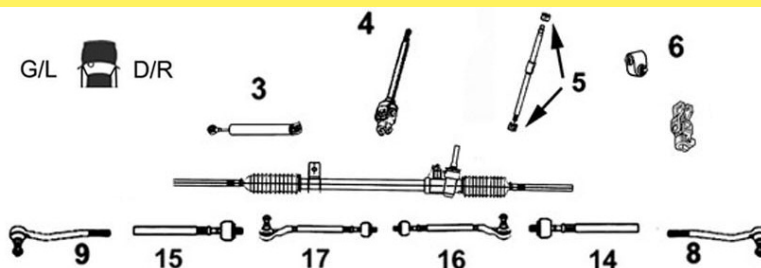

CITROËN

SASIC

7670008

OE 381786

Rotule de direction G

Left tie rod end

9 M14 x 1.5

1.3 HDi FAP	F13DTE5	BVM
1.4i	TU3A/E5	
1.4 HDi	DV4TED	



7670009

OE 381787

Rotule de direction D

Right tie rod end

8 M14 x 1.5

1.3 HDi FAP	F13DTE5	BVM
1.4i	TU3A/E5	
1.4 HDi	DV4TED	



Barre stabilisatrice

Stabilizer bar

Barra estabilizadora

Drażek stabilizatora

стабилизатор поперечной устойчивости

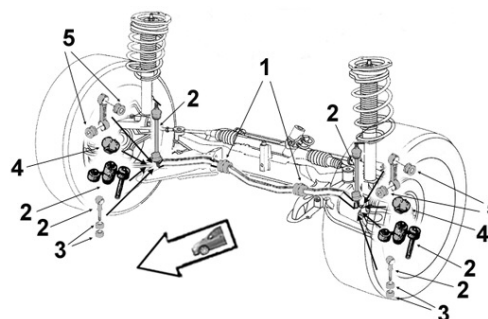

2300029

OE 508779

Biellette barre stab.

Stabilizer bar stub axle

2

1.3 HDi FAP	F13DTE5	BVM
1.4i	TU3A/E5	
1.4 HDi	DV4TED	



2300043

OE 5094C8

Palier de barre milieu

Middle bar main bearing

1 Barre Ø 20

1.4i	TU3A	-31/01/08
1.4 HDi	DV4TED	-31/01/08



2300041

OE 5094E5

Palier de barre milieu

Middle bar main bearing

1 Barre Ø 21

1.3 HDi FAP	F13DTE5	01/02/08-
1.4i	TU3A	01/02/08-
1.4 HDi	DV4TED	01/02/08-



...Nemo VU...





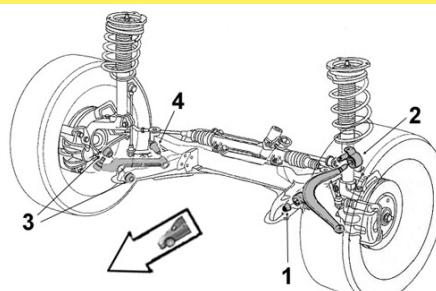





Eléments SUSPENSION
Suspension parts
Elementos suspensión
Elementy zawieszenia
Элементы подвески





CITROEN



2256032	Articulation AV	2256009	Articulation AR
Part/oe 3520Y4	<i>Front bush</i>	Part/oe 3520Y4	<i>Rear bush</i>
	1 Ø int. 12.5 Ø ext. 42 coll. 43 coll. 50.5 long.tube int. 67.5 ext. 41		2 Ø int. 12.5 Ø ext. 73 long. tube int. 66 ext. 27.5
	1.4i TU3A 1.4 HDi DV4TED		1.4i TU3A 1.4 HDi DV4TED

Bras & Triangle de suspension	G/L		D/R				
<i>Control arm</i> <i>Brazo y triángulo</i> <i>Wahacz</i> <i>Рычаг подвески</i>					2		1
					4		3
							

7470005	Triangle de susp. G	7470006	Triangle de susp. D
OE 3520Y4	<i>Left track control arm</i>	OE 3521V5	<i>Right track control arm</i>
	4 Avec rotule With ball joint		3 Avec rotule With ball joint
	1.3 HDi FAP F13DTE5 1.4i TU3A/E5 1.4 HDi DV4TED		1.3 HDi FAP F13DTE5 1.4i TU3A/E5 1.4 HDi DV4TED

7570004	Rotule de susp. inf. G/D
Part/oe 3520Y4	<i>L/R lower suspension ball joint</i>
	1
	1.3 HDi FAP F13DTE5 1.4i TU3A/E5 1.4 HDi DV4TED

...Nemo VU



CITROEN



Support d'amortisseur
Suspension mounting
Soporte amortiguador
Poduszka amortyzatora
Опора амортизатора

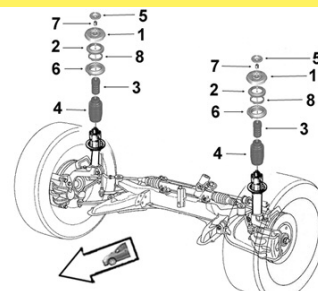

2650031

OE 1609274780

Support suspension G

Left suspension mounting

1



1.3 HDi FAP
 1.4i
 1.4 HDi

F13DTE5
 TU3A/E5
 DV4TED

2650032

OE 1609274680

Support suspension D

Right suspension mounting

1



1.3 HDi FAP
 1.4i
 1.4 HDi

F13DTE5
 TU3A/E5
 DV4TED

2650025

OE 5033F2

Butée de suspension G/D

L/R suspension bush

3



1.3 HDi FAP
 1.4i
 1.4 HDi

F13DTE5
 TU3A/E5
 DV4TED

Eléments TRAIN ARRIERE

Rear axle parts

Tren TRAS

Elementy zawieszenia tylnego

элементы задней оси.



2600012

OE 5131G8

Articulation essieu

Axle bush

Ø int. 13 Ø ext. 69 coll. 80 long. tube int.94 ext. 100 ep. coll. 2.5



1.3 HDi FAP
 1.4i
 1.4 HDi

F13DTE5
 TU3A TU3AE5
 DV4TED

Dokker ...

Eléments DIRECTION

Steering parts

Elementos Direcciones

Elementy układ kierowniczy

Элементы рулевой системы

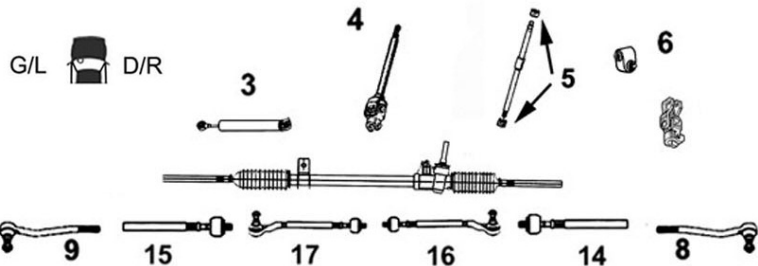

7774018

Axe de bielle G/D

Part/oe 485213172R L/R axial joint

NEW



14 Côté dir. M14x1.5 Côté rot. M14x1.5 long 193 mm
15 DA Conduite à gauche

1.2i Turbo	F/KEM0	03/12-
1.5 DCi	FEAL FEM4/6/7/W KEALKEM4/W	03/12-
1.6i	F/KEJB/M3	03/12-

7674018

Rotule de direction G

OE 485202867R Left tie rod end

NEW



9 DA Conduite à gauche

1.2i Turbo	F/KEM0	03/12-
1.5 DCi	FEAL FEM4/6/7/W	03/12-
1.5 DCi	KEALKEM4/W	03/12-
1.6i	F/KEJB/M3	03/12-

7674019

Rotule de direction D

OE 485200410R Right tie rod end

NEW



8

1.2i Turbo	F/KEM0	03/12-
1.5 DCi	FEAL FEM4/6/7/W	03/12-
1.5 DCi	KEALKEM4/W	03/12-
1.6i	F/KEJB/M3	03/12-



Barre stabilisatrice

Stabilizer bar

Barra estabilizadora

Drażek stabilizatora

стабилизатор поперечной устойчивости

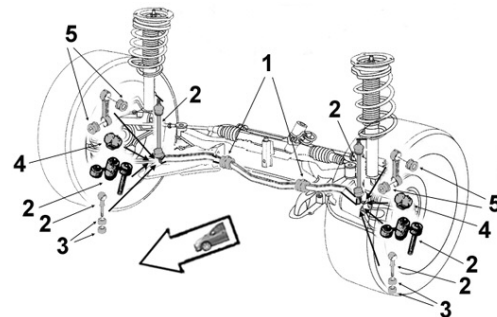

4005152

Palier de barre bout

OE 8200277960 End bar main bearing



2

1.2i Turbo	F/KEM0	H5F402
1.5 DCi /FAP	F/KEAL/M4/MW	K9K612/830
1.6i 8v.	/KEJB/M3	K7M812

... Dokker

SASIC

DACIA



Support d'amortisseur
Suspension mounting
Soporte amortiguador
Poduszka amortyzatora
Опора амортизатора

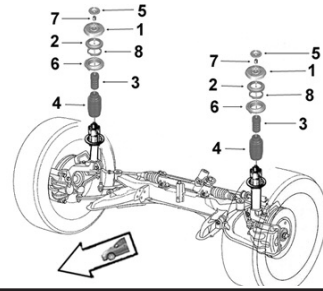

4005537

Support suspension

OE 6001547499

Suspension mounting



1

1.2i Turbo	03/12-
1.5 DCi	03/12-
1.6i	03/12-

4005300

Butée à billes G/D

OE 8200651172

L/R ball bearing



2

1.2i Turbo	03/12-
1.5 DCi	03/12-
1.6i	03/12-

Duster ...

Eléments DIRECTION

Steering parts
Elementos Direcciones
Elementy uklad kierowniczy
Элементы рулевой системы

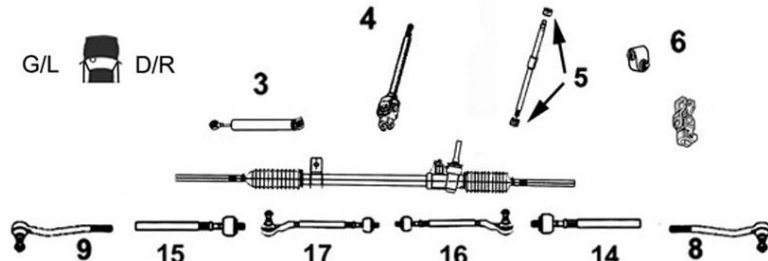

7774016

Axe de bielle G/D

Part/oe 8201108350

L/R axial joint

NEW



14 Côté dir. M16x1.5 Côté rot. M14x1.5 long 205 mm
15

1.2 TCE	HSM2	
1.5 DCi	HSAD/E/F/L/6/7	HSM0/3/5/C/D/G/V/W
1.6i 16v.	HSA5/8/9/M/N/P/S/T	HSMA/M/R
2.0i 16v.	HSAR HSMJ/K/L/S	

7674017

Rotule de direction G

OE 8201108339

Left tie rod end

NEW



9 M14 x 1.5

1.2 TCE	HSM2
1.5 DCi	HSAD/E/F/L/6/7 HSM0/3/5/C/D/G/V/W
1.6i 16v.	HSA5/8/9/M/N/P/S/T HSMA/M/R
2.0i 16v.	HSAR HSMJ/K/L/S

7674016

Rotule de direction D

OE 8201108332

Right tie rod end

NEW



8 M14 x 1.5

1.2 TCE	HSM2
1.5 DCi	HSAD/E/F/L/6/7 HSM0/3/5/C/D/G/V/W
1.6i 16v.	HSA5/8/9/M/N/P/S/T HSMA/M/R
2.0i 16v.	HSAR HSMJ/K/L/S

... Duster ...



Barre stabilisatrice
 Stabilizer bar
 Barra estabilizadora
 Drążek stabilizatora
 стабилизатор поперечной устойчивости

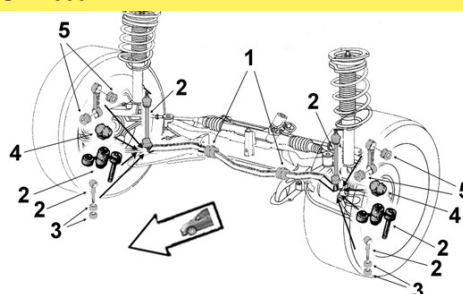

DACIA



2304033

OE 8200814411

Biellette barre stab.

Stabilizer bar stub axle

NEW



2

1.5 DCi HSMC/MW/A6/A7/
 MG/MV/M0/M3/MW
 1.6i 16v. HSA8/MM/MR/AS/AM/
 AP/AT/MA/A5/A9
 2.0i 16v. HSAR/MJ/MK/ML/MS

2304026

OE 546114237R

Palier de barre milieu

Middle bar main bearing



1

1.5 DCi /4WD HSA6/7 HSM0/3/C/
 G/V/X K9K 03/10-
 1.6i /4WD HSA8/M/P/S/T
 HSMR K4M 03/10-
 2.0i 16v. HSAR HSMJ/K/L/R/S
 F4R 03/10-



Eléments SUSPENSION

Suspension parts
 Elementos suspensión
 Elementy zawieszenie
 Элементы подвески

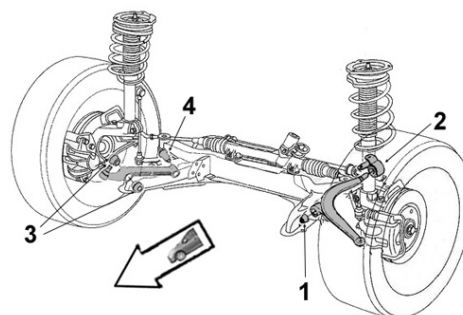

2254015

Part/oe 545011697R

Articulation AV/AR

Front rear bush

NEW



1
2

Ø int. 14 Ø ext. 37 coll. 50.5 long. tube int.45 ext.30 ep. coll.4

1.5 DCi HSMC/MW/A6/A7/MG/MV/M0/M3/MW
 1.6i 16v. HSA8/MM/MR/ S/AM/AP/AT/MA/A5/A9
 2.0i 16v. HSAR/MJ/MK/ML/MS

Bras & Triangle de suspension

Control arm
 Brazo y triángulo
 Wahacz
 Рычаг подвески

G/L D/R

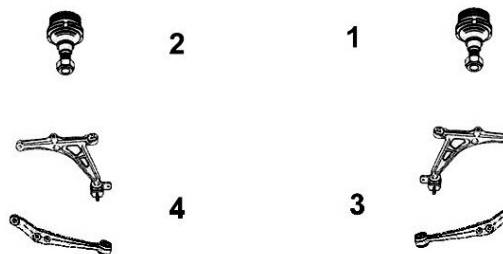

7474013

OE 545011697R

Triangle de susp. inf. G

Lower left track control arm

NEW



4 Avec rotule With ball joint

1.2 TCE HSM2
 1.5 DCi HSAD/E/F/L/6/7
 HSM0/3/5/C/D/G/V/W
 1.6i 16v. HSA5/8/9/M/N/P/S/T
 HSMA/M/R
 2.0i 16v. HSAR HSMJ/K/L/S

7474012

OE 545000138R

Triangle de susp. inf. D

Lower right track control arm

NEW



3 Avec rotule With ball joint

1.2 TCE HSM2
 1.5 DCi HSAD/E/F/L/6/7
 HSM0/3/5/C/D/G/V/W
 1.6i 16v. HSA5/8/9/M/N/P/S/T
 HSMA/M/R
 2.0i 16v. HSAR HSMJ/K/L/S

... Duster ...

SASIC

DACIA

Bras & Triangle de suspension

Control arm
Brazo y triángulo
Wahacz
Рычаг подвески

G/L  D/R



7574011 Rotule de susp. inf. G/D

Part/oe 545011697R L/R lower suspension ball joint

NEW



1
2

1.2 TCE
1.5 DCi
1.6i 16v.
2.0i 16v.

HSM2
HSAD/E/F/L/6/7 HSM0/3/5/C/D/G/V/W
HSA5/8/9/M/N/P/S/T HSMA/M/R
HSAR HSMJ/K/L/S



Support d'amortisseur

Suspension mounting
Soporte amortiguador
Poduszka amortyzatora
Опора амортизатора

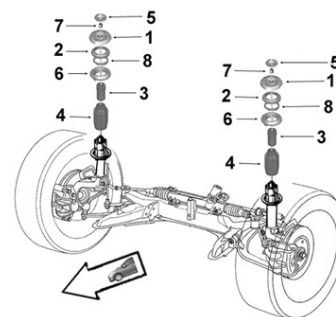

2654001 Coupelle rebond. G/D

OE 6001548403 L/R spring cup



5

1.5 DCi HSMC/MW
1.6i 16v. HSA8/MM/MR

4005537 Support suspension

OE 6001547499 Suspension mounting



1

1.5 DCi HSMC/MW
1.6i 16v. HSA8/MM/MR/AS

4005300 Butée à billes G/D

OE 8200651172 L/R ball bearing



2

1.5 DCi HSMC/MW/A6/A7/ MG/MV
1.6i 16v. HSA8/MM/MR/AS

2654002 Butée protecteur susp. G/D

OE 6001549290 L/R suspension bush



3
4

1.5 DCi HSMC/MW
1.6i 16v. HSA8/MM/MR/AS

... Duster



Barre stabilisatrice
 Stabilizer bar
 Barra estabilizadora
 Drążek stabilizatora
 стабилизатор поперечной устойчивости

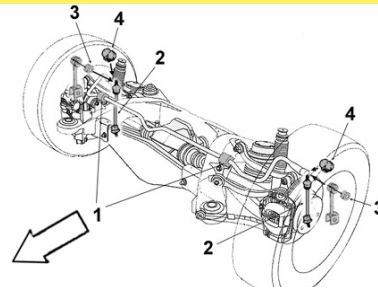

2304033

Biellette barre stab.

OE 8200814411

Stabilizer bar stub axle

NEW



2

1.5 DCi	4WD	HSMC/MW/A6/A7/MG/MV/M0/M3/MW
1.6i 16v.	4WD	HSA8/MM/MR/AS/AM/AP/AT/MA/A5/A9
2.0i 16v.	4WD	HSAR/MJ/MK/ML/MS



Support d'amortisseur
 Suspension mounting
 Soporte amortiguador
 Poduszka amortyzatora
 Опора амортизатора

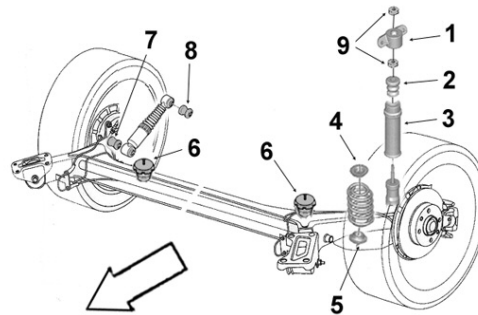

2654020

Butée protecteur susp.

OE 8200814709

Suspension bush



2
3

1.5 DCi 4WD	HSA6/7 HSM0/3/ C/G/V/X 03/10-
1.6i 16v. 4WD	HSA8/M/P/S/T HSMM/R 03/10-
2.0i 16v. 4WD	HSAR HSMJ/K/L/R/S 03/10-

2654028

Appui sup. ressort AR

OE 6001547495

Rear upper Spring support



4

Ø int. 43 Ø ext. 110 ep. 34

1.5 DCi /4WD
 1.6i 16v. /4WD
 2.0i /4WD

Éléments TRAIN ARRIERE

Rear axle parts

Tren TRAS

Elementy zawieszenia tylnego

элементы задней оси.



2604001

Articulation AR

OE 6001549989

Rear bush



Ø int.12 Ø ext.68 coll.78 long. tube int.90 ext.55 ep. coll.11.5

1.5 DCi 2WD	HSMC/MW/A6/A7/MG/MV
1.6i 16v. 2WD	HSA8/MM/MR/AS

Logan I ...

Eléments DIRECTION

Steering parts

Elementos Direcciones

Elementy układ kierowniczy

Элементы рулевой системы

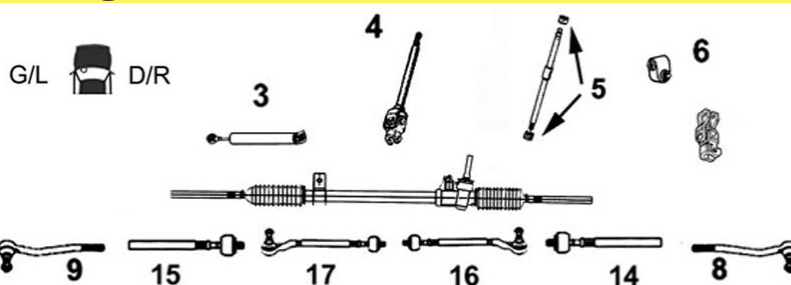

3008250

Axe de bielle G/D

OE 6001550441

L/R axial joint



14 Côté dir. M12x1.0 Côté rot. M14x1.5 long 194 mm Conduite à G

15

1.0i 16v.	LS0R LS1G/R
1.2i 16v.	LS01/2 LS1N
1.4 MPi	LS0A/C/E/G LS12/F FS0A/C/E KS0A/C/E/G KS12
1.5 DCi	LS00/4/J/K/W/Y LS1L FS00/4/J/K/W/Y FS1L
	KS00/4/J/K/W/Y KS1L US00/4/J/K/W/Y US1L
1.6i 16v.	US1Y LS09/L/M/P/V LS1S/V/Y KS0L/M/P KS1J/S
1.6 MPi	KS03/B/D/F/H KS11/E US03/B/D/F/H US11/E

4006158

Rotule de direction G

OE 6001550442

Left tie rod end



9 M14 x 1.5 Conduite à G

1.0i 16v.	LS0R LS1G/R
1.2i 16v.	LS01/2 LS1N
1.4 MPi	LS0A/C/E/G LS12/F FS0A/C/E KS0A/C/E/G KS12
1.5 DCi	LS00/4/J/K/W/Y LS1L FS00/4/J/K/W/Y FS1L KS00/4/J/K/W/Y KS1L
	US00/4/J/K/W/Y US1L
1.6i 16v.	US1Y LS09/L/M/P/V LS1S/V/Y KS0L/M/P KS1J/S
1.6 MPi	LS03/B/D/F/H/T LS11/6/A/E/H/U FS03/B/D/F FS11/E KS03/B/D/F/H
	KS11/E US03/B/D/F/H US11/E

4006157

Rotule de direction D

OE 6001550443

Right tie rod end



8 M14 x 1.5 Conduite à G

1.0i 16v.	LS0R LS1G/R
1.2i 16v.	LS01/2 LS1N
1.4 MPi	LS0A/C/E/G LS12/F FS0A/C/E KS0A/C/E/G KS12
1.5 DCi	LS00/4/J/K/W/Y LS1L FS00/4/J/K/W/Y FS1L KS00/4/J/K/W/Y KS1L
	US00/4/J/K/W/Y US1L
1.6i 16v.	US1Y LS09/L/M/P/V LS1S/V/Y KS0L/M/P KS1J/S
1.6 MPi	LS03/B/D/F/H/T LS11/6/A/E/H/U FS03/B/D/F FS11/E
	KS03/B/D/F/H KS11/E US03/B/D/F/H US11/E



Barre stabilisatrice

Stabilizer bar

Barra estabilizadora

Drażek stabilizatora

стабилизатор поперечной устойчивости

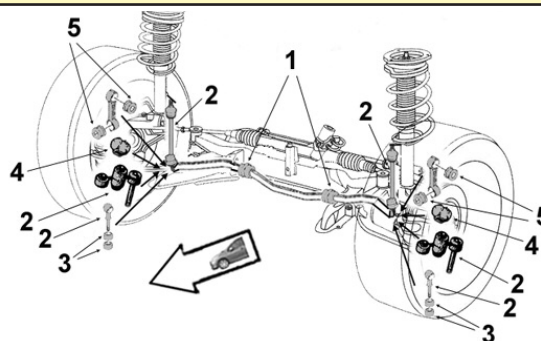

4005152

Palier de barre bout

OE 8200277960

End bar main bearing



2

1.4 MPi	LS 0A/0C/0E/0G	KS 0A/0C/0E/0G	FS 0A/0E
1.5 DCi	LS 00/0J/0K/0Y/0W	KS 0J/0K/00/0W/0Y	FS 0J/0K/0W/00 US 00/0J/0K/0W
1.6i 16v.	LS 0L/0M/0P/0V/09	KS 0M/0P/0L	
1.6 MPi	LS 0B/0D/0F/0H/0T/1A	KS 0B/0D/0F/0H	FS 0B/0F
1.6 MPi Pick-up	US 0B/0D/0F/0H		

... Logan I ...

DACIA



4005153 Palier de barre milieu

OE 6001547140 *Middle bar main bearing*



1	1.2i Sauf GPL	LS 01/02/1N		07/08-
	1.4 MPi	LS 0A/0C/0E/0G	KS 0A/0C/0E/0G	
	1.5 DCi	LS 00/0J/0K/0Y/0W	KS 0J/0K/00/0W/0Y	
	1.6i 16v.	LS 0M/0P/18/1S/1V/1Y		
	1.6i 16v. MCV	KS 0L/0M/0P/1J/1S		
	1.6i MPi	LS 0B/0D/0F/0H/0T/1A	KS 0B/0D/0F/0H	
	1.6 MPi	LS 0L/0M/0P/0V/09		-17/07/08
	1.6 MPi Sauf GPL	LS 0L/0M/0P/0V/09		17/07/08-
	1.6i MPi MCV	KS 0M/0P/0L		



Eléments SUSPENSION

Suspension parts

Elementos suspensión

Elementy zawieszenie

Элементы подвески

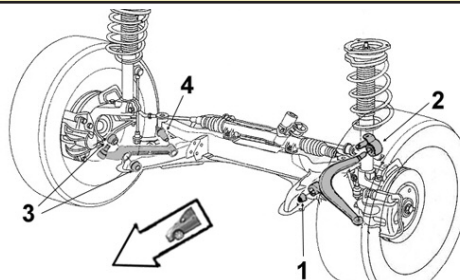

4001528 Articulation AV/AR Front rear bush

Part/oe 6001550911 8200820930



1	Ø int.12 Ø ext.37 coll.50 long. tube int.46 ext.30 ep. coll.2				
	1.4 MPi	KS 0A/0C/0E/0G	FS 0A/0E	LS 0A/0C/0E/0G	
	1.5 DCi	KS 0J/0K/00/0W/0Y	FS 0J/0K/0W/00	LS 00/0J/0K/0Y/0W	US 00/0J/0K/0W
	1.6i 16v.	KS 0M/0P/0L		LS 0L/0M/0P/0V/09	
	1.6 MPi	KS 0B/0D/0F/0H	FS 0B/0F	LS 0B/0D/0F/0H/0T/1A	US 0B/0D/0F/0H

Bras & Triangle de suspension

Control arm
Brazo y triángulo
Wahacz
Рычаг подвески

G/L D/R



4003212 Triangle de susp. G

Part/oe 545011362R *Left track control arm*



4	Sans rotule Without ball joint			
	1.0i 16v.	LS0R LS1G/R Ch J.....		-09/12
	1.2i 16v.	LS01/2 LS1N Ch A...../T.....		-09/12
	1.4 MPi	FS0A/C/E		-07/12
	1.4 MPi	LS0A/C/E/G LS12/F Ch A...../H...../T.....	KS0A/C/E/G KS12	-09/12
	1.5 DCi	FS00/4/J/K/W/Y FS1L		-07/12
	1.5 DCi	US00/4/J/K/W/Y US1L		-05/12
	1.5 DCi	LS00/4/J/K/W/Y LS1L Ch A...../J...../T.....	KS00/4/J/K/W/Y KS1L	-09/12
	1.6i 16v.	US1Y		-05/12
	1.6i 16v.	LS09/L/M/P/V LS1S/V/Y Ch A...../F...../H...../J...../T....	KS0L/M/P/1J/S	-09/12
	1.6 MPi	FS03/B/D/F FS11/E		-07/12
	1.6 MPi	US03/B/D/F/H US11/E		-05/12
	1.6 MPi	LS03/B/D/F/H/T LS11/6/A/E/H/U Ch A...../H...../J...../T.....		-09/12
	KS03/B/D/F/H KS11/E			

4003214 Triangle de susp. D

Part/oe 545004269R *Right track control arm*



3	Sans rotule Without ball joint			
	1.0i 16v.	LS0R LS1G/R Ch J.....		-09/12
	1.2i 16v.	LS01/2 LS1N Ch A...../T.....		-09/12
	1.4 MPi	FS0A/C/E		-07/12
	1.4 MPi	LS0A/C/E/G LS12/F Ch A...../H...../T.....	KS0A/C/E/G KS12	-09/12
	1.5 DCi	FS00/4/J/K/W/Y FS1L		-07/12
	1.5 DCi	US00/4/J/K/W/Y US1L		-05/12
	1.5 DCi	LS00/4/J/K/W/Y LS1L Ch A...../J...../T.....	KS00/4/J/K/W/Y KS1L	-09/12
	1.6i 16v.	US1Y		-05/12
	1.6i 16v.	LS09/L/M/P/V LS1S/V/Y Ch A...../F...../H...../J...../T....	KS0L/M/P/1J/S	-09/12
	1.6 MPi	FS03/B/D/F FS11/E		-07/12
	1.6 MPi	US03/B/D/F/H US11/E		-05/12
	1.6 MPi	LS03/B/D/F/H/T LS11/6/A/E/H/U Ch A...../H...../J...../T.....		-09/12
	KS03/B/D/F/H KS11/E			

... Logan I ...

SASIC

DACIA

Bras & Triangle de suspension

Control arm
Brazo y triángulo
Wahacz
Рычаг подвески

G/L  D/R



7474018

Triangle de susp. G

OE 545011362R

Left track control arm

NEW

4 Avec rotule With ball joint Ø 18



1.0i 16v.	LS0R LS1G/R Ch J.....		-09/12
1.2i 16v.	LS01/2 LS1N Ch A...../T.....		-09/12
1.4 MPi	FS0A/C/E		-07/12
1.4 MPi	LS0A/C/E/G LS12/F Ch A...../H...../T.....	KS0A/C/E/G KS12	-09/12
1.5 DCi	FS00/4/J/K/W/Y FS1L		-07/12
1.5 DCi	US00/4/J/K/W/Y US1L		-05/12
1.5 DCi	LS00/4/J/K/W/Y LS1L Ch A...../J...../T.....	KS00/4/J/K/W/Y KS1L	-09/12
1.6i 16v.	US1Y		-05/12
1.6i 16v.	LS09/L/M/P/V LS1S/V/Y Ch A. /F. /H. /J. /T.	KS0L/M/P KS1J/S	-09/12
1.6 MPi	FS03/B/D/F FS11/E		-07/12
1.6 MPi	US03/B/D/F/H US11/E		-05/12
1.6 MPi	LS03/B/D/F/H/T LS11/6/A/E/H/U Ch A. /H. /J. /T.	KS03/B/D/F/H KS11/E	-09/12

7474017

Triangle de susp. D

OE 545004269R

Right track control arm

NEW

3 Avec rotule With ball joint Ø 18



1.0i 16v.	LS0R LS1G/R Ch J.....		-09/12
1.2i 16v.	LS01/2 LS1N Ch A...../T.....		-09/12
1.4 MPi	FS0A/C/E		-07/12
1.4 MPi	LS0A/C/E/G LS12/F Ch A...../H...../T.....	KS0A/C/E/G KS12	-09/12
1.5 DCi	FS00/4/J/K/W/Y FS1L		-07/12
1.5 DCi	US00/4/J/K/W/Y US1L		-05/12
1.5 DCi	LS00/4/J/K/W/Y LS1L Ch A...../J...../T.....	KS00/4/J/K/W/Y KS1L	-09/12
1.6i 16v.	US1Y		-05/12
1.6i 16v.	LS09/L/M/P/V LS1S/V/Y Ch A. /F. /H. /J. /T.	KS0L/M/P KS1J/S	-09/12
1.6 MPi	FS03/B/D/F FS11/E		-07/12
1.6 MPi	US03/B/D/F/H US11/E		-05/12
1.6 MPi	LS03/B/D/F/H/T LS11/6/A/E/H/U Ch A. /H. /J. /T.	KS03/B/D/F/H KS11/E	-09/12

7574003

Rotule de susp. inf. G/D

OE 401604793R

L/R lower suspension ball joint



1 Ø 18

2

1.0i 16v.	LS0R LS1G/R	
1.2i 16v.	LS01/2 LS1N	
1.4 MPi	FS0A/C/E LS0A/C/E/G LS12/F	KS0A/C/E/G KS12
1.5 DCi	FS00/4/J/K/W/Y FS1L US00/4/J/K/W/Y US1L LS00/4/J/K/W/Y LS1L	KS00/4/J/K/W/Y KS1L
1.6i 16v.	LS09/L/M/P/V LS18/S/V/Y	KS0L/M/P KS1J
1.6 MPi	FS0B/D/F FS11/E US0B/D/F/H US1E LS03/B/D/F/H/T LS11/6/A/E/H/U	KS0B/D/F/H KS11/E

7964002S

Kit rép. train AV (en/in Skinpack)

OE -

Front axle repair kit



Sans visserie Without screws and bolts

1.4 MPi	LS0A/C/E/G KS0A/C/E/G	
1.5 DCi	LS00/J/K/W/Y KS00/J/K/W/Y	
1.6i 16v.	Sauf GPL LS09/L/M/P/V	17/07/08-
1.6i 16v.	KS0L/M/P	
1.6i 16v.	LS09/L/M/P/V	-17/07/08
1.6 MPi	LS0B/D/F/H/T LS1A KS0B/D/F/H	

... Logan I ...



Support d'amortisseur
 Suspension mounting
 Soporte amortiguador
 Poduszka amortyzatora
 Опора амортизатора

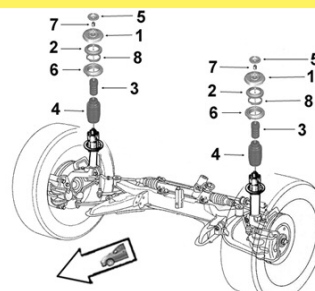

DACIA



2654001 **Coupelle rebond. G/D**
 OE 6001548403 *L/R spring cup*



5

1.4 MPi	LS0A/0C/0E/0G	KS0A/0C/0E/0G	FS0A/0E	K7J
1.5 DCi	LS00/0J/0K/0Y/0W US 00/0J/0K/0W	KS0J/0K/00/0W/0Y	FS0J/0K/0W/00	K9K
1.6i 16v.	LS0L/0M/0P/0V/09	KS0M/0P/0L		K4M
1.6 MPi	LS0B/0D/0F/0H/0T/1A US 0B/0D/0F/0H	KS0B/0D/0F/0H	FS0B/0F	K7M

4005537 **Support suspension**
 OE 6001547499 *Suspension mounting*



1

1.2i 16v.	LS 01/02/1N			D4F
1.4 MPi	LS0A/0C/0E/0G	KS0A/0C/0E/0G	FS0A/0E	K7J
1.5 DCi	LS00/0J/0K/0Y/0W US 00/0J/0K/0W	KS0J/0K/00/0W/0Y	FS0J/0K/0W/00	K9K
1.6i 16v.	LS0L/0M/0P/0V/09	KS0M/0P/0L/1J/1S		K4M
1.6 MPi	LS0B/0D/0F/0H/0T/1A US 0B/0D/0F/0H	KS0B/0D/0F/0H	FS0B/0F	K7M

4005300 **Butée à billes G/D**
 OE 8200651172 *L/R ball bearing*



2

1.0i 16v.	LS0R/1G/1R			
1.2i 16v.	LS1N			
1.4 MPi	FS0A/0E/0C	KS0A/0C/0E/0G/12		LS0A/0C/0E/0G/12/1F
1.5 DCi	FS0J/0K/0W/00/04/0Y/1L US00/0J/0K/0W/0Y/04/1L	KS0J/0K/00/0W/0Y/04/1L		LS00/0J/0K/0Y/0W/1L
1.6i 16v.	KS0M/0P/0L/1J		LS0L/0M/0P/0V/09/1S/1V/1Y	
1.6 MPi	FS0B/0F/0D/11/1E LS0B/0D/0F/0H/0T/1A/11/1E/1H/1U US0B/0D/0F/0H/1E	KS0B/0D/0F/0H/11/1E		

2654002 **Butée protecteur susp. G/D**
 OE 6001549290 *L/R suspension bush*



3

4

1.2i 16v.	LS 01/02/1N			D4F
1.4 MPi GPL	LS0A/0C/0E/0G			K7J
1.4 MPi	KS0A/0C/0E/0G	FS0A/0E		K7J
1.5 DCi	KS0J/0K/00/0W/0Y	FS0J/0K/0W/00		K9K
1.6i 16v. GPL	LS0L/0M/0P/0V/09			K4M
1.6i 16v.	KS0M/0P/0L			K4M
1.6 MPi GPL	LS0B/0D/0F/0H/0T/1A			K7M
1.6 MPi	KS0B/0D/0F/0H	FS0B/0F		K7M

4005536 **Butée protecteur susp. G/D**
 OE 6001548402 *L/R suspension bush*



3

4

1.4 MPi Sauf GPL	LS0A/0C/0E/0G			K7J
1.5 DCi	LS00/0J/0K/0Y/0W			K9K
1.6i 16v.	KS0L/0M/0P/1J/1S			K4M
1.6i 16v. Sauf GPL	LS0L/0M/0P/0V/09			K4M
1.6 MPi Sauf GPL	LS0B/0D/0F/0H/0T/1A			K7M

... Logan I



Support d'amortisseur
 Suspension mounting
 Soporte amortiguador
 Poduszka amortyzatora
 Опора амортизатора

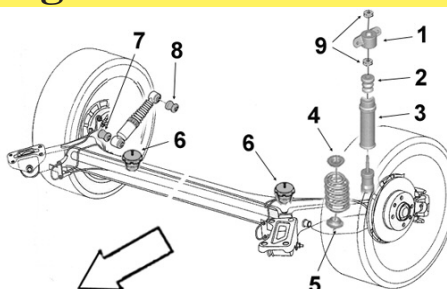

2654028

Appui sup. ressort AR

OE 6001547495

Rear upper Spring support



4 Ø int. 43 Ø ext. 110 ep. 34

1.0i
 1.2i
 1.4 MPi
 1.5 DCi
 1.6i 16v.
 1.6 MPi

Eléments TRAIN ARRIERE

Rear axle parts

Tren TRAS

Elementy zawieszenia tylnego

элементы задней оси.



2604001

Articulation AR

OE 6001549989

Rear bush



Ø int.12 Ø ext.68 coll.78 long. tube int.90 ext.55 ep. coll.11.5

1.2i 16v.	LS 01/02/1N			D4F
1.4 MPi	LS 0A/0C/0E/0G	KS 0A/0C/0E/0G	FS 0A/0E	K7J
1.5 DCi	LS 00/0J/0K/0Y/0W	KS 0J/0K/00/0W/0Y	FS 0J/0K/0W/00	K9K
	US 00/0J/0K/0W			
1.6i 16v.	LS 0L/0M/0P/0V/09	KS 0M/0P/0L		K4M
1.6i MPi	LS 0B/0D/0F/0H/0T/1A	KS 0B/0D/0F/0H	FS 0B/0F	K7M
	US 0B/0D/0F/0H			

Logan II ...

Eléments DIRECTION

Steering parts

Elementos Direcciones

Elementy uklad kierowniczy

Элементы рулевой системы

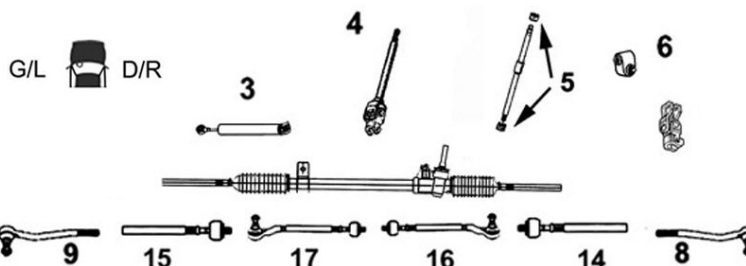

3008250

Axe de bielle G/D

Part/oe 6001550441

L/R axial joint



14 Côté dir. M12x1.0 Côté rot. M14x1.5 long 194 mm
15

1.2i	DNA Conduite à gauche	K/L8 MG/P
1.6i	DNA Conduite à gauche	L8A6/JB/ME/MV K8JB

... Logan II

DACIA

SASIC

7774018 Axe de bielle G/D

Part/oe 485213172R L/R axial joint

NEW



14 Côté dir. M14x1.5 Côté rot. M14x1.5 long 193 mm
15

0.9 Turbo	DA Conduite à gauche	Equipements ENPA01/B01/C01	L8MA	10/12-
0.9 Turbo	DA		K8MA	10/12-
1.0i 16v.	DA Conduite à gauche	Equipements ENPA01/B01/C01	L8A0	10/12-
1.2i	DA Conduite à gauche	Equipements ENPA01/B01/C01	L8MG/P	10/12-
1.2i	DA		K8MG/P	10/12-
1.5 DCi	DA Conduite à gauche	Equipements ENPA01/B01/C01	L8AL L8M4/6/7/W	10/12-
1.5 DCi	DA		K8AL K8M4/6/7/W	10/12-
1.6i	DA Conduite à gauche	Equipements ENPA01/B01/C01	L8A6/JB/ME/MV	10/12-
1.6i	DA		K8JB	10/12-
1.6i 16v.	DA Conduite à gauche	Equipements ENPA01/B01/C01	L8M9/T	10/12-

7674018 Rotule de direction G

OE 485202867R Left tie rod end

NEW



9	1.2i	DNA Conduite à gauche		K/L8 MG/P	
	1.6i	DNA Conduite à gauche		L8A6/JB/ME/MV K8JB	
	0.9 Turbo	DA Conduite à gauche	Equipements ENPA01/B01/C01	L8MA	10/12-
	0.9 Turbo	DA		K8MA	10/12-
	1.0i 16v.	DA Conduite à gauche	Equipements ENPA01/B01/C01	L8A0	10/12-
	1.2i	DA Conduite à gauche	Equipements ENPA01/B01/C01	L8MG/P	10/12-
	1.2i	DA		K8MG/P	10/12-
	1.5 DCi	DA Conduite à gauche	Equipements ENPA01/B01/C01	L8AL L8M4/6/7/W	10/12-
	1.5 DCi	DA		K8AL K8M4/6/7/W	10/12-
	1.6i	DA Conduite à gauche	Equipements ENPA01/B01/C01	L8A6/JB/ME/MV	10/12-
	1.6i	DA		K8JB	10/12-
	1.6i 16v.	DA Conduite à gauche	Equipements ENPA01/B01/C01	L8M9/T	10/12-

7674019 Rotule de direction D

OE 485200410R Right tie rod end

NEW



8	1.2i	DNA Conduite à gauche		K/L8 MG/P	
	1.6i	DNA Conduite à gauche		L8A6/JB/ME/MV K8JB	
	0.9 Turbo	DA Conduite à gauche	Equipements ENPA01/B01/C01	L8MA	10/12-
	0.9 Turbo	DA		K8MA	10/12-
	1.0i 16v.	DA Conduite à gauche	Equipements ENPA01/B01/C01	L8A0	10/12-
	1.2i	DA Conduite à gauche	Equipements ENPA01/B01/C01	L8MG/P	10/12-
	1.2i	DA		K8MG/P	10/12-
	1.5 DCi	DA Conduite à gauche	Equipements ENPA01/B01/C01	L8AL L8M4/6/7/W	10/12-
	1.5 DCi	DA		K8AL K8M4/6/7/W	10/12-
	1.6i	DA Conduite à gauche	Equipements ENPA01/B01/C01	L8A6/JB/ME/MV	10/12-
	1.6i	DA		K8JB	10/12-
	1.6i 16v.	DA Conduite à gauche	Equipements ENPA01/B01/C01	L8M9/T	10/12-



Barre stabilisatrice

Stabilizer bar

Barra estabilizadora

Drażek stabilizatora

стабилизатор поперечной устойчивости

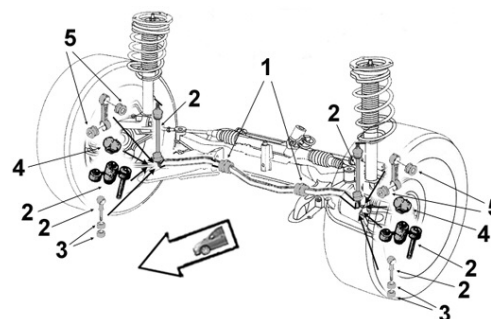

4005152 Palier de barre bout

OE 8200277960 End bar main bearing



2	Sans complément SUV			
	0.9 Turbo		L8MA	H4B400
	0.9 Turbo		K8MA	H4B400/05
	1.2i	Equipement E2 E3	L8MG/P	D4F732/34
	1.2i		K8MG/P	D4F732/34
	1.5 DCi/FAP		L8AL/M4/M6/MW	K9K612/830/838
	1.5 DCi/FAP		K8AL/M4/M6/M7/MW	K9K612/830/838
	1.6i 8v.	Equipement E2 E3	L8JB	K7M812
	1.6i 8v.	Sauf GPL	K8JB	K7M812

Lodgy ...

Eléments DIRECTION

Steering parts

Elementos Direcciones

Elementy układ kierowniczy

Элементы рулевой системы

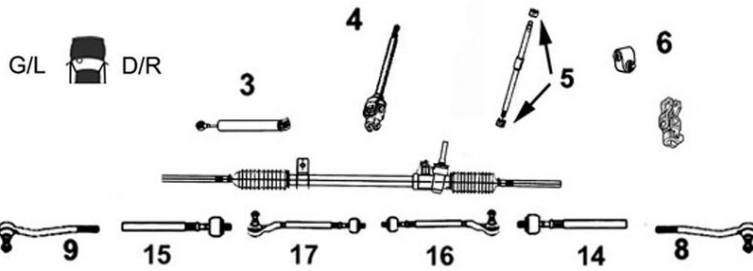

7774018 Axe de bielle G/D

Part/oe 485213172R L/R axial joint

NEW



14 Côté dir. M14x1.5 Côté rot. M14x1.5 long 193 mm

15 DA Conduite à gauche

1.2i Turbo
1.5 DCi
1.6i

JSM0
JSAL JSM6/7/C/W
JSJB/M3

01/12-
01/12-
01/12-

7674018 Rotule de direction G

OE 485202867R Left tie rod end

NEW



9 DA Conduite à gauche

1.2i Turbo
1.5 DCi
1.6i

JSM0
JSAL JSM6/7/C/W
JSJB/M3

01/12-
01/12-
01/12-

7674019 Rotule de direction D

OE 485200410R Right tie rod end

NEW



8 DA Conduite à gauche

1.2i Turbo
1.5 DCi
1.6i

JSM0
JSAL JSM6/7/C/W
JSJB/M3

01/12-
01/12-
01/12-



Barre stabilisatrice

Stabilizer bar

Barra estabilizadora

Drążek stabilizatora

стабилизатор поперечной устойчивости

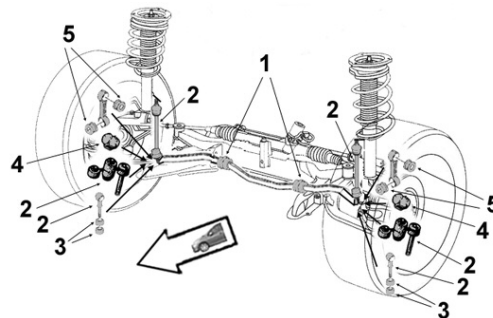

4005152 Palier de barre bout

OE 8200277960 End bar main bearing

2



1.2i Turbo
1.5 DCi /FAP
1.6i

JSM0
JSAL/MC/MW
JSJB/M3

H5F402
K9K612/830/846
K7M812

... Lodgy



Support d'amortisseur

Suspension mounting
Soporte amortiguador
Poduszka amortyzatora
Опора амортизатора

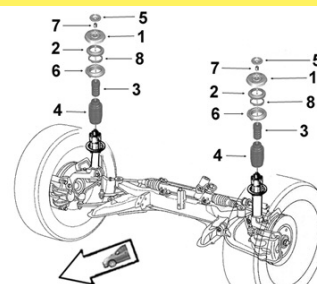

DACIA



4005537

Support suspension

OE 6001547499

Suspension mounting



1

1.2i Turbo
1.5 DCi
1.6i

JSM0
JSAL JSMC
JSJB JSM3

01/12-
01/12-
01/12-

4005300

Butée à billes G/D

OE 8200651172

L/R ball bearing



2

1.2i Turbo
1.5 DCi
1.6i

JSM0
JSAL JSMC
JSJB JSM3

01/12-
01/12-
01/12-

Sandero I ...

Eléments DIRECTION

Steering parts
Elementos Direcciones
Elementy uklad kierowniczy
Элементы рулевой системы

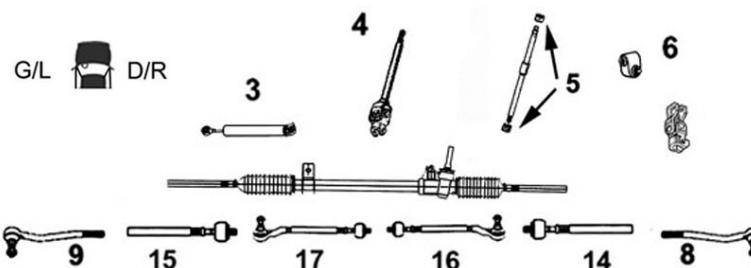

3008250

Axe de bielle G/D

OE 6001550441

L/R axial joint



14 Côté dir. M12x1.0 Côté rot. M14x1.5 long 194 mm

15 Conduite à G

1.0i 16v.
1.2i 16v.
1.4 MPi
1.5 DCi
1.6i 16v.
1.6 MPi

BS0R BS1G/R
BS1N BS01/2
BS0A/C/E/G BS1F/2
BS00/4/J/K/W/Y BS1L
BS09/L/M/P/V BS1P/S/V/Y
BS03/B/D/F/H/T BS11/6/A/E/H/T/U

4006158

Rotule de direction G

OE 6001550442

Left tie rod end



9

M14 x 1.5 Conduite à G

1.0i 16v. BS0R BS1G/R
1.2i 16v. BS1N BS01/2
1.4 MPi BS0A/C/E/G BS1F/2
1.5 DCi BS00/4/J/K/W/Y BS1L
1.6i 16v. BS09/L/M/P/V
BS1P/S/V/Y
1.6 MPi BS03/B/D/F/H/T
BS11/6/A/E/H/T/U

4006157

Rotule de direction D

OE 6001550443

Right tie rod end



8

M14 x 1.5 Conduite à G

1.0i 16v. BS0R BS1G/R
1.2i 16v. BS1N BS01/2
1.4 MPi BS0A/C/E/G BS1F/2
1.5 DCi BS00/4/J/K/W/Y BS1L
1.6i 16v. BS09/L/M/P/V
BS1P/S/V/Y
1.6 MPi BS03/B/D/F/H/T
BS11/6/A/E/H/T/U

... Sandero I ...

SASIC

DACIA



Barre stabilisatrice
 Stabilizer bar
 Barra estabilizadora
 Drążek stabilizatora
 стабилизатор поперечной устойчивости

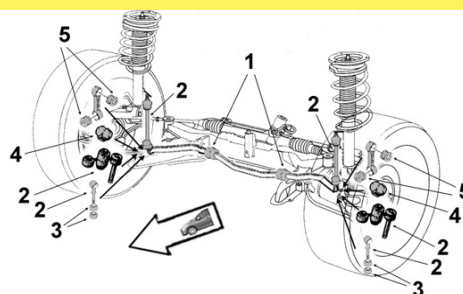

4005152 **Palier de barre bout**
 OE 8200277960 *End bar main bearing*



2

1.0i 16v.	BS0R BS1G/R
1.2i 16v. DA	BS1N BS01/2
1.4 MPi DA	BS0A/C/E/G BS1F/2
1.5 DCi	BS00/4/J/K/W/Y BS1L
1.6i 16v.	BS09/L/M/P/V
	BS1P/S/V/Y
1.6 MPi DA	BS03/B/D/F/H/T
	BS11/6/A/E/H/T/U

4005153 **Palier de barre milieu**
 OE 6001547140 *Middle bar main bearing*



1

1.2i 16v. DA	BS1N BS01/2
1.4 MPi DA	BS0A/C/E/G BS1F/2
1.5 DCi	BS00/4/J/K/W/Y BS1L
1.6i 16v.	BS09/L/M/P/V
	BS1P/S/V/Y
1.6 MPi DA	BS 0D/0F/0H/0B/
	0T/1A/1E/1H



Eléments SUSPENSION
 Suspension parts
 Elementos suspensión
 Elementy zawieszenie
 Элементы подвески

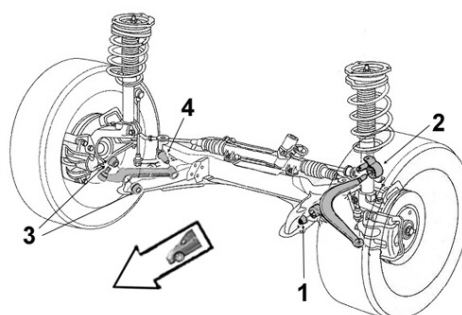

4001528 **Articulation AV/AR**
 Part/oe 8200820930 *Front rear bush*



1
2 Ø int.12 Ø ext.37 coll.50 long. tube int.46 ext.30 ep. coll.2

1.2i 16v.	BS1N
1.4 MPi	BS0A/C/E/G BS1F
1.5 DCi	BS00/J/K/W/Y
1.6i 16v.	BS09/L/M/P/V
1.6 MPi	BS0B/D/F/H/T BS1A/E/H

Bras & Triangle de suspension
 Control arm
 Brazo y triángulo
 Wahacz
 Рычаг подвески

G/L D/R



4003212 **Triangle de susp. G**
 Part/oe 545011362R *Left track control arm*



4 **Sans rotule Without ball joint**

1.0i 16v.	BS0R BS1G/R
1.2i 16v.	BS1N BS01/2
1.4 MPi	BS0A/C/E/G BS1F/2
1.5 DCi	BS00/4/J/K/W/Y BS1L
1.6i 16v.	BS09/L/M/P/V
	BS1P/S/V/Y
1.6 MPi	BS03/B/D/F/H/T
	BS11/6/A/E/H/T/U

4003214 **Triangle de susp. D**
 Part/oe 545004269R *Right track control arm*



3 **Sans rotule Without ball joint**

1.0i 16v.	BS0R BS1G/R
1.2i 16v.	BS1N BS01/2
1.4 MPi	BS0A/C/E/G BS1F/2
1.5 DCi	BS00/4/J/K/W/Y BS1L
1.6i 16v.	BS09/L/M/P/V
	BS1P/S/V/Y
1.6 MPi	BS03/B/D/F/H/T
	BS11/6/A/E/H/T/U

... Sandero I ...

7474018 OE 545011362R 	Triangle de susp. G <i>Left track control arm</i> 4 Avec rotule With ball joint Ø 18 1.0i 16v. BS0R BS1G/R 1.2i 16v. BS1N BS01/2 1.4 MPi BS0A/C/E/G BS1F/2 1.5 DCi BS00/4/J/K/W/Y BS1L 1.6i 16v. BS09/L/M/P/V BS1P/S/V/Y 1.6 MPi BS03/B/D/F/H/T BS11/6/A/E/H/T/U	7474017 OE 545004269R 	Triangle de susp. D <i>Right track control arm</i> 3 Avec rotule With ball joint Ø 18 1.0i 16v. BS0R BS1G/R 1.2i 16v. BS1N BS01/2 1.4 MPi BS0A/C/E/G BS1F/2 1.5 DCi BS00/4/J/K/W/Y BS1L 1.6i 16v. BS09/L/M/P/V BS1P/S/V/Y 1.6 MPi BS03/B/D/F/H/T BS11/6/A/E/H/T/U
7574003 OE 401604793R 	Rotule de susp. inf. G/D <i>L/R lower suspension ball joint</i> 1 Ø 18 2 1.0i 16v. BS0R BS1G/R 1.2i 16v. BS1N BS01/2 1.4 MPi BS0A/C/E/G BS1F/2 1.5 DCi BS00/4/J/K/W/Y BS1L 1.6i 16v. BS09/L/M/P/V BS1P/S/V/Y 1.6 MPi BS03/B/D/F/H/T BS11/6/A/E/H/T/U	7964002S OE - 	Kit rép. train AV (en/in Skinpact) <i>Front axle repair kit</i> Sans visserie Without screws and bolts 1.2i 16v. DA BS1N 1.4 MPi DA BS0A/C/E/G BS1F 1.5 DCi BS00/J/K/W/Y 1.6i 16v. BS09/L/M/P/V 1.6 MPi DA BS0B/D/F/H/T BS1A/E/H



Support d'amortisseur
Suspension mounting
Soporte amortiguador
Poduszka amortyzatora
Опора амортизатора

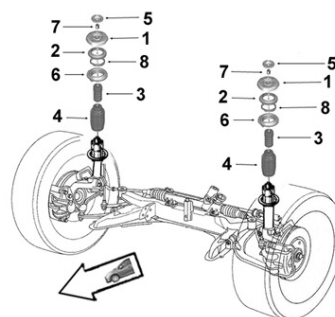

2654001 OE 6001548403 	Coupelle rebond. G/D <i>L/R spring cup</i> 5 1.2i 16v. BS1N 1.4 MPi BS0C/0E/0G/0A/1F 1.5 DCi BS00/0K/0W/0Y/0J 1.6i 16v. BS09/0L/0M/0P/0V 1.6 MPi BS0D/0F/0H/0B/0T /1A/1E/1H	4005537 OE 6001547499 	Support suspension <i>Suspension mounting</i> 1 1.2i 16v. BS1N 1.4 MPi BS0C/0E/0G/0A/1F 1.5 DCi BS00/0K/0W/0Y/0J 1.6i 16v. BS09/0L/0M/0P/0V 1.6 MPi BS0D/0F/0H/0B/0T /1A/1E/1H
-------------------------------------	---	-------------------------------------	--

4005300 OE 8200651172 	Butée à billes G/D <i>L/R ball bearing</i> 2 1.0i 16v. BS0R/1G/1R 1.2i 16v. BS1N 1.4 MPi BS0C/0E/0G/0A/1F/12 1.5 DCi BS00/0K/0W/0Y/0J/04/1L 1.6i MPi BS0D/0F/0H/0B/0T/1A/1E/1H/11/1T/1U BS09/0L/0M/0P/0V/1P/1S/1V/1Y
-------------------------------------	--

2654002 OE 6001549290 	Butée protecteur susp. G/D <i>L/R suspension bush</i> 3 4 1.2i 16v. BS1N 1.4 MPi BS0C/0E/0G/0A/1F 1.5 DCi BS00/0K/0W/0Y/0J 1.6i 16v. BS09/0L/0M/0P/0V 1.6 MPi BS0D/0F/0H/0B/0T/1A/1E/1H
-------------------------------------	--

... Sandero I



Support d'amortisseur
Suspension mounting
Soporte amortiguador
Poduszka amortyzatora
Опора амортизатора

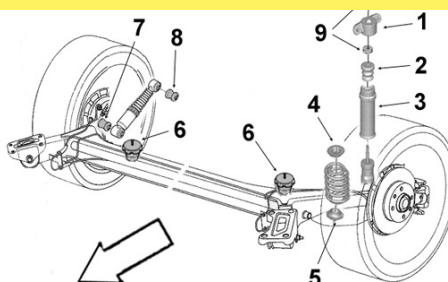

DACIA

2654028

Appui sup. ressort AR

OE 6001547495

Rear upper Spring support

4 Ø int. 43 Ø ext. 110 ep. 34



1.0
1.2i 16v.
1.4 MPi
1.5 DCi
1.6i 16v.
1.6 MPi

Eléments TRAIN ARRIERE

Rear axle parts

Tren TRAS

Elementy zawieszenia tylnego

элементы задней оси.



2604001

Articulation AR

OE 6001549989

Rear bush



Ø int.12 Ø ext.68 coll.78
long. tube int.90 ext.55 ep. coll.11.5

1.2i 16v. BS1N D4F
1.4 MPi BS 0C/0E/0G/0A/1F K7J
1.5 DCi BS 00/0K/0W/0Y/0J K9K
1.6i 16v. BS 09/0L/0M/0P/0V K4M
1.6i MPi BS 0D/F/H/B/T/1A/1E/1H K7M

Sandero II ...

Eléments DIRECTION

Steering parts

Elementos Direcciones

Elementy uklad kierowniczy

Элементы рулевой системы

G/L D/R

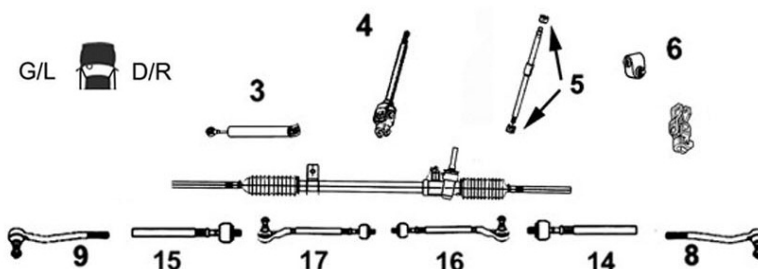

3008250

Axe de bielle G/D

Part/oe 6001550441

L/R axial joint

14 Côté dir. M12x1.0 Côté rot. M14x1.5 long 194 mm
15



1.2i	DNA Conduite à gauche	K/L8 MG/P
1.6i	DNA Conduite à gauche	L8A6/JB/ME/MV K8JB

7774018

Axe de bielle G/D

Part/oe 485213172R

L/R axial joint

14 Côté dir. M14x1.5 Côté rot. M14x1.5 long 193 mm
15



0.9 Turbo	DA	B8MA	08/12-
1.0i 16v.	DA	B8A0	08/12-
1.2i	DA	B8MG/P/U/Y	08/12-
1.5 DCi	DA	B8AL B8M4/6/7/W	08/12-
1.6i	DA	B8A6/JB/ME/MV	08/12-
1.6i 16v.	DA	B8M9/MT	08/12-

... Sandero II

DACIA



7674018 Rotule de direction G

OE 485202867R *Left tie rod end*

NEW



9	1.2i	DNA Conduite à gauche	B8MG/P/U/Y	
	1.6i	DNA Conduite à gauche	B8A6/JB/ME/MV	
	0.9 Turbo	DA	B8MA	08/12-
	1.0i 16v.	DA	B8A0	08/12-
	1.2i	DA	B8MG/P/U/Y	08/12-
	1.5 DCi	DA	B8AL B8M4/6/7/W	08/12-
	1.6i	DA	B8A6/JB/ME/MV	08/12-
	1.6i 16v.	DA	B8M9/MT	08/12-

7674019 Rotule de direction D

OE 485200410R *Right tie rod end*

NEW



8	1.2i	DNA Conduite à gauche	B8MG/P/U/Y	
	1.6i	DNA Conduite à gauche	B8A6/JB/ME/MV	
	0.9 Turbo	DA	B8MA	08/12-
	1.0i 16v.	DA	B8A0	08/12-
	1.2i	DA	B8MG/P/U/Y	08/12-
	1.5 DCi	DA	B8AL B8M4/6/7/W	08/12-
	1.6i	DA	B8A6/JB/ME/MV	08/12-
	1.6i 16v.	DA		



Barre stabilisatrice

Stabilizer bar
Barra estabilizadora
Drażek stabilizatora
стабилизатор поперечной устойчивости

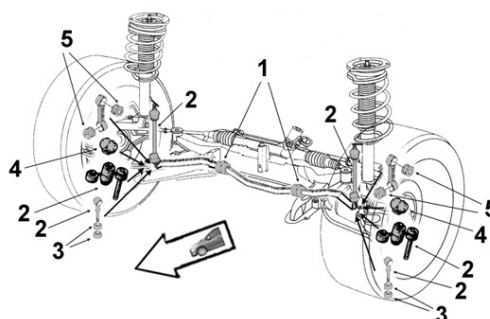

4005152 Palier de barre bout

OE 8200277960 *End bar main bearing*

2



0.9i Turbo	B8MA	H4B400
1.2i	B8MG/P/Y	D4F732/34
1.5 DCi /FAP	B8AL/M4/M6/MW	K9K612/830/838
1.6i 8v.	B8JB	K7M812

Espero ...

Eléments DIRECTION

Steering parts
Elementos Direcciones
Elementy układ kierowniczy
Элементы рулевой системы

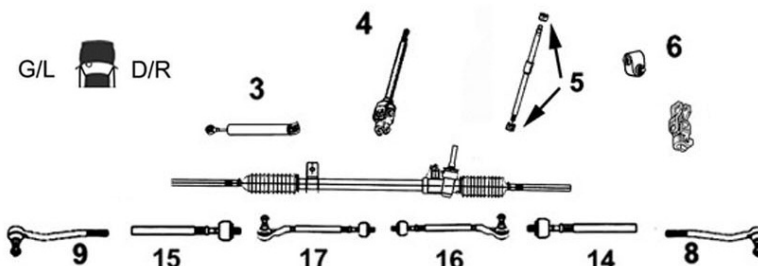

9006372 Rotule de direction G

OE 26001807 *Left tie rod end*

9 M16 x 15



TT /all models 01/91-

9006373 Rotule de direction D

OE 26001806 *Right tie rod end*

8 M16 x 15



TT /all models 01/91-

DAEWOO



... Espero

Bras & Triangle de suspension

Control arm
Brazo y triángulo
Wahacz
Рычаг подвески

G/L  D/R

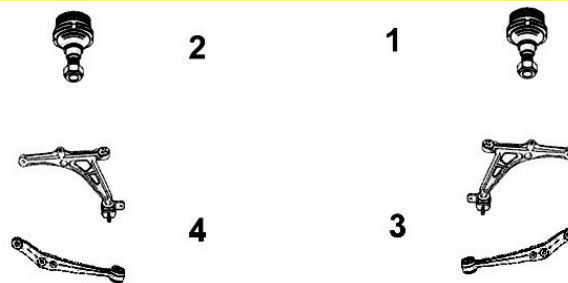

9005251

Rotule de susp. inf. G/D

OE 94788122

L/R lower suspension ball joint



1
2

TT /all models

01/91-

Kalos ...

Eléments DIRECTION

Steering parts
Elementos Direcciones
Elementy układ kierowniczy
Элементы рулевой системы

G/L  D/R

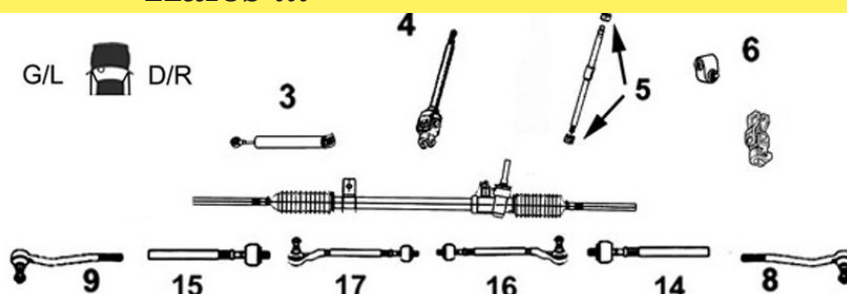

7676005

Rotule de direction G

OE 93740722

Left tie rod end



9

1.2i 02/03-12/04
1.4i 09/02-12/04

7676007

Rotule de direction D

OE 93740723

Right tie rod end



8

1.2i 02/03-12/04
1.4i 09/02-12/04



Barre stabilisatrice

Stabilizer bar
Barra estabilizadora
Drażek stabilizatora
стабилизатор поперечной устойчивости

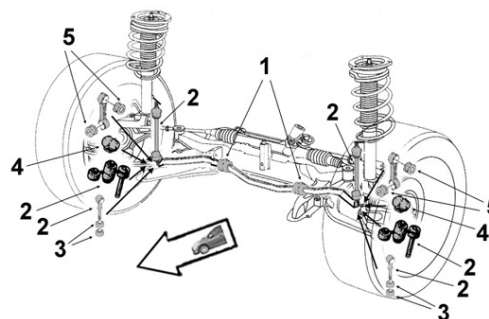

2306074

Biellette barre stab.

OE 96391875

Stabilizer bar stub axle



2

1.2i
1.4i

02/03-12/04
09/02-12/04

... Kalos

Bras & Triangle de suspension

Control arm
Brazo y triángulo
Wahacz
Рычаг подвески

G/L  D/R

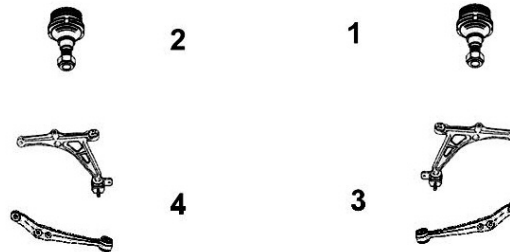

7476040

OE 96870465

Triangle de susp. G

Left track control arm



4 Avec rotule *With ball joint*

1.2i	04/03-
1.4i	09/02-
1.4i 16v.	04/03-

7476039

OE 96870466

Triangle de susp. D

Right track control arm



3 Avec rotule *With ball joint*

1.2i	04/03-
1.4i	09/02-
1.4i 16v.	04/03-

7576003

OE 96535089

Rotule de susp. inf. G/D

L/R lower suspension ball joint



1
2

1.2	04/03-
1.4	09/02-
1.4 16v.	04/03-

Lacetti

Bras & Triangle de suspension

Control arm
Brazo y triángulo
Wahacz
Рычаг подвески

G/L  D/R

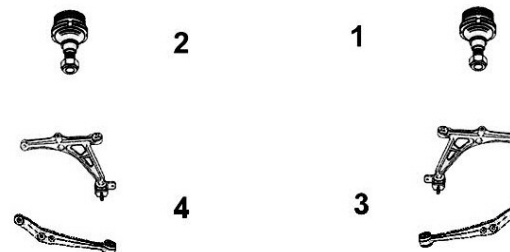

7476162

OE 96415063

Triangle de susp. G

Left track control arm

NEW



4 Avec rotule *With ball joint* Ø 18

1.4i	04/04-12/04
1.6i	04/04-12/04
1.8i	04/04-12/04

7476161

OE 96415064

Triangle de susp. D

Right track control arm

NEW



3 Avec rotule *With ball joint* Ø 18

1.4i	04/04-12/04
1.6i	04/04-12/04
1.8i	04/04-12/04

Leganza

Eléments DIRECTION

Steering parts

Elementos Direcciones

Elementy układ kierowniczy

Элементы рулевой системы

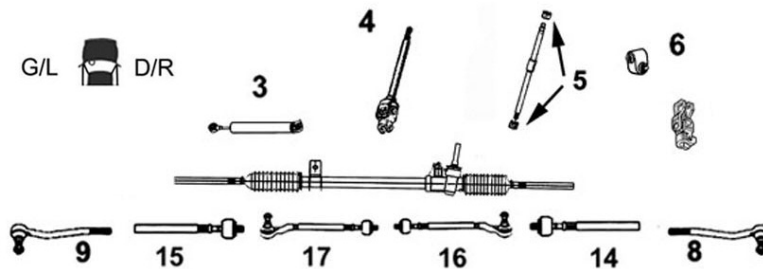

7776065

Axe de bielle G/D

OE 520808

L/R axial joint

NEW



14 Côté dir. M16x1.5 Côté rot. M14x1.5 long 360 mm
15

2.0i /16v.
2.2i

09/97-09/02
09/98-01/03

Matiz ...

Eléments DIRECTION

Steering parts

Elementos Direcciones

Elementy układ kierowniczy

Элементы рулевой системы

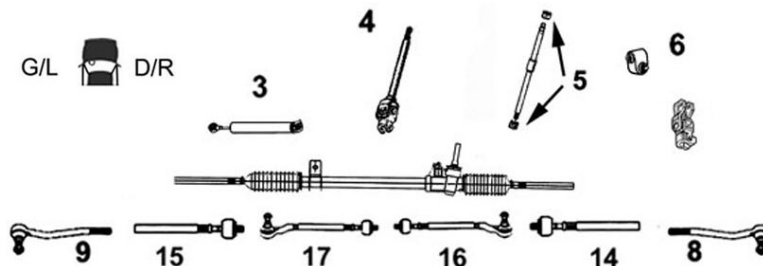

7776068

Axe de bielle G/D

OE 93741074

L/R axial joint

NEW



14 Côté dir. M16x1.5 Côté rot. M12x1.5 long 252 mm
15

0.8i
1.0i

Pour pneus 145 / 155
Pour pneus 145 / 155

Sans DA
Sans DA

F8CV
B10S /1

7776063

Axe de bielle G/D

OE 521257

L/R axial joint

NEW



14 Côté dir. M16x1.5 Côté rot. M12x1.5
15 long 256 mm

Pour pneus 175 Sans DA

0.8i
1.0i

F8CV
B10S

7776064

Axe de bielle G/D

OE 93741092

L/R axial joint

NEW



14 Côté dir. M16x1.5 Côté rot. M12x1.5
15 long 251 mm

Avec DA

0.8i
1.0i

F8CV
B10S /1

7676023

Rotule de direction G/D

OE 48810A78B00000 L/R tie rod end



8
9 M12 x 1.5

0.8i
1.0i

09/98-
01/03-

... Matiz

Bras & Triangle de suspension

Control arm
Brazo y triángulo
Wahacz
Рычаг подвески

G/L  D/R

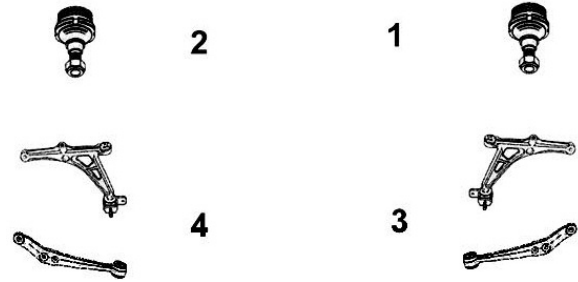

7476041

Bras de susp. AV inf. G/D

OE 96611265

L/R front lower track control arm



3 Avec rotule With ball joint
4 Ø15

0.8i
1.0i

09/98-12/04
01/03-12/04

DAEWOO



Nexia

Eléments DIRECTION

Steering parts
Elementos Direcciones
Elementy układ kierowniczy
Элементы рулевой системы

G/L  D/R

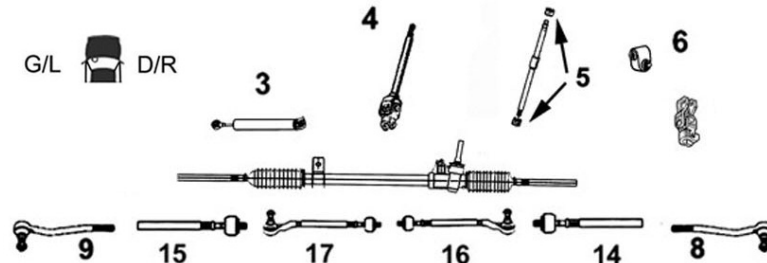

9006372

Rotule de direction G

OE 26001807

Left tie rod end



9 M16 x 1.5

TT /all models

9006373

Rotule de direction D

OE 26001806

Right tie rod end



8 M16 x 1.5

TT /all models

Bras & Triangle de suspension

Control arm
Brazo y triángulo
Wahacz
Рычаг подвески

G/L  D/R

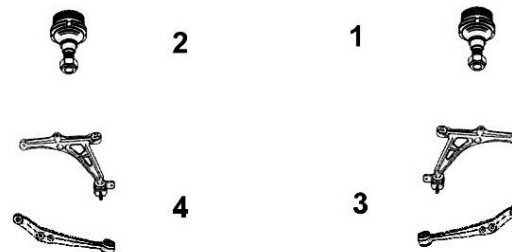

9005251

Rotule de susp. inf. G/D

OE 94788122

L/R lower suspension ball joint



1
2

TT /all models

Nubira ...

Eléments DIRECTION

Steering parts
Elementos Direcciones
Elementy układ kierowniczy
Элементы рулевой системы

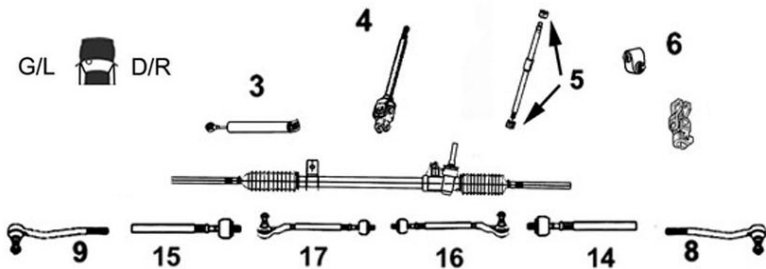

7776075

Axe de bielle G/D

OE 520838

L/R axial joint

NEW



14 Côté dir. M16x1.5 Côté rot. M14x1.5 long 344 mm

1.6i 16v. / GPL
2.0i 16v. / GPL

09/99-09/02
09/99-09/02



Barre stabilisatrice

Stabilizer bar
Barra estabilizadora
Drażek stabilizatora
стабилизатор поперечной устойчивости

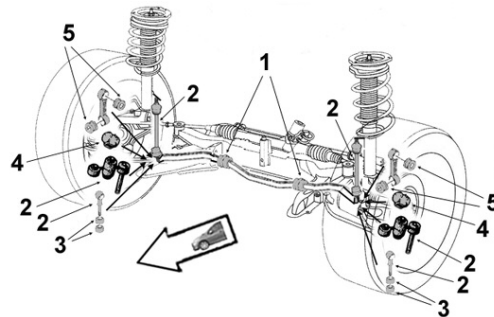

2306074

Biellette barre stab.

OE 96391875

Stabilizer bar stub axle



2

1.6i 16v.
2.0i
2.0i 16v.

09/99-09/02
09/99-09/02
01/99-09/02



Eléments SUSPENSION

Suspension parts
Elementos suspensión
Elementy zawieszenie
Элементы подвески

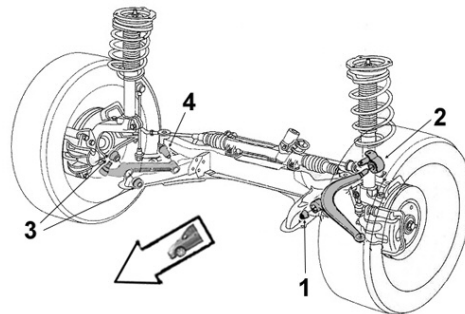

9001536

Articulation AR

Part/oe 96268439

Rear bush



2

Ø int.16 Ø ext.53 long. tube int.49 ext.25

1.6i 16v.
2.0i 16v.

9001537

Articulation AV

Part/oe 96268439

Front bush



1

Ø int.12 Ø ext.49 long. tube int.44 ext.25

1.6i 16v.
2.0i 16v.

... Nubira

Bras & Triangle de suspension

Control arm
Brazo y triángulo
Wahacz
Рычаг подвески

G/L  D/R



7476162

OE 96415063

Triangle de susp. G

Left track control arm

4 Avec rotule With ball joint Ø 18

NEW



1.6i /SW 110hp 80kw

1.8i /SW 120hp 90kw

F16D3

06/03-12/04

T18SED

06/03-12/04

7476161

OE 96415064

Triangle de susp. D

Right track control arm

3 Avec rotule With ball joint Ø 18

NEW



1.6i /SW 110hp 80kw

1.8i /SW 120hp 90kw

F16D3

06/03-12/04

T18SED

06/03-12/04

Rezzo



Barre stabilisatrice

Stabilizer bar
Barra estabilizadora
Drażek stabilizatora
стабилизатор поперечной устойчивости

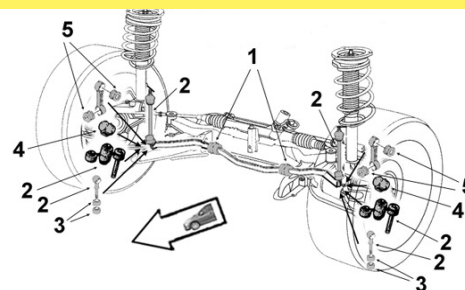

2306074

OE 96391875

Biellette barre stab.

Stabilizer bar stub axle

2



1.6i 16v.

1.8i

2.0i

2.0i 16v.

09/02-12/02

09/00-09/02

09/00-12/04

09/00-12/04

Tico

Bras & Triangle de suspension

Control arm
Brazo y triángulo
Wahacz
Рычаг подвески

G/L  D/R

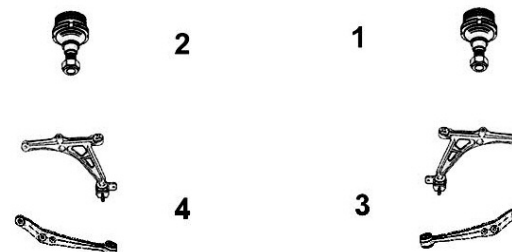

7476041

OE 96611265

Bras de susp. AV inf. G/D

L/R front lower track control arm

3 Avec rotule With ball joint
4 Ø15



0.8i

02/95-12/00

Terios

Eléments DIRECTION
Steering parts
Elementos Direcciones
Elementy układ kierowniczy
Элементы рулевой системы

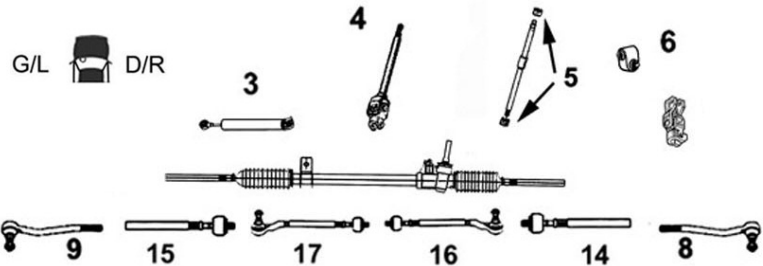

7776099 **Axe de bielle G/D**
OE 4546087401 *L/R axial joint*

NEW



14 Côté dir. M14x1.5 Côté rot. M14x1.5 long 298 mm
15

1.5i /4WD

3SZ/VE

06/06-

500

Eléments DIRECTION
Steering parts
Elementos Direcciones
Elementy układ kierowniczy
Элементы рулевой системы

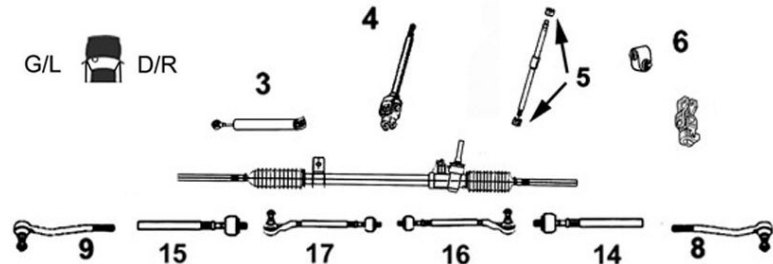

9006441 **Rotule de direction G**
OE 77362507 *Left tie rod end*



9 M12 x 1.5

0.9 Turbo /Cab.	09/09-
1.2	07/07-
1.3 JTD	07/07-
1.4i 16v. /Cab.	07/07-
1.4 Turbo	05/08-

9006440 **Rotule de direction D**
OE 77362508 *Right tie rod end*



8 M12 x 1.5

0.9 Turbo /Cab.	09/09-
1.2	07/07-
1.3 JTD	07/07-
1.4i 16v. /Cab.	07/07-
1.4 Turbo	05/08-



Barre stabilisatrice
Stabilizer bar
Barra estabilizadora
Drażek stabilizatora
стабилизатор поперечной устойчивости

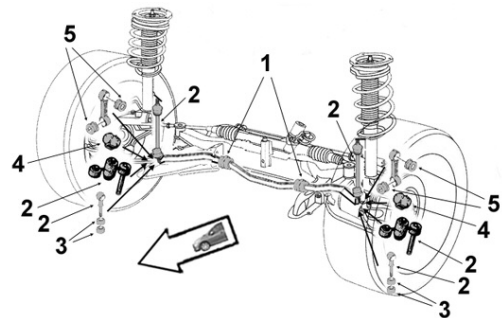

9005099 **Biellette barre stab.**
OE 51801136 *Stabilizer bar stub axle*



2

0.9i Turbo Twinair /Cab.	312A2000	BVM BV Rob.	09/10-
1.2i /Cab.	169A4000	BVM	07/07-
1.3 JTD FAP	169A1000	BVM	07/07-
1.3 JTD FAP /Cab.	199B1000	BVM	10/09-
1.4i 16v. /Dualogic /Cab.	169A3000	BVM	07/07-
1.4i Turbo	312A1000 /A3000	BVM	05/08-
1.4i Turbo Multiair /Cab.	312A3000	BVM BV Rob.	09/10-



Eléments SUSPENSION

Suspension parts
Elementos suspensión
Elementy zawieszenie
Элементы подвески

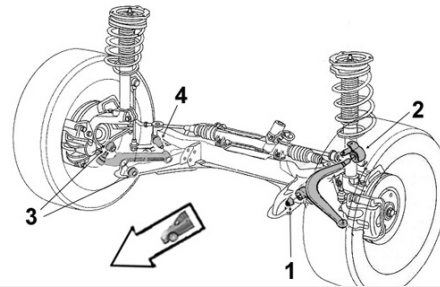

2256010

Articulation AR

Part/oe 50708824

Rear bush



2 Ø int. 14.5 Ø ext. 61
long. tube int.52 ext.27

1.2i 169A4000 07/07-
1.3 JTD 169A1000 07/07-
1.4i 16v. 169A3000 07/07-

2256011

Articulation AV

Part/oe 50708824

Front bush



1 Ø int. 12 Ø ext. 34 coll. 37 coll. 33
long. tube int. 52 ext. 39.5

1.2i 169A4000 07/07-
1.3 JTD 169A1000 07/07-
1.4i 16v. 169A3000 07/07-

Bras & Triangle de suspension

Control arm
Brazo y triángulo
Wahacz
Рычаг подвески

G/L D/R



7476030

Triangle de susp. G

OE 51857021

Left track control arm



4 Avec rotule With ball joint

0.9 Turbo /Cab. 09/09-
1.2i /Cab. 07/07-
1.3 JTD FAP /Cab. 07/07-
1.4i 16v. /Cab. 07/07-

7476029

Triangle de susp. D

OE 51857022

Right track control arm



3 Avec rotule With ball joint

0.9 Turbo /Cab. 09/09-
1.2i /Cab. 07/07-
1.3 JTD FAP /Cab. 07/07-
1.4i 16v. /Cab. 07/07-

Barchetta

Eléments DIRECTION

Steering parts
Elementos Direcciones
Elementy układ kierowniczy
Элементы рулевой системы

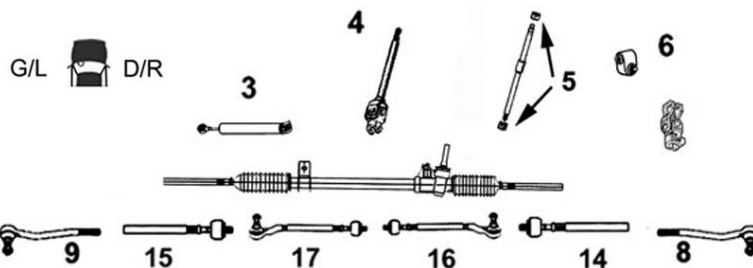

9006342

Rotule de direction G/D

OE 9946949

L/R tie rod end



8
9 M12 x 1.5

1.8i 16v. 06/95-06/06

Brava ...

SASIC

FIAT

Eléments DIRECTION

Steering parts

Elementos Direcciones

Elementy uklad kierowniczy

Элементы рулевой системы

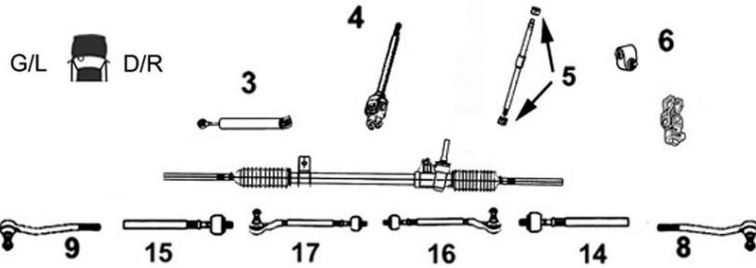

9006271

Axe de bielle G/D

OE 9941625

L/R axial joint

14 Côté dir. M14x1.5 Côté rot. M12x1.5 long 265 mm

TT /all models Sauf 2.0



9006334

Rotule de direction G

OE 9947437

Left tie rod end

9 M12x1.5

TT /all models Sauf 2.0



9006335

Rotule de direction D

OE 9947436

Right tie rod end

8 M12x1.5

TT /all models Sauf 2.0



Barre stabilisatrice

Stabilizer bar

Barra estabilizadora

Drażek stabilizatora

стабилизатор поперечной устойчивости

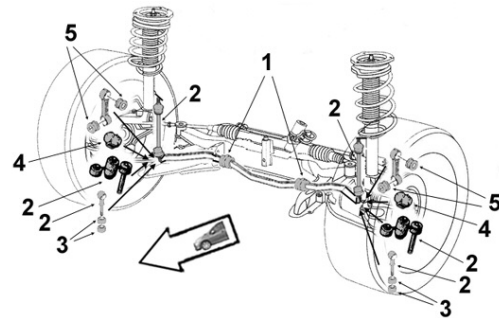

9001502

Liaison élastique

OE 7601642

Elastic link

3 Ø int.10.4 Ø ext.30.5
long. tube int.15.5 ext.17.5

1.4
1.6i 16v.
1.8
1.9 D
1.9 TD
2.0



9005082

Biellette barre stab.

OE 60570627

Stabilizer bar stub axle

2

1.4 09/95-10/98
1.6i 16v. 09/95-10/98
1.8 09/95-10/98
1.9 D 09/95-10/98
1.9 JTD 09/95-12/00
1.9 TD 09/95-12/00
2.0 09/95-10/98



9001728

Palier de barre milieu

OE 7760424

Middle bar main bearing

1 Barre Ø 23

1.8 09/95-12/01
1.9 D 09/95-12/96
1.9 JTD 09/95-12/01
1.9 TD 09/95-12/01
2.0 09/95-12/01



9001729

Palier de barre milieu

OE 7760425

Middle bar main bearing

1 Barre Ø 22

1.2 10/98-12/00
1.4 09/95-10/98
1.6i 16v. 09/95-12/01



... Brava ...



Eléments SUSPENSION

Suspension parts

Elementos suspensión

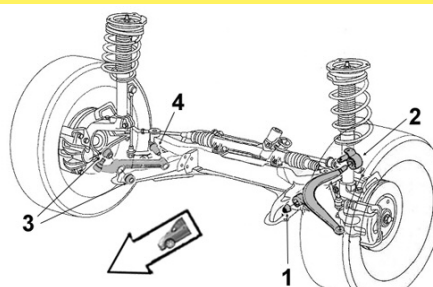

Elementy zawieszenie

Элементы подвески









FIAT



9001717 OE 7601065	Articulation AR G <i>Left rear bush</i>	9001714 OE 7601068	Articulation AR D <i>Right rear bush</i>
	2 Ø21 1.2 09/95-12/00 1.4 09/95-12/00 1.6i 16v. 09/95-12/00 1.8 09/95-12/00 1.9 D 09/95-12/00 1.9 JTD 09/95-12/00 1.9 TD 09/95-12/00		2 Ø21 1.2 09/95-12/00 1.4 09/95-12/00 1.6i 16v. 09/95-12/00 1.8 09/95-12/00 1.9 D 09/95-12/00 1.9 JTD 09/95-12/00 1.9 TD 09/95-12/00

9001722 OE 7601064	Articulation AV <i>Front bush</i>		
	1 Ø21 1.2 09/95-12/00 1.4 09/95-12/00 1.6i 16v. 09/95-12/00 1.8 09/95-12/00 1.9 D 09/95-12/00 1.9 JTD 09/95-12/00 1.9 TD 09/95-12/00		

Bras & Triangle de suspension <i>Control arm</i> <i>Brazo y triángulo</i> <i>Wahacz</i> <i>Рычаг подвески</i>	G/L  D/R	 2  4	1  3 
--	---	--	--

9005104 OE 71747915	Triangle de susp. G <i>Left track control arm</i>	9005103 OE 71747916	Triangle de susp. D <i>Right track control arm</i>
	4 Avec rotule With ball joint Ø 17 TT /all models Sauf 2.0		3 Avec rotule With ball joint Ø 17 TT /all models Sauf 2.0

... Brava

SASIC

FIAT



Support d'amortisseur
Suspension mounting
Soporte amortiguador
Poduszka amortyzatora
Опора амортизатора

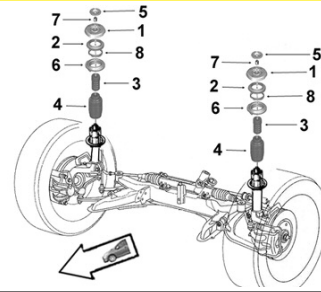

9001752 **Support suspension G/D**
 OE 46469709 *L/R suspension mounting*

8005206 **Butée à billes G/D**
 OE 7601502 *L/R ball bearing*



1 **Avec roulement With bearing**
 1.2 10/98-12/00
 1.4 01/96-10/98
 1.6i 16v. 09/95-12/00
 1.8 09/95-12/00
 1.9 D 09/95-12/00
 1.9 JTD 09/95-12/00
 1.9 TD 09/95-12/00
 2.0 sauf Pack sport 09/95-12/00



2 **Ø 78.5 x 128 x 47**
 1.4 09/95-01/96
 1.6i 16v. 09/95-01/96
 1.8 09/95-01/96
 1.9 D 09/95-01/96
 1.9 TD 09/95-01/96
 2.0 Pack sport 09/95-12/00

9005373 **Butée protecteur susp. AV G/D**
 Part/oe 46404169 *L/R front suspension bush*



3
4 1.2i 16v. 01/98-12/01
 1.4 09/95-10/98
 1.6i 16v. 09/95-12/01
 1.8 09/95-10/98
 1.9 D 09/95-10/98
 1.9 JTD 10/98-12/01
 1.9 TD 09/95-12/01
 2.0 09/95-10/98

9005611 **Coupelle ressort G/D**
 OE 7602150 *L/R spring cup*



6
 2.0i 20v. HGT 10/98-

Bravo ...

Eléments DIRECTION
Steering parts
Elementos Direcciones
Elementy układ kierowniczy
Элементы рулевой системы

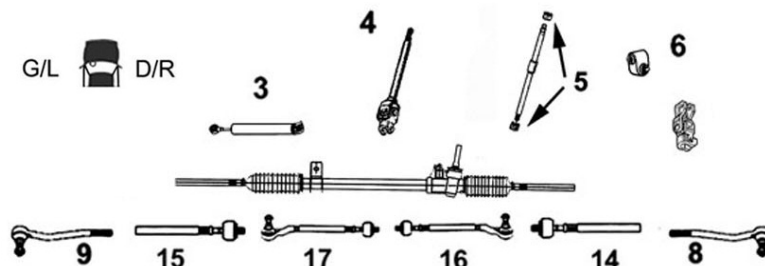

9006271 **Axe de bielle G/D**
 OE 9941625 *L/R axial joint*

9006334 **Rotule de direction G**
 OE 9947437 *Left tie rod end*











14 Côté dir. M14x1.5 Côté rot. M12x1.5
15 long 265 mm
 TT /all models

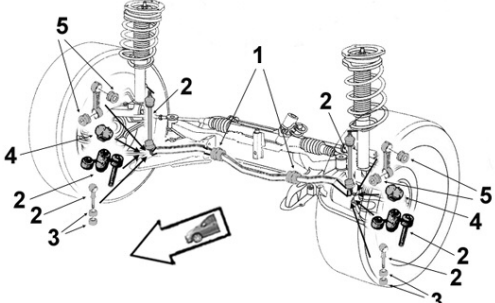

9 M12 x 1.5
 TT /all models Sauf 2.0

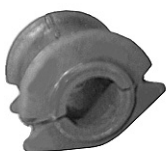
... Bravo ...

9006335		Rotule de direction D <i>Right tie rod end</i>		9006444		Rotule de direction G/D <i>L/R tie rod end</i>		
OE 9947436		8	M12 x 1.5	OE 9949218		8 9	M14 x 1.5	
		TT /all models Sauf 2.0				1.4i 16v. 03/07- 1.4 Turbo 06/07- 1.6 JTD /FAP 09/07- 1.9 JTD 03/07-05/08 2.0 JTD 10/08-		
		Barre stabilisatrice <i>Stabilizer bar</i> <i>Barra estabilizadora</i> <i>Drażek stabilizatora</i> стабилизатор поперечной устойчивости						
9001502		Liaison élastique <i>Elastic link</i>						
OE 7601642		3	Ø int.10.4 Ø ext.30.5 long. tube int.15.5 ext.17.5					
			1.4 1.6 1.8i 16v. 1.9 D 1.9 TD 2.0i 20v.					
9005082		Biellette barre stab. <i>Stabilizer bar stub axle</i>						
OE 60570627		2						
			1.4 09/95-10/98 1.6i 16v. 09/95-10/98 1.8i 16v. 09/95-10/98 1.9 D 09/95-10/98 1.9 JTD 09/95-12/00 1.9 TD 09/95-10/98 2.0i 20v. 09/95-10/98					
9005099		Biellette barre stab. <i>Stabilizer bar stub axle</i>						
OE 51801136		2						
			1.4i 16v. BVM 03/07- 1.4i Turbo /Dualogic /Multiair BVM 06/07- 1.6 JTD FAP /Dualogic BVM 09/07- 1.9 JTD BVM 03/07-05/08 2.0 JTD FAP BVM 10/08-					
9001729		Palier de barre milieu <i>Middle bar main bearing</i>		9001728		Palier de barre milieu <i>Middle bar main bearing</i>		
OE 7760425		1	Barre Ø 22	OE 7760424		1	Barre Ø 23	
			1.2 10/98-12/01 1.4 09/95-10/98 1.6i 16v. 09/95-12/01 1.8i 16v. 09/95-09/00 2.0i 20v. 09/95-10/98				1.6i 16v. GPL 01/98-05/99 1.8i 16v. 09/95-09/00 1.9 D 09/95-12/96 1.9 JTD 09/95-12/01 1.9 TD 09/95-09/00 2.0i 20v. 09/95-09/00	

FIAT



... Bravo ...



Eléments SUSPENSION
Suspension parts
Elementos suspensión
Elementy zawieszenie
Элементы подвески

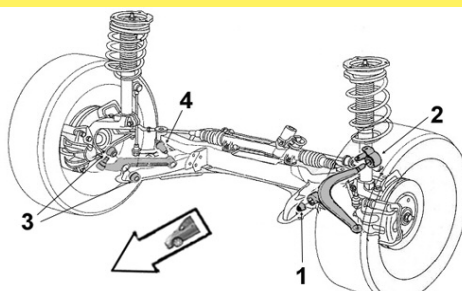

FIAT

SASIC

9001717

Articulation AR G

OE 7601065

Left rear bush



2

Ø21

1.2	09/95-12/00
1.4	09/95-12/00
1.6i 16v.	09/95-12/00
1.8i 16v.	09/95-12/00
1.9 D	09/95-12/00
1.9 JTD	09/95-12/00
1.9 TD	09/95-12/00
2.0i 20v.	09/95-12/00

9001714

Articulation AR D

OE 7601068

Right rear bush



2

Ø21

1.2	09/95-12/00
1.4	09/95-12/00
1.6i 16v.	09/95-12/00
1.8i 16v.	09/95-12/00
1.9 D	09/95-12/00
1.9 JTD	09/95-12/00
1.9 TD	09/95-12/00
2.0i 20v.	09/95-12/00

9001722

Articulation AV

OE 7601064

Front bush



1

Ø21

1.2	09/95-12/00
1.4	09/95-12/00
1.6i 16v.	09/95-12/00
1.8i 16v.	09/95-12/00
1.9 D	09/95-12/00
1.9 JTD	09/95-12/00
1.9 TD	09/95-12/00
2.0i 20v.	09/95-12/00

Bras & Triangle de suspension

Control arm
Brazo y triángulo
Wahacz
Рычаг подвески

G/L  D/R

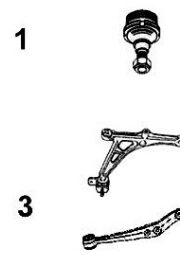
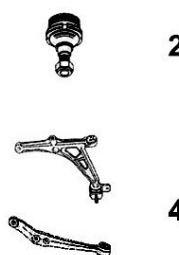

9005104

Triangle de susp. G

OE 71747915

Left track control arm



4

Avec rotule With ball joint Ø 17

TT /all models Sauf 2.0 09/95-

9005103

Triangle de susp. D

OE 71747916

Right track control arm



3

Avec rotule With ball joint Ø 17

TT /all models Sauf 2.0 09/95-

9005149

Triangle de susp. G

OE 46474556

Left track control arm



4

Avec rotule With ball joint Ø 17

2.0i 20v. 09/95-10/98

9005148

Triangle de susp. D

OE 46474557

Right track control arm



3

Avec rotule With ball joint Ø 17

2.0i 20v. 09/95-10/98

... Bravo

7476178 OE 51827736 	Triangle de susp. G <i>Left track control arm</i> 4 Avec rotule With ball joint Ø 17 1.4i 16v./GPL192B2000 03/07- 1.4i Turbo 198A1/4/7000 09/07- 1.6 JTD FAP 198A2/3/6000 09/07- 1.9 JTD/FAP 192A8000 /B5000 937A5000 03/07-05/08 2.0 JTD FAP 198A5000 10/08-	7476177 OE 51827738 	Triangle de susp. D <i>Right track control arm</i> 3 Avec rotule With ball joint Ø 17 1.4i 16v./GPL192B2000 03/07- 1.4i Turbo 198A1/4/7000 09/07- 1.6 JTD FAP 198A2/3/6000 09/07- 1.9 JTD/FAP 192A8000 /B5000 937A5000 03/07-05/08 2.0 JTD FAP 198A5000 10/08-
-----------------------------------	---	-----------------------------------	--



Support d'amortisseur
Suspension mounting
Soporte amortiguador
Poduszka amortyzatora
Опора амортизатора

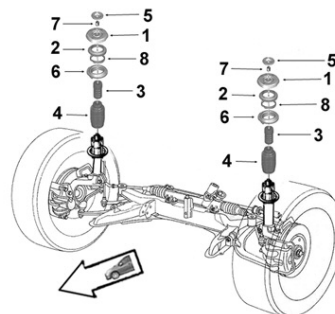

9001752 OE 46469709 	Support suspension G/D <i>L/R suspension mounting</i> 1 Avec roulement With bearing 1.2 10/98-12/00 1.4 01/96-10/98 1.6i 16v. 09/95-12/00 1.8i 16v. 09/95-12/00 1.9 D 09/95-12/00 1.9 JTD 09/95-12/00 1.9 TD 09/95-12/00 2.0i 20v. sauf Pack sport 09/95-12/00	8005206 OE 7601502 	Butée à billes G/D <i>L/R ball bearing</i> 2 Ø 78.5 x 128 x 47 1.4 09/95-01/96 1.6 09/95-01/96 1.8i 16v. 09/95-01/96 1.9 D 09/95-01/96 1.9 TD 09/95-01/96 2.0i 20v. Pack sport 09/95-12/00
-----------------------------------	--	----------------------------------	--

9005373 Part/oe 46773884 	Butée protecteur susp. AV G/D <i>L/R front suspension bush</i> 3 4 1.2i 16v. 04/98-12/01 1.4 09/95-05/99 1.6i 16v. 09/95-05/99 1.8i 16v. 09/95-09/00 1.9 D 09/95-02/00 1.9 JTD 10/98-12/01 1.9 TD 09/95-10/98 2.0i 20v. 09/95-09/00	9005611 OE 7602150 	Coupelle ressort G/D <i>L/R spring cup</i> 6 2.0i 20v. HGT 10/98-
--	--	----------------------------------	--

Eléments TRAIN ARRIERE
Rear axle parts
Tren TRAS
Elementy zawieszenia tylnego
элементы задней оси.



2606002 OE 50702649 	Articulation essieu G/D <i>L/R axle bush</i> Ø int. 13 Ø ext. 67.5 coll. 80.5 long. tube int. 100 ext. 65 ep coll. 16 1.4i Turbo /Dualogic BVM 06/07- 1.6 JTD FAP /Dualogic BVM 09/07- 1.9 JTD /FAP BVM 03/07-05/08		
-----------------------------------	--	--	--

Cinquecento

Eléments DIRECTION
 Steering parts
 Elementos Direcciones
 Elementy układ kierowniczy
 Элементы рулевой системы

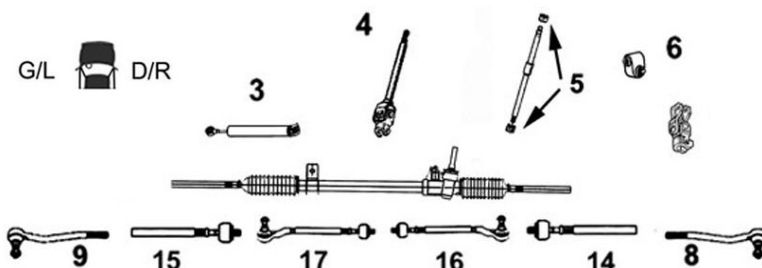

9006333 Rotule de direction G/D

OE 7669756 L/R tie rod end



8
9 M12 x 1.5

TT /all models



Eléments SUSPENSION
 Suspension parts
 Elementos suspensión
 Elementy zawieszenie
 Элементы подвески

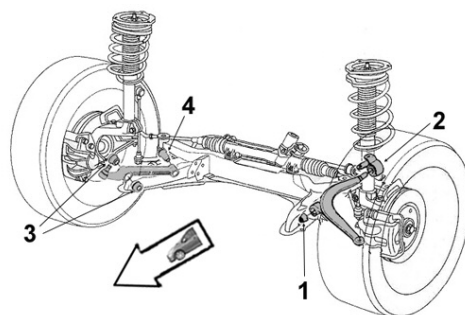

9001738 Articulation AR

OE 5927293 Rear bush



2

0.9 07/92-09/98
1.1 10/94-09/98

9001720 Articulation AV

OE 5927292

Front bush
 1 Ø int.12 Ø ext.32 coll.37
 long. tube int.55 ext.40 ep. coll.6



1

0.9 07/92-09/98
1.1 10/94-09/98

Coupé...

Eléments DIRECTION
 Steering parts
 Elementos Direcciones
 Elementy układ kierowniczy
 Элементы рулевой системы

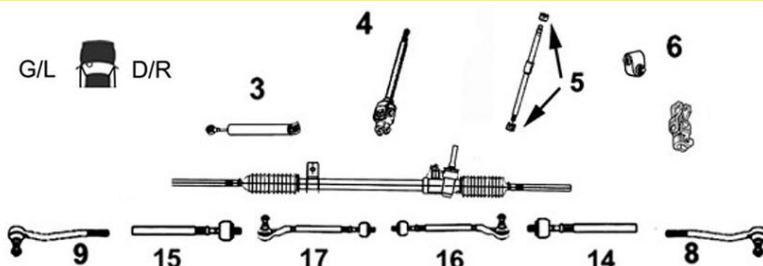

9006334 Rotule de direction G

OE 9947437 Left tie rod end



9 M12 x 1.5

2.0 16v. 11/93-08/96

9006335 Rotule de direction D

OE 9947438

Right tie rod end



8 M12 x 1.5

2.0 16v. 11/93-08/96

... Coupé

FIAT

SASIC

9006654 Rotule de direction G/D

OE 9947714 *L/R tie rod end*

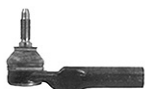

8
9 M14 x 1.5

1.8i 16v.
2.0 20v.

09/96-08/00
08/96-08/00



Barre stabilisatrice
Stabilizer bar
Barra estabilizadora
Drażek stabilizatora
стабилизатор поперечной устойчивости

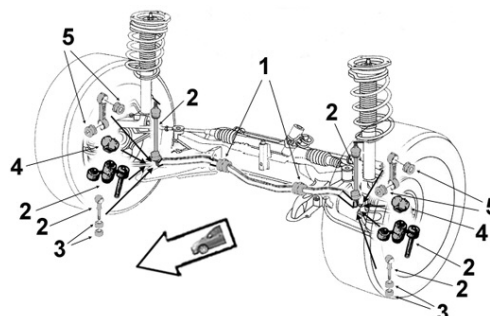

9005082 Bielle barre stab.

OE 60570627 *Stabilizer bar stub axle*



2

1.8i 16v.
2.0i 16v.
2.0i 20v.
2.0i Turbo

183A1
836A3
182A1 182B3
175A1 175A3

10/96-09/00
07/94-10/96
10/96-
06/94-

9001728 Palier de barre milieu

OE 7760424 *Middle bar main bearing*



1 Barre Ø 23

1.8i 16v.
2.0i 16v.
2.0i 20v.
2.0i Turbo

183A1
836A3
182A1 182B3
175A1 175A3

10/96-09/00
07/94-10/96
10/96-
06/94-

Bras & Triangle de suspension

Control arm
Brazo y triángulo
Wahacz
Рычаг подвески

G/L D/R

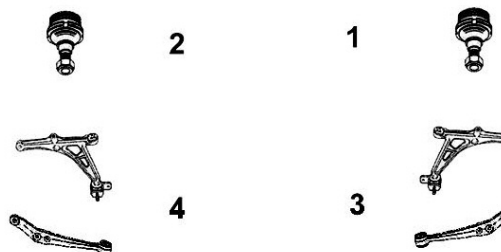

9005149 Triangle de susp. G

OE 46474556 *Left track control arm*



4 Avec rotule With ball joint Ø 17

1.8i 16v. 03/96-09/00
2.0 16v. /Turbo 11/93-09/00
2.0 20v. /Turbo 08/96-09/00

9005148 Triangle de susp. D

OE 46474557 *Right track control arm*



3 Avec rotule With ball joint Ø 17

1.8i 16v. 03/96-09/00
2.0 16v. /Turbo 11/93-09/00
2.0 20v. /Turbo 08/96-09/00

... Coupé

SASIC



Support d'amortisseur
Suspension mounting
Soporte amortiguador
Poduszka amortyzatora
Опора амортизатора

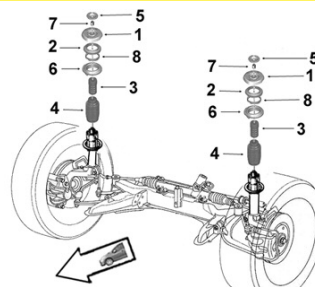

8005206

Butée à billes G/D

OE 7601502

L/R ball bearing

2 Ø 78.5 x 128 x 47



1.8i 16v.
 2.0i 16v.
 2.0i 20v.
 2.0i Turbo

183A1
 836A3
 182A1 182B3
 175A1 175A3

10/96-09/00
 06/94-10/96
 10/96-
 06/94-

Croma

Eléments DIRECTION

Steering parts

Elementos Direcciones

Elementy układu kierowniczy

Элементы рулевой системы

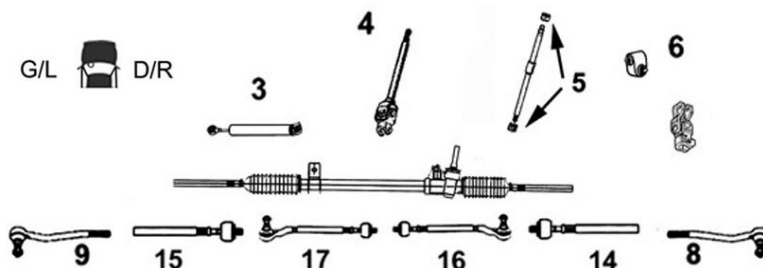

9006268

Axe de bielle G/D

OE 9940260

L/R axial joint

14 Côté dir. M14x1.5 Côté rot. M14x1.5
15 long 265 mm



TT /all models DA -12/96

9006339

Rotule de direction G/D

OE 82387676

L/R tie rod end

8
9 M14 x 1.5



TT /all models DA Ch- 0025984

Bras & Triangle de suspension

Control arm
Brazo y triángulo
Wahacz
Рычаг подвески

G/L D/R

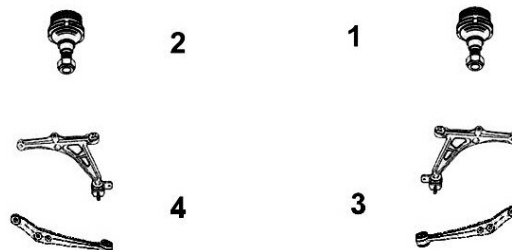

9005232

Rotule de susp. inf. G/D

OE 82446499

L/R lower suspension ball joint

1
2



TT /all models

Duna



Support d'amortisseur
 Suspension mounting
 Soporte amortiguador
 Poduszka amortyzatora
 Опора амортизатора

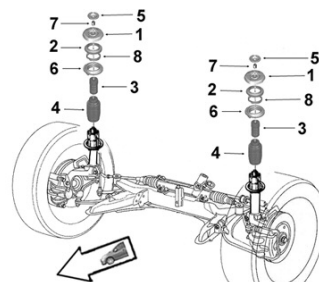

FIAT



9001754 OE 50003871	Support suspension G/D L/R suspension mounting	8005200 OE 4400895	Butée à billes G/D L/R ball bearing
	1 1.7 D 01/88-		2 Ø 50 x 70 x 3.6 1.7 D

Fiorino VL ...

Eléments DIRECTION

Steering parts
 Elementos Direcciones
 Elementy uklad kierowniczy
 Элементы рулевой системы

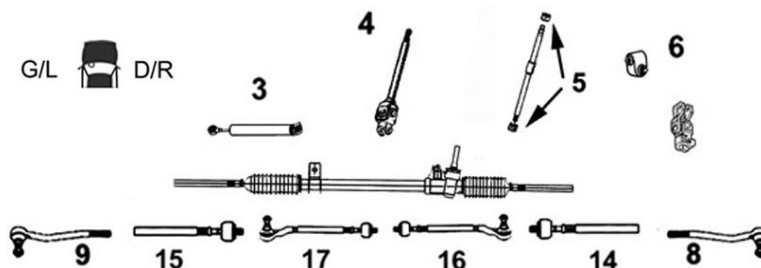

9006264 Part/oe 5960321	Axe de bielle G/D L/R axial joint	9006830 Part/oe 7076231	Axe de bielle G/D L/R axial joint
	14 Côté dir. M14x1.5 Côté rot. M12x1.5 15 long 192 mm TT /all models 02/92-12/93		14 Côté dir. M14x1.5 Côté rot. M14x1.5 15 long 217 mm TT /all models 1.7 D 12/92-12/93 01/93-
9006831 Part/oe 7077206	Axe de bielle G/D L/R axial joint	7770013 Part/oe 51784191	Axe de bielle G/D L/R axial joint
	14 Côté dir. M14x1.5 Côté rot. M14x1.5 15 long 192 mm TT /all models DA 01/93-		14 Côté dir. M14x1.5 Côté rot. M14x1.5 15 long 276 mm 1.3 JTD 199A2000 BVM 01/08- 1.4i TU3A/JP (KFV) BVM 01/08-
9006340 OE 7543028	Rotule de direction G/D L/R tie rod end	9006341 OE 50006261	Rotule de direction G/D L/R tie rod end
	8 9 M12 x 1.5 TT /all models 03/88-12/92		8 9 M14 x 1.5 TT /all models 12/92-03/00

... Fiorino VL ...

Eléments DIRECTION

Steering parts

Elementos Direcciones

Elementy układ kierowniczy

Элементы рулевой системы

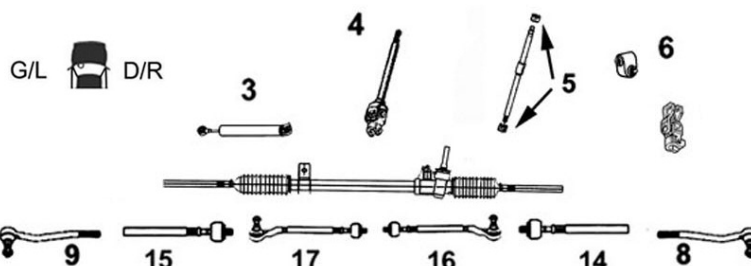

7670008

Rotule de direction G

OE 77364568

Left tie rod end



9 M14 x 1.5

1.3 JTD
1.4i 16v.

01/08-
01/08-

7670009

Rotule de direction D

OE 77364569

Right tie rod end



8 M14 x 1.5

1.3 JTD
1.4i 16v.

01/08-
01/08-



Barre stabilisatrice

Stabilizer bar

Barra estabilizadora

Drażek stabilizatora

стабилизатор поперечной устойчивости

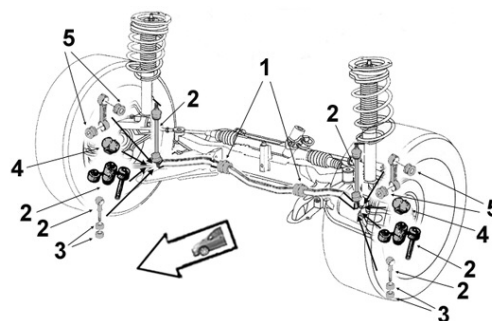

2300029

Biellette barre stab.

OE 51815479

Stabilizer bar stub axle



2

1.3 JTD
1.4i 16v.

01/08-
01/08-

2300043

Palier de barre milieu

OE 51785487

Middle bar main bearing



1 Barre Ø 20

1.3 JTD
1.4i

199A2000
TU3A/JP

01/08-
01/08-



Eléments SUSPENSION

Suspension parts

Elementos suspensión

Elementy zawieszenie

Элементы подвески

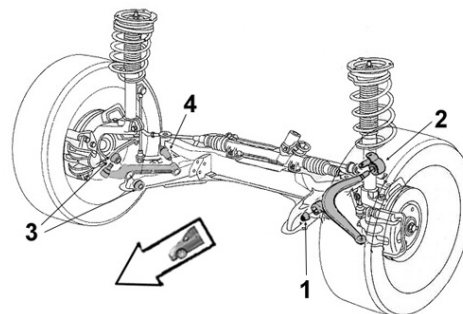

2256009

Articulation AR

Part/oe 51783057

Rear bush



2 Ø int. 12.5 Ø ext. 73 long. tube int. 66
ext. 27.5

1.3 JTD
1.4i

01/08-
01/08-

2256032

Articulation AV

Part/oe 51783057

Front bush



1 Ø int. 12.5 Ø ext. 42 coll. 43 coll. 50.5
long. tube int. 67.5 ext. 41

1.3 JTD
1.4i

01/08-
01/08-

... Fiorino VL ...

Bras & Triangle de suspension

Control arm
Brazo y triángulo
Wahacz
Рычаг подвески

G/L  D/R

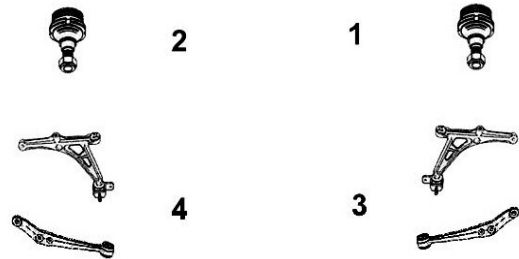

9005106 Bras de suspension G/D
OE 7591277 L/R track control arm

3
4 Avec rotule With ball joint Ø 10



TT /all models 03/88- -ch 8157331

9005174 Bras de suspension G/D
OE 7674825 L/R track control arm

3
4 Avec rotule With ball joint Ø 10



TT /all models Ch- 8157331

7470005 Triangle de susp. G
OE 51895367 Left track control arm

4 Avec rotule With ball joint



1.3 JTD 01/08-
1.4i 01/08-

7470006 Triangle de susp. D
OE 51895366 Right track control arm

3 Avec rotule With ball joint



1.3 JTD 01/08-
1.4i 01/08-

7570004 Rotule de susp. inf. G/D
Part/oe 51895367 L/R lower suspension ball joint

1
2



1.3 JTD 01/08-
1.4i 01/08-



Support d'amortisseur

Suspension mounting
Soporte amortiguador
Poduszka amortyzatora
Опора амортизатора

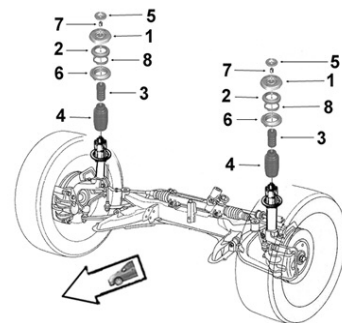

9001754 Support suspension G/D
OE 50003871 L/R suspension mounting

1



1.1	01/88-09/00
1.3	01/88-09/00
1.4	01/88-09/00
1.5	01/88-09/00
1.6	01/88-09/00
1.7 D	01/88-09/00

... Fiorino VL

SASIC

FIAT



Support d'amortisseur
Suspension mounting
Soporte amortiguador
Poduszka amortyzatora
Опора амортизатора

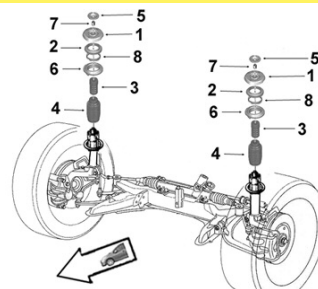

2650031 **Support suspension G**
 OE 51963725 *Left suspension mounting*



1
 1.3 JTD 199A2000/9000 01/08-
 1.4i TU3A TU3AE5 01/08-

2650032 **Support suspension D**
 OE 51963726 *Right suspension mounting*



1
 1.3 JTD 199A2000/9000 01/08-
 1.4i TU3A TU3AE5 01/08-

8005200 **Butée à billes G/D**
 OE 4400895 *L/R ball bearing*



2 Ø 50 x 70 x 3.6
 1.1 07/88-12/93
 1.3 07/88-01/00
 1.4 07/94-12/01
 1.5 03/93-12/93
 1.6 08/93-09/00
 1.7 D 07/88-06/91

2650025 **Butée de suspension G/D**
 OE 51866009 *L/R suspension bush*



3
 1.3 JTD 199A2000 01/08-
 1.4i TU3A/JP (KFV) 01/08-

Eléments TRAIN ARRIERE
Rear axle parts
Tren TRAS
Elementy zawieszenia tylnego
элементы задней оси.



2600012 **Articulation essieu**
 OE 51783623 *Axle bush*



Ø int. 13 Ø ext. 69 coll. 80 long. tube int.94
 ext. 100 ep. coll. 2.5
 1.3 JTD 199A2000 01/08-
 1.4i TU3A/JP 01/08-

Idea ...

Eléments DIRECTION
Steering parts
Elementos Direcciones
Elementy uklad kierowniczy
Элементы рулевой системы

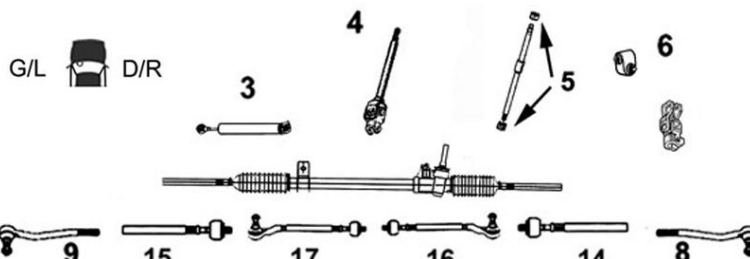

9006832 **Axe de bielle G/D**
 Part/oe 77362502 *L/R axial joint*



14 Côté dir. M14x1.5 Côté rot. M14x1.5 long 255 mm
15
 1.3 MJTD BVM BV Rob.
 1.4i 16v. BVM BV Rob.
 1.9 JTD BVM

... Idea

Bras & Triangle de suspension

Control arm
Brazo y triángulo
Wahacz
Рычаг подвески

G/L  D/R

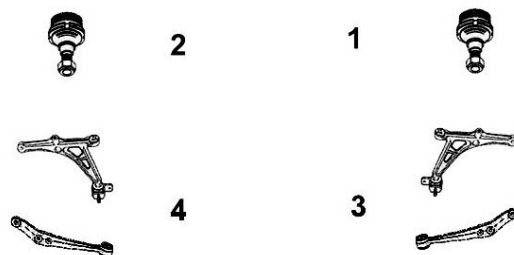

9005794

OE 51839219

Triangle de susp. inf. G

Lower left track control arm

4 Avec rotule *With ball joint*

1.2i 16v.	BVM	01/04-10/05
1.3 MJTD/FAP	BVM /Rob.	01/04-
1.4i	BVM	08/05-06/07
1.4i GNV	BVM	03/09-
1.4i 16v.	BVM /Rob.	01/04-
1.9 JTD	BVM	01/04-



9005793

OE 51839218

Triangle de susp. inf. D

Lower right track control arm

3 Avec rotule *With ball joint*

1.2i 16v.	BVM	01/04-10/05
1.3 MJTD/FAP	BVM /Rob.	01/04-
1.4i	BVM	08/05-06/07
1.4i GNV	BVM	03/09-
1.4i 16v.	BVM /Rob.	01/04-
1.9 JTD	BVM	01/04-



Linea

Eléments DIRECTION

Steering parts
Elementos Direcciones
Elementy układ kierowniczy
Элементы рулевой системы

G/L  D/R

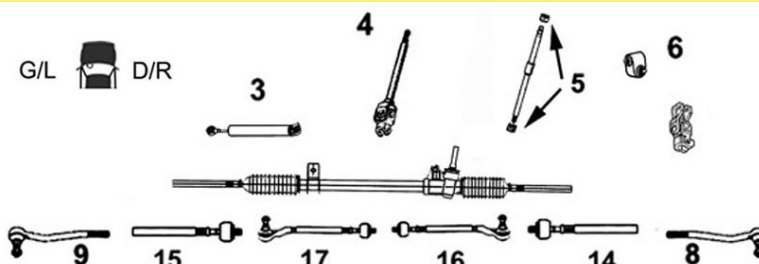

7670008

OE 77364568

Rotule de direction G

Left tie rod end

9 M14 x 1.5

1.3 JTD	06/07-
1.4i	06/07-
1.4i Turbo	09/07-



7670009

OE 77364569

Rotule de direction D

Right tie rod end

8 M14 x 1.5

1.3 JTD	06/07-
1.4i	06/07-
1.4i Turbo	09/07-



Barre stabilisatrice

Stabilizer bar
Barra estabilizadora
Drażek stabilizatora
стабилизатор поперечной устойчивости

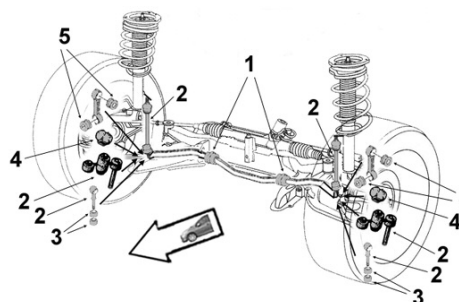

2300029

OE 51815479

Biellette barre stab.

Stabilizer bar stub axle

2

1.3 JTD
1.4i
1.4i Turbo
1.6 JTD



Marea ...

SASIC

FIAT

Eléments DIRECTION

Steering parts
Elementos Direcciones
Elementy układ kierowniczy
Элементы рулевой системы

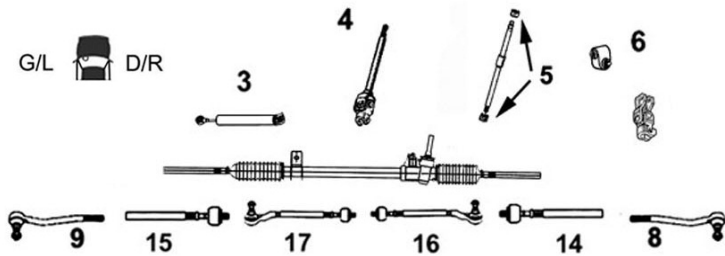

3008069

Axe de bielle G/D

Part/oe 9947713

L/R axial joint



14 Côté dir. M14x1.5 Côté rot. M14x1.5
15 long 306 mm

1.6i 16v.
1.8i 16v.
1.9 TD
2.0i 20v.
2.4 TD

9006654

Rotule de direction G/D

OE 9947714

L/R tie rod end

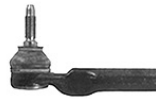

8 M14 x 1.5

9 1.2i 16v.
1.4 12v.
1.6i 16v.
1.8i 16v.
1.9 JTD
1.9 TD
2.0i 20v.
2.4 TD

03/99-12/02

09/96-02/99



Barre stabilisatrice

Stabilizer bar
Barra estabilizadora
Drażek stabilizatora
стабилизатор поперечной устойчивости

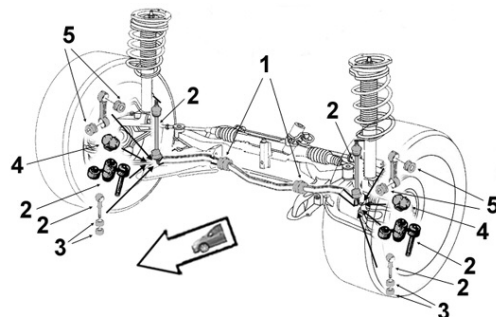

9005000

Biellette barre stab.

OE 51701045

Stabilizer bar stub axle



2

1.6i 16v. /Week End
1.8i 16v.
1.9 JTD /WeekEnd
1.9 TD
2.0i 20v. /Week End
2.4 JTD /Week End
2.4 TD

09/96-12/02
09/96-09/98
03/99-12/02
09/96-09/98
09/96-12/02
03/99-09/00
09/96-09/98



Eléments SUSPENSION

Suspension parts
Elementos suspensión
Elementy zawieszenie
Элементы подвески

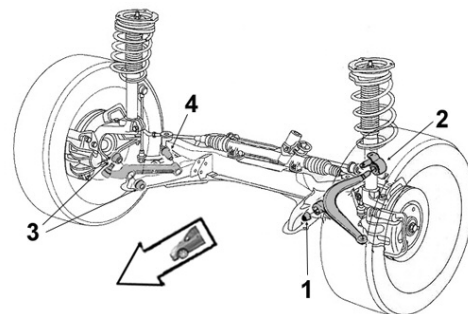

9001717

Articulation AR G

OE 7601065

Left rear bush



2 Ø21

1.4 09/96-02/99
1.6i 16v. 09/96-02/99
1.8i 16v. 09/96-02/99
1.9 TD 09/96-02/99
2.0i 20v. 09/96-02/99
2.4 TD 09/96-02/99

9001714

Articulation AR D

OE 7601068

Right rear bush



2 Ø21

1.4 09/96-02/99
1.6i 16v. 09/96-02/99
1.8i 16v. 09/96-02/99
1.9 TD 09/96-02/99
2.0i 20v. 09/96-02/99
2.4 TD 09/96-02/99

... Marea

FIAT

SASIC

9001722

Articulation AV

OE 7601064

Front bush



1 Ø21

1.4
1.6i 16v.
1.8i 16v.
1.9 TD
2.0i 20v.
2.4 TD

09/96-02/99
09/96-02/99
09/96-02/99
09/96-02/99
09/96-02/99
09/96-02/99

Bras & Triangle de suspension

*Control arm
Brazo y triángulo
Wahacz
Рычаг подвески*

G/L D/R

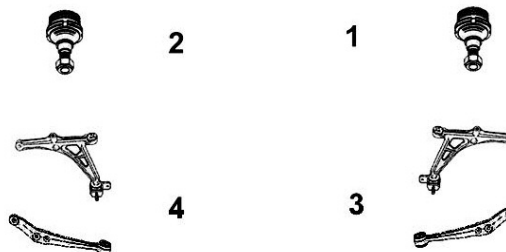

9005149

Triangle de susp. G

OE 46474556

Left track control arm



4 Avec rotule *With ball joint* Ø17

1.6i 16v.
1.8i 16v.
1.9 JTD
1.9 TD
2.0i 20v.
2.4 JTD
2.4 TD

9005148

Triangle de susp. D

OE 46474557

Right track control arm



3 Avec rotule *With ball joint* Ø17

1.6i 16v.
1.8i 16v.
1.9 JTD
1.9 TD
2.0i 20v.
2.4 JTD
2.4 TD



Support d'amortisseur

*Suspension mounting
Soporte amortiguador
Poduszka amortyzatora
Опора амортизатора*

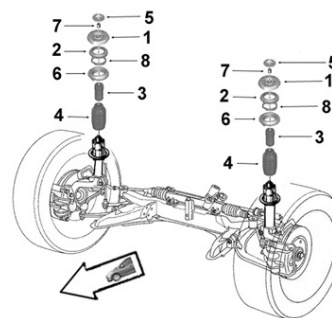

9001752

Support suspension G/D

OE 46469709

L/R suspension mounting



1 Avec roulement *With bearing*

1.6i 16v.
1.8i 16v.
1.9 TD
2.0i 20v.
2.4 TD

09/96-02/99
09/96-09/98
09/96-09/98
09/96-09/98
09/96-09/98

Multipla ...

SASIC

FIAT

Eléments DIRECTION

Steering parts
Elementos Direcciones
Elementy układ kierowniczy
Элементы рулевой системы

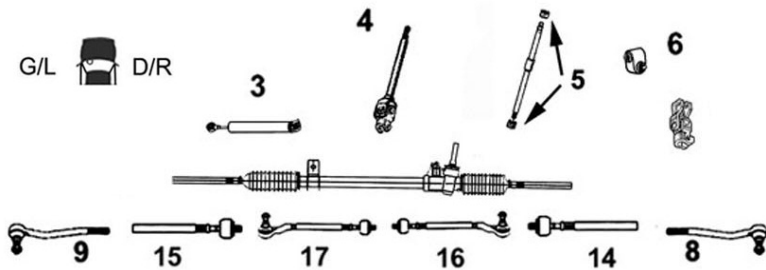

3008069

Axe de bielle G/D

Part/oe 9947713

L/R axial joint



14 Côté dir. M14x1.5 Côté rot. M14x1.5
15 long 306 mm

1.6i 16v. /GPL -08/04
1.9 JTD 105hp 77kw 110hp 81kw
115hp 85kw -08/04

9006654

Rotule de direction G/D

OE 9947714

L/R tie rod end

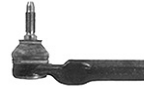

8
9 M14 x 1.5

1.6i 16v. /GPL -08/04
1.6i 16v. 09/04-
1.9 JTD 105hp 77kw 110hp 81kw
115hp 85kw -08/04
1.9 JTD 09/04-



Barre stabilisatrice

Stabilizer bar
Barra estabilizadora
Drażek stabilizatora
стабилизатор поперечной устойчивости

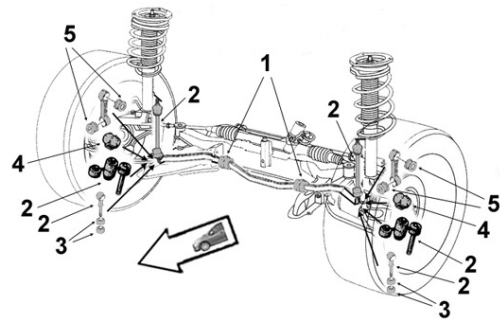

9005000

Biellette barre stab.

OE 51701045

Stabilizer bar stub axle



2

1.6i 16v. /GNV
1.9 JTD

01/99-04/10
01/99-04/10

Bras & Triangle de suspension

Control arm
Brazo y triángulo
Wahacz
Рычаг подвески

G/L D/R

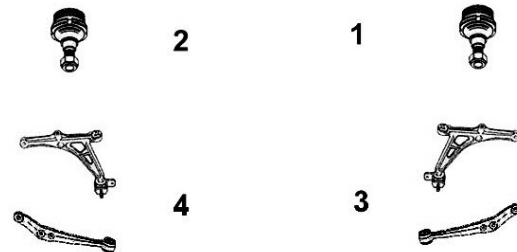

9005801

Triangle de susp. inf. G

OE 51832937

Lower left track control arm



4 Avec rotule With ball joint

1.6i 16v. /GPL -08/04
1.6i 16v. 09/04-
1.9 JTD 105hp 77kw 110hp 81kw
115hp 85kw -08/04
1.9 JTD 09/04-

9005800

Triangle de susp. inf. D

OE 51832938

Lower right track control arm



3 Avec rotule With ball joint

1.6i 16v. /GPL -08/04
1.6i 16v. 09/04-
1.9 JTD 105hp 77kw 110hp 81kw
115hp 85kw -08/04
1.9 JTD 09/04

... Multipla



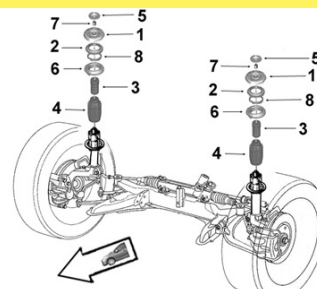

Support d'amortisseur
 Suspension mounting
 Soporte amortiguador
 Poduszka amortyzatora
 Опора амортизатора



FIAT





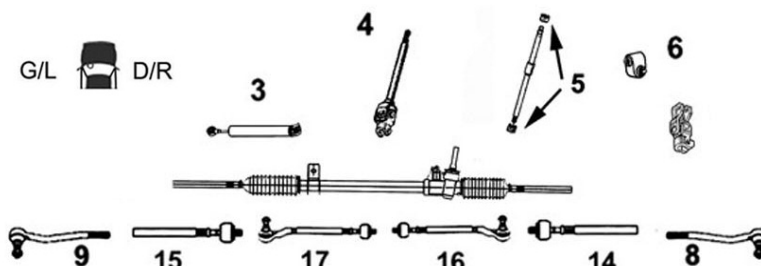

9005619 OE 46536244	Support suspension G/D <i>L/R suspension mounting</i>	9005370 OE 1303672080	Butée à billes G/D <i>L/R ball bearing</i>
	1 1.6i 16v. 1.9 JTD 01/99- 01/99-		2 Ø 78 x 128 x 45.5 1.6i 16v. 1.9 JTD 01/99-06/02 01/99-06/02

Palio ...

Eléments DIRECTION
 Steering parts
 Elementos Direcciones
 Elementy układ kierowniczy
 Элементы рулевой системы



9006824 OE 7079388	Axe de bielle G/D <i>L/R axial joint</i>	9006825 OE 7079382	Axe de bielle G/D <i>L/R axial joint</i>
	14 Côté dir. M14x1.5 Côté rot. M14x1.5 15 long 283 mm TT /all models DNA 01/96-12/01		14 Côté dir. M14x1.5 Côté rot. M14x1.5 15 long 285 mm TT /all models DA 01/96-07/99
9006827 OE 9948292	Axe de bielle G/D <i>L/R axial joint</i>		
	14 Côté dir. M16x1.5 Côté rot. M14x1.5 long 281 mm 15 TT /all models DA 08/99-12/01		
9006655 OE 46456189	Rotule de direction G <i>Left tie rod end</i>	9006657 OE 46456660	Rotule de direction D <i>Right tie rod end</i>
	9 M14 x 1.5 TT /all models 01/96-		8 M14 x 1.5 TT /all models 01/96-

... Palio ...

SASIC

FIAT



Barre stabilisatrice
 Stabilizer bar
 Barra estabilizadora
 Drażek stabilizatora
 стабилизатор поперечной устойчивости

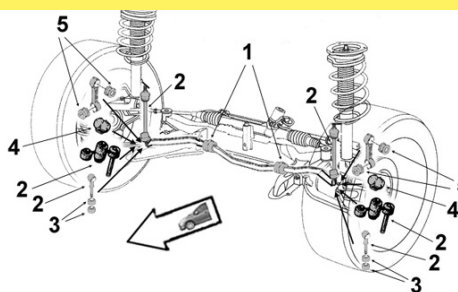

9001569 **Palier de barre bout**
 OE 7520850 *End bar main bearing*



4

1.2
 1.6
 1.7 TD

01/97-12/01
 01/97-12/01
 01/97-12/01



Eléments SUSPENSION
 Suspension parts
 Elementos suspensión
 Elementy zawieszenie
 Элементы подвески

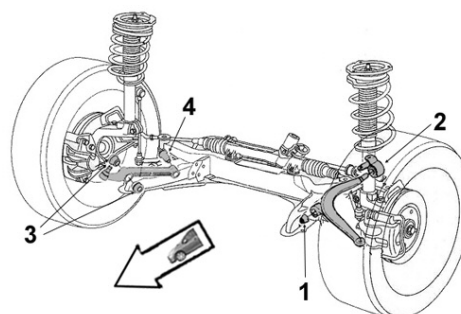

2256014 **Articulation AV**
 OE 46421522 *Front bush*



1 Ø int. 12 Ø ext. 30 coll. 44.5 long. tube int. 54.5 ext. 38

1.2i
 1.6i 16v.
 1.7 TD
 1.9 D

BVM
 BVM
 BVM
 BVM

03/98-12/05
 03/98-12/07
 03/98-09/00
 09/00-12/05

Bras & Triangle de suspension

Control arm
Brazo y triángulo
Wahacz
 Рычаг подвески

G/L D/R

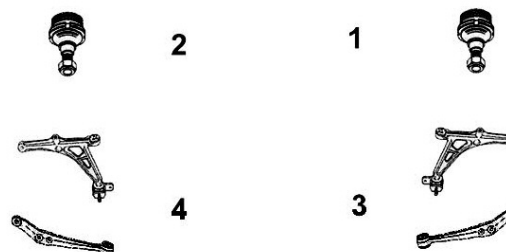

9005797 **Triangle de susp. inf. G**
 OE 46454597 *Lower left track control arm*



4 *Avec rotule With ball joint*

TT /all models DNA DA 01/96-12/01

9005796 **Triangle de susp. inf. D**
 OE 46454598 *Lower right track control arm*



3 *Avec rotule With ball joint*

TT /all models DNA DA 01/96-12/01

... Palio

FIAT



Panda ...

Eléments DIRECTION
Steering parts
Elementos Direcciones
Elementy układ kierowniczy
Элементы рулевой системы

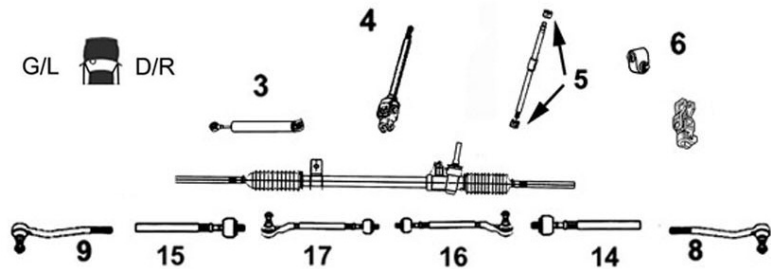

9006264

Axe de bielle G/D

Part/oe 5960321

L/R axial joint



14 Côté dir. M14x1.5 Côté rot. M12x1.5
 15 long 192 mm

TT /all models 10/82-12/03

7776022

Axe de bielle G/D

Part/oe 77362506

L/R axial joint



14 Côté dir. M14x1.5 Côté rot. M12x1.5
 15 long 230 mm

1.1i 09/03-
 1.2i /4WD 09/03-
 1.3 JTD /4WD 09/03-
 1.4i 16v. 10/06-

9006332

Rotule de direction G/D

OE 5960835

L/R tie rod end



8
 9 M12 x 1.5

TT /all models

10/82-12/03

9006441

Rotule de direction G

OE 77362507

Left tie rod end



9 M12 x 1.5

1.1i 8v. DA 01/03-
 1.2i 8v. DA BVM BV Rob. 01/03-
 1.3 JTD DA 01/03-
 1.4i 16v. 09/06-

9006440

Rotule de direction D

OE 77362508

Right tie rod end



8 M12 x 1.5

1.1i 8v. DA 01/03-
 1.2i 8v. DA BVM BV Rob. 01/03-
 1.3 JTD DA 01/03-
 1.4i 16v. 09/06-



Barre stabilisatrice

Stabilizer bar

Barra estabilizadora

Drażek stabilizatora

стабилизатор поперечной устойчивости

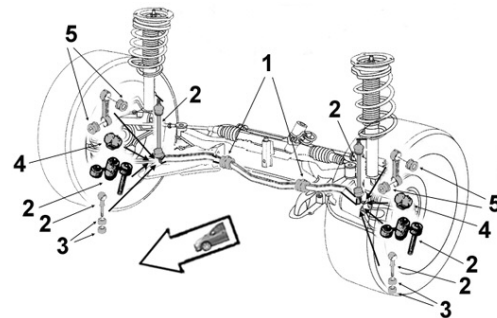

9001500

Liaison élastique

OE 4448132

Elastic link



3 Ø int.17 Ø ext.43 larg. 20

0.8
 1.0
 1.0 SPi

9005097

Biellette barre stab.

OE 51856872

Stabilizer bar stub axle



2

1.1i 8v. 09/03-
 1.2i 8v. /4WD /Van BVM 09/03-
 1.2i 8v. BV Rob. 09/03-
 1.3 JTD /4WD 04/04-

... Panda ...



Eléments SUSPENSION
Suspension parts
Elementos suspensión
Elementy zawieszenie
Элементы подвески

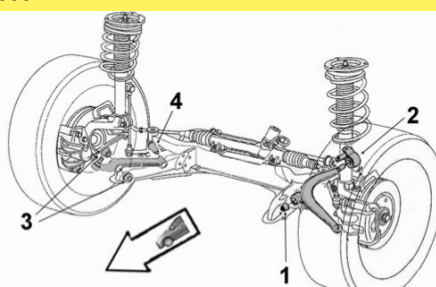

FIAT



2256012

Articulation AV

Part/oe 46545661

Front bush



1 Ø int. 12 Ø ext. 32.5 coll. 34.5 coll. 37 long. tube int.52.5 ext.39

1.1i
 1.2i /4WD
 1.3 JTD/4WD

BVM
 BVM
 BVM

10/00-
 09/03-
 04/04-

Bras & Triangle de suspension

Control arm
Brazo y triángulo
Wahacz
Рычаг подвески

G/L D/R



9005107

Bras de suspension G/D

OE 7601261

L/R track control arm



3 Sans rotule *Without tie rod end*

4

TT /all models

-12/03

7476032

Triangle de susp. G

OE 51857133

Left track control arm



4 Avec rotule *With ball joint*

1.1i 09/03-
 1.2i /4WD 09/03-
 1.3 JTD /4WD 04/04-

7476031

Triangle de susp. D

OE 51857134

Right track control arm



3 Avec rotule *With ball joint*

1.1i 09/03-
 1.2i /4WD 09/03-
 1.3 JTD /4WD 04/04-

7576001

Rotule de susp. inf. G/D

OE -

L/R lower suspension ball joint



1
2

TT /all models Sans support -12/03

9005230

Rotule de susp. inf. G/D

OE 4402649

L/R lower suspension ball joint



1
2

TT /all models Sans support -12/03

... Panda

SASIC

FIAT



Support d'amortisseur
Suspension mounting
Soporte amortiguador
Poduszka amortyzatora
Опора амортизатора

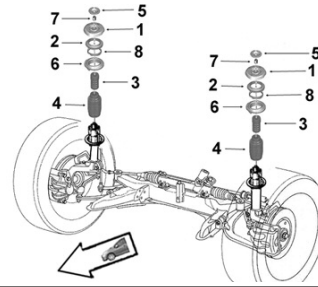

8005200

OE 4400895

Butée à billes G/D

L/R ball bearing

2 Ø 50 x 70 x 3.6

0.8
1.0
1.0 SPi
1.1

07/92-09/03



9005378

OE 4409263

Butée protecteur susp. G/D

L/R suspension bush

3
4

0.8
1.0
1.0 SPi

sauf 4WD
sauf 4WD



Punto ...

Eléments DIRECTION

Steering parts

Elementos Direcciones

Elementy układu kierowniczy

Элементы рулевой системы

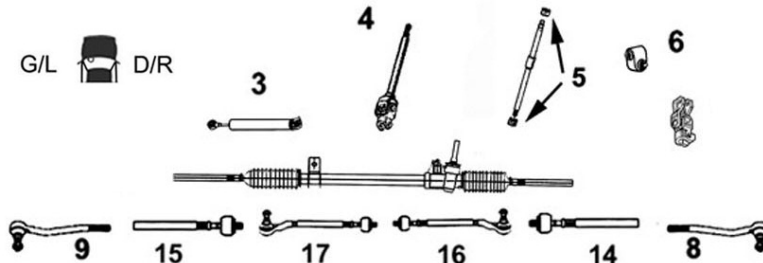

9006269

OE 9946948

Axe de bielle G/D

L/R axial joint

14 Côté dir. M14x1.25 Côté rot. M12x1.5
15 long 277 mm

TT /all models DNA 01/94-12/99



9006270

Part/oe 9945562

Axe de bielle G/D

L/R axial joint

14 Côté dir. M16x1.25 Côté rot. M12x1.5
15 long 271 mm

TT /all models DA 01/94-12/99



9006828

Part/oe 9948343

Axe de bielle G/D

L/R axial joint

14 Côté dir. M14x1.5 Côté rot. M12x1.5
15 long 280 mm

TT /all models 01/99-05/03



9006342

OE 9946949

Rotule de direction G/D

L/R tie rod end

8 M12 x 1.5
9

TT /all models 01/94-05/03
1.2 05/03-10/09
1.2i 16v. 05/03-09/04
1.3 JTD 05/03-10/09
1.4i 16v. 05/03-09/05
1.8i 16v. 05/03-09/04
1.9 JTD 05/03-09/05



7676014

OE 77363829

Rotule de direction G

Left tie rod end

9 M14 x 1.5

0.9i Turbo 01/12-
1.2i 01/12-
1.3 JTD 01/12-
1.4i 01/12-
1.4i Turbo 01/12-



7676013

OE 77363830

Rotule de direction D

Right tie rod end

8 M14 x 1.5

0.9i Turbo 01/12-
1.2i 01/12-
1.3 JTD 01/12-
1.4i 01/12-
1.4i Turbo 01/12-



... Punto ...

FIAT

SASIC

9004001

Axe de volant

OE 7736703

Steering wheel shaft



4

TT /all models essence DNA

01/94-12/99



Barre stabilatrice

Stabilizer bar

Barra estabilizadora

Drażek stabilizatora

стабилизатор поперечной устойчивости

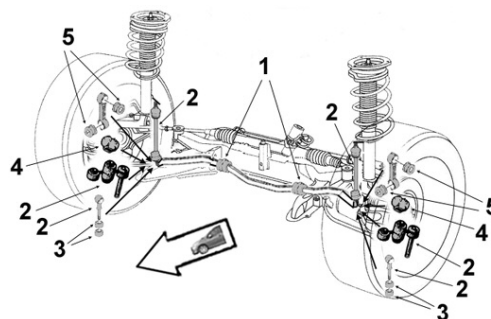

9001733

Palier de barre bout

OE 7750990

End bar main bearing



4

1.1 /SPi	01/93-12/99
1.2/i 16v. /SPi	01/93-
1.3 JTD	05/03-
1.4 GT /MPi turbo	01/93-
1.6i	01/93-12/97
1.7 D TD	01/93-12/99
1.8	05/03-09/04
1.9 JTD	05/03-09/05

9001736

Palier de barre milieu

OE 7750982

Middle bar main bearing



1

Barre Ø 21	
1.1 /SPi	01/93-12/99
1.2 /i 16v.	01/93-12/99
1.2 SPi	01/93-12/99
1.4 GT	01/93-12/99
1.4 MPi turbo	01/93-12/99
1.6i	01/93-12/97
1.7 D	01/93-12/99
1.7 TD	01/93-12/99



Eléments SUSPENSION

Suspension parts

Elementos suspensión

Elementy zawieszenie

Элементы подвески

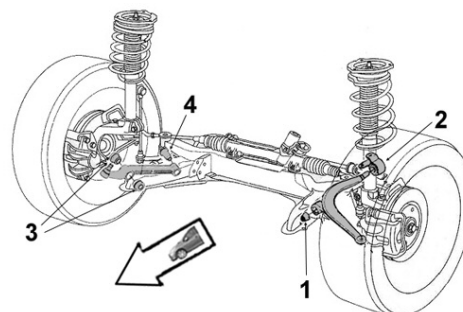

9001718

Articulation AR G

OE 7775343

Left rear bush



2

1.1 /SPi	01/93-09/99
1.2	01/93-09/99
1.2 SPi	01/93-09/99
1.2i 16v.	01/93-09/99
1.4 GT	01/93-09/99
1.4 MPi turbo	01/93-09/99
1.6i	01/93-12/97
1.7 D TD	01/93-09/99

9001715

Articulation AR D

OE 7775344

Right rear bush



2

1.1 /SPi	01/93-09/99
1.2	01/93-09/99
1.2 SPi	01/93-09/99
1.2i 16v.	01/93-09/99
1.4 GT	01/93-09/99
1.4 MPi turbo	01/93-09/99
1.6i	01/93-12/97
1.7 D TD	01/93-09/99

2256013

Articulation AR

Part/oe 46551790

Rear bush



2

**Ø int. 14.5 Ø ext. 61
long. tube int. 52 ext. 26**

1.2i		10/99-05/03
1.2i 16v.		10/99-05/03
1.8i 16v.	BVM	10/99-09/04
1.9 D	BVM	10/99-05/03
1.9 JTD	BVM	10/99-05/03

9001720

Articulation AV

OE 5927292

Front bush



1

**Ø int.12 Ø ext.32 coll.37
long. tube int.55 ext.40 ep. coll.6**

1.1		01/93-09/99
1.1 SPi		01/93-09/99
1.2		01/93-09/99
1.2i 16v.		01/93-09/99

... Punto ...



Eléments SUSPENSION

Suspension parts
Elementos suspensión
Elementy zawieszenie
Элементы подвески

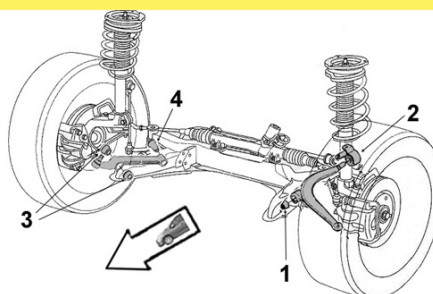

FIAT BASIC

9001720

Articulation AV

OE 5927292

Front bush

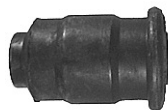

1 Ø int.12 Ø ext.32 coll.37
long. tube int.55 ext.40 ep. coll.6

1.2 SPi	01/93-09/99
1.4 GT	01/93-09/99
1.4 MPi turbo	01/93-09/99
1.6i	01/93-12/97
1.7 D	01/93-09/99
1.7 TD	01/93-09/99

2256012

Articulation AV

Part/oe 46545661

Front bush



1 Ø int. 12 Ø ext. 32.5 coll. 34.5 coll. 37
long. tube int.52.5 ext.39

1.2i		10/99-05/03
1.2i 16v.		10/99-05/03
1.8i 16v.	BVM	10/99-09/04
1.9 D	BVM	10/99-05/03
1.9 JTD	BVM	10/99-05/03

2256032

Articulation AV

Part/oe 51783057

Front bush



1 Ø int. 12.5 Ø ext. 42 coll. 43 coll. 50.5 long.tube int. 67.5 ext. 41

1.3 JTD	04/10-
1.4i	10/05-

Bras & Triangle de suspension

Control arm
Brazo y triángulo
Wahacz
Рычаг подвески

G/L D/R

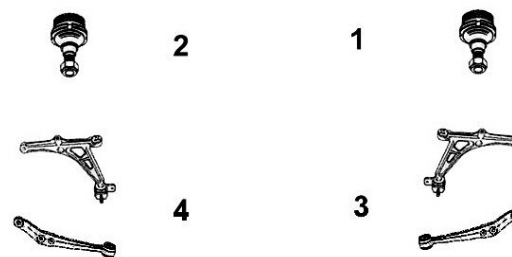

9005109

Triangle de susp. G

OE 46430002

Left track control arm



4 Avec rotule With ball joint

TT /all models Sauf 1400 01/94-09/99

9005108

Triangle de susp. D

OE 46430003

Right track control arm



3 Avec rotule With ball joint

TT /all models Sauf 1400 01/94-09/99

9005711

Triangle de susp. G

OE 51842192

Left track control arm



4 Avec rotule With ball joint

TT /all models Sauf 1.8 16v.	10/99-05/03
1.8i 16v.	03/02-05/03

9005712

Triangle de susp. D

OE 51842193

Right track control arm











3 Avec rotule With ball joint

TT /all models Sauf 1.8 16v.	10/99-05/03
1.8i 16v.	03/02-05/03

... Punto ...

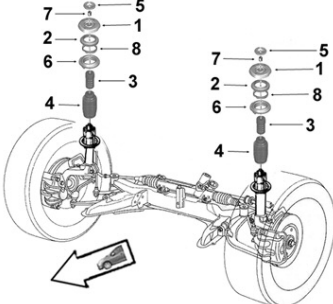
FIAT

SASIC

9005794		Triangle de susp. inf. G	
OE 51839219		<i>Lower left track control arm</i>	
	4 Avec rotule <i>With ball joint</i>		
	1.2i /Bipower /GNV/16v	05/03-09/04	
	1.3 JTD	05/03-10/09	
	1.4i 16v.	05/03-09/05	
	1.9 JTD /Van	05/03-09/05	
9005793		Triangle de susp. inf. D	
OE 51839218		<i>Lower right track control arm</i>	
	3 Avec rotule <i>With ball joint</i>		
	1.2i /Bipower /GNV/16v	05/03-09/04	
	1.3 JTD	05/03-10/09	
	1.4i 16v.	05/03-09/05	
	1.9 JTD /Van	05/03-09/05	
7570004		Rotule de susp. inf. G/D	
Part/oe 51895367		<i>L/R lower suspension ball joint</i>	
	1		
	0.9i Turbo Twinair	01/12-	
	1.2i	01/12-	
	1.3 JTD FAP	01/12-	
	1.4i /GNV /GPL	01/12-	
	1.4i Turbo	01/12-	
			
Support d'amortisseur			
<i>Suspension mounting</i>			
<i>Soporte amortiguador</i>			
<i>Poduszka amortyzatora</i>			
<i>Опора амортизатора</i>			
9005602		Support suspension G/D	
OE 7775940		<i>L/R suspension mounting</i>	
	1 Avec roulement <i>With bearing</i>		
	1.1 / SPi	01/93-12/99	
	1.2 /SPi /i 16v.	01/93-12/99	
	1.4 GT /MPi Turbo	01/93-12/99	
	1.6i	01/93-12/97	
	1.7 D	01/93-12/99	
	1.7 TD	01/93-12/99	
9005372		Butée protecteur susp. G/D	
OE 7762158		<i>L/R suspension bush</i>	
	3		
	4		
	1.1 /SPi	01/93-12/99	
	1.2 /SPi	01/93-12/99	
	1.2i 16v.	01/93-12/99	
	1.6i	01/93-12/97	
9005371		Butée protecteur susp. G/D	
OE 7757917		<i>L/R suspension bush</i>	
	3		
	4		
	1.4 GT	01/93-12/99	
	1.4 MPi Turbo	01/93-12/99	
	1.7 D	01/93-12/99	
	1.7 TD	01/93-12/99	
2650025		Butée de suspension G/D	
OE 51866009		<i>L/R suspension bush</i>	
	3		
	1.3 JTD	10/05-	
	1.4i	10/05-	

... Punto

SASIC

FIAT

Eléments TRAIN ARRIERE

Rear axle parts

Tren TRAS

Elementy zawieszenia tylnego

элементы задней оси.

G/L  D/R



2

1



9005713

OE 7736514

Bras AR G

Left rear arm



2

TT /all models 01/94-12/99 sans ABS

9005714

OE 7736515

Bras AR D

Right rear arm



1

TT /all models 01/94-12/99 sans ABS

9005152

OE 7769900

Bras AR G

Left rear arm



2

TT /all models 01/94-12/99 ABS

9005153

OE 7769901

Bras AR D

Right rear arm



1

TT /all models 01/94-12/99 ABS



Support d'amortisseur

Suspension mounting

Soporte amortiguador

Poduszka amortyzatora

Опора амортизатора

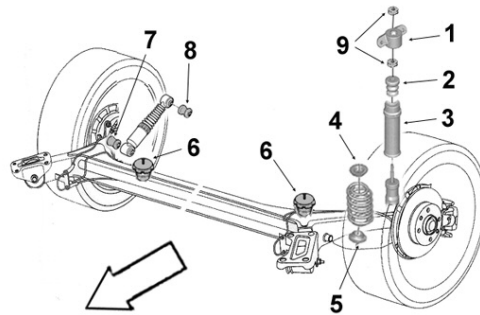

2656041

OE 55701902

Support suspension G

Left suspension mounting



1

1.2i

169A4000

BVM5

01/12-

2656040

OE 55701901

Support suspension D

Right suspension mounting



1

1.2i

169A4000

BVM5

01/12-

Grande Punto ...

Eléments DIRECTION

Steering parts

Elementos Direcciones

Elementy układ kierowniczy

Элементы рулевой системы

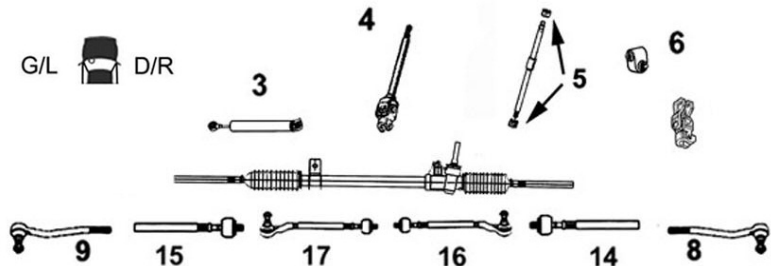

7776038

Axe de bielle G/D

OE -

L/R axial joint



14
15

Côté dir. M14x1.5 Côté rot. M14x1.5 long 293 mm

1.2i	09/05-
1.3 JTD	09/05-
1.4i	09/05-
1.4i Turbo Multiair	09/05-
1.9 JTD	09/05-

09/05-
09/05-
09/05-
09/05-
09/05-

7676014

Rotule de direction G

OE 77363829

Left tie rod end



9

M14 x 1.5

1.2i	09/05-
1.3 JTD /FAP	09/05-
1.4i	09/05-
1.4i 16v.	06/06-
1.4i Turbo	05/07-
1.6 JTD FAP	10/08-
1.9 JTD	09/05-

7676013

Rotule de direction D

OE 77363830

Right tie rod end



8

M14 x 1.5

1.2i	09/05-
1.3 JTD /FAP	09/05-
1.4i	09/05-
1.4i 16v.	06/06-
1.4i Turbo	05/07-
1.6 JTD FAP	10/08-
1.9 JTD	09/05-



Barre stabilisatrice

Stabilizer bar

Barra estabilizadora

Drażek stabilizatora

стабилизатор поперечной устойчивости

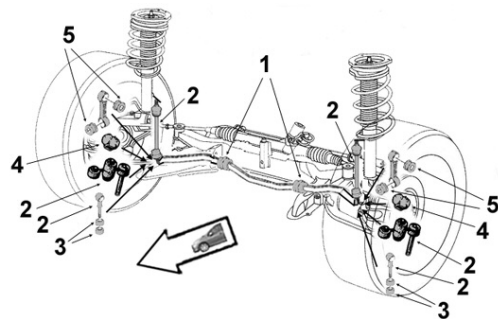

2306023

Biellette barre stab.

OE 55700753

Stabilizer bar stub axle



2

1.2i	09/05-
1.3 JTD FAP /Dualogic	09/05-
1.4i /Dualogic	09/05-
1.4i 16v.	06/06-
1.4i Turbo	05/07-
1.6 JTD FAP	10/08-
1.9 JTD	09/05-

09/05-
09/05-
09/05-
06/06-
05/07-
10/08-
09/05-

... Grande Punto ...



Eléments SUSPENSION
Suspension parts
Elementos suspensión
Elementy zawieszenie
Элементы подвески

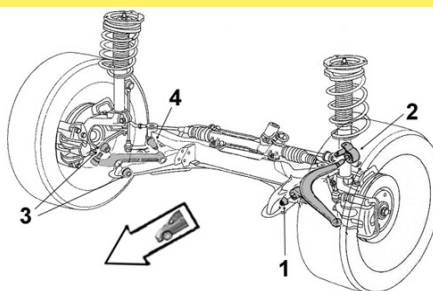

FIAT

2256009

Articulation AR

Part/oe 51783057

Rear bush



2 Ø int. 12.5 Ø ext. 73
 long. tube int. 66 ext. 27.5

1.2i	09/05-
1.3 JTD FAP /Dualogic	09/05-
1.4i /Dualogic	06/06-
1.4i 16v.	06/06-
1.4i Turbo	05/07-
1.9 JTD	09/05-

2256032

Articulation AV

Part/oe 51783057

Front bush



1 Ø int. 12.5 Ø ext. 42 coll. 43 coll. 50.5
 long. tube int. 67.5 ext. 41

1.2i	09/05-
1.3 JTD FAP /Dualogic	09/05-
1.3 JTD FAP	06/06-
1.4i /Dualogic /16v.	06/06-
1.4i Turbo	05/07-
1.9 JTD	09/05-

7470005

Triangle de susp. G

OE 51895367

Left track control arm



4 Avec rotule With ball joint

1.2i	09/05-
1.3 JTD	09/05-
1.4i	09/05-
1.4i 16v.	09/05-
1.4i 16v.Turbo	09/07-
1.6 JTD	10/08-12/11
1.9 JTD	09/05-

7470006

Triangle de susp. D

OE 51895366

Right track control arm



3 Avec rotule With ball joint

1.2i	09/05-
1.3 JTD	09/05-
1.4i	09/05-
1.4i 16v.	09/05-
1.4i 16v.Turbo	09/07-
1.6 JTD	10/08-12/11
1.9 JTD	09/05-

7570004

Rotule de susp. inf. G/D

Part/oe 51895367

L/R lower suspension ball joint



1
2

1.2i	09/05-
1.3 JTD	09/05-
1.4i	09/05-
1.4i 16v.	09/05-
1.4i 16v.Turbo	09/07-
1.9 JTD	09/05-



Support d'amortisseur
Suspension mounting
Soporte amortiguador
Poduszka amortyzatora
Опора амортизатора

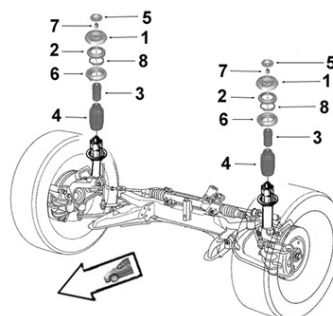

2650025

Butée de suspension G/D

OE 51866009

L/R suspension bush



3

1.2i	-ch VE 1446198 / -VE 439053	09/05-
1.3 JTD/Dualogic / FAP		06/06-
1.4i /GPL		09/05-
1.4i 16v. / Dualogic		06/06-
1.4i GNV		10/08-
1.4i Turbo		05/07-
1.6 JTD FAP		10/08-
1.9 JTD		09/05-

... Grande Punto



Support d'amortisseur
 Suspension mounting
 Soporte amortiguador
 Poduszka amortyzatora
 Опора амортизатора

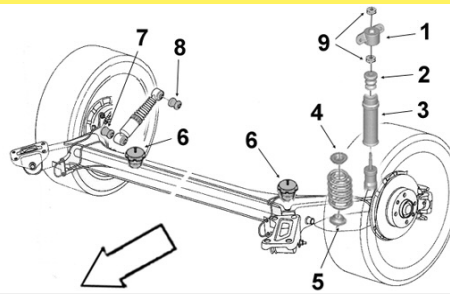

2656041

Support suspension G

OE 55701902

Left suspension mounting



1

1.2i	09/05-12/11
1.3 JTD /FAP	09/05-12/11
1.4i /GPL Dualogic /GNV	
1.4i 16v.	06/06-12/11
1.4i Turbo	05/07-12/11
1.6 JTD FAP	10/08-12/11
1.9 JTD	09/05-12/11

2656040

Support suspension D

OE 55701901

Right suspension mounting



1

1.2i	09/05-12/11
1.3 JTD /FAP	09/05-12/11
1.4i /GPL Dualogic /GNV	
1.4i 16v.	06/06-12/11
1.4i Turbo	05/07-12/11
1.6 JTD FAP	10/08-12/11
1.9 JTD	09/05-12/11

Eléments TRAIN ARRIERE

Rear axle parts

Tren TRAS

Elementy zawieszenia tylnego

элементы задней оси.



2606003

Articulation essieu AR

OE 51804551

Rear axle bush



Ø int.12 Ø ext.69 coll.81 long. tube int. 100 ext. 65 ep coll. 12

1.2i	199A4000	BVM 5	09/05-12/11
1.3 JTD	199A2000/3000/9000	223A9000	09/05-12/11
1.4i	350A1000		09/05-12/11
1.4i 16v.	199A6000	BVM 6	06/06-12/11
1.4i Turbo	198A4000	BVM 5	05/07-12/11
1.6 JTD FAP	955A3000	BVM 6	10/08-12/11
1.9 JTD	199A5000 939A1000	BVM 6	09/05-12/11

Punto Evo ...

SASIC

FIAT

Eléments DIRECTION
Steering parts
Elementos Direcciones
Elementy uklad kierowniczy
Элементы рулевой системы

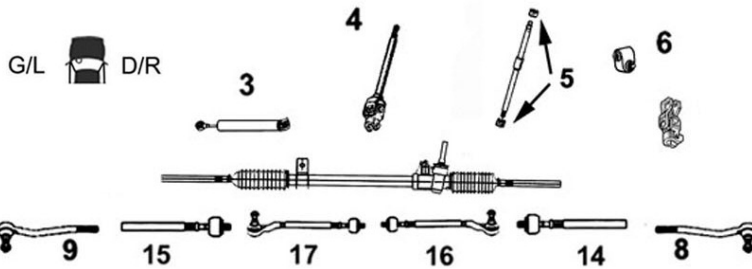

7776038 **Axe de bielle G/D**
 OE - *L/R axial joint*



14 Côté dir. M14x1.5 Côté rot. M14x1.5 long 293 mm
15

1.2i	10/09-
1.3 JTD	10/09-
1.4i	10/09-
1.4i Turbo Multiair	10/09-
1.6 JTD	10/09-

7676014 **Rotule de direction G**
 OE 77363829 *Left tie rod end*



9 M14 x 1.5

1.2i	10/09-
1.3 JTD	10/09-
1.4i	10/09-
1.4i Turbo Multiair	10/09-
1.6 JTD	10/09-

7676013 **Rotule de direction D**
 OE 77363830 *Right tie rod end*



8 M14 x 1.5

1.2i	10/09-
1.3 JTD	10/09-
1.4i	10/09-
1.4i Turbo Multiair	10/09-
1.6 JTD	10/09-



Barre stabilisatrice
Stabilizer bar
Barra estabilizadora
Drażek stabilizatora
 стабилизатор поперечной устойчивости

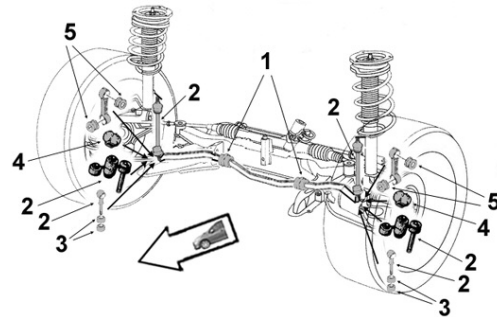

2306023 **Bielle barre stab.**
 OE 55700753 *Stabilizer bar stub axle*



2

1.2i	10/09-
1.3 JTD	10/09-
1.4i /GNV	10/09-
1.4i Turbo Multiair	10/09-
1.6 JTD	10/09-

... Punto Evo ...



Eléments SUSPENSION
Suspension parts
Elementos suspensión
Elementy zawieszenie
Элементы подвески

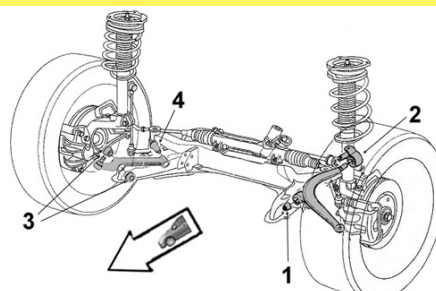

FIAT



2256032 Articulation AV

Part/oe 51783057 *Front bush*



1 Ø int. 12.5 Ø ext. 42 coll. 43 coll. 50.5 long.tube int. 67.5 ext. 41

1.2i	10/09-
1.3 JTD	09/10-
1.4i /GNV	10/09-
1.4i Turbo Multiair	10/09-
1.6 JTD	10/09-

Bras & Triangle de suspension

Control arm
Brazo y triángulo
Wahacz
Рычаг подвески

G/L D/R

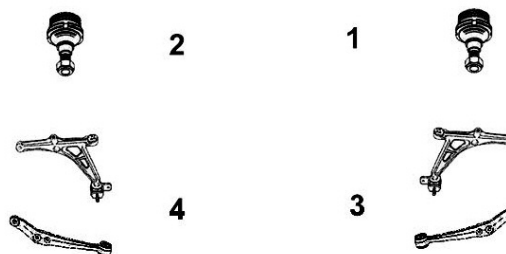

7470005 Triangle de susp. G

OE 51895367 *Left track control arm*



4 Avec rotule With ball joint

1.2	09/09-
1.3 JTD	09/09-
1.4i	09/09-
1.4i 16v. Turbo	09/09-
1.6 JTD	09/09-

7470006 Triangle de susp. D

OE 51895366 *Right track control arm*



3 Avec rotule With ball joint

1.2	09/09-
1.3 JTD	09/09-
1.4i	09/09-
1.4i 16v. Turbo	09/09-
1.6 JTD	09/09-

7570004 Rotule de susp. inf. G/D

Part/oe 51895367 *L/R lower suspension ball joint*



1
2

1.2	09/09-
1.3 JTD	09/09-
1.4i	09/09-
1.4i 16v. Turbo	09/09-
1.6 JTD	09/09-

... Punto Evo

SASIC



Support d'amortisseur
 Suspension mounting
 Soporte amortiguador
 Poduszka amortyzatora
 Опора амортизатора

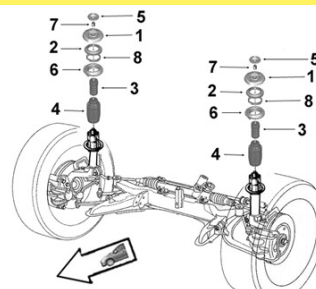

2650025

Butée de suspension G/D

OE 51866009

L/R suspension bush



3

1.3 JTD	10/09-
1.4i /GNV	10/09-
1.4i Turbo Multiair	10/09-
1.6 JTD	10/09-

FIAT



Support d'amortisseur
 Suspension mounting
 Soporte amortiguador
 Poduszka amortyzatora
 Опора амортизатора

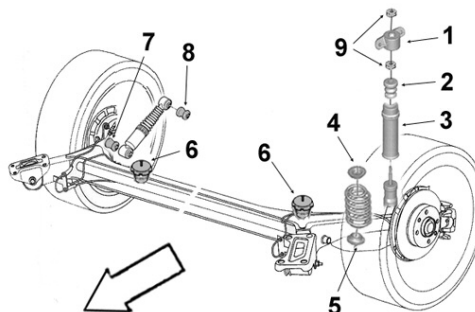

2656041

Support suspension G

OE 55701902

Left suspension mounting



1

1.2i	199A4000	BVM5	10/09-
1.2i	169A4000	BVM5	11/10-

2656040

Support suspension D

OE 55701901

Right suspension mounting



1

1.2i	199A4000	BVM5	10/09-
1.2i	169A4000	BVM5	11/10-

Eléments TRAIN ARRIERE

Rear axle parts

Tren TRAS

Elementy zawieszenia tylnego

элементы задней оси.



2606003

Articulation essieu AR

OE 51804551

Rear axle bush



Ø int.12 Ø ext.69 coll.81 long. tube int. 100 ext. 65 ep coll. 12			
1.2i	169A4000	199A4000	BVM 5 10/09-
1.3 JTD	199A2000	/9000	BVM 5 10/09-
1.3 JTD	199B4000		BVM 5 09/10-
1.3 JTD FAP	199B1000		10/09-
1.4i	350A1000		BVM 5 10/09-
1.4i	955A6000		BVM 6 10/09-
1.4i Turbo	955A2000		BVM 5 10/09-
1.6 JTD	955A3000		BVM 6 10/09-

Qubo ...

Eléments DIRECTION

Steering parts

Elementos Direcciones

Elementy układ kierowniczy

Элементы рулевой системы

G/L  D/R

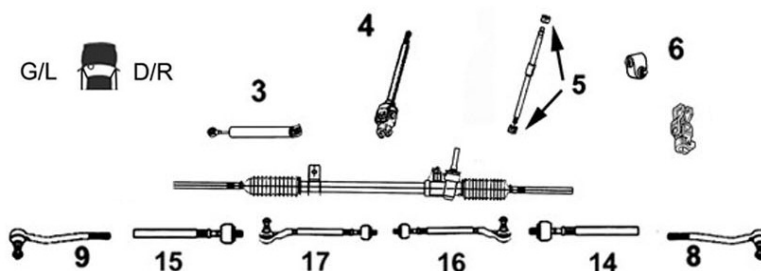

7670008

Rotule de direction G

OE 77364568

Left tie rod end



9 M14 x 1.5

1.3 JTD
1.4i

09/08-
09/08-

7670009

Rotule de direction D

OE 77364569

Right tie rod end



8 M14 x 1.5

1.3 JTD
1.4i

09/08-
09/08-



Barre stabilisatrice

Stabilizer bar

Barra estabilizadora

Drążek stabilizatora

стабилизатор поперечной устойчивости

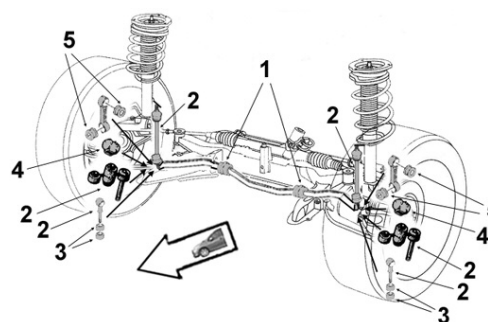

2300029

Biellette barre stab.

OE 51815479

Stabilizer bar stub axle



2

1.3 JTD
1.4

09/08-
09/08-

2300043

Palier de barre milieu

OE 51785487

Middle bar main bearing



1 Barre Ø 20

1.3 JTD 199A2000
1.4i TU3A/JP

-01/01/08
-01/01/08

2300041

Palier de barre milieu

OE 51785488

Middle bar main bearing



1 Barre Ø 21

1.3 JTD 199A2000
1.4i TU3A/JP

01/01/08-
01/01/08-

... Qubo ...



Eléments SUSPENSION
Suspension parts
Elementos suspensión
Elementy zawieszenie
Элементы подвески

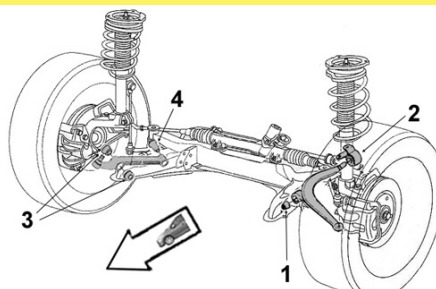

2256009 Articulation AR

Part/oe 51783057 *Rear bush*



2 Ø int. 12.5 Ø ext. 73 long. tube int. 66 ext. 27.5

1.3 JTD 09/08-
 1.4 09/08-

2256032 Articulation AV

Part/oe 51783057 *Front bush*



1 Ø int. 12.5 Ø ext. 42 coll. 43 coll. 50.5 long. tube int. 67.5 ext. 41

1.3 JTD 09/08-
 1.4 09/08-

Bras & Triangle de suspension

Control arm
Brazo y triángulo
Wahacz
Рычаг подвески

G/L D/R

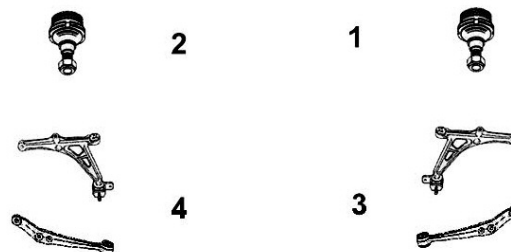

7470005 Triangle de susp. G

OE 51895367 *Left track control arm*



4 Avec rotule With ball joint

1.3 JTD 09/08-
 1.4 09/08-

7470006 Triangle de susp. D

OE 51895366 *Right track control arm*



3 Avec rotule With ball joint

1.3 JTD 09/08-
 1.4 09/08-

7570004 Rotule de susp. inf. G/D

Part/oe 51895367 *L/R lower suspension ball joint*



1/2

1.3 JTD 09/08-
 1.4 09/08-

... Qubo



Support d'amortisseur
 Suspension mounting
 Soporte amortiguador
 Poduszka amortyzatora
 Опора амортизатора

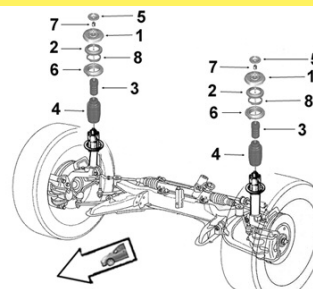

FIAT



2650031 OE 51963725	Support suspension G <i>Left suspension mounting</i>	2650032 OE 51963726	Support suspension D <i>Right suspension mounting</i>
1		1	
	1.3 JTD 1.4 09/08- 09/08-		1.3 JTD 1.4 09/08- 09/08-
2650025 OE 51866009			
Butée de suspension G/D <i>L/R suspension bush</i>			
3			
	1.3 JTD 1.4 09/08- 09/08-		
Eléments TRAIN ARRIERE <i>Rear axle parts</i> <i>Tren TRAS</i> <i>Elementy zawieszenia tylnego</i> <i>элементы задней оси.</i>			
		2600012 OE 51783623	Articulation essieu <i>Axle bush</i>
			Ø int. 13 Ø ext. 69 coll. 80 long. tube int.94 ext. 100 ep. coll. 2.5
			1.3 JTD 199A2000 1.4i TU3A/JP

Regata ...

Eléments DIRECTION
 Steering parts
 Elementos Direcciones
 Elementy układ kierowniczy
 Элементы рулевой системы

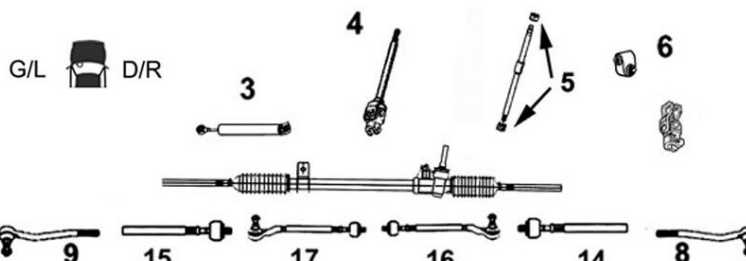

9006262 OE 7633721	Axe de bielle G/D <i>L/R axial joint</i>	9006265 OE 9939038	Axe de bielle G/D <i>L/R axial joint</i>
14 15	Côté dir. M14x1.5 Côté rot. M12x1.5 long 275 mm	14 15	Côté dir. M14x1.5 Côté rot. M12x1.5 long 277 mm
	TT /all models DNA		TT /all models DA

... Regata

Eléments DIRECTION

Steering parts

Elementos Direcciones

Elementy układ kierowniczy

Элементы рулевой системы

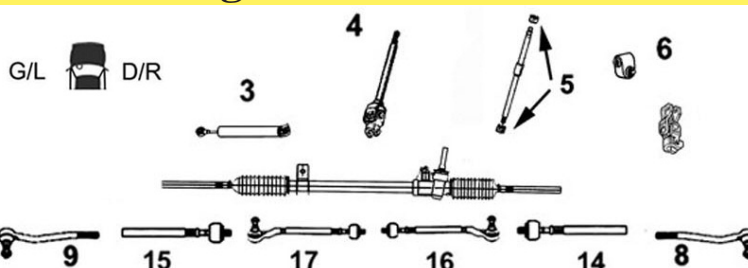

9006333

Rotule de direction G/D

OE 7669756

L/R tie rod end

8
9

M12 x 1.5

TT /all models

Bras & Triangle de suspension

Control arm

Brazo y triángulo

Wahacz

Рычаг подвески

G/L D/R

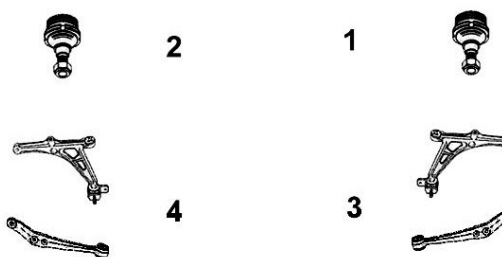

9005102

Bras de suspension G/D

OE 7558962

L/R track control arm

3
4

Avec rotule With ball joint

TT /all models Sauf 125/130 TC

Ritmo ...

Eléments DIRECTION

Steering parts

Elementos Direcciones

Elementy układ kierowniczy

Элементы рулевой системы

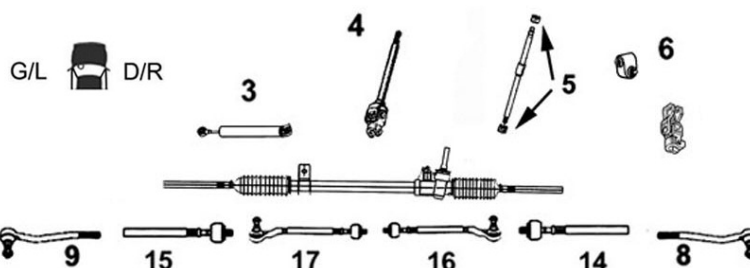

9006262

Axe de bielle G/D

OE 7633721

L/R axial joint

14
15Côté dir. M14x1.5 Côté rot. M12x1.5
long 275 mmTT /all models
Avec amortissement de dir. 01/82-

9006333

Rotule de direction G/D

OE 7669756

L/R tie rod end

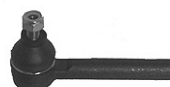
8
9

M12 x 1.5

TT /all models

01/82-

...Ritmo

Bras & Triangle de suspension

Control arm
Brazo y triángulo
Wahacz
Рычаг подвески

G/L  D/R

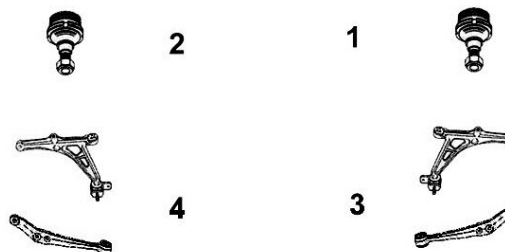

9005102

Bras de suspension G/D

OE 7558962

L/R track control arm

3 Avec rotule With ball joint

4



TT /all models Sauf 125/130 TC

01/82-

Seicento

Eléments DIRECTION

Steering parts
Elementos Direcciones
Elementy układ kierowniczy
Элементы рулевой системы

G/L  D/R

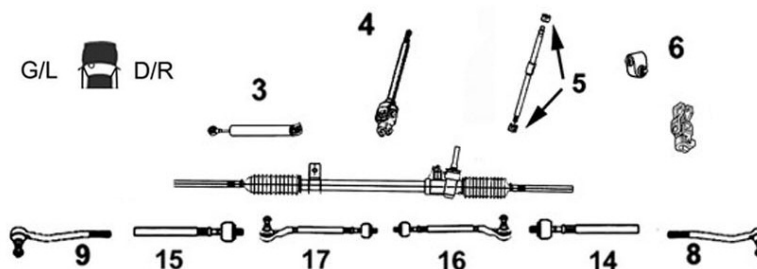

9006333

Rotule de direction G/D

OE 7669756

L/R tie rod end

8 M12 x 1.5

9



TT /all models DNA



Eléments SUSPENSION

Suspension parts
Elementos suspensión
Elementy zawieszenie
Элементы подвески

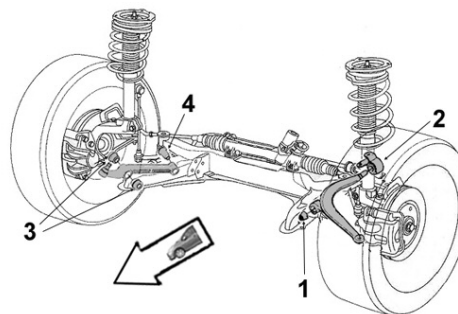

9001738

Articulation AR

OE 5927293

Rear bush

2



0.9
1.1

03/98-09/00
09/98-09/00

9001720

Articulation AV

OE 5927292

Front bush

1 Ø int.12 Ø ext.32 coll.37
long. tube int.55 ext.40 ep. coll.6



0.9
1.1

03/98-09/00
09/98-09/00

Stilo ...

Eléments DIRECTION

Steering parts
Elementos Direcciones
Elementy układ kierowniczy
Элементы рулевой системы

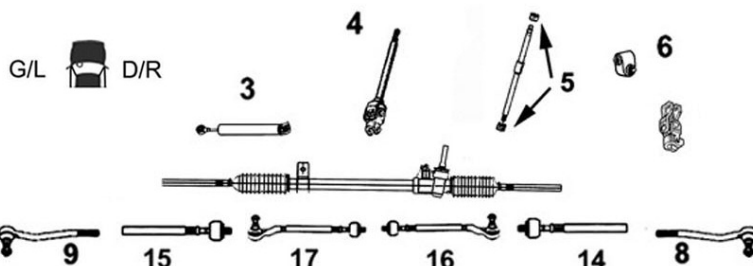

9006833

Axe de bielle G/D

Part/oe 9949217

L/R axial joint

14 Côté dir. M14x1.5 Côté rot. M14x1.5
15 long 315 mm



1.2i 16v.	01/01-12/03
1.6i 16v.	01/01-12/03
1.8i 16v.	01/01-12/03
1.9 JTD 80hp 59kw 115hp 85kw	01/01-12/03
2.4i 20v.	01/01-12/03

9006444

Rotule de direction G/D

OE 9949218

L/R tie rod end

8 M14 x 1.5
9



1.2i 16v.	01/01-
1.4i 16v.	01/04-
1.6i 16v.	01/01-
1.8i 16v.	01/01-
1.9 JTD	01/01-
2.4i 20v.	01/01-



Barre stabilisatrice

Stabilizer bar
Barra estabilizadora
Drażek stabilizatora
стабилизатор поперечной устойчивости

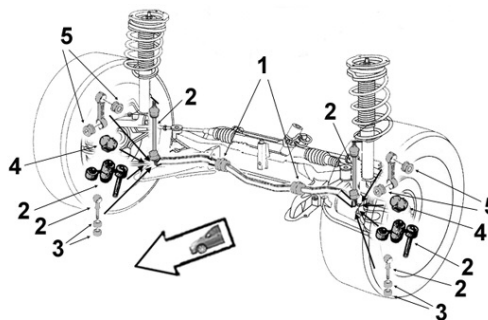

9005099

Biellette barre stab.

OE 51801136

Stabilizer bar stub axle

2



1.2i 16v.	10/01-12/02
1.4i 16v./Break	01/04-09/07
1.6i 16v./Break	10/01-
1.8i 16v./Break	10/01-
1.9 JTD /Break	10/01-
2.4 20v.	10/01-



Eléments SUSPENSION

Suspension parts
Elementos suspensión
Elementy zawieszenie
Элементы подвески

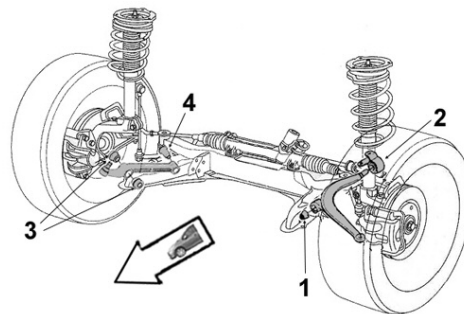

9001767

Articulation AR

OE 50700443

Rear bush

2 Ø int.12.5 Ø ext.42.1 coll.43.6 x1 51.7 x1
long. tube int.67.6 ext.59 ep. coll.4x1 7.4x1



1.2i 16v.	10/01-12/02
1.6i 16v.	10/01-12/03
1.8i 16v.	10/01-12/03
1.9 JTD	10/01-12/03
2.4 20v.	10/01-12/03

9001723

Articulation AV

OE 50700778

Front bush

1 Ø int.12.5 Ø ext.60.2
long. tube int.64.7 ext.20.7



1.2i 16v.	10/01-12/02
1.6i 16v.	10/01-12/03
1.8i 16v.	10/01-12/03
1.9 JTD	10/01-12/03
2.4 20v.	10/01-12/03

... Stilo

Bras & Triangle de suspension

Control arm
Brazo y triángulo
Wahacz
Рычаг подвески

G/L  D/R

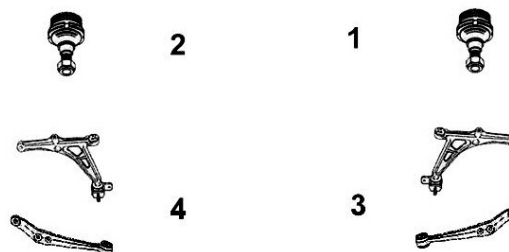

7476178

OE 51827736

Triangle de susp. G

Left track control arm

4 Avec rotule With ball joint Ø 17

NEW



1.2i 16v.	10/01-09/07
1.4i 16v./Break	01/04-09/07
1.6i 16v./Break	10/01-09/07
1.8i 16v./Break	10/01-09/07
1.9 JTD /Break	10/01-09/07
1.9 JTD /Break	01/04-09/07
2.4i 20v.	10/01-09/07

7476177

OE 51827738

Triangle de susp. D

Right track control arm

3 Avec rotule With ball joint Ø 17

NEW



1.2i 16v.	10/01-09/07
1.4i 16v./Break	01/04-09/07
1.6i 16v./Break	10/01-09/07
1.8i 16v./Break	10/01-09/07
1.9 JTD /Break	10/01-09/07
1.9 JTD /Break	01/04-09/07
2.4i 20v.	10/01-09/07

Eléments TRAIN ARRIERE

Rear axle parts

Tren TRAS

Elementy zawieszenia tylnego

элементы задней оси.



2606002

OE 50702649

Articulation essieu G/D

L/R axle bush

Ø int. 13 Ø ext. 67.5 coll. 80.5
long. tube int. 100 ext. 65 ep coll. 16



1.2i 16v.	10/01-09/07
1.4i 16v.	01/04-09/07
1.6i 16v.	10/01-09/07
1.8i 16v.	10/01-09/07
1.9 JTD	10/01-09/07
2.4i 20v.	10/01-09/07

Tempra ...

Eléments DIRECTION

Steering parts

Elementos Direcciones

Elementy układ kierowniczy

Элементы рулевой системы

G/L  D/R

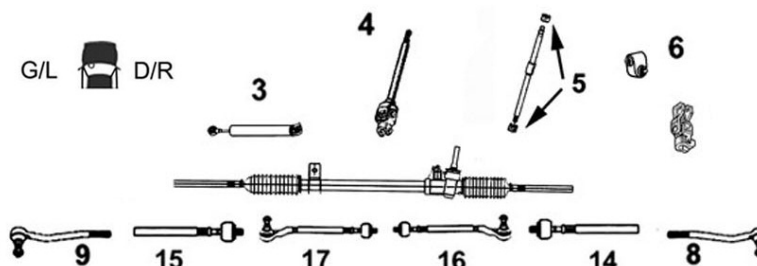

9006262

OE 7633721

Axe de bielle G/D

L/R axial joint

14 Côté dir. M14x1.5 Côté rot. M12x1.5
15 long 275 mm



TT /all models DNA

9006271

OE 9941625

Axe de bielle G/D

L/R axial joint

14 Côté dir. M14x1.5 Côté rot. M12x1.5
15 long 265 mm



TT /all models DA

9006334

OE 9947437

Rotule de direction G

Left tie rod end

9 M12 x 1.5



TT /all models

9006335

OE 9947436

Rotule de direction D

Right tie rod end

8 M12 x 1.5



TT /all models

... Tempra ...





SASIC

FIAT

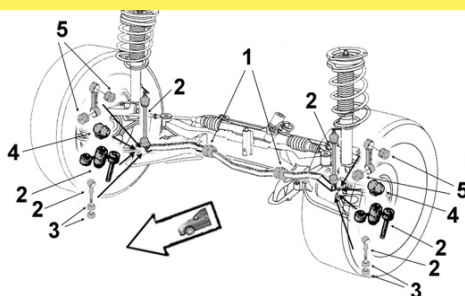

Barre stabilisatrice
Stabilizer bar
Barra estabilizadora
Drażek stabilizatora
 стабилизатор поперечной устойчивости

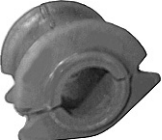



9001502 OE 7601642	Liaison élastique <i>Elastic link</i>	9005082 OE 60570627	Biellette barre stab. <i>Stabilizer bar stub axle</i>
	3 Ø int.10.4 Ø ext.30.5 long. tube int.15.5 ext.17.5 1.4 1.6 1.8ie 16v. 1.9 D 1.9 TDS 2.0		2 1.4 06/90-12/92 1.4i /ie /Break 01/93- 1.6 /Break 06/90- 1.6i /ie Break 07/92-09/96 1.8ie 16v. /Break 06/90- 1.9 D /TDS /Break 01/93- 2.0 01/93- 2.0ie 4WD Break 02/92-06/93
9001729 OE 7760425	Palier de barre milieu <i>Middle bar main bearing</i>	9001728 OE 7760424	Palier de barre milieu <i>Middle bar main bearing</i>
	1 Barre Ø 22 1.4 1.6 1.8ie 16v. 1.9 D 1.9 TDS 2.0		1 Barre Ø 23 1.4i /Break 1.6 i /ie /Break 1.8ie 16v. /Break 1.9 D 1.9 TDS 1.9 TDS /Break 2.0 2.0ie 4WD Break

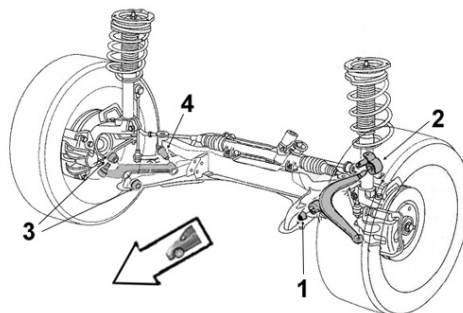

Eléments SUSPENSION
Suspension parts
Elementos suspensión
Elementy zawieszenie
 Элементы подвески



9001717 OE 7601065	Articulation AR G <i>Left rear bush</i>	9001714 OE 7601068	Articulation AR D <i>Right rear bush</i>
	2 Ø 21 1.4 1.6 1.8ie 16v. 1.9 D 1.9 TDS 2.0		2 Ø 21 1.4 1.6 1.8ie 16v. 1.9 D 1.9 TDS 2.0
9001722 OE 7601064	Articulation AV <i>Front bush</i>		
	1 Ø 21 1.4 1.6 1.8ie 16v. 1.9 D 1.9 TDS 2.0		

... Tempra ...

Bras & Triangle de suspension

Control arm
Brazo y triángulo
Wahacz
Рычаг подвески

G/L  D/R

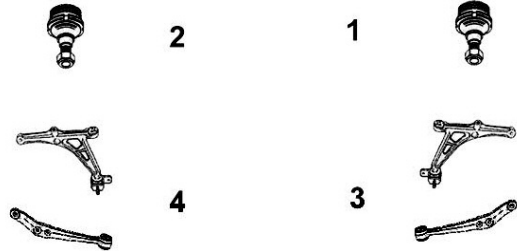

FIAT



... Tempra

Eléments TRAIN ARRIERE

Rear axle parts

Tren TRAS

Elementy zawieszenia tylnego

элементы задней оси.

**9001726**

OE 7693020

Articulation essieu AR

Rear axle bush



1.4
1.6
1.8ie 16v.
1.9 D
1.9 TDS
2.0

Tipo ...

Eléments DIRECTION

Steering parts

Elementos Direcciones

Elementy układ kierowniczy

Элементы рулевой системы

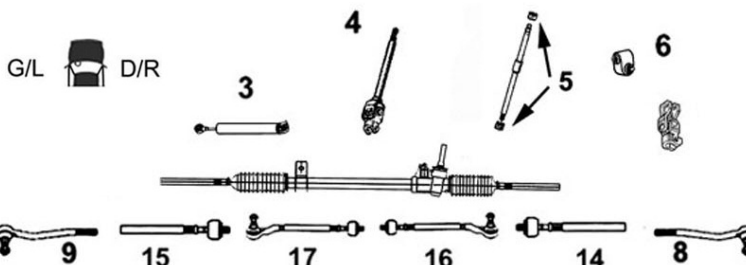
**9006262**

OE 7633721

Axe de bielle G/D

L/R axial joint



14 Côté dir. M14x1.5 Côté rot. M12x1.5
15 long 275 mm

TT /all models DNA 01/88-

9006271

OE 9941625

Axe de bielle G/D

L/R axial joint



14 Côté dir. M14x1.5 Côté rot. M12x1.5
15 long 265 mm

TT /all models DA 01/88-

9006334

OE 9947437

Rotule de direction G

Left tie rod end



9 M12 x 1.5

TT /all models 01/88-

9006335

OE 9947438

Rotule de direction D

Right tie rod end



8 M12 x 1.5

TT /all models 01/88-

**Barre stabilisatrice**

Stabilizer bar

Barra estabilizadora

Drażek stabilizatora

стабилизатор поперечной устойчивости

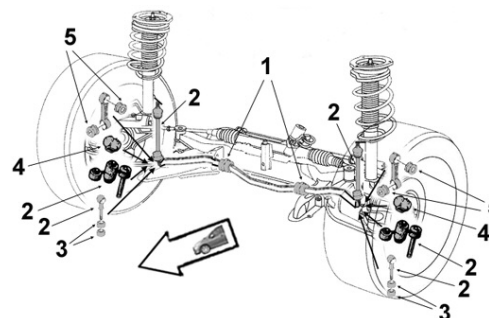
**9001502**

OE 7601642

Liaison élastique

Elastic link



3 Ø int.10.4 Ø ext.30.5 long. tube int.15.5
ext.17.5

1.1
1.4
1.6
1.7 D
1.8
1.9 D TD
2.0

9005082

OE 60570627

Biellette barre stab.

Stabilizer bar stub axle









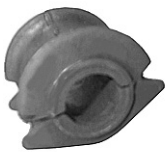

2

1.1 01/93-
1.4 01/93-
1.6 01/93-
1.7 D 01/93-
1.8 01/93-
1.9 D 01/93-
1.9 TD 01/93-
2.0 01/93-

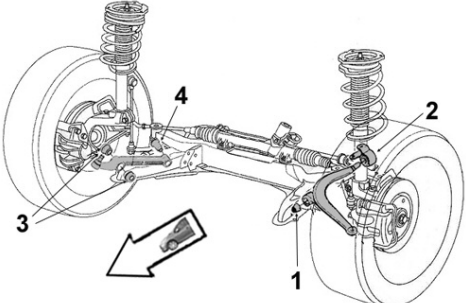
... Tipo ...

FIAT

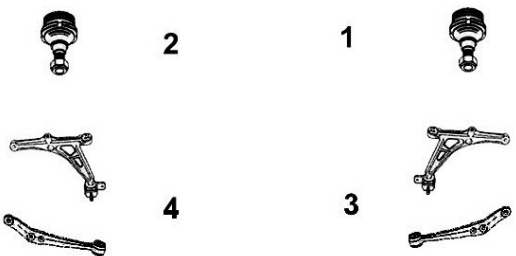
SASIC

9001729 OE 7760425	Palier de barre milieu <i>Middle bar main bearing</i>	9001728 OE 7760424	Palier de barre milieu <i>Middle bar main bearing</i>
	1 Barre Ø 22 1.4 1.6 1.7 D		1 Barre Ø 23 1.8 1.9 TD 2.0
 <p>Eléments SUSPENSION <i>Suspension parts</i> <i>Elementos suspensión</i> <i>Elementy zawieszenie</i> <i>Элементы подвески</i></p>			
9001717 OE 7601065	Articulation AR G <i>Left rear bush</i>	9001714 OE 7601068	Articulation AR D <i>Right rear bush</i>
	2 Ø 21 1.1 1.4 1.6 1.7 D 1.8 1.9 D 1.9 TD 2.0		2 Ø 21 1.1 1.4 1.6 1.7 D 1.8 1.9 D 1.9 TD 2.0
9001722 OE 7601064	Articulation AV <i>Front bush</i>		
	1 Ø 21 1.1 1.4 1.6 1.7 D 1.8 1.9 D 1.9 TD 2.0		
<p>Bras & Triangle de suspension <i>Control arm</i> <i>Brazo y triángulo</i> <i>Wahacz</i> <i>Рычаг подвески</i></p>		<p>G/L  D/R</p>	
9005144 OE 93501180	Triangle de susp. G <i>Left track control arm</i>	9005143 OE 93501181	Triangle de susp. D <i>Right track control arm</i>
	4 Trou fixation Ø15 Avec rotule <i>Fixation holes Ø15 With ball joint</i> TT /all models 01/88-12/90		3 Trou fixation Ø15 Avec rotule <i>Fixation holes Ø15 With ball joint</i> TT /all models 01/88-12/90

... Tipo

Bras & Triangle de suspension

Control arm
Brazo y triángulo
Wahacz
Рычаг подвески

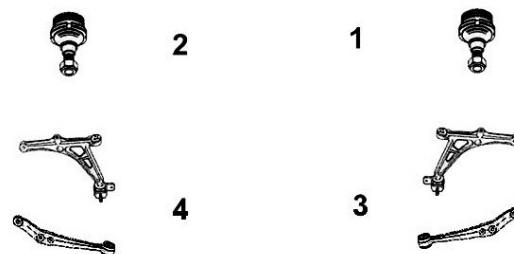
G/L  D/R**9005104**

OE 71747915

Triangle de susp. G

Left track control arm

4 Avec rotule With ball joint Ø17

TT /all models

09/90-

9005103

OE 71747916

Triangle de susp. D

Right track control arm

3 Avec rotule With ball joint Ø17

TT /all models

09/90-

**Support d'amortisseur**

Suspension mounting
Soporte amortiguador
Poduszka amortyzatora
Опора амортизатора

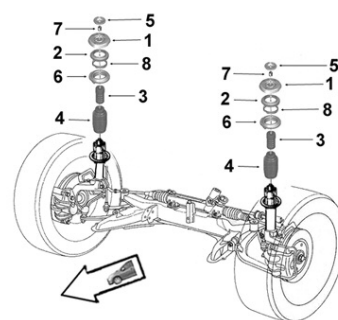
**8005206**

OE 7601502

Butée à billes G/D

L/R ball bearing

2 Ø 78.5 x 128 x 47

1.1
1.4
1.6
1.7 D
1.8
1.9 D
1.9 TD
2.0

**9005611**

OE 7602150

Coupelle ressort G/D

L/R spring cup

6

1.4
1.4i
1.6
1.6i
1.7 D
1.9 TD

**9005379**

OE 7607086

Butée protecteur susp. AV G/D

L/R front suspension bush

3**4**

1.1
1.4
1.6
1.7 D
1.8
1.9 D
1.9 TD
2.0

**9001726**

OE 7693020

Articulation essieu AR

Rear axle bush

Éléments TRAIN ARRIERE

Rear axle parts
Tren TRAS
Elementy zawieszenia tylnego
элементы задней оси.



1.7 D
1.9 D
1.9 TD
1.9 TD TDS

Ulysse ...

Eléments DIRECTION

Steering parts

Elementos Direcciones

Elementy układ kierowniczy

Элементы рулевой системы

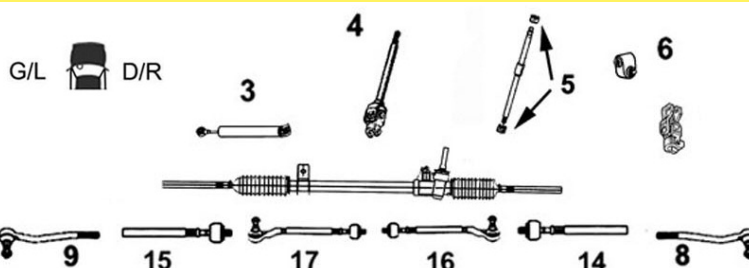

3008069 Axe de bielle G/D

Part/oe 9566950880 L/R axial joint



14 Côté dir. M14x1.5 Côté rot. M14x1.5 long 306 mm

15

1.8	-08/02
1.9 TD	-08/02
2.0	-08/02
2.0i 16v.	-08/02
2.0 Turbo	-08/02
2.0 JTD 8v. 16v.	-08/02
2.1 TD	-08/02

0594094 Rotule de direction G/D

OE 1306003080 L/R tie rod end



8 M14 x 1.5

9

1.8	-08/02
1.9 TD	-08/02
2.0	-08/02
2.0i 16v.	-08/02
2.0i Turbo	-08/02
2.0 JTD 8v.	-08/02
2.0 JTD 16v.	-08/02
2.1 TD	-08/02

7670011 Rotule de direction G/D

OE 9403817738 L/R tie rod end



8 M14 x 1.5

9

2.0 JTD	05/06-
2.2 JTD	03/08-



Barre stabilisatrice

Stabilizer bar

Barra estabilizadora

Drażek stabilizatora

стабилизатор поперечной устойчивости

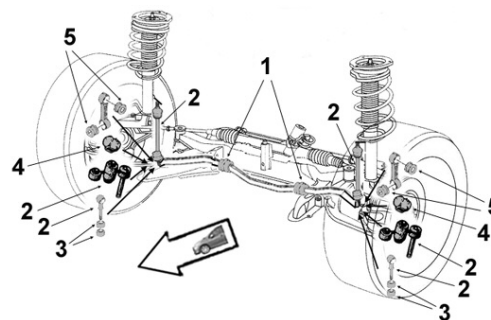

0875355 Biellette barre stab.

OE 1317425080 Stabilizer bar stub axle



2

1.8	-08/02
1.9 TD	-08/02
2.0	-08/02
2.0i 16v.	-08/02
2.0i Turbo	-08/02
2.0 JTD 8v.	-08/02
2.0 JTD 16v.	-08/02
2.1 TD	-08/02

0935155 Liaison élastique

OE 1300720080 Elastic link



3 Ø int.12.5 Ø ext.37.5
long.tube int.20 ext.22

1.8	-08/02
1.9 TD	-08/02
2.0	-08/02
2.0i 16v. /Turbo	-08/02
2.0 JTD 8v.	-08/02
2.0 JTD 16v.	-08/02
2.1 TD	-08/02

0945695 Palier de barre milieu

OE 1305782080 Middle bar main bearing



1 Barre Ø 24

1.8	-08/02
1.9 TD	-08/02
2.0	-08/02
2.0i 16v. /Turbo	-08/02
2.0 JTD 8v.	-08/02
2.0 JTD 16v.	-08/02
2.1 TD	-08/02

... Ulysse ...



Eléments SUSPENSION
Suspension parts
Elementos suspensión
Elementy zawieszenie
Элементы подвески

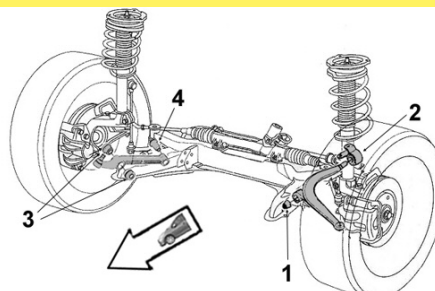

9001719 **Articulation AR G**
 OE 1305551080 *Left rear bush*



2
 1.8 -08/02
 1.9 TD -08/02
 2.0 -08/02
 2.0 Turbo -08/02
 2.0i 16v. -08/02
 2.0 JTD -08/02
 2.1 TD -08/02

9001716 **Articulation AR D**
 OE 1305552080 *Right rear bush*



2
 1.8 -08/02
 1.9 TD -08/02
 2.0 -08/02
 2.0 Turbo -08/02
 2.0i 16v. -08/02
 2.0 JTD -08/02
 2.1 TD -08/0

9001724 **Articulation AV**
 OE 1312317080 *Front bush*



1
 1.8 -08/02
 1.9 TD -08/02
 2.0 -08/02
 2.0 Turbo -08/02
 2.0i 16v. -08/02
 2.0 JTD -08/02
 2.1 TD -08/02

Bras & Triangle de suspension

Control arm
Brazo y triángulo
Wahacz
Рычаг подвески

G/L D/R



5203943 **Triangle de susp. G**
 OE 1317389080 OE 1316735080 *Left track control arm*



4 *Avec rotule With ball joint*
 1.8 -08/02
 1.9 TD -08/02
 2.0 -08/02
 2.0i 16v. -08/02
 2.0 Turbo -08/02
 2.0 JTD 8v./16v. -08/02
 2.1 TD -08/02

5213643 **Triangle de susp. D**
 OE 1317390080 OE 131737048 *Right track control arm*



3 *Avec rotule With ball joint*
 1.8 -08/02
 1.9 TD -08/02
 2.0 -08/02
 2.0i 16v. -08/02
 2.0 Turbo -08/02
 2.0 JTD 8v./16v. -08/02
 2.1 TD -08/02

5203P63 **Triangle de susp. G**
 OE 1346384080 *Left track control arm*











4 *Avec rotule With ball joint*
 2.0i 16v. 09/02-06/06
 2.0 JTD 09/02-06/06
 2.2 JTD 09/02-06/06

5213K63 **Triangle de susp. D**
 OE 1346385080 *Right track control arm*

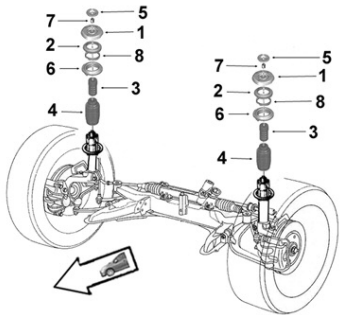

3 *Avec rotule With ball joint*
 2.0i 16v. 09/02-06/06
 2.0 JTD 09/02-06/06
 2.2 JTD 09/02-06/06

... Ulysse

... Ulysse			
7470015 OE 1356060080	Triangle de susp. G <i>Left track control arm</i>	7470014 OE 1356061080	Triangle de susp. D <i>Right track control arm</i>
	4 Avec rotule <i>With ball joint</i> Ø17 2.0 JTD 07/06- 2.2 JTD 07/06-		3 Avec rotule <i>With ball joint</i> Ø17 2.0 JTD 07/06- 2.2 JTD 07/06-
 <p>Support d'amortisseur <i>Suspension mounting</i> <i>Soporte amortiguador</i> <i>Poduszka amortyzatora</i> <i>Опора амортизатора</i></p>			
0385165 OE 9405038689	Support suspension G <i>Left suspension mounting</i>	0385175 OE 9405038709	Support suspension D <i>Right suspension mounting</i>
	1 1.8 1.9 TD 2.0 2.0i 16v. 2.0i Turbo 2.0 JTD 2.1 TD		1 1.8 1.9 TD 2.0 2.0i 16v. 2.0i Turbo 2.0 JTD 2.1 TD
9005370 OE 1303672080	Butée à billes G/D <i>L/R ball bearing</i>	0335395 OE 1307021080	Butée de suspension G/D <i>L/R suspension bush</i>
	2 Ø 78 x 128 x 45.5 2.0i 16v. -08/02 2.0i 16v. 09/02- 2.0 JTD 06/06- 2.0 JTD 16v. 09/00- 2.2 JTD 09/02-		3 H105 1.8 -08/02 1.9 TD -08/02 2.0 -08/02 2.0i 16v. -08/02 2.0i Turbo -08/02 2.0 JTD 8v. -08/02 2.0 JTD 16v. -08/02 2.1 TD -08/02
<p>Eléments TRAIN ARRIERE <i>Rear axle parts</i> <i>Tren TRAS</i> <i>Elementy zawieszenia tylnego</i> <i>элементы задней оси.</i></p>			
1525615 OE 1479759080	Articulation essieu AR <i>Rear axle bush</i>		
	Ø int.12 Ø ext.46 long. tube int.60 ext.48 1.8 -08/02 1.9 TD -08/02 2.0 -08/02 2.0ie GPL 02/95-09/00 2.0i 16v. -08/02 2.0i Turbo -08/02 2.0 JTD 8v. 16v. -08/02 2.1 TD -08/02		

Uno ...

SASIC

FIAT

Eléments DIRECTION
Steering parts
Elementos Direcciones
Elementy układ kierowniczy
Элементы рулевой системы

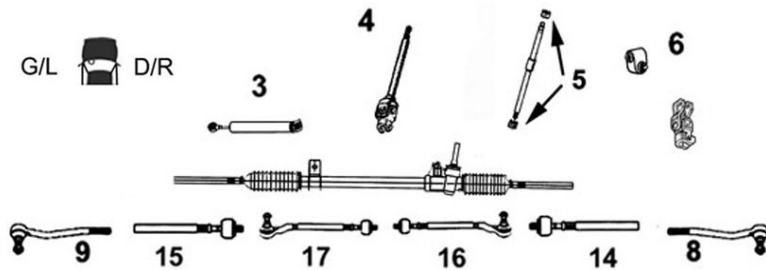

9006262 **Axe de bielle G/D**
 OE 7633721 *L/R axial joint*



14 Côté dir. M14x1.5 Côté rot. M12x1.5 long 275 mm
15

TT /all models Sauf CS et turbo IE

9006337 **Rotule de direction G/D**
 OE 5958246 *L/R tie rod end*



8 M12 x 1.5
9

TT /all models Sauf CS et turbo IE

9004002 **Axe de volant**
 OE 7640534 *Steering wheel shaft*



4

TT /all models Sauf CS et turbo IE
 01/89-12/95



Barre stabilisatrice
Stabilizer bar
Barra estabilizadora
Drażek stabilizatora
 стабилизатор поперечной устойчивости

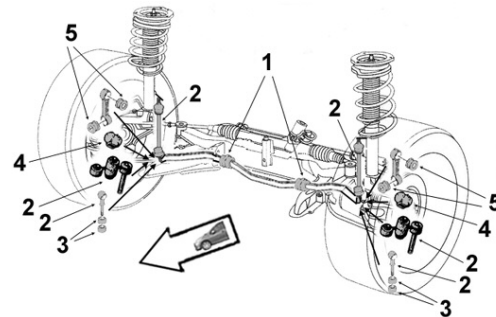

9001735 **Palier de barre bout**
 OE 7603476 *End bar main bearing*



4 Barre Ø 17
 1.1
 1.3
 1.3 turbo
 1.4i Turbo
 1.4ie
 1.4 TD
 1.5ie
 1.7 D

10/89-01/93
 01/88-
 01/88-
 10/89-01/93
 10/89-01/93
 01/88-
 07/92-12/93
 01/88-

9001734 **Palier de barre milieu**
 OE 7563151 *Middle bar main bearing*



1 Barre Ø 17
 1.1
 1.3
 1.3 turbo
 1.4i Turbo
 1.4ie
 1.4 TD
 1.5ie
 1.7 D

10/89-01/93
 01/88-
 01/88-
 10/89-01/93
 10/89-01/93
 01/88-
 07/92-12/93
 01/88-

... Uno ...



Eléments SUSPENSION

Suspension parts

Elementos suspensión



Elementy zawieszenie

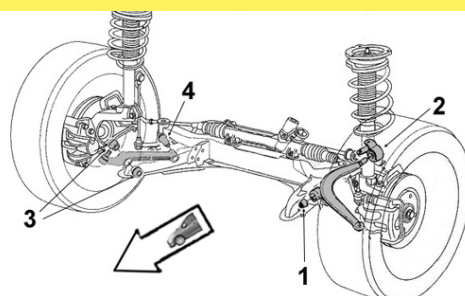



Элементы подвески





FIAT

SASIC

9001738 OE 5927293	Articulation AR <i>Rear bush</i>	9001720 OE 5927292	Articulation AV <i>Front bush</i>
	2 0.9 01/88- 1.0 01/88- 1.1 01/88- 1.3 01/88- 1.3 D 01/88- 1.4 TD 01/88- 1.7 D 01/88-		1 Ø int.12 Ø ext.32 coll.37 long. tube int.55 ext.40 ep. coll.6 0.9 01/88- 1.0 01/88- 1.1 01/88- 1.3 01/88- 1.3 D 01/88- 1.4 TD 01/88- 1.7 D 01/88-

Bras & Triangle de suspension <i>Control arm</i> <i>Brazo y triángulo</i> <i>Wahacz</i> <i>Рычаг подвески</i>	G/L  D/R	 2	1 
		 4	3 

9005171 OE 7705615	Triangle de susp. G <i>Left track control arm</i>	9005170 OE 7705616	Triangle de susp. D <i>Right track control arm</i>
	4 Avec rotule With ball joint TT /all models Sauf CS et turbo IE		3 Avec rotule With ball joint TT /all models Sauf CS et turbo IE

7576001 OE -	Rotule de susp. inf. G/D <i>L/R lower suspension ball joint</i>		
	1 2 TT /all models Sauf CS et turbo IE		

9005230 OE 4402649	Rotule de susp. inf. G/D <i>L/R lower suspension ball joint</i>		
	1 2 TT /all models Sauf CS et turbo IE		

... Uno

SASIC

FIAT



Support d'amortisseur
Suspension mounting
Soporte amortiguador
Poduszka amortyzatora
Опора амортизатора

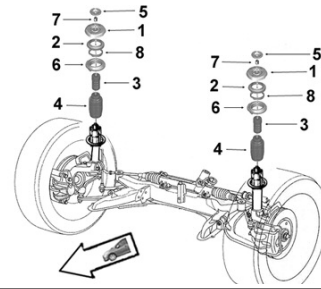

8005200

OE 4400895

Butée à billes G/D

L/R ball bearing

2 Ø 50 x 70 x 3.6

0.9	01/88-
1.0	01/88-
1.1	01/88-
1.3	01/88-
1.3 D	01/88-
1.4 /Turbo	10/89-
1.4 TD	01/88-
1.5	07/92-
1.7 D	01/88-



9005600

OE 5968311

Support suspension G/D

L/R suspension mounting

1

0.9	01/88-
1.0	01/88-
1.1	01/88-
1.3	01/88-
1.3 D	01/88-
1.4 TD	01/88-
1.7 D	01/88-



Support d'amortisseur
Suspension mounting
Soporte amortiguador
Poduszka amortyzatora
Опора амортизатора

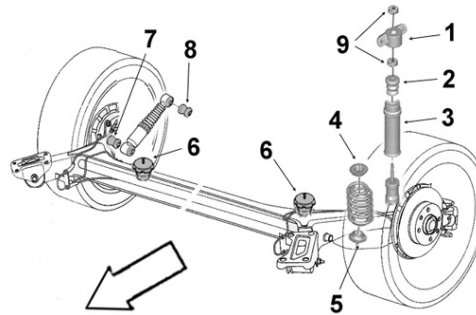

9001753

OE 5960254

Support suspension G/D

L/R suspension mounting

1

0.9	01/88-
1.0	01/88-
1.1	01/88-
1.3	01/88-
1.3 D	01/88-
1.4	10/89-
1.4 TD	01/88-
1.5	07/92-
1.7 D	01/88-



Eléments TRAIN ARRIERE

Rear axle parts
Tren TRAS
Elementy zawieszenia tylnego
элементы задней оси.



9001725

OE 5947887

Articulation essieu AR AV

Front Rear axle bush

Ø int. 10 Ø ext.52 coll.66 long. tube int. 68 ext.45 ep. coll.10

0.9	01/88-
1.0	01/88-
1.1	01/88-
1.3	01/88-
1.3 D	01/88-
1.4 TD	01/88-
1.7 D	01/88-



Doblo ...

Eléments DIRECTION

Steering parts

Elementos Direcciones

Elementy układ kierowniczy

Элементы рулевой системы

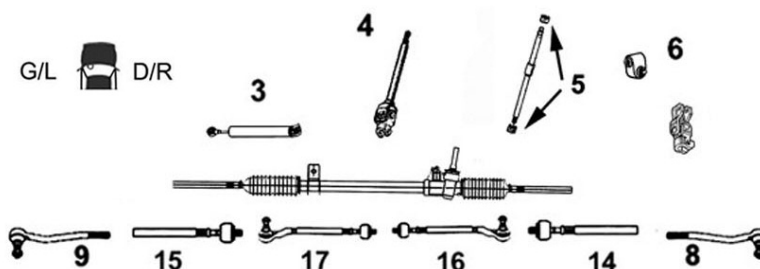

7776058

Axe de bielle G/D

Part/oe 98845025

L/R axial joint

NEW



14 Côté dir. M16x1.5 Côté rot. M14x1.5 long 330 mm
15

1.2	DNA	DA -ch 5120134	03/01-
1.3 MJTD	DNA	DA -ch 5120134	04/04-
1.4	DNA	DA -ch 5120134	10/05-
1.6i 16v.	DNA	DA -ch 5120134	10/01-
1.9 D	DNA	DA -ch 5120134	03/01-
1.9 JTD	DNA	DA -ch 5120134	10/01-

9006834

Axe de bielle G/D

Part/oe 98845026

L/R axial joint



14 Côté dir. M16x1.5 Côté rot. M14x1.5
15 long 292 mm
DA Ch- 5120135

1.2	-12/05
1.3 MJTD	-12/05
1.6i 16v.	-12/05
1.9 D	-12/05
1.9 JTD 100hp 74kw	-12/05
1.9 JTD 105hp 77kw	-12/05

9006654

Rotule de direction G/D

OE 9947714

L/R tie rod end

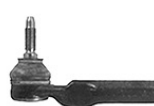

8 M14 x 1.5
9 -ch 5120134

1.2	
1.3 MJTD	
1.6i 16v.	
1.9 D	
1.9 JTD	

9006443

Rotule de direction G

OE 98845032

Left tie rod end



9 M14 x 1.5

1.2	Ch- 5120135	-12/05
1.3 MJTD	Ch- 5120135	-12/05
1.3 MJTD		01/06-
1.4i		01/06-12/09
1.6i 16v.	Ch- 5120135	-12/05
1.6i 16v.		01/06-
1.9 D	Ch- 5120135	-12/05
1.9 JTD 100hp 74kw 105hp 77kw	Ch- 5120135	-12/05
1.9 JTD		06/06-
1.9 MJTD		01/06-

9006442

Rotule de direction D

OE 98845031

Right tie rod end



8 M14 x 1.5

1.2	Ch- 5120135	-12/05
1.3 MJTD	Ch- 5120135	-12/05
1.3 MJTD		01/06-
1.4i		01/06-12/09
1.6i 16v.	Ch- 5120135	-12/05
1.6i 16v.		01/06-
1.9 D	Ch- 5120135	-12/05
1.9 JTD 100hp 74kw 105hp 77kw	Ch- 5120135	-12/05
1.9 JTD		06/06-
1.9 MJTD		01/06-

7676064

Rotule de direction G

OE 77365223

Left tie rod end

NEW



9 M14 x 1.5

1.3 JTD	01/10-
1.3 MJTD	01/10-
1.4i	01/10-
1.6 JTD	01/10-
2.0 JTD	01/10-

7676065

Rotule de direction D

OE 77365224

Right tie rod end

NEW



8 M14 x 1.5

1.3 JTD	01/10-
1.3 MJTD	01/10-
1.4i	01/10-
1.6 JTD	01/10-
2.0 JTD	01/10-

... Doblo ...

SASIC

FIAT



Barre stabilisatrice
 Stabilizer bar
 Barra estabilizadora
 Drażek stabilizatora
 стабилизатор поперечной устойчивости

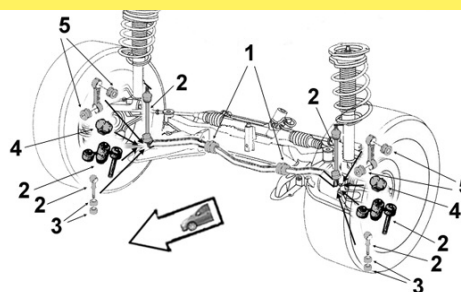

9001785 **Palier de barre bout**
 OE 46738808 *End bar main bearing*



4 Ø 22
 sauf 5 places

1.2	01/00-
1.3 MJTD sauf charge lourde	01/04-
1.6i 16v.	01/00-
1.9 D sauf charge lourde	01/00-
1.9 JTD sauf charge lourde	01/00-

9001713 **Palier de barre milieu**
 OE 46790552 *Middle bar main bearing*



1 Ø 23
 5 places

1.2	01/04-
1.3 MJTD	01/04-
1.6i 16v.	01/04-
1.9 D	01/04-
1.9 JTD	01/04-

9001743 **Palier de barre milieu**
 OE 46821119 *Middle bar main bearing*



1 Barre Ø 23.5
 Charge lourde

1.3 MJTD	01/04-
1.9 D	01/04-
1.9 JTD	01/04-



Eléments SUSPENSION
 Suspension parts
 Elementos suspensión
 Elementy zawieszenie
 Элементы подвески

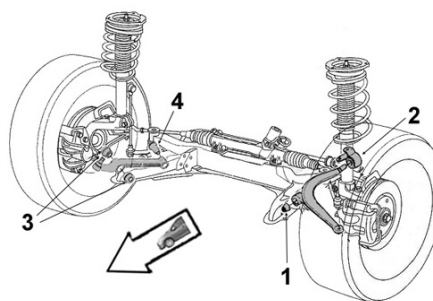

2256017 **Articulation AR G**
 Part/oe 51769074 *Left rear bush*



2 Ø int. 20

1.2i	BVM 03/01-
1.3 MJTD	BVM 04/04-
1.4i	BVM 01/06-
1.6i 16v. /GNV	BVM 10/01-
1.9 Ds	BVM 03/01-
1.9 JTD	BVM 10/01-
1.9 MJTD	BVM 01/06-

2256015 **Articulation AR D**
 Part/oe 51769073 *Right rear bush*



2 Ø int. 20

1.2i	BVM 03/01-
1.3 MJTD	BVM 04/04-
1.4i	BVM 01/06-
1.6i 16v. /GNV	BVM 10/01-
1.9 Ds	BVM 03/01-
1.9 JTD	BVM 10/01-
1.9 MJTD	BVM 01/06-

2256014 **Articulation AV**
 OE 46421522 *Front bush*



1 Ø int. 12 Ø ext. 30 coll. 44.5 long. tube int. 54.5 ext. 38

1.3 MJTD	BVM	10/03-
1.6i 16v.	BVM	04/04-
1.9 Ds	BVM	10/01-
1.9 JTD	BVM	03/01-
1.9 MJTD /FAP	BVM	04/04-
	BVM	01/06-

... Doblo ...

Bras & Triangle de suspension

Control arm
Brazo y triángulo
Wahacz
Рычаг подвески

G/L  D/R

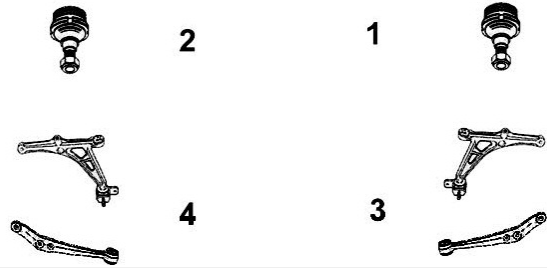

9005803

OE 51866701

Triangle de susp. G

Left track control arm

4 Avec rotule With ball joint



1.2i /Cargo	-12/05
1.3 MJTD /Cargo	04/04-12/05
1.6i 16v. /Cargo	-12/05
1.9 D /Cargo	-12/05
1.9 JTD /Cargo	-12/05

9005802

OE 51866700

Triangle de susp. D

Right track control arm

3 Avec rotule With ball joint



1.2i /Cargo	-12/05
1.3 MJTD /Cargo	04/04-12/05
1.6i 16v. /Cargo	-12/05
1.9 D /Cargo	-12/05
1.9 JTD /Cargo	-12/05

7476218

OE 51932035

Triangle de susp. G

Left track control arm

4 Avec rotule With ball joint Ø 18

NEW



1.3 JTD /Cargo	01/10-
1.3 MJTD /Cargo	01/10-
1.4i /Turbo /Cargo	01/10-
1.6 JTD /Cargo	01/10-
2.0 JTD /Cargo	01/10-

7476217

OE 51932036

Triangle de susp. D

Right track control arm

3 Avec rotule With ball joint Ø 18

NEW



1.3 JTD /Cargo	01/10-
1.3 MJTD /Cargo	01/10-
1.4i /Turbo /Cargo	01/10-
1.6 JTD /Cargo	01/10-
2.0 JTD /Cargo	01/10-

9005531

OE 7081835

Rotule de susp. G/D

L/R suspension ball joint

1 -ch 5023343

2



1.2i 8v.	-12/04
1.6i 16v.	-12/04
1.9 D	-12/04
1.9 JTD	-12/04

9005530

OE 46842581

Rotule de susp. G/D

L/R suspension ball joint

1

2



1.2		01/04-
1.2i 8v.	Ch- 5023343	-12/04
1.3 MJTD		01/04-
1.4		01/06-
1.6i 16v.	Ch- 5023343	-12/04
1.9 D	Ch- 5023343	-12/04
1.9 JTD	Ch- 5023343	-12/04
1.9 JTD	105hp 77kw	01/04-
1.9 MJTD	Ch- 5023343	



Support d'amortisseur

Suspension mounting
Soporte amortiguador
Poduszka amortyzatora
Опора амортизатора

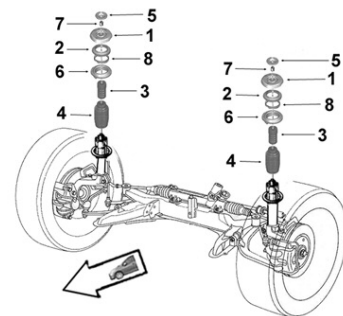

9005617

OE 46760674

Support suspension G

Left suspension mounting

1



1.2	01/00-
1.3 MJTD	01/04-
1.6i 16v.	01/00-
1.9 D	01/00-
1.9 JTD	01/00-

9005618

OE 46760673

Support suspension D

Right suspension mounting

1



1.2	01/00-
1.3 MJTD	01/04-
1.6i 16v.	01/00-
1.9 D	01/00-
1.9 JTD	01/00-

... Doblo

SASIC

FIAT



Barre stabilisatrice
 Stabilizer bar
 Barra estabilizadora
 Drażek stabilizatora
 стабилизатор поперечной устойчивости

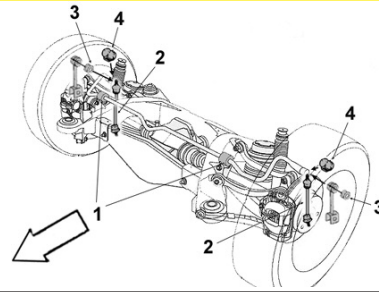

9005002 **Biellette barre stab.**
 OE 51717001 *Stabilizer bar stub axle*



2
 1.2 01/04-
 1.3 MJTD 01/04-
 1.4i Cargo /Cargo Maxi 01/06-10/10
 1.6i 16v. 01/04-
 1.9 D 01/04-
 1.9 JTD 01/04-
 1.9 MJTD Cargo Maxi 01/06-10/10

Eléments TRAIN ARRIERE
 Rear axle parts
 Tren TRAS
 Elementy zawieszenia tylnego
 элементы задней оси.



9003111 **Silentbloc essieu G/D**
 OE 46767261 *L/R axle silentbloc*
 Ø int.16 Ø ext.56 long. tube int.77.5 ext.70



1.2 01/04-
 1.3 MJTD 01/04-
 1.6i 16v. 01/04-
 1.9 D 01/04-
 1.9 JTD 01/04-

Ducato 81-94 ...

Eléments DIRECTION
 Steering parts
 Elementos Direcciones
 Elementy układ kierowniczy
 Элементы рулевой системы

G/L D/R

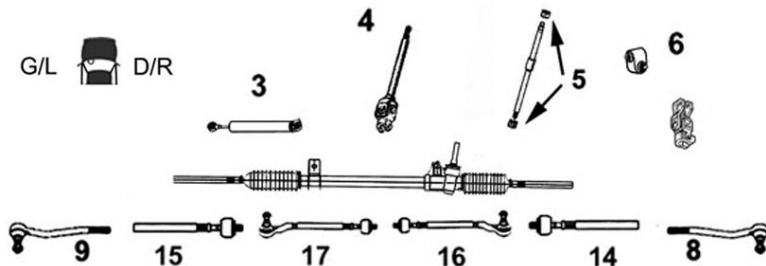

8123273 **Axe de bielle G/D**
 OE - *L/R axial joint*



14 Côté dir. M16x1.5 Côté rot. M16x1.5
15 long 292 mm

TT /all models DNA

3008071 **Axe de bielle G/D**
 OE - *L/R axial joint*



14 Côté dir. M14x1.5 Côté rot. M16x1.5
15 long 280 mm

TT /all models DA

8173113 **Rotule de direction G/D**
 OE 381711 *L/R tie rod end*



8 Ø 12 Ø 16 Ø 12 Ø 16 M16 x 1.5
9

TT /all models

1034534 **Axe de volant**
 OE 5920893 *Steering wheel shaft*



4
 TT /all models DNA

... Ducato 81-94 ...

1034A74

OE 4103A7

Axe de volant

Steering wheel shaft



4

TT /all models DA



Barre stabilisatrice

Stabilizer bar

Barra estabilizadora

Drażek stabilizatora

стабилизатор поперечной устойчивости

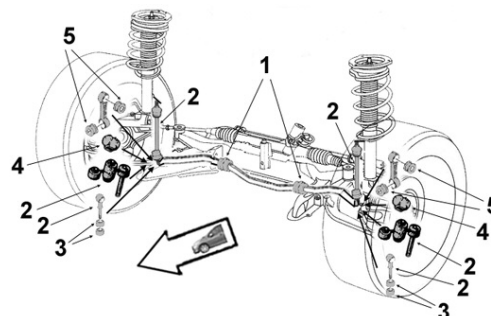

5613083

OE 4339248

Palier de barre

Bar main bearing



1 Ø int.22 Ø ext. 48 ep. 24.5

1.9 D
1.9 TD
2.5 D
2.5 TD



Eléments SUSPENSION

Suspension parts

Elementos suspensión

Elementy zawieszenie

Элементы подвески

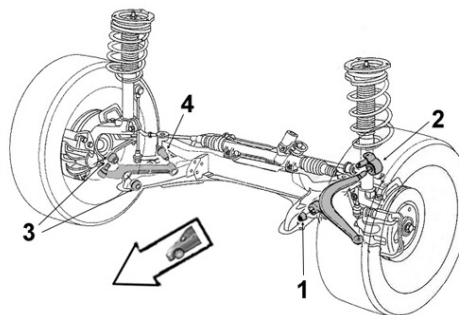

8003200

OE -

Articulation

Bush



4 Ø int.12 Ø ext.27 coll.43.5 x2 long. tube int.50 ext.28 ep. coll.6x2

Sauf 1800kg

1.9 D
1.9 TD
2.5 D
2.5 TD

8003209

OE -

Articulation

Bush



4 Ø int.12 Ø ext.35 coll.50 x2 long. tube int.50 ext.40 ep. coll.5x2

Sauf 1800kg

1.9 D
1.9 TD
2.5 D
2.5 TD

... Ducato 81-94 ...

SASIC

FIAT

Bras & Triangle de suspension

Control arm
Brazo y triángulo
Wahacz
Рычаг подвески

G/L  D/R

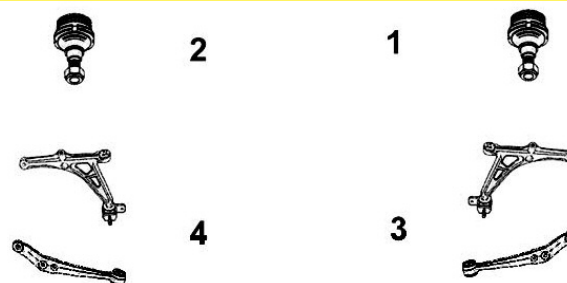

... Ducato 81-94 ...

Bras & Triangle de suspension

Control arm
Brazo y triángulo
Wahacz
Рычаг подвески

G/L  D/R

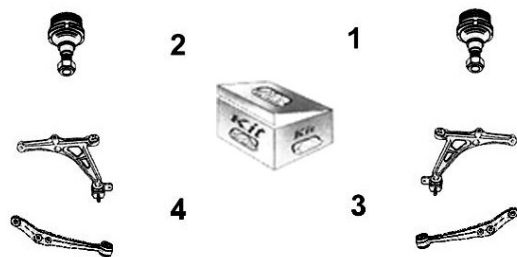

FIAT

SASIC

1003564 **Kit rép. bras susp. G ou D**
OE - *L or R track control arm bearing repair kit*

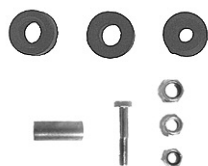

TT /all models sauf 1800kg

1003567 **Kit rép. bras susp. G ou D**
OE - *L or R track control arm bearing repair kit*

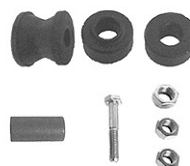

TT /all models 1800kg

1053564B **Kit rép. train AV complet**
OE - *Front axle complete repair kit*



Avec visserie With screws and bolts

TT /all models sauf 1800kg

105A564S **Kit rép. train AV**
OE - *Front axle repair kit*



Sans visserie Without screws and bolts

TT /all models sauf 1800kg

105A567S **Kit rép. train AV**
OE - *Front axle repair kit*



Sans visserie Without screws and bolts

TT /all models 1800kg



Support d'amortisseur

Suspension mounting
Soporte amortiguador
Poduszka amortyzatora
Опора амортизатора

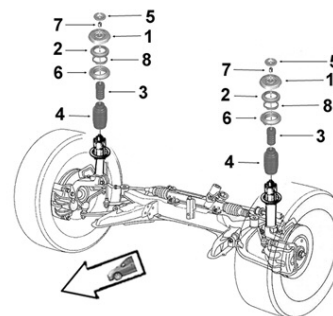

2105205 **Support suspension G/D**
OE 4466980 *L/R suspension mounting*



1

1.9 D
1.9 TD
2.5 D
2.5 TD

9005377 **Butée protecteur susp. G/D**
OE 1313046080 *L/R suspension bush*



3

4 1800kg
1.9 D
1.9 TD
2.5 D
2.5 TD

... Ducato 81-94

SASIC

FIAT



Support d'amortisseur
Suspension mounting
Soporte amortiguador
Poduszka amortyzatora
Опора амортизатора

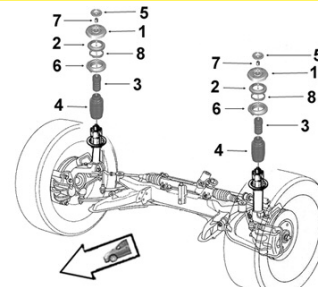

0335415

Butée de suspension G/D

OE 1313045080

L/R suspension bush



3
4 Sauf 1800kg

1.9 D
1.9 TD
2.5 D
2.5 TD

0355175

Butée à billes G/D

OE 4390179

L/R ball bearing



2

1.9 D
1.9 TD
2.5 D
2.5 TD

Eléments TRAIN ARRIERE

Rear axle parts

Tren TRAS

Elementy zawieszenia tylnego

элементы задней оси.



1315725

Articulation AR lame

OE 1304640080

Rear leaf bush



Ø int.16 Ø ext.41 coll.57
long. tube int.46.5 ext.40 coll.5

1.9 D
1.9 TD
2.5 D
2.5 TD

1315735

Articulation AV lame

OE 1304641080

Front leaf bush



Ø int.16.5 Ø ext.49 coll. 53 x2
long. tube int. 87 ext.70 coll.3

1.9 D
1.9 TD
2.5 D
2.5 TD

Ducato 94-01 ...

Eléments DIRECTION

Steering parts

Elementos Direcciones

Elementy układ kierowniczy

Элементы рулевой системы

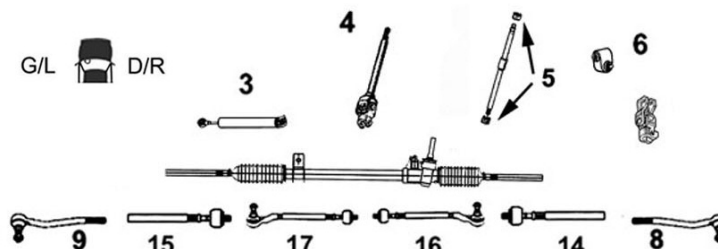

3008070

Axe de bielle G/D

Part/oe 9945836

L/R axial joint



14 Côté dir. M16x1.5 Côté rot. M16x1.5
15 long 319 mm

TT /all models

9006653

Rotule de direction G/D

OE 1471655080

L/R tie rod end



8
9 M16 x 1.5

TT /all models DNA

... Ducato 94-01 ...

FIAT



0184H44 Rotule de direction G/D

OE 1306716080 *L/R tie rod end*



8
9 M16 x 1.5

TT /all models DA

1034E64 Axe de volant *Steering wheel shaft*

OE 1307258080



4

TT /all models DNA

1034E44 Axe de volant *Steering wheel shaft*

OE 1307259080



4

TT /all models DA



Barre stabilisatrice
Stabilizer bar
Barra estabilizadora
Drażek stabilizatora
стабилизатор поперечной устойчивости

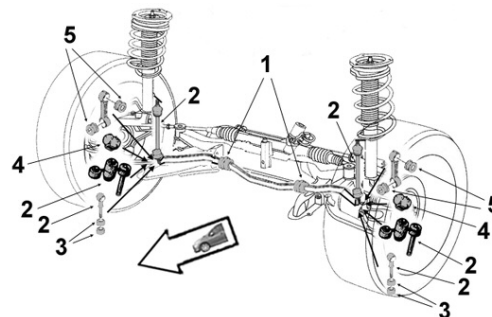

0875375 Bielle barre stab.

OE 1300716080 *Stabilizer bar stub axle*



2 Ø 12 x 125 long. 134

1.9 D TD	-12/01
2.0	-12/01
2.0 JTD Châssis Cabine	-12/01
2.5 D	-12/01
2.5 TDi	-12/01
2.8 D	-12/01
2.8 JTD	-12/01
2.8 TDiD	-12/01

0935155 Liaison élastique

OE 1313056080 *Elastic link*



3 Ø int.12.5 Ø ext.37.5 long. tube int.20 ext.22

1.9 D	-12/01
1.9 TD	-12/01
2.0	-12/01
2.5 D	-12/01
2.5 TDi	-12/01
2.8 D	-12/01
2.8 TDi	-12/01

8003210 Palier de barre

OE - *Bar main bearing*



1 Barre Ø 24

1.9 D	-12/01
1.9 TD	-12/01
2.0	-12/01
2.5 D	-12/01
2.5 TDi	-12/01
2.8 D	-12/01
2.8 TDi	-12/01

... Ducato 94-01 ...





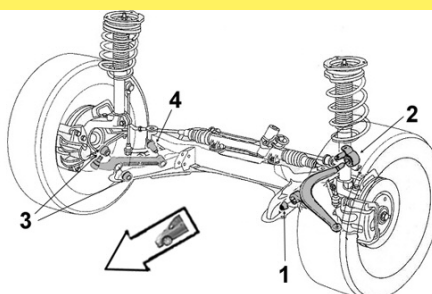





Eléments SUSPENSION
Suspension parts
Elementos suspensión
Elementy zawieszenie
Элементы подвески







FIAT



SASIC

8003204	Articulation AR	8003202	Articulation AV
OE -	Rear bush	OE -	Front bush
	2 Ø int.34		1 Ø int.18 Ø ext.45 coll.57.5 x2 long. tube int.65 ext.49 ep. coll.7x2
	1.9 D -12/01 1.9 TD -12/01 2.0 -12/01 2.5 D -12/01 2.5 TDi -12/01 2.8 D -12/01 2.8 TDi -12/01		1.9 D -12/01 1.9 TD -12/01 2.0 -12/01 2.5 D -12/01 2.5 TDi -12/01 2.8 D -12/01 2.8 TDi -12/01

Bras & Triangle de suspension		G/L  D/R			
<i>Control arm</i> <i>Brazo y triángulo</i> <i>Wahacz</i> <i>Рычаг подвески</i>					
				2	
					
				4	
					3

5203953	Triangle de susp. G	5213653	Triangle de susp. D
OE 1339465080	Left track control arm	OE 1339467080	Right track control arm
	4 Sans rotule Without tie rod end		3 Sans rotule Without tie rod end
	TT /all models Sauf 1800kg		TT /all models Sauf 1800kg

5203963	Triangle de susp. G	5213663	Triangle de susp. D
OE 1339464080	Left track control arm	OE 1339466080	Right track control arm
	4 Sans rotule Without tie rod end		3 Sans rotule Without tie rod end
	TT /all models 1800kg		TT /all models 1800kg

6403323	Rotule de susp. inf. G/D	6403333	Rotule de susp. inf. G/D
OE 1331640080	L/R lower suspension ball joint	OE 1331641080	L/R lower suspension ball joint
	1 2 M16x1.5		1 2 M18x1.5
	TT /all models Sauf 1800kg		TT /all models 1800kg

... Ducato 94-01 ...

Bras & Triangle de suspension

Control arm
Brazo y triángulo
Wahacz
Рычаг подвески

G/L  D/R



FIAT

SASIC

1003570

Kit rép. triangle susp. G ou D

OE -

L or R track control arm bearing repair kit

Sans visserie Without screws and bolts



TT /all models



Support d'amortisseur

Suspension mounting
Soporte amortiguador
Poduszka amortyzatora
Опора амортизатора

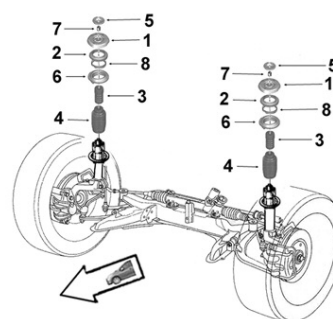

0385185

Support suspension G

OE 1323165080

Left suspension mounting



1

1.9 D	01/94-08/98
1.9 TD	01/94-08/98
2.5 D	01/94-08/98
2.5 TDi	01/94-08/98
2.8 D	01/94-08/98
2.8 TDi	01/94-08/98

0385195

Support suspension D

OE 1323166080

Right suspension mounting



1

1.9 D	01/94-08/98
1.9 TD	01/94-08/98
2.5 D	01/94-08/98
2.5 TDi	01/94-08/98
2.8 D	01/94-08/98
2.8 TDi	01/94-08/98

0385195

Support suspension G

OE 1323166080

Left suspension mounting



1

1.9 D	09/98-
1.9 TD	09/98-
2.0	09/98-
2.5 D	09/98-

0385185

Support suspension D

OE 1323165080

Right suspension mounting



1

1.9 D	09/98-
1.9 TD	09/98-
2.0	09/98-
2.5 D	09/98-

0335415

Butée de suspension G/D

OE 1313045080

L/R suspension bush



3

Sauf 1800kg

4

1.9 D TD	-12/01
2.0	-12/01
2.0 JTD	
2.5 D	-12/01
2.5 TDi	-12/01
2.8 D	-12/01
2.8 JTD	
2.8 TDi	-12/01

... Ducato 94-01





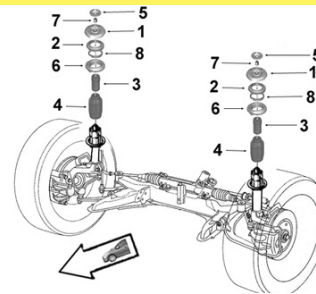

SASIC

FIAT





Support d'amortisseur
Suspension mounting
Soporte amortiguador
Poduszka amortyzatora
Опора амортизатора



0355395 OE 1355179080	Butée à billes G/D <i>L/R ball bearing</i>	9005377 OE 1313046080	Butée protecteur susp. G/D <i>L/R suspension bush</i>
	2 1.9 D -12/01 1.9 TD /Châssis Cabine -12/01 2.0 /i /Châssis Cabine -12/01 2.5 D /Châssis Cabine -12/01 2.5 TDi /Châssis Cabine -12/01 2.8 D /Châssis Cabine -12/01 2.8 JTD /Châssis Cabine -12/01 2.8 TDiD -12/01		3 1800kg 4 1.9 D TD 2.0 -12/01 2.0 JTD -12/01 2.5 D -12/01 2.5 TDi -12/01 2.8 D -12/01 2.8 JTD -12/01 2.8 TDi -12/01
1005266 OE -	Kit rép. suspension G <i>Left susp. mounting repair kit</i>	1005267 OE -	Kit rép. suspension D <i>Right susp. mounting repair kit</i>
	TT /all models Diesel 01/94-08/98		TT /all models Diesel 01/94-08/98
1005267 OE -	Kit rép. suspension G <i>Left susp. mounting repair kit</i>	1005266 OE -	Kit rép. suspension D <i>Right susp. mounting repair kit</i>
	TT /all models Essence Diesel Turbodiesel 09/98-		TT /all models Essence Diesel Turbodiesel 09/98-

Eléments TRAIN ARRIERE
Rear axle parts
Tren TRAS
Elementy zawieszania tylnego
элементы задней оси.



1315725 OE 1304640080	Articulation AR lame <i>Rear leaf bush</i>	1315735 OE 1304641080	Articulation AV lame <i>Front leaf bush</i>
	Ø int.16 Ø ext.41 coll.57 long. tube int.46.5 ext.40 coll.5 1.9 D TD -12/01 2.0 /i -12/01 2.5 D -12/01 2.5 TDi -12/01 2.8 D -12/01 2.8 TDi -12/01		Ø int.16.5 Ø ext.49 coll. 53 x2 long. tube int. 87 ext.70 coll.3 1.9 D TD -12/01 2.0 /i -12/01 2.5 D -12/01 2.5 TDi -12/01 2.8 D -12/01 2.8 TDi -12/01

Ducato 244.. 02-06 ...

Eléments DIRECTION

Steering parts

Elementos Direcciones

Elementy uklad kierowniczy

Элементы рулевой системы

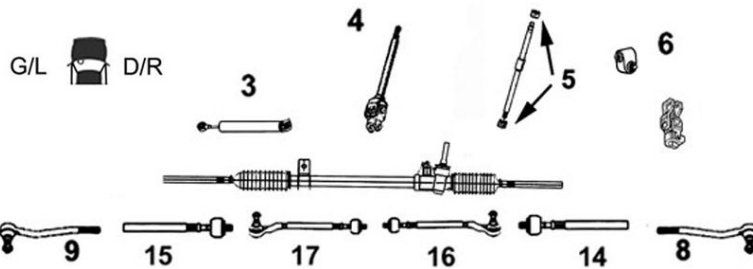

3008070

Axe de bielle G/D

Part/oe 9945836

L/R axial joint



14 Côté dir. M16x1.5 Côté rot. M16x1.5 long 319 mm

15

2.0
2.0 JTD
2.3 JTD
2.8 JTD

BVM BVA

0184H44

Rotule de direction G/D

OE 1306716080

L/R tie rod end



8
9

M16 x 1.5

2.0i -ch 7175291 -11/02
2.0 JTD -ch 7175291 -11/02
2.3 JTD -ch 7175291 -11/02
2.8 JTD -ch 7175291
BVM BVA -11/02

0184E04

Rotule de direction G/D

OE 77362278

L/R tie rod end



8
9

M16 x 1.5

2.0i Ch- 7175291
2.0 JTD Ch- 7175291
2.3 JTD Ch- 7175291
2.8 JTD Ch- 7175291 BVM BVA



Barre stabilisatrice

Stabilizer bar

Barra estabilizadora

Drażek stabilizatora

стабилизатор поперечной устойчивости

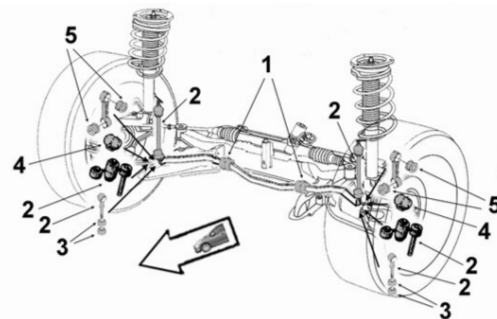

0875375

Biellette barre stab.

OE 1300716080

Stabilizer bar stub axle



2 Ø 12 x 125 long. 134

2.0i
2.0 JTD
2.3 JTD
2.8 JTD

0935155

Liaison élastique

OE 1313056080

Elastic link



3 Ø int.12.5 Ø ext.37.5 long. tube int.20 ext.22

2.0i
2.0 JTD
2.3 JTD
2.8 JTD

... Ducato 244.. 02-06 ...

SASIC

FIAT

Bras & Triangle de suspension

Control arm
Brazo y triángulo
Wahacz
Рычаг подвески

G/L  D/R



5203953

Triangle de susp. G

OE 1339465080

Left track control arm



4 Sans rotule Without tie rod end
Sauf 1800kg

2.0
2.0 JTD
2.3 JTD
2.8 JTD

BVM BVA

5213653

Triangle de susp. D

OE 1339467080

Right track control arm



3 Sans rotule Without tie rod end
Sauf 1800kg

2.0
2.0 JTD
2.3 JTD
2.8 JTD

BVM BVA

5203963

Triangle de susp. G

OE 1339464080

Left track control arm



4 Sans rotule Without tie rod end
1800kg

2.0
2.0 JTD
2.3 JTD
2.8 JTD

BVM BVA

5213663

Triangle de susp. D

OE 1339466080

Right track control arm



3 Sans rotule Without tie rod end
1800kg

2.0
2.0 JTD
2.3 JTD
2.8 JTD

BVM BVA

6403323

Rotule de susp. inf. G/D

OE 1331640080

L/R lower suspension ball joint



1 1800kg
2 M16 x 1.5

2.0
2.0 JTD
2.3 JTD
2.8 JTD

BVM BVA

6403333

Rotule de susp. inf. G/D

OE 1331641080

L/R lower suspension ball joint



1 1800kg
2 M18 x 1.5

2.0
2.0 JTD
2.3 JTD
2.8 JTD

BVM BVA



Support d'amortisseur

Suspension mounting
Soporte amortiguador
Poduszka amortyzatora
Опора амортизатора

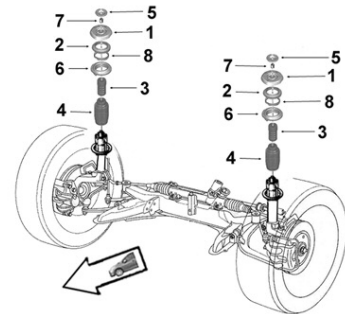

0385875

Support suspension G

OE 1345897080

Left suspension mounting



1

2.0i
2.0 JTD
2.3 JTD
2.8 JTD

0385895

Support suspension D

OE 1345896080



Right suspension mounting



1

2.0i
2.0 JTD
2.3 JTD
2.8 JTD

... Ducato 244.. 02-06

0355395	Butée à billes G/D	0335415	Butée de suspension G/D
OE 1355179080	L/R ball bearing	OE 1313045080	L/R suspension bush
	2		3 4
	2.0i /Châssis Cabine 2.0 JTD /Châssis Cabine 2.3 JTD /Châssis Cabine 2.8 JTD /4WD /Châssis Cabine		Sauf 1800kg 2.0 2.0 JTD 2.3 JTD 2.8 JTD

9005377	Butée protecteur susp. G/D
OE 1313046080	L/R suspension bush
	3 4
	1800kg 2.0 2.0 JTD 2.3 JTD 2.8 JTD

Ducato 250.. 06- ...

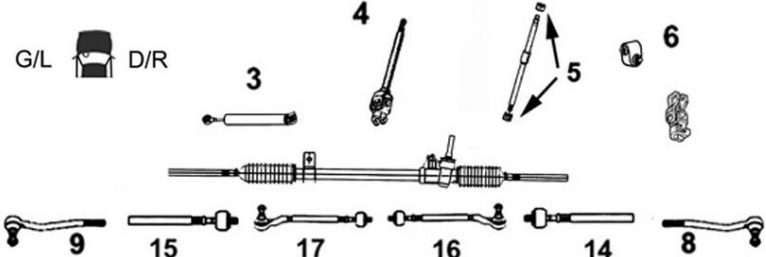
<p>Éléments DIRECTION Steering parts Elementos Direcciones Elementy układ kierowniczy Элементы рулевой системы</p>	
---	---

7770008	Axe de bielle G/D																														
Part/oe 1359225080	L/R axial joint																														
	14 15																														
	Conduite à gauche Left hand drive Côté dir. M16x1.5 Côté rot. M16x1.5 Long mm 261																														
	<table style="width: 100%; border: none;"> <tr> <td>2.3 JTD</td> <td>250ACMFAAX</td> <td>F1AE0481D</td> <td>BVM</td> <td>06/06-</td> </tr> <tr> <td>2.3 JTD</td> <td>250BCMFAAX /AAY1</td> <td>F1AE0481D</td> <td>BVM</td> <td>06/06-</td> </tr> <tr> <td>2.3 JTD</td> <td>250CCMFAAX /MFAAY /MFAAY1</td> <td>F1AE0481D</td> <td>BVM</td> <td>06/06-</td> </tr> <tr> <td>3.0 JTD</td> <td>250ADMFAAR /AAX</td> <td>F1CE0481D</td> <td>BVM</td> <td>06/06-</td> </tr> <tr> <td>3.0 JTD</td> <td>250BDMFAAX</td> <td>F1CE0481D</td> <td>BVM</td> <td>06/06-</td> </tr> <tr> <td>3.0 JTD</td> <td>250CDAFAAX1 /MFAAX</td> <td>F1CE0481D</td> <td>BVM</td> <td>06/06-</td> </tr> </table>	2.3 JTD	250ACMFAAX	F1AE0481D	BVM	06/06-	2.3 JTD	250BCMFAAX /AAY1	F1AE0481D	BVM	06/06-	2.3 JTD	250CCMFAAX /MFAAY /MFAAY1	F1AE0481D	BVM	06/06-	3.0 JTD	250ADMFAAR /AAX	F1CE0481D	BVM	06/06-	3.0 JTD	250BDMFAAX	F1CE0481D	BVM	06/06-	3.0 JTD	250CDAFAAX1 /MFAAX	F1CE0481D	BVM	06/06-
2.3 JTD	250ACMFAAX	F1AE0481D	BVM	06/06-																											
2.3 JTD	250BCMFAAX /AAY1	F1AE0481D	BVM	06/06-																											
2.3 JTD	250CCMFAAX /MFAAY /MFAAY1	F1AE0481D	BVM	06/06-																											
3.0 JTD	250ADMFAAR /AAX	F1CE0481D	BVM	06/06-																											
3.0 JTD	250BDMFAAX	F1CE0481D	BVM	06/06-																											
3.0 JTD	250CDAFAAX1 /MFAAX	F1CE0481D	BVM	06/06-																											

7670001	Rotule de direction G						
OE 1376346080	Left tie rod end						
	9						
	<table style="width: 100%; border: none;"> <tr> <td>2.2 JTD 16v. 100hp 74kw</td> <td style="text-align: right;">07/06-</td> </tr> <tr> <td>2.3 JTD 16v. 120hp 88kw</td> <td style="text-align: right;">07/06-</td> </tr> <tr> <td>3.0 JTD 16v. 155hp 116kw</td> <td style="text-align: right;">07/06-</td> </tr> </table>	2.2 JTD 16v. 100hp 74kw	07/06-	2.3 JTD 16v. 120hp 88kw	07/06-	3.0 JTD 16v. 155hp 116kw	07/06-
2.2 JTD 16v. 100hp 74kw	07/06-						
2.3 JTD 16v. 120hp 88kw	07/06-						
3.0 JTD 16v. 155hp 116kw	07/06-						

7670002	Rotule de direction D						
OE 1376345080	Right tie rod end						
	8						
	<table style="width: 100%; border: none;"> <tr> <td>2.2 JTD 16v. 100hp 74kw</td> <td style="text-align: right;">07/06-</td> </tr> <tr> <td>2.3 JTD 16v. 120hp 88kw</td> <td style="text-align: right;">07/06-</td> </tr> <tr> <td>3.0 JTD 16v. 155hp 116kw</td> <td style="text-align: right;">07/06-</td> </tr> </table>	2.2 JTD 16v. 100hp 74kw	07/06-	2.3 JTD 16v. 120hp 88kw	07/06-	3.0 JTD 16v. 155hp 116kw	07/06-
2.2 JTD 16v. 100hp 74kw	07/06-						
2.3 JTD 16v. 120hp 88kw	07/06-						
3.0 JTD 16v. 155hp 116kw	07/06-						

... Ducato 250.. 06- ...



Barre stabilisatrice
Stabilizer bar
Barra estabilizadora
Drażek stabilizatora
 стабилизатор поперечной устойчивости

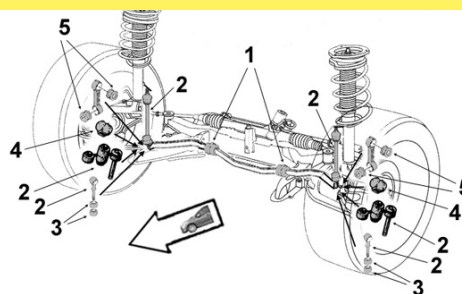

FIAT

0935155

Liaison élastique

OE 1313056080

Elastic link



3 Ø int.12.5 Ø ext.37.5
 long. tube int.20 ext.22

2.2 JTD PUMA 06/06-
 2.3 JTD VU 06/06-
 3.0 JTD 06/06-

2300037

Biellette barre stab.

Part/oe 1357572080

Stabilizer bar stub axle



2

2.2 JTD 16v. 07/06-
 2.3 JTD 16v. 07/06-
 3.0 JTD 16v. 07/06-

2300038

Palier de barre

Part/oe 1357572080

Bar main bearing



1 Barre Ø 26

2.2 JTD 16v. 07/06
 2.3 JTD 16v. 07/06-
 3.0 JTD 16v. 07/06-



Eléments SUSPENSION

Suspension parts
Elementos suspensión
Elementy zawieszenie
 Элементы подвески

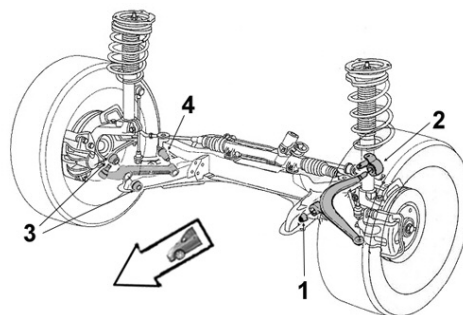

2250005

Articulation AR

Part/oe 1352227080

Rear bush



2 Ø int. 19 Ø ext. 74 long. tube int. 76 ext. 44

2.2 JTD 06/06-
 2.3 JTD 06/06-
 3.0 JTD 06/06-

2250004

Articulation AV

Part/oe 1352227080

Front bush



1 Ø int. 18 Ø ext. 56 coll. 59 long. tube int. 64 ext. 42 ep. coll.3X2

2.2 JTD 06/06-
 2.3 JTD 06/06-
 3.0 JTD 06/06-

... Ducato 250.. 06- ...

Bras & Triangle de suspension

Control arm
Brazo y triángulo
Wahacz
Рычаг подвески

G/L  D/R

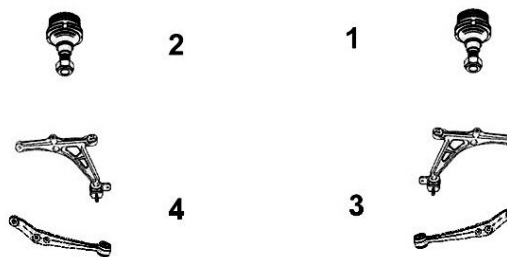

7470008

OE 1352227080

Triangle de susp. G

Left track control arm



4 Sans rotule Without tie rod end

2.2 JTD	06/06-
2.3 JTD	06/06-
3.0 JTD	06/06-

7470007

OE 1352225080

Triangle de susp. D

Right track control arm



3 Sans rotule Without tie rod end

2.2 JTD	06/06-
2.3 JTD	06/06-
3.0 JTD	06/06-

7570001

OE 93501837

Rotule de susp. inf. G/D

L/R lower suspension ball joint



1
2 M16 x 1.5

2.0 JTD FAP
2.2 JTD
2.3 JTD /FAP
3.0i /Turbo GNV
3.0 JTD /FAP



Support d'amortisseur

Suspension mounting
Soporte amortiguador
Poduszka amortyzatora
Опора амортизатора

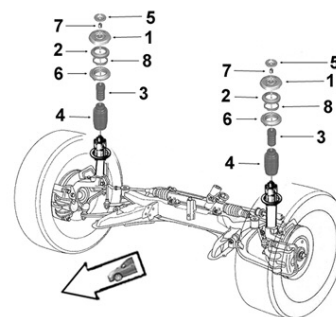

2650033

OE 1350789080

Support suspension G

Left suspension mounting



1

2.2 JTD	06/06-
2.3 JTD	06/06-
3.0 JTD	06/06-

2650034

OE 1350788080

Support suspension D

Right suspension mounting



1

2.2 JTD	06/06-
2.3 JTD	06/06-
3.0 JTD	06/06-

0355395

OE 1355179080

Butée à billes G/D

L/R ball bearing



2

2.2 JTD	06/06-
2.3 JTD	06/06-
3.0 JTD VU	06/06-

2650019

OE 93501847

Butée de suspension G/D

L/R suspension bush



3

2.2 JTD	06/06-
2.3 JTD	06/06-
3.0 JTD	06/06-

... Ducato 250.. 06- ...

SASIC



Support d'amortisseur
Suspension mounting
Soporte amortiguador
Poduszka amortyzatora
Опора амортизатора

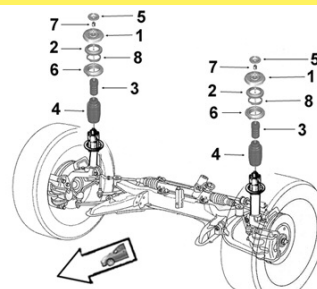

2650023

Protecteur amortisseur G/D

OE 50705790

L/R shock absorber protector



4

2.2 JTD 16v.
2.3 JTD 16v.
3.0 JTD 16v.

07/06-
07/06-
07/06-



Barre stabilisatrice

Stabilizer bar
Barra estabilizadora
Drażek stabilizatora
стабилизатор поперечной устойчивости

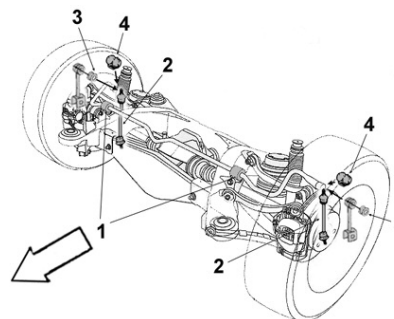

2300039

Biellette barre stab.

Part/oe 1355449080

Stabilizer bar stub axle



2

2.2 JTD 16v. 100hp 74kw
2.3 JTD 16v. 120hp 88kw
3.0 JTD 16v. 155hp 116kw

07/06-18/07/11
07/06-18/07/11
07/06-18/07/11



Support d'amortisseur

Suspension mounting
Soporte amortiguador
Poduszka amortyzatora
Опора амортизатора

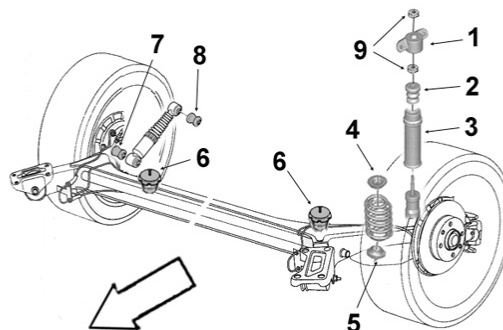

2650026

Butée de talonnage

OE 1351266080

Bushing



6

Susp. métallique Sauf susp. AR renforcée Charge utile 11/15/17Q
Susp. métallique Susp. AR renforcée Charge utile lourde 20Q

2.2 JTD 16v. 100hp 74kw
2.3 JTD 16v. 120hp 88kw
3.0 JTD 16v. 155hp 116kw

07/06-
07/06-
07/06-

... Ducato 250.. 06-

2650029
Butée de talonnage

OE 1355891080

Bushing

6 Susp. métallique
 Sauf susp. AR renforcée Charge utile lourde 20Q Sauf Fourgon semi vitré et motrice nue

 2.2 JTD 16v. 100hp 74kw
 2.3 JTD 16v. 120hp 88kw
 3.0 JTD 16v. 155hp 116kw

 07/06-
 07/06-
 07/06-

2650027
Butée de talonnage

OE 1357216080

Bushing

6 Susp. métallique Susp. AR renforcée Charge utile 11/15/17Q

 2.2 JTD 16v. 100hp 74kw
 2.3 JTD 16v. 120hp 88kw
 3.0 JTD 16v. 155hp 116kw

 07/06-
 07/06-
 07/06-

Fiorino VU ...

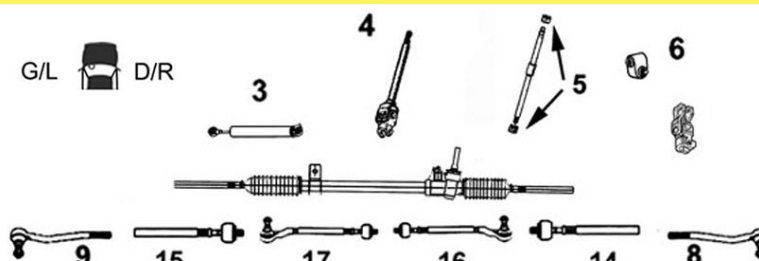
Eléments DIRECTION
Steering parts
Elementos Direcciones
Elementy układ kierowniczy
Элементы рулевой системы

9006263
Axe de bielle G/D

OE 4318655

L/R axial joint

14 Côté dir. M14x1.5 Côté rot. M14x1.0
15 long 133 mm

TT /all models 01/78-09/82

9006264
Axe de bielle G/D

Part/oe 5960321

L/R axial joint

14 Côté dir. M14x1.5 Côté rot. M12x1.5
15 long 192 mm

TT /all models 10/82-03/88

9006830
Axe de bielle G/D

Part/oe 7076231

L/R axial joint

14 Côté dir. M14x1.5 Côté rot. M14x1.5
15 long 217 mm

TT /all models 12/92-12/93

9006831
Axe de bielle G/D

Part/oe 7077206

L/R axial joint

14 Côté dir. M14x1.5 Côté rot. M14x1.5
15 long 192 mm

TT /all models DA 01/93-

7770013
Axe de bielle G/D

Part/oe 51784191

L/R axial joint

NEW

14 Côté dir. M14x1.5 Côté rot. M14x1.5 long 276 mm
15

 1.3 JTD
 1.4i

 199A2000
 TU3A/JP (KFV)

 BVM
 BVM

 01/08-
 01/08-

... Fiorino VU ...

Eléments DIRECTION
Steering parts
Elementos Direcciones
Elementy układ kierowniczy
Элементы рулевой системы

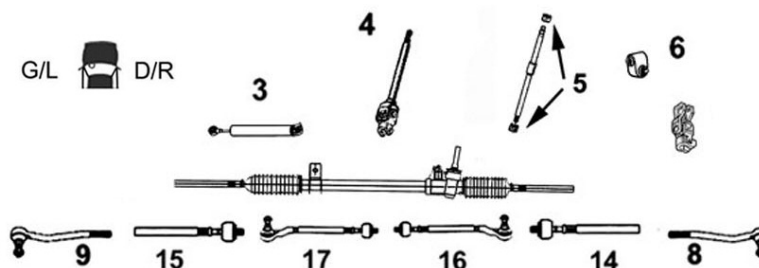

7670008

Rotule de direction G

OE 77364568

Left tie rod end



9 M14 x 1.5

1.3 JTD
1.4i

09/08-
09/08-

7670009

Rotule de direction D

OE 77364569

Right tie rod end



8 M14 x 1.5

1.3 JTD
1.4i

09/08-
09/08-

9006330

Rotule de direction G/D

OE 4254520

L/R tie rod end



**8
9 M14 x 1**

TT /all models

01/78-04/84

9006337

Rotule de direction G/D

OE 5958246

L/R tie rod end



**8
9 M12 x 1.5**

TT /all models

05/84-12/87

9006340

Rotule de direction G/D

OE 7543028

L/R tie rod end



**8
9 M12 x 1.5**

TT /all models

01/88-12/92

9006341

Rotule de direction G/D

OE 50006261

L/R tie rod end



**8
9 M14 x 1.5**

TT /all models

12/92-12/01

Bras & Triangle de suspension

Control arm
Brazo y triángulo
Wahacz
Рычаг подвески

G/L D/R

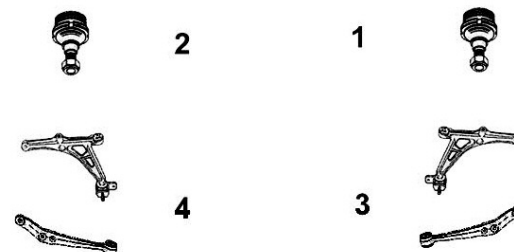

7470005

Triangle de susp. G

OE 51895367

Left track control arm



4 Avec rotule With ball joint

1.3 JTD
1.4i

01/08-
01/08-

7470006

Triangle de susp. D

OE 51895366

Right track control arm



3 Avec rotule With ball joint



1.3 JTD
1.4i

01/08-
01/08-

... Fiorino VU

FIAT







9005106 OE 7591277	Bras de suspension G/D <i>L/R track control arm</i>	9005174 OE 7674825	Bras de suspension G/D <i>L/R track control arm</i>
	3 4 Avec rotule With ball joint Ø 10 TT /all models -ch 8157331 03/88-12/93		3 4 Avec rotule With ball joint Ø 10 TT /all models Ch- 8157331



Support d'amortisseur
Suspension mounting
Soporte amortiguador
Poduszka amortyzatora
Опора амортизатора





9001754 OE 50003871	Support suspension G/D <i>L/R suspension mounting</i>	2650031 OE 51963725	Support suspension G <i>Left suspension mounting</i>
	1 1.3 D 01/88-09/00		1 1.3 JTD 199A2000 01/08- 1.4i TU3A 01/08-

2650032 OE 51963726	Support suspension D <i>Right suspension mounting</i>	8005200 OE 4400895	Butée à billes G/D <i>L/R ball bearing</i>
	1 1.3 JTD 199A2000 01/08- 1.4i TU3A 01/08-		2 Ø 50 x 70 x 3.6 1.3 D 07/88-01/00

Scudo ...

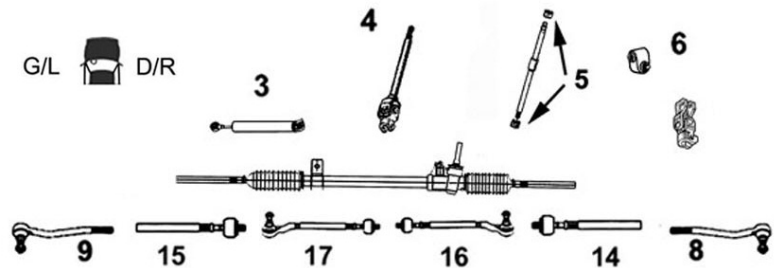
Eléments DIRECTION
Steering parts
Elementos Direcciones
Elementy uklad kierowniczy
Элементы рулевой системы



3008069 Part/oe 9566950880	Axe de bielle G/D <i>L/R axial joint</i>	7770003 OE -	Axe de bielle G/D <i>L/R axial joint</i>
	14 Côté dir. M14x1.5 Côté rot. M14x1.5 15 long 306 mm 1.6 01/95-12/03 1.9 D 01/95-12/03 1.9 TD 01/95-12/03		14 Côté dir. M16x1.5 Côté rot. M14x1.5 15 long 304 mm 1.6 JTD 04/07- 2.0 JTD 04/07-

... Scudo ...

Eléments DIRECTION
Steering parts
Elementos Direcciones
Elementy układ kierowniczy
Элементы рулевой системы

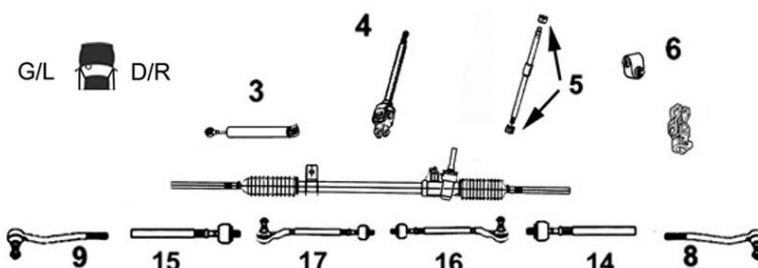

0594094 Rotule de direction G/D

OE 1306003080

L/R tie rod end



8	M14x1.5	
9		
1.6		01/95-12/03
1.9 D		01/95-12/03
1.9 D		01/04-
1.9 TD		01/95-12/03
2.0i 16v.		09/00-
2.0 JTD 95hp 69kw		02/99-
110hp 81kw		

7670011 Rotule de direction G/D

OE 9403817738

L/R tie rod end



8	M14x1.5	
9		
1.6 JTD		04/07-
2.0 JTD		04/07-



Barre stabilisatrice
Stabilizer bar
Barra estabilizadora
Drążek stabilizatora
стабилизатор поперечной устойчивости

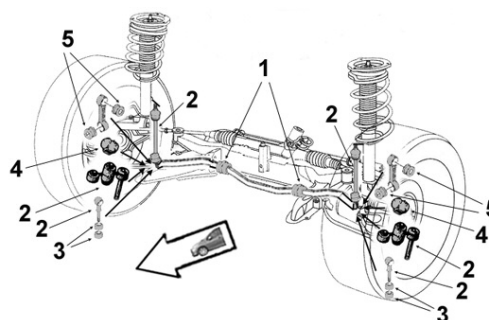

0875355 Bielle barre stab.

OE 1317425080

Stabilizer bar stub axle



2		
1.6		01/95-
1.9 D		01/95-
1.9 TD		01/95-
2.0i 16v. BVM		09/00-04/07
2.0 JTD /FAP BVM		01/04-04/07
2.0 JTD		12/99-

2300028 Bielle barre stab.

OE 1400099680

Stabilizer bar stub axle



2		
1.6 JTD BVM		04/07-
2.0 JTD /FAP BVM		04/07-

0935155 Liaison élastique

OE 1300720080

Elastic link



3	Ø int.12.5 Ø ext.37.5 long. tube int.20 ext.22	
1.6		01/95-
1.9 D		01/95-
1.9 TD		01/95-
2.0i 16v.		01/95-
2.0 JTD /FAP BVM		02/99-04/07

0945695 Palier de barre milieu

OE 1305782080

Middle bar main bearing



1	Barre Ø 24	
1.6		01/95-
1.9 D		01/95-
1.9 TD		01/95-
2.0i 16v. EW10J4 BVM		09/00-04/07
2.0 JTD DW10A/B		02/00-04/07

2300045 Palier de barre milieu

Part/oe 1400245280

Middle bar main bearing



1	Barre Ø 25 2ème montage	04/07-
1.6 JTD		12/11-
2.0i 16v.		12/11-
2.0 JTD /FAP		12/11-

... Scudo ...



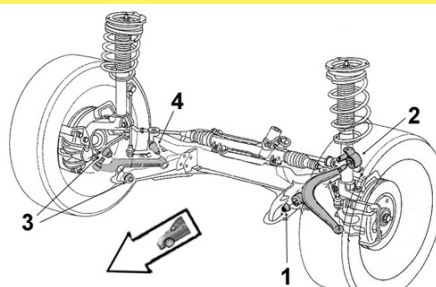

Eléments SUSPENSION
Suspension parts
Elementos suspensión
Elementy zawieszenia
Элементы подвески









FIAT





9001719 OE 1305551080	Articulation AR G <i>Left rear bush</i>	9001716 OE 1305552080	Articulation AR D <i>Right rear bush</i>
	2 1.6 1.9 D 1.9 TD 01/95- 01/95- 01/95-		2 1.6 1.9 D 1.9 TD 01/95- 01/95- 01/95-

9001724 OE 1312317080	Articulation AV <i>Front bush</i>
	1 1.6 1.9 D 1.9 TD 01/95- 01/95- 01/95-

Bras & Triangle de suspension <i>Control arm</i> <i>Brazo y triángulo</i> <i>Wahacz</i> <i>Рычаг подвески</i>	G/L  D/R	 2  4	 1  3
--	---	--	--

5203943 OE 1317389080	Triangle de susp. G <i>Left track control arm</i>	5213643 OE 71737048	Triangle de susp. D <i>Right track control arm</i>
	4 Avec rotule <i>With ball joint</i> 1.6 1.9 D 1.9 TD 2.0i 16v. 2.0 JTD 01/95-12/03 01/95- 01/95- 12/03 09/00- 02/99-01/07/06		3 Avec rotule <i>With ball joint</i> 1.6 1.9 D 1.9 TD 2.0i 16v. 2.0 JTD 01/95-12/03 01/95- 01/95- 12/03 09/00- 02/99-01/07/06

7470021 OE 1356065080	Triangle de susp. G <i>Left track control arm</i>	7470022 OE 1356066080	Triangle de susp. D <i>Right track control arm</i>
	4 Avec rotule <i>With ball joint</i> 2.0 JTD 95hp 70kw 01/07/06-04/07		3 Avec rotule <i>With ball joint</i> 2.0 JTD 95hp 70kw 01/07/06-04/07

... Scudo

SASIC

FIAT

Bras & Triangle de suspension

Control arm
Brazo y triángulo
Wahacz
Рычаг подвески

G/L  D/R

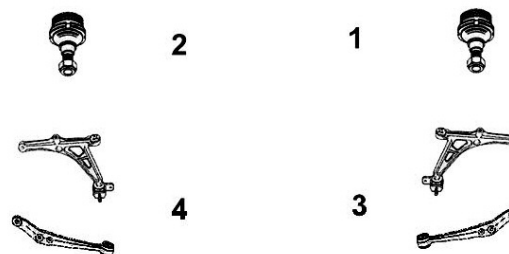

7470001

Triangle de susp. G

OE 1497408080

Left track control arm

4 Avec rotule *With ball joint*



1.6 JTD
2.0 JTD

04/07-
04/07-

7470002

Triangle de susp. D

OE 1497407080

Right track control arm

3 Avec rotule *With ball joint*



1.6 JTD
2.0 JTD

04/07-
04/07-



Support d'amortisseur

Suspension mounting
Soporte amortiguador
Poduszka amortyzatora
Опора амортизатора

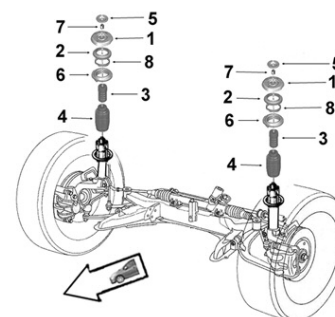

0385165

Support suspension G

OE 9405038689

Left suspension mounting

1



1.6
1.9 D
1.9 TD

01/95-
01/95-
01/95-

0385175

Support suspension D

OE 9405038709

Right suspension mounting

1



1.6
1.9 D
1.9 TD

01/95-
01/95-
01/95-

9005370

Butée à billes G/D

OE 1303672080

L/R ball bearing

2 Ø 78 x 128 x 45.5



1.6
1.9 D
1.9 TD
2.0i 16v.

01/95-
01/95-
01/95-
07/02-

0335395

Butée de suspension G/D

OE 1307021080

L/R suspension bush

3 H105



1.6
1.9 D
1.9 TD
2.0i 16v.
2.0 JTD

01/95-
01/95-
01/95-
07/02-
07/02-

Eléments TRAIN ARRIERE

Rear axle parts
Tren TRAS
Elementy zawieszenia tylnego
элементы задней оси.



1525615

Articulation essieu AR

OE 1479759080

Rear axle bush

Ø int.12 Ø ext.46 long. tube int.60 ext.48



1.6
1.9 D
1.9 TD

01/95-
01/95-
01/95-

Strada ...

Eléments DIRECTION

Steering parts

Elementos Direcciones

Elementy układ kierowniczy

Элементы рулевой системы

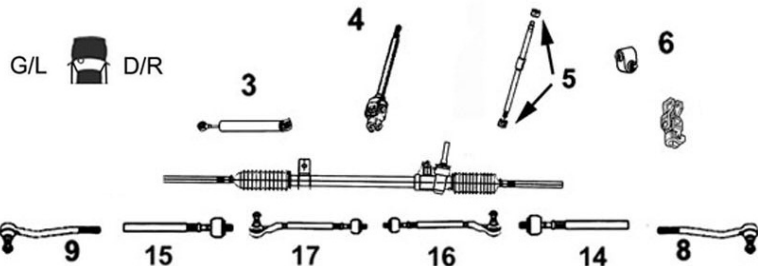

9006655

Rotule de direction G

OE 46456189

Left tie rod end



9

M14 x 1.5

1.2	01/01-06/06
1.3 JTD	07/06-
1.7 TDS	01/01-10/01
1.9 D	01/01-06/06
1.9 JTD	04/03-06/06

9006657

Rotule de direction D

OE 46456660

Right tie rod end



8

M14 x 1.5

1.2	01/01-06/06
1.3 JTD	07/06-
1.7 TDS	01/01-10/01
1.9 D	01/01-06/06
1.9 JTD	04/03-06/06



Eléments SUSPENSION

Suspension parts

Elementos suspensión

Elementy zawieszenie

Элементы подвески

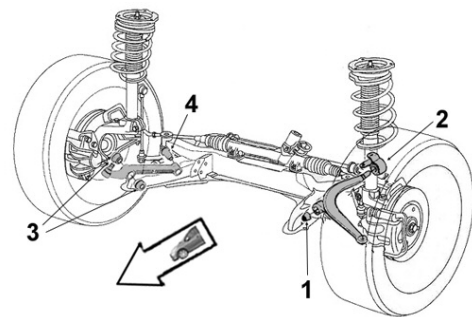

2256017

Articulation AR G

Part/oe 51769074

Left rear bush



2

Ø int. 20

1.2i	BVM	01/01-
1.3 JTD	BVM	07/06-
1.7 TDS	BVM	01/01-10/01
1.9 D	BVM	01/01-06/06
1.9 JTD	BVM	04/03-06/06

2256015

Articulation AR D

Part/oe 51769073

Right rear bush



2

Ø int. 20

1.2i	BVM	01/01-
1.3 JTD	BVM	07/06-
1.7 TDS	BVM	01/01-10/01
1.9 D	BVM	01/01-06/06
1.9 JTD	BVM	04/03-06/06

2256014

Articulation AV

OE 46421522

Front bush



1

Ø int. 12 Ø ext. 30 coll. 44.5 long. tube int. 54.5 ext. 38

1.2i	BVM	01/01-06/06
1.7 TDS	BVM	01/01-10/01
1.9 D	BVM	01/01-06/06
1.9 JTD	BVM	04/03-06/06

... Strada

SASIC

FIAT

Bras & Triangle de suspension

Control arm
Brazo y triángulo
Wahacz
Рычаг подвески

G/L  D/R

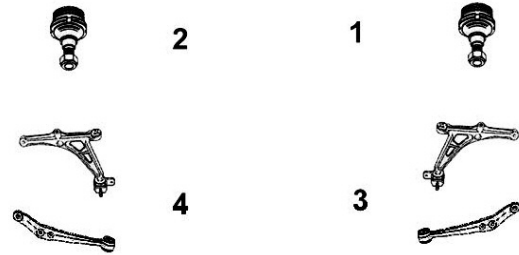

9005803

OE 51866701

Triangle de susp. G

Left track control arm

4 Avec rotule *With ball joint*



1.2i	01/01-06/06
1.7 TDS	01/01-10/01
1.9 D	01/01-06/06
1.9 JTD	01/03-06/06

9005802

OE 51866700

Triangle de susp. D

Right track control arm

3 Avec rotule *With ball joint*



1.2i	01/01-06/06
1.7 TDS	01/01-10/01
1.9 D	01/01-06/06
1.9 JTD	01/03-06/06

9005530

OE 7082812

Rotule de susp. G/D

L/R suspension ball joint

1
2



1.3 JTD

01/12-



Support d'amortisseur

Suspension mounting
Soporte amortiguador
Poduszka amortyzatora
Опора амортизатора

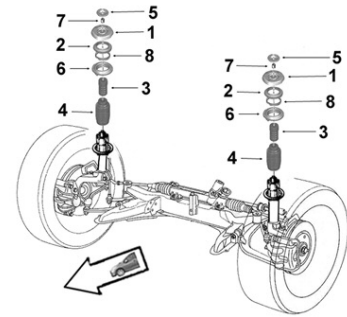

9005617

OE 46760674

Support suspension G

Left suspension mounting

1



1.2	01/01-06/06
1.3 JTD	07/06-
1.7 TDS	01/01-10/01
1.9 D	01/01-06/06
1.9 JTD	04/03-06/06

9005618

OE 46760673

Support suspension D

Right suspension mounting

1

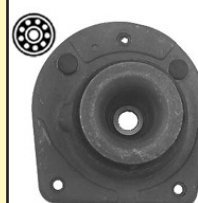

1.2	01/01-06/06
1.3 JTD	07/06-
1.7 TDS	01/01-10/01
1.9 D	01/01-06/06
1.9 JTD	04/03-06/06

B-Max

Eléments DIRECTION

Steering parts

Elementos Direcciones

Elementy układ kierowniczy

Элементы рулевой системы

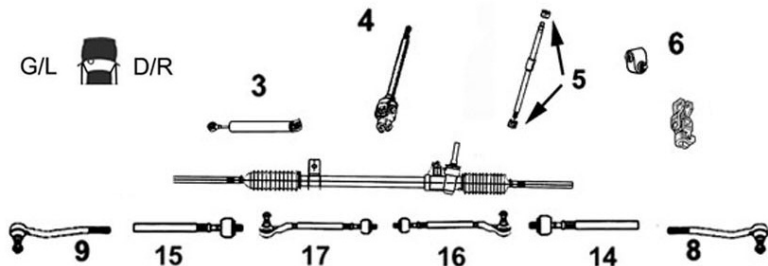

7776082

Axe de bielle G/D

OE 1545457

L/R axial joint

NEW



14 Côté dir. M14x1.5 Côté rot. M14x1.5
15

1.0 Turbo	08/12-
1.4i	08/12-
1.5 TDCi	08/12-
1.6i	08/12-
1.6 TDi	08/12-

7676091

Rotule de direction G

OE 1545339

Left tie rod end

NEW



9 M14 x 1.5

1.0 Turbo	06/12-
1.4i	06/12-
1.5 TDCi FAP	06/12-
1.6	06/12-
1.6 TDi FAP	06/12-

7676092

Rotule de direction D

OE 1545338

Right tie rod end

NEW



8 M14 x 1.5

1.0 Turbo	06/12-
1.4i	06/12-
1.5 TDCi FAP	06/12-
1.6	06/12-
1.6 TDi FAP	06/12-

C-Max ...

Eléments DIRECTION

Steering parts

Elementos Direcciones

Elementy układ kierowniczy

Элементы рулевой системы

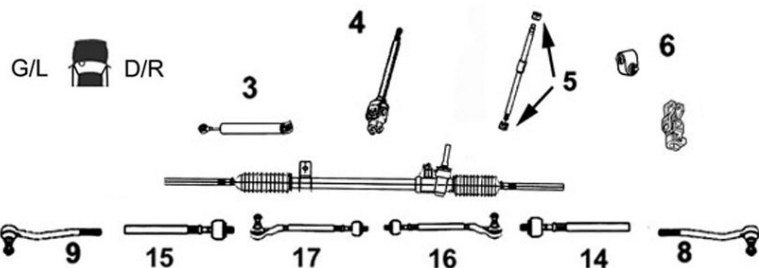

9006839

Axe de bielle G/D

OE 1510270

L/R axial joint



14 Côté dir. M14x1.5 Côté rot. M16x1.5 long 288 mm
15

1.6i 16v.	09/03-09/10
1.6 TDCi	09/03-09/10
1.8i 16v.	09/03-09/10
1.8 TDCi	04/05-09/10
2.0i 16v.	03/04-09/10
2.0 TDCi	06/04-09/10

7676067

Rotule de direction G

OE 1714700

Left tie rod end

NEW



9 M16 x 1.5 L130

1.0i Turbo	09/12-
1.6i /Turbo	09/10-
1.6 TDCi	09/10-
2.0 TDCi	09/10-

7676068

Rotule de direction D

OE 1714576

Right tie rod end

NEW



8 M16 x 1.5 L130

1.0i Turbo	09/12-
1.6i /Turbo	09/10-
1.6 TDCi	09/10-
2.0 TDCi	09/10-

... C-Max ...

Eléments DIRECTION
Steering parts
Elementos Direcciones
Elementy układ kierowniczy
Элементы рулевой системы

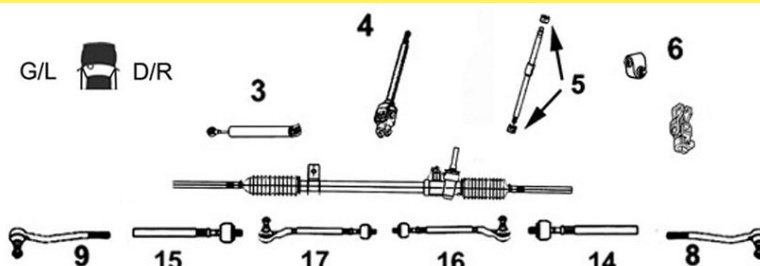

9006690

Rotule de direction G

OE 1317447

Left tie rod end



9

M16 x 1.5

1.6i 16v.	-23/07/10
1.6 TDCi	-23/07/10
1.8i 16v.	-23/07/10
1.8 TDCi	-23/07/10
2.0i 16v.	-23/07/10
2.0 TDCi	-23/07/10

9006689

Rotule de direction D

OE 1328877

Right tie rod end



8

M16 x 1.5

1.6i 16v.	-23/07/10
1.6 TDCi	-23/07/10
1.8i 16v.	-23/07/10
1.8 TDCi	-23/07/10
2.0i 16v.	-23/07/10
2.0 TDCi	-23/07/10



Barre stabilisatrice

Stabilizer bar
Barra estabilizadora
Drażek stabilizatora
стабилизатор поперечной устойчивости

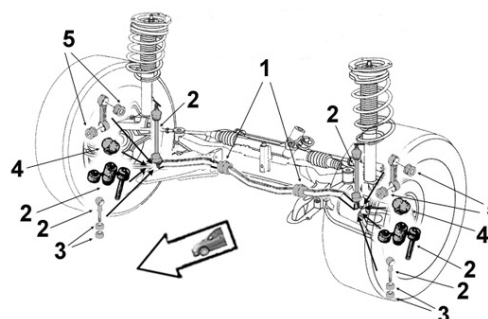

2306024

Biellette barre stab.

OE 1230909

Stabilizer bar stub axle



2

1.6i 16v.	BVM	04/04-
1.6 TDCi		09/03-
1.8i 16v.		09/03-
1.8 TDCi	BVM	04/05-
2.0i 16v.		03/04-
2.0 TDCi		06/04-

2306113

Palier de barre milieu

OE 1305960

Middle bar main bearing



1

repère orange orange mark

1.6i 16v.	09/03-09/10
1.6 TDCi	09/03-09/10
1.8i 16v.	09/03-09/10
1.8 TDCi	04/05-09/10
2.0i 16v.	03/04-09/10
2.0 TDCi	06/04-09/10



Eléments SUSPENSION

Suspension parts
Elementos suspensión
Elementy zawieszenie
Элементы подвески

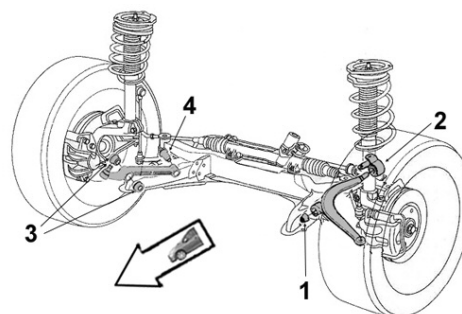

2256021

Articulation AR

Part/oe 1328380

Rear bush



2

Ø int.22

1.6i 16v.	BVM	09/03-
1.6 TDCi		09/03-03/07
1.8i 16v.		09/03-
1.8 TDCi	BVM	04/05-03/07
2.0i 16v.		03/04-
2.0 TDCi	BVM	06/04-03/07

2256020

Articulation AV

Part/oe 1328380

Front bush



1

**Ø int. 14 Ø ext. 41 coll. 45.5
 long. tube int. 65 ext 31.5**

1.6i 16v.	BVM	09/03-
1.6 TDCi		09/03-03/07
1.8i 16v.		09/03-
1.8 TDCi	BVM	04/05-03/07
2.0i 16v.		03/04-
2.0 TDCi	BVM	06/04-03/07

... C-Max ...

Bras & Triangle de suspension

Control arm
Brazo y triángulo
Wahacz
Рычаг подвески

G/L  D/R

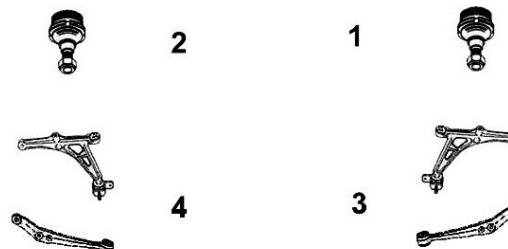

FORD

SASIC

9005814

Triangle de susp. G

OE 1570748

Left track control arm



4 Avec rotule With ball joint
Cône Ø 15 - Ø 18

1.6i 16v.	04/04-03/07
1.6 TDCi /FAP	06/04-03/07
1.8i 16v. /ETH	06/04-03/07
1.8 TDCi	04/04-03/07
2.0i 16v.	03/04-03/07
2.0 TDCi /FAP	06/04-03/07

9005813

Triangle de susp. D

OE 1570750

Right track control arm



3 Avec rotule With ball joint
Cône Ø 15 - Ø 18

1.6i 16v.	04/04-03/07
1.6 TDCi /FAP	06/04-03/07
1.8i 16v. /ETH	06/04-03/07
1.8 TDCi	04/04-03/07
2.0i 16v.	03/04-03/07
2.0 TDCi /FAP	06/04-03/07

7476192

Triangle de susp. G

OE 1570285

Left track control arm

NEW



4 Avec rotule With ball joint
Cône Ø 18 - Ø 21

1.6i 16v.	06/04-09/10
1.6 TDCi /FAP	06/04-09/10
1.8i 16v. /ETH	06/04-09/10
1.8 TDCi	06/04-09/10
2.0i 16v.	06/04-09/10
2.0 TDCi /FAP	06/04-09/10

7476193

Triangle de susp. D

OE 1570284

Right track control arm

NEW



3 Avec rotule With ball joint
Cône Ø 18 - Ø 21

1.6i 16v.	06/04-09/10
1.6 TDCi /FAP	06/04-09/10
1.8i 16v. /ETH	06/04-09/10
1.8 TDCi	06/04-09/10
2.0i 16v.	06/04-09/10
2.0 TDCi /FAP	06/04-09/10

9005527

Rotule de susp. G/D

OE 1679384

L/R suspension ball joint



1
2 Cône Ø 15 - Ø 18

1.6i 16v.	04/04-03/07
1.6 TDCi /FAP	06/04-03/07
1.8i 16v. /ETH	06/04-03/07
1.8 TDCi	04/04-03/07
2.0i 16v.	03/04-03/07
2.0 TDCi /FAP	06/04-03/07

7576041

Rotule de susp. G/D

OE 1679388

L/R suspension ball joint

NEW



1
2 Cône Ø 18 - Ø 21

1.6i 16v.	04/04-09/10
1.6 TDCi /FAP	06/04-09/10
1.8i 16v. /ETH	06/04-09/10
1.8 TDCi	04/04-09/10
2.0i 16v.	03/04-09/10
2.0 TDCi /FAP	06/04-09/10



Support d'amortisseur

Suspension mounting
Soporte amortiguador
Poduszka amortyzatora
Опора амортизатора

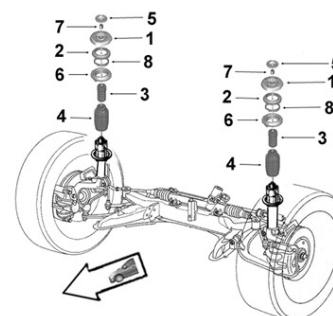

2656023

Support suspension

OE 1377612

Suspension mounting



1

1.6i 16v.	09/03-09/10
1.6 TDCi	09/03-09/10
1.8i 16v.	09/03-09/10
1.8 TDCi	04/05-09/10
2.0i 16v.	03/04-09/10
2.0 TDCi	02/08-09/10

... C-Max

SASIC

FORD



Barre stabilisatrice
 Stabilizer bar
 Barra estabilizadora
 Drążek stabilizatora
 стабилизатор поперечной устойчивости

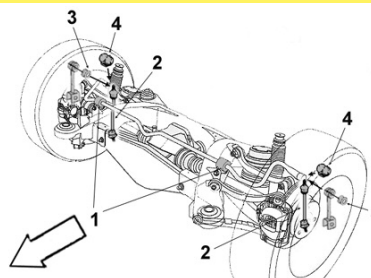

2306031

OE 1719542

Biellette barre stab.

Stabilizer bar stub axle

NEW

2



1.6i 16v.	BVM	09/03-
1.6 TDCi /DPF		09/03-
1.8i 16v. /ETH		09/03-
1.8 TDCi	BVM	04/05-
2.0i 16v.		03/04-
2.0 TDCi /DPF		06/04-

2306030

OE 1469208

Biellette barre stab.

Stabilizer bar stub axle

2



1.6i 16v.	BVM	03/07-09/10
1.6 TDCi /DPF		03/07-
1.8i 16v. 125hp 92kw /ETH		04/04-
1.8 TDCi	BVM	03/07-
2.0i 16v.		03/04-
2.0 TDCi /DPF		06/04-

2306097

OE 1337965

Palier de barre milieu

Middle bar main bearing

1 repère vert green mark



1.6i 16v.	Sauf Grand C-Max	09/03-
1.6i Turbo	Sauf Grand C-Max	09/10-
1.6 TDCi	Sauf Grand C-Max	09/03-
1.8i 16v.		09/03-09/10
1.8 TDCi		04/05-09/10
2.0i 16v.		03/04-09/10
2.0 TDCi	Sauf Grand C-Max	06/04-

2306110

OE 1337964

Palier de barre milieu

Middle bar main bearing

1 Repère mauve mauve mark



1.6i 16v.	Grand C-Max	09/10-
1.6i Turbo	Grand C-Max	09/10-
1.6 TDCi FAP	Grand C-Max	09/10-
2.0 TDCi FAP	Grand C-Max	09/10-



Support d'amortisseur
 Suspension mounting
 Soporte amortiguador
 Poduszka amortyzatora
 Опора амортизатора

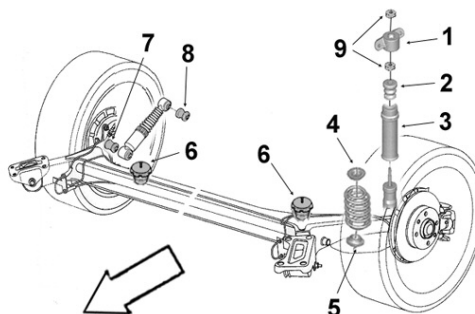

2656037

OE 1300459

Support suspension G/D

L/R suspension mounting

1



1.6i 16v.	09/03-09/10
1.6 TDCi	09/03-09/10
1.8i 16v.	09/03-09/10
1.8 TDCi	04/05-09/10
2.0i 16v.	03/04-09/10
2.0 TDCi	06/04-09/10

Cougar

Eléments DIRECTION

Steering parts

Elementos Direcciones

Elementy układ kierowniczy

Элементы рулевой системы

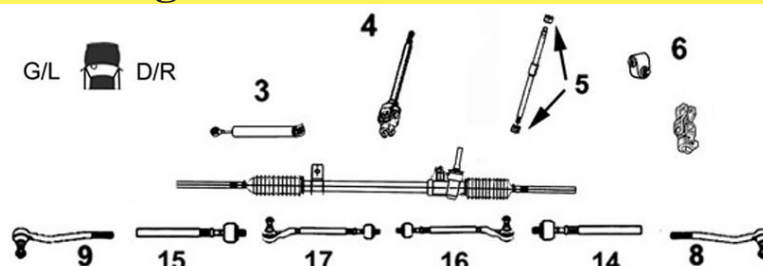

9006462

Rotule de direction G

OE 1097323

Left tie rod end



9 M16 x 1.5

TT /all models 04/99-

9006461

Rotule de direction D

OE 1097316

Right tie rod end



8 M16 x 1.5

TT /all models 04/99-



Barre stabilisatrice

Stabilizer bar

Barra estabilizadora

Drażek stabilizatora

стабилизатор поперечной устойчивости

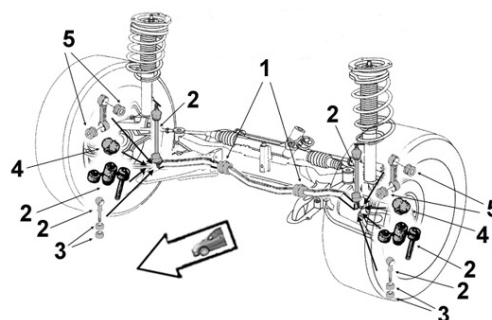

9005063

Biellette barre stab.

OE 6960036

Stabilizer bar stub axle



2 Acier steel
Entraxe : 232 mm M10x150 X2

2.0i 16v.
2.5 V6

BVM BVA

2306033

Palier de barre

OE 1128725

Bar main bearing



1 Ø 19

2.0i 16v.
2.5 V6



Support d'amortisseur

Suspension mounting

Soporte amortiguador

Poduszka amortyzatora

Опора амортизатора

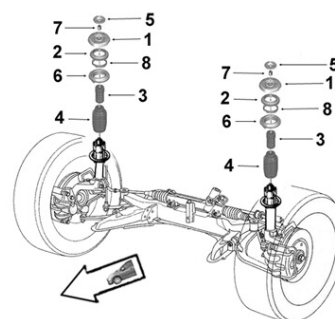

2656034

Butée de suspension G/D

OE 1023328

L/R suspension bush



3

2.0i 16v. 10/98-15/08/00
2.5 V6 10/98-15/08/00

9001456

Support suspension G/D

OE 6799585

L/R suspension mounting



1







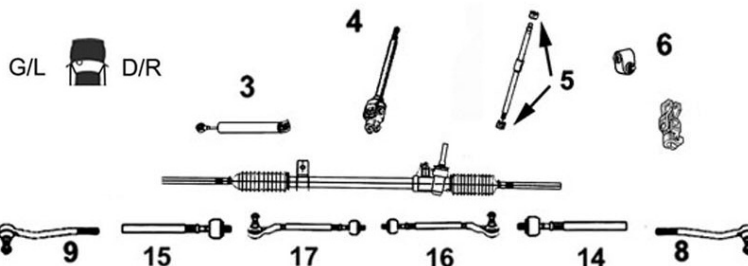

2.5 V6 BVM BVA

Escort ...

Eléments DIRECTION
Steering parts
Elementos Direcciones
Elementy układ kierowniczy
Элементы рулевой системы



FORD

<p>9006221 OE 1652651</p> 	<p>Axe de bielle G/D <i>L/R axial joint</i></p> <p>14 M14 x 1.5 1/2x20pouces 290 mm 15</p> <p>1.1 09/80-12/85 1.3 09/80-12/85 1.6 D 09/80-12/85</p> <p>TT /all models 01/86-08/90</p>	<p>9006222 OE 6180350</p> 	<p>Axe de bielle G/D <i>L/R axial joint</i></p> <p>14 Côté dir. M14x1.5 Côté rot. M14x2.0 15 long 323 mm</p> <p>TT /all models DNA 09/90-</p>	
<p>9006223 OE 6197238</p> 	<p>Axe de bielle G/D <i>L/R axial joint</i></p> <p>14 Côté dir. M14x1.5 Côté rot. M14x2.0 15 long 308 mm</p> <p>TT /all models Sauf Cosworth 4WD DA 09/90-12/94</p> <p>TT /all models DA 01/95-</p>	<p>9006227 OE 6185338</p> 	<p>Axe de bielle G/D <i>L/R axial joint</i></p> <p>14 Côté dir. M14x1.5 Côté rot. M14x2.0 15 long 294 mm</p> <p>2.0i Cosworth 4WD 05/94-01/95</p>	
<p>9006350 OE 1015547</p> 	<p>Rotule de direction G <i>Left tie rod end</i></p> <p>9 M14 x 2</p> <p>TT /all models Sauf Cosworth 4WD 09/90-12/94</p> <p>1.3 01/95-06/98 1.4 01/95-06/98 1.6 01/95-06/98 1.8 01/95-06/98 1.8 D TD 01/95-06/98</p>	<p>9006351 OE 1015546</p> 	<p>Rotule de direction D <i>Right tie rod end</i></p> <p>8 M14 x 2</p> <p>TT /all models Sauf Cosworth 4WD 09/90-12/94</p> <p>1.3 01/95-06/98 1.4 01/95-06/98 1.6 01/95-06/98 1.8 01/95-06/98 1.8 D TD 01/95-06/98</p>	
<p>9006352 OE 5021410</p> 				<p>Rotule de direction G/D <i>L/R tie rod end</i></p> <p>8 M1/2 x 20 pouces 9</p> <p>TT /all models 01/86-08/90 1.1 1100 09/80-12/85 1.3 1300 09/80-12/85 1.6 D 09/80-12/85</p>
<p>9006353 OE 6120232</p> 	<p>Rotule de direction G <i>Left tie rod end</i></p> <p>9 M14 x 2</p> <p>2.0i Cosworth 4WD 09/90-12/94</p>	<p>9006354 OE 6120231</p> 	<p>Rotule de direction D <i>Right tie rod end</i></p> <p>8 M14 x 2</p> <p>2.0i Cosworth 4WD 09/90-12/94</p>	

... Escort ...



Barre stabilisatrice
Stabilizer bar
Barra estabilizadora
Drażek stabilizatora
 стабилизатор поперечной устойчивости

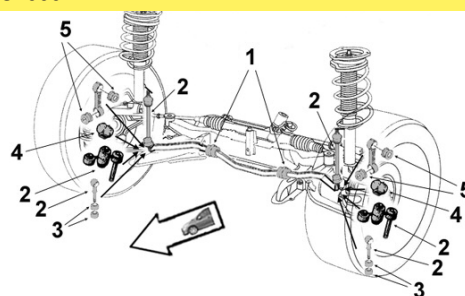

FORD



9005064 **Biellette barre stab.**
 OE 1067818 *Stabilizer bar stub axle*



2	Acier steel	
1.3		01/95-
1.4i		10/92-
1.6i		10/93-
1.8i		10/92-
1.8 XR3i		04/96-02/97
1.8 D		10/92-
1.8 TD		07/93-
2.0i RS/Cosworth 4WD		01/95-03/96
2.0i RS		10/92-01/95

9001534 **Palier de barre milieu**
 OE 7102392 *Middle bar main bearing*



1	Barre Ø 18	
1.1		01/91-
1.3		01/91-
1.4		01/91-
1.6 /i 16v.		01/91-08/00
1.8		01/91-
1.8 D		01/91-
1.8 TD		10/92-08/00
2.0i RS		10/92-03/96

9001600 **Palier de barre milieu**
 OE 1634900 *Middle bar main bearing*



1	Barre Ø 22	
1.3		-12/90
1.4		-12/90
1.6		-12/90
1.6i		-12/90
1.6 D		-12/90
1.8 D		-12/90



Eléments SUSPENSION
Suspension parts
Elementos suspensión
Elementy zawieszenie
 Элементы подвески

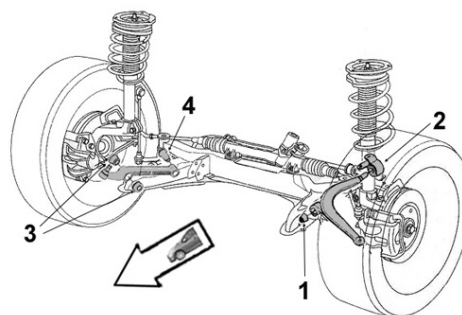

9001690 **Articulation int.**
 OE 6192705 *Inner bush*



4	Ø int.12 Ø ext.35 coll.40 x2 long. tube int.51 ext.30 ep. coll.5	
1.1		-12/90
1.3		-12/90
1.4		-12/90
1.6		-12/90
1.6 D		-12/90
1.8 D		-12/90
2.0i Cosworth 4WD		05/94-01/95

9001689 **Articulation AV**
 OE 1000445 *Front bush*



1	Ø int.12 Ø ext.46 long. tube int.45 ext.25	
1.1		01/91-
1.3		01/91-
1.4		01/91-
1.6		01/91-
1.8		01/91-
1.8 D		01/91-
1.8 TD		01/91-

9001595 **Articulation AR**
 OE 1035929 *Rear bush*









2	Ø int.12 Ø ext.54 coll.62 long. tube int.45.5 ext.24.5 coll.3	
1.1		01/91-
1.3		01/91-
1.4		01/91-
1.6		01/91-
1.8		01/91-
1.8 D		01/91-
1.8 TD		01/91-

... Escort ...

Bras & Triangle de suspension

Control arm
Brazo y triángulo
Wahacz
Рычаг подвески

G/L  D/R

9005110 OE 1637185	Bras de suspension G <i>Left track control arm</i>	9005111 OE 1637183	Bras de suspension D <i>Right track control arm</i>
	4 Avec rotule <i>With ball joint</i> TT /all models 01/86-08/90		3 Avec rotule <i>With ball joint</i> TT /all models 01/86-08/90
9005112 OE 6087889	Bras de suspension G <i>Left track control arm</i>	9005113 OE 6087888	Bras de suspension D <i>Right track control arm</i>
	4 Avec rotule <i>With ball joint</i> 1.1 1100 05/83-12/85 1.3 1300 09/80-12/85 1.6 D 09/80-12/85		3 Avec rotule <i>With ball joint</i> 1.1 1100 05/83-12/85 1.3 1300 09/80-12/85 1.6 D 09/80-12/85
9005118 OE 6770225	Triangle de susp. G <i>Left track control arm</i>	9005117 OE 6615742	Triangle de susp. D <i>Right track control arm</i>
	4 Avec rotule <i>With ball joint</i> TT /all models 08/90-01/95 Sauf Cosworth RS2000 1.3 01/95- 1.4 01/95- 1.6 01/95- 1.8 01/95- 1.8 D 01/95- 1.8 TD 01/95-		3 Avec rotule <i>With ball joint</i> TT /all models 08/90-01/95 Sauf Cosworth RS2000 1.3 01/95- 1.4 01/95- 1.6 01/95- 1.8 01/95- 1.8 D 01/95- 1.8 TD 01/95-
9005127 OE 6154290	Bras de suspension G <i>Left track control arm</i>	9005126 OE 6154289	Bras de suspension D <i>Right track control arm</i>
	4 Avec rotule <i>With ball joint</i> 2.0i Cosworth 4WD 05/94-01/95		3 Avec rotule <i>With ball joint</i> 2.0i Cosworth 4WD 05/94-01/95
9005240 Part/oe 6525844	Rotule de susp. inf. G/D <i>L/R lower suspension ball joint</i>		
	1 2 points d'ancrage 2 Cramping points Ø 17 2 TT /all models 09/90-12/94		

... Escort



Support d'amortisseur
Suspension mounting
Soporte amortiguador
Poduszka amortyzatora
Опора амортизатора

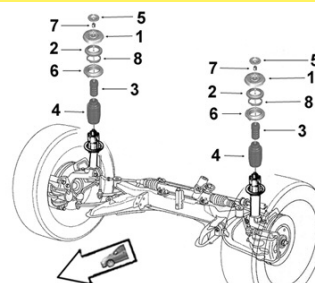

FORD



9005610

Support suspension G/D

OE 6495311

L/R suspension mounting



1

1.1	-01/95
1.3	-01/95
1.4	-01/95
1.6	-01/95
1.8	-01/95
1.8 D	-01/95
1.8 TD	-01/95

9001458

Support suspension G/D

OE 7350847

L/R suspension mounting



1

1.3	01/95-08/95
1.4	01/95-
1.6	01/95-
1.8	01/95-
1.8 D	01/95-
1.8 TD	01/95-

Eléments TRAIN ARRIERE

Rear axle parts
Tren TRAS
Elementy zawieszenia tylnego
элементы задней оси.



9001787

Articulation essieu G/D

OE 1041979

L/R axle bush



Ø int.12 Ø ext.64 coll.75 coll.70 long. tube int.70 ext.49 coll.6 coll.5

1.4	01/98-
1.6	01/98-
1.8	01/98-
1.8 TD	01/98-

Fiesta I/II 76-89 ...

Eléments DIRECTION

Steering parts
Elementos Direcciones
Elementy uklad kierowniczy
Элементы рулевой системы

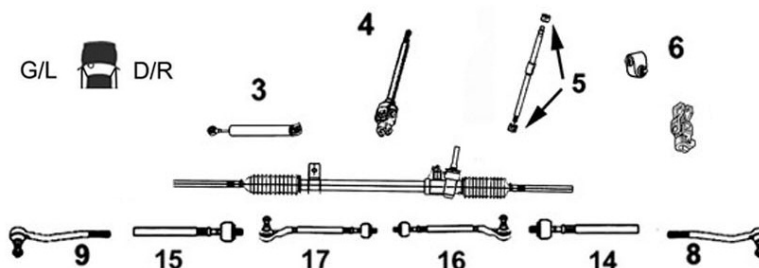

9006352

Rotule de direction G/D

OE 5021410

L/R tie rod end



8
9

M1/2 x 20 pouces

TT /all models

08/83-01/89

... Fiesta I/II 76-89 ...



Eléments SUSPENSION

Suspension parts
Elementos suspensión
Elementy zawieszenie
Элементы подвески

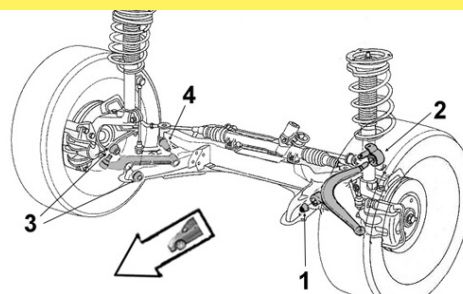

9001587

Articulation int.

OE 1619120

Inner bush

4 Ø int.10 Ø ext.33 coll.38 long. tube int.51 ext.24 ep. coll.7



1.0
1.1
1.3
1.4
1.6
1.6 D

01/84-12/89
01/84-12/89
01/84-12/89
01/84-12/89
01/84-12/89
01/84-12/89

Bras & Triangle de suspension

Control arm
Brazo y triángulo
Wahacz
Рычаг подвески

G/L D/R

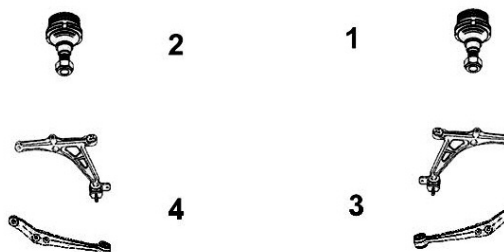

9005241

Rotule de susp. inf. G/D

OE 5021426

L/R lower suspension ball joint

1
2



TT /all models

08/83-01/89

Fiesta III 89-95 FA/B/V...

Eléments DIRECTION

Steering parts
Elementos Direcciones
Elementy układ kierowniczy
Элементы рулевой системы

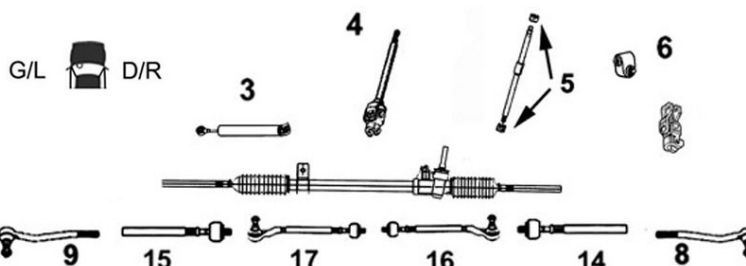

9006220

Axe de bielle G/D

OE 1659374

L/R axial joint

14
15 M14 x 1.5 1/2x20pouces 300 mm



TT /all models

01/89-12/95

9006352

Rotule de direction G/D

OE 5021410

L/R tie rod end

8
9 M1/2 x 20 pouces



TT /all models

01/89-01/94

... Fiesta III 89-95 FA/B/V...

FORD



9006357 OE 1034417	Rotule de direction G/D <i>L/R tie rod end</i> M1/2 x 20 pouces TT /all models 01/94-12/95	9004007 OE 7257202	Cardan colonne de direction <i>Cardan joint</i> TT /all models 01/89-08/95
------------------------------	---	------------------------------	--



Barre stabilisatrice
Stabilizer bar
Barra estabilizadora
Drażek stabilizatora
 стабилизатор поперечной устойчивости

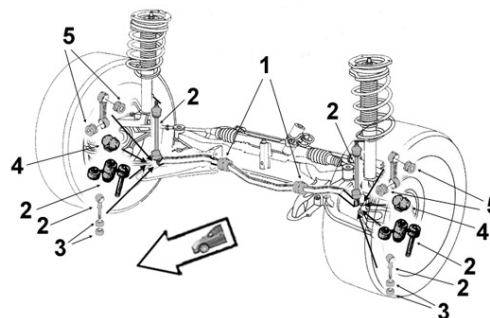

9005064 OE 1067818	Biellette barre stab. <i>Stabilizer bar stub axle</i> 2 Acier steel 1.1 01/89- 1.3 01/89- 1.4 01/89- 1.6 XR2 turbo 01/89- 1.8i XR2 01/94-01/96 1.8 D 01/89- 1.8 TD 01/89-
------------------------------	--



9001518 OE 1652936	Palier de barre milieu <i>Middle bar main bearing</i> 1 Barre Ø 12 1.3 01/89- 1.4 01/89-	9001534 OE 7102392	Palier de barre milieu <i>Middle bar main bearing</i> 1 Barre Ø 18 1.6 01/94- 1.8i XR2 01/94-01/96
------------------------------	---	------------------------------	---

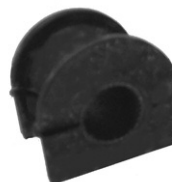

Eléments SUSPENSION
Suspension parts
Elementos suspensión
Elementy zawieszenia
 Элементы подвески

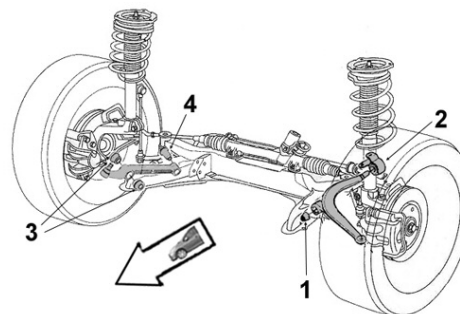

9001595 OE 1035929	Articulation AR <i>Rear bush</i> 2 Ø int.12 Ø ext.54 coll.62 long. tube int.45.5 ext.24.5 coll.3 1.0 1.1 01/89-07/95 1.3 sauf Mot. ZETEC & ENDURA 01/89-07/95 1.4 sauf Mot. ZETEC & ENDURA 01/89-07/95 1.6 sauf Mot. ZETEC & ENDURA 01/89-07/95 1.8 D TD 01/89-07/95	9001689 OE 1000445	Articulation AV <i>Front bush</i> 1 Ø int.12 Ø ext.46 long. tube int.45 ext.25 1.0 01/89-07/95 1.1 01/89-07/95 1.3 01/89-07/95 1.4 01/89-07/95 1.6 01/89-07/95 1.8 D 01/89-07/95 1.8 TD 01/89-07/95
------------------------------	--	------------------------------	--



... Fiesta III 89-95 FA/B/V ...

SASIC

FORD



Bras & Triangle de suspension

Control arm
Brazo y triángulo
Wahacz
Рычаг подвески

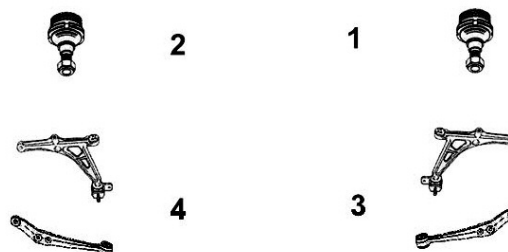
G/L  D/R





... Fiesta III 89-95 FA/B/V

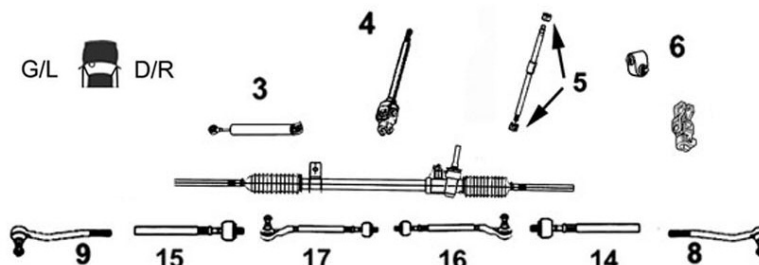

9005606 OE 6150277	Support suspension G/D <i>L/R suspension mounting</i>	9005502 OE -	Kit rép. suspension G ou D <i>L/R stabilizing bar repair kit</i>																								
	1 <table style="width: 100%; border-collapse: collapse;"> <tr><td style="width: 33%;">1.0</td><td style="width: 33%;">01/89-12/94</td><td style="width: 33%;"></td></tr> <tr><td>1.1</td><td>01/89-12/94</td><td></td></tr> <tr><td>1.3</td><td>01/89-12/94</td><td></td></tr> <tr><td>1.4</td><td>01/89-12/94</td><td></td></tr> <tr><td>1.6</td><td>01/89-12/94</td><td></td></tr> <tr><td>1.8 D</td><td>01/89-12/94</td><td></td></tr> <tr><td>1.8 TD</td><td>01/89-12/94</td><td></td></tr> </table>	1.0	01/89-12/94		1.1	01/89-12/94		1.3	01/89-12/94		1.4	01/89-12/94		1.6	01/89-12/94		1.8 D	01/89-12/94		1.8 TD	01/89-12/94			1 <table style="width: 100%; border-collapse: collapse;"> <tr><td style="width: 33%;"></td><td style="width: 33%;">TT /all models</td><td style="width: 33%;">01/89-12/94</td></tr> </table>		TT /all models	01/89-12/94
1.0	01/89-12/94																										
1.1	01/89-12/94																										
1.3	01/89-12/94																										
1.4	01/89-12/94																										
1.6	01/89-12/94																										
1.8 D	01/89-12/94																										
1.8 TD	01/89-12/94																										
	TT /all models	01/89-12/94																									

Fiesta IV/V 95-02 JB FA/B JA/V ...

Eléments DIRECTION
Steering parts
Elementos Direcciones
Elementy układ kierowniczy
Элементы рулевой системы





7776023 OE 1044014	Axe de bielle G/D <i>L/R axial joint</i>																									
	14 15 <table style="width: 100%; border-collapse: collapse;"> <tr><td colspan="2">Côté dir. M14x1.5 Côté rot. M14x2.0 long 307 mm</td></tr> <tr><td style="width: 33%;">1.0i</td><td style="width: 33%;">02/97-</td><td style="width: 33%;"></td></tr> <tr><td>1.2i 16v.</td><td>-11/01</td><td></td></tr> <tr><td>1.3i</td><td>-11/01</td><td></td></tr> <tr><td>1.4i 16v.</td><td>-11/01</td><td></td></tr> <tr><td>1.6i 16v.</td><td>02/00-11/01</td><td></td></tr> <tr><td>1.8 D</td><td>-04/00</td><td></td></tr> <tr><td>1.8 TDdi</td><td>04/00-11/01</td><td></td></tr> </table>	Côté dir. M14x1.5 Côté rot. M14x2.0 long 307 mm		1.0i	02/97-		1.2i 16v.	-11/01		1.3i	-11/01		1.4i 16v.	-11/01		1.6i 16v.	02/00-11/01		1.8 D	-04/00		1.8 TDdi	04/00-11/01			
Côté dir. M14x1.5 Côté rot. M14x2.0 long 307 mm																										
1.0i	02/97-																									
1.2i 16v.	-11/01																									
1.3i	-11/01																									
1.4i 16v.	-11/01																									
1.6i 16v.	02/00-11/01																									
1.8 D	-04/00																									
1.8 TDdi	04/00-11/01																									

9006660 OE 1020175	Rotule de direction G <i>Left tie rod end</i>
	9 M14x2 TT /all models 08/95-12/02
9006661 OE 1011857	Rotule de direction D <i>Right tie rod end</i>
	8 M14x2 TT /all models 08/95-12/02

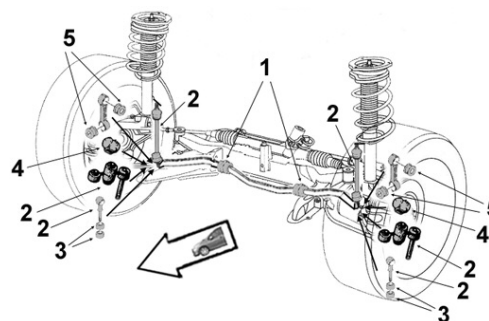

Barre stabilisatrice
Stabilizer bar
Barra estabilizadora
Drażek stabilizatora
стабилизатор поперечной устойчивости



9005064 OE 1067818	Biellette barre stab. <i>Stabilizer bar stub axle</i>																										
	2 Acier steel <table style="width: 100%; border-collapse: collapse;"> <tr><td style="width: 33%;">1.2</td><td style="width: 33%;">09/95-08/99</td><td style="width: 33%;"></td></tr> <tr><td>1.2i 16v.</td><td>09/99-</td><td></td></tr> <tr><td>1.3</td><td>09/95-</td><td></td></tr> <tr><td>1.4</td><td>02/96-08/99</td><td></td></tr> <tr><td>1.4i 16v.</td><td>09/99-</td><td></td></tr> <tr><td>1.6i 16v. LIT/V BVM</td><td>02/00-09/02</td><td></td></tr> <tr><td>1.8 D</td><td>09/95-</td><td></td></tr> <tr><td>1.8 TDdi</td><td>02/00-</td><td></td></tr> </table>	1.2	09/95-08/99		1.2i 16v.	09/99-		1.3	09/95-		1.4	02/96-08/99		1.4i 16v.	09/99-		1.6i 16v. LIT/V BVM	02/00-09/02		1.8 D	09/95-		1.8 TDdi	02/00-			
1.2	09/95-08/99																										
1.2i 16v.	09/99-																										
1.3	09/95-																										
1.4	02/96-08/99																										
1.4i 16v.	09/99-																										
1.6i 16v. LIT/V BVM	02/00-09/02																										
1.8 D	09/95-																										
1.8 TDdi	02/00-																										

... Fiesta IV/V 95-02 JB FA/B JA/V...



Barre stabilisatrice
 Stabilizer bar
 Barra estabilizadora
 Drażek stabilizatora
 стабилизатор поперечной устойчивости

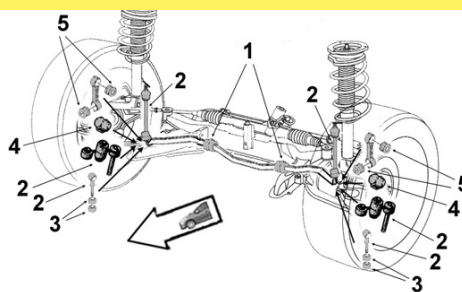

FORD



9001599

Palier de barre milieu

OE 1003609

Middle bar main bearing



1 Barre Ø 17	
1.2	09/95-
1.2i 16v.	09/99-
1.3	09/99-
1.3 sauf Courier	09/95-
1.4	02/96-
1.4i 16v.	09/99-
1.8 D sauf courier	09/95-
1.8 TDdi	02/00-

9001534

Palier de barre milieu

OE 7102392

Middle bar main bearing



1 Barre Ø 18	
1.8 D	09/99-
1.8 TDdi	02/00-09/02



Eléments SUSPENSION

Suspension parts
Elementos suspensión
Elementy zawieszenie
Элементы подвески

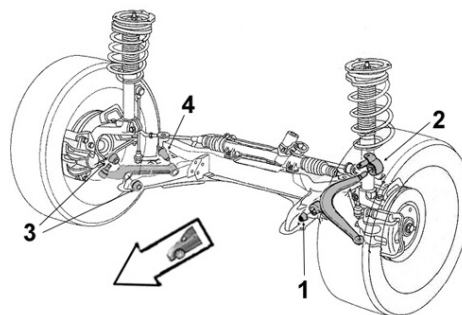

9001588

Articulation AR

OE 1014654

Rear bush



2 Ø int.12 Ø ext.66 long. tube int.50 ext.30	
1.2	09/95-
1.2i 16v.	09/99-
1.3	09/95-
1.4	02/96-
1.4i 16v.	09/99-
1.6i 16v.	02/00-
1.8 D	09/95-
1.8 TDdi	02/00-

9001594

Articulation AV

OE 1010037

Front bush



1 Ø int.12 Ø ext.37 long. tube int.62 ext.44	
sauf Moteur ZETEC et ENDURA	
1.2	08/95-09/99
1.3	08/95-09/99
1.4	08/95-09/99
1.8 D	08/95-09/99

9001596

Articulation AV

OE 1055191

Front bush



1 Ø int.12 Ø ext.38 long. tube int.62 ext.44	
1.2	09/95-
1.2i 16v.	09/99-
1.3	09/95-
1.4	02/96-
1.4i 16v.	09/99-
1.6i 16v.	02/00-
1.8 D	09/95-
1.8 TDdi	02/00-

... Fiesta IV/V 95-02 JB FA/B JA/V...

Bras & Triangle de suspension



Control arm
Brazo y triángulo
Wahacz
Рычаг подвески

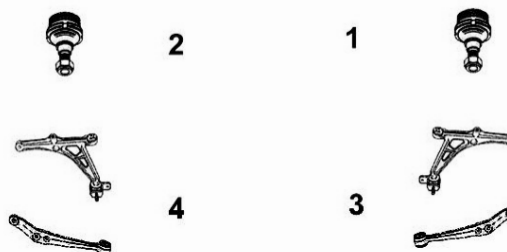

G/L  D/R



FORD



9005727 OE 1015265	Triangle de susp. G <i>Left track control arm</i>	9005728 OE 1015263	Triangle de susp. D <i>Right track control arm</i>
	4 Avec rotule <i>With ball joint</i>		3 Avec rotule <i>With ball joint</i>
	TT /all models DNA 08/95-12/02		TT /all models DNA 08/95-12/02



9005724 OE 1072279	Triangle de susp. G <i>Left track control arm</i>	9005726 OE 1330238	Triangle de susp. D <i>Right track control arm</i>
	4 Avec rotule <i>With ball joint</i>		3 Avec rotule <i>With ball joint</i>
	TT /all models DA 08/95-12/02		TT /all models DA 08/95-12/02

9005249 OE 1047797	Rotule de susp. inf. G/D <i>L/R lower suspension ball joint</i>		
	1 3 points d'ancrage <i>3 Cramping points</i>		
	TT /all models		01/96- 01/99-12/02

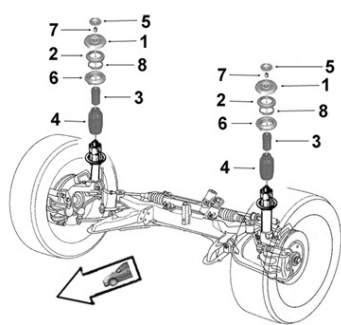

Support d'amortisseur
Suspension mounting
Soporte amortiguador
Poduszka amortyzatora
Опора амортизатора



9001454 OE 1013794	Support suspension G/D <i>L/R suspension mounting</i>	8005209 OE 1002513	Butée à billes <i>Ball bearing</i>
	1 1.2 09/95- 1.2i 16v. 09/99- 1.3 09/95- 1.4 02/96- 1.4i 16v. 09/99- 1.6i 16v. 02/00- 1.8 D 09/95- 1.8 TDdi 02/00-		2 1.2i 16v. 09/95- 1.3 09/95- 1.4 02/96- 1.4i 16v. 09/99- 1.6i 16v. 09/99- 1.8 D 09/95- 1.8 TDdi 02/00-

Les réf. constructeurs (OE) ne servent qu'à identifier les pièces et sont données à titre indicatif.

... Fiesta IV/V 95-02 JB FA/B JA/V

SASIC

FORD



Support d'amortisseur
 Suspension mounting
 Soporte amortiguador
 Poduszka amortyzatora
 Опора амортизатора

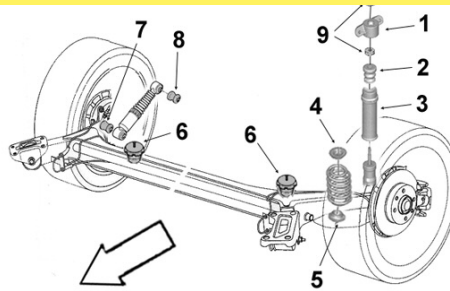

9005624 **Support suspension G/D**
 OE 1023587 *L/R suspension mounting*



1	1.2	09/95-
	1.3 sauf Courier	09/95-
	1.4	02/96-
	1.6i 16v.	02/00-09/02
	1.8 D sauf Courier	02/96-
	1.8 TDi	02/00-09/02

Eléments TRAIN ARRIERE
 Rear axle parts
 Tren TRAS
 Elementy zawieszenia tylnego
 элементы задней оси.



9001747 **Articulation essieu AR**
 OE 1016439 *Rear axle bush*
 Ø int.12 Ø ext.63 long. tube int.70 ext.55



1.2	09/95-
1.3 sauf Courier	09/95-
1.4	02/96-

Fiesta VI 02-10/08 ...

Eléments DIRECTION
 Steering parts
 Elementos Direcciones
 Elementy układ kierowniczy
 Элементы рулевой системы

G/L D/R

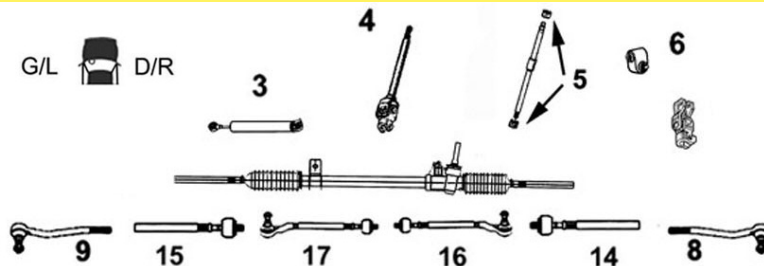

9006837 **Axe de bielle G/D**
 OE 4472940 *L/R axial joint*



14 15	Côté dir. M14x1.5 Côté rot. M14x1.5 long 276 mm	
	1.2i	05/02-
	1.3i 8v.	01/02-
	1.4i 16v.	01/02-
	1.4 TDCi	01/02-
	1.6i 16v.	01/02-
	1.6 TDCi	11/04-
	2.0i ST	03/05-

BVM /Pilotée
 BVM /Pilotée

9006663 **Rotule de direction G**
 OE 1202549 *Left tie rod end*



9	M14 x 1.5	
	1.2i	05/02-10/08
	1.3i 8v.	01/02-
	1.3	10/05-10/08
	1.4i 16v.	01/02-
	1.4 TDCi	01/02-
	1.6i 16v.	01/02-
	1.6 TDCi	01/05-10/08
	2.0i ST	-10/08

9006662 **Rotule de direction D**
 OE 1202548 *Right tie rod end*



8	M14 x 1.5	
	1.2i	05/02-10/08
	1.3i 8v.	01/02-
	1.3	10/05-10/08
	1.4i 16v.	01/02-
	1.4 TDCi	01/02-
	1.6i 16v.	01/02-
	1.6 TDCi	01/05-10/08
	2.0i ST	-10/08

... Fiesta VI 02-10/08 ...



Barre stabilisatrice
Stabilizer bar
Barra estabilizadora
Drażek stabilizatora
 стабилизатор поперечной устойчивости

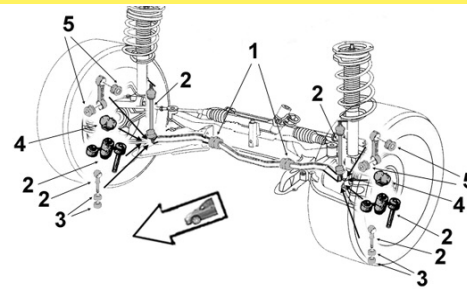

9005003 **Biellette barre stab.**
 OE 1469212 *Stabilizer bar stub axle*



2	1.2i	FUJA/B	BVM	10/05-10/08
	1.3 8v.			05/02-
	1.4i 16v.			05/02-
	1.4 TDCi			05/02-
	1.6i 16v.			05/02-
	1.6 TDCi		BVM	01/05-
	2.0i		BVM	10/05-
2.0i ST		BVM	01/05-10/05	



Eléments SUSPENSION
Suspension parts
Elementos suspensión
Elementy zawieszenie
 Элементы подвески

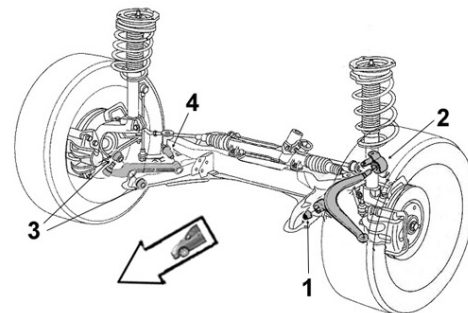

2256019 **Articulation AR**
 Part/oe 1146131 *Rear bush*



2	Ø int.22	
	1.2i	09/02-
	1.2i 16v.	05/02-
	1.3i	05/02-
	1.4i 16v.	05/02-
	1.4 TDCi	05/02-
	1.6i 16v.	01/05-
	1.6 TDCi	01/05-
2.0i ST	03/05-	

2256018 **Articulation AV**
 Part/oe 1146130 *Front bush*



1	Ø int. 12 Ø ext. 40.5 Coll. 50 Coll. 43.5 long. tube int. 55 ext. 28	
	1.2i	09/02-
	1.2i 16v.	05/02-
	1.3i	05/02-
	1.4i 16v.	05/02-
	1.4 TDCi	05/02-
	1.6i 16v.	05/02-
	1.6 TDCi	01/05-
	2.0i ST	03/05-

Bras & Triangle de suspension

Control arm
Brazo y triángulo
Wahacz
 Рычаг подвески

G/L D/R



9005812 **Triangle de susp. G**
 OE 1212808 *Left track control arm*



4	Avec rotule With ball joint	
	1.2i	05/02-
	1.3i 8v.	01/02-
	1.4i 16v. BVM /Pilotée	01/02-
	1.4 TDCi BVM /Pilotée	01/02-
	1.6i 16v.	01/02-
	1.6 TDCi	10/05-10/08
	2.0 ST	10/05-10/08

9005811 **Triangle de susp. D**
 OE 1212807 *Right track control arm*



3	Avec rotule With ball joint	
	1.2i	05/02-
	1.3i 8v.	01/02-
	1.4i 16v. BVM /Pilotée	01/02-
	1.4 TDCi BVM /Pilotée	01/02-
	1.6i 16v.	01/02-
	1.6 TDCi	10/05-10/08
	2.0 ST	10/05-10/08

... Fiesta VI 02-10/08

SASIC

FORD

Bras & Triangle de suspension

Control arm
Brazo y triángulo
Wahacz
Рычаг подвески

G/L  D/R

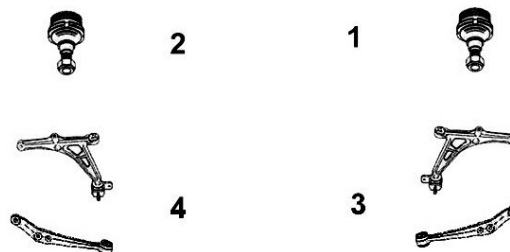

7576002

Rotule de susp. inf. G/D

OE 1679382

L/R lower suspension ball joint



1
2

Ø 16.5

1.2i
1.3i
1.4i 16v.
1.4 TDCi
1.6i 16v.
1.6 TDCi
2.0i ST

05/02-10/08

05/02-

05/02-

05/02-

05/02-

10/05-

10/05-

N4JB

BVM

BVM



Support d'amortisseur

Suspension mounting
Soporte amortiguador
Poduszka amortyzatora
Опора амортизатора

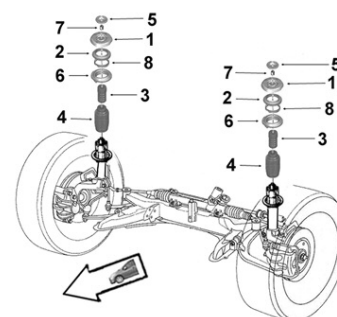

9005632

Support suspension G/D

OE 1469224

L/R suspension mounting



1

1.2i
1.3i 8v.
1.4i 16v.
1.4 TDCi
1.6i 16v.
1.6 TDCi
2.0i ST

05/02-

05/02-

05/02-

05/02-

05/02-

01/05-

01/05-10/05

HHJA/B

BVM

2656032

Butée à billes G/D

OE 1198235

L/R ball bearing



2

TT /all models

01/02-10/08

2656045

Butée de suspension

OE 1254220

Shock bush



3

H82

1.3i
1.4i 16v.
1.4 TDCi
1.6i 16v.

05/02-15/11/04

05/02-15/11/04

05/02-15/11/04

05/02-15/11/04

Fiesta VII 10/08- ...

Eléments DIRECTION

Steering parts

Elementos Direcciones

Elementy układ kierowniczy

Элементы рулевой системы

G/L  D/R

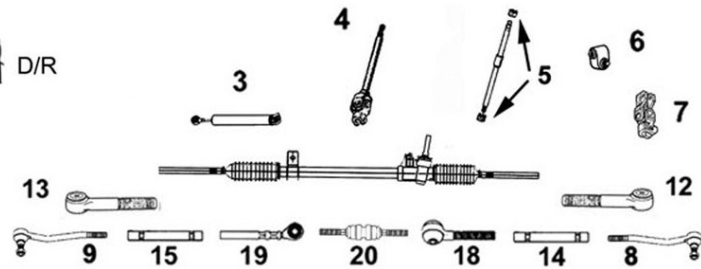

7776082

Axe de bielle G/D

OE 1545457

L/R axial joint

NEW



14 Côté dir. M14x1.5 Côté rot. M14x1.5 long 298 mm

15

1.2i
1.4i
1.4 TDCi
1.6i
1.6 TDCi

7676091

Rotule de direction G

OE 1545339

Left tie rod end

NEW



9 M14 x 1.5

1.2i
1.4i
1.4 TDCi
1.6i /16v.
1.6 TDCi /FAP

7676092

Rotule de direction D

OE 1545338

Right tie rod end

NEW



8 M14 x 1.5

1.2i
1.4i
1.4 TDCi
1.6i /16v.
1.6 TDCi /FAP

Bras & Triangle de suspension

Control arm

Brazo y triángulo

Wahacz

Рычаг подвески

G/L  D/R

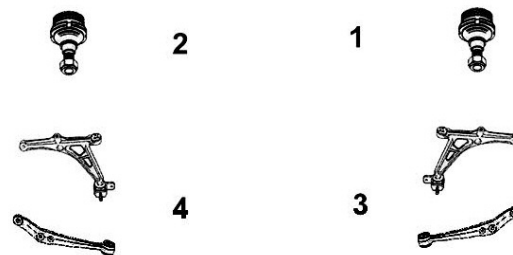

7476147

Triangle de susp. G

OE 1737305

Left track control arm

NEW



4 Avec rotule With ball joint Ø 17

1.2i	10/08-11/12
1.4i	11/08-11/12
1.4 TDCi	10/08-11/12
1.6i /16v.	10/08-11/12
1.6 TDCi	10/08-11/12

7476145

Triangle de susp. D

OE 1737309

Right track control arm

NEW



3 Avec rotule With ball joint Ø 17

1.2i	10/08-11/12
1.4i	11/08-11/12
1.4 TDCi	10/08-11/12
1.6i /16v.	10/08-11/12
1.6 TDCi	10/08-11/12

... Fiesta VII 10/08-



Support d'amortisseur
 Suspension mounting
 Soporte amortiguador
 Poduszka amortyzatora
 Опора амортизатора

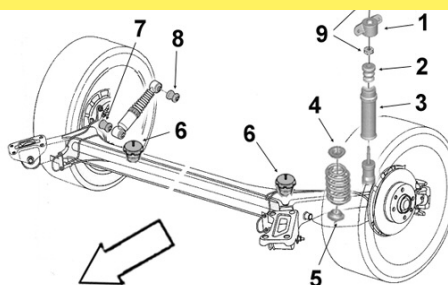

2656035

Support suspension G/D

OE 1535299

L/R suspension mounting



1

1.2i
 1.4i
 1.4 TDCi
 1.6i
 1.6 TDCi

Focus ...

Eléments DIRECTION

Steering parts

Elementos Direcciones

Elementy uklad kierowniczy

Элементы рулевой системы

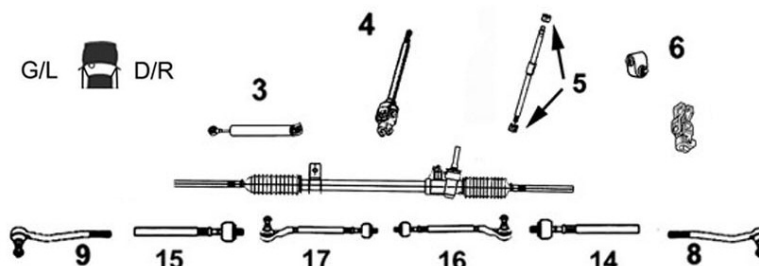

9006232

Axe de bielle G/D

Part/oe 1085520

L/R axial joint



14 Côté dir. M14x1.5 Côté rot. M14x2.0
15 long 340 mm

1.4i 16v. -08/04
 1.6i 16v. BVM BVA -08/04
 1.8i 16v. -08/04
 1.8 TDCi -08/04
 1.8 TDDi -08/04
 2.0i 16v. Sauf RS /ST -08/04

9006838

Axe de bielle G/D

Part/oe 1317453

L/R axial joint



14 Côté dir. M14x1.5 Côté rot. M16x1.5
15 long 288 mm

1.4i 16v. /Break 09/04-07/11
 1.6i 16v. /Break /Cab 09/04-07/11
 1.6 TDCi /Break 09/04-07/11
 1.8i 16v. /Break 01/05-07/11
 1.8 TDCi /Break 12/05-07/11
 2.0 /Break/Cab. Sauf RS/ST 09/04-07/11
 2.5 Turbo 12/05-07/11

9006464

Rotule de direction G

OE 1107015

Left tie rod end



9 M14 x 2

1.4i 16v. -08/04
 1.6i 16v BVM BVA -08/04
 1.8i 16v. -08/04
 1.8 TDCi -08/04
 1.8 TDDi -08/04
 2.0i 16v. Sauf RS /ST -08/04

9006463

Rotule de direction D

OE 1107013

Right tie rod end



8 M14 x 2.0

1.4i 16v. -08/04
 1.6i 16v BVM BVA -08/04
 1.8i 16v. -08/04
 1.8 TDCi -08/04
 1.8 TDDi -08/04
 2.0i 16v. Sauf RS /ST -08/04

9006690

Rotule de direction G

OE 1541811

Left tie rod end



9 M16 x 1.5

1.4i 16v. 09/04-07/11
 1.6i 16v. 09/04-07/11
 1.6 TDCi 09/04-07/11
 1.8i 16v. 01/05-07/11
 1.8 TDCi 01/05-07/11
 2.0i 16v. Sauf RS ST 09/04-07/11
 2.0 TDCi 09/04-07/11
 2.5 Turbo 12/05-07/11

9006689

Rotule de direction D

OE 1317446

Right tie rod end



8 M16 x 1.5

1.4i 16v. 09/04-07/11
 1.6i 16v. 09/04-07/11
 1.6 TDCi 09/04-07/11
 1.8i 16v. 01/05-07/11
 1.8 TDCi 01/05-07/11
 2.0i 16v. Sauf RS ST 09/04-07/11
 2.0 TDCi 09/04-07/11
 2.5 Turbo 12/05-07/11

... Focus ...

Eléments DIRECTION
Steering parts
Elementos Direcciones
Elementy układ kierowniczy
Элементы рулевой системы

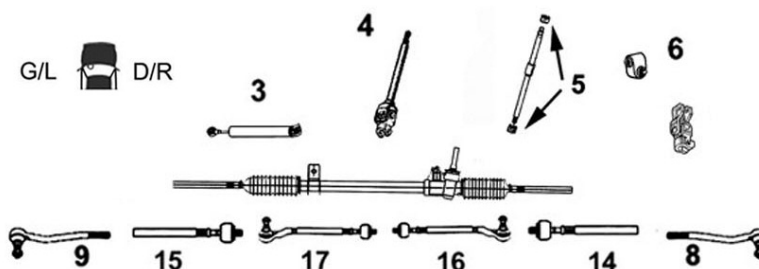

FORD



<p>7676067 OE 1714700</p> <p>Rotule de direction G <i>Left tie rod end</i></p>	<p>7676068 OE 1714576</p> <p>Rotule de direction D <i>Right tie rod end</i></p>	<p>NEW</p> <p>9 M16 x 1.5 L130</p> <p>1.0i Turbo /Break 02/12- 1.6i /Turbo /Break 04/11- 1.6 TDCi /Break 04/11- 2.0 TDCi /Break 04/11-</p>	<p>NEW</p> <p>8 M16 x 1.5 L130</p> <p>1.0i Turbo /Break 02/12- 1.6i /Turbo /Break 04/11- 1.6 TDCi /Break 04/11- 2.0 TDCi /Break 04/11-</p>
--	---	---	---

<p></p> <p>Barre stabilisatrice <i>Stabilizer bar</i> <i>Barra estabilizadora</i> <i>Drażek stabilizatora</i> <i>стабилизатор поперечной устойчивости</i></p>	
--	--

<p>9005004 OE 1209035</p> <p>Biellette barre stab. <i>Stabilizer bar stub axle</i></p>	<p>2 Alu alu</p> <p>1.4i 16v. 10/98-09/04</p>	<p>9005064 OE 1071336</p> <p>Biellette barre stab. <i>Stabilizer bar stub axle</i></p>	<p>2 Acier steel</p> <p>1.8i 16v. -04/00 1.8 TDDi -04/00</p>
<p>2306024 OE 1230909</p> <p>Biellette barre stab. <i>Stabilizer bar stub axle</i></p>	<p>2</p> <p>1.4i 16v. /Clipper BVM 09/04- 1.6i 16v. /Clipper 09/04- 1.6 TDCi/Clipper 01/05- 1.8i 16v./Clipper BVM 01/06- 1.8 TDCi/Clipper BVM 01/05- 2.0i 16v. /Clipper 11/04- 2.0 TDCi /Clipper 11/04- 2.5i Turbo ST /4WD BVM 12/05-</p>	<p>9005004 OE 1471446</p> <p>Biellette barre stab. <i>Stabilizer bar stub axle</i></p>	<p>2 Alu alu</p> <p>1.6i 16v. -08/04 1.8i 16v. 04/00-08/04 1.8 TDCi/Clipper/Coupé -12/04 1.8 TDDi 04/00-08/04 2.0i 16v. /Clipper /Coupé 04/00-08/04</p>
<p>9005064 OE 1071336</p> <p>Biellette barre stab. <i>Stabilizer bar stub axle</i></p>	<p>2 Acier steel</p> <p>2.0i 16v. -04/00</p>	<p>9001780 OE 1073217</p> <p>Palier de barre milieu <i>Middle bar main bearing</i></p>	<p>1</p> <p>1.4i 16v. -08/04 1.6i 16v. -08/04 1.8i 16v. -08/04 1.8 TDCi/Clipper/Coupé -12/04 1.8 TDDi -08/04 2.0i 16v./Clipper/Coupé -08/04</p>

... Focus ...



Barre stabilisatrice
 Stabilizer bar
 Barra estabilizadora
 Drażek stabilizatora
 стабилизатор поперечной устойчивости

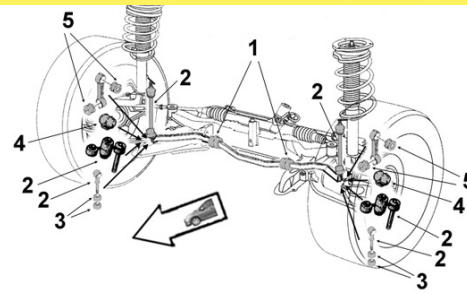

2306087 **Palier de barre milieu**
 OE 1348231 *Middle bar main bearing*



1 repère jaune <i>Yellow mark</i>	
1.4i 16v. Berline	09/04-12/10
1.6i 16v. Berline	09/04-12/10
1.6 TDCi Berline	09/04-12/10
1.8i 16v. ETH Berline	01/08-12/10
1.8 TDCi Berline	01/08-12/10
2.0i 16v. Berline	09/04-12/10
2.0 TDCi Berline	09/04-12/10
2.5i RS Berline	01/09-12/10
2.5i Turbo ST Berline	01/08-12/10

2306113 **Palier de barre milieu**
 OE 1305960 *Middle bar main bearing*



1 repère orange <i>orange mark</i>	
1.4i 16v. Break	01/05-12/10
1.6i 16v. Break/Cab.	01/05-12/10
1.6 TDCi Break	01/05-12/10
1.8i 16v. ETH Break	01/08-12/10
1.8 TDCi Break	01/08-12/10
2.0i 16v. Break /Cab.	01/05-12/10
2.0 TDCi Break /Cab.	01/05-12/10



Eléments SUSPENSION
 Suspension parts
 Elementos suspensión
 Elementy zawieszenia
 Элементы подвески

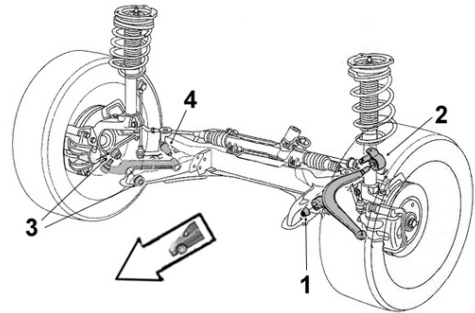

9001793 **Articulation AR**
 OE 1067918 *Rear bush*



2 Ø int.22	
1.4i 16v.	-08/04
1.6i 16v.	-08/04
1.8i 16v.	-08/04
1.8 TDdi	-08/04
2.0i 16v.	-08/04

2256021 **Articulation AR**
 Part/oe 1328380 *Rear bush*



2 Ø int.22	
1.4i 16v. /Clipper BVM	09/04-
1.6i 16v. /Clipper	09/04-
1.6 TDCi /Clipper	09/04-
1.8i 16v. /Clipper BVM	01/05-
1.8 TDCi/Clipper BVM	01/05-
2.0i 16v. /Clipper	09/04-
2.0 TDCi /Clipper	09/04-

9001586 **Articulation AV**
 OE 1061570 *Front bush*



1 Ø int.12 Ø ext.40 coll.50 long. tube int.65 ext.43 ep. coll.12	
1.4i 16v.	-08/04
1.6i 16v.	-08/04
1.8i 16v.	-08/04
1.8 TDCi/Clipper/Coupé	-12/04
1.8 TDdi	-08/04
2.0i 16v./Clipper/Coupé	-08/04

2256020 **Articulation AV**
 Part/oe 1328380 *Front bush*



1 Ø int. 14 Ø ext. 41 coll. 45.5 long. tube int. 65 ext 31.5	
1.4i 16v. /Clipper BVM	09/04-
1.6i 16v. /Clipper	09/04-
1.6 TDCi /Clipper	09/04-
1.8i 16v. /Clipper BVM	01/05-
1.8 TDCi/Clipper BVM	01/05-
2.0i 16v. /Clipper	09/04-
2.0 TDCi /Clipper	09/04-

... Focus ...

Bras & Triangle de suspension





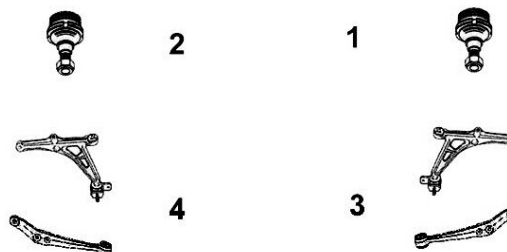



Control arm
Brazo y triángulo
Wahacz
Рычаг подвески

G/L  D/R



FORD

SASIC

<p>9005720 OE 1207974</p> 	<p>Triangle de susp. G <i>Left track control arm</i></p> <p>4 Avec rotule With ball joint Ø 16.5</p> <table border="0"> <tr><td>1.4i 16v.</td><td>-08/04</td></tr> <tr><td>1.6i 16v. BVM BVA</td><td>-08/04</td></tr> <tr><td>1.8i 16v.</td><td>-08/04</td></tr> <tr><td>1.8 TDCi</td><td>-08/04</td></tr> <tr><td>1.8 TDDi</td><td>-08/04</td></tr> <tr><td>2.0i 16v. Sauf RS /ST</td><td>-08/04</td></tr> </table>	1.4i 16v.	-08/04	1.6i 16v. BVM BVA	-08/04	1.8i 16v.	-08/04	1.8 TDCi	-08/04	1.8 TDDi	-08/04	2.0i 16v. Sauf RS /ST	-08/04	<p>9005721 OE 1207973</p> 	<p>Triangle de susp. D <i>Right track control arm</i></p> <p>3 Avec rotule With ball joint Ø 16.5</p> <table border="0"> <tr><td>1.4i 16v.</td><td>-08/04</td></tr> <tr><td>1.6i 16v. BVM BVA</td><td>-08/04</td></tr> <tr><td>1.8i 16v.</td><td>-08/04</td></tr> <tr><td>1.8 TDCi</td><td>-08/04</td></tr> <tr><td>1.8 TDDi</td><td>-08/04</td></tr> <tr><td>2.0i 16v. Sauf RS /ST</td><td>-08/04</td></tr> </table>	1.4i 16v.	-08/04	1.6i 16v. BVM BVA	-08/04	1.8i 16v.	-08/04	1.8 TDCi	-08/04	1.8 TDDi	-08/04	2.0i 16v. Sauf RS /ST	-08/04																
1.4i 16v.	-08/04																																										
1.6i 16v. BVM BVA	-08/04																																										
1.8i 16v.	-08/04																																										
1.8 TDCi	-08/04																																										
1.8 TDDi	-08/04																																										
2.0i 16v. Sauf RS /ST	-08/04																																										
1.4i 16v.	-08/04																																										
1.6i 16v. BVM BVA	-08/04																																										
1.8i 16v.	-08/04																																										
1.8 TDCi	-08/04																																										
1.8 TDDi	-08/04																																										
2.0i 16v. Sauf RS /ST	-08/04																																										
<p>9005814 OE 1570748</p> 	<p>Triangle de susp. G <i>Left track control arm</i></p> <p>4 Avec rotule With ball joint Cône Ø 15 - Ø 18</p> <table border="0"> <tr><td>1.4i 16v. /SW</td><td>09/04-12/10</td></tr> <tr><td>1.6i /SW</td><td>02/06-12/10</td></tr> <tr><td>1.6i 16v. /SW</td><td>09/04-12/10</td></tr> <tr><td>1.6 TDCi /FAP /SW</td><td>09/04-12/10</td></tr> <tr><td>1.8i 16v. /ETH /SW</td><td>01/05-12/10</td></tr> <tr><td>1.8 TD</td><td>02/09-12/10</td></tr> <tr><td>1.8 TDCi /SW KKDA</td><td>01/05-12/10</td></tr> <tr><td>2.0i 16v. /SW AODA/B</td><td>09/04-12/10</td></tr> <tr><td>2.0 TDCi /FAP /SW</td><td>09/04-12/10</td></tr> <tr><td>2.5i Turbo ST</td><td>08/06-12/10</td></tr> </table>	1.4i 16v. /SW	09/04-12/10	1.6i /SW	02/06-12/10	1.6i 16v. /SW	09/04-12/10	1.6 TDCi /FAP /SW	09/04-12/10	1.8i 16v. /ETH /SW	01/05-12/10	1.8 TD	02/09-12/10	1.8 TDCi /SW KKDA	01/05-12/10	2.0i 16v. /SW AODA/B	09/04-12/10	2.0 TDCi /FAP /SW	09/04-12/10	2.5i Turbo ST	08/06-12/10	<p>9005813 OE 1570750</p> 	<p>Triangle de susp. D <i>Right track control arm</i></p> <p>3 Avec rotule With ball joint Cône Ø 15 - Ø 18</p> <table border="0"> <tr><td>1.4i 16v. /SW</td><td>09/04-12/10</td></tr> <tr><td>1.6i /SW</td><td>02/06-12/10</td></tr> <tr><td>1.6i 16v. /SW</td><td>09/04-12/10</td></tr> <tr><td>1.6 TDCi /FAP /SW</td><td>09/04-12/10</td></tr> <tr><td>1.8i 16v. /ETH /SW</td><td>01/05-12/10</td></tr> <tr><td>1.8 TD</td><td>02/09-12/10</td></tr> <tr><td>1.8 TDCi /SW KKDA</td><td>01/05-12/10</td></tr> <tr><td>2.0i 16v. /SW AODA/B</td><td>09/04-12/10</td></tr> <tr><td>2.0 TDCi /FAP /SW</td><td>09/04-12/10</td></tr> <tr><td>2.5i Turbo ST</td><td>08/06-12/10</td></tr> </table>	1.4i 16v. /SW	09/04-12/10	1.6i /SW	02/06-12/10	1.6i 16v. /SW	09/04-12/10	1.6 TDCi /FAP /SW	09/04-12/10	1.8i 16v. /ETH /SW	01/05-12/10	1.8 TD	02/09-12/10	1.8 TDCi /SW KKDA	01/05-12/10	2.0i 16v. /SW AODA/B	09/04-12/10	2.0 TDCi /FAP /SW	09/04-12/10	2.5i Turbo ST	08/06-12/10
1.4i 16v. /SW	09/04-12/10																																										
1.6i /SW	02/06-12/10																																										
1.6i 16v. /SW	09/04-12/10																																										
1.6 TDCi /FAP /SW	09/04-12/10																																										
1.8i 16v. /ETH /SW	01/05-12/10																																										
1.8 TD	02/09-12/10																																										
1.8 TDCi /SW KKDA	01/05-12/10																																										
2.0i 16v. /SW AODA/B	09/04-12/10																																										
2.0 TDCi /FAP /SW	09/04-12/10																																										
2.5i Turbo ST	08/06-12/10																																										
1.4i 16v. /SW	09/04-12/10																																										
1.6i /SW	02/06-12/10																																										
1.6i 16v. /SW	09/04-12/10																																										
1.6 TDCi /FAP /SW	09/04-12/10																																										
1.8i 16v. /ETH /SW	01/05-12/10																																										
1.8 TD	02/09-12/10																																										
1.8 TDCi /SW KKDA	01/05-12/10																																										
2.0i 16v. /SW AODA/B	09/04-12/10																																										
2.0 TDCi /FAP /SW	09/04-12/10																																										
2.5i Turbo ST	08/06-12/10																																										
<p>7476192 OE 1570285</p> <p>NEW</p> 	<p>Triangle de susp. G <i>Left track control arm</i></p> <p>4 Avec rotule With ball joint Cône Ø 18- Ø 21</p> <table border="0"> <tr><td>1.4i 16v. /SW</td><td>09/04-12/10</td></tr> <tr><td>1.6i /SW</td><td>02/06-12/10</td></tr> <tr><td>1.6i 16v. /SW /Cab.</td><td>09/04-12/10</td></tr> <tr><td>1.6 TDCi /FAP /SW</td><td>09/04-12/10</td></tr> <tr><td>1.8i 16v. /ETH /SW</td><td>01/05-12/10</td></tr> <tr><td>1.8 TD</td><td>08/06-12/10</td></tr> <tr><td>1.8 TDCi /SW</td><td>01/05-12/10</td></tr> <tr><td>2.0i 16v. /SW /Cab.</td><td>09/04-12/10</td></tr> <tr><td>2.0 TDCi /FAP/SW /Cab</td><td>09/04-12/10</td></tr> <tr><td>2.5i Turbo ST</td><td>08/06-12/10</td></tr> </table>	1.4i 16v. /SW	09/04-12/10	1.6i /SW	02/06-12/10	1.6i 16v. /SW /Cab.	09/04-12/10	1.6 TDCi /FAP /SW	09/04-12/10	1.8i 16v. /ETH /SW	01/05-12/10	1.8 TD	08/06-12/10	1.8 TDCi /SW	01/05-12/10	2.0i 16v. /SW /Cab.	09/04-12/10	2.0 TDCi /FAP/SW /Cab	09/04-12/10	2.5i Turbo ST	08/06-12/10	<p>7476193 OE 1570284</p> <p>NEW</p> 	<p>Triangle de susp. D <i>Right track control arm</i></p> <p>3 Avec rotule With ball joint Cône Ø 18- Ø 21</p> <table border="0"> <tr><td>1.4i 16v. /SW</td><td>09/04-12/10</td></tr> <tr><td>1.6i /SW</td><td>02/06-12/10</td></tr> <tr><td>1.6i 16v. /SW /Cab.</td><td>09/04-12/10</td></tr> <tr><td>1.6 TDCi /FAP /SW</td><td>09/04-12/10</td></tr> <tr><td>1.8i 16v. /ETH /SW</td><td>01/05-12/10</td></tr> <tr><td>1.8 TD</td><td>08/06-12/10</td></tr> <tr><td>1.8 TDCi /SW</td><td>01/05-12/10</td></tr> <tr><td>2.0i 16v. /SW /Cab.</td><td>09/04-12/10</td></tr> <tr><td>2.0 TDCi /FAP/SW /Cab</td><td>09/04-12/10</td></tr> <tr><td>2.5i Turbo ST</td><td>08/06-12/10</td></tr> </table>	1.4i 16v. /SW	09/04-12/10	1.6i /SW	02/06-12/10	1.6i 16v. /SW /Cab.	09/04-12/10	1.6 TDCi /FAP /SW	09/04-12/10	1.8i 16v. /ETH /SW	01/05-12/10	1.8 TD	08/06-12/10	1.8 TDCi /SW	01/05-12/10	2.0i 16v. /SW /Cab.	09/04-12/10	2.0 TDCi /FAP/SW /Cab	09/04-12/10	2.5i Turbo ST	08/06-12/10
1.4i 16v. /SW	09/04-12/10																																										
1.6i /SW	02/06-12/10																																										
1.6i 16v. /SW /Cab.	09/04-12/10																																										
1.6 TDCi /FAP /SW	09/04-12/10																																										
1.8i 16v. /ETH /SW	01/05-12/10																																										
1.8 TD	08/06-12/10																																										
1.8 TDCi /SW	01/05-12/10																																										
2.0i 16v. /SW /Cab.	09/04-12/10																																										
2.0 TDCi /FAP/SW /Cab	09/04-12/10																																										
2.5i Turbo ST	08/06-12/10																																										
1.4i 16v. /SW	09/04-12/10																																										
1.6i /SW	02/06-12/10																																										
1.6i 16v. /SW /Cab.	09/04-12/10																																										
1.6 TDCi /FAP /SW	09/04-12/10																																										
1.8i 16v. /ETH /SW	01/05-12/10																																										
1.8 TD	08/06-12/10																																										
1.8 TDCi /SW	01/05-12/10																																										
2.0i 16v. /SW /Cab.	09/04-12/10																																										
2.0 TDCi /FAP/SW /Cab	09/04-12/10																																										
2.5i Turbo ST	08/06-12/10																																										
<p>7576004 OE 1679401</p> 	<p>Rotule de susp. inf. G/D <i>L/R lower suspension ball joint</i></p> <p>1/2 Ø 17.5</p> <table border="0"> <tr><td>1.4i 16v.</td><td>-08/04</td></tr> <tr><td>1.6i 16v.</td><td>-08/04</td></tr> <tr><td>1.8i 16v.</td><td>-08/04</td></tr> <tr><td>1.8 TDCi</td><td>-08/04</td></tr> <tr><td>1.8 TDDi</td><td>-08/04</td></tr> <tr><td>2.0i 16v. Sauf RS /ST</td><td>-08/04</td></tr> </table>	1.4i 16v.	-08/04	1.6i 16v.	-08/04	1.8i 16v.	-08/04	1.8 TDCi	-08/04	1.8 TDDi	-08/04	2.0i 16v. Sauf RS /ST	-08/04	<p>9005527 OE 1679384</p> 	<p>Rotule de susp. G/D <i>L/R suspension ball joint</i></p> <p>1/2 Cône Ø 15 - Ø 18</p> <table border="0"> <tr><td>1.4i 16v. /SW</td><td>09/04-12/10</td></tr> <tr><td>1.6i /SW</td><td>02/06-12/10</td></tr> <tr><td>1.6i 16v. /SW</td><td>09/04-12/10</td></tr> <tr><td>1.6 TDCi /FAP /SW</td><td>09/04-12/10</td></tr> <tr><td>1.8i 16v. /ETH /SW</td><td>01/05-12/10</td></tr> <tr><td>1.8 TD</td><td>02/09-12/10</td></tr> <tr><td>1.8 TDCi /SW KKDA</td><td>01/05-12/10</td></tr> <tr><td>2.0i 16v. /SW AODA/B</td><td>09/04-12/10</td></tr> <tr><td>2.0 TDCi /FAP /SW</td><td>09/04-12/10</td></tr> <tr><td>2.5i Turbo ST</td><td>08/06-12/10</td></tr> </table>	1.4i 16v. /SW	09/04-12/10	1.6i /SW	02/06-12/10	1.6i 16v. /SW	09/04-12/10	1.6 TDCi /FAP /SW	09/04-12/10	1.8i 16v. /ETH /SW	01/05-12/10	1.8 TD	02/09-12/10	1.8 TDCi /SW KKDA	01/05-12/10	2.0i 16v. /SW AODA/B	09/04-12/10	2.0 TDCi /FAP /SW	09/04-12/10	2.5i Turbo ST	08/06-12/10								
1.4i 16v.	-08/04																																										
1.6i 16v.	-08/04																																										
1.8i 16v.	-08/04																																										
1.8 TDCi	-08/04																																										
1.8 TDDi	-08/04																																										
2.0i 16v. Sauf RS /ST	-08/04																																										
1.4i 16v. /SW	09/04-12/10																																										
1.6i /SW	02/06-12/10																																										
1.6i 16v. /SW	09/04-12/10																																										
1.6 TDCi /FAP /SW	09/04-12/10																																										
1.8i 16v. /ETH /SW	01/05-12/10																																										
1.8 TD	02/09-12/10																																										
1.8 TDCi /SW KKDA	01/05-12/10																																										
2.0i 16v. /SW AODA/B	09/04-12/10																																										
2.0 TDCi /FAP /SW	09/04-12/10																																										
2.5i Turbo ST	08/06-12/10																																										
<p>7576041 OE 1679388</p> <p>NEW</p> 	<p>Rotule de susp. G/D <i>L/R suspension ball joint</i></p> <p>1/2 Cône Ø 18- Ø 21</p> <table border="0"> <tr><td>1.4i 16v. /SW</td><td>09/04-12/10</td></tr> <tr><td>1.6i /SW</td><td>02/06-12/10</td></tr> <tr><td>1.6i 16v. /SW /Cab.</td><td>09/04-12/10</td></tr> <tr><td>1.6 TDCi /FAP /SW</td><td>09/04-12/10</td></tr> <tr><td>1.8i 16v. /ETH /SW</td><td>01/05-12/10</td></tr> <tr><td>1.8 TD</td><td>08/06-12/10</td></tr> <tr><td>1.8 TDCi /SW</td><td>01/05-12/10</td></tr> <tr><td>2.0i 16v. /SW /Cab.</td><td>09/04-12/10</td></tr> <tr><td>2.0 TDCi /FAP/SW /Cab.</td><td>09/04-12/10</td></tr> <tr><td>2.5i Turbo ST</td><td>08/06-12/10</td></tr> </table>			1.4i 16v. /SW	09/04-12/10	1.6i /SW	02/06-12/10	1.6i 16v. /SW /Cab.	09/04-12/10	1.6 TDCi /FAP /SW	09/04-12/10	1.8i 16v. /ETH /SW	01/05-12/10	1.8 TD	08/06-12/10	1.8 TDCi /SW	01/05-12/10	2.0i 16v. /SW /Cab.	09/04-12/10	2.0 TDCi /FAP/SW /Cab.	09/04-12/10	2.5i Turbo ST	08/06-12/10																				
1.4i 16v. /SW	09/04-12/10																																										
1.6i /SW	02/06-12/10																																										
1.6i 16v. /SW /Cab.	09/04-12/10																																										
1.6 TDCi /FAP /SW	09/04-12/10																																										
1.8i 16v. /ETH /SW	01/05-12/10																																										
1.8 TD	08/06-12/10																																										
1.8 TDCi /SW	01/05-12/10																																										
2.0i 16v. /SW /Cab.	09/04-12/10																																										
2.0 TDCi /FAP/SW /Cab.	09/04-12/10																																										
2.5i Turbo ST	08/06-12/10																																										

... Focus ...

SASIC

FORD



Support d'amortisseur
 Suspension mounting
 Soporte amortiguador
 Poduszka amortyzatora
 Опора амортизатора

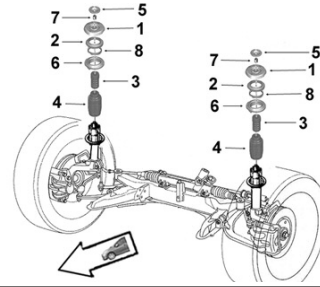

9005633

Support suspension G/D
L/R suspension mounting

OE 1087177



1
 1.4i 16v. /Clipper /Coupé BVM -08/04
 1.6i 16v. /Clipper /Coupé BVM -08/04
 1.8i 16v. /Clipper /Coupé BVM -08/04
 1.8 TDCi/Clipper/Coupé BVM
 01/03-08/04
 1.8 TDDi /Clipper /Coupé BVM -08/04
 2.0i 16v. /Clipper /Coupé BVM -08/04

2656011

Support suspension
Suspension mounting

OE 1377471



1
 1.4i 16v. Berline BVM5 09/04-08/02/05
 1.4i 16v. SW BVM5 01/05-12/07
 1.6i 16v. Berline BVM5 09/04-08/02/05
 1.6i 16v. SW BVM5 01/05-12/07
 1.6 TDCi Berline BVM5 /Ség.
 09/04-08/02/05
 1.6 TDCi SW BVM5 /Ség. 01/05-12/07
 2.0i 16v. Berline BVM5 09/04-08/02/05
 2.0i 16v. SW BVM5 01/05-12/07
 2.0 TDCi Berline BVM6 09/04-08/02/05
 2.0 TDCi SW BVM6 01/05-12/07

2656023

Support suspension
Suspension mounting

OE 1377612



1
 1.4i 16v. Berline /SW 08/02/05-12/10
 1.6i 16v. Berline /SW 08/02/05-12/10
 1.6 TDCi Berline /SW 08/02/05-12/10
 1.8i 16v. ETH Berline /SW
 01/08-12/10
 1.8 TDCi Berline /SW 01/08-12/10
 2.0i 16v. Berline /SW 08/02/05-12/10
 2.0 TDCi Berline /SW 08/02/05-12/10

2656010

Support suspension
Suspension mounting

OE 1106874



1
 1.6i 16v. /Clipper /Coupé FYDA/B/C
 HWDA BVA4 07/99-09/04
 2.0i 16v. /Clipper /Coupé EDDF
 BVA4 12/01-07/03



Barre stabilisatrice
 Stabilizer bar
 Barra estabilizadora
 Drążek stabilizatora
 стабилизатор поперечной устойчивости

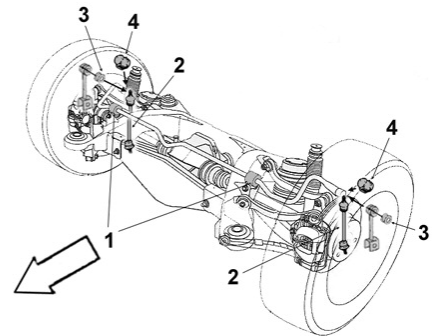

2306029

Biellette barre stab.
Stabilizer bar stub axle

OE 1487402



2	1.4i /Clipper/Coupé	BVM	10/98-09/04
	1.4i 16v. /Clipper/Coupé	BVM	10/98-09/04
	1.6i 16v. /Clipper/Coupé		10/98-12/07
	1.6 TDCi /DPF	BVM	09/04-12/07
	1.8i 16v. /Clipper/Coupé	BVM	10/98-12/04
	1.8 TDCi /Clipper/Coupé	BVM	03/01-09/04
	1.8 TDDi /Clipper/Coupé	BVM	01/01-12/04
	2.0i 16v. /Clipper/Coupé		10/98-12/07
	2.0 TDCi /DPF		09/04-12/07

2306030

Biellette barre stab.
Stabilizer bar stub axle

OE 1469208



2	1.4i 16v.	BVM 09/04-
	1.6i 16v.	09/04-
	1.6 TDCi	09/04-
	1.8i 16v. ETH /Clipper	01/05-
	1.8 TDCi/Clipper	BVM 01/05-
	2.0i 16v. /Cab.	09/04-
	2.0 TDCi Cab.	09/04-
	2.5i Turbo ST	BVM 12/05-

2306031

Biellette barre stab.
Stabilizer bar stub axle













OE 1719542

NEW



2	1.4i 16v. Clipper	BVM 01/08-
	1.6i 16v. Clipper	01/08-
	1.6 TDCi/Clipper	BVM 01/08-
	1.8i 16v. ETH /Clipper	BVM 01/08-
	1.8 TDCi /Clipper	BVM 01/08-
	2.0i 16v. Clipper	01/08-
	2.0 TDCi Clipper	01/08-

... Focus ...

9001782 OE 1073249	Palier de barre milieu <i>Middle bar main bearing</i>	2306085 OE 1345913	Palier de barre milieu <i>Middle bar main bearing</i>
	1 Ø 20 1.4i 16v. -08/04 1.6i 16v. -08/04 1.8i 16v. -08/04 1.8 TDCi/Clipper /Coupé -12/04 1.8 TDdi -08/04 2.0i 16v. -08/04		1 repère orange orange mark 1.4i 16v. 09/04-12/10 1.6i 16v. Berline Break 09/04-12/10 1.6i Turbo Break 04/11- 1.6 TDCi Berline Break 09/04-12/10 1.8i 16v. ETH /TDCi 01/08-12/10 2.0i 16v. Berline Break 09/04-12/10 2.0 TDCi Berline Break 09/04-12/10
2306097 OE 1337965	Palier de barre milieu <i>Middle bar main bearing</i>	2306112 OE 1416474	Palier de barre milieu <i>Middle bar main bearing</i>
	1 Repère vert green mark 1.6i Berline Break 04/11- 1.6i Turbo Berline Break 04/11- 1.6 TDCi Break 01/05-12/07 1.6 TDCi Berline Break 04/11- 2.0i 16v. Break 01/05-12/07 2.0 TDCi Break 01/05-12/07 2.0 TDCi FAP Berline Break 04/11-		1 repère bleu blue mark 1.6i 16v. Cab. 10/06-07/10 2.0i 16v. Cab. 10/06-12/10 2.0 TDCi FAP Cab. 10/06-12/10
2306111 OE 1371748	Palier de barre milieu <i>Middle bar main bearing</i>		
	1 Repère jaune Yellow mark 1.6 TDCi FAP Break 04/11- 2.0 TDCi FAP Break 04/11- 2.5i Turbo ST Berline 01/08-12/10 HYDA BVM6		
2306110 OE 1337964	Palier de barre milieu <i>Middle bar main bearing</i>		
	1 Repère mauve mauve mark 2.0 TDCi FAP Berline TXDB UFDB BVM6/ rob.6 04/11-		
Bras & Triangle de suspension <i>Control arm</i> <i>Brazo y triángulo</i> <i>Wahacz</i> <i>Рычаг подвески</i>			
G/L  D/R		 2	 1
		 4	 3
7476152 OE 1064128 NEW	Bras de susp. AR inf. <i>Rear lower track control arm</i>		
	3 4 1.4i /16v. 75hp 55kw /Coupé 10/98-09/04 1.6i 16v. 100hp 74kw /Coupé 10/98-09/04 1.8i 16v. 115hp 85kw /Coupé 10/98-09/04 1.8 TDCi 100hp 74kw 115hp 85kw /4ptes /Coupé 03/01-09/04 1.8 TDdi 75hp 55kw 90hp 66kw /Coupé 02/99-09/04 2.0i 16v. 130hp 96kw/Coupé 10/98-07/03		

FORD



... Focus



Support d'amortisseur
 Suspension mounting
 Soporte amortiguador
 Poduszka amortyzatora
 Опора амортизатора

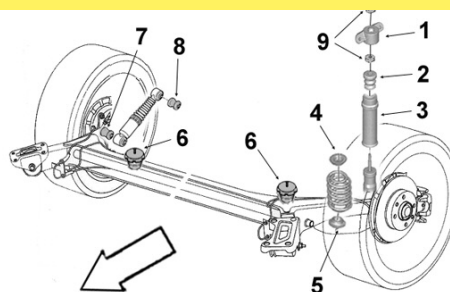

2656037 **Support suspension G/D**
 OE 1300459 *L/R suspension mounting*



1	1.4i 16v. Berline	09/04-12/07
	1.6i 16v. Berline	09/04-12/07
	1.6 TDCi Berline	09/04-12/07
	2.0i 16v. Berline	09/04-12/07
	2.0 TDCi Berline	09/04-12/07

Fusion ...

Eléments DIRECTION
 Steering parts
 Elementos Direcciones
 Elementy uklad kierowniczy
 Элементы рулевой системы

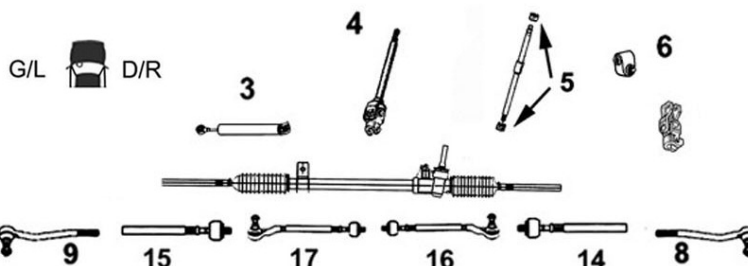

9006837 **Axe de bielle G/D**
 OE 4472940 *L/R axial joint*



14 15	Côté dir. M14x1.5 Côté rot. M14x1.5 long 276 mm	
	1.4i 16v. BVM /Pilotée	
	1.4 TDCi BVM /Pilotée	
	1.6i 16v. BVM /Pilotée	
	1.6 TDCi BVM /Pilotée	

9006663 **Rotule de direction G**
 OE 1202549 *Left tie rod end*



9	M14 x 1.5	
	1.4i 16v. BVM /Pilotée	
	1.4 TDCi BVM /Pilotée	
	1.6i 16v. BVM /Pilotée	
	1.6 TDCi BVM /Pilotée	10/05-

9006662 **Rotule de direction D**
 OE 1202548 *Right tie rod end*



8	M14 x 1.5	
	1.4i 16v. BVM /Pilotée	
	1.4 TDCi BVM /Pilotée	
	1.6i 16v. BVM /Pilotée	
	1.6 TDCi BVM /Pilotée	10/05-

... Fusion ...



Barre stabilisatrice
Stabilizer bar
Barra estabilizadora
Drażek stabilizatora
 стабилизатор поперечной устойчивости

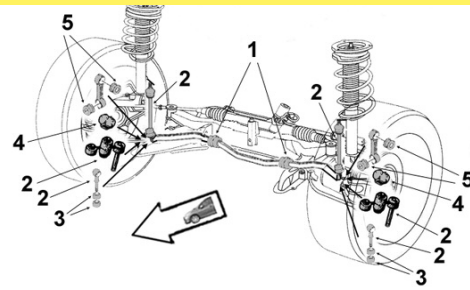

9005003 **Biellette barre stab.**
 OE 1146150 *Stabilizer bar stub axle*



2

1.4i 16v.
 1.4 TDCi
 1.6i 16v.
 1.6 TDCi

BVM

09/02-
 09/02-
 09/02-
 11/04-



Eléments SUSPENSION
Suspension parts
Elementos suspensión
Elementy zawieszenie
 Элементы подвески

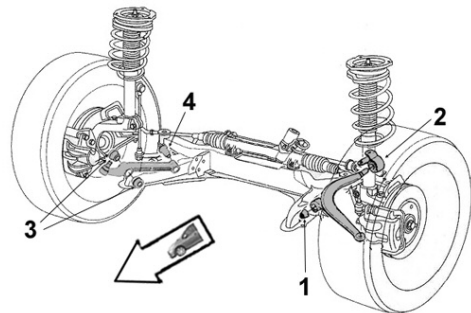

2256019 **Articulation AR**
 Part/oe 1146131 *Rear bush*



2

Ø int.22

1.2i	FUJA/B BVM	11/03-
1.4i GPL	FXJA /Duratec BVM	10/09-
1.4i 16v.	FXJA /B/Duratec	09/02-
1.4 TDCi	F6JA /B/Duratorq	09/02-
1.6i 16v.	FYJA/B /Duratec	09/02-
1.6 TDCi	HHJA/B BVM	12/04-

2256018 **Articulation AV**
 Part/oe 1146130 *Front bush*



1

Ø int. 12 Ø ext. 40.5 Coll. 50 Coll. 43.5
 long. tube int. 55 ext. 28

1.2i	FUJA/B BVM	11/03-
1.4i GPL	FXJA /Duratec BVM	10/09-
1.4i 16v.	FXJA /B/Duratec	09/02-
1.4 TDCi	F6JA /B/Duratorq	09/02-
1.6i 16v.	FYJA/B /Duratec	09/02-
1.6 TDCi	HHJA/B BVM	12/04-

Bras & Triangle de suspension

Control arm
Brazo y triángulo
Wahacz
 Рычаг подвески

G/L D/R



2



1



4



3

9005812 **Triangle de susp. G**
 OE 1212808 *Left track control arm*



4

Avec rotule With ball joint

1.4i 16v.	10/05-
1.4 TDCi	10/05-
1.6i 16v.	10/05-
1.6 TDCi	10/05-

9005811 **Triangle de susp. D**
 OE 1212807 *Right track control arm*



3

Avec rotule With ball joint

1.4i 16v.	10/05-
1.4 TDCi	10/05-
1.6i 16v.	10/05-
1.6 TDCi	10/05-

... Fusion

Bras & Triangle de suspension

Control arm
Brazo y triángulo
Wahacz
Рычаг подвески

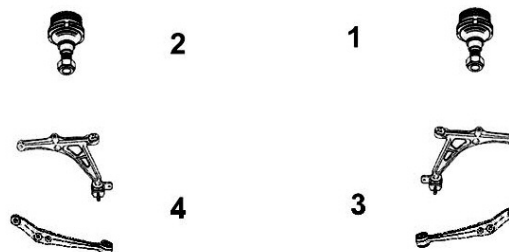
G/L  D/R**7576002****Rotule de susp. inf. G/D**

OE 1679382

L/R lower suspension ball joint**1**
2 Ø 16.5

1.4i 16v.
1.4 TDCi
1.6i 16v.
1.6 TDCi

09/02-
09/02-
09/02-
12/04-

**Support d'amortisseur**

Suspension mounting
Soporte amortiguador
Poduszka amortyzatora
Опора амортизатора

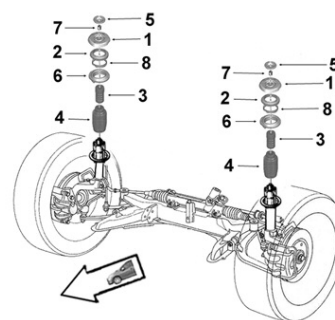
**9005632****Support suspension G/D**

OE 1469224

L/R suspension mounting**1**

1.4i 16v. 09/02-
1.4 TDCi 09/02-
1.6i 16v. 09/02-
1.6 TDCi 10/05-

2656032**Butée à billes G/D**

OE 1198235

L/R ball bearing**2**

TT /all models 09/02-10/08

Galaxy ...

Eléments DIRECTION

Steering parts
Elementos Direcciones
Elementy układ kierowniczy
Элементы рулевой системы

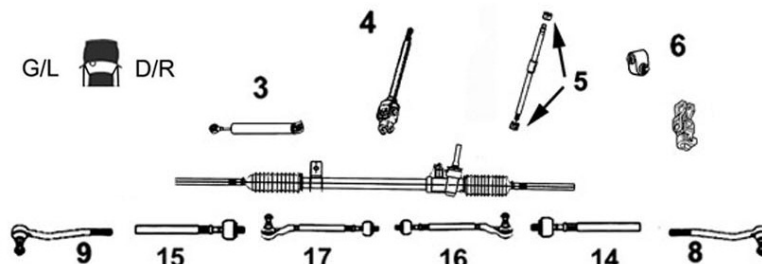
G/L  D/R**7776025****Axe de bielle G/D**

OE 1596574

L/R axial joint

14 Côté dir. M16x1.5 Côté rot. M18x1.5
15 long 315 mm

1.6i Turbo 03/10-
1.6 TDCi FAP 03/11-
1.8 TDCi 03/10-
2.0i 16v. 06/06-
2.0i Turbo 03/10-
2.0 TDCi 03/10-
2.2 TDCi FAP 01/08-
2.3i 16v. 03/10-

9006229**Axe de bielle G/D**

Part/oe 1020497

L/R axial joint



14 Côté dir. M14x1.5 Côté rot. M14x1.5
long 184 mm

1.9 TDi -06/06
2.0 -03/00
2.0i 16v. 04/00-06/06
2.3i 16v. -06/06
2.8 VR6 -06/06

... Galaxy ...

FORD



SASIC

9006460 OE 1234259	Rotule de direction G <i>Left tie rod end</i>	9006459 OE 1234258	Rotule de direction D <i>Right tie rod end</i>
	9 M14 x 1.5 1.9 TDi 2.0 2.0i 16v. -03/00 2.3i 16v. 04/00- 2.8 VR6		8 M14 x 1.5 1.9 TDi 2.0 2.0i 16v. -03/00 2.3i 16v. 04/00- 2.8 VR6
7676025 OE 1433274	Rotule de direction G <i>Left tie rod end</i>	7676024 OE 1433273	Rotule de direction D <i>Right tie rod end</i>
	9 M18 x 1.5 1.6i Turbo 03/11- 1.6 TDCi 03/11- 1.8 TDCi 06/06- 2.0i Turbo 03/10- 2.0i 16v. 06/06- 2.0 TDCi 06/06- 2.2 TDCi 03/08- 2.3i 16v. 07/07-		8 M18 x 1.5 1.6i Turbo 03/11- 1.6 TDCi 03/11- 1.8 TDCi 06/06- 2.0i Turbo 03/10- 2.0i 16v. 06/06- 2.0 TDCi 06/06- 2.2 TDCi 03/08- 2.3i 16v. 07/07-

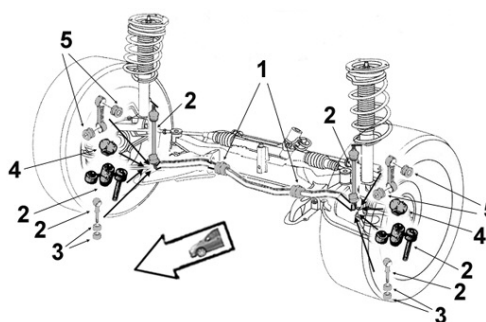

Barre stabilisatrice
Stabilizer bar
Barra estabilizadora
Drażek stabilizatora
 стабилизатор поперечной устойчивости



2306025 OE 1377849	Biellette barre stab. <i>Stabilizer bar stub axle</i>	9005062 OE 1141774	Biellette barre stab. <i>Stabilizer bar stub axle</i>
	2 1.6i Turbo 03/10- 1.6 TDCi 02/11- 1.8 TDCi BVM 06/06- 2.0i 16v. BVM 06/06- 2.0 TDCi 06/06- 2.2 TDCi 03/08- 2.3i 16v. BVA 07/07-		2 1.9 TDi 2.0i 16v. 2.3i 16v. 2.8 VR6 /4WD



Eléments SUSPENSION
Suspension parts
Elementos suspensión
Elementy zawieszenie
 Элементы подвески

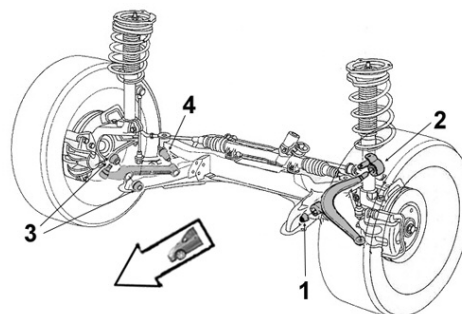

9001436 OE 7201717	Articulation AV <i>Front bush</i>
	1 Ø int.14 Ø ext.35 coll.38 x2 long. tube int.60 ext.33 ep. coll.5x2 1.9 TDi 2.0 2.0i 16v. -03/00 2.3i 16v. 04/00- 2.8 VR6

... Galaxy ...

SASIC

FORD

Bras & Triangle de suspension

Control arm
Brazo y triángulo
Wahacz
Рычаг подвески

G/L D/R

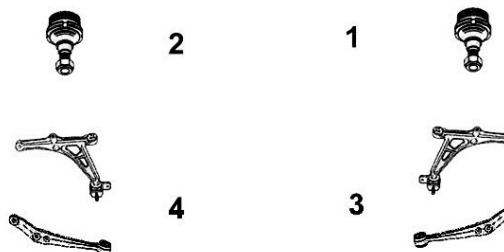

9005751

OE 1007602

Triangle de susp. G

Left track control arm

4 Sans rotule Without tie rod end



1.9 TDi
2.0 -03/00
2.0i 16v. 04/00-
2.3i 16v.
2.8 VR6

9005752

OE 1012632

Triangle de susp. D

Right track control arm

3 Sans rotule Without tie rod end



1.9 TDi
2.0 -03/00
2.0i 16v. 04/00-
2.3i 16v.
2.8 VR6

7476043

OE 1507182

Triangle de susp. G

Left track control arm

4 Avec rotule With ball joint



1.6i Turbo 03/10-
1.6 TDCi 03/11-
1.8 TDCi 06/06-
2.0i Turbo 03/10-
2.0i 16v. 06/06-
2.0 TDCi 06/06-
2.2 TDCi 03/08-
2.3i 16v. 07/07-

7476042

OE 1507181

Triangle de susp. D

Right track control arm

3 Avec rotule With ball joint



1.6i Turbo 03/10-
1.6 TDCi 03/11-
1.8 TDCi 06/06-
2.0i Turbo 03/10-
2.0i 16v. 06/06-
2.0 TDCi 06/06-
2.2 TDCi 03/08-
2.3i 16v. 07/07-

9005247

OE 1111156

Rotule de susp. inf. G/D

L/R lower suspension ball joint

1
2



1.9 TDi
2.0 -03/00
2.0i 16v. 04/00-
2.3i 16v.
2.8 VR6



Support d'amortisseur

Suspension mounting
Soporte amortiguador
Poduszka amortyzatora
Опора амортизатора

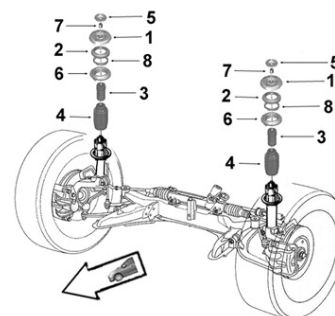

9001709

OE 7201848

Support suspension G/D

L/R suspension mounting

1



1.9 TDi
2.0 -03/00
2.0i 16v. 04/00-
2.3i 16v.
2.8 VR6

9005352

OE 1102592

Butée à billes G/D

L/R ball bearing

2



1.9 TDi
2.0 -03/00
2.0i 16v. 04/00-
2.3i 16v.
2.8 VR6

... Galaxy



Eléments SUSPENSION

Suspension parts
Elementos suspensión
Elementy zawieszenie
Элементы подвески

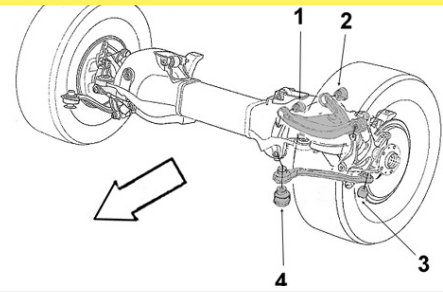

FORD

SASIC

9001436

Articulation AV

OE 7201717

Front bush



1 Ø int.14 Ø ext.35 coll.38 x2 long. tube int.60 ext.33 ep. coll.5x2

1.9 TDi
2.0
2.0i 16v.
2.3i 16v.

BVM BVA
BVM

-03/00
04/00-

2.8 VR6

BVM BVA

-03/00

Eléments TRAIN ARRIERE

Rear axle parts
Tren TRAS
Elementy zawieszenia tylnego
элементы задней оси.



9001448

Support train AR

OE 7403748

Rear axle mounting



1.9 TDi

2.0 BVM BVA -03/00
2.0i 16v. BVM 04/00-

2.3i 16v. BVM BVA
2.8 VR6 BVM BVA

Ka ...

Eléments DIRECTION

Steering parts
Elementos Direcciones
Elementy uklad kierowniczy
Элементы рулевой системы

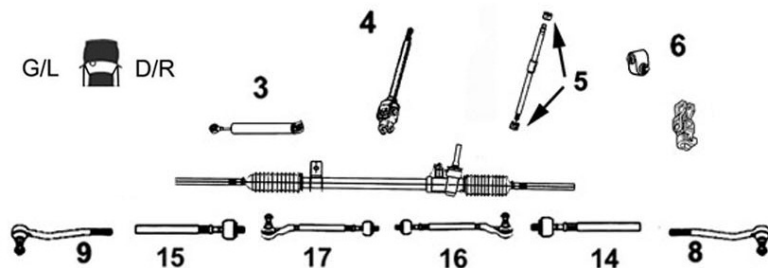

9006220

Axe de bielle G/D

OE 1659374

L/R axial joint



14
15 M14 x 1.5 1/2x20pouces 300 mm

TT /all models

01/96-

9006357

Rotule de direction G/D

OE 6969518

L/R tie rod end



8
9 M1/2 x 20 pouces

TT /all models DNA DA

01/96-

... Ka ...



SASIC

FORD

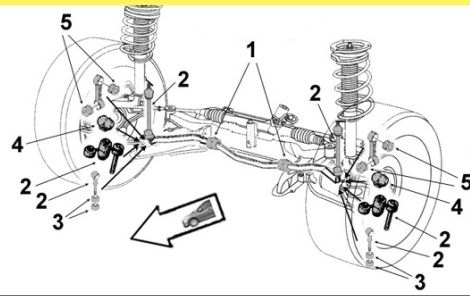

Barre stabilisatrice
Stabilizer bar
Barra estabilizadora
Drażek stabilizatora
 стабилизатор поперечной устойчивости





9005064 OE 1067818	Biellette barre stab. <i>Stabilizer bar stub axle</i>	9005004 OE 1471446	Biellette barre stab. <i>Stabilizer bar stub axle</i>
	2 Acier steel 1.3i 10/96-10/08		2 Alu alu 1.6i 03/03-10/08
9005099 OE 1580517	Biellette barre stab. <i>Stabilizer bar stub axle</i>	9001599 OE 1003609	Palier de barre milieu <i>Middle bar main bearing</i>
	2 1.2i 10/08- 1.3 TDCi 10/08-		1 Barre Ø 17 1.3i 10/96- 1.6i 03/03-

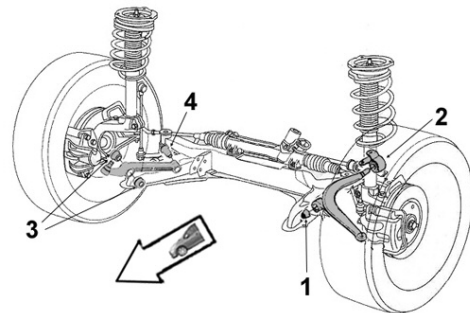

Eléments SUSPENSION
Suspension parts
Elementos suspensión
Elementy zawieszenia
 Элементы подвески



9001595 OE 1035929	Articulation AR <i>Rear bush</i>
	2 Ø int.12 Ø ext.54 coll.62 long. tube int.45.5 ext.24.5 coll.3 1.3i 10/96- 1.6i 03/03-10/08
9001689 OE 1000445	Articulation AV <i>Front bush</i>
	1 Ø int.12 Ø ext.46 long. tube int.45 ext.25 1.3i 10/96-

... Ka ...

Bras & Triangle de suspension

Control arm
Brazo y triángulo
Wahacz
Рычаг подвески

G/L  D/R

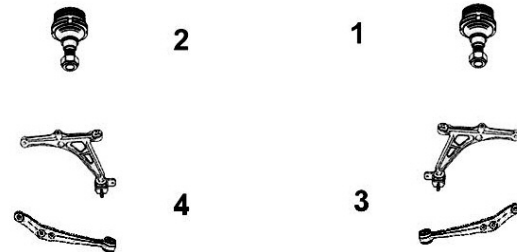

FORD

SASIC

9005718
OE 1032102

Triangle de susp. G
Left track control arm



4 Avec rotule *With ball joint*

TT /all models DNA 01/97-

9005719
OE 1032100

Triangle de susp. D
Right track control arm



3 Avec rotule *With ball joint*

TT /all models DNA 01/97-

9005810
OE 1448622

Triangle de susp. G
Left track control arm



4 Avec rotule *With ball joint*

TT /all models DA 01/97-

9005809
OE 1448621

Triangle de susp. D
Right track control arm



3 Avec rotule *With ball joint*

TT /all models DA 01/97-

9005249
OE 1030025

Rotule de susp. inf. G/D
L/R lower suspension ball joint



1 3 points d'ancrage *3 Cramping points*
2

TT /all models

01/96-



Support d'amortisseur
Suspension mounting
Soporte amortiguador
Poduszka amortyzatora
Опора амортизатора

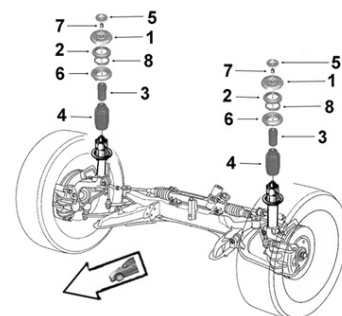

9001454
OE 1013794

Support suspension G/D
L/R suspension mounting



1

1.3i 10/96-

8005209
OE 1002513

Butée à billes
Ball bearing



2

1.3i 10/96-

... Ka



Support d'amortisseur
 Suspension mounting
 Soporte amortiguador
 Poduszka amortyzatora
 Опора амортизатора

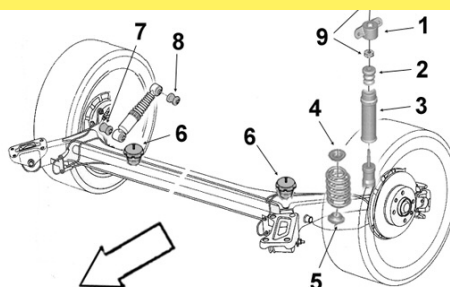

9005624 **Support suspension G/D**
 OE 1023587 L/R suspension mounting



1

1.3i
1.6i

10/96-
03/03-

Eléments TRAIN ARRIERE
 Rear axle parts
 Tren TRAS
 Elementy zawieszenia tylnego
 элементы задней оси.



9001747 **Articulation essieu AR**
 OE 1016439 Rear axle bush



Ø int.12 Ø ext.63 long. tube int.70 ext.55

1.3i 10/96-
1.6i 03/03-

Kuga ...

Eléments DIRECTION
 Steering parts
 Elementos Direcciones
 Elementy uklad kierowniczy
 Элементы рулевой системы

G/L D/R

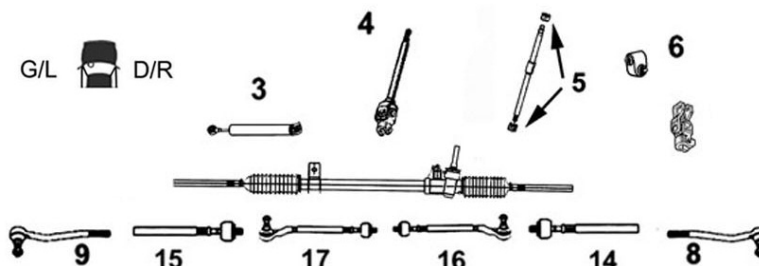

9006839 **Axe de bielle G/D**
 OE 1510270 L/R axial joint



14
15

Côté dir. M14x1.5 Côté rot. M16x1.5 long 288 mm

2.0 TDCi DPF /4WD
2.5i Turbo /4WD
2.5 TDCi 4WD

03/08-11/12
10/08-11/12
07/10-11/12

7676028 **Rotule de direction G**
 OE 1541488 Left tie rod end



9

M16 x 1.5

2.0 TDCi /4WD 03/08-10/11/12
2.5i Turbo /4WD 10/08-10/11/12

7676027 **Rotule de direction D**
 OE 1541485 Right tie rod end



8

M16 x 1.5

2.0 TDCi /4WD 03/08-10/11/12
2.5i Turbo /4WD 10/08-10/11/12

... Kuga



Barre stabilisatrice
 Stabilizer bar
 Barra estabilizadora
 Drażek stabilizatora
 стабилизатор поперечной устойчивости

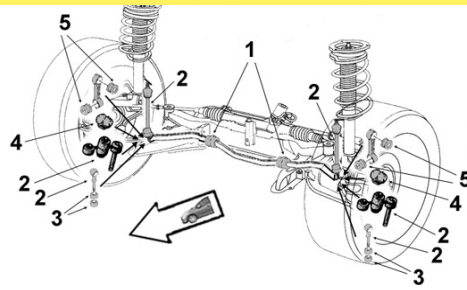

2306024
 OE 1230909

Biellette barre stab.
Stabilizer bar stub axle



2
 2.0 TDCi DPF /4WD BVM 03/08-
 2.5i Turbo 4WD 03/09-

2306113
 OE 1305960

Palier de barre milieu
Middle bar main bearing



1 repère orange *orange mark*
 2.0 TDCi FAP /4WD 02/08-11/12
 2.5i Turbo 4WD 02/08-11/12
 2.5 TDCi 4WD 02/08-11/12

Bras & Triangle de suspension

Control arm
Brazo y triángulo
Wahacz
 Рычаг подвески

G/L D/R

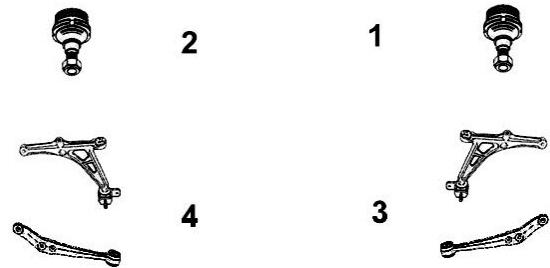

7476048
 OE 1723324

Triangle de susp. G
Left track control arm



4 Avec rotule *With ball joint*
 2.0 TDCi /4WD 03/08-
 2.5i Turbo /4WD 10/08-
 2.5 TDCi 4WD 07/10-

7476047
 OE 1723323

Triangle de susp. D
Right track control arm



3 Avec rotule *With ball joint*
 2.0 TDCi /4WD 03/08-
 2.5i Turbo /4WD 10/08-
 2.5 TDCi 4WD 07/10-

Mondeo ...

Éléments DIRECTION

Steering parts
Elementos Direcciones
Elementy układ kierowniczy
 Элементы рулевой системы

G/L D/R

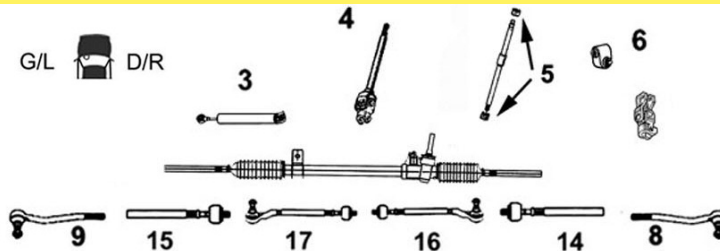

9006224

Axe de bielle G/D

Part/oe 7294415 *L/R axial joint*



14 Côté dir. M14x1.5 Côté rot. M16x1.5 long 340 mm
15 TT /all models Jante 14 pouces
 1.8i 16v. 08/96-12/00
 1.8i 16v. 110hp 81kw 125hp 92kw 01/01-06/07
 1.8 SCi 06/03-06/07
 1.8 TD 08/96-12/00
 2.0i 16v. Jante 14 pouces 08/96-12/00
 2.0i 16v. 145hp 107kw 01/01-06/07
 2.0 TDDi 90hp 66kw 115hp 85kw 01/01-06/07
 2.0 TDCi 115hp 85kw 130hp 95kw 01/01-06/07
 2.2 TDCi 07/04-06/07
 2.5i V6 170hp 125kw 01/01-06/07
 3.0 V6 07/04-06/07
 3.0i ST 225hp 166kw 04/02-06/07

... Mondeo ...

Eléments DIRECTION

Steering parts

Elementos Direcciones

Elementy uklad kierowniczy

Элементы рулевой системы

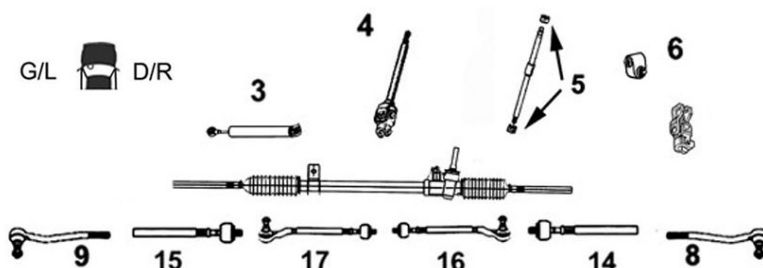

9006225

Axe de bielle G/D

OE 7294416

L/R axial joint



14 Côté dir. M14x1.5 Côté rot. M16x1.5
15 long 339 mm

TT /all models Jante Ø 15 pouces
10/94-08/96

9006233

Axe de bielle G/D

Part/oe 3903149

L/R axial joint



14 Côté dir. M14x1.5 Côté rot. M16x1.5
15 long 341 mm

1.8i 16v. 08/96-12/00
1.8 TD 08/96-12/00
2.0i 16v. 08/96-12/00
2.5i V6 Jante 15 pouces 08/96-12/00

7776025

Axe de bielle G/D

OE 1596574

L/R axial joint



14 Côté dir. M16x1.5 Côté rot. M18x1.5 long 315 mm
15

1.6i 16v. /Turbo/ SW
1.6 Ti 16v. SW
1.8 TDCi
2.0i 16v.
2.0i Turbo/ SW
2.0i ETH/ SW
2.0 TDCi /SW
2.2 TDCi FAP/ SW
2.3i 16v./ SW
2.5i Turbo 20v./ SW

SEBA
HUBA

BVA
BVM

09/10-
06/07-
06/07-09/10
06/07-12/07
03/10-
09/10-
09/10-
01/08-
09/07-09/10
06/07-09/10

9006359

Rotule de direction G

OE 5027451

Left tie rod end

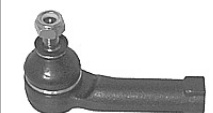

9 M16 x 1.5

TT /all models -08/96

9006358

Rotule de direction D

OE 5027452

Right tie rod end

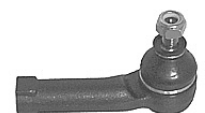

8 M16 x 1.5

TT /all models -08/96

9006462

Rotule de direction G

OE 1097323

Left tie rod end



9 M16 x 1.5

1.8i 16v. 08/96-12/00
1.8 TD 08/96-12/00
2.0i 16v. 08/96-12/00
2.5i V6 08/96-12/00

9006461

Rotule de direction D

OE 1097316

Right tie rod end



8 M16 x 1.5

1.8i 16v. 08/96-12/00
1.8 TD 08/96-12/00
2.0i 16v. 08/96-12/00
2.5i V6 08/96-12/00

9006467

Rotule de direction G/D

OE 1138313

L/R tie rod end



8 M16 x 1.5
9



1.8i 16v.
1.8i SCi.
2.0i 16v.
2.0 TDCi
2.0 TDDi
2.2 TDCi
2.5i V6
3.0i ST

01/01-03/07
06/03-03/07
01/01-03/07
01/01-03/07
01/01-03/07
07/04-03/07
01/01-03/07
04/02-03/07

... Mondeo ...

FORD



SASIC



7676025 OE 1433274	Rotule de direction G <i>Left tie rod end</i>	7676024 OE 1433273	Rotule de direction D <i>Right tie rod end</i>
	9 M18 x 1.5 1.6i Turbo 02/11- 1.6 Ti 16v. 06/07- 1.8 TDCi 06/07-09/10 2.0i 16v. /Turbo 06/07- 2.0 TDCi 06/07- 2.2 TDCi 03/08- 2.3i 16v. 09/07-09/10 2.5i Turbo 20v. 06/07-09/10		8 M18 x 1.5 1.6i Turbo 02/11- 1.6 Ti 16v. 06/07- 1.8 TDCi 06/07-09/10 2.0i 16v. /Turbo 06/07- 2.0 TDCi 06/07- 2.2 TDCi 03/08- 2.3i 16v. 09/07-09/10 2.5i Turbo 20v. 06/07-09/10

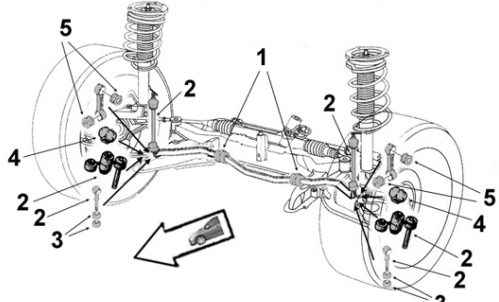



Barre stabilisatrice
Stabilizer bar
Barra estabilizadora
Drążek stabilizatora
 стабилизатор поперечной устойчивости



9005063 OE 6960036	Biellette barre stab. <i>Stabilizer bar stub axle</i>	9005007 OE 5106995	Biellette barre stab. <i>Stabilizer bar stub axle</i>
	2 Acier steel Entraxe : 232 mm M10x150 X2 1.6i 16v. /Clipper 01/93-09/00 1.8i 16v. /Clipper 01/93-09/00 1.8 TD /Clipper 01/93-09/00 2.0i 16v. /Clipper 01/93-09/00 2.5i V6 /Clipper 01/93-09/00		2 Alu alu Entraxe : 237 mm M10x150 X2 1.6i 16v. /Clipper 01/93-01/96 1.8i 16v. /Clipper 01/93-09/00 1.8 TD /Clipper 07/93-09/00 2.0i 16v. /Clipper 01/93-09/00 2.5i V6 /Clipper 07/94-09/00

9005008 OE 1117698	Biellette barre stab. <i>Stabilizer bar stub axle</i>	9005009 OE 1219697	Biellette barre stab. <i>Stabilizer bar stub axle</i>
	2 1.8i 16v. /Clipper 01/01-08/02 2.0i 16v. /Clipper 01/01-08/02 2.0 TDCi /Clipper 10/00-08/02 2.0 TDDi /Clipper 01/01-08/02 2.2 TDCi 155hp 114kw /Clipper 07/04-08/02 2.5i V6 170hp 125kw /Clipper 01/01-08/02 3.0i ST /Clipper 07/04-08/02		2 1.8i 16v. /Clipper 09/02-06/07 1.8i SCi /Clipper 09/02-06/07 2.0i 16v. /Clipper 09/02-06/07 2.0 TDCi /Clipper 09/02-06/07 2.0 TDDi /Clipper 09/02-06/07 2.2 TDCi /Clipper 09/02-06/07 2.5i V6 /Clipper 09/02-06/07 3.0i ST /Clipper 09/02-06/07

2306025 OE 1377849	Biellette barre stab. <i>Stabilizer bar stub axle</i>		
	2 1.6i 16v./Turbo /Clipper 09/10- 1.6i /Turbo/Ti/16v./Clipper 06/07- 1.8 TDCi /Clipper 06/07-09/10 2.0i 16v. /Clipper 06/07-12/07 2.0i ETH /Clipper 12/07- 2.0i Turbo /Clipper 03/10- 2.0 TDCi /Clipper 06/07- 2.2 TDCi /DPF /Clipper 01/08- 2.3i 16v. /Clipper 09/07-09/10 2.5i Turbo 20v. /Clipper 06/07-09/10		

2306033 OE 1128725	Palier de barre <i>Bar main bearing</i>	9001783 OE 1118695	Palier de barre milieu <i>Middle bar main bearing</i>
	1 Ø 19 1.6i 16v. BVM 01/93-01/96 1.8i 16v. 01/93-09/00 1.8 TD/Clipper/BVM 07/93-09/00 2.0i 16v. /4WD 01/93-09/00 2.5i V6 24v. 07/94-09/00		1 1.8i 16v. /Clipper 01/01- 1.8i SCi /Clipper -15/08/03 2.0i 16v. /Clipper 01/01- 2.0 TDCi /Clipper 01/01- 2.0 TDDi /Clipper 01/01- 2.2 TDCi /Clipper 07/04-06/07 2.5i V6 24v./Clipper -15/08/03 3.0i V6 /Clipper 04/02-

... Mondeo ...



Eléments SUSPENSION

Suspension parts

Elementos suspensión

Elementy zawieszenie

Элементы подвески

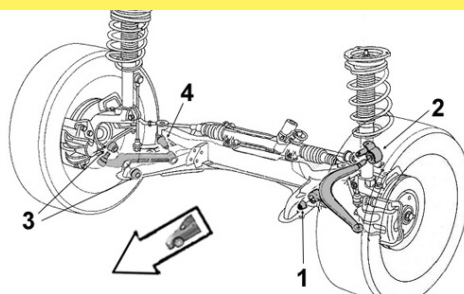

FORD

SASIC

9001589

Articulation AR

OE 6870549

Rear bush



2 Ø int.12 Ø ext.46 long. tube int.45 ext.25

1.6i 16v. /Clipper	01/93-09/96
1.8i 16v. /Clipper	01/93-09/96
1.8 TD /Clipper	01/93-09/96
2.0i 16v. /Clipper	01/93-09/96
2.5i V6 /Clipper	01/93-09/96

9001592

Articulation AR

OE 1023058

Rear bush



2 Ø int.12 Ø ext.60 long. tube int.46 ext.25.5

1.6i 16v.	09/96-09/00
1.8i 16v.	09/96-09/00
1.8 TD /Clipper	09/96-09/00
2.0i 16v.	09/96-09/00
2.5i V6	09/96-09/00

2256023

Articulation AR

Part/oe 1522081

Rear bush



2 Ø int. 13 Ø ext. 78 coll. 86
long. tube int. 78 ext. 42

1.8i 16v. /Clipper BVM	11/00-06/07
1.8i SCi /Clipper BVM	06/03-06/07
2.0i 16v. /Clipper	09/00-06/07
2.0 TDCi /Clipper	12/01-06/07
2.0 TDDi /Clipper BVM	09/00-06/07
2.2 TDCi /Clipper BVM	07/04-06/07
2.5i V6 24v. /Clipper	11/00-06/07
3.0i ST /Clipper BVM	04/02-06/07
3.0i V6 24v. BVM	07/04-06/07

9001593

Articulation AV

OE 6790115

Front bush



1 Ø int.12 Ø ext.47.5 long. tube int.45 ext.28

1.6i 16v. /Clipper	01/93-09/00
1.8i 16v. /Clipper	01/93-09/00
1.8 TD /Clipper	01/93-09/00
2.0i 16v. /Clipper	01/93-09/00
2.5i V6 /Clipper	01/93-09/00

2256022

Articulation AV

Part/oe 1522081

Front bush



1 Ø int. 12 Ø ext. 35 coll. 47 coll. 49 long. tube int. 69 ext. 55.5

1.8i 16v. /Clipper	BVM	11/00-06/07
1.8i SCi /Clipper	BVM	06/03-06/07
2.0i 16v. /Clipper		09/00-06/07
2.0 TDCi /Clipper		12/01-06/07
2.0 TDDi /Clipper	BVM	09/00-06/07
2.2 TDCi /Clipper	BVM	07/04-06/07
2.5i V6 24v. /Clipper		11/00-06/07
3.0i ST /Clipper	BVM	04/02-06/07
3.0i V6 24v.	BVM	07/04-06/07

Bras & Triangle de suspension

Control arm
Brazo y triángulo
Wahacz
Рычаг подвески

G/L D/R

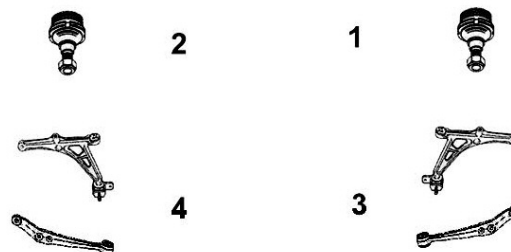

9005128

Triangle de susp. G

OE 1043158

Left track control arm



4 Avec rotule With ball joint

TT /all models -12/00

9005129

Triangle de susp. D

OE 1043159

Right track control arm













3 Avec rotule With ball joint

TT /all models -12/00

... Mondeo

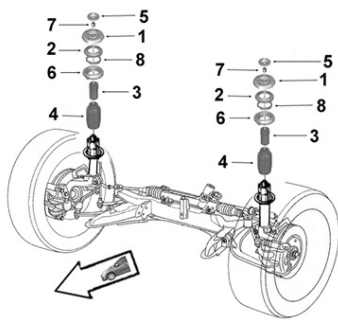
FORD

SASIC

9005716 OE 1311417 	Triangle de susp. G <i>Left track control arm</i> 4 Avec rotule With ball joint TT /all models Sauf ST220 01/01-06/07	9005717 OE 1311416 	Triangle de susp. D <i>Right track control arm</i> 3 Avec rotule With ball joint TT /all models Sauf ST220 01/01-06/07
7476043 OE 1507182 	Triangle de susp. G <i>Left track control arm</i> 4 Avec rotule With ball joint 1.6i Turbo 02/11- 1.6 Ti 16v. 06/07- 1.8 TDCi 06/07-09/10 2.0i 16v. /Turbo 06/07- 2.0 TDCi 06/07- 2.2 TDCi 03/08- 2.3i 16v. 09/07-09/10 2.5i Turbo 20v. 06/07-09/10	7476042 OE 1507181 	Triangle de susp. D <i>Right track control arm</i> 3 Avec rotule With ball joint 1.6i Turbo 02/11- 1.6 Ti 16v. 06/07- 1.8 TDCi 06/07-09/10 2.0i 16v. /Turbo 06/07- 2.0 TDCi 06/07- 2.2 TDCi 03/08- 2.3i 16v. 09/07-09/10 2.5i Turbo 20v. 06/07-09/10
9005243 OE 93BB3395AC 	Rotule de susp. inf. G/D <i>L/R lower suspension ball joint</i> 1 2 TT /all models -12/00	7576008 Part/oe 1522081 	Rotule de susp. inf. G/D <i>L/R lower suspension ball joint</i> 1 2 Ø 21 1.8i 16v. 09/00-06/07 1.8i SCi 06/03-06/07 2.0i 16v. 09/00-06/07 2.0 TDCi 12/01-06/07 2.0 TDDi 09/00-06/07 2.2 TDCi 09/04-06/07 2.5i V6 24v. 09/00-06/07 3.0i ST /Clipper 09/02-
 Support d'amortisseur <i>Suspension mounting</i> <i>Soporte amortiguador</i> <i>Poduszka amortyzatora</i> <i>Опора амортизатора</i>			
9001456 OE 6799585 	Support suspension G/D <i>L/R suspension mounting</i> 1 1.6i 16v. /Clipper 01/93- 1.8i 16v. /Clipper 01/93- 1.8 TD /Clipper 01/93- 2.0i 16v. /Clipper 01/93- 2.5i V6 01/97-	9005626 OE 4609099 	Support suspension G/D <i>L/R suspension mounting</i> 1 1.8i 16v./Clipper 01/01-06/07 2.0i 16v./Clipper 01/01-06/07 2.0 TDCi /Clipper 01/01-06/07 2.0 TDDi /Clipper 01/01-06/07 2.5i V6 /Clipper 01/01-06/07 3.0i V6 /Clipper 04/02-06/07
8005210 OE 1115177 	Butée à billes <i>Ball bearing</i> 2 1.8i 16v. /Clipper 01/01-06/07 2.0i 16v. /Clipper 01/01-06/07 2.0 TDCi /Clipper 01/01-06/07 2.0 TDDi /Clipper 01/01-06/07 2.5i V6 /Clipper 01/01-06/07	2656034 OE 1023328 	Butée de suspension G/D <i>L/R suspension bush</i> 3 TT /all models 10/96-09/00

... Mondeo



Barre stabilisatrice

Stabilizer bar
Barra estabilizadora
Drażek stabilizatora
стабилизатор поперечной устойчивости

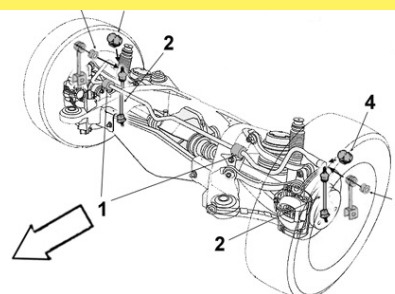

9005010

Biellette barre stab.

OE 1130452

Stabilizer bar stub axle

2



1.8i 16v. Clipper	01/01-06/07
2.0i 16v. Clipper	01/01-06/07
2.0 TDCi Clipper	01/01-06/07
2.0 TDDi Clipper	01/01-06/07
2.2 TDCi Clipper	09/04-06/07
2.5i V6 Clipper	01/01-06/07
3.0i ST Clipper	10/00-06/07

2306027

Biellette barre stab.

OE 1127648

Stabilizer bar stub axle

2



1.8i 16v. Berline	09/00-06/07
1.8i SCi Berline	06/03-06/07
2.0i 16v. Berline	09/00-06/07
2.0 TDCi Berline	04/02-06/07
2.0 TDDi Berline	09/00-06/07
2.2 TDCi Berline	07/04-06/07
2.5i V6 24v. Berline	09/00-06/07
3.0i ST Berline	04/02-06/07

Eléments TRAIN ARRIERE

Rear axle parts
Tren TRAS
Elementy zawieszenia tylnego
элементы задней оси.



9001598

Articulation

OE 6901534

Bush

Ø int.12 Ø ext.39 long. tube int.45 ext.30



1.6i 16v.	-09/00
1.8i 16v.	-09/00
1.8 TD	-09/00
2.0i 16v.	-09/00
2.5i V6	-09/00



Support d'amortisseur

Suspension mounting
Soporte amortiguador
Poduszka amortyzatora
Опора амортизатора

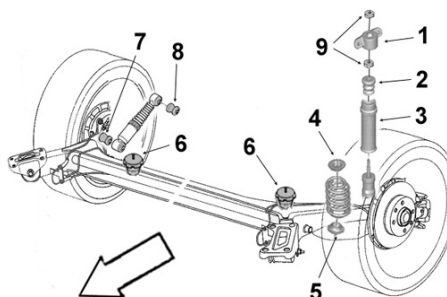

9001435

Support suspension G/D

OE 6838725

L/R suspension mounting

1



1.6i 16v. Berline	01/93-01/96
1.8i 16v. Berline	01/93-09/00
1.8 TD Berline	07/93-09/00
2.0i 16v. Berline	07/93-09/00
2.5i V6 Berline	07/94-09/00

Orion ...

Eléments DIRECTION

Steering parts

Elementos Direcciones



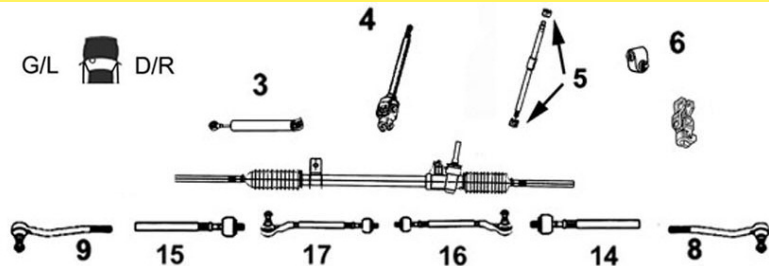

Elementy uklad kierowniczy

Элементы рулевой системы



FORD

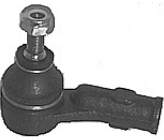
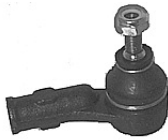

9006221 OE 1652651 	Axe de bielle G/D <i>L/R axial joint</i> M14 x 1.5 1/2x20pouces 290 mm TT /all models 08/83-08/90	9006222 OE 6180350 	Axe de bielle G/D <i>L/R axial joint</i> Côté dir. M14x1.5 Côté rot. M14x2.0 long 323 mm TT /all models DNA 09/90-12/94
9006223 OE 6197238 	Axe de bielle G/D <i>L/R axial joint</i> Côté dir. M14x1.5 Côté rot. M14x2.0 long 308 mm TT /all models DA 09/90-12/94	9006352 OE 5021410 	Rotule de direction G/D <i>L/R tie rod end</i> M1/2 x 20 pouces TT /all models 08/83-08/90
9006350 OE 1015547 	Rotule de direction G <i>Left tie rod end</i> M14 x 2 TT /all models 09/90-12/94	9006351 OE 1015546 	Rotule de direction D <i>Right tie rod end</i> M14 x 2 TT /all models 09/90-12/94



Barre stabilisatrice



Stabilizer bar

Barra estabilizadora

Drażek stabilizatora

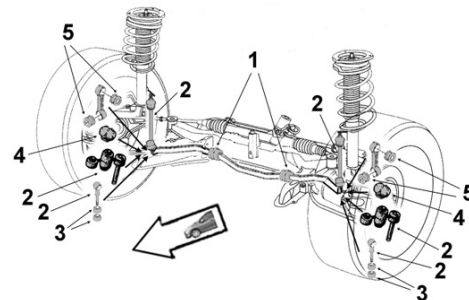
стабилизатор поперечной устойчивости



9005064 OE 1130273 	Biellette barre stab. <i>Stabilizer bar stub axle</i> Acier steel 1.4i 11/90-01/94 1.6i /16v. 11/90-01/94 1.8i 11/90-01/94 1.8 D 11/90-01/94 1.8 TD 07/93-01/94	9001534 OE 7102392 	Palier de barre milieu <i>Middle bar main bearing</i> Barre Ø 18 1.3 01/91- 1.4 01/91- 1.6 01/91- 1.8 01/91- 1.8 D 01/91- 1.8 TD 01/91-
---	---	--	--

... Orion ...

SASIC

FORD



Barre stabilisatrice
Stabilizer bar
Barra estabilizadora
Drażek stabilizatora
 стабилизатор поперечной устойчивости

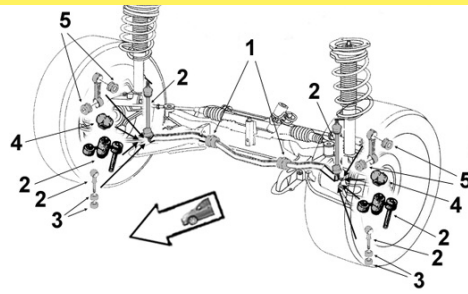

9001600 **Palier de barre milieu**
 OE 1634900 *Middle bar main bearing*



1	Barre Ø 22	
	1.4	-12/90
	1.6	-12/90
	1.6i	-12/90
	1.6 D	-12/90
	1.8 D	-12/90



Eléments SUSPENSION
Suspension parts
Elementos suspensión
Elementy zawieszenie
 Элементы подвески

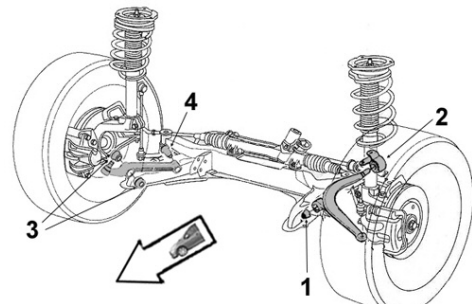

9001690 **Articulation int.**
 OE 6192705 *Inner bush*



4	Ø int.12 Ø ext.35 coll.40 x2 long. tube int.51 ext.30 ep. coll.5	
	1.3	-12/90
	1.4	-12/90
	1.6	-12/90
	1.6 D	-12/90
	1.8 D	-12/90

9001595 **Articulation AR**
 OE 1035929 *Rear bush*



2	Ø int.12 Ø ext.54 coll.62 long. tube int.45.5 ext.24.5 coll.3	
	1.3	01/91-
	1.4	01/91-
	1.6	01/91-
	1.8	01/91-
	1.8 D	01/91-
	1.8 TD	01/91-

9001689 **Articulation AV**
 OE 1000445 *Front bush*



1	Ø int.12 Ø ext.46 long. tube int.45 ext.25	
	1.3	01/91-
	1.4	01/91-
	1.6	01/91-
	1.8	01/91-
	1.8 D	01/91-
	1.8 TD	01/91-

... Orion ...

Bras & Triangle de suspension

Control arm
Brazo y triángulo
Wahacz
Рычаг подвески

G/L  D/R

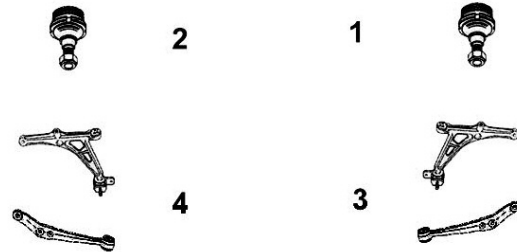

FORD



... Orion

SASIC



Support d'amortisseur
Suspension mounting
Soporte amortiguador
Poduszka amortyzatora
Опора амортизатора

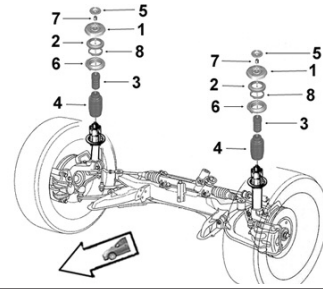

OE 6495311 *L/R suspension mounting*



1

1.3	-01/95
1.4	-01/95
1.6	-01/95
1.8	-01/95
1.8 D	-01/95
1.8 TD	-01/95

7776023 *Axe de bielle G/D*

Puma ...

Eléments DIRECTION
Steering parts
Elementos Direcciones
Elementy układ kierowniczy
Элементы рулевой системы

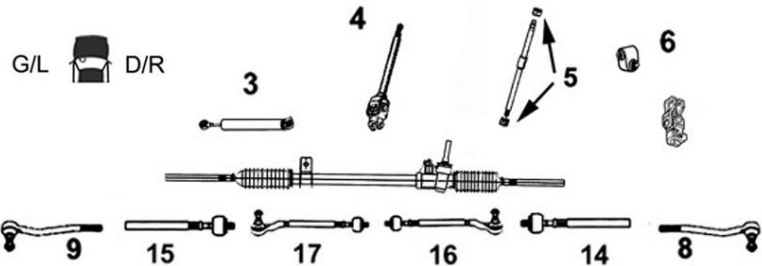

OE 1044014 *L/R axial joint*
14 *Côté dir. M14x1.5 Côté rot. M14x2.0 long 307 mm*
15



1.4i 16v.	-08/00
1.6i 16v.	09/00-
1.7i 16v.	04/97-

9006660 *Rotule de direction G*

OE 1020175 *Left tie rod end*

9 *M14x2*



1.4i 16v.	09/00-09/02
1.6i 16v.	
1.7i 16v.	

OE 1020174 *Right tie rod end*

8 *M14x2*



1.4i 16v.	09/00-09/02
1.6i 16v.	
1.7i 16v.	

9006661 *Rotule de direction D*

... Puma ...



Barre stabilisatrice
 Stabilizer bar
 Barra estabilizadora
 Drażek stabilizatora
 стабилизатор поперечной устойчивости

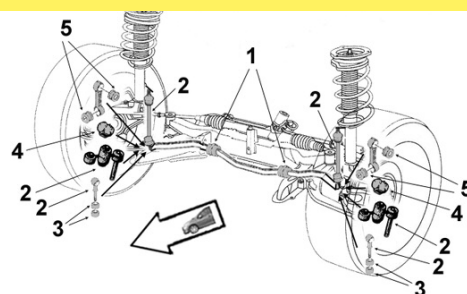

FORD



... Puma

Bras & Triangle de suspension

Control arm
Brazo y triángulo
Wahacz
Рычаг подвески

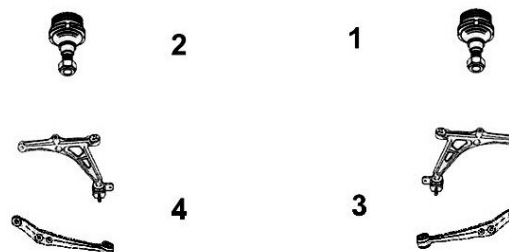
G/L  D/R**9005249****Rotule de susp. inf. G/D**

OE 1030025

*L/R lower suspension ball joint***1** 3 points d'ancrage 3 Cramping points**2**

1.4i 16v.
1.6i 16v.
1.7i 16v.

**Support d'amortisseur**

Suspension mounting
Soporte amortiguador
Poduszka amortyzatora
Опора амортизатора

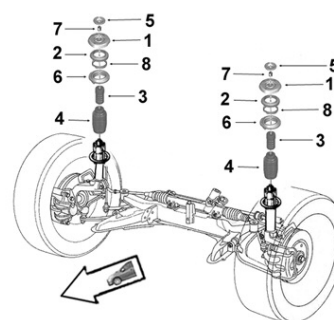
**8005209****Butée à billes**

OE 1002513

*Ball bearing***2**

1.4i 16v.
1.6i 16v.
1.7i 16v.

Scorpio ...

Eléments DIRECTION

Steering parts
Elementos Direcciones
Elementy układ kierowniczy
Элементы рулевой системы

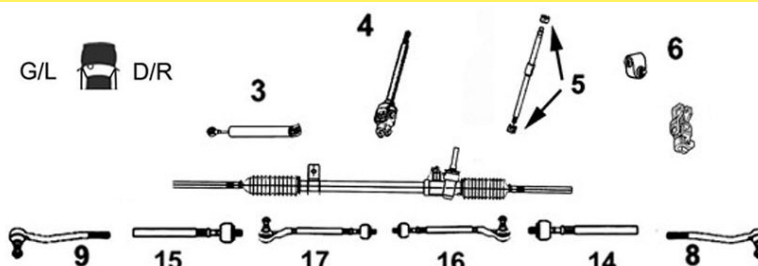
**9006227****Axe de bielle G/D**

OE 6185338

L/R axial joint

14 Côté dir. M14x1.5 Côté rot. M14x2.0
15 long 294 mm

TT /all models 03/85-10/94

**9006360****Rotule de direction G/D**

OE 6160988





L/R tie rod end

8
9 M14 x 2

TT /all models 03/85-10/94



... Scorpio

9006362 OE 5030222	Rotule de direction G <i>Left tie rod end</i>	9006361 OE 5030221	Rotule de direction D <i>Right tie rod end</i>
	9 M16 x 1.5 TT /all models 10/94-		8 M16 x 1.5 TT /all models 10/94-
9005127 OE 5021463	Bras de suspension G <i>Left track control arm</i>	9005126 OE 5021462	Bras de suspension D <i>Right track control arm</i>
	4 Avec rotule <i>With ball joint</i> TT /all models Sauf 4WD 03/85-10/94		3 Avec rotule <i>With ball joint</i> TT /all models Sauf 4WD 03/85-10/94



FORD

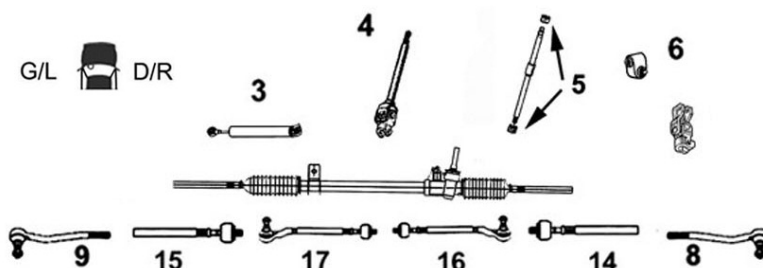

Sierra...

Eléments DIRECTION
Steering parts
Elementos Direcciones
Elementy uklad kierowniczy
Элементы рулевой системы



9006228 OE 6131083	Axe de bielle G/D <i>L/R axial joint</i>		
	14 Côté dir. M14x1.5 Côté rot. M14x2.0 long 281 mm 15 TT /all models Sauf 4WD 10/82-07/93		
9006353 OE 5021414	Rotule de direction G <i>Left tie rod end</i>	9006354 OE 5021413	Rotule de direction D <i>Right tie rod end</i>
	9 M14 x 2 TT /all models Sauf 4WD 10/82-07/93		8 M14 x 2 TT /all models Sauf 4WD 10/82-07/93

... Sierra



Eléments SUSPENSION
Suspension parts
Elementos suspensión
Elementy zawieszenie
Элементы подвески

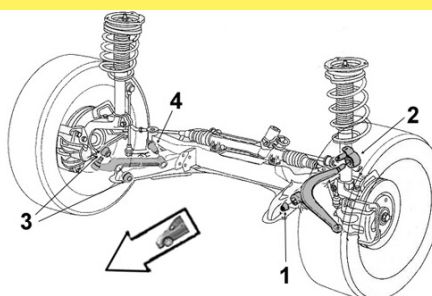

FORD

9001587

Articulation int. bras

OE 1619120

Arm inner bush

4 Ø int.10 Ø ext.33 coll.38 long. tube int.51 ext.24 ep. coll.7



1.6
1.8
1.8 TD
2.0
2.3 D

08/82-
08/82-
08/82-
08/82-
08/82-

Bras & Triangle de suspension

Control arm
Brazo y triángulo
Wahacz
Рычаг подвески

G/L  D/R

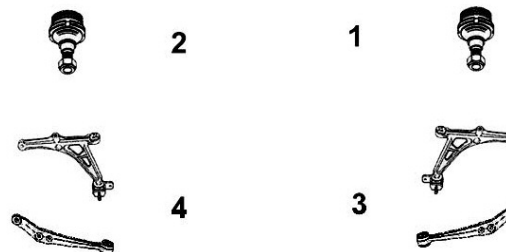

9005114

Bras de suspension G

OE 5021461

Left track control arm

4 Avec rotule With ball joint



TT /all models Sauf 4WD
10/82-07/93

9005116

Bras de suspension D

OE 5021460

Right track control arm

3 Avec rotule With ball joint



TT /all models Sauf 4WD
10/82-07/93

S-Max ...

Eléments DIRECTION

Steering parts
Elementos Direcciones
Elementy układ kierowniczy
Элементы рулевой системы

G/L  D/R

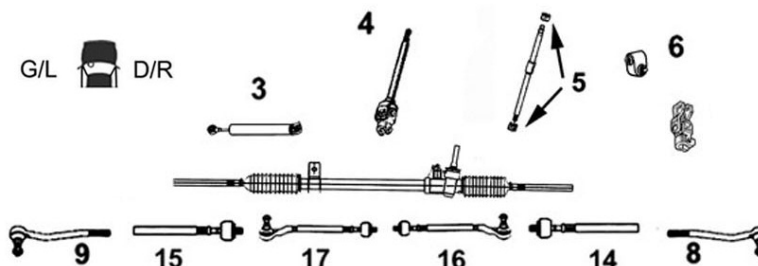

7776025

Axe de bielle G/D

OE 1596574

L/R axial joint

14 Côté dir. M16x1.5 Côté rot. M18x1.5 long 315 mm



15
1.6i Turbo
1.6 TDCi FAP
1.8 TDCi
2.0i 16v.
2.0i ETH
2.0i Turbo
2.0 TDCi
2.2 TDCi FAP
2.3i 16v.
2.5i Turbo 20v.

03/10-
03/11-
05/06-
05/06-
01/08-
03/10-
05/06-
01/08-
07/07-
05/06-

SEWA BVA
HUWA BVM

... S-Max

FORD

SASIB

7676025 **Rotule de direction G**
 OE 1433274 *Left tie rod end*



9	M18 x 1.5	
	1.6i Turbo	03/11-
	1.6 TDCi	03/11-
	1.8 TDCi	05/06-
	2.0i 16v.	05/06-
	2.0i Turbo	01/08-
	2.0 TDCi	05/06-
	2.2 TDCi	03/08-
	2.3i 16v.	07/07-
	2.5i Turbo 20v.	05/06-

7676024 **Rotule de direction D**
 OE 1433273 *Right tie rod end*



8	M18 x 1.5	
	1.6i Turbo	03/11-
	1.6 TDCi	03/11-
	1.8 TDCi	05/06-
	2.0i 16v.	05/06-
	2.0i Turbo	01/08-
	2.0 TDCi	05/06-
	2.2 TDCi	03/08-
	2.3i 16v.	07/07-
	2.5i Turbo 20v.	05/06-



Barre stabilisatrice
Stabilizer bar
Barra estabilizadora
Drażek stabilizatora
 стабилизатор поперечной устойчивости

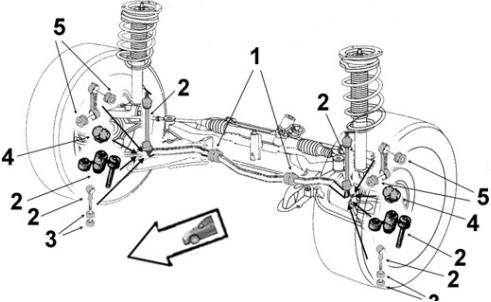

2306025 **Biellette barre stab.**
 OE 1377849 *Stabilizer bar stub axle*









2	1.6i Turbo	03/10-
	1.6 TDCi	03/11-
	1.8 TDCi	05/06-
	2.0i 16v.	05/06-
	2.0i Turbo	03/10-
	2.0 TDCi	05/06-
	2.2 TDCi	01/08-
	2.3i 16v.	07/07-
	2.5i Turbo 20v.	05/06-

BVM 05/06-
 BVM 05/06-
 BVA 07/07-
 BVM 05/06-

Bras & Triangle de suspension
Control arm
Brazo y triángulo
Wahacz
 Рычаг подвески

G/L  D/R

	2		1
			
	4		3

7476043 **Triangle de susp. G**
 OE 1507182 *Left track control arm*



4 *Avec rotule With ball joint*

	1.6i Turbo	03/11-
	1.6 TDCi	03/11-
	1.8 TDCi	05/06-
	2.0i 16v.	05/06-
	2.0i Turbo	05/06-
	2.0 TDCi	05/06-
	2.2 TDCi	03/08-
	2.3i 16v.	07/07-
	2.5i Turbo 20v.	05/06-

7476042 **Triangle de susp. D**
 OE 1507181 *Right track control arm*



3 *Avec rotule With ball joint*

	1.6i Turbo	03/11-
	1.6 TDCi	03/11-
	1.8 TDCi	05/06-
	2.0i 16v.	05/06-
	2.0i Turbo	05/06-
	2.0 TDCi	05/06-
	2.2 TDCi	03/08-
	2.3i 16v.	07/07-
	2.5i Turbo 20v.	05/06-

StreetKa ...

SASIC

FORD

Eléments DIRECTION
 Steering parts
 Elementos Direcciones
 Elementy układ kierowniczy
 Элементы рулевой системы

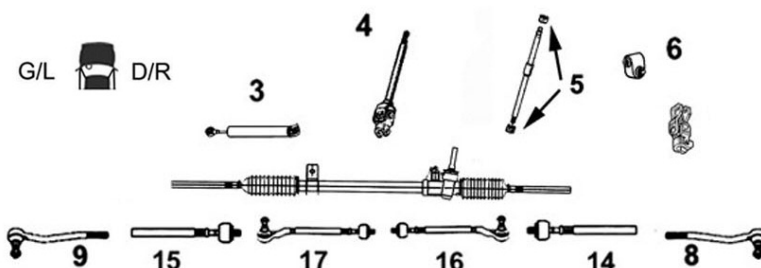

9006357 Rotule de direction G/D

OE 1034417 L/R tie rod end



8
9 M1/2 x 20 pouces

1.6i

01/03-12/05



Barre stabilisatrice
 Stabilizer bar
 Barra estabilizadora
 Drażek stabilizatora
 стабилизатор поперечной устойчивости

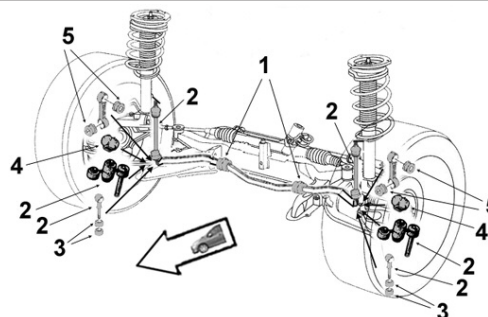

9005004 Bielle barre stab.

OE 1135077 Stabilizer bar stub axle



2 Alu alu

1.6i

01/03-12/05



Eléments SUSPENSION
 Suspension parts
 Elementos suspensión
 Elementy zawieszenie
 Элементы подвески

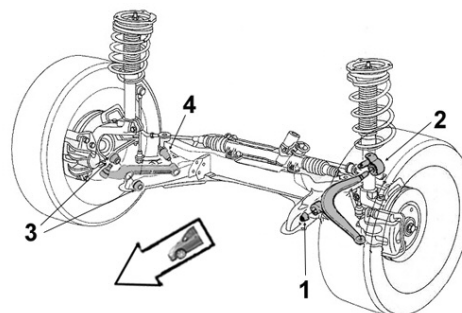

9001595 Articulation AR

OE 1035929 Rear bush



2 Ø int.12 Ø ext.54 coll.62 long. tube int.45.5 ext.24.5 coll.3

1.6i

CDRA/B BVM

01/03-12/05

... StreetKa

Eléments TRAIN ARRIERE

Rear axle parts

Tren TRAS

Elementy zawieszenia tylnego

элементы задней оси.



9001747

OE 1016439

Articulation essieu AR

Rear axle bush

Ø int.12 Ø ext.63 long. tube int.70 ext.55



1.6i CDRA/B BVM 01/03-12/05

Courier ...

Eléments DIRECTION

Steering parts

Elementos Direcciones

Elementy uklad kierowniczy

Элементы рулевой системы

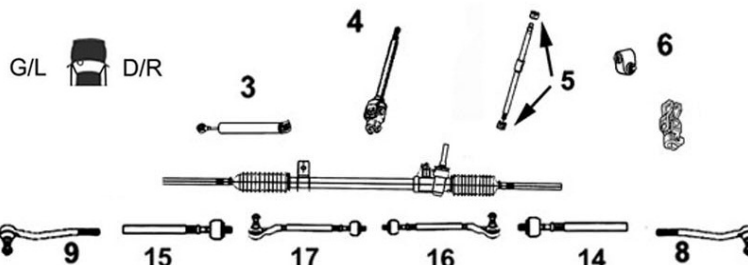

9006220

OE 1659374

Axe de bielle G/D

L/R axial joint



14
15

M14 x 1.5 1/2x20pouces 300 mm

TT /all models

01/89-12/95

9006352

OE 5021410

Rotule de direction G/D

L/R tie rod end



8
9

M1/2 x 20 pouces

TT /all models

01/89-01/94

9006357

OE 1034417

Rotule de direction G/D

L/R tie rod end



8
9

M1/2 x 20 pouces

TT /all models

01/94-12/95

9006660

OE 1020175

Rotule de direction G

Left tie rod end



9

M14 x 2

TT /all models

01/96-

9006661

OE 1020174

Rotule de direction D

Right tie rod end



8

M14 x 2

TT /all models

01/96-

9004007

OE 7257202

Cardan colonne de direction

Cardan joint



7

TT /all models

01/89-08/95

... Courier ...

SASIC

FORD



Barre stabilisatrice
 Stabilizer bar
 Barra estabilizadora
 Drażek stabilizatora
 стабилизатор поперечной устойчивости

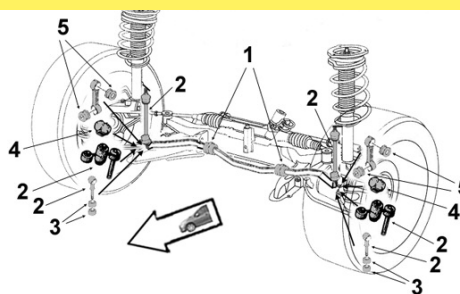

9005064 **Biellette barre stab.**
 OE 1071336 *Stabilizer bar stub axle*



2 Acier steel

1.3	01/89-
1.8 D	01/89-
1.8 TDdi	04/00-

9001534 **Palier de barre milieu**
 OE 7102392 *Middle bar main bearing*

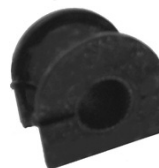

1 Barre Ø 18

1.3	01/96-
1.8 D	01/96-



Eléments SUSPENSION
 Suspension parts
 Elementos suspensión
 Elementy zawieszenie
 Элементы подвески

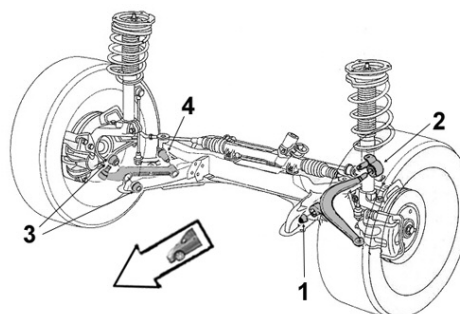

9001594 **Articulation AR**
 OE 1010037 *Rear bush*



2 Ø int.12 Ø ext.37 long. tube int.62 ext.44

1.3	01/94-01/98
1.4i 16v.	01/94-01/98
1.8 D	01/94-01/98

9001588 **Articulation AR**
 OE 1063372 *Rear bush*



2 Ø int.12 Ø ext.66 long. tube int.50 ext.30

1.3	01/98-
1.8 D	01/98-
1.8 TDdi	04/00-09/02

9001689 **Articulation AV**
 OE 1000445 *Front bush*



1 Ø int.12 Ø ext.46 long. tube int.45 ext.25

1.3	01/92-01/94
1.4	01/92-01/94
1.8 D	01/92-01/94

9001588 **Articulation AV**
 OE 1014654 *Front bush*



1 Ø int.12 Ø ext.66 long. tube int.50 ext.30

1.3	01/94-12/96
1.4i 16v.	01/94-12/96
1.8 D	01/94-12/96

9001596 **Articulation AV**
 OE 1055191 *Front bush*



1 Ø int.12 Ø ext.38 long. tube int.62 ext.44

1.3i	15/05/98-09/02
1.8 D	15/05/98-09/02
1.8 TDdi	04/00-09/02

... Courier ...

Bras & Triangle de suspension

Control arm
Brazo y triángulo
Wahacz
Рычаг подвески

G/L  D/R

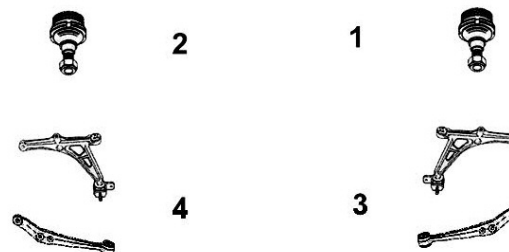

FORD



... Courier



Support d'amortisseur

Suspension mounting
Soporte amortiguador
Poduszka amortyzatora
Опора амортизатора

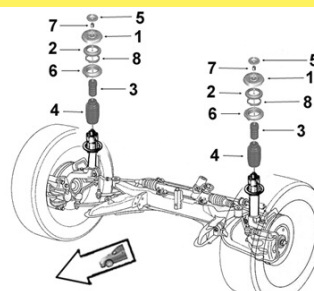

9005606

Support suspension G/D

OE 6150277

L/R suspension mounting



1

1.3
1.4
1.8 D

01/95-10/96
01/95-12/96
-10/96

9001454

Support suspension G/D

OE 1013794

L/R suspension mounting



1

1.3
1.8 D

10/96-
10/96-

Tourneo



Barre stabilisatrice

Stabilizer bar
Barra estabilizadora
Drażek stabilizatora
стабилизатор поперечной устойчивости

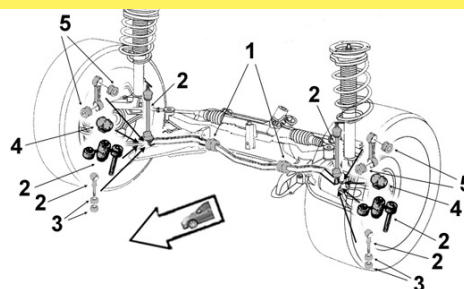

2306028

Biellette barre stab.

OE 4519467

Stabilizer bar stub axle



2

2.2 TDCi VP

09/06-



Support d'amortisseur

Suspension mounting
Soporte amortiguador
Poduszka amortyzatora
Опора амортизатора

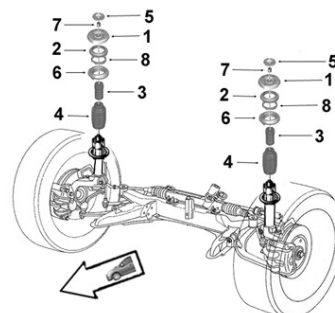

2656031

Butée à billes G/D

OE 1377929

L/R ball bearing



2

2.2 TDCi

09/06-

Tourneo Connect ...

Eléments DIRECTION
 Steering parts
 Elementos Direcciones
 Elementy układ kierowniczy
 Элементы рулевой системы

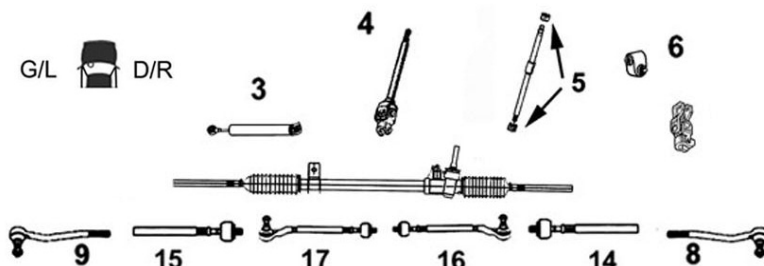

FORD



9006232

Axe de bielle G/D

Part/oe 1085520

L/R axial joint



14 Côté dir. M14x1.5
15 Côté rot. M14x2.0 long 340 mm

1.8i 16v. 09/02-
 1.8 TDDi 09/02-

9006667

Rotule de direction G/D

OE 4381840

L/R tie rod end



8 M14 x 1.75
9

1.8i 16v. 09/02-
 1.8 TDDi 09/02-



Barre stabilisatrice
 Stabilizer bar
 Barra estabilizadora
 Drażek stabilizatora
 стабилизатор поперечной устойчивости

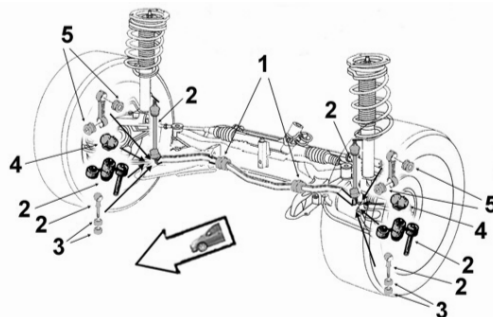

2306132

Palier de barre milieu

OE 4419559

Middle bar main bearing

NEW



1 Ø 24.5

1.8i 16v. 09/02-04/09
 1.8 TDCi 06/02-
 1.8 TDDi 06/02-

Bras & Triangle de suspension

Control arm
 Brazo y triángulo
 Wahacz
 Рычаг подвески

G/L D/R



7476045

Triangle de susp. G

OE 1355050

Left track control arm



4 Sans rotule Without ball joint

1.8i 16v. 09/02-04/09
 1.8 TDCi 06/02-04/09
 1.8 TDDi 09/02-04/09

7476044

Triangle de susp. D

OE 1355048

Right track control arm



3 Sans rotule Without ball joint

1.8i 16v. 09/02-04/09
 1.8 TDCi 06/02-04/09
 1.8 TDDi 09/02-04/09

...Tourneo Connect

SASIC

FORD

Bras & Triangle de suspension

Control arm
Brazo y triángulo
Wahacz
Рычаг подвески

G/L  D/R

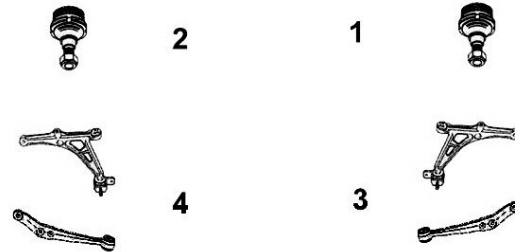

9005528

Rotule de susp. G/D

OE 4386870

L/R suspension ball joint



1
2

1.8i 16v.
1.8 TDDi

09/02-
09/02-



Barre stabilisatrice

Stabilizer bar
Barra estabilizadora
Drażek stabilizatora
стабилизатор поперечной устойчивости

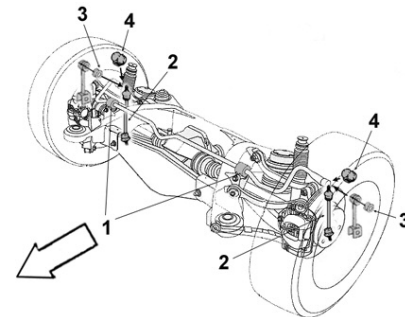

2306133

Palier de barre

OE 4419557

Bar main bearing

NEW



1 Ø 22

1.8i 16v.
1.8 TDCi
1.8 TDDi

09/02-04/09
06/02-
05/02-

Transit ...

Eléments DIRECTION

Steering parts
Elementos Direcciones
Elementy układ kierowniczy
Элементы рулевой системы

G/L  D/R

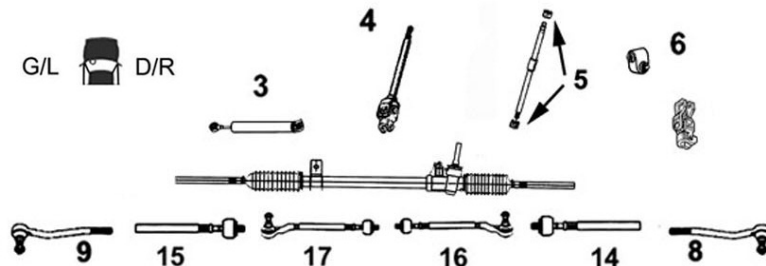

9006231

Axe de bielle G/D

OE 6156463

L/R axial joint



14 Côté dir. M14x1.5
15 Côté rot. M16x1.5 long 399 mm

TT /all models dir. à crémaillère
10/85-01/92

9006835

Axe de bielle G/D

Part/oe 6869951

L/R axial joint











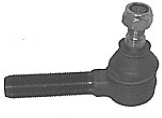

14 Côté dir. M16x1.5
15 Côté rot. M16x1.5 long 399 mm

TT /all models 01/92-08/00

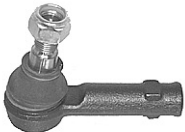
... Transit ...

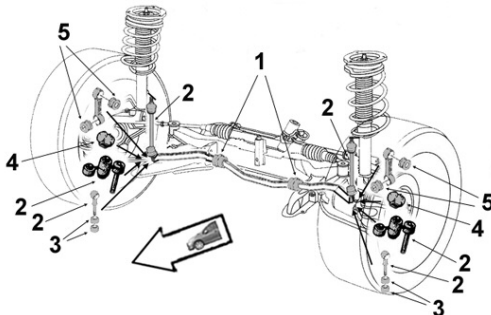
FORD

SASIC

9006885 OE 4059923	Axe de bielle G <i>Left axial joint</i>	9006884 OE 4059924	Axe de bielle D <i>Right axial joint</i>
	15 Côté dir. M16x1.5 Côté rot. M16x1.5 long 380 mm 2.0 TDCi 04/02-09/06 2.0 TDDi 08/00-09/06 2.2 TDCi 09/06- 2.3i 16v. DOHC 01/00- 2.4 TDCi 08/04- 2.4 TDDi 03/00-15/12/04		14 Côté dir. M20x1.5 Côté rot. M16x1.5 long 379 mm 2.0 TDCi 04/02-09/06 2.0 TDDi 08/00-09/06 2.2 TDCi 09/06- 2.3i 16v. DOHC 01/00- 2.4 TDCi 08/04- 2.4 TDDi 03/00-15/12/04
9006365 OE 6148996	Rotule de direction D <i>Right tie rod end</i>	9006363 OE 6172643	Rotule de direction G/D <i>L/R tie rod end</i>
	8 M20 x 1.5 TT /all models dir. à boîtier 130 190 100L 10/85-08/87		8 9 M16 x 1.5 TT /all models dir. à crémaillère 10/85-01/92
9006364 OE 1039103	Rotule de direction G/D <i>L/R tie rod end</i>	9006465 OE 1736669	Rotule de direction G/D <i>L/R tie rod end</i>
	8 9 M16 x 1.5 TT /all models DA 01/92-08/00		8 9 M16 x 1.5 2.0 TDCi 01/00- 2.0 TDDi 08/00-09/06 2.3i 16v. DOHC 01/00- 2.4 TDCi 08/04-09/06 2.4 TDDi 03/00-09/06
	Barre stabilisatrice <i>Stabilizer bar</i> <i>Barra estabilizadora</i> <i>Drażek stabilizatora</i> стабилизатор поперечной устойчивости		
9005067 OE 6150971	Biellette barre stab. G <i>Left stabilizer bar stub axle</i>	9005066 OE 6150970	Biellette barre stab. D <i>Right stabilizer bar stub axle</i>
	2 1.6 01/86-10/94 2.0 01/86-10/94 2.0i 01/92-08/00 2.5 D 01/86-08/00 2.5 Di /VP 10/94-08/00 2.5 TD 01/92-08/00		2 1.6 01/86-10/94 2.0 01/86-10/94 2.0i 01/92-08/00 2.5 D 01/86-08/00 2.5 Di /VP 10/94-08/00 2.5 TD 01/92-08/00
2306028 OE 4519467	Biellette barre stab. <i>Stabilizer bar stub axle</i>	2306032 OE 3736028	Biellette barre stab. <i>Stabilizer bar stub axle</i>
	2 2.0 TDCi BVM 10/01-09/06 2.0 TDDi BVM 08/00-09/06 2.2 TDCi BVM 09/06- 2.3i 16v. 08/00- 2.4 TDCi BVM 02/04- 2.4 TDDi 03/00-09/06		2 2.0 TDCi BVM 04/02-09/06 2.0 TDDi BVM 08/00-09/06

... Transit ...

SASIC

FORD



Barre stabilisatrice
Stabilizer bar
Barra estabilizadora
Drażek stabilizatora
 стабилизатор поперечной устойчивости

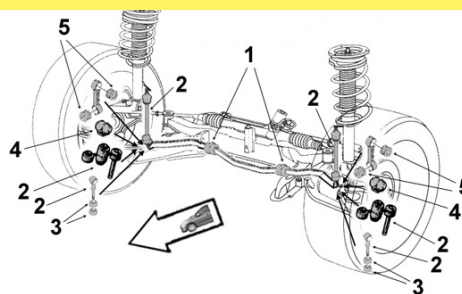

9001602

Palier de barre milieu

OE 6521811

Middle bar main bearing



1 Barre Ø 18

2.0i	01/92-08/00
2.5 D	01/92-08/00
2.5 Di	10/94-08/00
2.5 TD	01/92-08/00

9001603

Palier de barre milieu

OE 6521812

Middle bar main bearing



1 Barre Ø 20

2.0i	01/92-08/00
2.5 D	01/92-08/00
2.5 TD	01/92-08/00



Eléments SUSPENSION

Suspension parts
Elementos suspensión
Elementy zawieszenie
 Элементы подвески

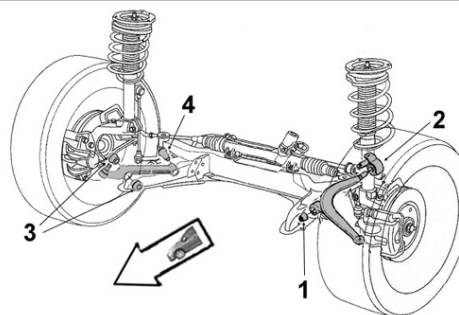

9001772

Articulation AR

OE 6517356

Rear bush



2 Ø int.16 Ø ext.41 coll.45 long. tube int.96 ext.60 ep. coll.11

2.0i	01/92-10/94
2.5 D	01/92-08/00
2.5 TD	01/92-08/00

2256049

Articulation AR

OE 4540787

Rear bush



2 Ø int.16.5 Ø ext.66 long. tube int.72 ext. 40

2.0 TDCi VU	FIFA	04/02-09/06
2.0 TDDi VU	ABFA D3FA F3FA	08/00-09/06
2.2 TDCi VU	P8FA P8FB QVFA QWFA	09/06-
2.4 TDCi VU	H9FB JXFA PHFA	09/06-

9001745

Articulation AV

OE 6608818

Front bush











1 Ø int.16 Ø ext.52 coll.60 x2 long. tube int.52 ext.27 ep. coll.4

2.0	01/92-08/00
2.5 D	01/92-08/00
2.5 TD	01/92-08/00

... Transit ...

FORD



9002461 Articulation AV OE 4131788 <i>Front bush</i>			
	1 Ø int.14 Ø ext.37 coll.44 long. tube int.67 ext.39 ep. coll.6 2.0 TDCi VU FIFA 2.0 TDDi VU ABFA D3FA F3FA 2.2 TDCi VU P8FA P8FB QVFA QWFA 2.4 TDCi VU H9FB JXFA PHFA 04/02-09/06 08/00-09/06 09/06- 09/06-		
9005821 Triangle de susp. G OE 6608832 <i>Left track control arm</i>		9005820 Triangle de susp. D OE 6608830 <i>Right track control arm</i>	
	4 Sans rotule Without ball joint TT /all models 01/92-12/95 2.0 01/95-08/00 2.5 Di 01/95-08/00 2.5 TD BVM BVA 01/95-08/00		3 Sans rotule Without ball joint TT /all models 01/92-12/95 2.0 01/95-08/00 2.5 Di 01/95-08/00 2.5 TD BVM BVA 01/95-08/00
9005817 Triangle de susp. G OE 1735890 <i>Left track control arm</i>		9005816 Triangle de susp. D OE 1735889 <i>Right track control arm</i>	
	4 Sans rotule Without ball joint 2.0 TDCi 01/00- 2.0 TDDi 08/00-09/06 2.2 TDCi 09/06-28/12/13 2.3i 16v. DOHC 01/00- 2.4 TDCi 08/04-28/12/13 2.4 TDDi 01/00-		3 Sans rotule Without ball joint 2.0 TDCi 01/00- 2.0 TDDi 08/00-09/06 2.2 TDCi 09/06-28/12/13 2.3i 16v. DOHC 01/00- 2.4 TDCi 08/04-28/12/13 2.4 TDDi 01/00-
9005244 Rotule de susp. inf. G/D OE 5021430 <i>L/R lower suspension ball joint</i>		9005246 Rotule de susp. inf. G/D OE 6650261 <i>L/R lower suspension ball joint</i>	
	1 2 TT /all models 10/85-01/92		1 2 TT /all models 01/92-12/99
9005526 Rotule de susp. inf. G/D OE 1451914 <i>L/R lower suspension ball joint</i>			
	1 2 2.0 TDCi 01/00-09/06 2.0 TDDi 08/00-09/06 2.2 TDCi 09/06- 2.3i 16v. DOHC 01/00-09/06 2.4 TDCi 100hp 74kw 115hp 85kw 140hp 103kw 09/06- 2.4 TDDi 75hp 55kw 90hp 66kw 120hp 88kw 125hp 92kw 01/00-09/06		

... Transit ...

SASIC

FORD



Support d'amortisseur

Suspension mounting
Soporte amortiguador
Poduszka amortyzatora
Опора амортизатора

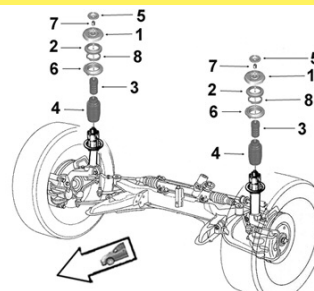

9001455

OE 6763456

Support suspension G/D

L/R suspension mounting



1

2.0		01/92-10/94
2.0i		01/92-08/00
2.5 D		01/92-10/94
2.5 Di		10/94-08/00
2.5 TD	BVM BVA	01/92-08/00

9005649

OE 4094280

Support suspension G/D

L/R suspension mounting

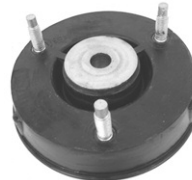

1

2.0 TDCi	08/00-
2.0 TDDi	08/00-09/06
2.3i 16v.	08/00-
2.4 TDCi	08/00-

2656031

OE 1377929

Butée à billes G/D

L/R ball bearing



2

2.2 TDCi	09/06-
2.4 TDCi	09/06-



Barre stabilisatrice

Stabilizer bar
Barra estabilizadora
Drażek stabilizatora
стабилизатор поперечной устойчивости

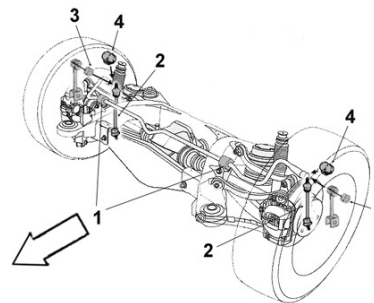

2306137

OE 4440885

Biellette barre stab.

Stabilizer bar stub axle

NEW



2

2.0 TDCi		08/02-05/06
2.0 TDDi		06/01-11/03
	06/01-11/03	2.3i 16v.
2.4 TDCi		03/04-05/06
2.4 TDDi		06/01-11/03

9003125

OE 4041490

Palier de barre milieu

Middle bar main bearing



1 Ø29

2.3i 16v.	08/00-
2.4 TDCi	08/00-
2.4 TDDi	

... Transit



Support d'amortisseur
Suspension mounting
Soporte amortiguador
Poduszka amortyzatora
Опора амортизатора

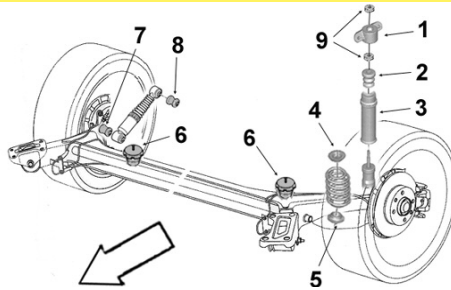

9003112

Articulation amortisseur

OE 6562752

Shock absorber bush



7 Ø int.12 Ø ext.44.5 long. tube int.39.5 ext.28

2.0
 2.0i
 2.5 D
 2.5 TD

BVM BVA

01/92-10/94
 01/92-08/00
 01/92-08/00
 01/92-08/00

Eléments TRAIN ARRIERE

Rear axle parts
Tren TRAS
Elementy zawieszenia tylnego
элементы задней оси.



9003126

Articulation lame

OE 4055743

Leaf bush



Ø int.16 Ø ext.57 long. tube int.72 ext.60.5

2.0 TDCi
 2.3i 16v.
 2.4 TDCi

08/00-
 08/00-
 08/00-

Transit Connect ...

Eléments DIRECTION

Steering parts
Elementos Direcciones
Elementy układ kierowniczy
Элементы рулевой системы

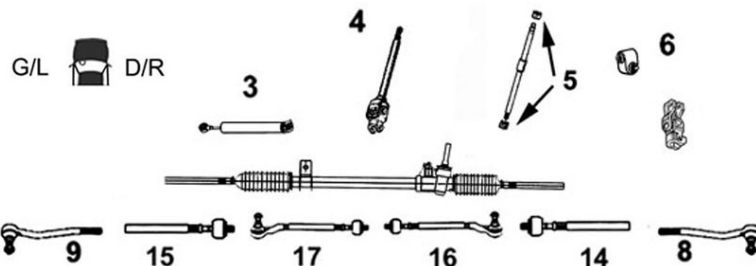

9006232

Axe de bielle G/D

Part/oe 1085520

L/R axial joint



14 Côté dir. M14x1.5
15 Côté rot. M14x2.0 long 340 mm

1.8i 16v. EFi 115hp 85kw
 1.8 TDCi
 1.8 TDdi

9006667

Rotule de direction G/D

OE 4381840

L/R tie rod end



8 M14 x 1.75
9

1.8i 16v. EFi 115hp 85kw
 1.8 TDCi 90hp 66kw
 1.8 TDdi

... Transit Connect ...

SASIC

FORD



Barre stabilisatrice
 Stabilizer bar
 Barra estabilizadora
 Drażek stabilizatora
 стабилизатор поперечной устойчивости

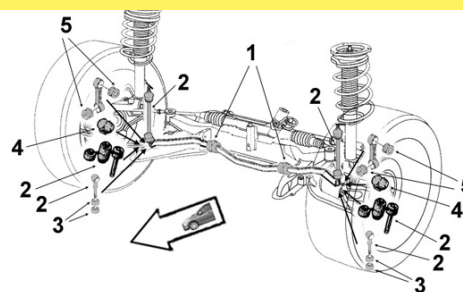

9005012 **Biellette barre stab.**
 OE 1332453 *Stabilizer bar stub axle*



2
 1.8i 16v. EFi 115hp 85kw
 1.8 TDCi 90hp 66kw
 1.8 TDDi 75hp 55kw 110hp 81kw

2306132 **Palier de barre milieu**
 OE 4419559 *Middle bar main bearing*



1 Ø 24.5
 1.8i 16v. VU 01/03-09/06
 1.8 TDCi VU 05/02-
 1.8 TDDi VU 09/02-

Bras & Triangle de suspension
 Control arm
 Brazo y triángulo
 Wahacz
 Рычаг подвески

G/L D/R

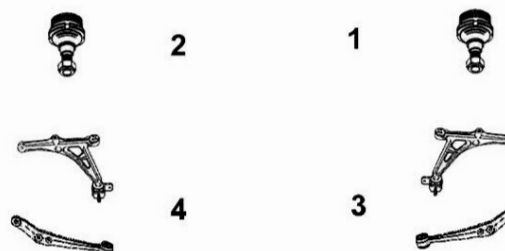

7476045 **Triangle de susp. G**
 OE 1355050 *Left track control arm*



4 **Sans rotule Without ball joint**
 1.8i 16v. 09/02-09/06
 1.8 TDCi 09/02-04/09
 1.8 TDDi 09/02-04/09

7476044 **Triangle de susp. D**
 OE 1355048 *Right track control arm*



3 **Sans rotule Without ball joint**
 1.8i 16v. 09/02-09/06
 1.8 TDCi 09/02-04/09
 1.8 TDDi 09/02-04/09

9005528 **Rotule de susp. G/D**
 OE 4386870 *L/R suspension ball joint*



1
2
 1.8i 16v. EFi 115hp 85kw
 1.8 TDCi 90hp 66kw
 1.8 TDDi



Support d'amortisseur
 Suspension mounting
 Soporte amortiguador
 Poduszka amortyzatora
 Опора амортизатора

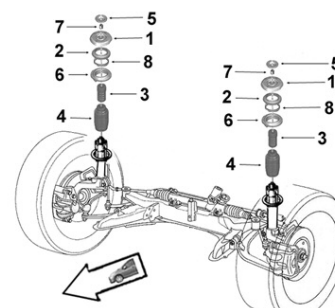

9005633 **Support suspension G/D**
 OE 1087177 *L/R suspension mounting*



1
 1.8i 16v. EFi 115hp 85kw
 1.8 TDCi 90hp 66kw
 1.8 TDDi 75hp 55kw

8005210 **Butée à billes**
 OE 1115177 *Ball bearing*



2
 1.8i 16v. EFi 115hp 85kw
 1.8 TDCi 90hp 66kw
 1.8 TDDi 75hp 55kw

...Transit Connect



Barre stabilisatrice
 Stabilizer bar
 Barra estabilizadora
 Drażek stabilizatora
 стабилизатор поперечной устойчивости

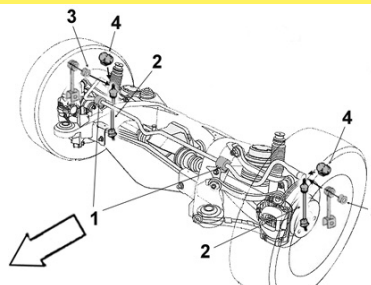

9005013 **Biellette barre stab.**
 OE 1332463 *Stabilizer bar stub axle*



2
 1.8i 16v. EFi 115hp 85kw
 1.8 TDCi 90hp 66kw
 1.8 TDDi 75hp 55kw 110hp 81kw

2306133 **Palier de barre**
 OE 4419557 *Bar main bearing*

NEW

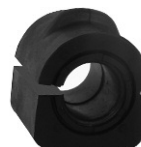

1 Ø 22
 1.8i 16v. 01/03-09/06
 1.8 TDCi 05/02-
 1.8 TDDi 09/02-

FORD



Accord

Eléments DIRECTION
 Steering parts
 Elementos Direcciones
 Elementy układ kierowniczy
 Элементы рулевой системы

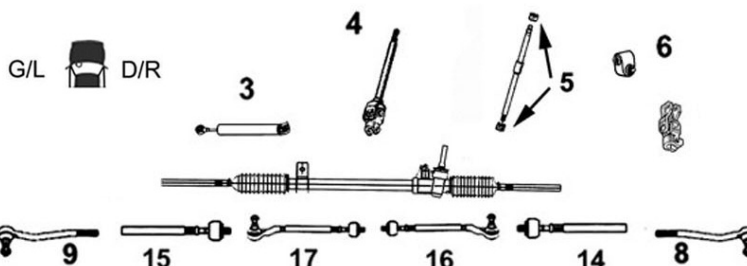

7776014 **Axe de bielle G/D**
 OE 53010S84A01 *L/R axial joint*



14 Côté dir. M16x1.5
15 Côté rot. M14x1.5 long 140 mm
 1.6i 10/98-12/02
 1.8i 10/98-12/02
 2.0i 10/98-10/02
 2.0i Coupé 07/98-04/02
 2.0 TDi 01/99-12/02
 2.2i Vtec 10/98-09/01

9006474 **Rotule de direction G/D**
 OE 53540SB2003 *L/R tie rod end*



8
9 M12 x 1.25
 TT /all models -12/90

HONDA



Civic ...

Eléments DIRECTION
 Steering parts
 Elementos Direcciones
 Elementy układ kierowniczy
 Элементы рулевой системы

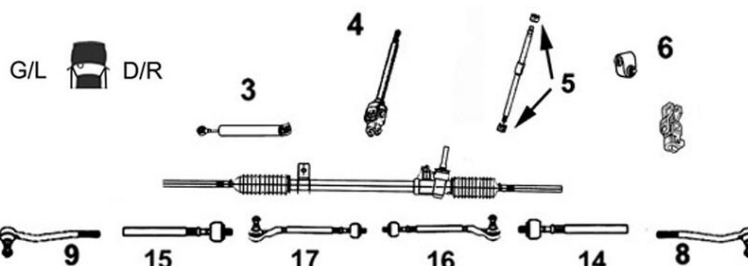

7776109 **Axe de bielle G/D**
 OE 53521S5A003 *L/R axial joint*



14 Côté dir. M14x1.25
15 Côté rot. M14x1.5 long 500 mm
 1.3i 01/04-09/05
 1.4i 12/00-09/05
 1.6i /Coupé 02/01-12/05
 1.7i /Coupé 02/01-12/05
 1.7 CDTi 01/02-09/05
 2.0i 09/01-09/05

7776083 **Axe de bielle G**
 OE 53010SMGE01 *Left axial joint*

NEW



15 Côté dir. M20x1.5
 Côté rot. M14x1.5 long 210 mm
 1.3i 01/06-11/11
 1.4i 08/08-11/11
 1.8i 04/06-11/11
 2.0i 01/07-11/11
 2.2 CDTi 01/06-11/11

... Civic ...

Eléments DIRECTION
Steering parts
Elementos Direcciones
Elementy układ kierowniczy
Элементы рулевой системы

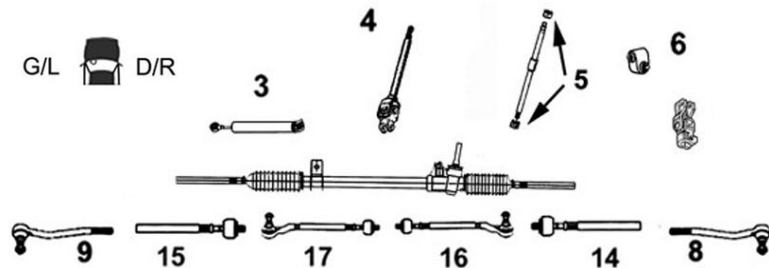

SASIC

HONDA

7776084 **Axe de bielle D**
 OE 53011SMGE01 *Right axial joint*

NEW



14 Côté dir. M20x1.5 Côté rot. M14x1.5 long 210 mm

1.3i	01/06-11/11
1.4i	08/08-11/11
1.8i	04/06-11/11
2.0i	01/07-11/11
2.2 CDTi	01/06-11/11

9006474 **Rotule de direction G/D**
 OE 53540SB2003 *L/R tie rod end*



8
9 M12 x 1.25

TT /all models -12/87

9006697 **Rotule de direction G**
 OE 53560SH3013 *Left tie rod end*



9 M14 x 1.5

TT /all models 01/88-12/91

9006695 **Rotule de direction D**
 OE 53540SH3013 *Right tie rod end*



8 M14 x 1.5

TT /all models 01/88-12/91

7676074 **Rotule de direction G/D**
 OE 53541S5A003 *L/R tie rod end*

NEW



8
9 M14 x 1.5

1.3i	01/04-09/05
1.4i	12/00-09/05
1.6i 16v.	02/01-12/05
1.7i	02/01-12/05
1.7 CDTi	01/02-09/05
1.8i	02/01-09/05
2.0i 16v.	09/01-09/05

7676071 **Rotule de direction G**
 OE 53560SMG003 *Left tie rod end*

NEW



9 M14 x 1.5

1.3i	04/06-11/11
1.4i	08/08-11/11
1.8i Vtec	01/06-11/11

7676070 **Rotule de direction D**
 OE 53540SMG003 *Right tie rod end*

NEW



8 M14 x 1.5

1.3i	04/06-11/11
1.4i	08/08-11/11
1.8i Vtec	01/06-11/11

... Civic

Bras & Triangle de suspension

Control arm
Brazo y triángulo
Wahacz
Рычаг подвески

G/L  D/R

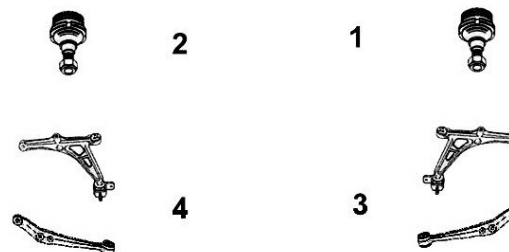

7476211

Triangle de susp. G

OE 51360S6DG00

Left track control arm

NEW

4 Sans rotule Without tie rod end



1.4i 16v.
1.6i 16v. Vtec

03/01-12/05
03/01-12/05

7476210

Triangle de susp. D

OE 51350S6DG00

Right track control arm

NEW

3 Sans rotule Without tie rod end



1.4i 16v.
1.6i 16v. Vtec

03/01-12/05
03/01-12/05

HONDA



CR-V

Eléments DIRECTION

Steering parts
Elementos Direcciones
Elementy układ kierowniczy
Элементы рулевой системы

G/L  D/R

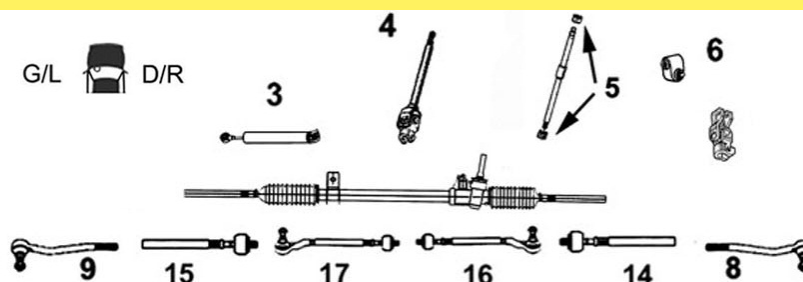

7676074

Rotule de direction G/D

OE 53541S5A003

L/R tie rod end

NEW

8
9 M14 x 1.5



2.0i 16v.
2.2 CDTi

07/02-09/06
02/05-09/06

Insight ...

Eléments DIRECTION

Steering parts
Elementos Direcciones
Elementy układ kierowniczy
Элементы рулевой системы

G/L  D/R

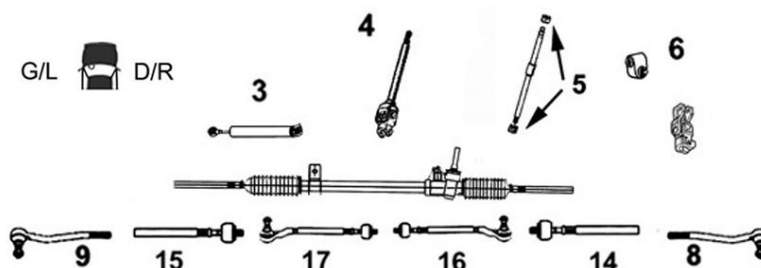

7776102

Axe de bielle G/D

OE 53010TF0003

L/R axial joint

NEW

14
15 Côté dir. M18x1.5 Côté rot. M14x1.5 long 235 mm



1.3 Hybrid

04/09-

... Insight

Eléments DIRECTION
 Steering parts
 Elementos Direcciones
 Elementy układ kierowniczy
 Элементы рулевой системы

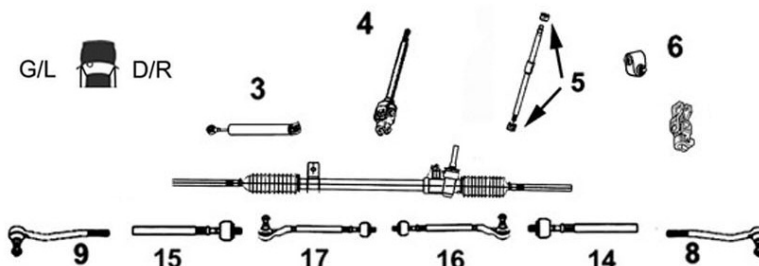

7676103 Rotule de direction G
 OE 53560TF0003 Left tie rod end

NEW



9 M14 x 1.5
 1.3 Hybrid 04/09-

7676102 Rotule de direction D
 OE 53540TF0003 Right tie rod end

NEW



8 M14 x 1.5
 1.3 Hybrid 04/09-

Jazz ...

Eléments DIRECTION
 Steering parts
 Elementos Direcciones
 Elementy układ kierowniczy
 Элементы рулевой системы

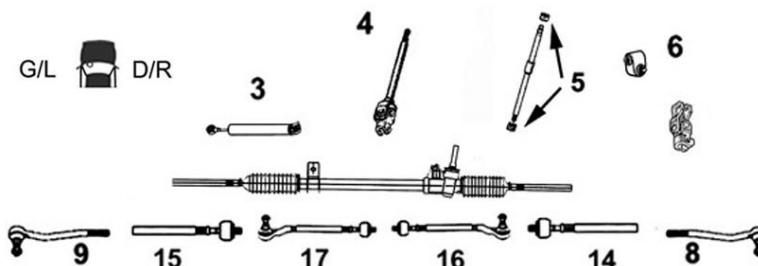

7776111 Axe de bielle G
 OE 53011SAAJ01 Left axial joint

NEW



15
 1.2i 01/02-11/08
 1.4i 04/02-11/08

7776110 Axe de bielle D
 OE 53010SAAJ01 Right axial joint

NEW



14 Côté dir. M16x1.0
 Côté rot. M12x1.25 long 217 mm
 1.2i 01/02-11/08
 1.4i 04/02-11/08

7776102 Axe de bielle G/D
 OE 53010TF0003 L/R axial joint

NEW



14
15 Côté dir. M18x1.5 Côté rot. M14x1.5 long 235 mm
 1.2i 07/08-
 1.3i 07/08-
 1.3 Hybrid 04/11-

7676072 Rotule de direction G
 OE 53560SAA003 Left tie rod end

NEW



9 M12 x 1.25
 1.2i 04/02-07/08
 1.4i 04/02-07/08

7676073 Rotule de direction D
 OE 53540SAA003 Right tie rod end

NEW











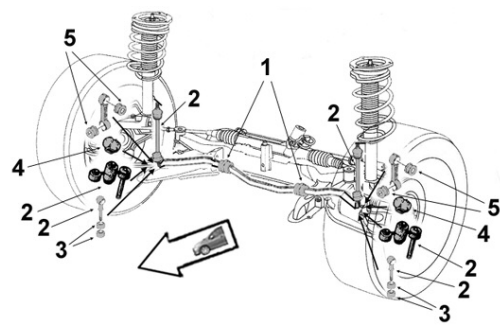

8 M12 x 1.25
 1.2i 04/02-07/08
 1.4i 04/02-07/08

... Jazz

HONDA



7676103		Rotule de direction G <i>Left tie rod end</i>		7676102		Rotule de direction D <i>Right tie rod end</i>	
OE 53560TF0003		<i>Left tie rod end</i>		OE 53540TF0003		<i>Right tie rod end</i>	
NEW	9	M14 x 1.5		NEW	8	M14 x 1.5	
		1.2i	07/08-			1.2i	07/08-
		1.3i	07/08-			1.3i	07/08-
		1.3 Hybrid	04/11-			1.3 Hybrid	04/11-
 <p>Barre stabilisatrice Stabilizer bar Barra estabilizadora Drażek stabilizatora стабилизатор поперечной устойчивости</p>							
2306072		Biellette barre stab. G <i>Left stabilizer bar stub axle</i>		2306068		Biellette barre stab. D <i>Right stabilizer bar stub axle</i>	
OE 51321SAA003		<i>Left stabilizer bar stub axle</i>		OE 51320SAA003		<i>Right stabilizer bar stub axle</i>	
	2				2		
		1.2i	01/02-			1.2i	01/02-
		1.4i	01/02-			1.4i	01/02-
<p>Bras & Triangle de suspension Control arm Brazo y triángulo Wahacz Рычаг подвески</p>				<p style="text-align: center;">G/L  D/R</p> <div style="display: flex; justify-content: space-around;"> <div style="text-align: center;">  <p>2 4</p> </div> <div style="text-align: center;">  <p>1 3</p> </div> </div>			
7476169		Triangle de susp. G <i>Left track control arm</i>		7476168		Triangle de susp. D <i>Right track control arm</i>	
OE 51350SAAJ01		<i>Left track control arm</i>		OE 51350SAAE11		<i>Right track control arm</i>	
NEW	4	Avec rotule With ball joint		NEW	3	Avec rotule With ball joint	
		1.2i	L12A1 /4 BVM 01/02-11/08			1.2i	L12A1 /4 BVM 01/02-11/08
		1.4i	L13A1 /6 BVM BV Séq. 04/02-11/08			1.4i	L13A1 /6 BVM BV Séq. 04/02-11/08

Accent

Eléments DIRECTION

Steering parts

Elementos Direcciones

Elementy układ kierowniczy

Элементы рулевой системы

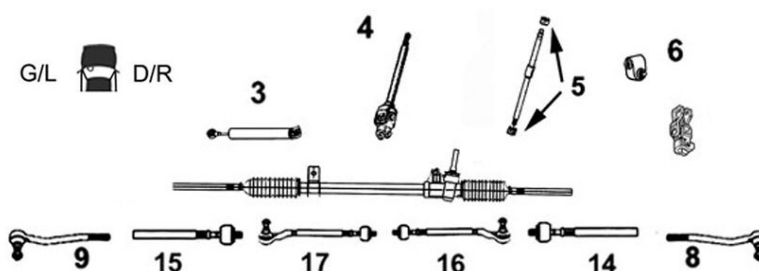
**7676081****Rotule de direction G**

OE 568201E000

Left tie rod end

NEW

**9 M14 x 1.5**

1.3i 12v.
1.4i /16v.
1.5i
1.5 CRDi
1.6i /16v.
1.6 CRDi FAP

01/09/05-28/02/12
01/09/05-28/02/12
01/09/05-28/02/12
01/09/05-28/02/12
01/09/05-28/02/12
01/09/05-28/02/12

7676082**Rotule de direction D**

OE 568201E900

Right tie rod end

NEW

**8 M14 x 1.5**

1.3i 12v.
1.4i /16v.
1.5i
1.5 CRDi
1.6i /16v.
1.6 CRDi FAP

01/09/05-28/02/12
01/09/05-28/02/12
01/09/05-28/02/12
01/09/05-28/02/12
01/09/05-28/02/12
01/09/05-28/02/12

Bras & Triangle de suspension

Control arm

Brazo y triángulo

Wahacz

Рычаг подвески

G/L D/R

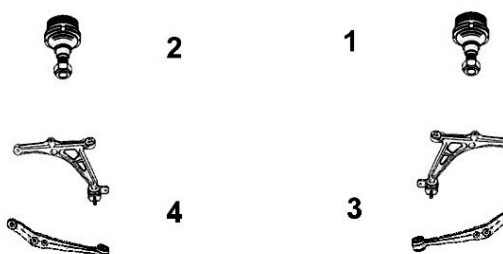
**7476157****Triangle de susp. G**

OE 5450025000

Left track control arm

NEW

**4 Avec rotule With ball joint**

1.3i 12v. G4EA 11/99-12/05
1.5i G4EB 11/99-09/01
1.5 CRDi D3EA 06/01-12/05

7476155**Triangle de susp. D**

OE 5450125000

Right track control arm

NEW

**3 Avec rotule With ball joint**

1.3i 12v. G4EA 11/99-12/05
1.5i G4EB 11/99-09/01
1.5 CRDi D3EA 06/01-12/05

7476059**Triangle de susp. G**

OE 545001E000

Left track control arm

**4 Sans rotule Without ball joint
Pour DA**

1.4i G4EE 06/10-03/12
1.4i 16v. G4EE 01/06-03/12
1.5 CRDi D4FA 01/06-03/12
1.6i 16v. G4ED 01/06-03/12

7476058**Triangle de susp. D**

OE 545011E000

Right track control arm

**3 Sans rotule Without ball joint
Pour DA**

1.4i G4EE 06/10-03/12
1.4i 16v. G4EE 01/06-03/12
1.5 CRDi D4FA 01/06-03/12
1.6i 16v. G4ED 01/06-03/12

7576031**Rotule de susp. inf. G/D**

OE 5453025000

L/R lower suspension ball joint

NEW

**1/2**

TT /all models

10/99-12/05

Coupé



Support d'amortisseur
Suspension mounting
Soporte amortiguador
Poduszka amortyzatora
Опора амортизатора

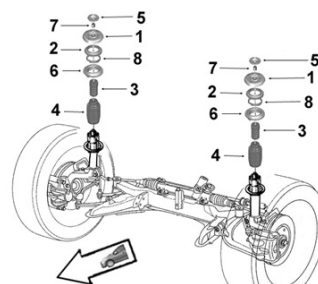

0355275

Butée à billes G/D

OE 546122C000

L/R ball bearing



2

1.6i 16v.
2.0i 16v.
2.7i

03/02-
08/01-
03/02-

Getz ...



Barre stabilisatrice
Stabilizer bar
Barra estabilizadora
Drażek stabilizatora
стабилизатор поперечной устойчивости

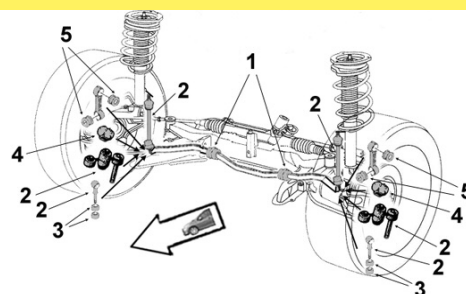

2306128

Biellette barre stab. G

OE 548301C000

Left stabilizer bar stub axle



2

1.1i G4HD/HG BVM5
09/02-12/06
1.3i 12v. G4EA BVM5 BVA4
09/02-11/05
1.4i G4EE BVM5 BVA4
11/05-12/06
1.5 CRDi D3EA D4FA BVM5
10/03-12/06

2306127

Biellette barre stab. D

OE 548401C000

Right stabilizer bar stub axle



2

1.1i G4HD/HG BVM5
09/02-12/06
1.3i 12v. G4EA BVM5 BVA4
09/02-11/05
1.4i G4EE BVM5 BVA4
11/05-12/06
1.5 CRDi D3EA D4FA BVM5
10/03-12/06

Bras & Triangle de suspension

Control arm
Brazo y triángulo
Wahacz
Рычаг подвески

G/L  D/R

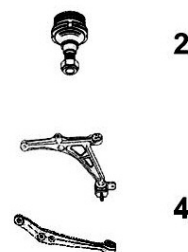

2

4

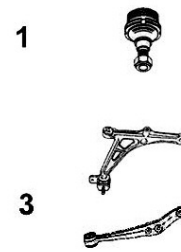

1

3

7476175

Triangle de susp. G

OE 545001C010

Left track control arm

NEW



4

Avec rotule With ball joint

1.1i G4HD /G 09/02-10/10
1.3i 12v. G4EA 09/02-11/05
1.4i G4EE 11/05-10/10
1.5 CRDi D3EA D4FA
10/03-10/10

7476174

Triangle de susp. D

OE 545011C010

Right track control arm

NEW



3

Avec rotule With ball joint

1.1i G4HD /G 09/02-10/10
1.3i 12v. G4EA 09/02-11/05
1.4i G4EE 11/05-10/10
1.5 CRDi D3EA D4FA
10/03-10/10

... Getz

Bras & Triangle de suspension

Control arm
Brazo y triángulo
Wahacz
Рычаг подвески

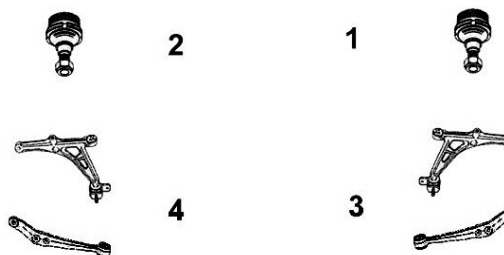
G/L  D/R**7576031****Rotule de susp. inf. G/D**

OE 5453025000

L/R lower suspension ball joint

NEW

1
2

TT /all models

09/02-

**Support d'amortisseur**

Suspension mounting
Soporte amortiguador
Poduszka amortyzatora
Опора амортизатора

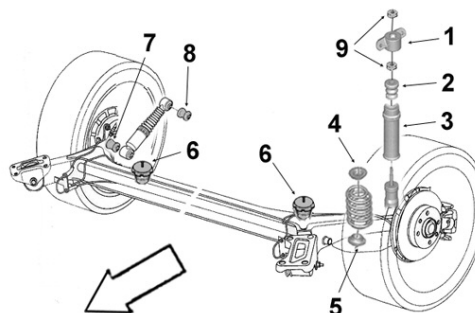
**2656067****Butée de suspension**

OE 553261C000

Shock bush

NEW



2 H125

1.1i
1.3i
1.4i
1.5 CRDi
1.6i

09/02-10/10
09/02-10/03
11/05-10/10
10/03-10/10
09/02-10/10

I 10 ...

Eléments DIRECTION

Steering parts
Elementos Direcciones
Elementy układ kierowniczy
Элементы рулевой системы

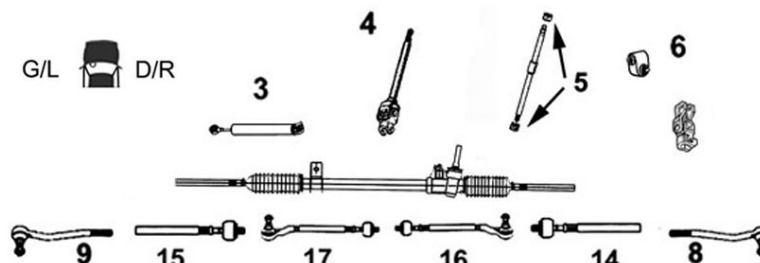
G/L  D/R**7776108****Axe de bielle G/D**

OE 577240X010

L/R axial joint

NEW



14 Côté dir. M16x1.5
15 Côté rot. M12x1.25 long 295 mm

1.0i 01/11-
1.1i 12/09/08-
1.1 CRDi 12/09/10-
1.2i 12/09/08-

7676075**Rotule de direction G/D**

OE 568200X900

L/R tie rod end

NEW



8
9 M12 x 1.25

1.1i 12/07-12/10
1.1 CRDi 12/07-12/10
1.2i 12/07-12/10

... I 10

Bras & Triangle de suspension

Control arm
Brazo y triángulo
Wahacz
Рычаг подвески

G/L  D/R

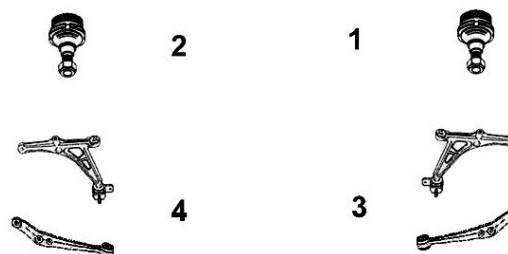

7576034

Rotule de susp. inf. G/D

OE 5453007000

L/R lower suspension ball joint

NEW



1
2 Ø 16

1.1i
1.1 CRDi
1.2i

19/12/07-02/11/10
19/12/07-02/11/10
19/12/07-02/11/10

I 20 ...

Eléments DIRECTION

Steering parts
Elementos Direcciones
Elementy układ kierowniczy
Элементы рулевой системы

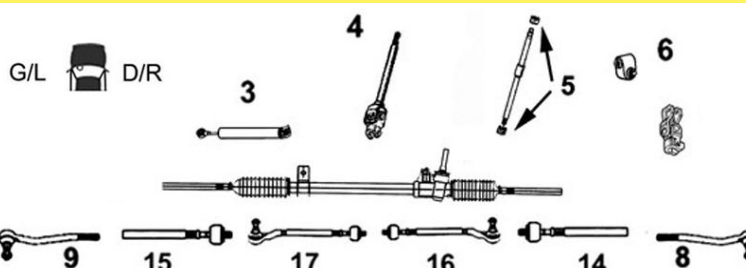

7776085

Axe de bielle G/D

OE 577241J000

L/R axial joint

NEW



14 Côté dir. M16x1.5 Côté rot. M16x1.5 long 224 mm
15

1.2i
1.4i
1.4 CRDi
1.6i
1.6 CRDi

10/08-26/04/12
10/08-26/04/12
10/08-26/04/12
10/08-26/04/12
10/08-26/04/12

7676109

Rotule de direction G

OE 568202K000

Left tie rod end

NEW



9 M16 x 1.5

1.2i 04/09-
1.4i 06/12-
1.4 CRDi /FAP 04/09-
2.0 CRDi FAP 06/12-

7676108

Rotule de direction D

OE 568202K050

Right tie rod end

NEW



8 M16 x 1.5

1.2i 04/09-
1.4i 06/12-
1.4 CRDi /FAP 04/09-
2.0 CRDi FAP 06/12-

... I 20

Bras & Triangle de suspension

Control arm
Brazo y triángulo
Wahacz
Рычаг подвески

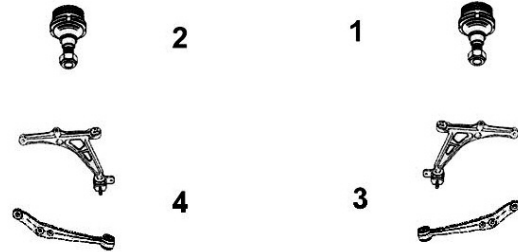
G/L  D/R**7576031****Rotule de susp. inf. G/D**

OE 5453025000

L/R lower suspension ball joint

NEW

1
2

1.2i /GPL
1.4i
1.4 CRDi /FAP
1.6i
1.6 CRDi

04/09-03/12
04/09-03/12
04/09-03/12
04/09-03/12
04/09-03/12

I 30 ...

Eléments DIRECTION

Steering parts
Elementos Direcciones
Elementy układ kierowniczy
Элементы рулевой системы

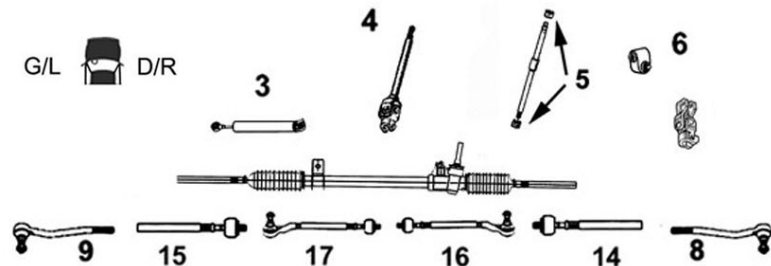
G/L  D/R**7776027****Axe de bielle G/D**

OE 565402H000

L/R axial joint

14
15

Côté dir. M16x1.5 Côté rot. M14x1.5 long 162 mm

1.4i /Break
1.6i /Break
1.6 CRDi /Break
2.0 /Break
2.0 CRDi /Break

07/07-
07/07-
07/07-
07/07-
07/07-

7676030**Rotule de direction G**

OE 568202H000

Left tie rod end

9 M14 x 1.5



1.4i /Break 07/07-
1.6i /Break 07/07-
1.6 CRDi /Break 07/07-
2.0 /Break 07/07-
2.0 CRDi /Break 07/07-

7676029**Rotule de direction D**

OE 568202H090

Right tie rod end

8 M14 x 1.5



1.4i /Break 07/07-
1.6i /Break 07/07-
1.6 CRDi /Break 07/07-
2.0 /Break 07/07-
2.0 CRDi /Break 07/07-



Barre stabilisatrice
 Stabilizer bar
 Barra estabilizadora
 Drażek stabilizatora
 стабилизатор поперечной устойчивости

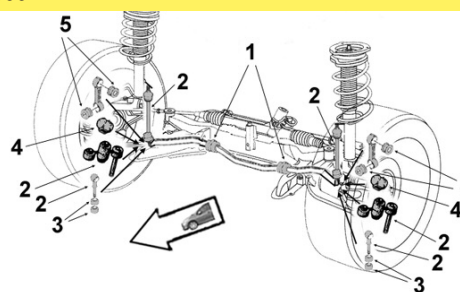

2306119 **Biellette barre stab.**
 OE 548302H200 *Stabilizer bar stub axle*



2

1.4i Berline	G4FA	BVM5	07/07-05/12
1.6 CRDi	D4FB		07/07-05/12
2.0 CRDi Berline	D4EA	BVM6	07/07-12/10

Bras & Triangle de suspension

Control arm
 Brazo y triángulo
 Wahacz
 Рычаг подвески

G/L D/R

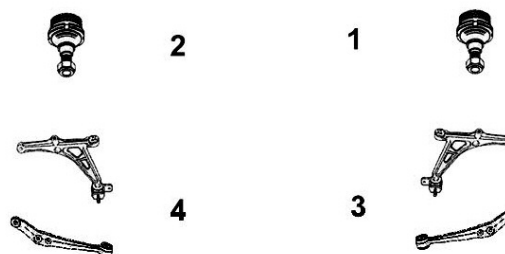

7476050 **Triangle de susp. G**
 OE 545002H000 *Left track control arm*



4

Sans rotule Without ball joint

1.4i /Break	07/07-
1.6i /Break	07/07-
1.6 CRDi /Break	07/07-
2.0i /Break	07/07-
2.0 CRDi /Break	07/07-

7476049 **Triangle de susp. D**
 OE 545012H100 *Right track control arm*



3

Sans rotule Without ball joint

1.4i /Break	07/07-
1.6i /Break	07/07-
1.6 CRDi /Break	07/07-
2.0i /Break	07/07-
2.0 CRDi /Break	07/07-

7576009 **Rotule de susp. inf. G/D**
 OE 517600Q000 *L/R lower suspension ball joint*



1
2

1.4i /Break	07/07-
1.6i /Break	07/07-
1.6 CRDi /Break	07/07-
2.0i /Break	07/07-
2.0 CRDi /Break	07/07-

... I30



HYUNDAI



Support d'amortisseur
Suspension mounting
Soporte amortiguador
Poduszka amortyzatora
Опора амортизатора

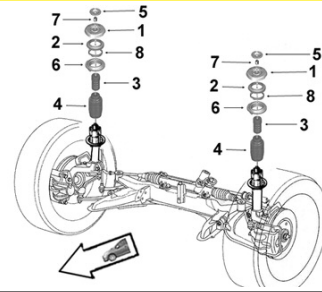

0355275

Butée à billes G/D

OE 546122C000

L/R ball bearing



2

1582 1.4i /Break
 1582 1.6 CRDi /Break
 1582 2.0 CRDi /Break

10/07-
 07/07-
 07/07-



Barre stabilisatrice
Stabilizer bar
Barra estabilizadora
Drażek stabilizatora
стабилизатор поперечной устойчивости

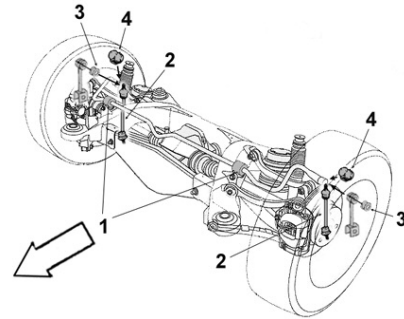

2306120

Biellette barre stab.

OE 555301H100

Stabilizer bar stub axle



2

1.4i Berline G4FA BVM5
 07/07-05/12
 1.6 CRDi D4FB 07/07-05/12
 2.0 CRDi Berline D4EA BVM6
 07/07-12/10

2306145

Biellette barre stab.

OE 555303R000

Stabilizer bar stub axle

NEW



2

1.4i /Break 26/12/11-
 1.4 CRDi /Break 26/12/11-
 1.6i Break 26/12/11-
 1.6 CRDi /Break 26/12/11-
 2.0i /Break 26/12/11-
 2.0 CRDi /Break 26/12/11-

IX 20 ...

Éléments DIRECTION
Steering parts
Elementos Direcciones
Elementy układ kierowniczy
Элементы рулевой системы

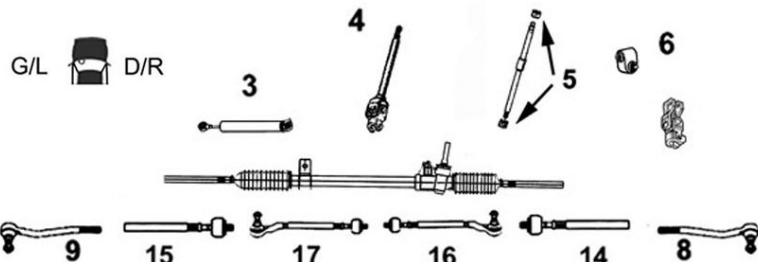

7676109

Rotule de direction G

OE 568202K000

Left tie rod end

NEW



9

M16 x 1.5

1.4i 10/10-
 1.4 CRDi 10/10-
 1.6i 10/10-

7676108

Rotule de direction D

OE 568202K050

Right tie rod end

NEW



8

M16 x 1.5

1.4i 10/10-
 1.4 CRDi 10/10-
 1.6i 10/10-

... IX 20

<p>Bras & Triangle de suspension Control arm Brazo y triángulo Wahacz Рычаг подвески</p>	<p>G/L D/R</p>	<p>7576031 OE 5453025000</p> <p>Rotule de susp. inf. G/D <i>L/R lower suspension ball joint</i></p> <p>NEW </p>	<p>1 2</p> <table style="width: 100%; border-collapse: collapse;"> <tr> <td style="width: 50%;">1.4i</td> <td style="width: 50%;">10/10-</td> </tr> <tr> <td>1.4 CRDi</td> <td>10/10-</td> </tr> <tr> <td>1.6i</td> <td>10/10-</td> </tr> <tr> <td>1.6 CRDi FAP</td> <td>10/10-</td> </tr> </table>	1.4i	10/10-	1.4 CRDi	10/10-	1.6i	10/10-	1.6 CRDi FAP	10/10-
1.4i	10/10-										
1.4 CRDi	10/10-										
1.6i	10/10-										
1.6 CRDi FAP	10/10-										

IX 35 ...

<p>Eléments DIRECTION Steering parts Elementos Direcciones Elementy układ kierowniczy Элементы рулевой системы</p>	<p>G/L D/R</p>
---	-----------------

<p>7776087 OE 577242S000</p> <p>Axe de bielle G/D <i>L/R axial joint</i></p>	<p>14 15</p> <p>Côté dir. M16x1.5 Côté rot. M16x1.5 long 182 mm</p>	<p>NEW </p> <table style="width: 100%; border-collapse: collapse;"> <tr> <td style="width: 50%;">1.6i</td> <td style="width: 50%;">09/10-</td> </tr> <tr> <td>1.7 CRDi</td> <td>09/10-</td> </tr> <tr> <td>2.0i /4WD</td> <td>09/10-</td> </tr> <tr> <td>2.0 CRDi /FAP /4WD</td> <td>09/10-</td> </tr> <tr> <td>2.4i 4WD</td> <td>09/10-</td> </tr> </table>	1.6i	09/10-	1.7 CRDi	09/10-	2.0i /4WD	09/10-	2.0 CRDi /FAP /4WD	09/10-	2.4i 4WD	09/10-
1.6i	09/10-											
1.7 CRDi	09/10-											
2.0i /4WD	09/10-											
2.0 CRDi /FAP /4WD	09/10-											
2.4i 4WD	09/10-											

<p>7676099 OE 568202S000</p> <p>Rotule de direction G <i>Left tie rod end</i></p>	<p>7676098 OE 568202S050</p> <p>Rotule de direction D <i>Right tie rod end</i></p>																				
<p>NEW </p> <p>9 M16x1.5</p> <table style="width: 100%; border-collapse: collapse;"> <tr> <td style="width: 50%;">1.6i</td> <td style="width: 50%;">07/10-08/13</td> </tr> <tr> <td>1.7 CRDi</td> <td>09/10-08/13</td> </tr> <tr> <td>2.0i /4WD</td> <td>04/10-08/13</td> </tr> <tr> <td>2.0 CRDi /4WD</td> <td>04/10-08/13</td> </tr> <tr> <td>2.4i 4WD</td> <td>04/10-08/13</td> </tr> </table>	1.6i	07/10-08/13	1.7 CRDi	09/10-08/13	2.0i /4WD	04/10-08/13	2.0 CRDi /4WD	04/10-08/13	2.4i 4WD	04/10-08/13	<p>NEW </p> <p>8 M16x1.5</p> <table style="width: 100%; border-collapse: collapse;"> <tr> <td style="width: 50%;">1.6i</td> <td style="width: 50%;">07/10-08/13</td> </tr> <tr> <td>1.7 CRDi</td> <td>09/10-08/13</td> </tr> <tr> <td>2.0i /4WD</td> <td>04/10-08/13</td> </tr> <tr> <td>2.0 CRDi /4WD</td> <td>04/10-08/13</td> </tr> <tr> <td>2.4i 4WD</td> <td>04/10-08/13</td> </tr> </table>	1.6i	07/10-08/13	1.7 CRDi	09/10-08/13	2.0i /4WD	04/10-08/13	2.0 CRDi /4WD	04/10-08/13	2.4i 4WD	04/10-08/13
1.6i	07/10-08/13																				
1.7 CRDi	09/10-08/13																				
2.0i /4WD	04/10-08/13																				
2.0 CRDi /4WD	04/10-08/13																				
2.4i 4WD	04/10-08/13																				
1.6i	07/10-08/13																				
1.7 CRDi	09/10-08/13																				
2.0i /4WD	04/10-08/13																				
2.0 CRDi /4WD	04/10-08/13																				
2.4i 4WD	04/10-08/13																				

<p>Bras & Triangle de suspension Control arm Brazo y triángulo Wahacz Рычаг подвески</p>	<p>G/L D/R</p>
---	-----------------

<p>7576032 OE 545303S000</p> <p>Rotule de susp. inf. G/D <i>L/R lower suspension ball joint</i></p>	<p>1 2</p> <p>Ø 18</p>	<p>NEW </p> <table style="width: 100%; border-collapse: collapse;"> <tr> <td style="width: 50%;">1.6i</td> <td style="width: 50%;">09/10-</td> </tr> <tr> <td>1.7 CRDi</td> <td>09/10-</td> </tr> <tr> <td>2.0i /4WD</td> <td>09/10-</td> </tr> <tr> <td>2.0 CRDi /FAP /4WD</td> <td>09/10-</td> </tr> <tr> <td>2.4i 4WD</td> <td>09/10-</td> </tr> </table>	1.6i	09/10-	1.7 CRDi	09/10-	2.0i /4WD	09/10-	2.0 CRDi /FAP /4WD	09/10-	2.4i 4WD	09/10-
1.6i	09/10-											
1.7 CRDi	09/10-											
2.0i /4WD	09/10-											
2.0 CRDi /FAP /4WD	09/10-											
2.4i 4WD	09/10-											

... IX 35



Barre stabilisatrice
 Stabilizer bar
 Barra estabilizadora
 Drażek stabilizatora
 стабилизатор поперечной устойчивости

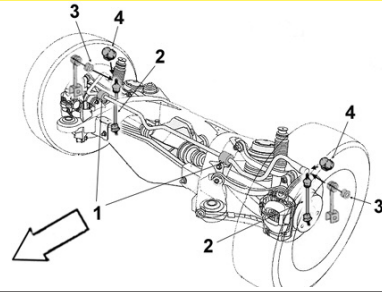

2306145

Biellette barre stab.

OE 555303R000

Stabilizer bar stub axle

NEW



2

1.6i	2WD
1.7 CRDi	2WD
2.0i	2WD
2.0 CRDi	2WD

15/04/10-31/08/13
15/04/10-31/08/13
15/04/10-31/08/13
15/04/10-31/08/13

IX 55



Barre stabilisatrice
 Stabilizer bar
 Barra estabilizadora
 Drażek stabilizatora
 стабилизатор поперечной устойчивости

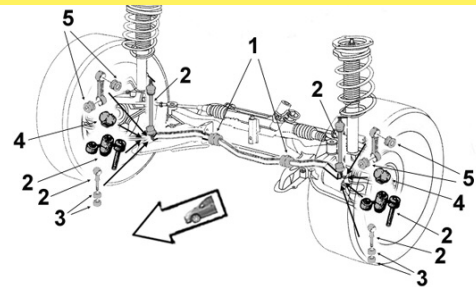

2306121

Biellette barre stab. G

OE 548302B200

Left stabilizer bar stub axle



2

3.0 CRDi	4WD	D6EA BVA6
		09/08-
3.0 CRDi FAP 4WD		D6EB BVA6
		01/12-

2306122

Biellette barre stab. D

OE 548402B200

Right stabilizer bar stub axle



2

3.0 CRDi	4WD	D6EA BVA6
		09/08-
3.0 CRDi FAP 4WD		D6EB BVA6
		01/12-



Barre stabilisatrice
 Stabilizer bar
 Barra estabilizadora
 Drażek stabilizatora
 стабилизатор поперечной устойчивости

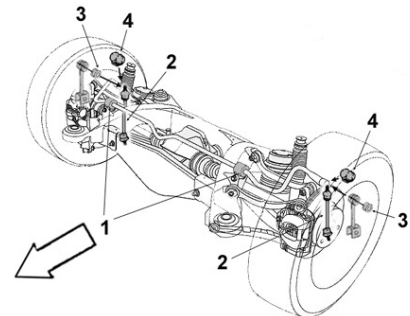

2306123

Biellette barre stab.

OE 555302B200

Stabilizer bar stub axle



2

3.0 CRDi	4WD
3.0 CRDi FAP 4WD	

D6EA	BVA6
D6EB	BVA6

09/08-
01/12-

Santa Fe



Barre stabilisatrice
 Stabilizer bar
 Barra estabilizadora
 Drażek stabilizatora
 стабилизатор поперечной устойчивости

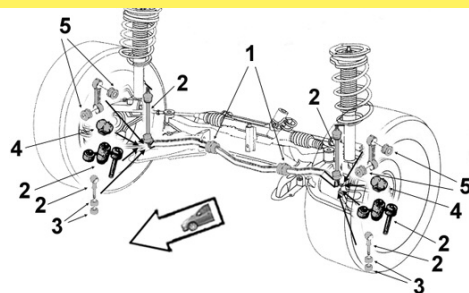

2306121

Biellette barre stab. G

OE 548302B200

Left stabilizer bar stub axle



2

2.2 CRDi FAP 4WD D4HB
 BVM6 BVA6 01/10-

2306122

Biellette barre stab. D

OE 548402B200

Right stabilizer bar stub axle



2

2.2 CRDi FAP 4WD D4HB
 BVM6 BVA6 01/10-



Barre stabilisatrice
 Stabilizer bar
 Barra estabilizadora
 Drażek stabilizatora
 стабилизатор поперечной устойчивости

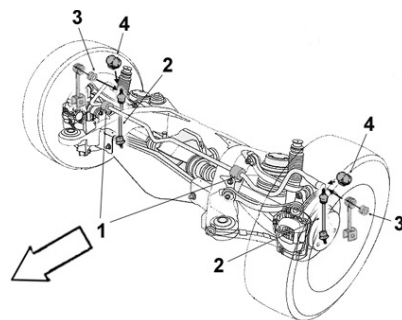

2306123

Biellette barre stab.

OE 555302B200

Stabilizer bar stub axle



2

2.2 CRDi FAP 4WD D4HB BVM6 BVA6 01/10-

Tucson ...

Eléments DIRECTION
 Steering parts
 Elementos Direcciones
 Elementy układ kierowniczy
 Элементы рулевой системы

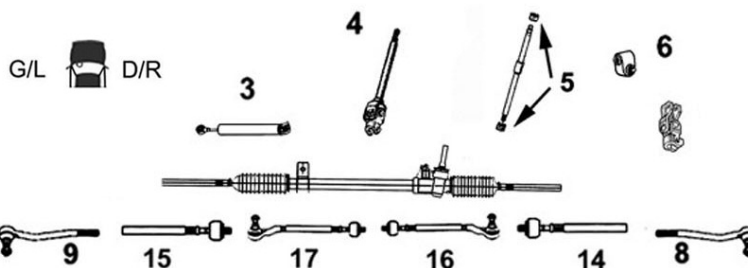

7776067

Axe de bielle G/D

OE 577242E000

L/R axial joint

NEW



14 Côté dir. M16x1.5 Côté rot. M16x1.5 long 245 mm
 15

2.0i 09/04-10/10
 2.0 CRDi /4WD 09/04-10/10
 2.7i 4WD 09/04-10/10

... Tucson ...

Eléments DIRECTION
Steering parts
Elementos Direcciones
Elementy układ kierowniczy
Элементы рулевой системы

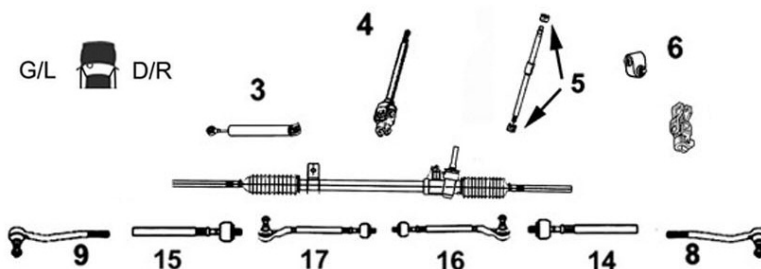

7676097 Rotule de direction G

OE 568202E000 *Left tie rod end*

NEW



9 M16x1.5

2.0i	09/04-10/10
2.0 CRDi /4WD	09/04-10/10
2.7i 4WD	09/04-10/10

7676095 Rotule de direction D

OE 568202E900 *Right tie rod end*

NEW



8 M16x1.5

2.0i	09/04-10/10
2.0 CRDi /4WD	09/04-10/10
2.7i 4WD	09/04-10/10



Barre stabilisatrice
Stabilizer bar
Barra estabilizadora
Drażek stabilizatora
стабилизатор поперечной устойчивости

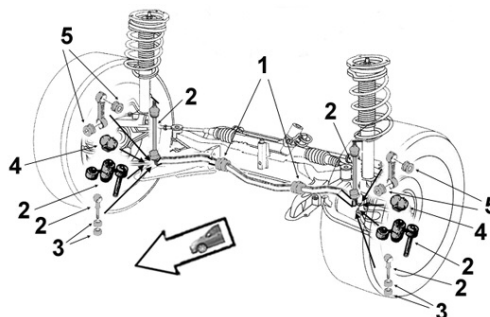

2306125 Bielle barre stab.

OE 548302E100 *Stabilizer bar stub axle*



2

2.0i	G4GC	BVM5	01/06-10/10
2.0 CRDi /4WD	D4EA		09/04-10/10

Bras & Triangle de suspension

Control arm
Brazo y triángulo
Wahacz
Рычаг подвески

G/L D/R

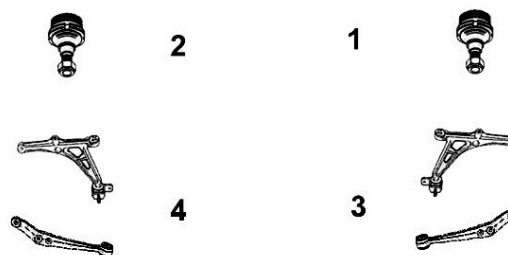

7576027 Rotule de susp. inf. G/D

OE 517602E000 *L/R lower suspension ball joint*

NEW



1
2

2.0i 141hp 104kw	G4GC	01/06-10/10
2.0 CRDi /4WD	D4EA	09/04-10/10

... Tucson

7576045	Rotule de susp. inf. G	7576044	Rotule de susp. inf. D
OE 517602E010	<i>Left lower suspension ball joint</i>	OE 517702E010	<i>Right lower suspension ball joint</i>
NEW 	2	NEW 	1
	2.0i /4WD 09/09/05-02/03/10 2.0 CRDi /4WD 31/10/06-02/03/10		2.0i /4WD 09/09/05-02/03/10 2.0 CRDi /4WD 31/10/06-02/03/10



Barre stabilisatrice
Stabilizer bar
Barra estabilizadora
Drażek stabilizatora
 стабилизатор поперечной устойчивости

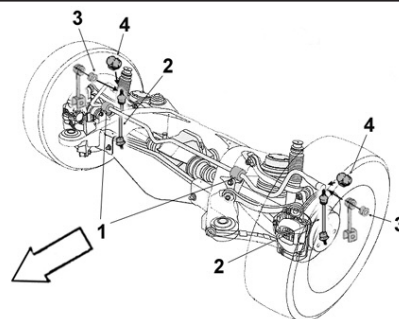



2306124	Biellette barre stab.		
OE 555302E100	<i>Stabilizer bar stub axle</i>		
	2		
	2.0i 2.0 CRDi /4WD	G4GC D4EA	BVM5 01/06-10/10 09/04-10/10

Daily I -03/96 ...

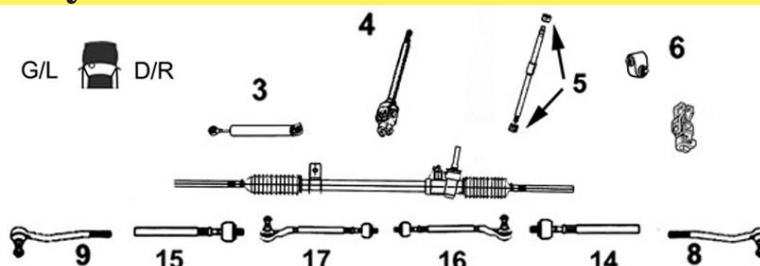
Eléments DIRECTION
Steering parts
Elementos Direcciones
Elementy układ kierowniczy
 Элементы рулевой системы



7774010	Axe de bielle G/D		
OE -	<i>L/R axial joint</i>		
NEW 	14 15	Côté dir. M16x1.5 Côté rot. M16x1.5 Long mm 222	
	TT /all models 30-8 TT /all models 35-8/10/12 TT /all models 40.10/12 TT /all models 45.10 TT /all models 49-10/12 TT /all models 59-12	8140.27S	01/78-05/92 01/78-05/92 01/78-05/92 01/78-05/92 01/78-05/92 01/78-05/92

9006343	Axe de bielle G/D		9006338	Rotule de direction G/D	
OE 9983325	<i>L/R axial joint</i>		OE 93800662	<i>L/R tie rod end</i>	
	14 15	Côté dir. M16x1.5 Côté rot. M16x1.5 long 334 mm		8 9	M16 x 1.5 2.4 D 30.8 35.8 40.8 2.4 TD 35.10 2.5 D 30.8 35.8 35.10 2.5 TD 35.10 40.10 45.10 49.10 2.5 TD 35.12 40.12 49.12 59.12
		TT /all models -05/96			

... Daily I -03/96 ...

SASIC

IVECO



Barre stabilisatrice
 Stabilizer bar
 Barra estabilizadora
 Drażek stabilizatora
 стабилизатор поперечной устойчивости

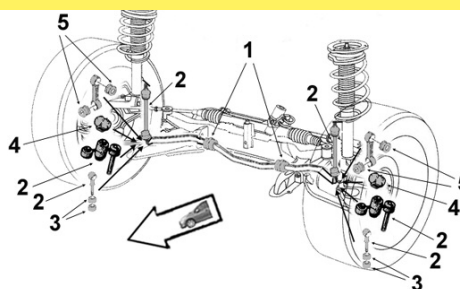

9001580

Palier de barre

OE 93802248

Bar main bearing

1 Barre Ø 22 Bar Ø22



TT /all models Turbo Daily Intercooler

Bras & Triangle de suspension

Control arm
Brazo y triángulo
Wahacz
 Рычаг подвески

G/L D/R



9005231

Rotule de susp. G/D Inf./Sup.

OE 93802242

L/R upper susp. ball joint

1
2



TT /all models -05/96

9005233

Rotule tirant chasse sup/inf G/D

OE 500310933

Ball joint L R upper lower bushing

1
2



2.4 D	30.8
2.5 D	30.8 35.8 35.10
2.5 TD	35.10/49 45.10 49.10
2.5 TD	35.12 45.12 49.12 59.12



Barre stabilisatrice
 Stabilizer bar
 Barra estabilizadora
 Drażek stabilizatora
 стабилизатор поперечной устойчивости

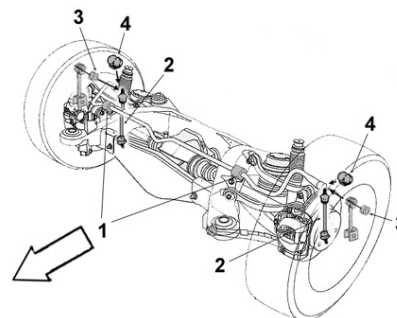

9001582

Palier de barre

OE 8581295

Bar main bearing

1 Barre Ø 26



TT /all models Turbo Daily Intercooler

9001583

Palier de barre

OE 8560291

Bar main bearing

1 Barre Ø 28



TT /all models Turbo Daily Intercooler

... Daily I -03/96

Eléments TRAIN ARRIERE

Rear axle parts

Tren TRAS

Elementy zawieszenia tylnego

элементы задней оси.



9001427

OE 93807640

Articulation inf.

Lower bush

Ø int.29 Ø ext.52 coll.62
long tube int.42 ext.32 ep. coll.8



TT /all models Turbo Daily Intercooler

Daily I 04/96-05/99 ...

Eléments DIRECTION

Steering parts

Elementos Direcciones

Elementy uklad kierowniczy

Элементы рулевой системы

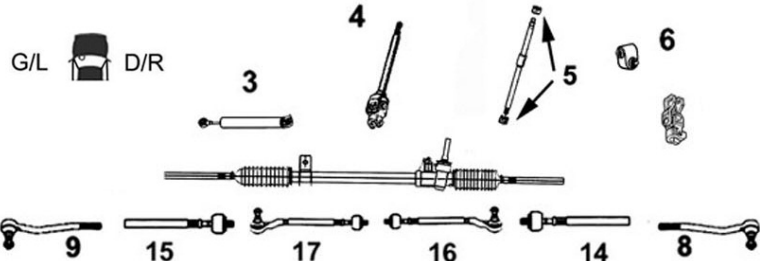

9006338

Rotule de direction G/D

OE 93800662

L/R tie rod end



8
9 M16 x 1.5

2.5 D	30.8
2.8 D	30.8 35.8
2.8 TD	30.10 35.10 40.10 45.10 49.10
2.8 TD	35.12 40.12 49.12 59.12

Bras & Triangle de suspension

Control arm

Brazo y triángulo

Wahacz

Рычаг подвески

G/L  D/R

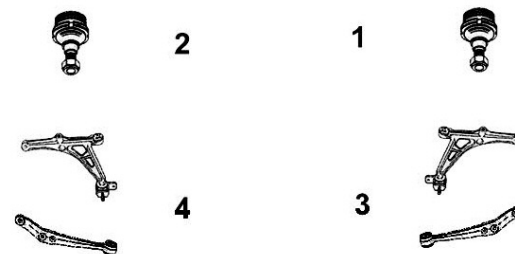

9005233

Rotule tirant chasse sup/inf G/D

OE 500310933

Ball joint L R upper lower bushing



1 M20 x 1.5 M20 x 1.5
2

2.5 D	30.8
2.5 TD	35.10
2.8 D	30.8 35.8
2.8 TD	30.10 35.10/49 45.10 49.10
	35.12 45.12 49.12 59.12

... Daily I 04/96-05/99

SASIC

IVECO



Barre stabilisatrice
 Stabilizer bar
 Barra estabilizadora
 Drążek stabilizatora
 стабилизатор поперечной устойчивости

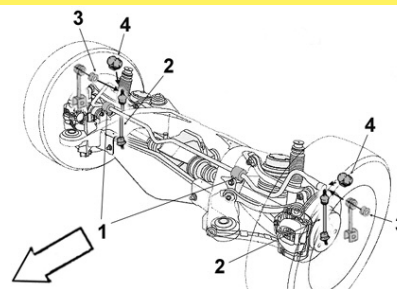

9001576 OE 93803961	Palier de barre Bar main bearing	9001577 OE 8581021	Palier de barre Bar main bearing
	1 Barre Ø 16 2.5 TD		1 Barre Ø 18 2.5 TD
9001578 OE 93802629	Palier de barre Bar main bearing	9001579 OE 93801556	Palier de barre Bar main bearing
	1 Barre Ø 20 2.5 TD		1 Barre Ø 22 2.5 TD
Eléments TRAIN ARRIERE Rear axle parts Tren TRAS Elementy zawieszenia tylnego элементы задней оси.			
		9001427 OE 93807640	Articulation inf. Lower bush
		Ø int.29 Ø ext.52 coll.62 L tube int.42 ext.32 ep. coll.8 TT /all models	

Daily II 05/99-03/06 ...

Eléments DIRECTION
 Steering parts
 Elementos Direcciones
 Elementy układ kierowniczy
 Элементы рулевой системы

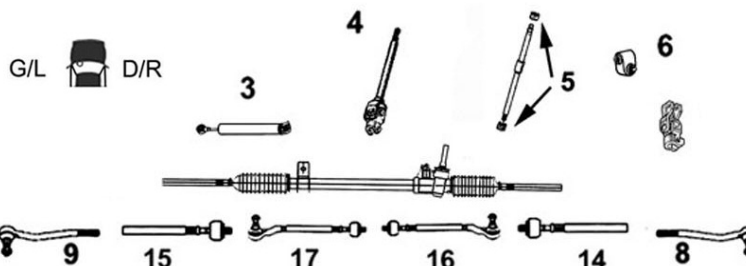

7776001 Part/oe 2992593	Axe de bielle G/D L/R axial joint		
	14 15	Côté dir. M18x1.5 Côté rot. M16x1.5 long 345 mm	
	TT /all models	29L-9/10/11/12/13/14 35S-9/10/11/12/13/15	05/99- 05/99-
	2.8 D 2.8 TD	35C-9/10/11/12/13/15 35C-9/10/11/12/13/15 50C 11/13/15 65C15	05/99- 05/99- 05/99-

... Daily II 05/99-03/06

Bras & Triangle de suspension

Control arm
Brazo y triángulo
Wahacz
Рычаг подвески

G/L  D/R

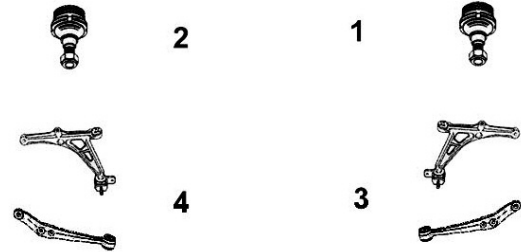

IVECO







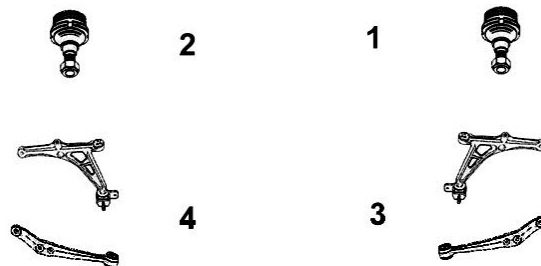

Daily III 04/06-

Bras & Triangle de suspension

Control arm
Brazo y triángulo
Wahacz
Рычаг подвески

G/L  D/R

7476222 OE 500334717	Triangle de susp. inf. G <i>Left lower track control arm</i>	7476221 OE 500334716	Triangle de susp. inf. D <i>Right lower track control arm</i>
NEW 	4 Avec rotule With ball joint TT /all models 29/35 Roue arrière simple 2900kg 3500kg	NEW 	3 Avec rotule With ball joint TT /all models 29/35 Roue arrière simple 2900kg 3500kg
7476224 OE 500379801	Triangle de susp. Sup. G <i>Upper left track control arm</i>	7476223 OE 500379802	Triangle de susp. Sup. D <i>Upper right track control arm</i>
NEW 	4 Avec rotule With ball joint TT /all models 29/35 Roue arrière simple 2900kg 3500kg	NEW 	3 Avec rotule With ball joint TT /all models 29/35 Roue arrière simple 2900kg 3500kg
7576039 Part/oe 500334716	Rotule de susp. inf. G/D <i>L/R lower suspension ball joint</i>		
NEW 	1 2 TT /all models 29/35 Roue arrière simple 2900kg 3500kg		
7576040 Part/oe 500379802	Rotule de susp. sup. G/D <i>L/R upper susp. ball joint</i>		
NEW 	1 2 TT /all models 29/35 Roue arrière simple 2900kg 3500kg		
9005233 OE 500310933	Rotule tirant chasse sup/inf G/D <i>Ball joint L R upper lower bushing</i>		
	1 M20 x 1.5 2 2.3 HPi 35C10/12 35S10/12 40C10 /12 /14 40S14 3.0 HPi 35C15 /18 /S18 40C15 /18 50C14 /15 /17 /18 65C15 /18		

Grinta

Eléments TRAIN ARRIERE

Rear axle parts

Tren TRAS

Elementy zawieszenia tylnego

элементы задней оси.



9001427

OE 93807640

Articulation inf.

Lower bush

Ø int.29 Ø ext.52 coll.62 L tube int.42
ext.32 ep. coll.8



TT /all models

Cherokee

Eléments DIRECTION

Steering parts

Elementos Direcciones

Elementy układ kierowniczy

Элементы рулевой системы

G/L D/R

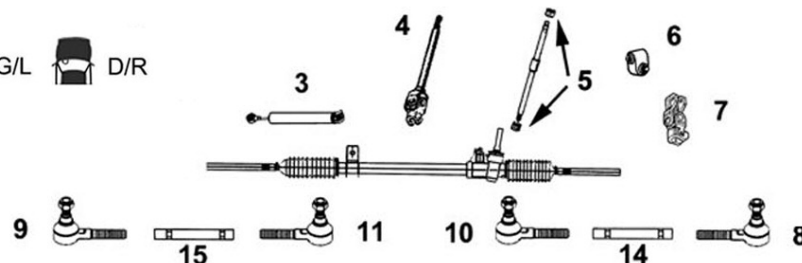

9006675

Rotule de direction G/D Int.

OE ES2222L

L/R inner tie rod end



10 M20 x 1.5
11

TT /all models

01/84-12/90

9006671

Rotule de direction G Ext.

OE ES2221L

Left outer tie rod end



9 11/16x18h

TT /all models

01/84-12/90

9006672

Rotule de direction D Ext.

OE ES2223R

Right outer tie rod end



8 11/16x18h

TT /all models

01/84-12/90

Grand Cherokee

Eléments DIRECTION

Steering parts

Elementos Direcciones

Elementy układ kierowniczy

Элементы рулевой системы

G/L D/R

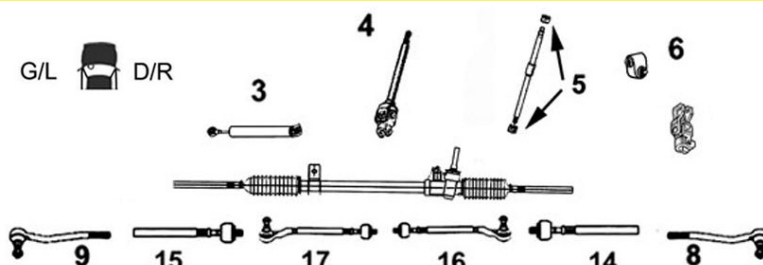

9006673

Rotule de direction G

OE ES3094L

Left tie rod end



9 11/16x18h

TT /all models Sauf 5.2l 8 cyl.

01/93-12/94

Ceed ...

Eléments DIRECTION
Steering parts
Elementos Direcciones
Elementy uklad kierowniczy
Элементы рулевой системы

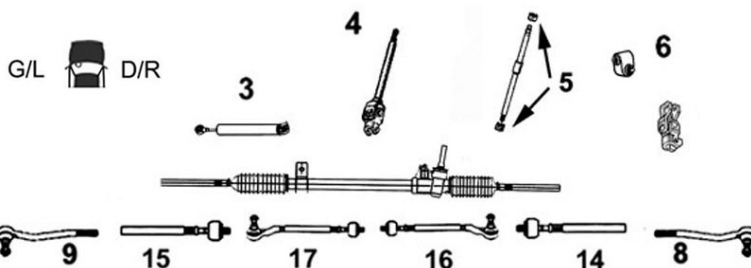

7776027 Axe de bielle G/D

OE 565402H000

L/R axial joint



14 Côté dir. M16x1.5 Côté rot. M14x1.5 long 162 mm
15

1.4i /SW	12/06-
1.6i /SW	12/06-
1.6 CRDi /SW	12/06-
2.0i /SW	12/06-
2.0 CRDi /SW	09/07-

7676030 Rotule de direction G

OE 568202H000

Left tie rod end



9 M14 x 1.5

1.4i /SW	12/06-30/08/12
1.6i /SW	12/06-30/08/12
1.6 CRDi /SW	12/06-30/08/12
2.0i /SW	12/06-30/08/12
2.0 CRDi /SW	12/06-30/08/12

7676029 Rotule de direction D

OE 568202H090

Right tie rod end



8 M14 x 1.5

1.4i /SW	12/06-30/08/12
1.6i /SW	12/06-30/08/12
1.6 CRDi /SW	12/06-30/08/12
2.0i /SW	12/06-30/08/12
2.0 CRDi /SW	12/06-30/08/12

7676111 Rotule de direction G

OE 56820A6000

Left tie rod end

NEW



9 M16 x 1.5

1.4i	09/12-
1.4 CRDi	09/12-
1.6i	09/12-
1.6 CRDi	09/12-

7676110 Rotule de direction D

OE 56820A6090

Right tie rod end

NEW



8 M16 x 1.5

1.4i	09/12-
1.4 CRDi	09/12-
1.6i	09/12-
1.6 CRDi	09/12-



Barre stabilisatrice
Stabilizer bar
Barra estabilizadora
Drażek stabilizatora
стабилизатор поперечной устойчивости

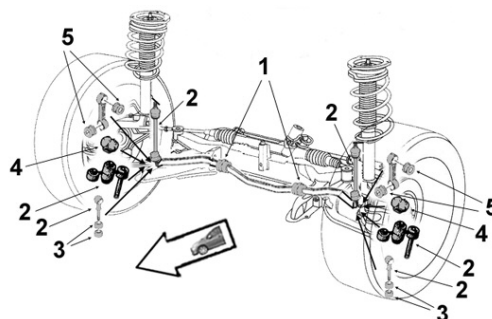

2306119 Bielle barre stab.

OE 548302H200

Stabilizer bar stub axle



2

1.4i Berline	G4FA	BVM5	01/07-05/12
1.6i /SW	G4FC	BVM5 BVA4	01/07-05/12
1.6 CRDi /SW	D4FB		01/07-05/12
2.0i Berline	G4GC	BVM5 BVA4	01/07-09/09
2.0 CRDi /SW	D4EA	BVM6	04/07-09/09

... Ceed ...

Bras & Triangle de suspension

Control arm
Brazo y triángulo
Wahacz
Рычаг подвески

G/L  D/R

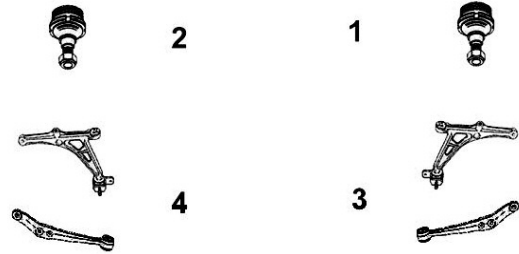

KIA

SASIC

7476050

Triangle de susp. G

OE 545002H000

Left track control arm



4 Sans rotule Without tie rod end

1.4i /SW	12/06-
1.6i /SW	12/06-
1.6 CRDi /SW	12/06-
2.0i /SW	12/06-
2.0 CRDi /SW	09/07-

7476049

Triangle de susp. D

OE 545012H100

Right track control arm



3 Sans rotule Without tie rod end

1.4i /SW	12/06-
1.6i /SW	12/06-
1.6 CRDi /SW	12/06-
2.0i /SW	12/06-
2.0 CRDi /SW	09/07-

7576009

Rotule de susp. inf. G/D

OE 517600Q000

L/R lower suspension ball joint



1/2

1.4i /SW	12/06-
1.6i /SW	12/06-
1.6 CRDi /SW	12/06-
2.0i /SW	12/06-
2.0 CRDi /SW	09/07-



Support d'amortisseur

Suspension mounting
Soporte amortiguador
Poduszka amortyzatora
Опора амортизатора

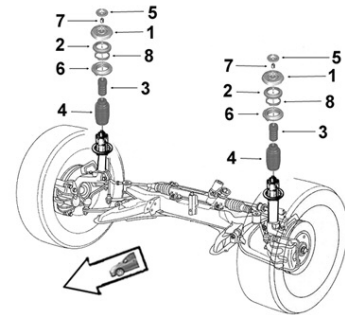

0355275

Butée à billes G/D

OE 546121G010

L/R ball bearing



2

1.4i	G4FA	BVM	01/07-09/09
1.6i /SW	G4FC		-13/07/09
1.6 CRDi /SW	D4FB	BVM	-13/07/09
2.0i	G4GC		01/07-
2.0 CRDi /SW	D4EA	BVM	04/07-09/09

... Ceed



Barre stabilisatrice
 Stabilizer bar
 Barra estabilizadora
 Drażek stabilizatora
 стабилизатор поперечной устойчивости

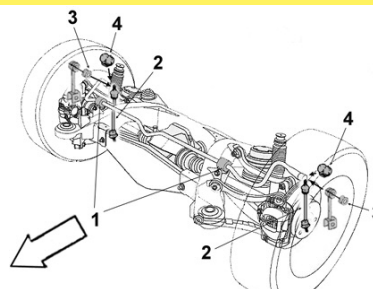

2306120

Biellette barre stab.

OE 555301H100

Stabilizer bar stub axle



2

1.4i Berline G4FA BVM5 01/07-05/12
 1.6i /SW G4FCBVM5 BVA4
 01/07-05/12
 1.6 CRDi /SW D4FB 01/07-05/12
 2.0i Berline G4GC BVM5 BVA4
 01/07-09/09
 2.0 CRDi/SW D4EA BVM6
 04/07-09/09

2306145

Biellette barre stab.

OE 555303R000

Stabilizer bar stub axle

NEW



2

1.4i 06/12-
 1.4 CRDi 06/12-
 1.6i 06/12-
 1.6 CRDi 06/12-

Picanto ...

Eléments DIRECTION
 Steering parts
 Elementos Direcciones
 Elementy układ kierowniczy
 Элементы рулевой системы

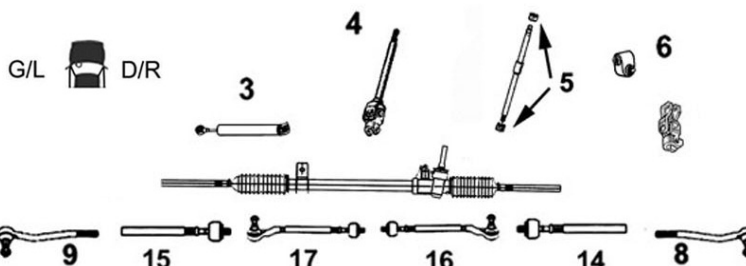

7776028

Axe de bielle G/D

OE 5772407000

L/R axial joint



14
15

Côté dir. M16x1.5 Côté rot. M12x1.25 long 290 mm

1.0i 05/04-
 1.1i 05/04-
 1.1 CRDi 11/05-

7676031

Rotule de direction G/D

OE MDX5032280

L/R tie rod end



8
9

M12x1.25

1.0i 05/04-
 1.1i 05/04-
 1.1 CRDi 11/05-

7676075

Rotule de direction G/D

OE 568200X010

L/R tie rod end



8
9

M12x1.25

1.0i 01/08-03/11
 1.1i 01/08-03/11
 1.1 CRDi 01/08-02/11

7676100

Rotule de direction G

OE 568201Y501

Left tie rod end



9

M14 x 1.5

1.0i 16/06/11-
 1.2i 16/06/11-

7676101

Rotule de direction D

OE 568201Y551

Right tie rod end



8

M14 x 1.5

1.0i 16/06/11-
 1.2i 16/06/11-

... Picanto



Barre stabilisatrice
 Stabilizer bar
 Barra estabilizadora
 Drażek stabilizatora
 стабилизатор поперечной устойчивости

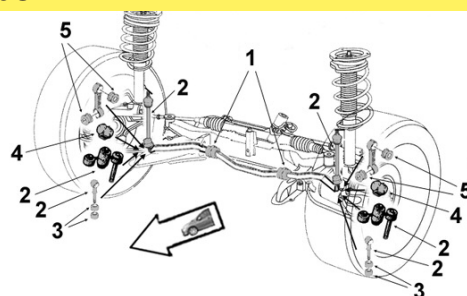

KIA



2306143 OE 5483007000	Biellette barre stab. G <i>Left stabilizer bar stub axle</i>	2306142 OE 5484007000	Biellette barre stab. D <i>Right stabilizer bar stub axle</i>
NEW 	2 1.0i 01/08-03/11 1.1i 01/08-03/11 1.1 CRDi 01/06-03/11	NEW 	2 1.0i 01/08-03/11 1.1i 01/08-03/11 1.1 CRDi 01/06-03/11

<p>Bras & Triangle de suspension Control arm Brazo y triángulo Wahacz Рычаг подвески</p>	G/L	D/R	 2	 1	 4	 3
---	-----	-----	--------------	--------------	--------------	--------------

7476052 OE 5450007100	Triangle de susp. G <i>Left track control arm</i>	7476051 OE 5450107100	Triangle de susp. D <i>Right track control arm</i>
	4 <i>Avec rotule With ball joint</i> 1.0i 05/04- 1.1i 05/04- 1.1 CRDi 11/05-		3 <i>Avec rotule With ball joint</i> 1.0i 05/04- 1.1i 05/04- 1.1 CRDi 11/05-

7576034 OE 5453007000		Rotule de susp. inf. G/D <i>L/R lower suspension ball joint</i>	
NEW 	1 Ø 16 2 1.0i 01/02/04-04/08/08 1.1i 01/02/04-04/08/08 1.1 CRDi 01/02/04-04/08/08		

7576043 OE 545302K000		Rotule de susp. G/D <i>L/R suspension ball joint</i>	
NEW 	1 Ø 18 2 1.0i 03/11- 1.2i 03/11-		

Rio ...

Eléments DIRECTION
Steering parts
Elementos Direcciones
Elementy układ kierowniczy
Элементы рулевой системы

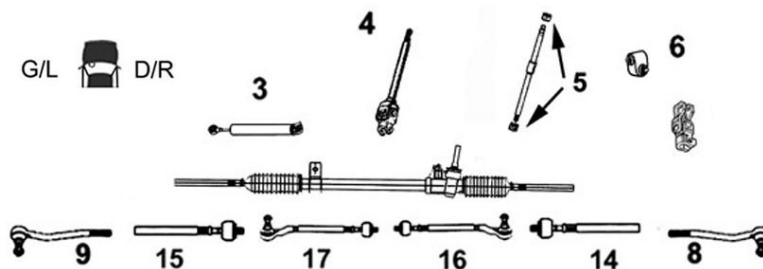



KIA

7776029	Axe de bielle G/D
OE KDX5332240B	L/R axial joint
	14 Côté dir. M16x1.5 Côté rot. M12x1.25 15 long 279 mm
	1.3i /Break 08/00-09/05 1.5i /Break 08/00-09/05

7776030	Axe de bielle G/D
OE 577241G000	L/R axial joint
	14 Côté dir. M16x1.5 Côté rot. M14x1.5 15 long 185 mm
	1.4i 09/05- 1.5 CRDi 09/05- 1.6i 16v. 09/05-

7776101	Axe de bielle G/D
OE 565400U500	L/R axial joint
	14 Côté dir. M16x1.5 Côté rot. M16x1.5 long 220 mm 15
	1.1 CRDi 06/11- 1.2i 06/11- 1.4i Sauf russie 06/11- 1.4 CRDi 06/11-

7676031	Rotule de direction G/D
OE 5682007000	L/R tie rod end
	8 9 M12x1.25
	1.3i /Break 09/00-02/05 1.5i /Break 09/00-02/05

7676032	Rotule de direction G
OE 568201G900	Left tie rod end
	9 M14 x 1.5
	1.4i 09/05- 1.5 CRDi 09/05- 1.6i 16v. 09/05-

7676048	Rotule de direction D
OE 568201G000	Right tie rod end
	8 M14 x 1.5
	1.4i 09/05- 1.5 CRDi 09/05- 1.6i 16v. 09/05-

7676105	Rotule de direction G
OE 568201W000	Left tie rod end
	9 M16 x 1.5
	1.1 CRDi 08/07/11- 1.2i 08/07/11- 1.4i Sauf Russie 08/07/11- 1.4 CRDi 08/07/11-

7676104	Rotule de direction D
OE 568201W090	Right tie rod end
	8 M16 x 1.5
	1.1 CRDi 08/07/11- 1.2i 08/07/11- 1.4i Sauf Russie 08/07/11- 1.4 CRDi 08/07/11-

... Rio

Bras & Triangle de suspension

Control arm
Brazo y triángulo
Wahacz
Рычаг подвески

G/L  D/R



KIA



Sephia

Bras & Triangle de suspension

Control arm
Brazo y triángulo
Wahacz
Рычаг подвески

G/L  D/R

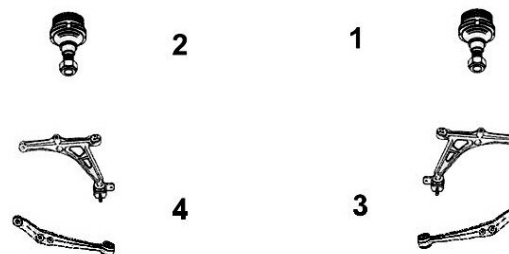

7476231

Triangle de susp. G

OE 0K2A134350C

Left track control arm

NEW

4 Avec rotule With ball joint Ø18



1.5i

01/99-10/00

7476230

Triangle de susp. D

OE 0K2A134300C

Right track control arm

NEW

3 Avec rotule With ball joint Ø18



1.5i

01/99-10/00

Sorento ...



Barre stabilisatrice

Stabilizer bar
Barra estabilizadora
Drażek stabilizatora
стабилизатор поперечной устойчивости

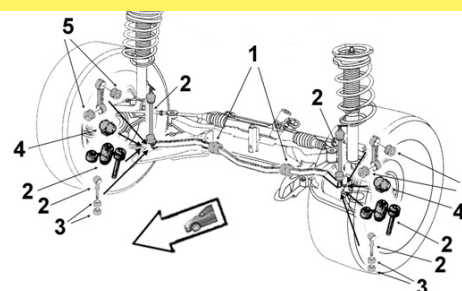

2306121

Biellette barre stab. G

OE 548302B000

Left stabilizer bar stub axle

2



2.2 CRDi FAP 4WD D4HB 11/09-

2306122

Biellette barre stab. D

OE 548402B000

Right stabilizer bar stub axle

2



2.2 CRDi FAP 4WD D4HB 11/09-

Bras & Triangle de suspension

Control arm
Brazo y triángulo
Wahacz
Рычаг подвески

G/L  D/R

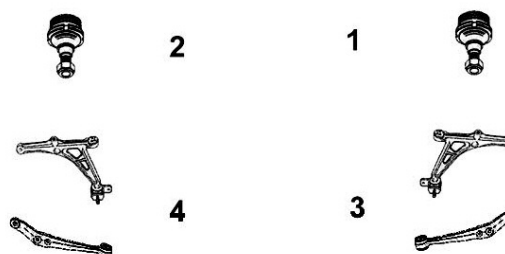

7476238

Triangle de susp. G

OE 545103E003

Left track control arm

NEW

4 Avec rotule With ball joint



2.4i 4WD 04/10/02-25/04/06
2.5 CRDi 4WD 04/10/02-25/04/06
3.5i 4WD 04/10/02-25/04/06

7476239

Triangle de susp. D

OE 545203E003

Right track control arm

NEW

3 Avec rotule With ball joint



2.4i 4WD 04/10/02-25/04/06
2.5 CRDi 4WD 04/10/02-25/04/06
3.5i 4WD 04/10/02-25/04/06

... Sorento

7576035 **Rotule de susp. G/D**
 OE 545703E001 *L/R suspension ball joint*

NEW



1
2

2.4i 4WD
 2.5 CRDi 4WD
 3.5i 4WD

04/10/02-25/04/06
 04/10/02-25/04/06
 04/10/02-25/04/06



Barre stabilisatrice
Stabilizer bar
Barra estabilizadora
Drażek stabilizatora
 стабилизатор поперечной устойчивости

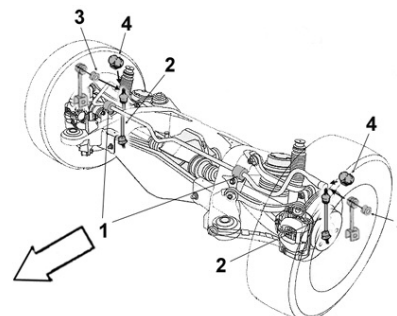

2306123 **Biellette barre stab.**
 OE 555302B000 *Stabilizer bar stub axle*



2

2.2 CRDi FAP 4WD

D4HB

11/09-

Soul ...

Éléments DIRECTION
Steering parts
Elementos Direcciones
Elementy układ kierowniczy
 Элементы рулевой системы

G/L D/R

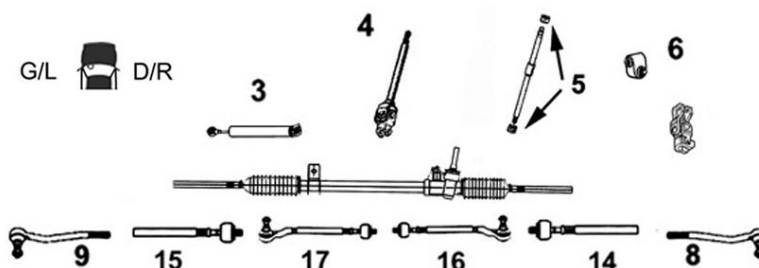

7676109 **Rotule de direction G**
 OE 568202K000 *Left tie rod end*

NEW



9

M16 x 1.5

1.6i 01/09-
 1.6 CRDi /FAP 01/09-

7676108 **Rotule de direction D**
 OE 568202K050 *Right tie rod end*

NEW



8

M16 x 1.5

1.6i 01/09-
 1.6 CRDi /FAP 01/09-

... Soul

Bras & Triangle de suspension

Control arm
Brazo y triángulo
Wahacz
Рычаг подвески

G/L  D/R

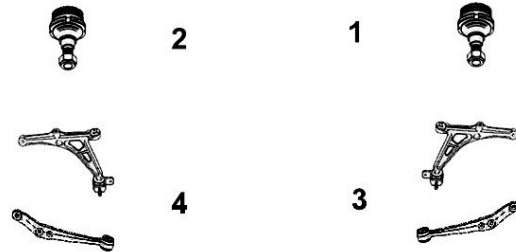

SASIC

KIA

7576043

Rotule de susp. G/D

OE 545302K000

L/R suspension ball joint

NEW



1 Ø 18
2

1.6i
1.6 CRDi /FAP

01/09-
01/09-

Sportage ...

Éléments DIRECTION

Steering parts
Elementos Direcciones
Elementy układ kierowniczy
Элементы рулевой системы

G/L  D/R

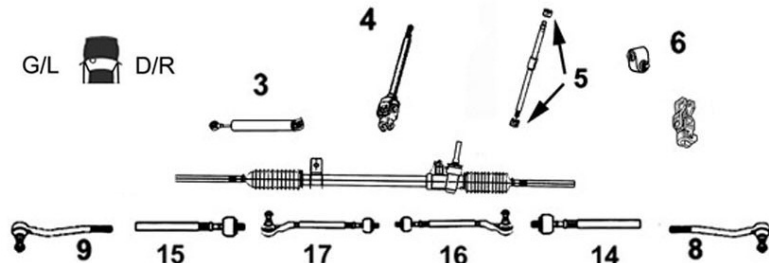

7776067

Axe de bielle G/D

OE 577242E000

L/R axial joint

NEW



14 Côté dir. M16x1.5 Côté rot. M16x1.5
15 long 245 mm

2.0i /4WD 04/07-05/10
2.0 CRDi /4WD /FAP 04/07-05/10
2.7i 4WD 04/07-05/10

7776087

Axe de bielle G/D

OE 577242S000

L/R axial joint

NEW



14 Côté dir. M16x1.5 Côté rot. M16x1.5
15 long 182 mm

1.6i 09/10-
1.7 CRDi 09/10-
2.0i 4WD 09/10-
2.0 CRDi /FAP /4WD 09/10-

7676097

Rotule de direction G

OE 568202E000

Left tie rod end

NEW



9 M16x1.5

2.0i /4WD 04/07-05/10
2.0 CRDi /4WD /FAP 04/07-05/10
2.7i 4WD 04/07-05/10

7676095

Rotule de direction D

OE 568202E900

Right tie rod end

NEW



8 M16x1.5

2.0i /4WD 04/07-05/10
2.0 CRDi /4WD /FAP 04/07-05/10
2.7i 4WD 04/07-05/10

7676099

Rotule de direction G

OE 568202S000

Left tie rod end

NEW



9 M16x1.5

1.6i 06/10-02/14
1.7 CRDi 06/10-02/14
2.0i /4WD 06/10-02/14
2.0 CRDi /4WD 06/10-02/14

7676098

Rotule de direction D

OE 568202S050

Right tie rod end

NEW



8 M16x1.5

1.6i 06/10-02/14
1.7 CRDi 06/10-02/14
2.0i /4WD 06/10-02/14
2.0 CRDi /4WD 06/10-02/14

... Sportage



Barre stabilisatrice
 Stabilizer bar
 Barra estabilizadora
 Drażek stabilizatora
 стабилизатор поперечной устойчивости

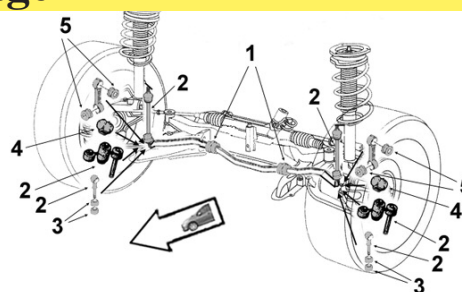

KIA



2306125 **Biellette barre stab.**
 OE 548302E100 *Stabilizer bar stub axle*



2

2.0i /4WD
 2.0 CRDi

JE G4GC
 JE D4EA

BVM5 09/04-09/10
 09/04-09/10

Bras & Triangle de suspension

Control arm
 Brazo y triángulo
 Wahacz
 Рычаг подвески

G/L D/R



7576027 **Rotule de susp. inf. G/D**
 OE 517602E000 *L/R lower suspension ball joint*



NEW

1
2

2.0i 4WD 141hp 104kw G4GC
 09/04-05/07
 2.0 CRDi /4WD 115hp 83kw D4EA
 09/04-11/07
 2.7i 4WD 175hp 129kw G6BA
 09/04-05/07

7576032 **Rotule de susp. inf. G/D**
 OE 545303S000 *L/R lower suspension ball joint*



NEW

1
2

Ø 18
 1.6i 09/10-
 1.7 CRDi 09/10-
 2.0i 4WD 09/10-
 2.0 CRDi /FAP /4WD 09/10-

7576042 **Rotule de susp. inf. G/D**
 OE 0K01134510B *L/R lower suspension ball joint*



NEW

1
2

2.0i 4WD
 2.0 TDCi 4WD

-12/03
 -12/03

7576045 **Rotule de susp. inf. G**
 OE 517602E010 *Left lower suspension ball joint*



NEW

2

2.0i /4WD 11/09/06-02/02/10
 2.0 CRDi /4WD 11/09/06-02/02/10

7576044 **Rotule de susp. inf. D**
 OE 517702E010 *Right lower suspension ball joint*



NEW

1

2.0i /4WD 11/09/06-02/02/10
 2.0 CRDi /4WD 11/09/06-02/02/10

... Sportage



Barre stabilisatrice
 Stabilizer bar
 Barra estabilizadora
 Drażek stabilizatora
 стабилизатор поперечной устойчивости

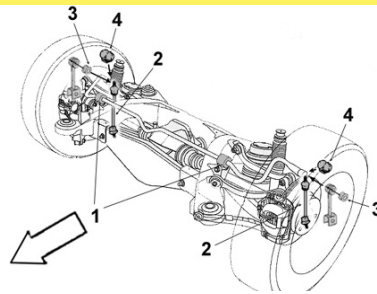

2306124

Biellette barre stab.

OE 555302E100

Stabilizer bar stub axle



2

2.0i /4WD JE G4GC BVM5
 09/04-09/10
 2.0 CRDi JE D4EA 09/04-09/10

2306145

Biellette barre stab.

OE 555303R000

Stabilizer bar stub axle

NEW



2

1.6i 2WD 10/06/10-
 1.7 CRDi 10/06/10-
 2.0i 10/06/10-
 2.0 CRDi 10/06/10-

Venga

Eléments DIRECTION
 Steering parts
 Elementos Direcciones
 Elementy układ kierowniczy
 Элементы рулевой системы

G/L D/R

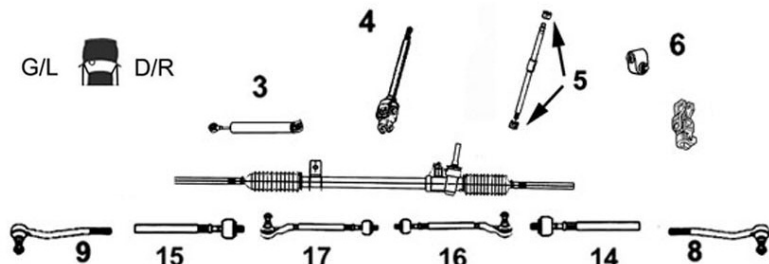

7676109

Rotule de direction G

OE 568202K000

Left tie rod end

NEW



9

M16 x 1.5

1.4i 01/10-
 1.4 CRDi 01/10-
 1.6i 01/10-
 1.6 CRDi 01/10-

7676108

Rotule de direction D

OE 568202K050

Right tie rod end

NEW



8

M16 x 1.5

1.4i 01/10-
 1.4 CRDi 01/10-
 1.6i 01/10-
 1.6 CRDi 01/10-

Bras & Triangle de suspension

Control arm
 Brazo y triángulo
 Wahacz
 Рычаг подвески

G/L D/R

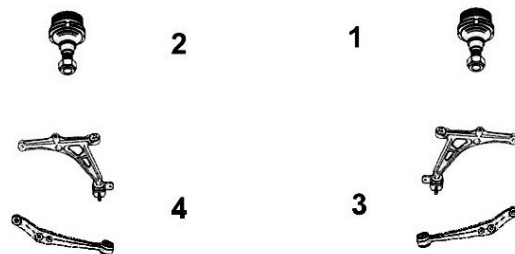

7576031

Rotule de susp. inf. G/D

OE 5453025000

L/R lower suspension ball joint

NEW



1
2

1.4i 10/10-
 1.4 CRDi 10/10-
 1.6i 10/10-
 1.6 CRDi 10/10-

Niva

Eléments DIRECTION

Steering parts

Elementos Direcciones

Elementy układ kierowniczy

Элементы рулевой системы

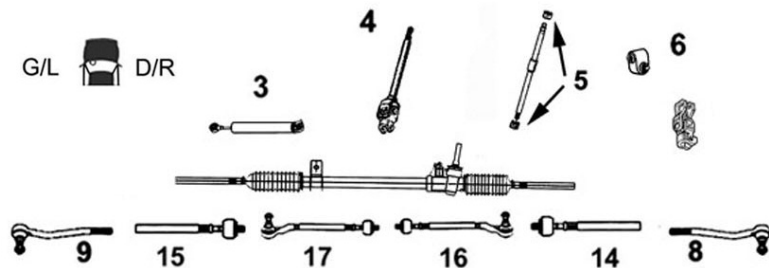

9006274

Rotule de direction G/D Int.

OE 21213414116

L/R inner tie rod end



10
11

M16x1

TT /all models 03/78-

9006478

Rotule de direction G/D Ext.

OE 21013003057

L/R outer tie rod end



8
9

M16 x 1

TT /all models 03/78-

Bras & Triangle de suspension

Control arm

Brazo y triángulo

Wahacz

Рычаг подвески

G/L D/R



9005279

Rotule de susp. G/D Inf./sup.

OE 21012904192

Susp. ball joint L/R inner/outer



1
2

TT /all models

03/78-

Dedra ...

Eléments DIRECTION

Steering parts

Elementos Direcciones

Elementy układ kierowniczy

Элементы рулевой системы

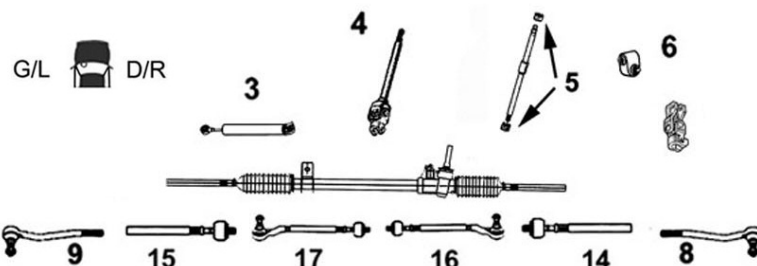

9006262

Axe de bielle G/D

OE 7633721

L/R axial joint



14
15

Côté dir. M14x1.5 Côté rot. M12x1.5
long 275 mm

TT /all models Sauf SW DNA

9006271

Axe de bielle G/D

OE 9941625

L/R axial joint



14
15

Côté dir. M14x1.5 Côté rot. M12x1.5
long 265 mm

TT /all models SW DA

... Dedra ...

Eléments DIRECTION
Steering parts
Elementos Direcciones
Elementy układ kierowniczy
Элементы рулевой системы

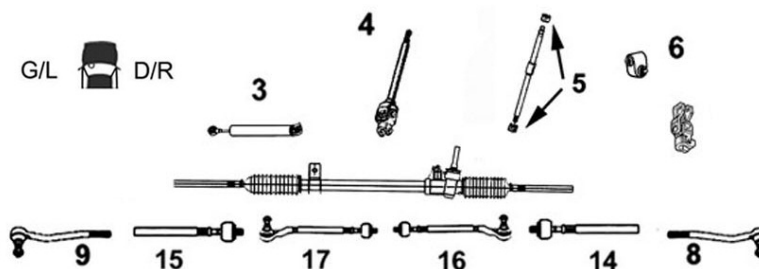

LANCIA

SASIC

9006334

Rotule de direction G

OE 9947437

Left tie rod end



9 M12 x 1.5

TT /all models

9006335

Rotule de direction D

OE 9947436

Right tie rod end



8 M12 x 1.5

TT /all models

9006654

Rotule de direction G/D

OE 9947714

L/R tie rod end

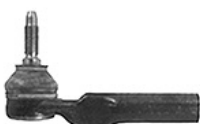

8
9 M14 x 1.5

1.6i 16v.

10/94-12/99



Barre stabilisatrice

Stabilizer bar

Barra estabilizadora

Drażek stabilizatora

стабилизатор поперечной устойчивости

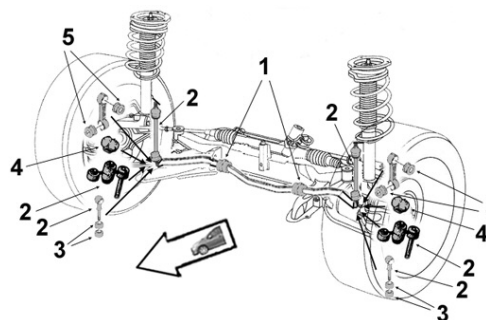

9005082

Biellette barre stab.

OE 60570627

Stabilizer bar stub axle



2

1.6 /i 16v. /ie 16v. /SW
 1.8 /i 16v. -01/98
 1.8 ie 16v. 10/94-02/96
 1.9 TDS
 2.0 /i 4WD
 2.0i 16v.
 2.0i Turbo 4WD 04/91-10/92
 2.0ie Turbo /HF 04/91-09/94

9005000

Biellette barre stab.

OE 51701045

Stabilizer bar stub axle



2

1.6i 16v. /SW
 1.8 /i 16v. /SW 15/12/97-
 1.9 TDS /SW 15/12/97-

9001502

Liaison élastique

OE 7601642

Elastic link



3 Ø int.10.4 Ø ext.30.5 long. tube int.15.5 ext.17.5

1.6 /i 16v.
 1.8 /i 16v.
 1.9 TDS
 2.0 /i 16v.

9001729

Palier de barre milieu

OE 7760425

Middle bar main bearing



1 Barre Ø 22

1.6i -15/09/90
 1.8 /i 16v.
 1.9 TDS
 2.0 /i 16v.

... Dedra ...

LANCIA



9001728 **Palier de barre milieu**
 OE 7760424 *Middle bar main bearing*



1 Barre Ø 23

1.6i
 1.6ie /SW
 1.8 /i 16v.
 1.8ie /SW
 1.9 TDS
 2.0 /i 16v.
 2.0i Turbo /4WD
 2.0ie Turbo /HF

16/09/90-

04/91-09/94
 04/91-09/94



Eléments SUSPENSION

Suspension parts
Elementos suspensión
Elementy zawieszenia
Элементы подвески

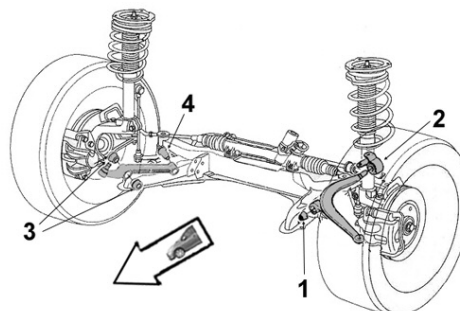

9001722 **Articulation AV**
 OE 7601064 *Front bush*



1 Ø 21

1.6 /i 16v.
 1.8 /i 16v.
 1.9 TDS
 2.0 /i 16v.

9001717 **Articulation AR G**
 OE 7601065 *Left rear bush*



2 Ø 21

1.6 /i 16v.
 1.8 /i 16v.
 1.9 TDS
 2.0 /i 16v.

9001714 **Articulation AR D**
 OE 7601068 *Right rear bush*



2 Ø 21

1.6 /i 16v.
 1.8 /i 16v.
 1.9 TDS
 2.0 /i 16v.

Bras & Triangle de suspension

Control arm
Brazo y triángulo
Wahacz
Рычаг подвески

G/L D/R

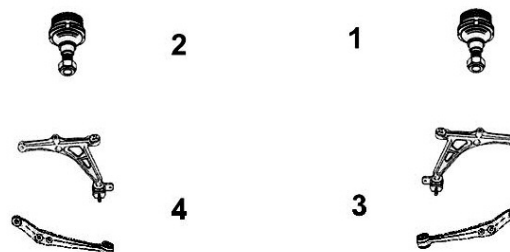

9005144 **Triangle de susp. G**
 OE 93501180 *Left track control arm*



4 Trou fixation Ø15 avec rotule
Fixation holes Ø15 with ball joint

1.6i 835A1000 BVM 11/89-15/07/90
 1.8i 835A2000 BVM 11/89-15/07/90
 1.9TDs 835A4000 BVM 11/89-15/07/90
 2.0ie 835A5000 BVM 11/89-15/07/90

9005143 **Triangle de susp. D**
 OE 93501181 *Right track control arm*



3 Trou fixation Ø15 avec rotule
Fixation holes Ø15 with ball joint

1.6i 835A1000 BVM 11/89-15/07/90
 1.8i 835A2000 BVM 11/89-15/07/90
 1.9TDs 835A4000 BVM 11/89-15/07/90
 2.0ie 835A5000 BVM 11/89-15/07/90

... Dedra

SASIC

LANCIA

Bras & Triangle de suspension

Control arm
Brazo y triángulo
Wahacz
Рычаг подвески

G/L  D/R



9005104

Triangle de susp. G

OE 71747915

Left track control arm

4 Avec rotule With ball joint Ø 17



1.6 15/07/90-14/12/97
1.8 15/07/90-14/12/97
1.9 TDs 15/07/90-14/12/97
2.0ie 15/07/90-

9005103

Triangle de susp. D

OE 71747916

Right track control arm

3 Avec rotule With ball joint Ø 17



1.6 15/07/90-14/12/97
1.8 15/07/90-14/12/97
1.9 TDs 15/07/90-14/12/97
2.0ie 15/07/90-

9005149

Triangle de susp. G

OE 46474556

Left track control arm

4 Avec rotule With ball joint Ø 17



1.6 15/12/97-
1.8 15/12/97-
1.9 TDs 15/12/97-

9005148

Triangle de susp. D

OE 46474557

Right track control arm

3 Avec rotule With ball joint Ø 17



1.6 15/12/97-
1.8 15/12/97-
1.9 TDs 15/12/97-



Support d'amortisseur

Suspension mounting
Soporte amortiguador
Poduszka amortyzatora
Опора амортизатора

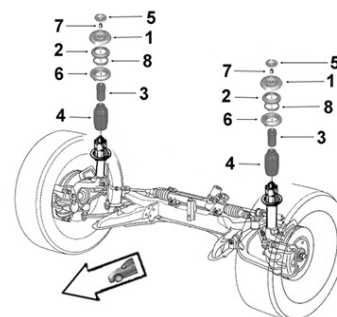

8005206

Butée à billes G/D

OE 7601502

L/R ball bearing

2 Ø 78.5 x 128 x 47



1.6i /16v.
1.8i /16v.
1.9 TDS
2.0i /Turbo

9005373

Butée protecteur susp. AV G/D

Part/oe 46404169

L/R front suspension bush

3
4



1.6

Delta ...

Eléments DIRECTION
Steering parts
Elementos Direcciones
Elementy układ kierowniczy
Элементы рулевой системы

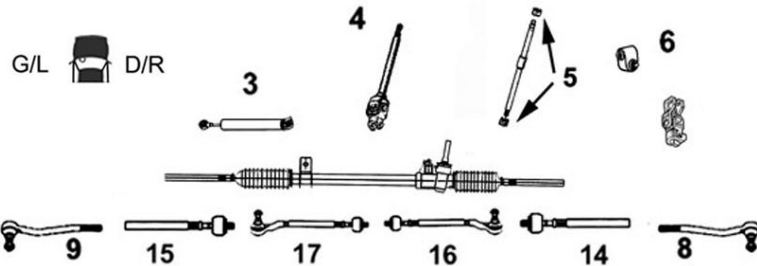

LANCIA



... Delta ...

SASIC

LANCIA



Barre stabilisatrice
 Stabilizer bar
 Barra estabilizadora
 Drażek stabilizatora
 стабилизатор поперечной устойчивости

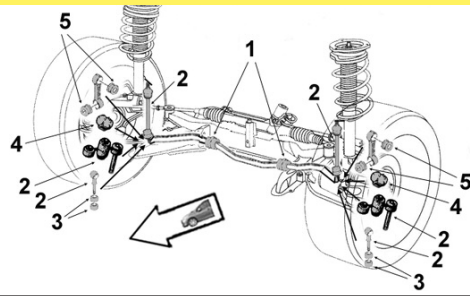

9005082 **Biellette barre stab.**
 OE 60570627 *Stabilizer bar stub axle*



2

1.6 /i 16v.	09/93-12/99
1.8 /i 16v.	09/93-12/99
1.9 TD	09/93-12/99
2.0i 16v. /Turbo	09/93-12/99

9005099 **Biellette barre stab.**
 OE 51801136 *Stabilizer bar stub axle*



2

1.4	09/08-
1.4i Turbo 198A1/4 BVM	07/08-
1.6 JTD DPF	07/08-
1.8i Turbo	01/09-
1.9 JTD FAP	07/08-
2.0 JTD FAP 198A5000 BVM	07/08-
2.0 JTD Multijet	09/08-

9001502 **Liaison élastique**
 OE 7601642 *Elastic link*



3 Ø int.10.4 Ø ext.30.5
 long. tube int.15.5 ext.17.5

1.4	09/93-12/99
1.6 /i 16v.	09/93-12/99
1.8 /i 16v.	09/93-12/99
1.9 TD	09/93-12/99
2.0i 16v. /Turbo	09/93-12/99

9001728 **Palier de barre milieu**
 OE 7760424 *Middle bar main bearing*



1 Barre Ø 23

1.4	09/93-12/99
1.6 /i 16v.	09/93-12/99
1.8 /i 16v.	09/93-12/99
1.9 TD	09/93-12/99
2.0i 16v. /Turbo	09/93-12/99



Eléments SUSPENSION
 Suspension parts
 Elementos suspensión
 Elementy zawieszenie
 Элементы подвески

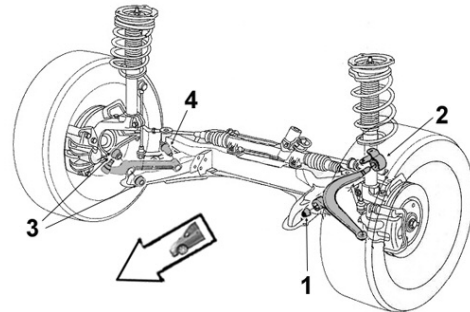

9001722 **Articulation AV**
 OE 7601064 *Front bush*



1 Ø 21

1.4	09/93-12/99
1.6 /i 16v.	09/93-12/99
1.8 /i 16v.	09/93-12/99
1.9 TD	09/93-12/99
2.0i 16v. /Turbo	09/93-12/99

9001717 **Articulation AR G**
 OE 7601065 *Left rear bush*



2 Ø 21

1.4	09/93-12/99
1.6 /i 16v.	09/93-12/99
1.8 /i 16v.	09/93-12/99
1.9 TD	09/93-12/99
2.0i 16v. /Turbo	09/93-12/99

9001714 **Articulation AR D**
 OE 7601068 *Right rear bush*



2 Ø 21

1.4	09/93-12/99
1.6 /i 16v.	09/93-12/99
1.8 /i 16v.	09/93-12/99
1.9 TD	09/93-12/99
2.0i 16v. /Turbo	09/93-12/99

... Delta ...

Bras & Triangle de suspension







Control arm
Brazo y triángulo
Wahacz
Рычаг подвески

G/L  D/R



LANCIA



9005179 OE 82391821	Triangle de susp. D <i>Right track control arm</i>		
	3 Avec rotule With ball joint	1.3 1.5	-12/92 -12/92
9005104 OE 71747915	Triangle de susp. G <i>Left track control arm</i>	9005103 OE 71747916	Triangle de susp. D <i>Right track control arm</i>
	4 Avec rotule With ball joint Ø 17		3 Avec rotule With ball joint Ø 17
1.6 1.8ie 2.0i 16v. LS /i Turbo LS	01/93- -01/13 01/93-	1.6 1.8ie 2.0i 16v. LS /i Turbo LS	01/93- -01/13 01/93-
9005149 OE 46474556	Triangle de susp. G <i>Left track control arm</i>	9005148 OE 46474557	Triangle de susp. D <i>Right track control arm</i>
	4 Avec rotule With ball joint Ø 17		3 Avec rotule With ball joint Ø 17
1.8 132hp 97kw Sauf LS 1.9 TD 2.0i 16v. /i Turbo Sauf LS	01/93- 01/93- 01/93-	1.8 132hp 97kw Sauf LS 1.9 TD 2.0i 16v. /i Turbo Sauf LS	01/93- 01/93- 01/93-
7476178 OE 51827736	Triangle de susp. G <i>Left track control arm</i>	7476177 OE 51827738	Triangle de susp. D <i>Right track control arm</i>
NEW 	4 Avec rotule With ball joint Ø 17	NEW 	3 Avec rotule With ball joint Ø 17
1.4i Turbo 1.6 JTD FAP 1.8i Turbo 1.9 JTD DPF 2.0 JTD FAP	07/08- 07/08- 01/09- 07/08- 07/08-	1.4i Turbo 1.6 JTD FAP 1.8i Turbo 1.9 JTD DPF 2.0 JTD FAP	07/08- 07/08- 01/09- 07/08- 07/08-

... Delta

SASIC

LANCIA



Support d'amortisseur
Suspension mounting
Soporte amortiguador
Poduszka amortyzatora
Опора амортизатора

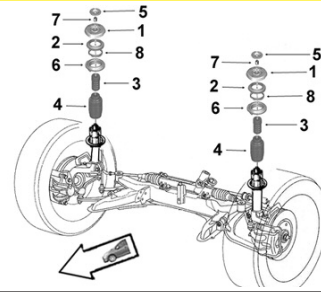

8005206

Butée à billes G/D

OE 7601502

L/R ball bearing



2 Ø 78.5 x 128 x 47

1.6i /16v.
 1.8i /16v.
 1.9 TD
 2.0 16v. /Turbo

09/93-12/99
 09/93-12/99
 09/93-12/99
 09/93-12/99

Eléments TRAIN ARRIERE

Rear axle parts
Tren TRAS
Elementy zawieszenia tylnego
элементы задней оси.



2606002

Articulation essieu G/D

OE 50702649

L/R axle bush



Ø int. 13 Ø ext. 67.5 coll. 80.5 long. tube int. 100 ext. 65 ep coll. 16

1.4		07/08-
1.4i Turbo	198A1/4 BVM	07/08-
2.0 JTD Multijet		07/08-
2.0 JTD FAP	198A5000 BVM	07/08-

Kappa ...

Eléments DIRECTION

Steering parts
Elementos Direcciones
Elementy układu kierowniczy
Элементы рулевой системы

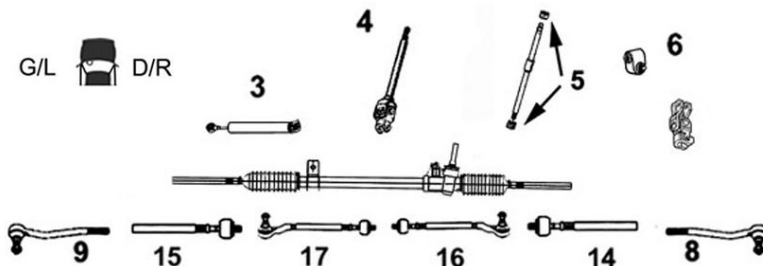

9006287

Axe de bielle G/D

OE 9946815

L/R axial joint



14 Côté dir. M14x1.5 Côté rot. M14x1.5
15 long 276 mm

2.0 10/94-
 2.0 Turbo Coupé 10/94-
 2.4 10/94-

9006339

Rotule de direction G/D

OE 82387676

L/R tie rod end



8 M14 x 1.5
9

TT /all models Sauf Diesel 10/94-
 Sauf servotronic

... Kappa

Bras & Triangle de suspension

Control arm
Brazo y triángulo
Wahacz
Рычаг подвески

G/L  D/R

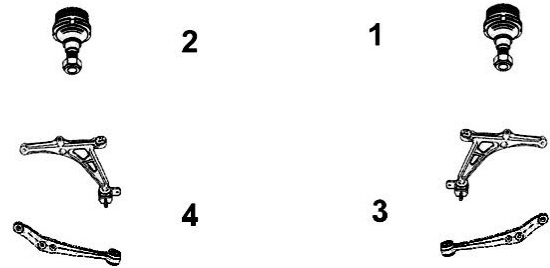

9005284

Rotule de susp. inf. G/D

OE 82480099

L/R lower suspension ball joint



1
2

TT /all models

10/94-

LANCIA



Lybra

Bras & Triangle de suspension

Control arm
Brazo y triángulo
Wahacz
Рычаг подвески

G/L  D/R

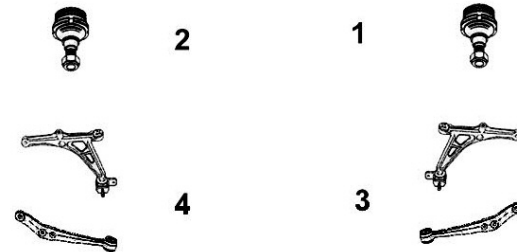

9005801

Triangle de susp. inf. G

OE 51832937

Lower left track control arm



4

Avec rotule With ball joint

1.6i 16v.	09/00-12/02
1.8i 16v.	09/99-03/05
1.9 JTD	09/99-03/05
2.0i 20v.	09/00-03/05
2.4 JTD	09/99-03/05

9005800

Triangle de susp. inf. D

OE 51832938

Lower right track control arm



3

Avec rotule With ball joint

1.6i 16v.	09/00-12/02
1.8i 16v.	09/99-03/05
1.9 JTD	09/99-03/05
2.0i 20v.	09/99-03/05
2.4 JTD	09/99-03/05



Support d'amortisseur

Suspension mounting
Soporte amortiguador
Poduszka amortyzatora
Опора амортизатора

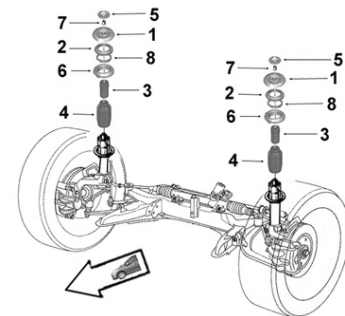

9005370

Butée à billes G/D

OE 1303672080

L/R ball bearing



2

Ø 78 x 128 x 45.5

1.6i 16v.
1.8i 16v.
1.9 JTD
2.0i 20v.
2.4 JTD

Musa

Eléments DIRECTION

Steering parts
Elementos Direcciones
Elementy układ kierowniczy
Элементы рулевой системы

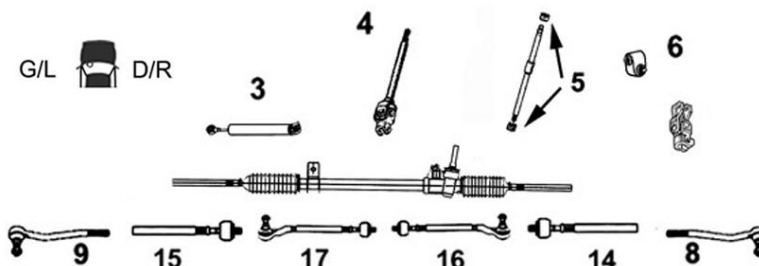

9006832 Axe de bielle G/D

Part/oe 77362502 L/R axial joint

14 Côté dir. M14x1.5 Côté rot. M14x1.5 long 255 mm

15



1.3 JTD
1.4i 16v.
1.9 JTD

09/04-
09/04-
09/04-



Eléments SUSPENSION

Suspension parts
Elementos suspensión
Elementy zawieszenie
Элементы подвески

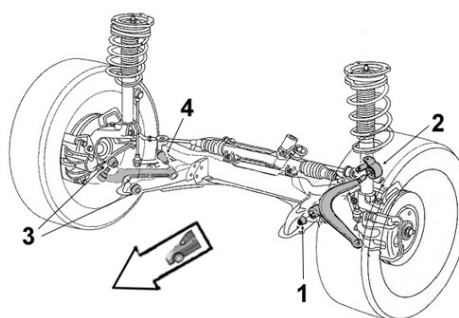

2256012 Articulation AV

Part/oe 46545661 Front bush

1 Ø int. 12 Ø ext. 32.5 coll. 34.5 coll. 37 long. tube int.52.5 ext.39



1.3 JTD
1.4i /GNV
1.4i 16v.
1.9 JTD

BVM 09/04-
BVM 08/06-
BVM 09/04-
BVM 09/04-

Bras & Triangle de suspension

Control arm
Brazo y triángulo
Wahacz
Рычаг подвески

G/L D/R

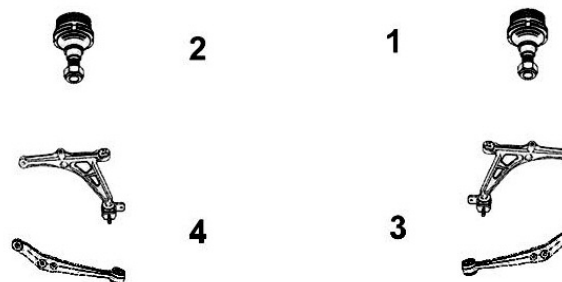

9005794 Triangle de susp. inf. G

OE 51839219 Lower left track control arm

4 Avec rotule With ball joint



1.3 JTD		09/04-
1.3 JTD FAP		10/07-
1.4i	BVM	08/06-
1.4i GPL	BVM	09/09-
1.4i 16v.		09/04-
1.6 JTD Multijet FAP BVM		07/08-
1.9 JTD	BVM	09/04-

9005793 Triangle de susp. inf. D

OE 51839218 Lower right track control arm

9005793 Triangle de susp. inf. D

OE 51839218 Lower right track control arm

3 Avec rotule With ball joint



1.3 JTD		09/04-
1.3 JTD FAP		10/07-
1.4i	BVM	08/06-
1.4i GPL	BVM	09/09-
1.4i 16v.		09/04-
1.6 JTD Multijet FAP BVM		07/08-
1.9 JTD	BVM	09/04-

Phedra

Eléments DIRECTION
Steering parts
Elementos Direcciones
Elementy układ kierowniczy
Элементы рулевой системы

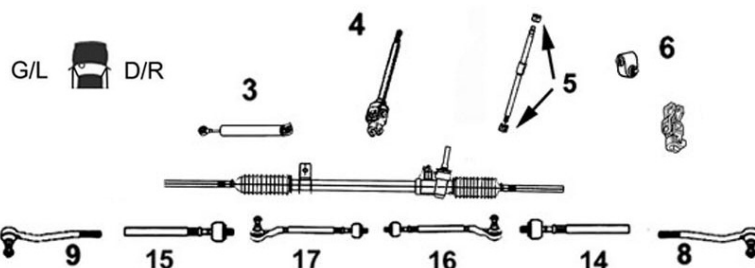

7670011 Rotule de direction G/D

OE 9403817738 *L/R tie rod end*



8 M14 x 1.5
9

2.2 JTD

10/07-

Bras & Triangle de suspension

Control arm
Brazo y triángulo
Wahacz
Рычаг подвески

G/L D/R



5203P63 Triangle de susp. G inf.

OE 1346384080 *Lower left track control arm*



4 Avec rotule With ball joint

2.0i 16v.	BVM BVA	03/04-06/06
2.0 JTD		03/04-06/06
2.2 JTD		03/04-06/06
3.0 V6 24v.	BVA	03/04-06/06

5213K63 Triangle de susp. D inf.

OE 1346385080 *Lower right track control arm*



3 Avec rotule With ball joint

2.0i 16v.	BVM BVA	03/04-06/06
2.0 JTD		03/04-06/06
2.2 JTD		03/04-06/06
3.0 V6 24v.	BVA	03/04-06/06

7470015 Triangle de susp. G

OE 1356060080 *Left track control arm*



4 Avec rotule With ball joint Ø 17

2.0 JTD	07/06-
2.2 JTD	07/06-

7470014 Triangle de susp. D

OE 1356061080 *Right track control arm*



3 Avec rotule With ball joint Ø 17

2.0 JTD	07/06-
2.2 JTD	07/06-

Prisma ...

SASIC

LANCIA

Eléments DIRECTION
Steering parts
Elementos Direcciones
Elementy uklad kierowniczy
Элементы рулевой системы

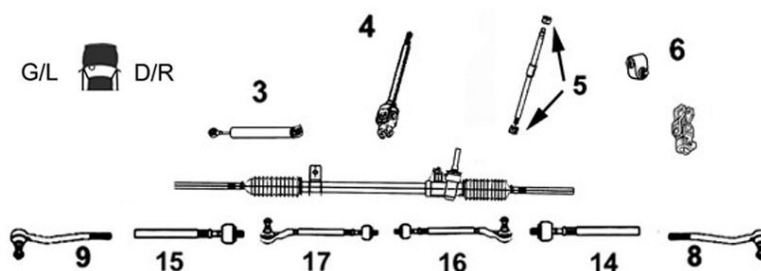

9006262 **Axe de bielle G/D**
 OE 5958244 *L/R axial joint*

14 Côté dir. M14x1.5 Côté rot. M12x1.5
15 long 275 mm

 TT /all models DNA

9006265 **Axe de bielle G/D**
 OE 9939038 *L/R axial joint*

14 Côté dir. M14x1.5 Côté rot. M12x1.5
15 long 277 mm

 TT /all models DA

9006493 **Rotule de direction G/D**
 OE 7545270 *L/R tie rod end*

8 M12 x 1.5
9

 TT /all models

12/84-



Barre stabilisatrice
Stabilizer bar
Barra estabilizadora
Drażek stabilizatora
 стабилизатор поперечной устойчивости

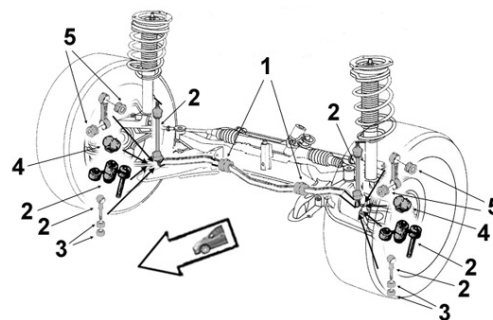

9005082 **Biellette barre stab.**
 OE 60570627 *Stabilizer bar stub axle*

2

1.3	01/83-
1.5	01/83-
1.6	01/83-
1.9 D	01/83-
1.9 TD	01/83-
2.0	01/83-



9001502 **Liaison élastique**
 OE 7601642 *Elastic link*

3 Ø int.10.4 Ø ext.30.5 long. tube int.15.5 ext.17.5

1.3	01/83-
1.5	01/83-
1.6	01/83-
1.9 D	01/83-
1.9 TD	01/83-
2.0	01/83-



9001729 **Palier de barre milieu**
 OE 7760425 *Middle bar main bearing*

1 Barre Ø 22

1.3	01/83-
1.5	01/83-
1.6	01/83-
1.9 D	01/83-
1.9 TD	01/83-
2.0	01/83-

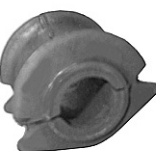

9001728 **Palier de barre milieu**
 OE 7760424 *Middle bar main bearing*

1 Barre Ø 23

1.3	01/83-
1.5	01/83-
1.6	01/83-
1.9 D	01/83-
1.9 TD	01/83-
2.0	01/83-



... Prisma



Eléments SUSPENSION

Suspension parts

Elementos suspensión

Elementy zawieszenia

Элементы подвески

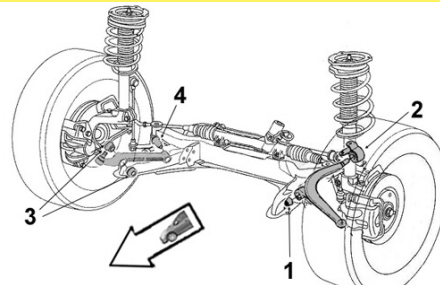

LANCIA



9001722

Articulation AV

OE 7601064

Front bush



1 Ø21

1.3
1.5
1.6
1.9 D
1.9 TD
2.0

01/83-
01/83-
01/83-
01/83-
01/83-
01/83-

9001717

Articulation AR G

OE 7601065

Left rear bush



2 Ø21

1.3
1.5
1.6
1.9 D
1.9 TD
2.0

01/83-
01/83-
01/83-
01/83-
01/83-
01/83-

9001714

Articulation AR D

OE 7601068

Right rear bush



2 Ø21

1.3
1.5
1.6
1.9 D
1.9 TD
2.0

01/83-
01/83-
01/83-
01/83-
01/83-
01/83-

Bras & Triangle de suspension

Control arm

Brazo y triángulo

Wahacz

Рычаг подвески

G/L D/R

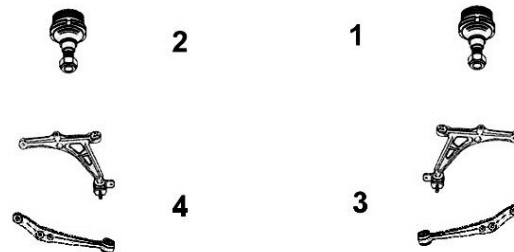

9005179

Triangle de susp. D

OE 82391821

Right track control arm



3 Avec rotule With ball joint

1.3
1.5

Thema

Eléments DIRECTION
Steering parts
Elementos Direcciones
Elementy uklad kierowniczy
Элементы рулевой системы

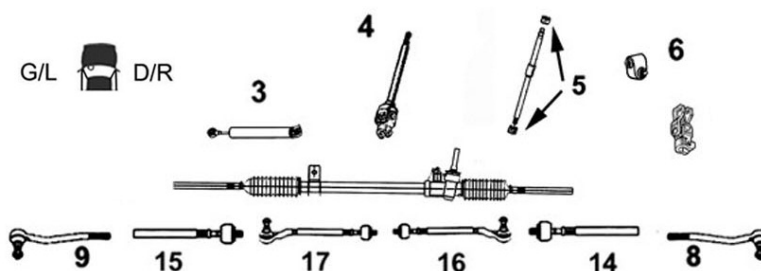

9006268

Axe de bielle G/D

OE 9940260

L/R axial joint



14 Côté dir. M14x1.5 Côté rot. M14x1.5
15 long 265 mm

TT /all models 04/86-

9006339

Rotule de direction G/D

OE 82387676

L/R tie rod end



8 M14 x 1.5
9

TT /all models 04/86-

Bras & Triangle de suspension

Control arm
Brazo y triángulo
Wahacz
Рычаг подвески

G/L D/R



9005232

Rotule de susp. inf. G/D

OE 82446499

L/R lower suspension ball joint



1
2

TT /all models

01/86-

Thesis

Eléments DIRECTION
Steering parts
Elementos Direcciones
Elementy uklad kierowniczy
Элементы рулевой системы

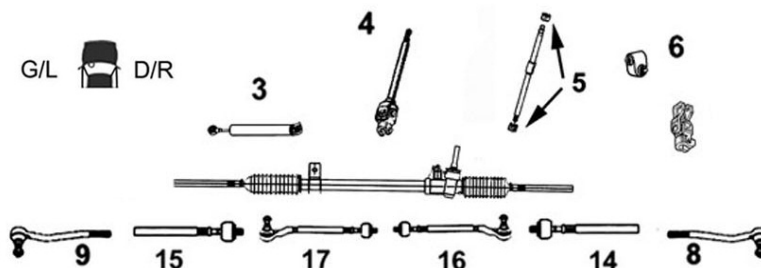

9006647

Rotule de direction G

OE 9947919

Left tie rod end



9

2.0i Turbo	09/02-03/05
2.4i	09/02-03/05
2.4 JTD	09/02-03/06
3.0i	09/02-03/05
3.2i	06/03-03/06

9006648

Rotule de direction D

OE 9947920

Right tie rod end

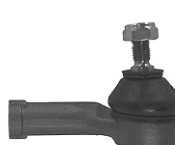

8

2.0i Turbo	09/02-03/05
2.4i	09/02-03/05
2.4 JTD	09/02-03/06
3.0i	09/02-03/05
3.2i	06/03-03/06

Y (Epsilon) ...

Eléments DIRECTION

Steering parts

Elementos Direcciones

Elementy układ kierowniczy

Элементы рулевой системы

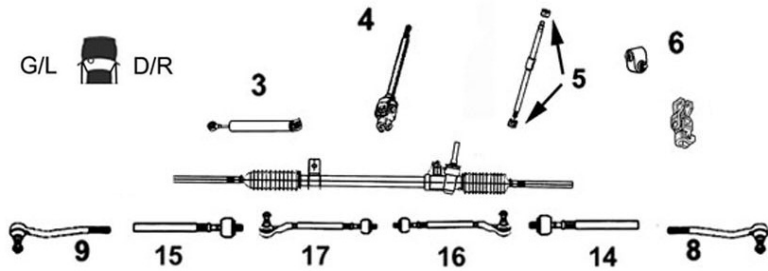

9006270

Axe de bielle G/D

Part/oe 9945562

L/R axial joint



14 Côté dir. M16x1.25 Côté rot. M12x1.5 long 271 mm

15

1.2 Epsilon
1.2i Y
1.4 Epsilon

BVM BVA

01/96-12/00
09/00-10/03
01/96-12/00

9006342

Rotule de direction G/D

OE 9946949

L/R tie rod end



8 M12 x 1.5

9

1.1
1.2 Epsilon
1.2i Y
1.4 Epsilon

BVM BVA

06/97-12/99
01/96-12/00
09/00-10/03
01/96-12/00



Eléments SUSPENSION

Suspension parts

Elementos suspensión

Elementy zawieszenie

Элементы подвески

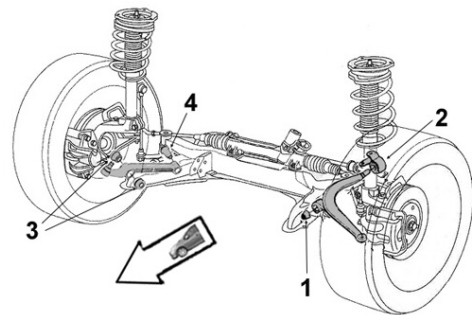

9001720

Articulation AV

OE 5927292

Front bush



1 Ø int.12 Ø ext.32 coll.37 long.tube int.55 ext.40 ep. coll.6

1.1
1.2 /i 16v.
1.4i 12v.

9001718

Articulation AR G

OE 7775343

Left rear bush



2

1.1
1.2 /i 16v.
1.4i 12v.

9001715

Articulation AR D

OE 7775344

Right rear bush



2

1.1
1.2 /i 16v.
1.4i 12v.

... Y (Epsilon) ...

SASIC

LANCIA

Bras & Triangle de suspension

Control arm
Brazo y triángulo
Wahacz
Рычаг подвески

G/L  D/R

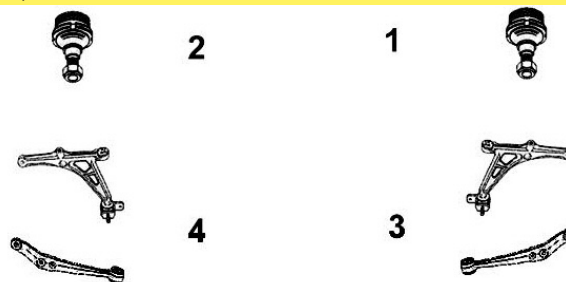

9005109

Triangle de susp. G

OE 46430002

Left track control arm

4 Avec rotule *With ball joint*



1.1 Epsilon	06/97-12/99
1.2 Epsilon BVM BVA	01/96-12/00
1.2i Y	09/00-10/03
1.4 Epsilon	01/96-12/00

9005108

Triangle de susp. D

OE 46430003

Right track control arm

3 Avec rotule *With ball joint*



1.1 Epsilon	06/97-12/99
1.2 Epsilon BVM BVA	01/96-12/00
1.2i Y	09/00-10/03
1.4 Epsilon	01/96-12/00



Support d'amortisseur

Suspension mounting
Soporte amortiguador
Poduszka amortyzatora
Опора амортизатора

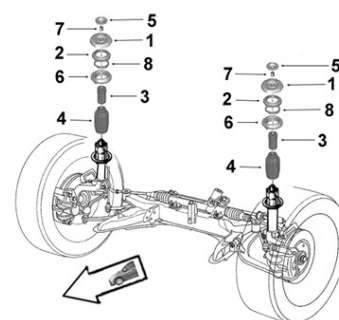

9005372

Butée protecteur susp. G/D

OE 7762158

L/R suspension bush

3
4



1.1
1.2 /i 16v.
1.4i 12v.

Eléments TRAIN ARRIERE

Rear axle parts
Tren TRAS
Elementy zawieszenia tylnego
элементы задней оси.

G/L  D/R



9005152

Bras AR G

OE 7769900

Left rear arm

2



1.1	06/97-12/99	ABS
1.2 /i 16v.	01/96-09/00	ABS
1.4	01/96-06/98	ABS

9005153

Bras AR D

OE 7769901

Right rear arm

1



1.1	06/97-12/99	ABS
1.2 /i 16v.	01/96-09/00	ABS
1.4	01/96-06/98	ABS

... Y (Epsilon)

9005713
Bras AR G

OE 7736514

Left rear arm

2

1.1	06/97-12/99 sans ABS
1.2 /i 16v.	01/96-09/00 sans ABS
1.4	01/96-06/98 sans ABS

9005714
Bras AR D

OE 7736515

Right rear arm

1

1.1	06/97-12/99 sans ABS
1.2 /i 16v.	01/96-09/00 sans ABS
1.4	01/96-06/98 sans ABS

Ypsilon ...

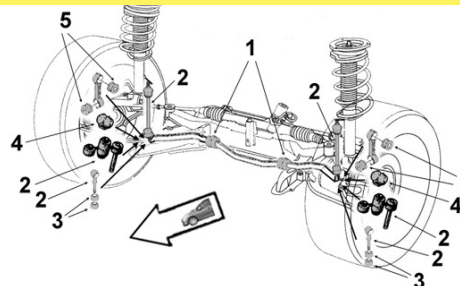
Barre stabilisatrice
Stabilizer bar
Barra estabilizadora
Drażek stabilizatora
стабилизатор поперечной устойчивости

9005099
Biellette barre stab.

OE 51801136

Stabilizer bar stub axle

2

0.9i	06/11-
1.2i	06/11-
1.3 JTD	06/11-

06/11-
06/11-
06/11-

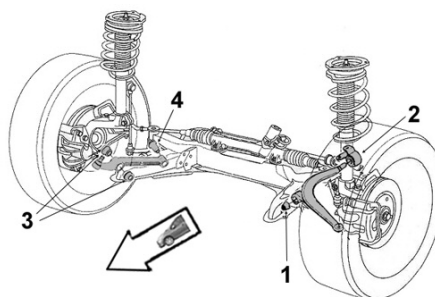
Eléments SUSPENSION
Suspension parts
Elementos suspensión
Elementy zawieszenie
Элементы подвески

2256012
Articulation AV

Part/oe 46545661

Front bush

1 Ø int. 12 Ø ext. 32.5 coll. 34.5 coll. 37 long. tube int.52.5 ext.39

1.2i /GNV	BVM	10/03-
1.2i 16v.	BVM	10/03-
1.3 JTD	BVM	10/03-
1.4i 16v.	BVM	10/03-

BVM	10/03-
BVM	10/03-
BVM	10/03-
BVM	10/03-

...Ypsilon

Bras & Triangle de suspension

Control arm
Brazo y triángulo
Wahacz
Рычаг подвески

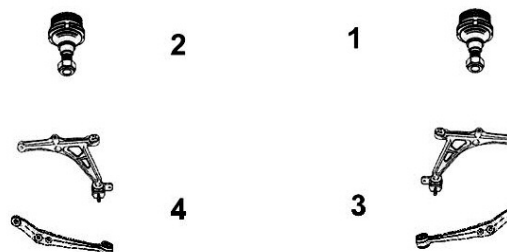
G/L  D/R**9005794**

OE 51839219

Triangle de susp. inf. G*Lower left track control arm*

4

1.2 /i 16v. 10/03-
1.3 JTD MJTD 10/03-
1.4 11/06-
1.4i 16v. 10/03-

9005793

OE 51839218

Triangle de susp. inf. D*Lower right track control arm*

3

1.2 /i 16v. 10/03-
1.3 JTD MJTD 10/03-
1.4 11/06-
1.4i 16v. 10/03-

Y10 ...

Eléments DIRECTION

Steering parts
Elementos Direcciones
Elementy układ kierowniczy
Элементы рулевой системы

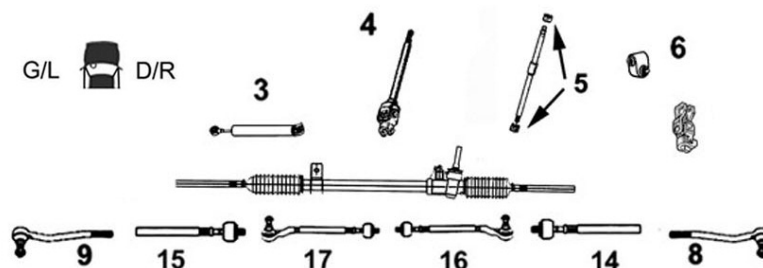
G/L  D/R**9006264**

Part/oe 5960321

Axe de bielle G/D*L/R axial joint*

14

15

Côté dir. M14x1.5 Côté rot. M12x1.5 long 192 mm

TT /all models

01/85-12/95

9006337

OE 5958246

Rotule de direction G/D*L/R tie rod end*

8

9

M12 x 1.5

TT /all models
Sauf 1.01.1 4WD

01/85-12/95

9006333

OE 5960037

Rotule de direction G/D*L/R tie rod end*

8

9

M12 x 1.5

1.0 4WD
1.1 4WD

07/86-12/95

01/85-12/95

... Y10

Bras & Triangle de suspension

Control arm
Brazo y triángulo
Wahacz
Рычаг подвески

G/L  D/R

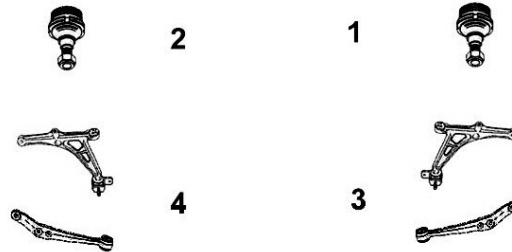

9005107

OE 7601261

Bras de suspension G/D

L/R track control arm



3
4 Sans rotule Without tie rod end

TT /all models

01/85-12/95

7576001

OE -

Rotule de susp. inf. G/D

L/R lower suspension ball joint



1
2

TT /all models

01/85-12/95

9005230

OE 4402649

Rotule de susp. inf. G/D

L/R lower suspension ball joint



1
2

TT /all models

01/85-12/95

Zeta ...

Eléments DIRECTION

Steering parts
Elementos Direcciones
Elementy uklad kierowniczy
Элементы рулевой системы

G/L  D/R

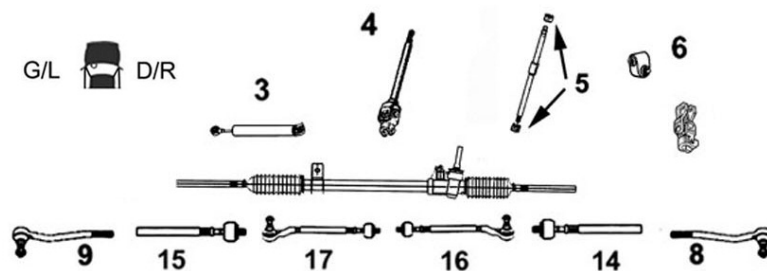

3008069

Part/oe 9566950880

Axe de bielle G/D

L/R axial joint



14
15 Côté dir. M14x1.5 Côté rot. M14x1.5 long 306 mm

TT /all models

0594094

OE 1306003080

Rotule de direction G/D

L/R tie rod end



8
9 M14 x 1.5

TT /all models

LANCIA



... Zeta ...



Barre stabilisatrice
Stabilizer bar
Barra estabilizadora
Drażek stabilizatora
 стабилизатор поперечной устойчивости

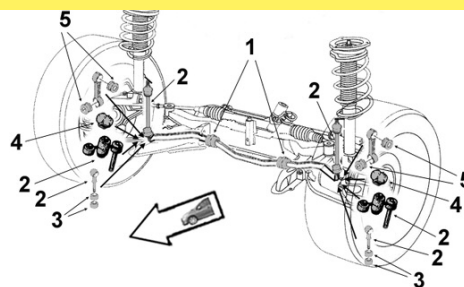

LANCIA

SASIC

0875355 **Biellette barre stab.**
 OE 1317425080 *Stabilizer bar stub axle*



2

2.0 /Turbo /i 16v.
 2.0 JTD
 2.1 TD

09/99-

0935155 **Liaison élastique**
 OE 1313056080 *Elastic link*



3 **Ø int.12.5 Ø ext.37.5**
long. tube int.20 ext.22

2.0 /Turbo /i 16v.
 2.1 TD

0945695 **Palier de barre milieu**
 OE 1305782080 *Middle bar main bearing*



1 **Barre Ø 24**

2.0 /Turbo /i 16v.
 2.1 TD



Eléments SUSPENSION
Suspension parts
Elementos suspensión
Elementy zawieszenie
 Элементы подвески

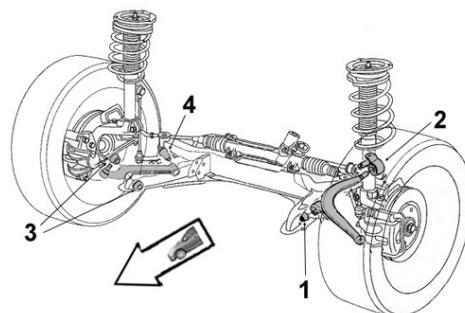

9001724 **Articulation AV**
 OE 1312317080 *Front bush*



1

2.0 /Turbo /i 16v.
 2.1 TD

9001719 **Articulation AR G**
 OE 1305551080 *Left rear bush*



2

2.0 /Turbo /i 16v.
 2.1 TD

9001716 **Articulation AR D**
 OE 1305552080 *Right rear bush*



2

2.0 /Turbo /i 16v.
 2.1 TD

... Zeta

Bras & Triangle de suspension

Control arm
Brazo y triángulo
Wahacz
Рычаг подвески

G/L  D/R

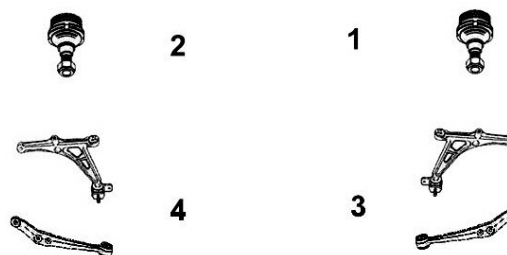

5203943

OE 71737047

Triangle de susp. G

Left track control arm



4 Avec rotule *With ball joint*

TT /all models

5213643

OE 71737048

Triangle de susp. D

Right track control arm



3 Avec rotule *With ball joint*

TT /all models



Support d'amortisseur

Suspension mounting
Soporte amortiguador
Poduszka amortyzatora
Опора амортизатора

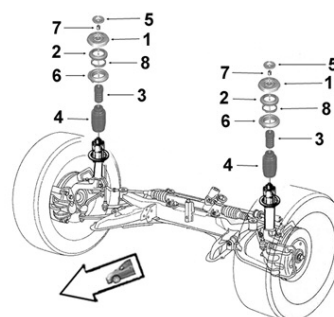

0385165

OE 9405038689

Support suspension G

Left suspension mounting



1

2.0 /Turbo /i 16v.
2.1 TD

0385175

OE 9405038709

Support suspension D

Right suspension mounting



1

2.0 /Turbo /i 16v.
2.1 TD

9005370

OE 1303672080

Butée à billes G/D

L/R ball bearing



2

Ø 78 x 128 x 45.5

2.0 /Turbo /i 16v.
2.1 TD

0335395

OE 1307021080

Butée de suspension G/D

L/R suspension bush



3

H105

2.0
2.0i 16v.

Discovery

Eléments DIRECTION
 Steering parts
 Elementos Direcciones
 Elementy układ kierowniczy
 Элементы рулевой системы

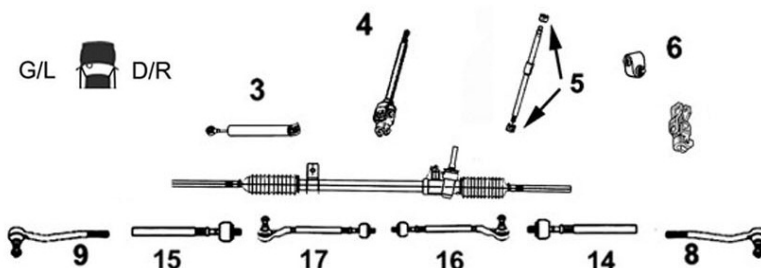

9006503 Rotule de direction G/D

OE NRC5869 L/R tie rod end

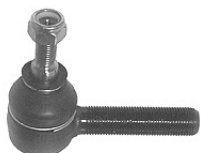

8 9 Filetage pas à droite Right-hand thread 11/16 x 16h

TT /all models

01/89-

FreeLander

Eléments DIRECTION
 Steering parts
 Elementos Direcciones
 Elementy układ kierowniczy
 Элементы рулевой системы

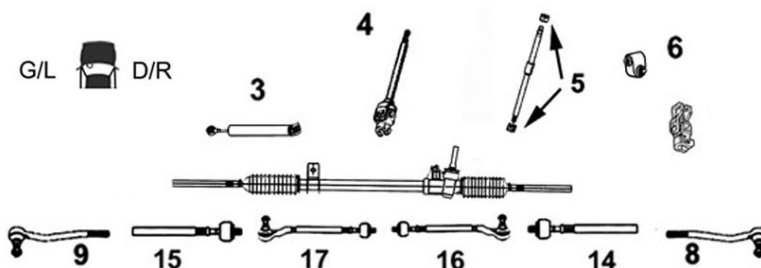

9006507 Rotule de direction G

OE QJB100230 Left tie rod end



9 M16 x 1.5

1.8i 16v. 4WD -01/05
 2.0 Di 4WD -08/02
 2.0 TD 4WD BVM BVA 09/02-12/06
 2.5i V6 4WD BVA 09/02-01/05

9006505 Rotule de direction D

OE QJB100220 Right tie rod end



8 M16 x 1.5

1.8i 16v. 4WD -01/05
 2.0 Di 4WD -08/02
 2.0 TD 4WD BVM BVA 09/02-12/06
 2.5i V6 4WD BVA 09/02-01/05

CT

Bras & Triangle de suspension

Control arm
 Brazo y triángulo
 Wahacz
 Рычаг подвески

G/L D/R

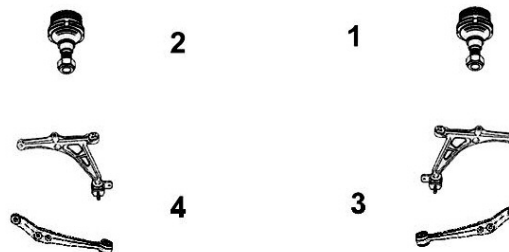

9005568 Rotule de susp. inf. G/D

OE 4333049185 L/R lower suspension ball joint



1 2

1.8i 100hp 73kw 200H 2ZR BV Séq. 01/11-

MAZDA 2 ...

Eléments DIRECTION
 Steering parts
 Elementos Direcciones
 Elementy uklad kierowniczy
 Элементы рулевой системы

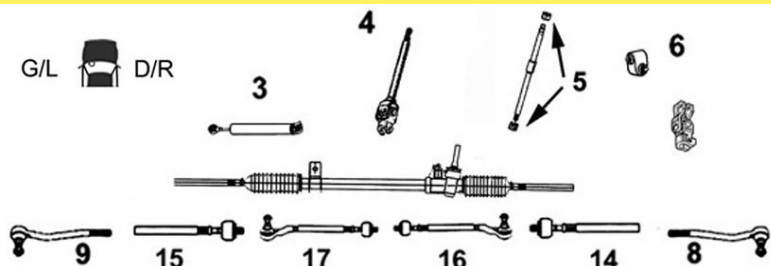

7906001 Néc. Rép. Axe de Bielle
 OE D65332240 Axial joint repair kit

NEW



14 Côté dir. M14x1.5 Côté rot. M14x1.5 long 215 mm
15

1.3i	09/07-
1.4 TD	04/08-
1.4 TDCi	01/08-
1.5i	09/07-
1.6 D	04/08-

7676078 Rotule de direction G
 OE D65132290 Left tie rod end

NEW



9 M14 x 1.5

1.3i	09/07-24/05/10
1.4i	04/08-24/05/10
1.4 TD	09/07-24/05/10
1.4 TDCi	01/08-24/05/10
1.5i	09/07-24/05/10
1.6 D MZRCD	04/08-24/05/10

7676077 Rotule de direction D
 OE D65132280 Right tie rod end

NEW



8 M14 x 1.5

1.3i	09/07-24/05/10
1.4i	04/08-24/05/10
1.4 TD	09/07-24/05/10
1.4 TDCi	01/08-24/05/10
1.5i	09/07-24/05/10
1.6 D MZRCD	04/08-24/05/10

Bras & Triangle de suspension

Control arm
 Brazo y triángulo
 Wahacz
 Рычаг подвески

G/L D/R

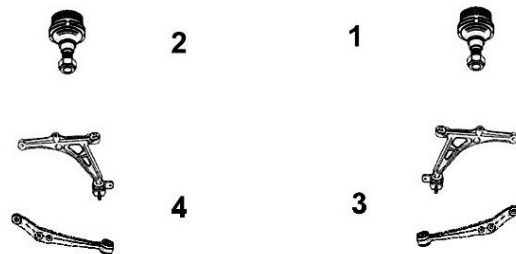

7476147 Triangle de susp. G
 OE D65134350B Left track control arm

NEW



4 Avec rotule With ball joint Ø 17

1.3i	ZJ	09/07-02/11
1.4 TDCi	F6JC	01/08-02/11
1.5i	ZY BVM	09/07-02/11

7476145 Triangle de susp. D
 OE D65134300B Right track control arm

NEW



3 Avec rotule With ball joint Ø 17

1.3i	ZJ	09/07-02/11
1.4 TDCi	F6JC	01/08-02/11
1.5i	ZY BVM	09/07-02/11

7576002 Rotule de susp. inf. G/D
 Part/oe DD3234300A L/R lower suspension ball joint

NEW



1 Ø 16.5
2

1.2i 16v.	FUJA	BVM	03/03-09/07
1.4i 16v.	FXJA Duratec	BVM	03/03-09/07
1.4 TDCi	F6JA Duratorq	BVM	03/03-09/07
1.6i 16v.	FYJA Duratec	BVM	03/03-09/07

... MAZDA 2



Support d'amortisseur
 Suspension mounting
 Soporte amortiguador
 Poduszka amortyzatora
 Опора амортизатора

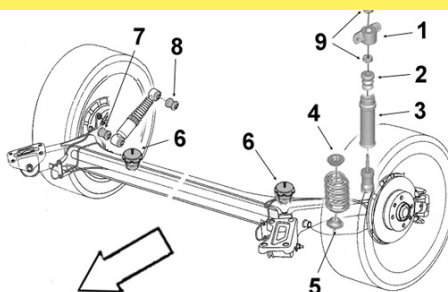

2656035

Support suspension G/D

OE DR612870X

L/R suspension mounting



1

1.3 MZR
 1.4 MZRCD
 1.5 MZR

09/07-
 09/07-
 09/07-

MAZDA 3 ...

Eléments DIRECTION
 Steering parts
 Elementos Direcciones
 Elementy uklad kierowniczy
 Элементы рулевой системы

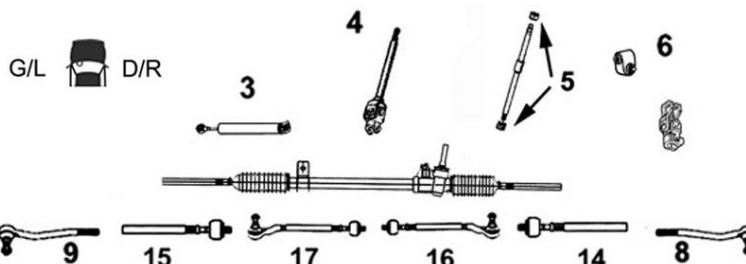

7776088

Axe de bielle G/D

OE BP4L32240

L/R axial joint

NEW



14 Côté dir. M14x1.5 Côté rot. M17x1.5 long 290 mm

15
 1.4i
 1.6i /MZR
 1.6 CiDT
 1.6 D /MZCD
 1.6 TD /MZR CD
 2.0i /MZR
 2.0 MZR CD
 2.2 MZR CD
 2.3i Turbo

10/03-06/09
 10/03-
 06/04-06/09
 07/06-06/09
 07/06-06/09
 10/03-
 12/06-
 06/09-
 12/06-

7676080

Rotule de direction G

OE BP4L32290

Left tie rod end

NEW



9 M17 x 1.5

1.3i ZJ 07/06-06/09
 1.4i ZJ 10/03-07/06
 1.6i Z6 10/03-
 1.6 CiDT Y6 03/04-07/06
 1.6 D MZCD Y6 12/05-10/11
 1.6 D MZCD FAP Y6 09/11-
 1.6 TD Y6 07/06-06/09
 2.0i /16v. LF 10/03-
 2.0 D MZRCD RF 04/07-06/09
 2.2 D MZRCD R2 06/09-10/11
 2.2 D MZRCD FAP R2 09/11-
 2.3i 16v. Turbo L3 09/06-06/09
 2.3i 16v. Turbo L3 09/11-

7676079

Rotule de direction D

OE BP4L32280

Right tie rod end

NEW



8 M17 x 1.5

1.3i ZJ 07/06-06/09
 1.4i ZJ 10/03-07/06
 1.6i Z6 10/03-
 1.6 CiDT Y6 03/04-07/06
 1.6 D MZCD Y6 12/05-10/11
 1.6 D MZCD FAP Y6 09/11-
 1.6 TD Y6 07/06-06/09
 2.0i /16v. LF 10/03-
 2.0 D MZRCD RF 04/07-06/09
 2.2 D MZRCD R2 06/09-10/11
 2.2 D MZRCD FAP R2 09/11-
 2.3i 16v. Turbo L3 09/06-06/09
 2.3i 16v. Turbo L3 09/11-

... MAZDA 3



Barre stabilisatrice
 Stabilizer bar
 Barra estabilizadora
 Drażek stabilizatora
 стабилизатор поперечной устойчивости

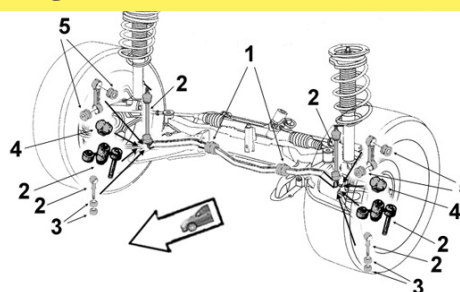

2306024 **Biellette barre stab.**
 OE BP4K34170D *Stabilizer bar stub axle*



2

1.3i
 1.4i
 1.6i
 1.6 TD
 2.0i 16v.

BVM 07/06-01/09
 BVM 10/03-07/06
 10/03-07/06
 BVM 06/04-
 10/03-



Eléments SUSPENSION
 Suspension parts
 Elementos suspensión
 Elementy zawieszenie
 Элементы подвески

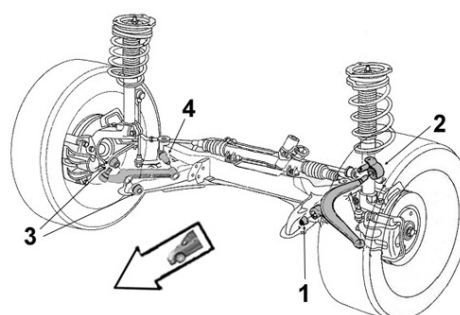

2256021 **Articulation AR**
 OE - *Rear bush*



2 Ø int.22

1.3i BVM 07/06-01/09
 1.4i BVM 10/03-07/06
 1.6i 10/03-01/09
 1.6 CiDT BVM 03/04-07/06
 1.6 TD BVM 07/06-01/09
 2.0i 16v. BVM 10/03-01/09

2256020 **Articulation AV**
 OE - *Front bush*



1 Ø int. 14 Ø ext. 41 coll. 45.5
 long. tube int. 65 ext 31.5

1.3i BVM 07/06-01/09
 1.4i BVM 10/03-07/06
 1.6i 10/03-01/09
 1.6 CiDT BVM 03/04-07/06
 1.6 TD BVM 07/06-01/09
 2.0i 16v. BVM 10/03-01/09

Bras & Triangle de suspension

Control arm
 Brazo y triángulo
 Wahacz
 Рычаг подвески

G/L D/R

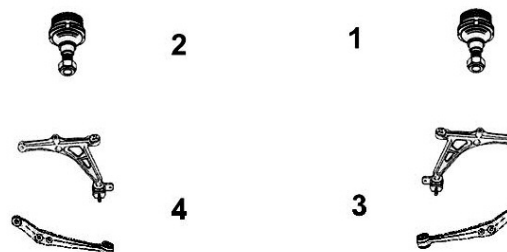

7476149 **Triangle de susp. G**
 OE C51334350 *Left track control arm*

NEW



4 Avec rotule With ball joint Ø 18

1.3i ZJ 07/06-06/09
 1.4i ZJ 10/03-07/06
 1.6i Z6 10/03-06/09
 1.6 CiDT Y6 03/04-07/06
 1.6 DMZCD Y6 12/05-06/09
 1.6 TD Y6 07/06-06/09
 2.0i 16v. LF 10/03-06/09

7476148 **Triangle de susp. D**
 OE C51334300 *Right track control arm*

NEW



3 Avec rotule With ball joint Ø 18

1.3i ZJ 07/06-06/09
 1.4i ZJ 10/03-07/06
 1.6i Z6 10/03-06/09
 1.6 CiDT Y6 03/04-07/06
 1.6 DMZCD Y6 12/05-06/09
 1.6 TD Y6 07/06-06/09
 2.0i 16v. LF 10/03-06/09

MAZDA 5 ...

SASIC

MAZDA

Eléments DIRECTION

Steering parts

Elementos Direcciones

Elementy układ kierowniczy

Элементы рулевой системы

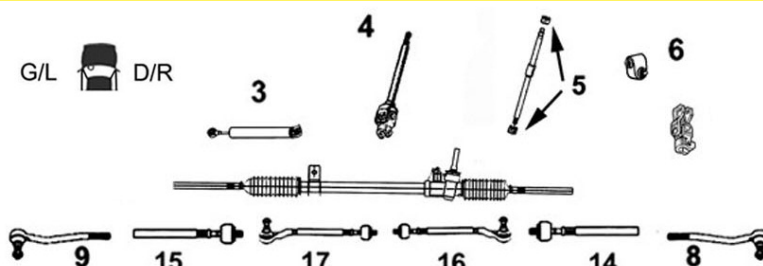

7776088

Axe de bielle G/D

OE BP4L32240

L/R axial joint

NEW



14 Côté dir. M14x1.5 Côté rot. M17x1.5 long 290 mm

1.6 D	09/10-
1.8i 16v. /MZR	03/05-
2.0i	03/05-
2.0 D /MZR CD	03/05-
2.0 TD MZR CD	01/08-

7676080

Rotule de direction G

OE BP4L32290

Left tie rod end

NEW



9 M17 x 1.5

1.6 D MZCD Y6	01/11-
1.8i 16v. L8	01/08-
2.0i BA/LF(DX) /MZR	01/08-10/10
2.0i 16v. LF	01/08-
2.0 D MZCD RF	06/05-10/08
2.0 D MZCD LF	01/11-
2.0 TD RF /MZRC	01/08-10/10

7676079

Rotule de direction D

OE BP4L32280

Right tie rod end

NEW



8 M17 x 1.5

1.6 D MZCD Y6	01/11-
1.8i 16v. L8	01/08-
2.0i BA/LF(DX) /MZR	01/08-10/10
2.0i 16v. LF	01/08-
2.0 D MZCD RF	06/05-10/08
2.0 D MZCD LF	01/11-
2.0 TD RF /MZRC	01/08-10/10



Barre stabilisatrice

Stabilizer bar

Barra estabilizadora

Drażek stabilizatora

стабилизатор поперечной устойчивости

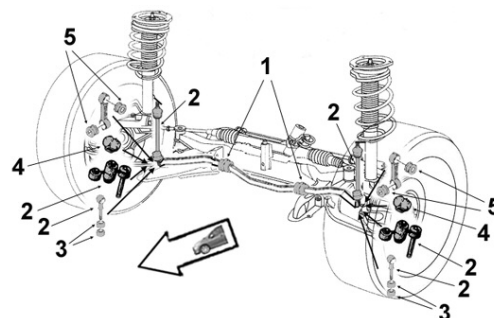

2306024

Biellette barre stab.

OE BP4K34170D

Stabilizer bar stub axle

2



1.6 D		09/10-
1.8i 16v.	BVM	01/08-
2.0i /16v.		03/05-
2.0 D		03/05-
2.0 TD	BVM	06/05-

... MAZDA 5

Bras & Triangle de suspension

Control arm
Brazo y triángulo
Wahacz
Рычаг подвески

G/L  D/R



MAZDA

SASIC

7476149

Triangle de susp. G

OE C51334350

Left track control arm

NEW

4 Avec rotule With ball joint Ø 18



1.6 D MZCD	Y6	01/11-
1.8i 16v.	L8	06/05-
2.0i BA/ LF/ MZR	BVA	01/08-10/10
2.0i 16v.	LF BVM	01/08-
2.0 D MZCD	LF	01/11-

7476148

Triangle de susp. D

OE C51334300

Right track control arm

NEW

3 Avec rotule With ball joint Ø 18



1.6 D MZCD	Y6	01/11-
1.8i 16v.	L8	06/05-
2.0i BA/ LF/ MZR	BVA	01/08-10/10
2.0i 16v.	LF BVM	01/08-
2.0 D MZCD	LF	01/11-

MAZDA 121

Eléments DIRECTION

Steering parts
Elementos Direcciones
Elementy układ kierowniczy
Элементы рулевой системы

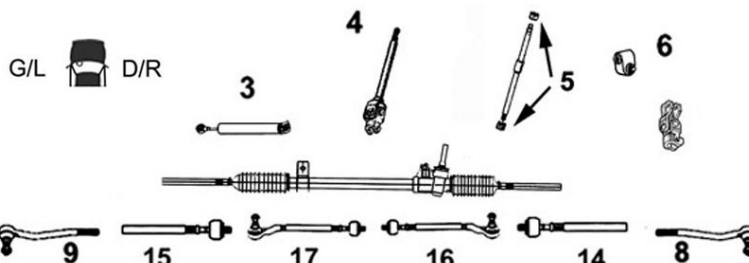

7776023

Axe de bielle G/D

OE 1E0032240

L/R axial joint



14 Côté dir. M14x1.5 Côté rot. M14x2.0 long 307 mm
15

1.2i	03/96-
1.3i	03/96-
1.8 D	03/96-

MAZDA 323...

Eléments DIRECTION

Steering parts
Elementos Direcciones
Elementy układ kierowniczy
Элементы рулевой системы

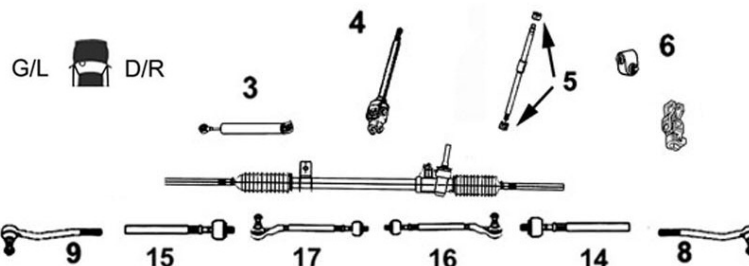

9006511

Rotule de direction G/D

OE B45532280

L/R tie rod end



8 M12 x 1.25
9

1.7 D	BG /BA	01/89-
2.0i 16v. V6	BG /BA	01/89-

... MAZDA 323

SASIC

MAZDA

Bras & Triangle de suspension

Control arm
Brazo y triángulo
Wahacz
Рычаг подвески

G/L D/R

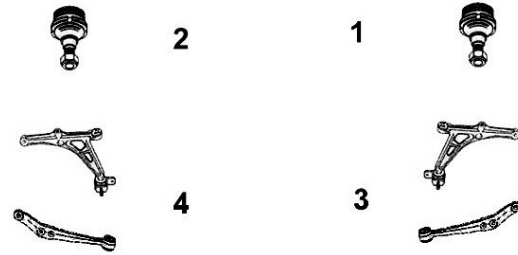

7476173

Triangle de susp. G

OE B25D34350D

Left track control arm

4 Avec rotule With ball joint Ø 18

1.3i /16v.	BJ B3	01/00-10/03
1.5i	BJ ZL	05/98-09/01
1.6i	BJ ZM	09/01-03/04
1.8i 16v.	BJ FP	05/98-03/04
2.0i 16v.	BJ FS	09/00-03/04
2.0 D	BJ RF1G	06/97-03/04
2.0 DiTD	BJ RF	07/98-03/04



7476172

Triangle de susp. D

OE B25D34300D

Right track control arm

3 Avec rotule With ball joint Ø 18

1.3i /16v.	BJ B3	01/00-10/03
1.5i	BJ ZL	05/98-09/01
1.6i	BJ ZM	09/01-03/04
1.8i 16v.	BJ FP	05/98-03/04
2.0i 16v.	BJ FS	09/00-03/04
2.0 D	BJ RF1G	06/97-03/04
2.0 DiTD	BJ RF	07/98-03/04



9005286

Rotule de susp. inf. G/D

OE BTDA34550

L/R lower suspension ball joint

1
2

1.3i 16v.	BG /BA	01/89-
1.5	BG /BA	01/89-
1.7 D	BG /BA	01/89-
2.0i 16v. V6	BG /BA	01/89-



MAZDA 626 ...

Éléments DIRECTION

Steering parts
Elementos Direcciones
Elementy układ kierowniczy
Элементы рулевой системы

G/L D/R

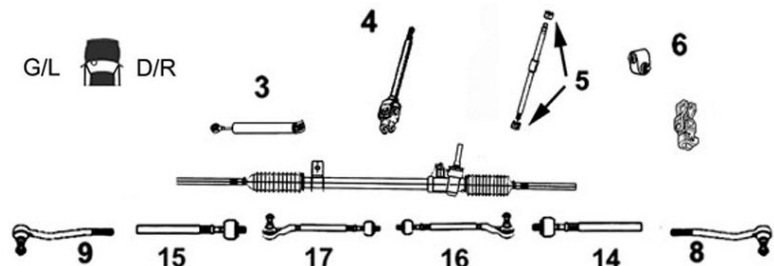

9006512

Rotule de direction G/D

OE H26032280

L/R tie rod end

8
9 M14 x 1.5

TT /all models	GC / GD	02/83-12/92
----------------	---------	-------------



...MAZDA 626

Bras & Triangle de suspension

Control arm
Brazo y triángulo
Wahacz
Рычаг подвески

G/L  D/R

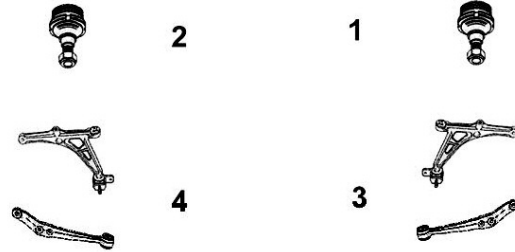

9005287

Rotule de susp. inf. G/D

OE G03099356

L/R lower suspension ball joint



1
2 Ø 18

TT /all models

GC / GD

02/83-12/92

Demio

Eléments DIRECTION

Steering parts
Elementos Direcciones
Elementy układ kierowniczy
Элементы рулевой системы

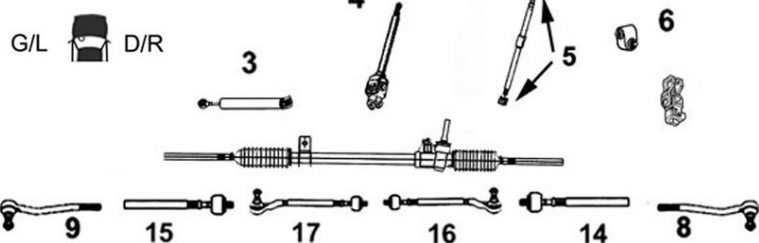

9006511

Rotule de direction G/D

OE B45532280

L/R tie rod end

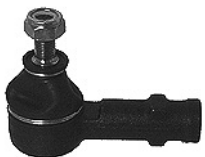

8
9 M12 x 1.25

1.3i

07/98-08/03

MAZDA



Série 124 12/84- ...



MERCEDES

Eléments DIRECTION

Steering parts

Elementos Direcciones

Elementy uklad kierowniczy

Элементы рулевой системы

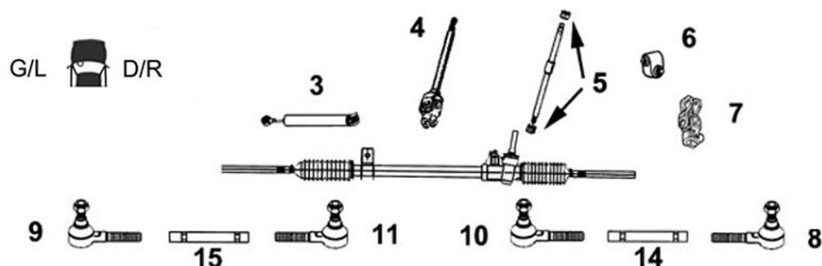

9006845

Bielle de direction G/D

OE 1243300803

L/R steering rod



8			
9			
10			
11			
14	2.0 W124	200	01/85-
15	2.0 W124	200E	01/91-
	2.0 C124	200E Coupé /Cab.	10/92-
	2.0 T124	200T/TE	
	2.0 D W124	200D	01/85-
	2.0 TD T124	200TD	
	2.2 W124	220E	01/91-
	2.2 C124	220CE E220 Coupé /Cab.	09/89-
	2.2 T124	220TE	10/91-
	2.3 W124	230	01/85-
	2.3 C124	230CE	
	2.3 T124	230E/TE	09/89-
	2.5 D W124	250D	01/85-
	2.5 D T124	250D	10/91-
	2.5 TD W124	250TD	01/85-
	2.6 W124	260	01/85-
	2.8 W124	280E	01/89-
	2.8 T124	280E/TE	10/91-
	3.0 W124	300E	
	3.0 C/T124	300CE/TE	
	3.0 D W124	300D	01/85-
	3.0 D T124	300D	
	3.0 TD W124	300TD	01/85-
	3.0 TD T124	300TD	09/89-
	3.2 W124	320E	01/89-
	3.2 C124	320CE 320E Coupé Cab.	10/91-
	3.2 T124	320TE	10/91-
	3.6 CE124	36 AMG	06/94-
	3.6 T124	36 AMG /Break /Cab. /Coupé	06/94-

9006529

Rotule de direction G/D Ext.

OE 0003385110

L/R outer tie rod end



8			
9			
	Filetage pas à droite Right-hand thread M14 x 1.5		
	3.0 C124	300CE/E24 Coupé Cab.	
	3.0 T124	300TE	-08/89
	3.0 T124	300TE/TE24	09/89-
	3.0 W124	300E	01/85-
	3.0 W124	300E24	01/89-
	3.0 W124	E300	01/91-
	3.0 D T124	300D	09/89-
	3.0 D W124	300D	01/85-
	3.0 D W124	E300D	01/91-
	3.0 TD T124	300TD	
	3.0 TD W124	300TD	01/85-
	3.2 C124	320CE Coupé Cab.	10/91-
	3.2 C124	E320 Coupé Cab.	10/91-
	3.2 T124	320TE	10/91-
	3.2 W124	320E	01/89-
	3.2 W124 T124	320E	01/91-
	3.6 AMG		05/94-
	3.6	T36 AMG Coupé Cab.	05/94-

... Série 124 12/84- ...

9006531

Rotule de direction G/D Int.

OE 0003385910

L/R inner tie rod end

10 Filetage pas à gauche *left-hand thread* M14 x 1.5
11



2.0 T124	200T/TE	-08/89
2.0 T124	200TE	10/91-
2.0 W124	200	01/85-
2.0 T124	200T/TE	09/89-
2.0 W124	200E	01/91-
2.0 W124/C124	200E /Coupé Cab.	01/91-
2.0 D W124	200D	01/85-
2.0 TD T124	200TD	09/89-
2.2 C124	220CE	09/89-
2.2 C124	E220 Coupé Cab.	10/91-
2.2 T124	220TE	10/91-
2.2 W124	220E	01/91-
2.3 C124	230CE Coupé	
2.3 T124	230E/TE	
2.3 W124	230	01/85-
2.5 D T124	250D	
2.5 D W124	250D	01/85-
2.5 TD W124	250TD	01/85-
2.6 W124	260	01/85-
2.8 T124	280TE	10/91-
2.8 W124	280E	01/89-
3.0 C124	300CE/24 Coupé Cab.	
3.0 T124	300TE	
3.0 W124	300E /E24	
3.0 W124	E300	01/91-
3.0 D T124	300D	09/89-
3.0 D W124	300D	01/85-
3.0 D W124	E300D	01/91-
3.0 TD T124	300TD	
3.0 TD W124	300TD	01/85-
3.2 C124	320CE Coupé Cab.	10/91-
3.2 T124	320TE	10/91-
3.2 W124	320E	01/89-
3.6 C124	36 AMG Coupé Cab.	04/94-
3.6 T124	36 AMG	04/94-

9006529

Rotule de direction G/D Ext.

OE 0003385110

L/R outer tie rod end

8 Filetage pas à droite *Right-hand thread* M14 x 1.5
9



2.0 W124	200/200E	01/85-
2.0 T124	200T/TE	
2.0 D W124	200D	01/85-
2.0 D T124	200TD	
2.2 W124	220E	01/91-
2.2 C124	E220 Coupé Cab.	10/91-
2.2 T124	220TE	10/91-
2.3 W124	230	01/85-
2.3 C124	230CE Coupé	
2.3 T124	230E/TE	
2.5 D W124	250D	01/85-
2.5 D T124	250D	
2.5 TD W124	250TD	01/85-
2.6 W124	260	01/85-
2.8 W124	280E	01/89-
2.8 T124	280E/TE	10/91-

... Série 124 12/84- ...



Eléments SUSPENSION

Suspension parts
Elementos suspensión
Elementy zawieszenie
Элементы подвески

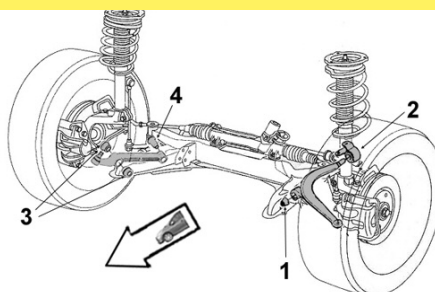

9001608

Articulation AV

OE 1243334214

Front bush



1

2.0	200E /TE
2.0 D	200D/TD
2.3	230E
2.5 D /TD	250D/TD
2.6	260E
3.0 D TD	300D
5.0	500E

Bras & Triangle de suspension

Control arm
Brazo y triángulo
Wahacz
Рычаг подвески

G/L D/R

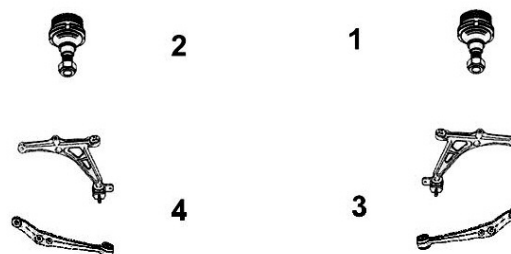

9005731

Triangle de suspension G

OE 1243303007

Left track control arm

4 Avec rotule With ball joint



TT /all models W124 Sauf Sport

200/D 230 260 300E	01/85-
200E 220E 280E	01/91-
250D/TD 300D/TD	01/85-
280E 300E24 320E	01/89-
320E E200 E250 E300/D	01/91-

TT /all models T124 Sauf Sport

200T/TD/TE 230E/TE	-08/89
200TE 220TE 280E/TE	10/91-
200T/TD/TE 230E/TE	09/89-
250D/T 260E	
300D/TD/TE/TE24	09/89-
300TD/TE	-08/89
320TE 250D/TD 300D/TD	10/91-

2.2 C124	220CE	sauf Sport	09/89-
2.2 C124	E220	Coupé Cab.	10/91-

2.3 C124	230CE	Coupé sauf Sport	
----------	-------	------------------	--

3.0 C124	300CE	Coupé sauf Sport	
3.0 C124	300CE24	Coupé Cab.	10/91-

3.2 C124	320CE	Coupé Cab.	10/91-
3.2 C124	E320	Coupé Cab.	10/91-

... Série 124 12/84- ...



9005732 Triangle de suspension D

OE 1243303107 *Right track control arm*

3 Avec rotule With ball joint



TT /all models W124 Sauf Sport

200/D 230 260 300E	01/85-
200E 220E 280E	01/91-
250D/TD 300D/TD	01/85-
280E 300E24 320E	01/89-
320E E200 E250 E300/D	01/91-

TT /all models T124 Sauf Sport

200T/TD/TE 230E/TE	-08/89
200TE 220TE 280E/TE	10/91-
200T/TD/TE 230E/TE	09/89-
250D/T 260E	
300D/TD/TE/TE24	09/89-
300TD/TE	-08/89
320TE 250D/TD 300D/TD	10/91-

2.2 C124	220CE	sauf Sport	09/89-
2.2 C124	E220	Coupé Cab.	10/91-

2.3 C124	230CE	Coupé sauf Sport	
----------	-------	------------------	--

3.0 C124	300CE	Coupé sauf Sport	
3.0 C124	300CE24	Coupé Cab.	10/91-

3.2 C124	320CE	Coupé Cab.	10/91-
3.2 C124	E320	Coupé Cab.	10/91-

9005289 Rotule de susp. inf. G/D

OE 124330327 *L/R lower suspension ball joint*

1 Sauf 4WD

2



TT /all models W124

200/D 230 260 300E	01/85-
200E 220E 280E 320E	01/91-
E200 E250/D E300/D	01/91-
280E 300 E24 320E	01/89-

TT /all models T124

200T/TD/TE 230E/TE	
200TE 220TE 280E/TE	10/91-
250D/TD 260E 300D/TD/TE	-08/89
250D/T 260E	09/89-
300D/TD/TE/TE24	09/89-
320TE 250D/TD 300D/TD	10/91-

2.2 C124	E220	Coupé Cab.	10/91-
----------	------	------------	--------

2.3 C124	230CE	Coupé	
----------	-------	-------	--

3.0 C124	300CE	Coupé	
3.0 C124	300CE24	Coupé Cab.	10/91-

3.2 C124	320CE	Coupé Cab.	10/91-
3.2 C124	E320	Coupé Cab.	10/91-

... Série 124 12/84- ...

SASIC

MERCEDÉS



Support d'amortisseur

Suspension mounting
Soporte amortiguador
Poduszka amortyzatora
Опора амортизатора

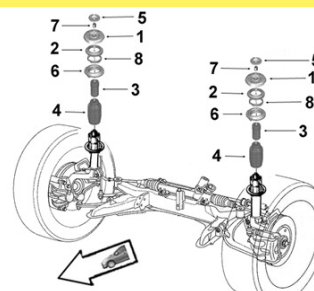

9001635

Support suspension AV G/D

OE 1243201444

L/R front susp. mounting

1



2.0	200CE	-06/98
2.0	200E	01/89-12/95
2.0	200TE	-12/95
2.0 D	200D	
2.0 TD	200	-07/93
2.2i	220CE/TE	09/89-
2.2i	220E	01/89-12/95
2.2i	230TE	-10/92
2.3i	230CE	09/89-
2.5 D	250	-07/93
2.5 D	250D /TD	07/93-
2.5 D	250TD	-07/93
2.5 TD	250D	
2.5 TD	250TD	-07/93
2.6i	260E	-10/92
2.8i	280E	01/89-12/95
2.8i	280TE	-12/95
3.0i 24v.	300E	-10/92
3.0i 24v.	300TE	-10/92
3.0i	300CE	09/89-
3.0i	300E /TE / 4-Matic	-12/95
3.0 D	300D/TD	
3.0 TD	300D /TD / 4-Matic	
3.2	320CE	09/89-
3.2	320E	01/89-12/95
3.2	320TE	-12/95
3.6i	36 AMG /Break /Cab. /Coupé	06/94-
4.2	420E	01/89-12/95
5.0	500E	01/89-12/95



Barre stabilisatrice

Stabilizer bar
Barra estabilizadora
Drażek stabilizatora
стабилизатор поперечной устойчивости

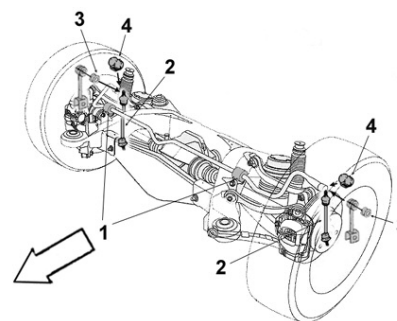

9005040

Biellette barre stab.

OE 1243200289

Stabilizer bar stub axle

2



2.0	200C/E/TE	
2.0 D	200D	
2.2	220C/E/TE	
2.8	280E/TE	
3.0	300E/TE 4Matic	
3.0 D	300E/TE D	
3.0 TD	300E/TE TD / 4-Matic	
3.2i	320E/C/TE	
4.2i	420E	
5.0i	500E	

9005072

Biellette barre stab.

OE 1243200489

Stabilizer bar stub axle

2



2.0	200E 200TE	
2.0 D	200TD	
2.2	220E	
2.5 D	250E /TE/TD	
2.5 TD	250E D	
2.6	260E	
2.8	280E	
3.0 D TD	300E D/TD /4 Matic	
3.2i	320E	
3.6i 36 AMG /Break /Cab. /Coupé	06/94-	

... Série 124 12/84- ...



Eléments SUSPENSION

Suspension parts

Elementos suspensión

Elementy zawieszenie

Элементы подвески

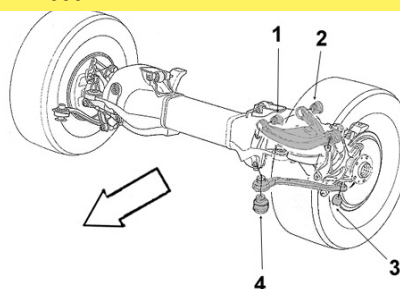

MERCEDES



9001606

Articulation inf.

OE 2023520165

Lower bush

4 Ø int.12 Ø ext.33 long. tube int.58 ext.45



2.0	200E 200TE
2.0 D	200D 200TD
2.2	220E
2.3	230E
2.5 D TD	250D 250TD
2.6	260E /4Matic
2.8	280E
3.0	300E
3.0 D TD	300D TD /4Matic
3.2	320E
4.2	420E
5.0	500E

Eléments TRAIN ARRIERE

Rear axle parts

Tren TRAS

Elementy zawieszenia tylnego

элементы задней оси.



9001605

Art. bielle de réaction AR

OE 2013528865

Rear track rod bush

Ø int.12 Ø ext.32 long. tube int.43 ext.35



2.0	200E
2.0	200T
2.0	200TE
2.0 D	200D
2.0 D	200TD
2.3	230E
2.5 D	250
2.5 D	250TD
2.5 TD	250TD
2.6	260E /4 Matic
2.8	280E
3.0	300E
3.0 D	300D /4Matic
3.0 D	300TD /4Matic
3.0 TD	300D /4Matic
3.0 TD	300TD /4Matic
3.2	320E
4.2	420E
5.0	500E

9005071

Art. bielle de réaction G/D

OE 2103520965

L/R track rod bush

Ø int. 12 Ø ext. 36 long. tube int.38 ext.30



2.0	200E
2.0	200T
2.0	200TE
2.0 D	200D
2.0 D	200TD
2.3	230E
2.5 D	250
2.5 D	250TD
2.5 TD	250D
2.5 TD	250TD
2.6	260E /4Matic
2.8	280E
3.0	300E
3.0 D	300D /4Matic
3.0 D	300TD
3.0 TD	300D /4Matic
3.0 TD	300TD /4Matic
3.2	320E
4.2	420E
5.0	500E

... Série 124 12/84- ...



MERCEDES

Eléments TRAIN ARRIERE

Rear axle parts

Tren TRAS

Elementy zawieszenia tylnego

элементы задней оси.





9005070 OE 2103503806	Bielle de réaction G/D <i>L/R track rod</i>	9005076 OE 2013505606	Bielle de réaction AR G/D <i>L/R rear track rod</i>
	2.0 200E /CE		2.0 200CE 200E 200TE
	2.0 200T/TE		2.0 D 200D 200TD
	2.0 D 200D 200TD		2.2 220CE 220E 220TE
	2.2 220CE 220E 220TE		2.3 230E
	2.2 220CE 220E 220TE		2.3 230E
	2.3 230E		2.5 D 250 250TD 250TE
	2.3 230E		2.5 D 250 250TD 250TE
	2.5 D 250 250TD 250TE		2.5 TD 250D 250TD
	2.5 D 250 250TD 250TE		2.5 TD 250D 250TD
	2.5 TD 250D 250TD		2.6 260E /4Matic
	2.5 TD 250D 250TD		2.6 260E /4Matic
	2.6 260E /4Matic		2.8 280E 280TE
	2.6 260E /4Matic		2.8 280E 280TE
	2.8 280E 280TE		3.0 300E/T /4Matic
	2.8 280E 280TE		3.0 300E/T /4Matic
	3.0 300E/T /4Matic		3.0 D 300D /4Matic
	3.0 300E/T /4Matic		3.0 D 300D /4Matic
	3.0 D 300D /4Matic		3.0 D 300TD /4Matic
	3.0 D 300D /4Matic		3.0 D 300TE D
	3.0 D 300TD /4Matic		3.0 TD 300D /4Matic
3.0 D 300TE D	3.0 TD 300D /4Matic		
3.0 TD 300D /4Matic	3.0 TD 300TD /4Matic		
3.0 TD 300D /4Matic	3.0 TD 300TE D /4Matic		
3.0 TD 300TD /4Matic	3.2 320E/CE/TE		
3.0 TD 300TE D /4Matic	3.2 320E/CE/TE		
3.2 320E/CE/TE	3.6i 36 AMG /Break /Cab. /Coupé		
3.2 320E/CE/TE	3.6i 36 AMG /Break /Cab. /Coupé		
3.6i 36 AMG /Break /Cab. /Coupé	4.2 420E		
3.6i 36 AMG /Break /Cab. /Coupé	4.2 420E		
4.2 420E	5.0 500E		
4.2 420E	5.0 500E		
5.0 500E			
5.0 500E			

9001604 OE 1243529065	Art. tirant de chasse <i>Rod bushing</i>	9001616 OE 1243511942	Silentbloc essieu AR ext. <i>Outer rear axle silentbloc</i>
	Ø int. 12 Ø ext. 36 long. tube int.38 ext.30		Ø int.12.5 Ø ext.67 coll.80 long. tube int.58 ext.36 ep. coll.8.5
	2.0 200CE		2.0 200CE
	2.0 200E		2.0 200E
	2.0 200T		2.0 200T
	2.0 200TE		2.0 200TE
	2.0 D 200D		2.0 200D
	2.0 D 200TD		2.0 D 200D
	2.0 D 200TD		2.0 D 200TD
	2.2 220CE		2.0 D 200TD
	2.2 220E		2.3 230E
	2.2 220TE		2.3 230E
	2.2 220TE		2.5 D 250
	2.5 D 250		2.5 D 250
	2.5 D 250TD		2.5 D 250TD
	2.5 D 250TD		2.5 TD 250D
	2.6 260E		2.5 TD 250D
	2.6 260E		2.6 260E /4Matic
	2.8 280E		3.0 300E /4Matic
	2.8 280E		3.0 300E /4Matic
	3.0 300E		3.0 D 300D
3.0 300E	3.0 D 300D /4Matic		
3.0 D 300D /4Matic	3.0 D 300TD /4Matic		
3.0 D 300D /4Matic	3.0 D 300TD /4Matic		
3.0 TD 300D /4Matic	3.0 TD 300D		
3.0 TD 300D /4Matic	3.0 TD 300D		
3.0 TD 300TD /4Matic	4.2 420E		
3.0 TD 300TD /4Matic	4.2 420E		
3.2 320E	5.0 500E		
3.2 320E	5.0 500E		

9001617 OE 1293511542	Silentbloc essieu AR <i>Rear axle silentbloc</i>
	2.6 260E /4Matic
	3.0 300E /4Matic
	3.0 TD 300TD
	3.0 TD 300TD
	3.2 320E

... Série 124 12/84-

9001615 OE 1243510242	Silentbloc essieu AR int. <i>Inner rear axle silentbloc</i>	9001622 OE 1243527765	Silentbloc pont AR <i>Rear axle silentbloc</i>																																																										
	<p>Ø int.17.5 Ø ext.82 coll.99 long. tube int.61 ext.45 ep. coll.6</p> <table style="width: 100%; border: none;"> <tr><td>2.0</td><td>200CE 200E 200T/TE</td></tr> <tr><td>2.0 D</td><td>200D 200TD</td></tr> <tr><td>2.3</td><td>230E</td></tr> <tr><td>2.5 D</td><td>250 /TD</td></tr> <tr><td>2.5 TD</td><td>250D/TD</td></tr> <tr><td>2.6</td><td>260E /4Matic</td></tr> <tr><td>3.0</td><td>300E /4Matic</td></tr> <tr><td>3.0 D</td><td>300D</td></tr> <tr><td>3.0 D</td><td>300TD /4Matic</td></tr> <tr><td>3.0 TD</td><td>300D</td></tr> <tr><td>3.0 TD</td><td>300TD /4Matic</td></tr> <tr><td>4.2</td><td>420E</td></tr> <tr><td>5.0</td><td>500E</td></tr> </table>	2.0	200CE 200E 200T/TE	2.0 D	200D 200TD	2.3	230E	2.5 D	250 /TD	2.5 TD	250D/TD	2.6	260E /4Matic	3.0	300E /4Matic	3.0 D	300D	3.0 D	300TD /4Matic	3.0 TD	300D	3.0 TD	300TD /4Matic	4.2	420E	5.0	500E		<p>Ø int.14 Ø ext.47 long. tube int.30 ext.30</p> <table style="width: 100%; border: none;"> <tr><td>2.0</td><td>200E 200T/TE 200CE</td></tr> <tr><td>2.0 D</td><td>200D 200TD</td></tr> <tr><td>2.3</td><td>230E</td></tr> <tr><td>2.5 D</td><td>250</td></tr> <tr><td>2.5 TD</td><td>250D</td></tr> <tr><td>2.6</td><td>260E</td></tr> <tr><td>2.8</td><td>280E</td></tr> <tr><td>3.0</td><td>300E</td></tr> <tr><td>3.0 D</td><td>300D/TD /4Matic</td></tr> <tr><td>3.0 TD</td><td>300D/TD /4Matic</td></tr> <tr><td>3.2</td><td>320E</td></tr> <tr><td>2.0</td><td>E200</td></tr> <tr><td>2.0 D</td><td>E200D</td></tr> <tr><td>2.5 D</td><td>E250D</td></tr> <tr><td>2.5 TD</td><td>E250D</td></tr> <tr><td>3.0 D</td><td>E300D</td></tr> </table>	2.0	200E 200T/TE 200CE	2.0 D	200D 200TD	2.3	230E	2.5 D	250	2.5 TD	250D	2.6	260E	2.8	280E	3.0	300E	3.0 D	300D/TD /4Matic	3.0 TD	300D/TD /4Matic	3.2	320E	2.0	E200	2.0 D	E200D	2.5 D	E250D	2.5 TD	E250D	3.0 D	E300D
2.0	200CE 200E 200T/TE																																																												
2.0 D	200D 200TD																																																												
2.3	230E																																																												
2.5 D	250 /TD																																																												
2.5 TD	250D/TD																																																												
2.6	260E /4Matic																																																												
3.0	300E /4Matic																																																												
3.0 D	300D																																																												
3.0 D	300TD /4Matic																																																												
3.0 TD	300D																																																												
3.0 TD	300TD /4Matic																																																												
4.2	420E																																																												
5.0	500E																																																												
2.0	200E 200T/TE 200CE																																																												
2.0 D	200D 200TD																																																												
2.3	230E																																																												
2.5 D	250																																																												
2.5 TD	250D																																																												
2.6	260E																																																												
2.8	280E																																																												
3.0	300E																																																												
3.0 D	300D/TD /4Matic																																																												
3.0 TD	300D/TD /4Matic																																																												
3.2	320E																																																												
2.0	E200																																																												
2.0 D	E200D																																																												
2.5 D	E250D																																																												
2.5 TD	E250D																																																												
3.0 D	E300D																																																												

Série 190 (201) 10/82-08/93 ...

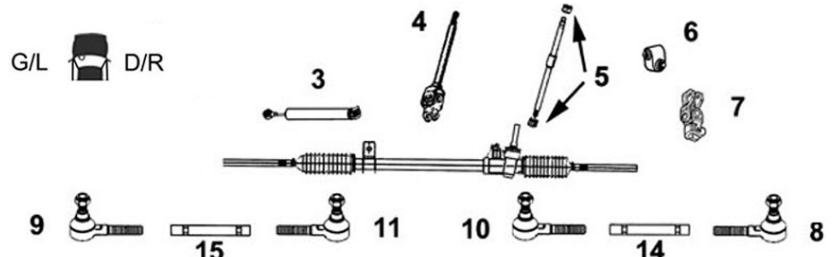

Eléments DIRECTION
Steering parts
Elementos Direcciones
Elementy układ kierowniczy
Элементы рулевой системы

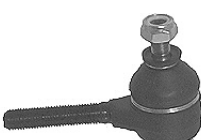

G/L D/R

7776012 OE 2014601505	Barre de direction <i>Centre rod assembly</i>																											
	<table style="width: 100%; border: none;"> <thead> <tr> <th style="text-align: left;">centrale</th> <th style="text-align: left;">middle</th> <th></th> </tr> </thead> <tbody> <tr><td>1.8i</td><td>190</td><td>07/90-06/93</td></tr> <tr><td>2.0</td><td>190</td><td>04/80-06/93</td></tr> <tr><td>2.0 D</td><td>190</td><td>12/83-06/93</td></tr> <tr><td>2.3i</td><td>190</td><td>07/84-06/93</td></tr> <tr><td>2.5i</td><td>190</td><td>09/88-06/93</td></tr> <tr><td>2.5 D</td><td>190</td><td>07/85-06/93</td></tr> <tr><td>2.5 TD</td><td>190</td><td>09/88-06/93</td></tr> <tr><td>2.6i</td><td>260</td><td>01/87-06/93</td></tr> </tbody> </table>	centrale	middle		1.8i	190	07/90-06/93	2.0	190	04/80-06/93	2.0 D	190	12/83-06/93	2.3i	190	07/84-06/93	2.5i	190	09/88-06/93	2.5 D	190	07/85-06/93	2.5 TD	190	09/88-06/93	2.6i	260	01/87-06/93
centrale	middle																											
1.8i	190	07/90-06/93																										
2.0	190	04/80-06/93																										
2.0 D	190	12/83-06/93																										
2.3i	190	07/84-06/93																										
2.5i	190	09/88-06/93																										
2.5 D	190	07/85-06/93																										
2.5 TD	190	09/88-06/93																										
2.6i	260	01/87-06/93																										

9006533 OE 0003386010	Rotule de direction int. G <i>Left inner tie rod end</i>	9006534 OE 0003386310	Rotule de direction Int. D <i>Right inner tie rod end</i>
	<p>11 Filetage pas à gauche left-hand thread M12 x 1.5</p> <p>TT /all models 01/82-</p>		<p>10 Filetage pas à droite Right-hand thread M12 x 1.5</p> <p>TT /all models 01/82-</p>

9006538 OE 0003386110	Rotule de direction Ext. G <i>Left outer tie rod end</i>	9006533 OE 0003386210	Rotule de direction Ext. D <i>Right outer tie rod end</i>
	<p>9 Filetage pas à droite Right-hand thread M12 x 1.5</p> <p>TT /all models 01/82-</p>		<p>8 Filetage pas à gauche left-hand thread M12 x 1.5</p> <p>TT /all models 01/82-</p>

... Série 190 (201) 10/82-08/93 ...

MERCEDES



Bras & Triangle de suspension

Control arm
Brazo y triángulo
Wahacz
Рычаг подвески

G/L D/R

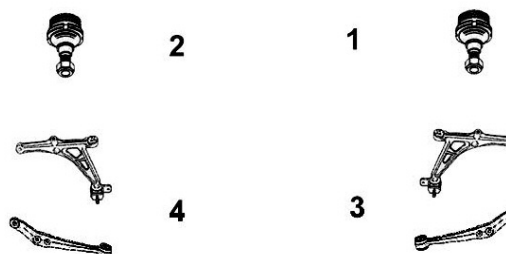

9005729 Triangle de suspension G

OE 1243303807

Left track control arm



4 Avec rotule With ball joint

TT /all models 01/82-

9005730 Triangle de suspension D

OE 1243303907

Right track control arm



3 Avec rotule With ball joint

TT /all models 01/82-

9005289 Rotule de susp. inf. G/D

OE 1243330327

L/R lower suspension ball joint



1
2

TT /all models 01/82-



Support d'amortisseur

Suspension mounting
Soporte amortiguador
Poduszka amortyzatora
Опора амортизатора

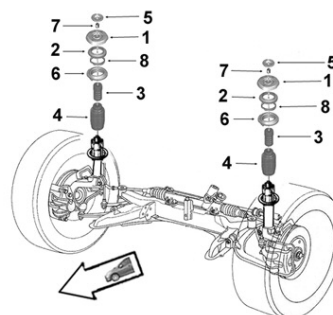

9001636 Support suspension G/D

OE 2013202444

L/R suspension mounting



1

1.8	190E
2.3	190E
2.3i 16v.	190E
2.5 D	190
2.5 TD	190
2.6	190E
3.2	190E AMG

9001619 Silentbloc AV

OE 2023510842

Front silentbloc



1.8	190E
2.0 D	190D
2.3	190E
2.5 D	190
2.5 TD	190
2.6	190E



Eléments TRAIN ARRIERE

Rear axle parts
Tren TRAS
Elementy zawieszenia tylnego
элементы задней оси.

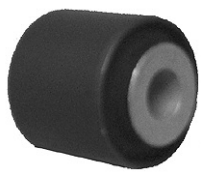

... Série 190 (201) 10/82-08/93

9001618 OE 2013512842	Silentbloc AR <i>Rear silentbloc</i>	9001604 OE 1243529065	Art. tirant de chasse sup. <i>Upper rod bushing</i>
	H69 1.8 190E 09/88- 2.0 D 190D 09/88- 2.3 190E 09/88- 2.5 D 190 09/88- 2.5 TD 190 09/88- 2.6 190E 09/88-		Ø int. 12 Ø ext. 36 long. tube int. 38 ext. 30 2.3 190E 2.5 D 190 2.5 TD 190 2.6 190E

9001605 OE 2013528865	Art. bielle de réaction AR milieu <i>Middle rear track rod bush</i>	9005076 OE 2013505606	Bielle de réaction AR G/D sup. <i>L/R Rear Uupper track rod</i>
	Ø int.12 Ø ext.32 long. tube int.43 ext.35 1.8 190E 2.0 190E 2.0 D 190D 2.3 190E 2.5 D 190 2.5 TD 190 2.6 190E		1.8 190E 2.3 190E 2.5 D 190 2.5 TD 190 2.6 190E

9005070 OE 2103503806	Bielle de réaction G/D inf. <i>Lower L/R track rod</i>		
	1.8 190E 2.3 190E 2.5 D 190 2.5 TD 190 2.6 190E		

Classe A (168) 07/97- ...

Eléments DIRECTION

Steering parts



Elementos Direcciones

Elementy uklad kierowniczy

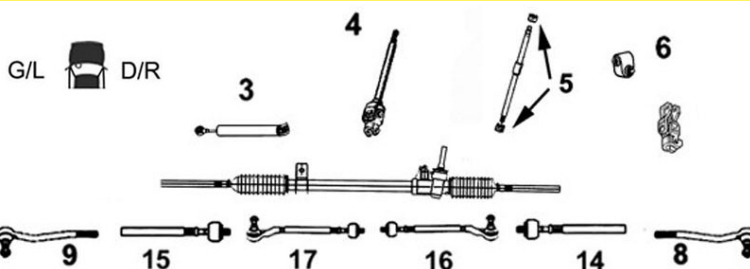
Элементы рулевой системы



9006842 Part/oe 1683301335	Axe de bielle G/D <i>L/R axial joint</i>		
	14 15 Côté dir. M14x1.5 Côté rot. M12x1.5 long 197 mm		
	1.4i 140 /Family 1.6i 160 F/amily 1.7 CDi 160 1.7 CDi 170 /Family 1.9i 190 /Family 2.1i 210 /Family	BVM BVA BVM BVA BVM BVA BVM BVA BVM BVA BVM BVA	-09/04 -09/04 03/01-09/04 -09/04 -09/04 01/01-09/04

9006682 OE 1683301135	Rotule de direction G <i>Left tie rod end</i>	9006683 OE 1683301235	Rotule de direction D <i>Right tie rod end</i>
	9 M12 x 1.5 1.4i 140 /Family BVM BVA -09/04 1.6i 160 /Family BVM BVA -09/04 1.7 CDi 160 BVM BVA 03/01-09/04 1.7 CDi 170 /Family BVM BVA -09/04 1.9i 190 /Family BVM BVA -09/04 2.1i 210 /Family BVM BVA 01/01-09/04		8 M12 x 1.5 1.4i 140 /Family BVM BVA -09/04 1.6i 160 /Family BVM BVA -09/04 1.7 CDi 160 BVM BVA 03/01-09/04 1.7 CDi 170 /Family BVM BVA -09/04 1.9i 190 /Family BVM BVA -09/04 2.1i 210 /Family BVM BVA 01/01-09/04

... Classe A (168) 07/97- ...

SASIC

MERCEDDES



Barre stabilisatrice
 Stabilizer bar
 Barra estabilizadora
 Drażek stabilizatora
 стабилизатор поперечной устойчивости

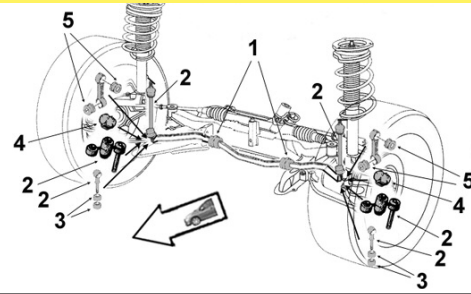

2306034 **Biellette barre stab.**
 OE 1683201189 *Stabilizer bar stub axle*



2	1.4i	140	01/98-09/04
	1.6i	160	01/98-09/04
	1.7 CDi	160 170	07/98-09/04
	1.9i	190	06/99-09/04
	2.1i		02/02-09/04



Eléments SUSPENSION
 Suspension parts
 Elementos suspensión
 Elementy zawieszenie
 Элементы подвески

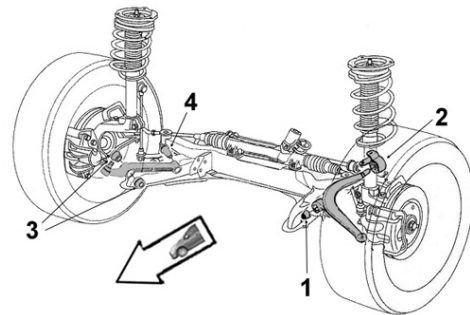

2256024 **Articulation AV**
 OE 1683330714 *Front bush*



1	Ø int. 12 Ø ext. 40.5 Coll. 42 long. tube int. 70.5 ext 52		
	1.4i	140	01/98-09/04
	1.6i	160	01/98-09/04
	1.7 CDi	160 /170	07/98-09/04
	1.9i	190	06/99-09/04
	2.1i		02/02-09/04

2256025 **Articulation AR**
 OE 1683330614 *Rear bush*



2	Ø int. 12.5 Ø ext. 60.5 Coll. 72 long. tube int. 52.5 ext. 30		
	1.4i	140	01/98-09/04
	1.6i	160	01/98-09/04
	1.7 CDi	160 /170	07/98-09/04
	1.9i	190	06/99-09/04
	2.1i		02/02-09/04

Bras & Triangle de suspension

Control arm
 Brazo y triángulo
 Wahacz
 Рычаг подвески

G/L D/R

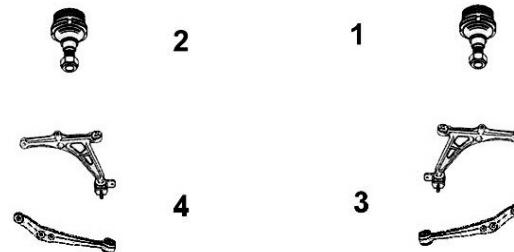

9005743 **Triangle de susp. inf. G**
 OE 1683301107 *Lower left track control arm*



4	Sans rotule Without ball joint	
	1.4i 140 /Family	BVM BVA -09/04
	1.6i 160 /Family	BVM BVA -09/04
	1.7 CDi 160 /Family	BVM BVA 03/01-09/04
	1.7 CDi 170 /Family	BVM BVA -09/04
	1.9i 190 /Family	BVM BVA -09/04
	2.1i 210 /Family	BVM BVA 01/01-09/04

9005742 **Triangle de susp. inf. D**
 OE 1683301207 *Lower right track control arm*



3	Sans rotule Without ball joint	
	1.4i 140 /Family	BVM BVA -09/04
	1.6i 160 /Family	BVM BVA -09/04
	1.7 CDi 160 /Family	BVM BVA 03/01-09/04
	1.7 CDi 170 /Family	BVM BVA -09/04
	1.9i 190 /Family	BVM BVA -09/04
	2.1i 210 /Family	BVM BVA 01/01-09/04

...Classe A (168) 07/97-

7476185	Triangle de susp. inf. G	7476187	Triangle de susp. inf. D
OE 1683302307+1683330227 <i>Lower left track control arm</i>		OE 1683302407+1683330227 <i>Lower right track control arm</i>	
NEW 	4 Avec rotule With ball joint 1.4i 140 /Family -09/04 1.6i 160 /Family -09/04 1.7 CDi 160 /Family 03/01-09/04 1.7 CDi 170 /Family -09/04 1.9i 190 /Family -09/04 2.1i 210 /Family 01/01-09/04	NEW 	3 Avec rotule With ball joint 1.4i 140 /Family -09/04 1.6i 160 /Family -09/04 1.7 CDi 160 /Family 03/01-09/04 1.7 CDi 170 /Family -09/04 1.9i 190 /Family -09/04 2.1i 210 /Family 01/01-09/04

9005533	Rotule de susp. inf. G/D		
OE 1683330227 <i>L/R lower suspension ball joint</i>			
	1 2 1.4i 140 /Family -09/04 1.6i 160 /Family -09/04 1.7 CDi 160 /Family -09/04 1.7 CDi 170 /Family -09/04 1.9i 190 /Family -09/04 2.1i 210 /Family -09/04		



Eléments SUSPENSION

Suspension parts
Elementos suspensión
Elementy zawieszenia
Элементы подвески

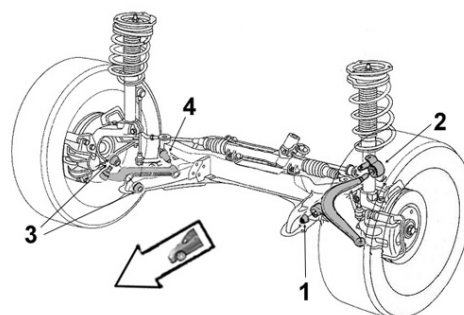



2656058	Ensemble suspension		
OE 1683200373 <i>Suspension assembly</i>			
	1 2 3 4 1.4i 140 -09/04 1.6i 160 -09/04 1.7 CDi 160 -09/04 1.7 CDi 170 -09/04 1.9i 190 -09/04 2.1i 210 -09/04		

Classe A (169) 07/04- ...

Eléments DIRECTION

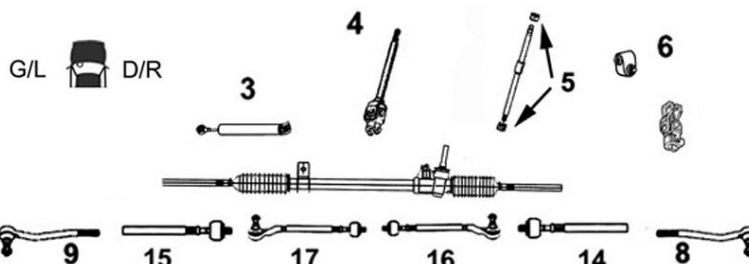
Steering parts
Elementos Direcciones
Elementy układ kierowniczy
Элементы рулевой системы



7776069	Axe de bielle G/D	7776074	Axe de bielle G/D
Part/oe 1693300403 <i>L/R axial joint</i>		Part/oe 1693300803 <i>L/R axial joint</i>	
NEW 	14 15 Côté rot. M14x1.5 long 204 mm 1.5i 150 -ch J 126739 -31/03/05 1.7i 170 -ch J 126739 -31/03/05 2.0i 200 -ch J 126739 -31/03/05 2.0 CDi 160 180 200 FAP -ch J 126739 -31/03/05	NEW 	14 15 Côté rot. M14x1.5 long 204 mm Electric 01/11-06/12 1.5i 150 Ch- J 126740 31/03/05- 1.7i 170 Ch- J 126740 31/03/05- 2.0i 200 Ch- J 126740 31/03/05- 2.0i Turbo 200 07/05- 2.0 CDi 160 180 200 FAP Ch- J 126740 31/03/05-

... Classe A (169) 07/04- ...

SASIC

MERCEDÉS

Eléments DIRECTION
Steering parts
Elementos Direcciones
Elementy układ kierowniczy
Элементы рулевой системы

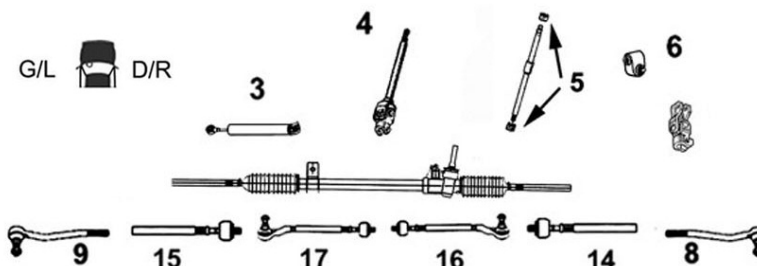

7676034 **Rotule de direction G**
 OE 1693300503 *Left tie rod end*



9	M14 x 1.5		
	1.5i	150	12/04-
	1.7i	170	12/04-
	2.0i	200	09/04-
	2.0i Turbo	200	07/05-
	2.0 CDi	160 180 200	09/04-
	Electric		01/11-06/12

7676033 **Rotule de direction D**
 OE 1693300603 *Right tie rod end*



8	M14 x 1.5		
	1.5i	150	12/04-
	1.7i	170	12/04-
	2.0i	200	09/04-
	2.0i Turbo	200	07/05-
	2.0 CDi	160 180 200	09/04-
	Electric		01/11-06/12



Barre stabilisatrice
Stabilizer bar
Barra estabilizadora
Drażek stabilizatora
стабилизатор поперечной устойчивости

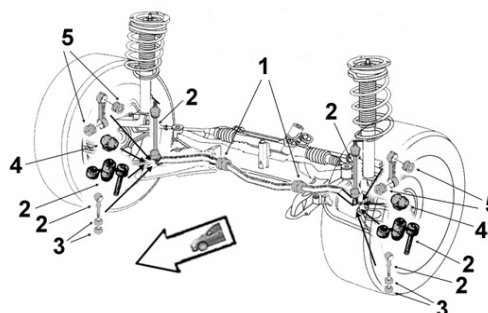

2306035 **Biellette barre stab.**
 OE 1693200989 *Stabilizer bar stub axle*



2			
	1.5i	150	09/04-
	1.7i	170	09/04-
	2.0i	200	09/04-
	2.0i Turbo	200	07/05-
	2.0 CDi		09/04-
	Electric		01/11-

Bras & Triangle de suspension
Control arm
Brazo y triángulo
Wahacz
Рычаг подвески

G/L D/R

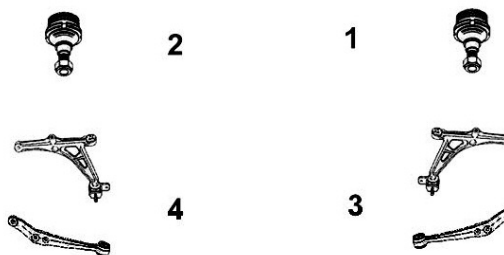

7476154 **Triangle de susp. G**
 OE 1693300907 *Left track control arm*



4	Avec rotule With ball joint		
	1.5i	150	09/04-06/12
	1.7i	170	09/04-06/12
	2.0i	200	09/04-06/12
	2.0i Turbo	200	09/04-06/12
	2.0 CDi /FAP	160 180 200	09/04-06/12
	Electric		01/11-06/12

7476153 **Triangle de susp. D**
 OE 1693301007 *Right track control arm*



3	Avec rotule With ball joint		
	1.5i	150	09/04-06/12
	1.7i	170	09/04-06/12
	2.0i	200	09/04-06/12
	2.0i Turbo	200	09/04-06/12
	2.0 CDi /FAP	160 180 200	09/04-06/12
	Electric		01/11-06/12

... Classe A (169) 07/04-

7576028

Rotule de susp. G/D

OE 1693330127

L/R suspension ball joint

NEW



1
2

1.5i	150	09/04-06/12
1.7i	170	09/04-06/12
2.0i	200	09/04-06/12
2.0i Turbo	200	07/05-06/12
2.0 CDi	160 180 200	09/04-06/12
Electric		01/11-06/12



Support d'amortisseur

Suspension mounting
Soporte amortiguador
Poduszka amortyzatora
Опора амортизатора

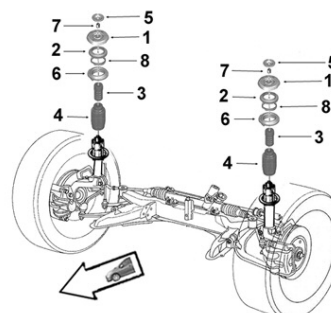

2656047

Support suspension

OE 169320007328

Suspension mounting

1



1.5i	150	09/04-
1.7i	170	09/04-
2.0i	200	09/04-
2.0i Turbo	200	07/05-
2.0 CDi	160 180 200	09/04-



Barre stabilisatrice

Stabilizer bar
Barra estabilizadora
Drażek stabilizatora
стабилизатор поперечной устойчивости

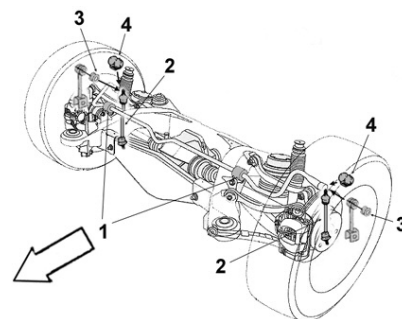

2306045

Biellette barre stab.

OE 1693200589

Stabilizer bar stub axle

2



1.5i	150	12/04-
1.7i	170	12/04-
2.0i	200	12/04-
2.0i Turbo	200	07/05-
2.0 CDi		09/04-
Electric		01/11-

Classe B (245) 05/05- ...

SASIC

MERCEDÉS

Eléments DIRECTION

Steering parts
Elementos Direcciones
Elementy układ kierowniczy
Элементы рулевой системы

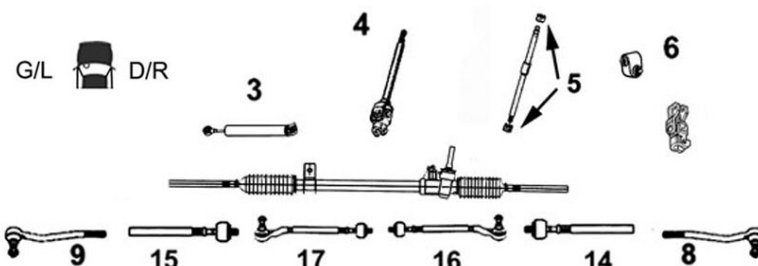

7776074 Axe de bielle G/D

Part/oe 1693300803 L/R axial joint

NEW



14 Côté rot. M14x1.5 long 204 mm

15			
1.5i	150		06/05-09/11
1.7i	170		06/05-09/11
2.0i	200		06/05-09/11
2.0i GNV	150 170		10/08-09/11
2.0i Turbo	200		06/05-09/11
2.0 CDi 16v. FAP	200		06/05-09/11
2.0 CDi FAP	180		06/05-09/11

7676034 Rotule de direction G

OE 1693300503 Left tie rod end



9 M14 x 1.5

1.5i	150	06/05-
1.7i	170	06/05-
2.0i	200	06/05-
2.0i GNV	150 170	10/08-
2.0i Turbo	200	06/05-
2.0 CDi	180 200	06/05-

7676033 Rotule de direction D

OE 1693300603 Right tie rod end



8 M14 x 1.5

1.5i	150	06/05-
1.7i	170	06/05-
2.0i	200	06/05-
2.0i GNV	150 170	10/08-
2.0i Turbo	200	06/05-
2.0 CDi	180 200	06/05-



Barre stabilisatrice

Stabilizer bar
Barra estabilizadora
Drażek stabilizatora
стабилизатор поперечной устойчивости

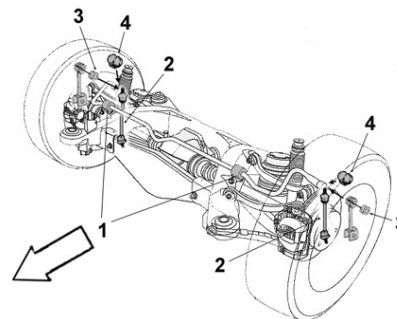

2306035 Bielle barre stab. G/D

OE 1693200989 L/R stabilizer bar stub axle



2

-ch J210986

1.5i	150	06/05-
1.7i	170	06/05-
2.0i	200	06/05-
2.0i GNV	150 170	10/08-
2.0i Turbo	200	06/05-
2.0 CDi 180	200	06/05-

... Classe B (245) 05/05- ...

Bras & Triangle de suspension

Control arm
Brazo y triángulo
Wahacz
Рычаг подвески

G/L  D/R

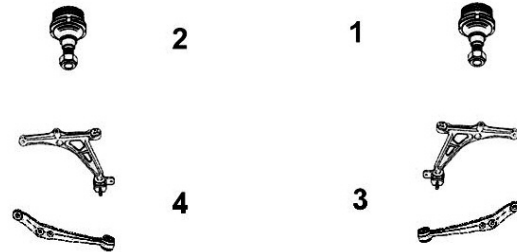

7476154

Triangle de susp. G

OE 1693300907

Left track control arm

NEW



4 Avec rotule With ball joint

1.5i	150	06/05-09/11
1.7i	170	06/05-09/11
2.0i	200	06/05-09/11
2.0i GNV	150 170	10/08-09/11
2.0i Turbo	200	06/05-09/11
2.0 CDi FAP	180 200	06/05-09/11

7476153

Triangle de susp. D

OE 1693301007

Right track control arm

NEW



3 Avec rotule With ball joint

1.5i	150	06/05-09/11
1.7i	170	06/05-09/11
2.0i	200	06/05-09/11
2.0i GNV	150 170	10/08-09/11
2.0i Turbo	200	06/05-09/11
2.0 CDi FAP	180 200	06/05-09/11

7576028

Rotule de susp. G/D

OE 1693330127

L/R suspension ball joint

NEW



1
2

1.5i	150	06/05-09/11
1.7i	170	06/05-09/11
2.0i	200	06/05-09/11
2.0i GNV	150 170	10/08-09/11
2.0i Turbo	200	06/05-09/11
2.0 CDi 180	200	06/05-09/11



Support d'amortisseur

Suspension mounting
Soporte amortiguador
Poduszka amortyzatora
Опора амортизатора

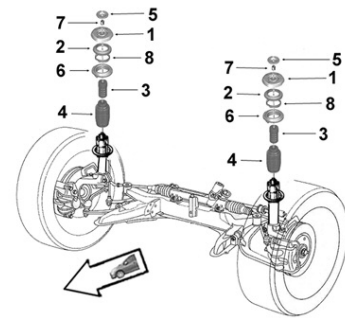

2656047

Support suspension

OE 169320007328

Suspension mounting

1



1.5i	150	06/05-09/11
1.7i	170	06/05-09/11
2.0i	200	06/05-09/11
2.0i GNV	150 170	10/08-09/11
2.0i Turbo	200	06/05-09/11
2.0 CDi	180 200	06/05-09/11

... Classe B (245) 05/05-



Barre stabilisatrice

Stabilizer bar

Barra estabilizadora

Drażek stabilizatora

стабилизатор поперечной устойчивости

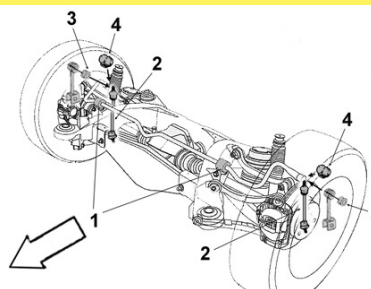

2306045

Biellette barre stab. G/D

OE 1693200589

L/R stabilizer bar stub axle

2



1.5i	150	06/05-
1.7i	170	06/05-
2.0i	200	06/05-
2.0i GNV	150 170	10/08-
2.0i Turbo	200	06/05-
2.0 CDi	180 200	06/05-

Classe C (202) 03/93- ...

Eléments DIRECTION

Steering parts

Elementos Direcciones

Elementy układ kierowniczy

Элементы рулевой системы

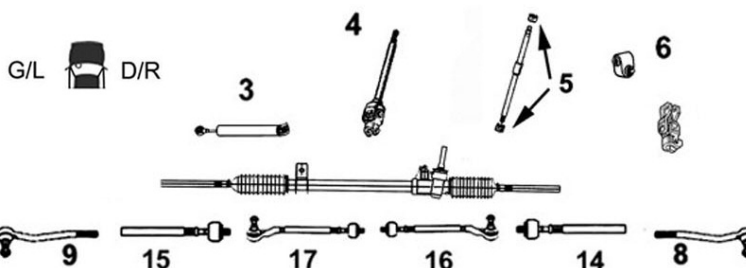

9006530

Rotule de direction G/D

OE 0013307735

L/R tie rod end

8

M12 x 1.5

9



1.8i	180	06/93-
2.0i	200	06/93-
2.0 D	200	06/93-
2.2i	220	06/93-
2.2 CDi	200 220 /Break	03/98-
2.2 D	220	06/93-
2.3i	230 /Komp /Break	09/95-
2.4i	240 /Break	06/97-
2.5 D	250	06/93-
2.5 TD	250 /Break	09/95-
2.8i	280	06/93-
3.6i	C36 AMG	05/94-
4.3i	C43 AMG /Break	08/97-

... Classe C (202) 03/93- ...



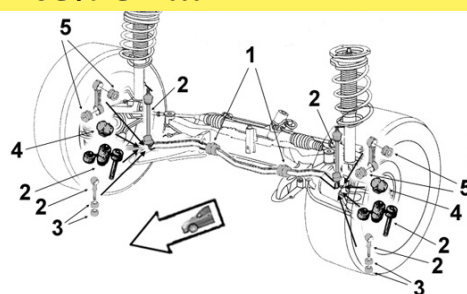

Barre stabilisatrice
 Stabilizer bar
 Barra estabilizadora
 Drażek stabilizatora
 стабилизатор поперечной устойчивости







MERCEDES





9001797 OE 1243234985	Palier de barre milieu <i>Middle bar main bearing</i>																								
	<p>1 Ø 18</p> <table border="0"> <tr><td>1.8i /Break</td><td>180</td><td></td></tr> <tr><td>2.0i</td><td>200</td><td></td></tr> <tr><td>2.0 D</td><td>200</td><td></td></tr> <tr><td>2.2i</td><td>220</td><td></td></tr> <tr><td>2.2 D</td><td>220</td><td></td></tr> <tr><td>2.3i</td><td>230</td><td>BVM</td></tr> <tr><td>2.5 D TD</td><td>250</td><td></td></tr> <tr><td>2.8i</td><td>280</td><td></td></tr> </table>	1.8i /Break	180		2.0i	200		2.0 D	200		2.2i	220		2.2 D	220		2.3i	230	BVM	2.5 D TD	250		2.8i	280	
1.8i /Break	180																								
2.0i	200																								
2.0 D	200																								
2.2i	220																								
2.2 D	220																								
2.3i	230	BVM																							
2.5 D TD	250																								
2.8i	280																								

9001796 OE 2023230285	Palier de barre milieu <i>Middle bar main bearing</i>																								
	<p>1 Ø 23</p> <table border="0"> <tr><td>1.8i</td><td>180 /Break</td><td>sauf Sport</td></tr> <tr><td>2.0i</td><td>200</td><td>sauf Sport</td></tr> <tr><td>2.0 D</td><td>200</td><td>sauf Sport</td></tr> <tr><td>2.2i</td><td>220</td><td>sauf Sport</td></tr> <tr><td>2.2 D</td><td>220</td><td>sauf Sport</td></tr> <tr><td>2.3i 2</td><td>30</td><td>sauf Sport BVM</td></tr> <tr><td>2.5 D</td><td>250</td><td>sauf Sport</td></tr> <tr><td>2.8i</td><td>280</td><td>sauf Sport</td></tr> </table>	1.8i	180 /Break	sauf Sport	2.0i	200	sauf Sport	2.0 D	200	sauf Sport	2.2i	220	sauf Sport	2.2 D	220	sauf Sport	2.3i 2	30	sauf Sport BVM	2.5 D	250	sauf Sport	2.8i	280	sauf Sport
1.8i	180 /Break	sauf Sport																							
2.0i	200	sauf Sport																							
2.0 D	200	sauf Sport																							
2.2i	220	sauf Sport																							
2.2 D	220	sauf Sport																							
2.3i 2	30	sauf Sport BVM																							
2.5 D	250	sauf Sport																							
2.8i	280	sauf Sport																							

Bras & Triangle de suspension Control arm Brazo y triángulo Wahacz Рычаг подвески	G/L  D/R	 2 4	 1 3
--	---	--	--

9005736 OE 1703300107	Triangle de suspension G Inf. <i>Left lower track control arm</i>																																																				
	<p>4 Sans rotule Without tie rod end</p> <table border="0"> <tr><td>1.8i</td><td>180</td><td>sauf Sport</td><td>06/93-</td></tr> <tr><td>2.0i</td><td>200</td><td>sauf Sport</td><td>06/93-</td></tr> <tr><td>2.0 D</td><td>200</td><td>sauf Sport</td><td>06/93-</td></tr> <tr><td>2.2i</td><td>220</td><td>sauf Sport</td><td>06/93-</td></tr> <tr><td>2.2 CDi</td><td>220</td><td>/Break</td><td>sauf Sport 06/93-03/98-</td></tr> <tr><td>2.2 D</td><td>220</td><td>sauf Sport</td><td>06/93-</td></tr> <tr><td>2.3i</td><td>230</td><td>/Komp/Break</td><td>sauf Sport 09/95-</td></tr> <tr><td>2.4i</td><td>240</td><td>/Break</td><td>sauf Sport 06/97-</td></tr> <tr><td>2.5 D</td><td>250</td><td>sauf Sport</td><td>06/93-</td></tr> <tr><td>2.5 TD</td><td>250</td><td>/Break</td><td>sauf Sport 09/95-</td></tr> <tr><td>2.8i</td><td>280</td><td>sauf Sport</td><td>06/93-</td></tr> <tr><td>3.6i</td><td>C36 AMG</td><td></td><td>05/94-</td></tr> <tr><td>4.3i</td><td>C43 AMG</td><td></td><td>08/96-</td></tr> </table>	1.8i	180	sauf Sport	06/93-	2.0i	200	sauf Sport	06/93-	2.0 D	200	sauf Sport	06/93-	2.2i	220	sauf Sport	06/93-	2.2 CDi	220	/Break	sauf Sport 06/93-03/98-	2.2 D	220	sauf Sport	06/93-	2.3i	230	/Komp/Break	sauf Sport 09/95-	2.4i	240	/Break	sauf Sport 06/97-	2.5 D	250	sauf Sport	06/93-	2.5 TD	250	/Break	sauf Sport 09/95-	2.8i	280	sauf Sport	06/93-	3.6i	C36 AMG		05/94-	4.3i	C43 AMG		08/96-
1.8i	180	sauf Sport	06/93-																																																		
2.0i	200	sauf Sport	06/93-																																																		
2.0 D	200	sauf Sport	06/93-																																																		
2.2i	220	sauf Sport	06/93-																																																		
2.2 CDi	220	/Break	sauf Sport 06/93-03/98-																																																		
2.2 D	220	sauf Sport	06/93-																																																		
2.3i	230	/Komp/Break	sauf Sport 09/95-																																																		
2.4i	240	/Break	sauf Sport 06/97-																																																		
2.5 D	250	sauf Sport	06/93-																																																		
2.5 TD	250	/Break	sauf Sport 09/95-																																																		
2.8i	280	sauf Sport	06/93-																																																		
3.6i	C36 AMG		05/94-																																																		
4.3i	C43 AMG		08/96-																																																		

9005737 OE 1703300207	Triangle de suspension D Inf. <i>Right lower track control arm</i>																																																				
	<p>3 Sans rotule Without tie rod end</p> <table border="0"> <tr><td>1.8i</td><td>180</td><td>sauf Sport</td><td>06/93-</td></tr> <tr><td>2.0i</td><td>200</td><td>sauf Sport</td><td>06/93-</td></tr> <tr><td>2.0 D</td><td>200</td><td>sauf Sport</td><td>06/93-</td></tr> <tr><td>2.2i</td><td>220</td><td>sauf Sport</td><td>06/93-</td></tr> <tr><td>2.2 CDi</td><td>220</td><td>/Break</td><td>sauf Sport 06/93-03/98-</td></tr> <tr><td>2.2 D</td><td>220</td><td>sauf Sport</td><td>06/93-</td></tr> <tr><td>2.3i</td><td>230</td><td>/Komp/Break</td><td>sauf Sport 09/95-</td></tr> <tr><td>2.4i</td><td>240</td><td>/Break</td><td>sauf Sport 06/97-</td></tr> <tr><td>2.5 D</td><td>250</td><td>sauf Sport</td><td>06/93-</td></tr> <tr><td>2.5 TD</td><td>250</td><td>/Break</td><td>sauf Sport 09/95-</td></tr> <tr><td>2.8i</td><td>280</td><td>sauf Sport</td><td>06/93-</td></tr> <tr><td>3.6i</td><td>C36 AMG</td><td></td><td>05/94-</td></tr> <tr><td>4.3i</td><td>C43 AMG</td><td></td><td>08/96-</td></tr> </table>	1.8i	180	sauf Sport	06/93-	2.0i	200	sauf Sport	06/93-	2.0 D	200	sauf Sport	06/93-	2.2i	220	sauf Sport	06/93-	2.2 CDi	220	/Break	sauf Sport 06/93-03/98-	2.2 D	220	sauf Sport	06/93-	2.3i	230	/Komp/Break	sauf Sport 09/95-	2.4i	240	/Break	sauf Sport 06/97-	2.5 D	250	sauf Sport	06/93-	2.5 TD	250	/Break	sauf Sport 09/95-	2.8i	280	sauf Sport	06/93-	3.6i	C36 AMG		05/94-	4.3i	C43 AMG		08/96-
1.8i	180	sauf Sport	06/93-																																																		
2.0i	200	sauf Sport	06/93-																																																		
2.0 D	200	sauf Sport	06/93-																																																		
2.2i	220	sauf Sport	06/93-																																																		
2.2 CDi	220	/Break	sauf Sport 06/93-03/98-																																																		
2.2 D	220	sauf Sport	06/93-																																																		
2.3i	230	/Komp/Break	sauf Sport 09/95-																																																		
2.4i	240	/Break	sauf Sport 06/97-																																																		
2.5 D	250	sauf Sport	06/93-																																																		
2.5 TD	250	/Break	sauf Sport 09/95-																																																		
2.8i	280	sauf Sport	06/93-																																																		
3.6i	C36 AMG		05/94-																																																		
4.3i	C43 AMG		08/96-																																																		

9005733 OE 2023304807	Triangle de suspension G Sup. <i>Upper left track control arm</i>																																												
	<p>4 Avec rotule With ball joint</p> <table border="0"> <tr><td>1.8i</td><td>C/180</td><td>Sauf Sport</td><td>06/93-</td></tr> <tr><td>2.0i</td><td>200</td><td>Sauf Sport</td><td>06/93-</td></tr> <tr><td>2.0 D</td><td>200</td><td>Sauf Sport</td><td>06/93-</td></tr> <tr><td>2.2i</td><td>220</td><td>Sauf Sport</td><td>06/93-</td></tr> <tr><td>2.2 CDi</td><td>200</td><td>220</td><td></td></tr> <tr><td>2.2 D</td><td>220</td><td>Sauf Sport</td><td>06/93-</td></tr> <tr><td>2.3i</td><td>230</td><td>Komp</td><td>09/95-</td></tr> <tr><td>2.4i</td><td>240</td><td></td><td>06/97-</td></tr> <tr><td>2.5 D</td><td>250</td><td>Sauf Sport</td><td>06/93-</td></tr> <tr><td>2.5 TD</td><td>250</td><td></td><td>09/95-</td></tr> <tr><td>2.8i</td><td>280</td><td>Sauf Sport</td><td>06/93-</td></tr> </table>	1.8i	C/180	Sauf Sport	06/93-	2.0i	200	Sauf Sport	06/93-	2.0 D	200	Sauf Sport	06/93-	2.2i	220	Sauf Sport	06/93-	2.2 CDi	200	220		2.2 D	220	Sauf Sport	06/93-	2.3i	230	Komp	09/95-	2.4i	240		06/97-	2.5 D	250	Sauf Sport	06/93-	2.5 TD	250		09/95-	2.8i	280	Sauf Sport	06/93-
1.8i	C/180	Sauf Sport	06/93-																																										
2.0i	200	Sauf Sport	06/93-																																										
2.0 D	200	Sauf Sport	06/93-																																										
2.2i	220	Sauf Sport	06/93-																																										
2.2 CDi	200	220																																											
2.2 D	220	Sauf Sport	06/93-																																										
2.3i	230	Komp	09/95-																																										
2.4i	240		06/97-																																										
2.5 D	250	Sauf Sport	06/93-																																										
2.5 TD	250		09/95-																																										
2.8i	280	Sauf Sport	06/93-																																										

9005734 OE 2023304907	Triangle de suspension D Sup. <i>Upper right track control arm</i>																																												
	<p>3 Avec rotule With ball joint</p> <table border="0"> <tr><td>1.8i</td><td>C/180</td><td>Sauf Sport</td><td>06/93-</td></tr> <tr><td>2.0i</td><td>200</td><td>Sauf Sport</td><td>06/93-</td></tr> <tr><td>2.0 D</td><td>200</td><td>Sauf Sport</td><td>06/93-</td></tr> <tr><td>2.2i</td><td>220</td><td>Sauf Sport</td><td>06/93-</td></tr> <tr><td>2.2 CDi</td><td>200</td><td>220</td><td></td></tr> <tr><td>2.2 D</td><td>220</td><td>Sauf Sport</td><td>06/93-</td></tr> <tr><td>2.3i</td><td>230</td><td>Komp</td><td>09/95-</td></tr> <tr><td>2.4i</td><td>240</td><td></td><td>06/97-</td></tr> <tr><td>2.5 D</td><td>250</td><td>Sauf Sport</td><td>06/93-</td></tr> <tr><td>2.5 TD</td><td>250</td><td></td><td>09/95-</td></tr> <tr><td>2.8i</td><td>280</td><td>Sauf Sport</td><td>06/93-</td></tr> </table>	1.8i	C/180	Sauf Sport	06/93-	2.0i	200	Sauf Sport	06/93-	2.0 D	200	Sauf Sport	06/93-	2.2i	220	Sauf Sport	06/93-	2.2 CDi	200	220		2.2 D	220	Sauf Sport	06/93-	2.3i	230	Komp	09/95-	2.4i	240		06/97-	2.5 D	250	Sauf Sport	06/93-	2.5 TD	250		09/95-	2.8i	280	Sauf Sport	06/93-
1.8i	C/180	Sauf Sport	06/93-																																										
2.0i	200	Sauf Sport	06/93-																																										
2.0 D	200	Sauf Sport	06/93-																																										
2.2i	220	Sauf Sport	06/93-																																										
2.2 CDi	200	220																																											
2.2 D	220	Sauf Sport	06/93-																																										
2.3i	230	Komp	09/95-																																										
2.4i	240		06/97-																																										
2.5 D	250	Sauf Sport	06/93-																																										
2.5 TD	250		09/95-																																										
2.8i	280	Sauf Sport	06/93-																																										

... Classe C (202) 03/93- ...

SASIC

MERCEDES

Bras & Triangle de suspension

Control arm
Brazo y triángulo
Wahacz
Рычаг подвески

G/L  D/R



9005291

Rotule de susp. inf. G/D

OE 2113300335

L/R lower suspension ball joint



1
2

1.8i	180	06/93-
2.0i	200 220	06/93-
2.0 D	200	06/93-
2.2i	220	06/93-
2.2 CDi	200 220	03/98-03/01
2.2 D	220	06/93-
2.3i	230	06/96-03/01
2.4i	240	06/97-03/01
2.5 D	250	06/93-
2.5 TD	250	09/95-03/01
2.8i	280	06/93-
3.6i	36 AMG	06/94-06/97
4.3i	43 AMG	01/98-03/01



Barre stabilisatrice

Stabilizer bar
Barra estabilizadora
Drażek stabilizatora
стабилизатор поперечной устойчивости

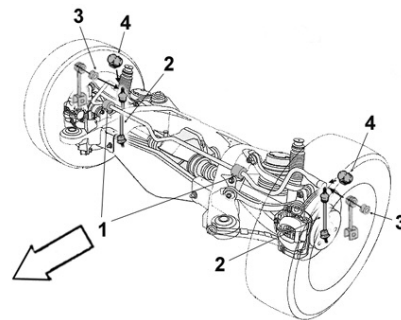

9005040

Biellette barre stab.

OE 1243200289

Stabilizer bar stub axle



2

1.8i	180 /Break
2.0i	200 /Komp Break
2.0 D	200
2.2i	220
2.2 CDi	200 220 Break
2.2 D	220 /Break
2.3i	230 /Komp /Break
2.4i	240 Break
2.5 D	250
2.5 TD	250 /Break
2.8i	280 /Break
3.6i	36 AMG
4.3i	43AMG Break

... Classe C (202) 03/93-



Eléments SUSPENSION

Suspension parts

Elementos suspensión

Elementy zawieszenie

Элементы подвески

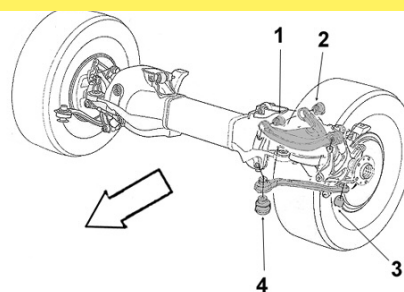

MERCEDES



9001606

Articulation inf.

OE 2023520165

Lower bush



4 Ø int.12 Ø ext.33 long. tube int.58 ext.45

1.8i	180
2.0i	200
2.2i	220
2.2 D	220
2.3i	230 Komp
2.5 TD	250
2.8i	280

Eléments TRAIN ARRIERE

Rear axle parts

Tren TRAS

Elementy zawieszenia tylnego

элементы задней оси.



9002516

Articulation berceau AR

OE 2023503408

Rear cradle bush



1.8i	180 /Break
2.0i	200
2.0 D	200
2.2i	220
2.2 D	220
2.3i	230 BVM
2.5 D	250
2.8i	280

9001605

Art. bielle de réaction AR milieu

OE 2013528865

Middle rear track rod bush



Ø int.12 Ø ext.32 long. tube int.43 ext.35

1.8i	180
2.0i	200
2.2i	220
2.2 D	220
2.3i	230 /Komp.
2.5 TD	250
2.8i	280

9005076

Bielle de réaction AR G/D sup.

OE 2013505606

Rear track rod L R upper



1.8i	180 /Break
2.0i	200 /Komp. Break
2.0 D	200
2.2i	220
2.2 CDi	200 220 /Break
2.2 D	220 /Break
2.3i	230 /Komp. /Break
2.4i	240 /Break
2.5 D	250
2.5 TD	250 /Break
2.8i	280 /Break
3.6i	36 AMG
4.3i	43AMG /Break

9005070

Bielle de réaction G/D inf.

OE 2103503806

Lower L/R track rod



1.8i	180
1.8i	180 Break
2.0i	200 /Komp. Break
2.0 D	200
2.2i	220
2.2 CDi	200 220 /Break
2.2 D	220 /Break
2.3i	230 /Komp. /Break
2.4i	240 /Break
2.5 D	250
2.5 TD	250 /Break
2.8i	280 /Break
3.6i	36 AMG
4.3i	43AMG /Break

Classe C (203) 05/00- ...



MERCEDES

Eléments DIRECTION
 Steering parts
 Elementos Direcciones
 Elementy układ kierowniczy
 Элементы рулевой системы

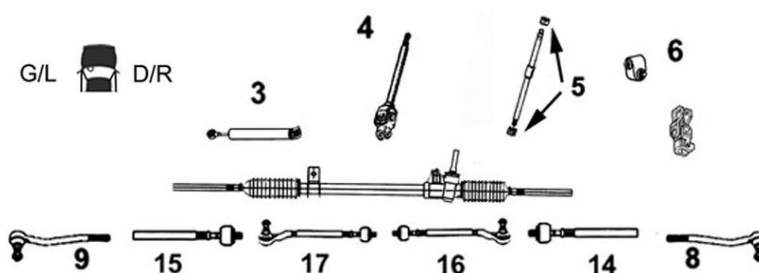

9006840 Axe de bielle G/D

Part/oe 2303380015 L/R axial joint



14 Côté dir. M16x1.5 Côté rot. M14x1.5 long 241 mm
15

1.8i	160 Sport Komp.	06/05-12/06
1.8i /16v.	180 200 Komp. /Break	
1.8i	180 200 Komp. Coupé	
2.0i	180 200	
2.0i	180 200 Komp. Break /Coupé	
2.1 CDi	200 220 /Break /Coupé	
2.3i	230 Komp. Coupé	
2.5i	230 /Break /Coupé	
2.6i V6	240 /Break	
2.7 CDi	270 /Break	
3.0i V6	280 /Break	
3.0 CDi	AMG Coupé	
3.2i	320 V6 /Break /Coupé	
3.5i	350 /Break /Coupé	
5.4i	55 AMG /Break	

9006540 Rotule de direction G

OE 2033303903 Left tie rod end



8 M14 x 1.5

1.8i	160 Komp. Sport	06/05-12/06
1.8i	180 200/30 Komp./Break/Coupé	
2.0i	180 200 Komp./Break/Coupé	
2.1 CDi	200 220 /Break /Coupé	
2.3i	230 Komp. Coupé	
2.5i	230 /Break /Coupé	
2.6i V6	240 /Break	
2.7 CDi	270 /Break	
3.0i V6	280 /Break	
3.0 CDi	AMG Coupé	
3.2i	320 V6 /Break /Coupé	
3.5i	350 /Break /Coupé	
5.4i	55 AMG /Break	

9006539 Rotule de direction D

OE 2033304003 Right tie rod end

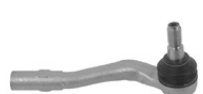

8 M14 x 1.5

1.8i	160 Komp. Sport	06/05-12/06
1.8i	180 200/30 Komp./Break/Coupé	
2.0i	180 200 Komp./Break/Coupé	
2.1 CDi	200 220 /Break /Coupé	
2.3i	230 Komp. Coupé	
2.5i	230 /Break /Coupé	
2.6i V6	240 /Break	
2.7 CDi	270 /Break	
3.0i V6	280 /Break	
3.0 CDi	AMG Coupé	
3.2i	320 V6 /Break /Coupé	
3.5i	350 /Break /Coupé	
5.4i	55 AMG /Break	



Barre stabilisatrice
 Stabilizer bar
 Barra estabilizadora
 Drażek stabilizatora
 стабилизатор поперечной устойчивости

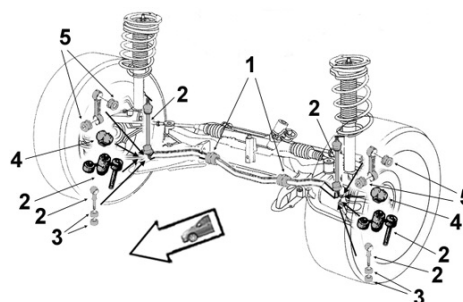

2306037 Biellette barre stab.

OE 2033202889 Stabilizer bar stub axle



2

1.8i	180 200 Komp./Break	06/02-06/07
2.0i	180 200 Komp./Break	05/00-06/02
2.1 CDi	200 220 / Break	05/00-06/07
2.5i	230 /Break	05/00-06/07
2.6i V6	240 /Break	05/00-06/05
2.7 CDi	270 /Break	10/00-06/05
3.0i V6	24v. 280 /Break	06/05-06/07
3.0 CDi	320 /Break	01/05-06/07
3.2i	320 V6 /Break	05/00-06/05
3.5i V6	350 /Break	06/05-06/07

2306048 Palier de barre milieu

OE 2033232085 Middle bar main bearing



1 Ø 20

1.8i	180 200 Komp./Break	06/02-03/04
2.0i	180 /Break	05/00-06/02
2.0i	200 Komp./Break	05/00-06/02
2.1 CDi	200 220 /Break	05/00-03/04
2.6i V6	240 /Break	05/00-03/04
2.7 CDi	270 /Break	10/00-03/04
3.2i	320 V6 /Break	05/00-03/04

... Classe C (203) 05/00- ...



Eléments SUSPENSION

Suspension parts

Elementos suspensión

Elementy zawieszenie

Элементы подвески

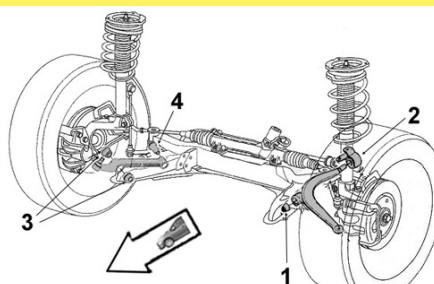

MERCEDDES



2256030

Articulation bras AV

OE 2033330914

Front arm bush



4 Ø ext. 70 long. tube int.80 ext. 45

1.8i	180 200 Komp. /Break	06/02-03/04
2.0i	180 /Sport /Break /Coupé	05/00-06/02
	200 Komp. /Sport /Break /Coupé	
2.1 CDi	200 220 /Sport /Break /Coupé	05/00-03/04
2.3i	230 Komp. Sport Coupé	03/01-06/02
2.6i V6	240 /4Matic /Break	05/00-06/07
2.7 CDi	270 /Break	08/00-06/07
3.0 CDi	AMG Sport Coupé	09/02-01/05
3.2i	32 AMG Komp. /Break	03/01-03/04
	320 V6/Break	05/00-06/05

2256027

Articulation bras AR

OE 2033331014

Rear arm bush



4 Ø ext. 70 long. tube int.80 ext.60

1.8i	180 200 Komp./Break	06/02-03/04
2.0i	180 /Break	05/00-06/02
2.0i	200 Komp. /Break	05/00-06/02
2.1 CDi	200 220 /Break	05/00-03/04
2.6i V6	240 /Break	05/00-03/04
2.7 CDi	270 /Break	10/00-03/04
3.2i	320 V6 /Break	05/00-03/04

Bras & Triangle de suspension

Control arm
Brazo y triángulo
Wahacz
Рычаг подвески

G/L D/R

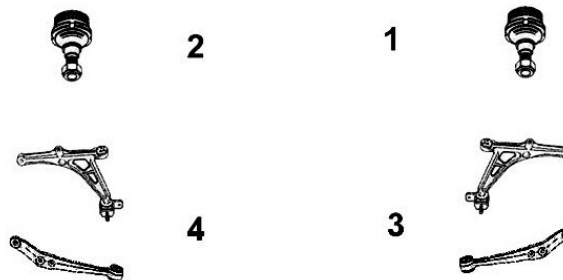

7476002

Bras de susp. AR inf. G

OE 2033303911

Left rear lower track control arm



4 Aluminium Avec rotule With ball joint

1.8i 16v.	Sport Coupé	06/05-12/06
1.8i	180 Komp.	06/02-03/04
1.8i	180 Komp. Sport Coupé	06/02-04/08
1.8i	200 Komp.	06/02-03/04
1.8i	200 Komp. Sport Coupé	06/02-04/08
1.8i	230 Komp. Sport Coupé	06/02-06/05
2.0i	180	05/00-06/02
2.0i	180 Sport Coupé	03/01-06/02
2.0i	200 Komp.	05/00-06/02
2.0i	200 Komp. Sport Coupé	03/01-06/02
2.1 CDi	200	05/00-03/04
2.1 CDi	200 Sport Coupé	09/03-04/08
2.1 CDi	220	05/00-09/03
2.1 CDi	220 Sport Coupé	03/01-04/08
2.3i	230 Komp. Sport Coupé	03/01-06/02
2.5i	230 Sport Coupé	06/05-04/08
2.6i V6	240	05/00-03/04
2.7 CDi	270	10/00-03/04
3.0 CDi	AMG Sport	09/02-01/05
3.2i	320 V6	05/00-03/04
3.2i	320 V6 Sport Coupé	09/02-06/05
3.5i	350 Sport Coupé	06/05-04/08

... Classe C (203) 05/00- ...

Bras & Triangle de suspension

Control arm
Brazo y triángulo
Wahacz
Рычаг подвески

G/L  D/R

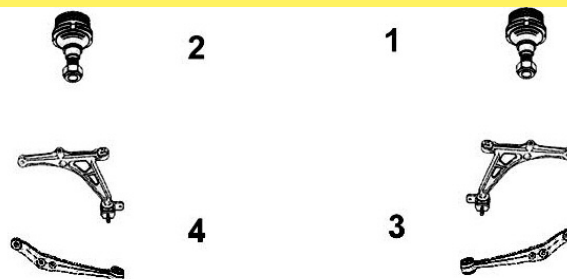

MERCEDÉS

SASIC

7476001

Bras de susp. AR inf. D

OE 2033303611

Right rear lower track control arm

3 Aluminium Avec rotule With ball joint



1.8i 16v.	Sport Coupé	06/05-12/06
1.8i	180 Komp.	06/02-03/04
1.8i	180 Komp. Sport Coupé	06/02-04/08
1.8i	200 Komp.	06/02-03/04
1.8i	200 Komp. Sport Coupé	06/02-04/08
1.8i	230 Komp. Sport Coupé	06/02-06/05
2.0i	180	05/00-06/02
2.0i	180 Sport Coupé	03/01-06/02
2.0i	200 Komp.	05/00-06/02
2.0i	200 Komp. Sport Coupé	03/01-06/02
2.1 CDi	200	05/00-03/04
2.1 CDi	200 Sport Coupé	09/03-04/08
2.1 CDi	220	05/00-09/03
2.1 CDi	220 Sport Coupé	03/01-04/08
2.3i	230 Komp. Sport Coupé	03/01-06/02
2.5i	230 Sport Coupé	06/05-04/08
2.6i V6	240	05/00-03/04
2.7 CDi	270	10/00-03/04
3.0 CDi	AMG Sport	09/02-01/05
3.2i	320 V6	05/00-03/04
3.2i	320 V6 Sport Coupé	09/02-06/05
3.5i	350 Sport Coupé	06/05-04/08

7476061

Bras de susp. AR inf. G

OE 2043301911

Left rear lower track control arm

4 Acier steel Avec rotule With ball joint



1.8i	160 Komp. Sport Coupé	06/05-12/06
1.8i	180 Komp. /Break	06/02-08/07
1.8i	180 Komp. Sport Coupé	06/02-04/08
1.8i	200 Komp. /Break	06/02-08/07
1.8i	200 Komp. Sport Coupé	06/02-04/08
1.8i	230 Komp. Sport Coupé	06/02-06/05
2.0i	180 /Break	05/00-06/02
2.0i	180 Sport Coupé	03/01-06/02
2.0i	200 Komp. /Break	05/00-06/02
2.0i	200 Komp. Sport Coupé	03/01-06/02
2.1 CDi	200 220 /Break	05/00-08/07
2.1 CDi	200 220 Sport Coupé	03/01-04/08
2.3i	230 Komp. Sport Coupé	03/01-06/02
2.5i	230 /Break	01/05-08/07
2.5i	230 Sport Coupé	06/05-04/08
2.6i V6	240 /Break	03/01-08/07
2.7 CDi	270 /Break	03/01-08/07
3.0i	280 /Break	01/05-08/07
3.0 CDi	/Break	01/05-08/07
3.0 CDi	AMG Sport /Break	09/02-01/05
3.2i	320 V6 /Break	03/01-08/07
3.2i	320 V6 Sport Coupé	09/02-06/05
3.5i	350 /Break	06/05-08/07
3.5i	350 Sport Coupé	06/05-04/08
5.4i	55 AMG /Break	02/04-08/07

... Classe C (203) 05/00- ...

7476060

Bras de susp. AR inf. D

OE 2043302011

Right rear lower track control arm



3 Acier steel Avec rotule With ball joint

1.8i	160 Komp. Sport Coupé	06/05-12/06
1.8i	180 Komp. /Break	06/02-08/07
1.8i	180 Komp. Sport Coupé	06/02-04/08
1.8i	200 Komp. /Break	06/02-08/07
1.8i	200 Komp. Sport Coupé	06/02-04/08
1.8i	230 Komp. Sport Coupé	06/02-06/05
2.0i	180 /Break	05/00-06/02
2.0i	180 Sport Coupé	03/01-06/02
2.0i	200 Komp. /Break	05/00-06/02
2.0i	200 Komp. Sport Coupé	03/01-06/02
2.1 CDi	200 220 /Break	05/00-08/07
2.1 CDi	200 220 Sport Coupé	03/01-04/08
2.3i	230 Komp. Sport Coupé	03/01-06/02
2.5i	230 /Break	01/05-08/07
2.5i	230 Sport Coupé	06/05-04/08
2.6i V6	240 /Break	03/01-08/07
2.7 CDi	270 /Break	03/01-08/07
3.0i	280 /Break	01/05-08/07
3.0 CDi	/Break	01/05-08/07
3.0 CDi	AMG Sport /Break	09/02-01/05
3.2i	320 V6 /Break	03/01-08/07
3.2i	320 V6 Sport Coupé	09/02-06/05
3.5i	350 /Break	06/05-08/07
3.5i	350 Sport Coupé	06/05-04/08
5.4i	55 AMG /Break	02/04-08/07



Barre stabilisatrice

Stabilizer bar

Barra estabilizadora

Drażek stabilizatora

стабилизатор поперечной устойчивости

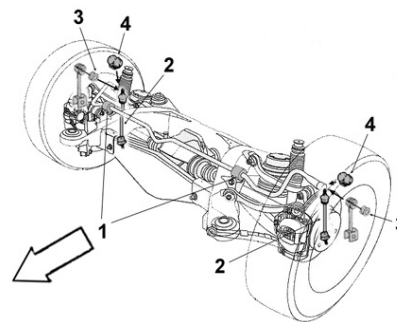

2306047

Biellette barre stab. G

OE 2033200789

Left stabilizer bar stub axle



2 1.8i	180 200 Komp. /Break	06/02-06/07
2.0i	180 /Break	05/00-06/02
2.0i	200 Komp. /Break	05/00-06/02
2.1 CDi	200 220 /Break	05/00-06/07
2.5i	230 /Break	06/05-06/07
2.6i V6	240 /4Matic Break	05/00-06/05
2.7 CDi	270 /Break	10/00-06/05
3.0i V6 24v.	280 /Break	06/05-06/07
3.0 CDi	320 /AMG /Break	03/04-06/07
3.2i V6	320 /4Matic /Break	05/00-06/05
3.5i V6	350 /4Matic /Break	06/05-06/07
5.4i	55 AMG /Break	03/04-06/07

9005040

Biellette barre stab.

OE 1243200289

Stabilizer bar stub axle



2		
2.0i	220 GPL	01/94-06/97

...Classe C (203) 05/00-



Eléments SUSPENSION

Suspension parts
Elementos suspensión
Elementy zawieszenie
Элементы подвески

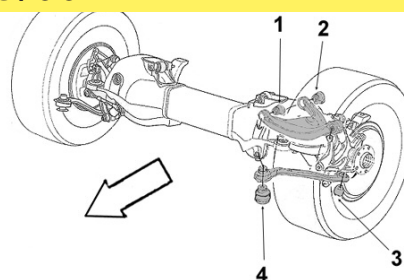

9001606

Articulation inf.

OE 2023520165

Lower bush

4 Ø int.12 Ø ext.33 long. tube int.58 ext.45



1.8i	180 200 Komp. /Break	06/02-03/04
2.0i	180 200 Komp. /Break	05/00-06/02
2.1 CDi	200 220 /Break	05/00-03/04
2.6i V6	240 /4Matic /Break	05/00-06/05
2.7 CDi	270 /Break	10/00-03/04
3.0i	280 4-Matic /Break	06/05-06/07
3.0 CDi	AMG Break BVA	03/04-01/05
3.2i	320 V6 /4Matic /Break	05/00-06/07
3.5i V6 18/24v.	350 /4Matic /Break	06/05-06/07
5.4i	55 AMG /Break	03/04-06/07

Eléments TRAIN ARRIERE

Rear axle parts
Tren TRAS
Elementy zawieszenia tylnego
элементы задней оси.



9001605

Art. bielle de réaction AR milieu

OE 2013528865

Middle rear track rod bush

Ø int.12 Ø ext.32 long. tube int.43 ext.35



1.8i	180 200 Komp. /Break
2.0i	180 200 Komp. Break
2.1 CDi	200 220 Break
2.6i V6	240 /4Matic /Break
2.7 CDi	270 Break
3.2i	320 V6 /4Matic /Break

9005076

Bielle de réaction AR G/D sup.

OE 2103503306

Rear track rod L R upper



1.8i	180 200 Komp.
2.0i	180 200 Komp. 220 GPL
2.1 CDi	200 220
2.3i	230 Komp.
2.5i	230 /Sport /Break
2.6i V6	240
2.7 CDi	270
3.0i V6	280 /4Matic /Break
3.0 CDi	320 /AMG /Sport /Break
3.2i	320 V6
3.5i V6	350 /Sport /4Matic /Break
5.4i	55 AMG /Break

9005070

Bielle de réaction G/D inf.

OE 2103503806

Lower L/R track rod



1.8i	180 200 Komp.
2.0i	180 200 Komp.
2.0i	220 GPL
2.1 CDi	200 220
2.3i	230 Komp.
2.5i	230 /Sport /Break
2.6i V6	240
2.7 CDi	270
3.0i V6	280 /4Matic /Break
3.0 CDi	320 /AMG /Sport /Break
3.2i	320 V6
3.5i V6	350 /Sport /4Matic /Break
5.4i	55 AMG /Break

Classe C (204) 01/07-...

Eléments DIRECTION

Steering parts

Elementos Direcciones

Elementy uklad kierowniczy

Элементы рулевой системы

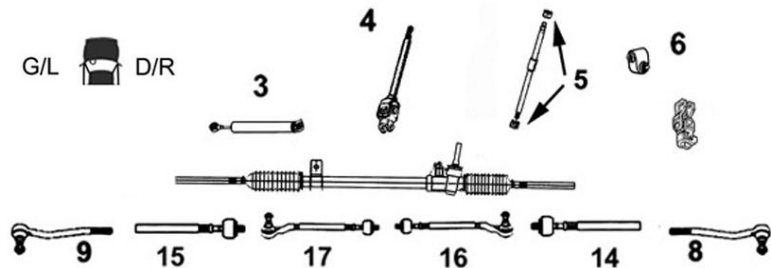

7776015

Axe de bielle G/D

OE 2043380415

L/R axial joint



14 Côté dir. M16x1.5 Côté rot. M14x1.5 long 260 mm

15	1.6i Turbo	180 /Break	01/08-
	1.8 CGi	180 200 250 /Break /Coupé	01/07-
	1.8i	180 Komp. /Break	09/07-12/08
	1.8i	200 Komp. /Break	01/07-
	2.1 CDi	250 /Break	BVM 10/08-
	2.1 CDi	200 220 FAP /Break	09/07-
	2.2 CDi	200 220 250 FAP /Break	01/07-
	2.5i	230 /Break	01/07-
	3.0i	280 /Break	01/07-
	3.0 CDi	320 350 FAP /Break	09/07-
	3.5i	350 /Break/Coupé	BVA 01/07-

7676012

Rotule de direction G

OE 2043300903

Left tie rod end

9



	1.6i Turbo	180 /Break	01/08-
	1.8 CGi	180 200/50/Break/Coupé	01/07-
	1.8i	180 Komp. /Break	09/07-12/08
	1.8i	200 Komp. /Break	01/07-
	2.1 CDi	200/20/50 FAP/Break	09/07-
	2.2 CDi	180 200 220 250 FAP /Break	01/07-
	2.5i	230 /Break	05/07-
	3.0i	280 /Break	01/07-
	3.0 CDi	320 350 FAP /Break	01/07-
	3.5i	350 /Break BVA	01/07-
	6.3i	63 AMG /Break BVA	01/08-

7676011

Rotule de direction D

OE 2043301003

Right tie rod end

8



	1.6i Turbo	180 /Break	01/08-
	1.8 CGi	180 200/50/Break/Coupé	01/07-
	1.8i	180 Komp. /Break	09/07-12/08
	1.8i	200 Komp. /Break	01/07-
	2.1 CDi	200/20/50 FAP/Break	09/07-
	2.2 CDi	180 200 220 250 FAP /Break	01/07-
	2.5i	230 /Break	05/07-
	3.0i	280 /Break	01/07-
	3.0 CDi	320 350 FAP /Break	01/07-
	3.5i	350 /Break BVA	01/07-
	6.3i	63 AMG /Break BVA	01/08-



Eléments SUSPENSION

Suspension parts

Elementos suspensión

Elementy zawieszenie

Элементы подвески

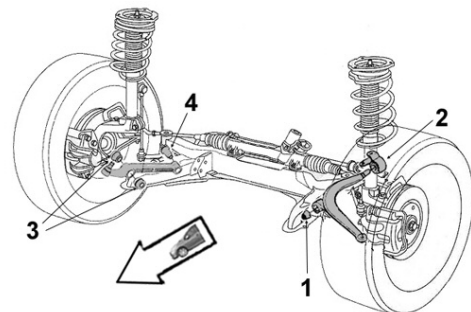

2256027

Articulation bras sup.

OE 2033331014

Upper arm bush

4 Ø ext. 70 long. tube int.80 ext.60



	1.6i Turbo	180 Break	01/08-
	1.8i	180 200 Komp. /Break	01/07-
	2.1 CDi	200 220 250 /Break	09/07-
	3.0i	280 /4WD Break	01/07-
	3.0 CDi	320 /4WD Break	01/07-
	3.5i	350 /4WD Break BVA	01/07-

2256031

Articulation bras inf.

OE 2043330414

Lower arm bush

4 Ø int. 15 Ø ext. 53 long. tube int. 80 ext. 56



	1.8i	180 200 Komp.	01/07-
	2.2 CDi	220	01/07-
	2.5i	230	05/07-
	3.5i	350 /Break	08/08-

... Classe C (204) 01/07-

SASIC



MERCEDÉS

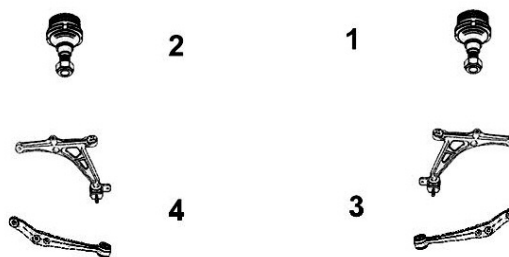

Bras & Triangle de suspension

Control arm
Brazo y triángulo
Wahacz
Рычаг подвески

G/L  D/R



<p>7476002 OE 2043304311</p> 	<p>Bras de susp. AR inf. G <i>Left rear lower track control arm</i></p> <p>4 Aluminium Avec rotule With ball joint</p> <p>1.6i Turbo 180 /Break 01/08- 1.8i 180 Komp./Break 09/07-12/08 1.8i 200 Komp./Break 01/07- 1.8i CGI 180 200 250 01/07- 2.1 CDi 200 220/50 /Break 01/07- 2.2 CDi 180 200 220 250 /Break /Coupé 01/07- 2.5i 230 /Break 01/07- 3.0i 280 /Break 01/07- 3.0 CDi 320/50 FAP/Break 01/07- 3.5i 350 /Break BVA 01/07- 6.3i 63 AMG /Break BVA 01/08-</p>	<p>7476001 OE 2043304411</p> 	<p>Bras de susp. AR inf. D <i>Right rear lower track control arm</i></p> <p>3 Aluminium Avec rotule With ball joint</p> <p>1.6i Turbo 180 /Break 01/08- 1.8i 180 Komp./Break 09/07-12/08 1.8i 200 Komp./Break 01/07- 1.8i CGI 180 200 250 01/07- 2.1 CDi 200 220/50 /Break 01/07- 2.2 CDi 180 200 220 250 /Break /Coupé 01/07- 2.5i 230 /Break 01/07- 3.0i 280 /Break 01/07- 3.0 CDi 320/50 FAP/Break 01/07- 3.5i 350 /Break BVA 01/07- 6.3i 63 AMG /Break BVA 01/08-</p>
---	--	--	---



<p>7476003 OE 2043306711</p> 	<p>Bras de susp. AV inf. G <i>L front lower track control arm</i></p> <p>4 Avec rotule With ball joint</p> <p>1.6i Turbo 180 /Break 1.8i CGI 200 250 /Break 1.8i 180 200 Komp. /Break 2.1 CDi 200 200 250 /Break 2.2 CDi 180 200/20/50 FAP/Break /Coupé 2.5i 230 /Break 3.0i 280 /Break 3.0 CDi 320 350 FAP /Break 3.5i 350 /Break BVA</p>	<p>7476004 OE 2043306811</p> 	<p>Bras de susp. AV inf. D <i>R front lower track control arm</i></p> <p>3 Avec rotule With ball joint</p> <p>1.6i Turbo 180 /Break 1.8i CGI 200 250 /Break 1.8i 180 200 Komp. /Break 2.1 CDi 200 200 250 /Break 2.2 CDi 180 200/20/50 FAP/Break /Coupé 2.5i 230 /Break 3.0i 280 /Break 3.0 CDi 320 350 FAP /Break 3.5i 350 /Break BVA</p>
---	--	--	--

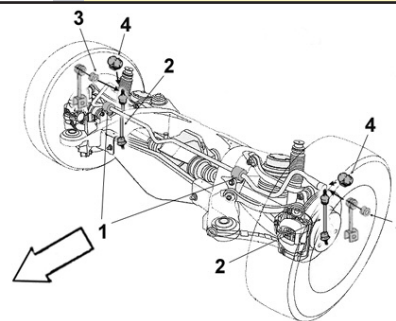

Barre stabilisatrice

Stabilizer bar
Barra estabilizadora
Drażek stabilizatora
стабилизатор поперечной устойчивости



<p>2306039 OE 2043200589</p> 	<p>Biellette barre stab. G <i>Left stabilizer bar stub axle</i></p> <p>2</p> <p>1.6i Turbo 180 /Break 01/08- 1.8i 180 200 Komp./Break 01/07- 2.1 CDi 200 220 250 /Break 01/07- 2.5i 230 /Break 01/07- 3.0i 280 /4WD Break 01/07- 3.0 CDi 320 /4WD Break 01/07- 3.0 CDi 350 /4WD /Break 10/09- 3.5i 350 /4WD Break BVA 01/07- 6.3i 63 AMG BVA 01/08-</p>	<p>2306038 OE 2043200489</p> 	<p>Biellette barre stab. D <i>Right stabilizer bar stub axle</i></p> <p>2</p> <p>1.6i Turbo 180 /Break 01/08- 1.8i 180 200 Komp./Break 01/07- 2.1 CDi 200 220 250 /Break 01/07- 2.5i 230 /Break 01/07- 3.0i 280 /4WD Break 01/07- 3.0 CDi 320 /4WD Break 01/07- 3.0 CDi 350 /4WD /Break 10/09- 3.5i 350 /4WD Break BVA 01/07- 6.3i 63 AMG BVA 01/08-</p>
---	---	--	--

Classe CLK Coupé (209) 06/02-...

Eléments DIRECTION
 Steering parts
 Elementos Direcciones
 Elementy uklad kierowniczy
 Элементы рулевой системы

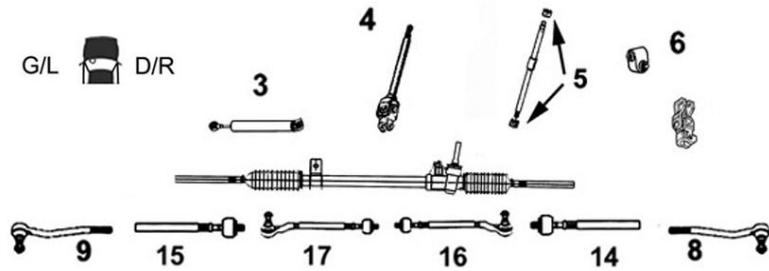

9006840 Axe de bielle G/D

Part/oe 2303380015 L/R axial joint



14 Côté dir. M16x1.5 Côté rot. M14x1.5 long 241 mm

15	1.8i	200 Komp.	05/02-12/09
	2.2 CDi		04/05-12/09
	2.6i	240	05/02-04/05
	2.7 CDi	270	05/02-04/05
	3.0i	280	04/05-12/09
	3.0 CDi	320	04/05-12/09
	3.2i	320	05/02-04/05
	3.5i	350	04/05-12/09
	5.0i	500	05/02-09/06
	5.5i	600	09/06-12/09

4WD

9006540 Rotule de direction G

OE 2033303903 Left tie rod end



9	M14 x 1.5		
	1.8i	200 Komp.	05/02-12/09
	2.2 CDi		04/05-12/09
	2.6i	240	05/02-04/05
	2.7 CDi	270	05/02-04/05
	3.0i	280	04/05-12/09
	3.0 CDi	320	04/05-12/09
	3.2i	320	05/02-04/05
	3.5i	350	04/05-12/09
	5.0i	500	05/02-09/06
	5.5i	600	09/06-12/09

9006539 Rotule de direction D

OE 2033304003 Right tie rod end



8	M14 x 1.5		
	1.8i	200 Komp.	05/02-12/09
	2.2 CDi		04/05-12/09
	2.6i	240	05/02-04/05
	2.7 CDi	270	05/02-04/05
	3.0i	280	04/05-12/09
	3.0 CDi	320	04/05-12/09
	3.2i	320	05/02-04/05
	3.5i	350	04/05-12/09
	5.0i	500	05/02-09/06
	5.5i	600	09/06-12/09

Bras & Triangle de suspension

Control arm
 Brazo y triángulo
 Wahacz
 Рычаг подвески

G/L D/R

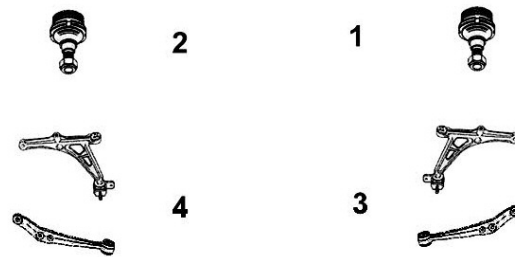

7476061 Bras de susp. AR inf. G

OE 2043301911 Left rear lower track control arm



4	Acier steel Avec rotule With ball joint		
	1.8i	200 Komp.	05/02-12/09
	2.2 CDi		04/05-12/09
	2.6i V6 18v.	240	05/02-04/05
	2.7 CDi	270	05/02-04/05
	3.0i V6 24v.	280	04/05-12/09
	3.0 CDi	320	04/05-12/09
	3.2i V6 18v.	320	05/02-04/05
	3.5i V6 18v.	350	04/05-12/09
	5.0i V8 24v.	500	05/02-09/06
	5.5i	600	09/06-12/09

7476060 Bras de susp. AR inf. D

OE 2043302011 Right rear lower track control arm



3	Acier steel Avec rotule With ball joint		
	1.8i	200 Komp.	05/02-12/09
	2.2 CDi		04/05-12/09
	2.6i V6 18v.	240	05/02-04/05
	2.7 CDi	270	05/02-04/05
	3.0i V6 24v.	280	04/05-12/09
	3.0 CDi	320	04/05-12/09
	3.2i V6 18v.	320	05/02-04/05
	3.5i V6 18v.	350	04/05-12/09
	5.0i V8 24v.	500	05/02-09/06
	5.5i	600	09/06-12/09

7476002 Bras de susp. AR inf. G

OE 2033303911 Left rear lower track control arm



4	Aluminium Avec rotule With ball joint		
	1.8i	200 Komp.	05/02-12/09
	2.2 CDi FAP		04/05-12/09
	2.6i V6 18v.	240	05/02-04/05
	2.7 CDi	270	05/02-04/05
	3.0i V6 24v.	280	04/05-12/09
	3.0 CDi	320 FAP	04/05-12/09
	3.2i V6 18v.3204WDBVA		05/02-04/05
	3.5i V6 18v.	350 BVA	04/05-12/09
	5.0i V8 24v.	500 BVA	05/02-09/06
	5.5i	600 BVA	09/06-12/09

7476001 Bras de susp. AR inf. D

OE 2043304411 Right rear lower track control arm



3	Aluminium Avec rotule With ball joint		
	1.8i	200 Komp.	05/02-12/09
	2.2 CDi FAP		04/05-12/09
	2.6i V6 18v.	240	05/02-04/05
	2.7 CDi	270	05/02-04/05
	3.0i V6 24v.	280	04/05-12/09
	3.0 CDi	320 FAP	04/05-12/09
	3.2i V6 18v.3204WDBVA		05/02-04/05
	3.5i V6 18v.	350 BVA	04/05-12/09
	5.0i V8 24v.	500 BVA	05/02-09/06
	5.5i	600 BVA	09/06-12/09

... Classe CLK Coupé (209) 06/02-

Eléments TRAIN ARRIERE

Rear axle parts

Tren TRAS

Elementy zawieszenia tylnego

элементы задней оси.



MERCEDDES

9005076

Bielle de réaction AR G/D sup.

OE 2103503306

Rear bushing L R upper



1.8i	200Komp.	05/02-12/09
2.2 CDi	FAP	04/05-12/09
2.6i V6	18v. 240	05/02-04/05
2.7 CDi	270	05/02-04/05
3.0i V6	24v. 280	04/05-12/09
3.0 CDi	320 FAP	04/05-12/09
3.2i V6	18v. 320	05/02-04/05
3.5i V6	18v. 350	04/05-12/09
5.0i V8	24v. 500	05/02-09/06
5.5i	600	09/06-12/09

9005070

Bielle de réaction G/D inf.

OE 2103503806

Lower L/R track rod



1.8i	200Komp.	05/02-12/09
2.2 CDi	FAP	04/05-12/09
2.6i V6	18v. 240	05/02-04/05
2.7 CDi	270	05/02-04/05
3.0i V6	24v. 280	04/05-12/09
3.0 CDi	320 FAP	04/05-12/09
3.2i V6	18v. 320	05/02-04/05
3.5i V6	18v. 350	04/05-12/09
5.0i V8	24v. 500	05/02-09/06
5.5i	600	09/06-12/09

Classe CLS (219)

Bras & Triangle de suspension

Control arm
Brazo y triángulo
Wahacz
Рычаг подвески

G/L D/R

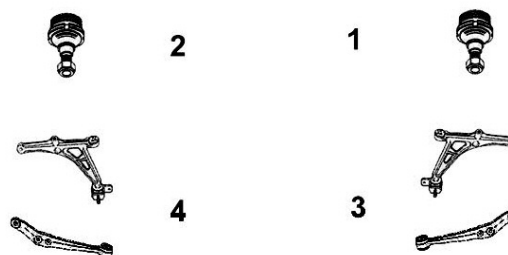

7576033

Rotule de susp. sup. G/D

OE 0003301007

L/R upper susp. ball joint

NEW



1
2

3.0i	280	07/08-12/10
3.0 CDi	320	01/05-12/10
3.5i	350	10/04-12/10
5.0i	500	10/04-12/10
5.5	500	04/06-12/10
5.5	55 AMG	01/05-12/10
6.2i	AMG	04/06-12/10

Classe E (207) 01/09- ...

Eléments DIRECTION

Steering parts

Elementos Direcciones

Elementy układ kierowniczy

Элементы рулевой системы

G/L D/R

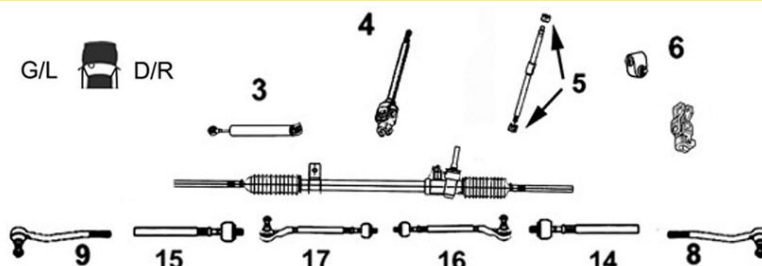

7776015

Axe de bielle G/D

OE 2043380415

L/R axial joint



14
15

Côté dir. M16x1.5 Côté rot. M14x1.5 long 260 mm

1.8i	CGI	BVA	05/09-
2.1 CDi	250	BVA	05/09-
3.0 CDi	350	BVA	05/09-
3.5i	350	BVA	05/09-
5.5i	500	BVA	05/09-

... Classe E (207) 01/09-

MERCEDES



7676012 OE 2043300903	Rotule de direction G <i>Left tie rod end</i>	7676011 OE 2043301003	Rotule de direction D <i>Right tie rod end</i>																														
9	<table style="width: 100%; border-collapse: collapse;"> <tr><td>1.8i CGI</td><td>BVA</td><td>05/09-</td></tr> <tr><td>2.1 CDi 250</td><td></td><td>05/09-</td></tr> <tr><td>3.0 CDi 350</td><td>BVA</td><td>05/09-</td></tr> <tr><td>3.5i 350</td><td>BVA</td><td>05/09-</td></tr> <tr><td>5.5i 500</td><td>BVA</td><td>05/09-</td></tr> </table>	1.8i CGI	BVA	05/09-	2.1 CDi 250		05/09-	3.0 CDi 350	BVA	05/09-	3.5i 350	BVA	05/09-	5.5i 500	BVA	05/09-	8	<table style="width: 100%; border-collapse: collapse;"> <tr><td>1.8i CGI</td><td>BVA</td><td>05/09-</td></tr> <tr><td>2.1 CDi 250</td><td></td><td>05/09-</td></tr> <tr><td>3.0 CDi 350</td><td>BVA</td><td>05/09-</td></tr> <tr><td>3.5i 350</td><td>BVA</td><td>05/09-</td></tr> <tr><td>5.5i 500</td><td>BVA</td><td>05/09-</td></tr> </table>	1.8i CGI	BVA	05/09-	2.1 CDi 250		05/09-	3.0 CDi 350	BVA	05/09-	3.5i 350	BVA	05/09-	5.5i 500	BVA	05/09-
1.8i CGI	BVA	05/09-																															
2.1 CDi 250		05/09-																															
3.0 CDi 350	BVA	05/09-																															
3.5i 350	BVA	05/09-																															
5.5i 500	BVA	05/09-																															
1.8i CGI	BVA	05/09-																															
2.1 CDi 250		05/09-																															
3.0 CDi 350	BVA	05/09-																															
3.5i 350	BVA	05/09-																															
5.5i 500	BVA	05/09-																															

Bras & Triangle de suspension

Control arm
Brazo y triángulo
Wahacz
Рычаг подвески

G/L D/R

7476002 OE 2043304311	Bras de susp. AR inf. G <i>Left rear lower track control arm</i>	7476001 OE 2043304411	Bras de susp. AR inf. D <i>Right rear lower track control arm</i>																																								
4	<p>Aluminium Avec rotule With ball joint</p> <table style="width: 100%; border-collapse: collapse;"> <tr><td>1.8i CGI</td><td></td><td>BVA</td><td>05/09-</td></tr> <tr><td>2.1 CDi 250</td><td></td><td></td><td>05/09-</td></tr> <tr><td>3.0 CDi</td><td></td><td>BVA</td><td>05/09-</td></tr> <tr><td>3.5i 350</td><td></td><td></td><td>05/09-</td></tr> <tr><td>5.5i 500</td><td></td><td>BVA</td><td>05/09-</td></tr> </table>	1.8i CGI		BVA	05/09-	2.1 CDi 250			05/09-	3.0 CDi		BVA	05/09-	3.5i 350			05/09-	5.5i 500		BVA	05/09-	3	<p>Aluminium Avec rotule With ball joint</p> <table style="width: 100%; border-collapse: collapse;"> <tr><td>1.8i CGI</td><td></td><td>BVA</td><td>05/09-</td></tr> <tr><td>2.1 CDi 250</td><td></td><td></td><td>05/09-</td></tr> <tr><td>3.0 CDi</td><td></td><td>BVA</td><td>05/09-</td></tr> <tr><td>3.5i 350</td><td></td><td></td><td>05/09-</td></tr> <tr><td>5.5i 500</td><td></td><td>BVA</td><td>05/09-</td></tr> </table>	1.8i CGI		BVA	05/09-	2.1 CDi 250			05/09-	3.0 CDi		BVA	05/09-	3.5i 350			05/09-	5.5i 500		BVA	05/09-
1.8i CGI		BVA	05/09-																																								
2.1 CDi 250			05/09-																																								
3.0 CDi		BVA	05/09-																																								
3.5i 350			05/09-																																								
5.5i 500		BVA	05/09-																																								
1.8i CGI		BVA	05/09-																																								
2.1 CDi 250			05/09-																																								
3.0 CDi		BVA	05/09-																																								
3.5i 350			05/09-																																								
5.5i 500		BVA	05/09-																																								

7476003 OE 2043306711	Bras de susp. AV inf. G <i>L front lower track control arm</i>	7476004 OE 2043306811	Bras de susp. AV inf. D <i>R front lower track control arm</i>																																								
4	<p>Avec rotule With ball joint</p> <table style="width: 100%; border-collapse: collapse;"> <tr><td>1.8i CGI</td><td></td><td>BVA</td><td>05/09-</td></tr> <tr><td>2.1 CDi 250</td><td></td><td></td><td>05/09-</td></tr> <tr><td>3.0 CDi 350</td><td></td><td>BVA</td><td>05/09-</td></tr> <tr><td>3.5i 350</td><td></td><td>BVA</td><td>05/09-</td></tr> <tr><td>5.5i 500</td><td></td><td>BVA</td><td>05/09-</td></tr> </table>	1.8i CGI		BVA	05/09-	2.1 CDi 250			05/09-	3.0 CDi 350		BVA	05/09-	3.5i 350		BVA	05/09-	5.5i 500		BVA	05/09-	3	<p>Avec rotule With ball joint</p> <table style="width: 100%; border-collapse: collapse;"> <tr><td>1.8i CGI</td><td></td><td>BVA</td><td>05/09-</td></tr> <tr><td>2.1 CDi 250</td><td></td><td></td><td>05/09-</td></tr> <tr><td>3.0 CDi 350</td><td></td><td>BVA</td><td>05/09-</td></tr> <tr><td>3.5i 350</td><td></td><td>BVA</td><td>05/09-</td></tr> <tr><td>5.5i 500</td><td></td><td>BVA</td><td>05/09-</td></tr> </table>	1.8i CGI		BVA	05/09-	2.1 CDi 250			05/09-	3.0 CDi 350		BVA	05/09-	3.5i 350		BVA	05/09-	5.5i 500		BVA	05/09-
1.8i CGI		BVA	05/09-																																								
2.1 CDi 250			05/09-																																								
3.0 CDi 350		BVA	05/09-																																								
3.5i 350		BVA	05/09-																																								
5.5i 500		BVA	05/09-																																								
1.8i CGI		BVA	05/09-																																								
2.1 CDi 250			05/09-																																								
3.0 CDi 350		BVA	05/09-																																								
3.5i 350		BVA	05/09-																																								
5.5i 500		BVA	05/09-																																								

Barre stabilisatrice
Stabilizer bar
Barra estabilizadora
Drażek stabilizatora
стабилизатор поперечной устойчивости

2306039 OE 2043200589	Biellette barre stab. G <i>Left stabilizer bar stub axle</i>	2306038 OE 2043200489	Biellette barre stab. D <i>Right stabilizer bar stub axle</i>																																								
2	<table style="width: 100%; border-collapse: collapse;"> <tr><td>1.8i CGI</td><td></td><td></td><td>05/09-</td></tr> <tr><td>2.1 CDi 250 Coupé</td><td></td><td></td><td>05/09-</td></tr> <tr><td>3.0 CDi 350</td><td></td><td></td><td>05/09-</td></tr> <tr><td>3.5i 350</td><td></td><td></td><td>05/09-</td></tr> <tr><td>5.5i 500</td><td></td><td></td><td>05/09-</td></tr> </table>	1.8i CGI			05/09-	2.1 CDi 250 Coupé			05/09-	3.0 CDi 350			05/09-	3.5i 350			05/09-	5.5i 500			05/09-	2	<table style="width: 100%; border-collapse: collapse;"> <tr><td>1.8i CGI</td><td></td><td></td><td>05/09-</td></tr> <tr><td>2.1 CDi 250 Coupé</td><td></td><td></td><td>05/09-</td></tr> <tr><td>3.0 CDi 350</td><td></td><td></td><td>05/09-</td></tr> <tr><td>3.5i 350</td><td></td><td></td><td>05/09-</td></tr> <tr><td>5.5i 500</td><td></td><td></td><td>05/09-</td></tr> </table>	1.8i CGI			05/09-	2.1 CDi 250 Coupé			05/09-	3.0 CDi 350			05/09-	3.5i 350			05/09-	5.5i 500			05/09-
1.8i CGI			05/09-																																								
2.1 CDi 250 Coupé			05/09-																																								
3.0 CDi 350			05/09-																																								
3.5i 350			05/09-																																								
5.5i 500			05/09-																																								
1.8i CGI			05/09-																																								
2.1 CDi 250 Coupé			05/09-																																								
3.0 CDi 350			05/09-																																								
3.5i 350			05/09-																																								
5.5i 500			05/09-																																								

Classe E (210) 06/95-03/03 ...



MERCEDES

Eléments DIRECTION
Steering parts
Elementos Direcciones
Elementy układ kierowniczy
Элементы рулевой системы

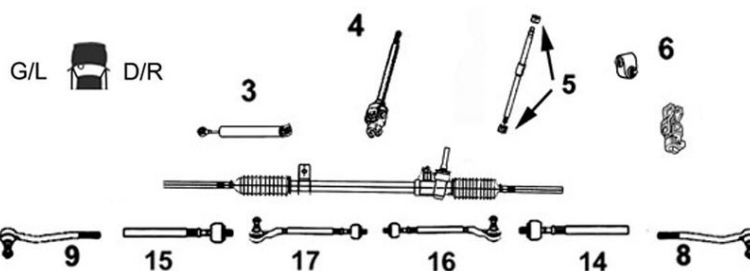

9006841 Axe de bielle G/D

Part/oe 2103380415 *L/R axial joint*

14 Côté dir. M16x1.5 Côté rot. M14x1.5 long 241 mm 15



TT /all models

9006542 Rotule de direction G

OE 2103380515 *Left tie rod end*

9 M14 x 1.5



TT /all models

9006541 Rotule de direction D

OE 2103380615 *Right tie rod end*

8 M14 x 1.5



TT /all models



Barre stabilisatrice
Stabilizer bar
Barra estabilizadora
Drażek stabilizatora
стабилизатор поперечной устойчивости

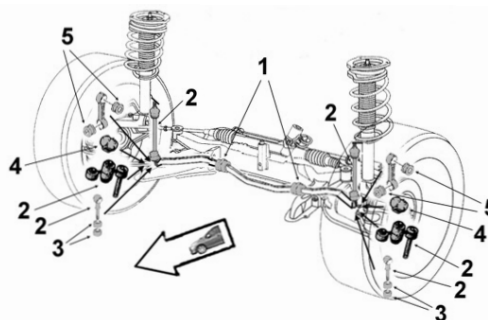

9001797 Palier de barre milieu

OE 1243234985 *Middle bar main bearing*

1 Ø 18



2.8i 280 4-Matic /Break

04/97-12/02

3.2i 320 4-Matic /Break

04/97-12/02

... Classe E (210) 06/95-03/03 ...

Bras & Triangle de suspension

Control arm
Brazo y triángulo
Wahacz
Рычаг подвески

G/L  D/R



MERCEDDES



9005733

Triangle de suspension G sup.

OE 2103302207

Upper left track control arm



4 Avec rotule With ball joint

TT /all models

9005734

Triangle de suspension D sup.

OE 2103308807

Upper right track control arm



3 Avec rotule With ball joint

TT /all models

9005746

Triangle de susp. inf. G

OE 2103307607

Left lower track control arm



4 Sans rotule Without tie rod end

TT /all models

9005744

Triangle de susp. inf. D

OE 2103307707

Right lower track control arm



3 Sans rotule Without tie rod end

TT /all models

9005291

Rotule de susp. inf. G/D

OE 2113300335

L/R lower suspension ball joint



1
2

TT /all models



Barre stabilisatrice

Stabilizer bar
Barra estabilizadora
Drażek stabilizatora
стабилизатор поперечной устойчивости

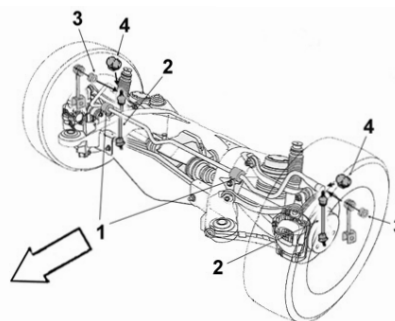

9005040

Biellette barre stab.

OE 1243200289

Stabilizer bar stub axle



2	2.0i 200	Berline	06/95-09/99
	2.1 CDi 200	Berline	07/98-09/99
	2.2 D 220	Berline	06/95-02/99
	2.3i 230	Berline	06/95-09/97
	2.4i 240 /4-Matic	Berline	09/97-09/99
	2.8i 280 /4Matic	Berline	04/97-09/99
	2.9 CDi 290	Berline	01/96-09/99
	3.0 TD 300	Berline	04/97-09/99
	3.2i 320 /4Matic	Berline	06/95-09/99
	4.2i 4.3i 420/30	Berline	09/97-09/99
	5.0i 50 AMG	Berline	07/96-09/97
	5.4i 55 AMG	Berline	09/97-09/99

9005072

Biellette barre stab.

OE 1243200489

Stabilizer bar stub axle



2	2.0i 200	Break	06/96-08/00
	2.1 CDi 220	Break	07/98-12/02
	2.3i 230	Break	06/95-09/97
	2.4i 240	Break	09/97-12/02
	2.7 CDI 270	Break	09/99-12/02
	2.8i 280	Break	04/97-12/02
	2.9 CDi 290	Break	06/96-09/99
	3.0 TD 300	Break	04/97-09/99
	3.2i 320	Break	04/97-12/02
	3.2 CDi 320	Break	09/99-12/02
	4.2i 420	Break	09/97-09/99
	4.3i 430	Break	09/97-12/02
5.4i 55 AMG	Break	07/98-09/99	

... Classe E (210) 06/95-03/03



Eléments SUSPENSION

Suspension parts

Elementos suspensión

Elementy zawieszenie

Элементы подвески

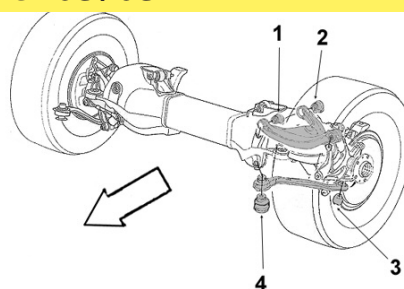

9001606

Articulation inf.

OE 2023520165

Lower bush



4 Ø int.12 Ø ext.33 long. tube int.58 ext.45

2.0i	200	06/95-09/99
2.1 CDi	200 220	07/98-09/99
2.2 D	220	06/95-02/99
2.3i	230	06/95-09/97
2.4i	240	09/97-09/99
2.8i	280 /4Matic	01/96-09/99
2.9 CDi	290	01/96-09/99
3.0 TD	300	04/97-09/99
3.2i	320 /4Matic	04/97-09/99
4.2i 4.3i	420 430	09/97-09/99

9005076

Bielle de réaction AR G/D sup.

OE 2103503306

Rear L/R rack rod upper



2.0i	200 /Komp.	06/95-03/02
2.1 CDi	200 220	07/98-03/02
2.2 D	220	06/95-02/99
2.4i	240	09/97-03/02
2.7 CDi	270	09/99-03/02
2.8i	280 /4Matic	01/96-03/02
2.9 CDi	290	01/96-09/99
3.0 TD	300	04/97-09/99
3.2i	320 /4Matic	01/96-03/02
3.2 CDi	320	09/99-03/02
4.2i	420	09/97-09/99
4.3i	430/4-Matic	09/97-03/02
5.4i	55 AMG	07/98-03/02

9005070

Bielle de réaction G/D inf.

OE 2103503806

Lower L/R track rod



2.0i	200 /Komp.	06/95-03/02
2.1 CDi	200 220	07/98-03/02
2.2 D	220	06/95-02/99
2.4i	240	09/97-03/02
2.7 CDi	270	09/99-03/02
2.8i	280 /4Matic	12/96-03/02
2.9 CDi	290	01/96-09/99
3.0 TD	300	04/97-09/99
3.2i	320 /4Matic	01/96-03/02
3.2 CDi	320	09/99-03/02
4.2i	420	09/97-09/99
4.3i	430/4-Matic	09/97-03/02
5.4i	55 AMG	07/98-03/02

Classe E (211) 03/02- ...

Eléments DIRECTION

Steering parts

Elementos Direcciones

Elementy układ kierowniczy

Элементы рулевой системы

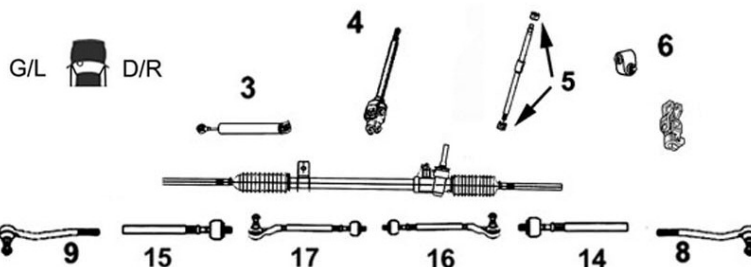

9006840

Axe de bielle G/D

Part/oe 2303380015



L/R axial joint



14 Côté dir. M16x1.5 Côté rot. M14x1.5 long 241 mm

15 1.8i	200 Komp. /Break	09/02-12/09
2.1 CDi	200 220 /Break	01/03-06/06
2.6i	240 /Break	03/02-06/05
2.7 CDi	270 /Break	03/02-06/06
3.0i	280 /Break	06/05-12/09
3.0 CDi	280 320 /Break	06/05-12/09
3.2i	320 V6 18v. /Break	03/02-01/05
3.2 CDi	320 /Break	09/02-06/06
3.5i V6 18v.	350 /Break	01/05-12/09
4.0 CDi	400 420	01/03-12/08
5.0i V8 24v.	500 /Break	03/02-06/06
5.4i	55 AMG /Break	09/02-06/06
6.2i	63 AMG /Break	06/06-12/09

... Classe E (211) 03/02- ...



9006544 OE 2113302703	Rotule de direction G <i>Left tie rod end</i>	9006543 OE 2113302803	Rotule de direction D <i>Right tie rod end</i>
	9 M14 x 1.5		8 M14 x 1.5
	<p>1.8i 16v. Komp 200 /Break 03/03-06/06 1.8i Komp 200 /Break 06/06-12/09 2.1 CDi 220 /Break 03/03-06/06 2.2 CDi 200/20/40/Break 06/06-12/09 2.6i V6 18v. 240 /Break 03/03-12/09 2.7 CDi 270 /Break 03/03-07/09 3.0i 280 /Break 06/05-12/09 3.0 CDi 280 320 /Break 06/05-12/09 3.2i 320 V6 18v. /Break BVA 03/02-01/05 3.2 CDi 320 /Break BVA 11/02-06/06 3.5i 350 /Break BVA 01/08-12/09 3.5i V6 18v.350/Break BVA 01/05-12/09 4.0 CDi 420 FAP BVA 02/03-12/08 5.0i V8 24v.500/Break BVA 03/02-06/06 5.4i V8 24v. Komp 55 AMG /Break BVA 09/02-06/06 5.5i 600 /Break BVA 06/06-12/09 6.2i 63 AMG /Break BVA 06/06-12/09</p>		<p>1.8i 16v. Komp 200 /Break 03/03-06/06 1.8i Komp 200 /Break 06/06-12/09 2.1 CDi 220 /Break 03/03-06/06 2.2 CDi 200/20/40/Break 06/06-12/09 2.6i V6 18v. 240 /Break 03/03-12/09 2.7 CDi 270 /Break 03/03-07/09 3.0i 280 /Break 06/05-12/09 3.0 CDi 280 320 /Break 06/05-12/09 3.2i 320 V6 18v. /Break BVA 03/02-01/05 3.2 CDi 320 /Break BVA 11/02-06/06 3.5i 350 /Break BVA 01/08-12/09 3.5i V6 18v.350/Break BVA 01/05-12/09 4.0 CDi 420 FAP BVA 02/03-12/08 5.0i V8 24v.500/Break BVA 03/02-06/06 5.4i V8 24v. Komp 55 AMG /Break BVA 09/02-06/06 5.5i 600 /Break BVA 06/06-12/09 6.2i 63 AMG /Break BVA 06/06-12/09</p>

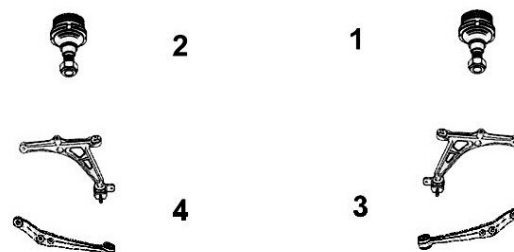

Bras & Triangle de suspension

Control arm
 Brazo y triángulo
 Wahacz
 Рычаг подвески

G/L  D/R



9005739 OE 2113308907	Triangle de susp. sup. G <i>Upper left track control arm</i>	9005738 OE 2113309007	Triangle de susp. sup. D <i>Upper right track control arm</i>
	4 Avec rotule With ball joint		3 Avec rotule With ball joint
	<p>1.8i 200 Komp./Break BVM BVA Séq. 2.1 CDi 200/20/Break BVM BVA Séq. 2.5 230 /Break 2.6i 240 /Break BVM BVA Séq. 2.7 CDi 270 /Break BVM BVA Séq. 3.0i 280 /Break 03/05-12/09 3.0 CDi 280 320 /Break 03/05-12/09 3.2i 320 V6 18v./Break BVA 3.2 CDi 320 280/Break BVA 3.5i V6 18v. 350/Break BVA 03/05-12/09 4.0 CDi 400 420 BVA 5.0i V8 24v. 500/Break BVA5 BVA7 5.4i 55 AMG /Break BVA 6.2i 63 AMG /Break 06/06-12/09</p>		<p>1.8i 200 Komp./Break BVM BVA Séq. 2.1 CDi 200/20/Break BVM BVA Séq. 2.5 230 /Break 2.6i 240 /Break BVM BVA Séq. 2.7 CDi 270 /Break BVM BVA Séq. 3.0i 280 /Break 03/05-12/09 3.0 CDi 280 320 /Break 03/05-12/09 3.2i 320 V6 18v./Break BVA 3.2 CDi 320 280/Break BVA 3.5i V6 18v. 350/Break BVA 03/05-12/09 4.0 CDi 400 420 BVA 5.0i V8 24v. 500/Break BVA5 BVA7 5.4i 55 AMG /Break BVA 6.2i 63 AMG /Break 06/06-12/09</p>

7476063 OE 2113309107	Bras de susp. AR inf. G <i>Left rear lower track control arm</i>	7476062 OE 2113309207	Bras de susp. AR inf. D <i>Right rear lower track control arm</i>
	4 Sans rotule Without ball joint		3 Sans rotule Without ball joint
	<p>1.8i 200 Komp./Break BVMBVA 09/02-12/09 2.1 CDi 200/20/Break BVM BVA 03/02-06/06 2.2 CDi 200 220 240 Break BVM BVA 06/06-12/09 2.6i 240 /Break BVM BVA 03/02-06/05 2.7 CDi 270/Break BVM BVA 03/02-06/05 3.0i 280 /Break BVM BVA 03/05-12/09 3.0 CDi 280 320 /Break BVM BVA 03/05-12/09 3.2i 320 V6 18v. /Break BVA 03/02-01/05 3.2 CDi 320 /Break BVA 09/02-06/05 3.5i V6 18v. 350 /Break BVA 03/05-12/09 4.0 CDi 400 420 BVA 01/03-12/08 5.0i V8 24v. 500/Break BVA 03/02-06/06 5.4i 55 AMG /Break BVA 10/02-06/06 5.5i 600 /Break BVA 06/06-12/09 6.2i 63 AMG /Break BVA 06/06-12/09</p>		<p>1.8i 200 Komp./Break BVMBVA 09/02-12/09 2.1 CDi 200/20/Break BVM BVA 03/02-06/06 2.2 CDi 200 220 240 Break BVM BVA 06/06-12/09 2.6i 240 /Break BVM BVA 03/02-06/05 2.7 CDi 270/Break BVM BVA 03/02-06/05 3.0i 280 /Break BVM BVA 03/05-12/09 3.0 CDi 280 320 /Break BVM BVA 03/05-12/09 3.2i 320 V6 18v. /Break BVA 03/02-01/05 3.2 CDi 320 /Break BVA 09/02-06/05 3.5i V6 18v. 350 /Break BVA 03/05-12/09 4.0 CDi 400 420 BVA 01/03-12/08 5.0i V8 24v. 500/Break BVA 03/02-06/06 5.4i 55 AMG /Break BVA 10/02-06/06 5.5i 600 /Break BVA 06/06-12/09 6.2i 63 AMG /Break BVA 06/06-12/09</p>

... Classe E (211) 03/02- ...

MERCEDES



Bras & Triangle de suspension

Control arm
Brazo y triángulo
Wahacz
Рычаг подвески

G/L D/R

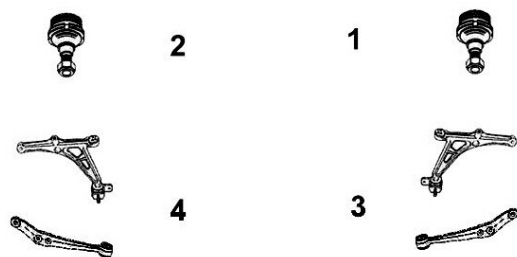

	7476007 OE 2113304311	7476005 OE 2113304411																																																												
	Bras de susp. AV inf. G <i>L front lower track control arm</i>	Bras de susp. AV inf. D <i>R front lower track control arm</i>																																																												
	<p>4 Avec rotule With ball joint</p> <table style="width: 100%; border-collapse: collapse;"> <tr><td style="width: 60%;">1.8i 200 Komp. /Break</td><td style="width: 40%;">06/06-12/09</td></tr> <tr><td>2.1 CDi 200 220 /Break</td><td>03/02-06/06</td></tr> <tr><td>2.2 CDi 200/220/240 FAP /Break</td><td>06/06-12/09</td></tr> <tr><td>2.6i 240 /Break</td><td>03/02-06/05</td></tr> <tr><td>2.7 CDi 270 /Break</td><td>03/02-06/05</td></tr> <tr><td>3.0i 280 /Break</td><td>03/05-12/09</td></tr> <tr><td>3.0 CDi 280 320/Break</td><td>03/05-12/09</td></tr> <tr><td>3.2i 320 V6 18v./Break</td><td>BVA 03/02-01/05</td></tr> <tr><td>3.2 CDi 320 /Break</td><td>BVA 09/02-06/05</td></tr> <tr><td>3.5i V6 18v. 350/Break</td><td>BVA 01/08-12/09</td></tr> <tr><td>4.0 CDi 400 420</td><td>BVA 01/03-12/08</td></tr> <tr><td>5.0i V8 24v. 500/Break</td><td>BVA 03/02-06/06</td></tr> <tr><td>5.4i 55 AMG /Break</td><td>BVA 10/02-06/06</td></tr> <tr><td>5.5i 600 /Break</td><td>BVA 06/06-12/09</td></tr> <tr><td>6.2i 63 AMG/Break</td><td>BVA 06/06-12/09</td></tr> </table>	1.8i 200 Komp. /Break	06/06-12/09	2.1 CDi 200 220 /Break	03/02-06/06	2.2 CDi 200/220/240 FAP /Break	06/06-12/09	2.6i 240 /Break	03/02-06/05	2.7 CDi 270 /Break	03/02-06/05	3.0i 280 /Break	03/05-12/09	3.0 CDi 280 320/Break	03/05-12/09	3.2i 320 V6 18v./Break	BVA 03/02-01/05	3.2 CDi 320 /Break	BVA 09/02-06/05	3.5i V6 18v. 350/Break	BVA 01/08-12/09	4.0 CDi 400 420	BVA 01/03-12/08	5.0i V8 24v. 500/Break	BVA 03/02-06/06	5.4i 55 AMG /Break	BVA 10/02-06/06	5.5i 600 /Break	BVA 06/06-12/09	6.2i 63 AMG/Break	BVA 06/06-12/09	<p>3 Avec rotule With ball joint</p> <table style="width: 100%; border-collapse: collapse;"> <tr><td style="width: 60%;">1.8i 200 Komp. /Break</td><td style="width: 40%;">06/06-12/09</td></tr> <tr><td>2.1 CDi 200 220 /Break</td><td>03/02-06/06</td></tr> <tr><td>2.2 CDi 200/220/240 FAP /Break</td><td>06/06-12/09</td></tr> <tr><td>2.6i 240 /Break</td><td>03/02-06/05</td></tr> <tr><td>2.7 CDi 270 /Break</td><td>03/02-06/05</td></tr> <tr><td>3.0i 280 /Break</td><td>03/05-12/09</td></tr> <tr><td>3.0 CDi 280 320/Break</td><td>03/05-12/09</td></tr> <tr><td>3.2i 320 V6 18v./Break</td><td>BVA 03/02-01/05</td></tr> <tr><td>3.2 CDi 320 /Break</td><td>BVA 09/02-06/05</td></tr> <tr><td>3.5i V6 18v. 350/Break</td><td>BVA 01/08-12/09</td></tr> <tr><td>4.0 CDi 400 420</td><td>BVA 01/03-12/08</td></tr> <tr><td>5.0i V8 24v. 500/Break</td><td>BVA 03/02-06/06</td></tr> <tr><td>5.4i 55 AMG /Break</td><td>BVA 10/02-06/06</td></tr> <tr><td>5.5i 600 /Break</td><td>BVA 06/06-12/09</td></tr> <tr><td>6.2i 63 AMG/Break</td><td>BVA 06/06-12/09</td></tr> </table>	1.8i 200 Komp. /Break	06/06-12/09	2.1 CDi 200 220 /Break	03/02-06/06	2.2 CDi 200/220/240 FAP /Break	06/06-12/09	2.6i 240 /Break	03/02-06/05	2.7 CDi 270 /Break	03/02-06/05	3.0i 280 /Break	03/05-12/09	3.0 CDi 280 320/Break	03/05-12/09	3.2i 320 V6 18v./Break	BVA 03/02-01/05	3.2 CDi 320 /Break	BVA 09/02-06/05	3.5i V6 18v. 350/Break	BVA 01/08-12/09	4.0 CDi 400 420	BVA 01/03-12/08	5.0i V8 24v. 500/Break	BVA 03/02-06/06	5.4i 55 AMG /Break	BVA 10/02-06/06	5.5i 600 /Break	BVA 06/06-12/09	6.2i 63 AMG/Break	BVA 06/06-12/09
1.8i 200 Komp. /Break	06/06-12/09																																																													
2.1 CDi 200 220 /Break	03/02-06/06																																																													
2.2 CDi 200/220/240 FAP /Break	06/06-12/09																																																													
2.6i 240 /Break	03/02-06/05																																																													
2.7 CDi 270 /Break	03/02-06/05																																																													
3.0i 280 /Break	03/05-12/09																																																													
3.0 CDi 280 320/Break	03/05-12/09																																																													
3.2i 320 V6 18v./Break	BVA 03/02-01/05																																																													
3.2 CDi 320 /Break	BVA 09/02-06/05																																																													
3.5i V6 18v. 350/Break	BVA 01/08-12/09																																																													
4.0 CDi 400 420	BVA 01/03-12/08																																																													
5.0i V8 24v. 500/Break	BVA 03/02-06/06																																																													
5.4i 55 AMG /Break	BVA 10/02-06/06																																																													
5.5i 600 /Break	BVA 06/06-12/09																																																													
6.2i 63 AMG/Break	BVA 06/06-12/09																																																													
1.8i 200 Komp. /Break	06/06-12/09																																																													
2.1 CDi 200 220 /Break	03/02-06/06																																																													
2.2 CDi 200/220/240 FAP /Break	06/06-12/09																																																													
2.6i 240 /Break	03/02-06/05																																																													
2.7 CDi 270 /Break	03/02-06/05																																																													
3.0i 280 /Break	03/05-12/09																																																													
3.0 CDi 280 320/Break	03/05-12/09																																																													
3.2i 320 V6 18v./Break	BVA 03/02-01/05																																																													
3.2 CDi 320 /Break	BVA 09/02-06/05																																																													
3.5i V6 18v. 350/Break	BVA 01/08-12/09																																																													
4.0 CDi 400 420	BVA 01/03-12/08																																																													
5.0i V8 24v. 500/Break	BVA 03/02-06/06																																																													
5.4i 55 AMG /Break	BVA 10/02-06/06																																																													
5.5i 600 /Break	BVA 06/06-12/09																																																													
6.2i 63 AMG/Break	BVA 06/06-12/09																																																													

	7576033 OE 0003301007																																				
	Rotule de susp. sup. G/D <i>L/R upper susp. ball joint</i>																																				
	<table style="width: 100%; border-collapse: collapse;"> <tr><td style="width: 5%;">1</td><td style="width: 65%;">1.8i /Komp. 200 /Break</td><td style="width: 30%;">11/02-</td></tr> <tr><td>2</td><td>2.1 CDi 200 /220 /Break</td><td>07/02-</td></tr> <tr><td></td><td>2.6i 240 /Break</td><td>03/02-</td></tr> <tr><td></td><td>2.7 CDi /Break</td><td>03/02-</td></tr> <tr><td></td><td>3.0i 280 300 /Break</td><td>03/05-</td></tr> <tr><td></td><td>3.0 CDi 280 320 /Break</td><td>03/05-</td></tr> <tr><td></td><td>3.2i 320 /Break</td><td>03/02-</td></tr> <tr><td></td><td>3.2 CDi 280 320 /Break</td><td>11/02-</td></tr> <tr><td></td><td>3.5i 350 /Break</td><td>03/05-</td></tr> <tr><td></td><td>4.0 CDi 400 420</td><td>02/03-</td></tr> <tr><td></td><td>5.0i V8 500 /Break</td><td>03/02-</td></tr> <tr><td></td><td>5.4i V8 55AMG /Break</td><td>10/02-</td></tr> </table>	1	1.8i /Komp. 200 /Break	11/02-	2	2.1 CDi 200 /220 /Break	07/02-		2.6i 240 /Break	03/02-		2.7 CDi /Break	03/02-		3.0i 280 300 /Break	03/05-		3.0 CDi 280 320 /Break	03/05-		3.2i 320 /Break	03/02-		3.2 CDi 280 320 /Break	11/02-		3.5i 350 /Break	03/05-		4.0 CDi 400 420	02/03-		5.0i V8 500 /Break	03/02-		5.4i V8 55AMG /Break	10/02-
1	1.8i /Komp. 200 /Break	11/02-																																			
2	2.1 CDi 200 /220 /Break	07/02-																																			
	2.6i 240 /Break	03/02-																																			
	2.7 CDi /Break	03/02-																																			
	3.0i 280 300 /Break	03/05-																																			
	3.0 CDi 280 320 /Break	03/05-																																			
	3.2i 320 /Break	03/02-																																			
	3.2 CDi 280 320 /Break	11/02-																																			
	3.5i 350 /Break	03/05-																																			
	4.0 CDi 400 420	02/03-																																			
	5.0i V8 500 /Break	03/02-																																			
	5.4i V8 55AMG /Break	10/02-																																			

	9005291 OE 2113300335																																													
	Rotule de susp. inf. G/D <i>L/R lower suspension ball joint</i>																																													
	<table style="width: 100%; border-collapse: collapse;"> <tr><td style="width: 5%;">1</td><td colspan="2"></td><td></td><td></td></tr> <tr><td>2</td><td>2.6i V6 18v.</td><td>240 4WD</td><td>BVA</td><td>03/02-06/05</td></tr> <tr><td></td><td>3.0i V6 24v.</td><td>280 4WD</td><td>BVA</td><td>06/05-12/09</td></tr> <tr><td></td><td>3.0 CDi 280</td><td>320 4WD</td><td>BVA</td><td>06/05-12/09</td></tr> <tr><td></td><td>3.2i V6 18v.</td><td>320 4WD</td><td>BVA</td><td>03/02-01/05</td></tr> <tr><td></td><td>3.5i</td><td>350 4WD</td><td>BVA</td><td>01/05-12/09</td></tr> <tr><td></td><td>5.0i V8 24v.</td><td>500 4WD</td><td>BVA</td><td>03/02-06/06</td></tr> <tr><td></td><td>5.5i</td><td>500 4WD Break</td><td>BVA</td><td>06/06-12/09</td></tr> <tr><td></td><td>5.5i</td><td>600 4WD Berline</td><td>BVA</td><td>06/06-12/08</td></tr> </table>	1					2	2.6i V6 18v.	240 4WD	BVA	03/02-06/05		3.0i V6 24v.	280 4WD	BVA	06/05-12/09		3.0 CDi 280	320 4WD	BVA	06/05-12/09		3.2i V6 18v.	320 4WD	BVA	03/02-01/05		3.5i	350 4WD	BVA	01/05-12/09		5.0i V8 24v.	500 4WD	BVA	03/02-06/06		5.5i	500 4WD Break	BVA	06/06-12/09		5.5i	600 4WD Berline	BVA	06/06-12/08
1																																														
2	2.6i V6 18v.	240 4WD	BVA	03/02-06/05																																										
	3.0i V6 24v.	280 4WD	BVA	06/05-12/09																																										
	3.0 CDi 280	320 4WD	BVA	06/05-12/09																																										
	3.2i V6 18v.	320 4WD	BVA	03/02-01/05																																										
	3.5i	350 4WD	BVA	01/05-12/09																																										
	5.0i V8 24v.	500 4WD	BVA	03/02-06/06																																										
	5.5i	500 4WD Break	BVA	06/06-12/09																																										
	5.5i	600 4WD Berline	BVA	06/06-12/08																																										

	9005536 OE 2113300435																																										
	Rotule de susp. inf. G/D <i>L/R lower suspension ball joint</i>																																										
	<table style="width: 100%; border-collapse: collapse;"> <tr><td style="width: 5%;">1</td><td style="width: 65%;">1.8i 200 Komp. /Break</td><td style="width: 30%;">BVM BVA Séq.</td></tr> <tr><td>2</td><td>2.1 CDi 200 220 /Break</td><td>BVM BVA Séq.</td></tr> <tr><td></td><td>2.2 CDi 200 220 Break</td><td>BVM BVA Séq.</td></tr> <tr><td></td><td>2.6i 240 2WD 4ptes</td><td>BVM BVA Séq.</td></tr> <tr><td></td><td>2.7 CDi 270 4ptes</td><td>BVM BVA Séq.</td></tr> <tr><td></td><td>3.0i 280 2WD /Break</td><td>BVM BVA</td></tr> <tr><td></td><td>3.0 CDi 280 320 2WD /Break</td><td>BVM BVA Séq.</td></tr> <tr><td></td><td>3.2i V6 18v. 320 2WD 4ptes/Break</td><td>BVA</td></tr> <tr><td></td><td>3.2 CDi 320 4ptes /Break</td><td>BVA</td></tr> <tr><td></td><td>3.5i V6 18v. 350 2WD /Break</td><td>BVA</td></tr> <tr><td></td><td>4.0 CDi 400 420 4ptes</td><td>BVA</td></tr> <tr><td></td><td>5.0i V8 24v. 500 2WD 4ptes</td><td>BVA5 BVA7</td></tr> <tr><td></td><td>5.4i 55 AMG /Break</td><td>BVA</td></tr> <tr><td></td><td>6.2i 63 AMG /Break</td><td>BVA</td></tr> </table>	1	1.8i 200 Komp. /Break	BVM BVA Séq.	2	2.1 CDi 200 220 /Break	BVM BVA Séq.		2.2 CDi 200 220 Break	BVM BVA Séq.		2.6i 240 2WD 4ptes	BVM BVA Séq.		2.7 CDi 270 4ptes	BVM BVA Séq.		3.0i 280 2WD /Break	BVM BVA		3.0 CDi 280 320 2WD /Break	BVM BVA Séq.		3.2i V6 18v. 320 2WD 4ptes/Break	BVA		3.2 CDi 320 4ptes /Break	BVA		3.5i V6 18v. 350 2WD /Break	BVA		4.0 CDi 400 420 4ptes	BVA		5.0i V8 24v. 500 2WD 4ptes	BVA5 BVA7		5.4i 55 AMG /Break	BVA		6.2i 63 AMG /Break	BVA
1	1.8i 200 Komp. /Break	BVM BVA Séq.																																									
2	2.1 CDi 200 220 /Break	BVM BVA Séq.																																									
	2.2 CDi 200 220 Break	BVM BVA Séq.																																									
	2.6i 240 2WD 4ptes	BVM BVA Séq.																																									
	2.7 CDi 270 4ptes	BVM BVA Séq.																																									
	3.0i 280 2WD /Break	BVM BVA																																									
	3.0 CDi 280 320 2WD /Break	BVM BVA Séq.																																									
	3.2i V6 18v. 320 2WD 4ptes/Break	BVA																																									
	3.2 CDi 320 4ptes /Break	BVA																																									
	3.5i V6 18v. 350 2WD /Break	BVA																																									
	4.0 CDi 400 420 4ptes	BVA																																									
	5.0i V8 24v. 500 2WD 4ptes	BVA5 BVA7																																									
	5.4i 55 AMG /Break	BVA																																									
	6.2i 63 AMG /Break	BVA																																									

... Classe E (211) 03/02-



Barre stabilisatrice

Stabilizer bar

Barra estabilizadora

Drążek stabilizatora

стабилизатор поперечной устойчивости

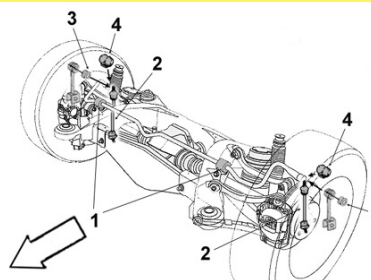

2306103

Biellette barre stab.

OE 2113203389

Stabilizer bar stub axle



2

1.8i 16v. Komp	200 Break	BVM6 BVA5	03/03-06/06
1.8i Komp	200 /Break	BVM6 BVA5	06/06-12/09
2.1 CDi	220 Break	BVM6 BVA5	03/03-06/06
2.2 CDi	200 220 240 /Break	BVM6 BVA5	09/06-12/09
2.6i V6 18v.	240 /4WD /Break	BVM6 BVA5	03/03-06/05
2.7 CDi	270 Break	BVM6 BVA5	03/03-06/06
3.0i	280 /Break	BVM6 BVA7	06/05-12/09
3.0i V6 24v.	280 4WD /Break	BVA5	03/05-12/09
3.0 CDi	280 320/4WD/Break		06/05-12/09
3.2i	320 V6 18v./Break/4WD	BVA5	03/03-01/05
3.2 CDi	320 /Break	BVA5	03/03-06/06
3.5i	350 /4WD /Break	BVA5 BVA7	03/05-12/09
3.5i V6 18v.	350 /Break	BVA7	01/05-12/09
4.0 CDi	420 FAP Berline	BVA7	02/03-12/08
5.0i V8 24v.	500 /Break	BVA7	03/02-06/06
5.4i V8 24v.	Komp 55 AMG/Break	BVA5	09/02-06/06
5.5i	500 4WD Break	BVA5	06/06-12/09
5.5i	600 /4WD /Break	BVA5 BVA7	06/06-12/09
6.2i	63 AMG /Break	BVA7	06/06-12/09

Classe E (212)



Barre stabilisatrice

Stabilizer bar

Barra estabilizadora

Drążek stabilizatora

стабилизатор поперечной устойчивости

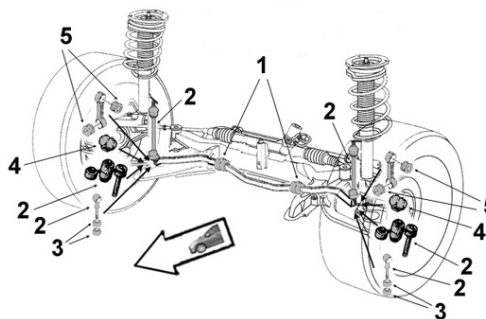

2306039

Biellette barre stab. G

OE 2043200589

Left stabilizer bar stub axle



2

1.8i	200 CGi/Break	10/09-
1.8i	250 Komp. Break	10/09-
2.1 CDi	200 220 250 /Break	03/09-
2.2 CDi	220 250	03/09-
3.0 CDi	250 350 /4WD /Break	03/09-
3.5i	350 /Break	03/09-
5.5i	500 /4WD /Break	03/09-
6.3i	63 AMG	03/09-

2306038

Biellette barre stab. D

OE 2043200489

Right stabilizer bar stub axle



2

1.8i	200 CGi/Break	10/09-
1.8i	250 Komp. Break	10/09-
2.1 CDi	200 220 250 /Break	03/09-
2.2 CDi	220 250	03/09-
3.0 CDi	250 350 /4WD /Break	03/09-
3.5i	350 /Break	03/09-
5.5i	500 /4WD /Break	03/09-
6.3i	63 AMG	03/09-

Classe SL (230) 10/01-

Bras & Triangle de suspension

Control arm
Brazo y triángulo
Wahacz
Рычаг подвески

G/L  D/R

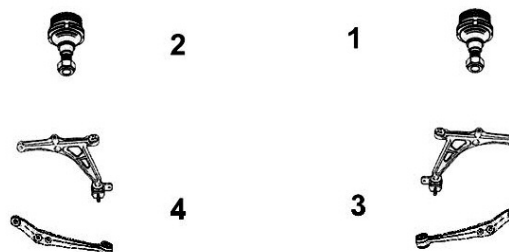

7576033

Rotule de susp. sup. G/D

OE 0003301007

L/R upper susp. ball joint

NEW



1			
2	3.0i	280 300	03/08-01/12
	3.5	350	03/06-01/12
	3.7	350	03/03-01/12
	5.0i	500	10/01-01/12
	5.4	55 AMG /Kompressor	10/01-01/12
	5.5	600	04/03-01/12
	5.5i	500 /55 AMG	03/06-01/12
	6.0	65 AMG	03/04-01/12
	6.2	63 AMG	03/08-01/12

Classe SLK (170) 04/96- ...

Eléments DIRECTION

Steering parts
Elementos Direcciones
Elementy uklad kierowniczy
Элементы рулевой системы

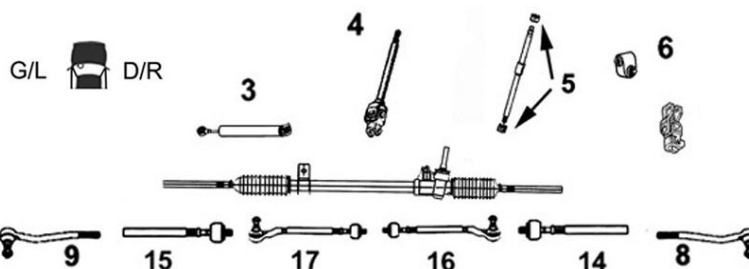

9006530

Rotule de direction G/D

OE 0013307735

L/R tie rod end



8	M12 x 1.5		
9	2.0i	200 Komp	01/00-03/04
	2.3i	230 Komp	01/00-03/04
	3.2i	320 32AMG	11/00-03/04

Bras & Triangle de suspension

Control arm
Brazo y triángulo
Wahacz
Рычаг подвески

G/L  D/R

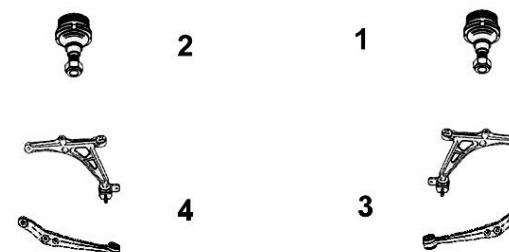

9005733

Triangle de suspension G Sup.

OE 2023304807

Upper left track control arm



4	Avec rotule With ball joint		
	2.0i 200 Komp		-03/04
	2.3i 230 Komp		-03/04
	3.2i 320 / Komp		01/00-03/04

9005734

Triangle de suspension D Sup.



OE 2023304907

Upper right track control arm



3	Avec rotule With ball joint		
	2.0i 200 Komp		-03/04
	2.3i 230 Komp		-03/04
	3.2i 320 / Komp		01/00-03/04

... Classe SLK (170) 04/96-

9005736 OE 1703300107	Triangle de suspension G Inf. <i>Left lower track control arm</i>	9005737 OE 1703300207	Triangle de suspension D Inf. <i>Right lower track control arm</i>
	4 Sans rotule <i>Without tie rod end</i>		3 Sans rotule <i>Without tie rod end</i>
	2.0i 200 /Komp 09/96-03/04 2.3i 230 Komp 09/96-03/04 3.2i 320 32AMG 01/00-03/04		2.0i 200 /Komp 09/96-03/04 2.3i 230 Komp 09/96-03/04 3.2i 320 32AMG 01/00-03/04

9005291 OE 2113300335	Rotule de susp. inf. G/D <i>L/R lower suspension ball joint</i>		
	1 2		
	2.0i 200 09/96-12/99 2.0i Komp 200 01/00-03/04 2.3i Komp 230 09/96-03/04 3.2i 320 01/00-03/04 3.2i Komp 32 AMG 03/01-03/04		

Eléments TRAIN ARRIERE



Rear axle parts

Tren TRAS

Elementy zawieszenia tylnego

элементы задней оси.



9005076 OE 2103503306	Tirant de chasse AR G/D sup. <i>Rear bushing L R upper</i>	9005070 OE 2103503806	Bielle de réaction G/D inf. <i>Lower L/R track rod</i>
	2.0i 200 /Komp 09/96-03/04 2.3i 230 Komp 09/96-03/04 3.2i 320 /Komp 32 AMG 01/00-03/04		2.0i 200 /Komp Ch- F056942 09/96-03/04 2.3i 230 Komp Ch- F056942 09/96-03/04 3.2i 320 /Komp 32 AMG 01/00-03/04

Classe SLK (171) 03/04- ...

Eléments DIRECTION



Steering parts

Elementos Direcciones

Elementy układ kierowniczy

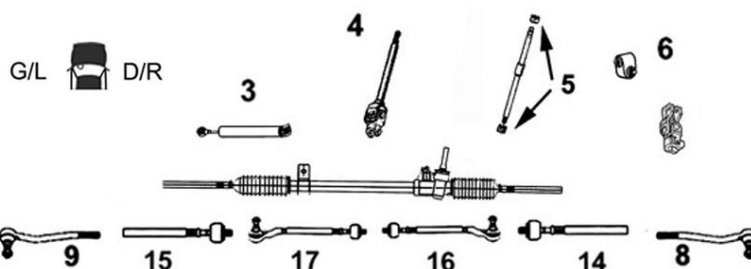
Элементы рулевой системы



9006540 OE 2033303903	Rotule de direction G <i>Left tie rod end</i>	9006539 OE 2033304003	Rotule de direction D <i>Right tie rod end</i>
	9 M14 x 1.5		8 M14 x 1.5
	1.8i 200 Komp 03/04-04/08 3.0i 280 04/05-04/08 3.5i 350 V6 18v. 03/04-04/08 5.4i 55 AMG 03/04-04/08		1.8i 200 Komp 02/04-04/08 3.0i 280 04/05-04/08 3.5i 350 V6 18v. 03/04-04/08 5.4i 55 AMG 03/04-04/08

... Classe SLK (171) 03/04-

SASIC



MERCEDES



Bras & Triangle de suspension

Control arm
Brazo y triángulo
Wahacz
Рычаг подвески

G/L  D/R



7476061 OE 2043301911	Bras de susp. AR inf. G <i>Left rear lower track control arm</i>	7476060 OE 2043302011	Bras de susp. AR inf. D <i>Right rear lower track control arm</i>
	4 Acier steel 1.8i Komp 200 03/04-02/11 3.0i 280 04/05-02/11 3.5i V6 18v. 350 03/04-02/11 5.4i 55 AMG 03/04-02/11		3 Acier steel 1.8i Komp 200 03/04-02/11 3.0i 280 04/05-02/11 3.5i V6 18v. 350 03/04-02/11 5.4i 55 AMG 03/04-02/11

7476002 OE 2033303911	Bras de susp. AR inf. G <i>Left rear lower track control arm</i>	7476001 OE 2033303611	Bras de susp. AR inf. D <i>Right rear lower track control arm</i>
	4 Aluminium aluminium 1.8i 200 Komp 03/04-04/08 3.0i 280 04/05-04/08 3.5i 350 V6 18v. 03/04-04/08 5.4i 55 AMG BVA 03/04-04/08		3 Aluminium aluminium 1.8i 200 Komp 03/04-04/08 3.0i 280 04/05-04/08 3.5i 350 V6 18v. 03/04-04/08 5.4i 55 AMG BVA 03/04-04/08

Eléments TRAIN ARRIERE

Rear axle parts
Tren TRAS
Elementy zawieszenia tylnego
элементы задней оси.



9005076 OE 2103503306	Tirant de chasse AR G/D sup. <i>Rear bushing L R upper</i>
	1.8i 200 Komp 03/04-04/08 3.0i 280 04/05-04/08 3.5i V6 18v. 350 03/04-04/08 5.4i 55 AMG 03/04-04/08

9005070 OE 2103503806	Bielle de réaction G/D inf. <i>Lower L/R track rod</i>
	1.8i 200 Komp 03/04-04/08 3.0i 280 04/05-04/08 3.5i V6 18v. 350 03/04-04/08 5.4i 55 AMG 03/04-04/08

Classe V (638) 10/96- ...

Eléments DIRECTION
Steering parts
Elementos Direcciones
Elementy układ kierowniczy
Элементы рулевой системы

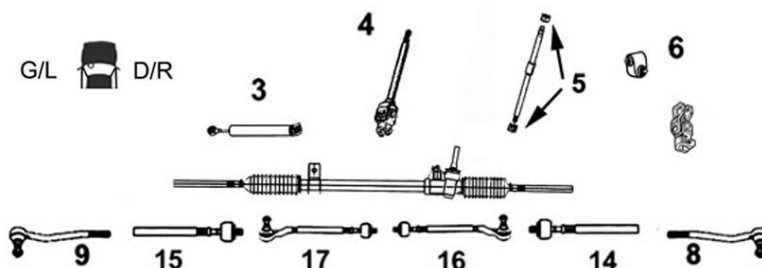



MERCEDES



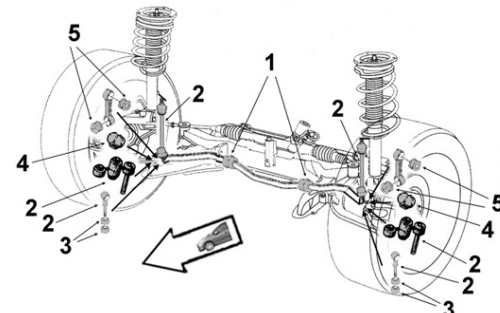

9006843	Axe de bielle G/D
OE 6384600255	L/R axial joint
	14 Côté dir. M16x1.5 Côté rot. M16x1.5 15 long 340 mm 2.0i 200 09/96-10/03 2.2 CDi 200 220 10/98-10/03 2.3i 230 09/96-10/03 2.3 TD 230 09/96-04/00 2.8i 280 BVA 01/98-02/02

9006684	Rotule de direction G/D
OE 6384600048	L/R tie rod end
	14 M16 x 1.5 15 2.0i 200 09/96-10/03 2.2 CDi 200 220 10/98-10/03 2.3i 230 09/96-10/03 2.3 TD 230 09/96-04/00 2.8i 280 BVA 01/98-02/02

 Barre stabilisatrice <i>Stabilizer bar</i> <i>Barra estabilizadora</i> <i>Drażek stabilizatora</i> <i>стабилизатор поперечной устойчивости</i>	
--	---

9005073	Biellette barre stab. G
OE 6383230268	Left stabilizer bar stub axle
	2 Entraxe : 250 mm M10x150 X2 2.0i 200 -ch 267540 02/97- 2.3i 230 -ch 267540 02/97- 2.3 TD 230 09/96-04/00 2.8i 280 -ch 267540 08/97-

9005074	Biellette barre stab. D
OE 6383230368	Right stabilizer bar stub axle
	2 Entraxe : 250 mm M10x150 X2 2.0i 200 -ch 267540 02/97- 2.3i 230 -ch 267540 02/97- 2.3 TD 230 09/96-04/00 2.8i 280 -ch 267540 08/97-

2306042	Biellette barre stab. G
OE 6383230468	Left stabilizer bar stub axle
	2 Entraxe : 230 mm M10x150 X2 2.0i 200 Ch- 267541 -10/03 2.2 CDi 200/20 Ch- 267541 -10/03 2.3i 230 Ch- 267541 -10/03 2.8i 280 BVA Ch- 267541 -02/02

2306041	Biellette barre stab. D
OE 6383230568	Right stabilizer bar stub axle
	2 Entraxe : 230 mm M10x150 X2 2.0i 200 Ch- 267541 -10/03 2.2 CDi 200/20 Ch- 267541 -10/03 2.3i 230 Ch- 267541 -10/03 2.8i 280 BVA Ch- 267541 -02/02

9001614	Palier de barre milieu
OE 6383230285	Middle bar main bearing
	1 Barre Ø 25 2.0i 02/97-07/03 2.2 CDi 03/99-07/03 2.3i 10/96-07/03 2.3 TD 09/96-07/03 2.8i 08/97-07/03

Les réf. constructeurs (OE) ne servent qu'à identifier les pièces et sont données à titre indicatif.

... Classe V (638) 10/96-



Eléments SUSPENSION

Suspension parts
Elementos suspensión
Elementy zawieszenie
Элементы подвески

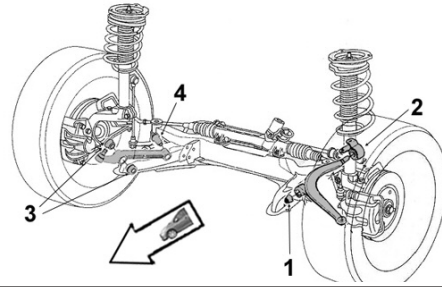

MERCEDÉS



2256028

Articulation AV

OE 6393330314

Front bush



1 Ø int. 14 Ø ext. 42 coll. 51
long. tube int.75 ext.46

2.0i	200	02/97-07/03
2.2 CDi	200 220	10/98-07/03
2.3i	230	09/96-07/03
2.3 TD	230	09/96-04/00
2.8i	280	01/98-02/02

2256029

Articulation AR

OE 6383330814

Rear bush



2 Ø int. 14 Ø ext. 70.5 long. tube int.70
ext.39

2.0i	200	02/97-07/03
2.2 CDi	200 220	10/98-10/03
2.3i	230	09/96-10/03
2.3 TD	230	09/96-04/00
2.8i	280	01/98-02/02

Bras & Triangle de suspension

Control arm
Brazo y triángulo
Wahacz
Рычаг подвески

G/L D/R

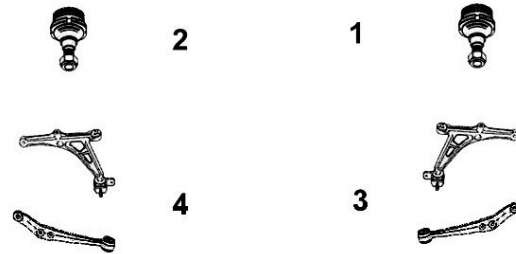

9005741

Triangle de susp. G

OE 6383300010

Left track control arm



4 Avec rotule With ball joint

2.0i	200	09/96-10/03
2.2 CDi	200 220	03/99-07/03
2.3i	230	10/96-07/03
2.3 TD	230	09/96-07/03
2.8i	280	08/97-07/03

9005740

Triangle de susp. D

OE 6383300110

Right track control arm



3 Avec rotule With ball joint

2.0i	200	09/96-10/03
2.2 CDi	200 220	03/99-07/03
2.3i	230	10/96-07/03
2.3 TD	230	09/96-07/03
2.8i	280	08/97-07/03

MB100 ...

Eléments DIRECTION

Steering parts
Elementos Direcciones
Elementy układ kierowniczy
Элементы рулевой системы

G/L D/R

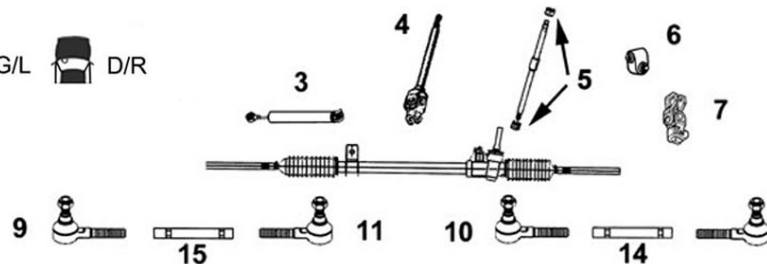

9006844

Bielle de direction G/D

OE 6313300703

L/R steering rod



8
9
10
11
14
15 TT /all models

Ch- 013458 02/88-

... MB100

MERCEDES



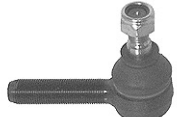

9006532	Rotule de direction D	9006535	Rotule de direction D
OE 0013304835	<i>Right tie rod end</i>	OE 6313380410	<i>Right tie rod end</i>
	8 M20 x 1.5		8 M18 x 1.5
	TT /all models Ch- 013458 02/88-		TT /all models -ch 013457 02/88-

Bras & Triangle de suspension
Control arm
Brazo y triángulo
Wahacz
Рычаг подвески

G/L  D/R

2

1



4



3

9005290	Rotule de susp. inf. G/D
OE 6313200028	<i>L/R lower suspension ball joint</i>
	1 2
	TT /all models 02/88-

Sprinter ...

Eléments DIRECTION
Steering parts
Elementos Direcciones
Elementy uklad kierowniczy
Элементы рулевой системы

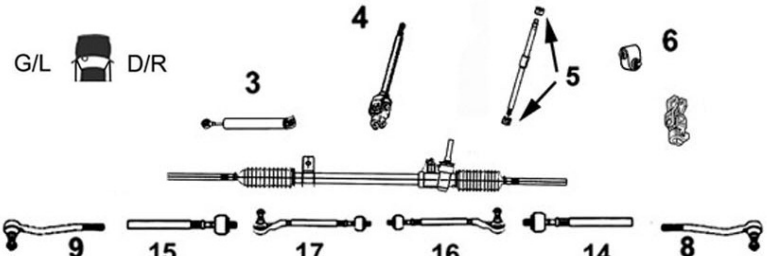
G/L  D/R



7776017	Axe de bielle G/D								
Part/oe 9064600055	<i>L/R axial joint</i>								
	14 Côté dir. M18x1.5 Côté rot. M16x1.5 long 400 mm 15								
	<table style="width: 100%; border: none;"> <tr> <td style="width: 50%;">2.1 CDi</td> <td style="width: 50%;">06/06-</td> </tr> <tr> <td>2.2 CDi</td> <td>06/06-</td> </tr> <tr> <td>3.0 CDi /4WD</td> <td>06/06-</td> </tr> <tr> <td>3.5i</td> <td>BVA 09/06-</td> </tr> </table>	2.1 CDi	06/06-	2.2 CDi	06/06-	3.0 CDi /4WD	06/06-	3.5i	BVA 09/06-
2.1 CDi	06/06-								
2.2 CDi	06/06-								
3.0 CDi /4WD	06/06-								
3.5i	BVA 09/06-								

9006848	Axe de bielle G/D												
Part/oe 9014600205	<i>L/R axial joint</i>												
	14 Côté dir. M16x1.5 Côté rot. M16x1.5 long 380 mm 15												
	<table style="width: 100%; border: none;"> <tr> <td style="width: 50%;">2.2 CDi</td> <td style="width: 50%;">208 211 213 308 311 313</td> <td style="width: 50%;">01/00-05/06</td> </tr> <tr> <td>2.3 D</td> <td>208 308 408</td> <td>01/95-12/00</td> </tr> <tr> <td>2.7 CDi</td> <td>216 316</td> <td>01/00-05/06</td> </tr> <tr> <td>2.9 D</td> <td>212D 312D 412D</td> <td>01/95-12/00</td> </tr> </table>	2.2 CDi	208 211 213 308 311 313	01/00-05/06	2.3 D	208 308 408	01/95-12/00	2.7 CDi	216 316	01/00-05/06	2.9 D	212D 312D 412D	01/95-12/00
2.2 CDi	208 211 213 308 311 313	01/00-05/06											
2.3 D	208 308 408	01/95-12/00											
2.7 CDi	216 316	01/00-05/06											
2.9 D	212D 312D 412D	01/95-12/00											

... Sprinter ...

Eléments DIRECTION
Steering parts
Elementos Direcciones
Elementy układ kierowniczy
Элементы рулевой системы

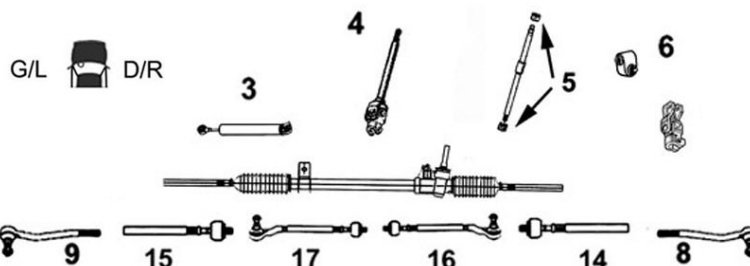

7676010

Rotule de direction G/D

OE 9064600148

L/R tie rod end



8
9

M16 x 1.5

2.1 CDi	06/06-
2.2 CDi /4WD	06/06-
3.0 CDi	06/06-
3.5i	06/06-

9006545

Rotule de direction G/D

OE 9014600148

L/R tie rod end



8
9

M16 x 1.5

2.2 CDi 208/11/13 308/11/13	03/00-05/06
2.3 D 208 308 408	05/95-02/00
2.7 CDi 216 316	03/00-05/06
2.9 D 212D 312 412 2WD	05/95-02/00



Barre stabilisatrice
Stabilizer bar
Barra estabilizadora
Drażek stabilizatora
стабилизатор поперечной устойчивости

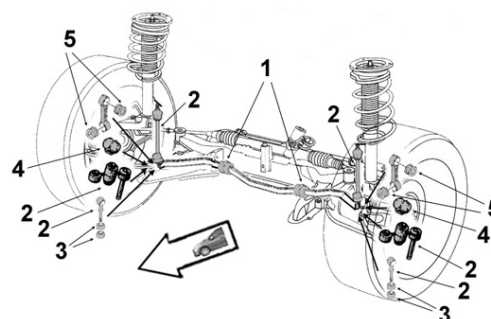

2306144

Biellette barre stab.

OE 9013200389

Stabilizer bar stub axle

NEW



2

2.2 CDi /4WD	311 313 411 413	04/00-05/06
2.2 CDi	208 211 213 308 408	04/00-05/06
2.3i /GNT	214 314 414 /4WD	02/95-05/06
2.3 D	208 308 408	02/95-05/06
2.7 CDi /4WD	316	08/02-05/06
2.7 CDi /4WD	416	04/00-05/06

2306005

Biellette barre stab. G

OE 9063201789

Left stabilizer bar stub axle



2

2.2 CDi 209 309 509	06/06-
2.2 CDi 211 311 511	06/06-
2.2 CDi 213 313	06/06-
2.2 CDi 215 315 515	06/06-
2.2 CDi 310	06/06-
3.0 CDi 218 318 518	06/06-
3.5 224 324	06/06-

2306004

Biellette barre stab. D

OE 9063201889

Right stabilizer bar stub axle



2

2.2 CDi 209 309 509	06/06-
2.2 CDi 211 311 511	06/06-
2.2 CDi 213 313	06/06-
2.2 CDi 215 315 515	06/06-
2.2 CDi 310	06/06-
3.0 CDi 218 318 518	06/06-
3.5 224 324	06/06-

2306075

Palier de barre milieu

OE 9043230085

Middle bar main bearing



1

Ø 25

2.2 CDi 308 311 313 316	
/Essieu renforcé 903.6..	01/00-
2.3 D 408 904312/13/22/23/62/63	
	01/95-12/00
2.9 D 412D 903...	01/95-12/00

2306102

Palier biellette barre stab.

OE 9013230285

Stabilizer bar stub axle Main bearing



5

2.2 CDi	02/95-02/06
2.3i	02/95-02/06
2.3 D	02/95-02/06
2.7 CDi	02/95-02/06
2.9 CDi	02/95-02/06

... Sprinter ...



Eléments SUSPENSION
Suspension parts
Elementos suspensión
Elementy zawieszenie
Элементы подвески

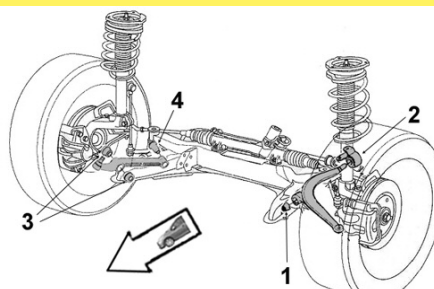

MERCEDES



<p>2256055 Articulation AV OE 9063330014 <i>Front bush</i></p>	<p>2256057 Articulation AR OE 9063330114 <i>Rear bush</i></p>																														
<p>1 Ø int.14 Ø ext. 52 coll. 59 x2 long. tube int.75 ext.48 ep. coll.5x2</p> <table style="width: 100%; border-collapse: collapse;"> <tr><td>1.8i Komp</td><td>906</td><td>06/06-</td></tr> <tr><td>2.1 CDi</td><td>906</td><td>06/06-</td></tr> <tr><td>2.2 CDi</td><td>906</td><td>06/06-</td></tr> <tr><td>3.0 CDi</td><td>906</td><td>06/06-</td></tr> <tr><td>3.5i</td><td>906</td><td>06/06-</td></tr> </table>	1.8i Komp	906	06/06-	2.1 CDi	906	06/06-	2.2 CDi	906	06/06-	3.0 CDi	906	06/06-	3.5i	906	06/06-	<p>2 Ø int.14 Ø ext. 52 coll. 59 x2 long. tube int.75 ext.48 ep. coll.5x2</p> <table style="width: 100%; border-collapse: collapse;"> <tr><td>1.8i Komp</td><td>906</td><td>06/06-</td></tr> <tr><td>2.1 CDi</td><td>906</td><td>06/06-</td></tr> <tr><td>2.2 CDi</td><td>906</td><td>06/06-</td></tr> <tr><td>3.0 CDi</td><td>906</td><td>06/06-</td></tr> <tr><td>3.5i</td><td>906</td><td>06/06-</td></tr> </table>	1.8i Komp	906	06/06-	2.1 CDi	906	06/06-	2.2 CDi	906	06/06-	3.0 CDi	906	06/06-	3.5i	906	06/06-
1.8i Komp	906	06/06-																													
2.1 CDi	906	06/06-																													
2.2 CDi	906	06/06-																													
3.0 CDi	906	06/06-																													
3.5i	906	06/06-																													
1.8i Komp	906	06/06-																													
2.1 CDi	906	06/06-																													
2.2 CDi	906	06/06-																													
3.0 CDi	906	06/06-																													
3.5i	906	06/06-																													

<p>Bras & Triangle de suspension <i>Control arm</i> <i>Brazo y triángulo</i> <i>Wahacz</i> <i>Рычаг подвески</i></p>	<p>G/L D/R</p>	<p>2 </p> <p>4 </p>	<p>1 </p> <p>3 </p>
---	-----------------	-----------------------------------	-----------------------------------

<p>7476111 Triangle de susp. G OE 9063304007 <i>Left track control arm</i></p>	<p>7476112 Triangle de susp. D OE 9063304107 <i>Right track control arm</i></p>																																								
<p>NEW</p>	<p>NEW</p>																																								
<p>4 Avec rotule With ball joint</p> <table style="width: 100%; border-collapse: collapse;"> <tr><td>1.8i 155hp 115kw</td><td>06/06-</td></tr> <tr><td>2.1 CDi 90hp 65kw 110hp 80kw</td><td>06/06-</td></tr> <tr><td>2.1 CDi 130hp 95kw 150hp 110kw</td><td>06/06-</td></tr> <tr><td>2.2 CDi /FAP 90hp 65kw 95hp 70kw</td><td>06/06-</td></tr> <tr><td>110hp 80kw</td><td>06/06-</td></tr> <tr><td>2.2 CDi /FAP 130hp 95kw 150hp</td><td>06/06-</td></tr> <tr><td>110kw 165hp 120kw</td><td>06/06-</td></tr> <tr><td>3.0 CDI/FAP 185hp 135kw 190hp</td><td>140kw</td></tr> <tr><td></td><td>06/06-</td></tr> <tr><td>3.5i 260hp 190kw</td><td>06/06-</td></tr> </table>	1.8i 155hp 115kw	06/06-	2.1 CDi 90hp 65kw 110hp 80kw	06/06-	2.1 CDi 130hp 95kw 150hp 110kw	06/06-	2.2 CDi /FAP 90hp 65kw 95hp 70kw	06/06-	110hp 80kw	06/06-	2.2 CDi /FAP 130hp 95kw 150hp	06/06-	110kw 165hp 120kw	06/06-	3.0 CDI/FAP 185hp 135kw 190hp	140kw		06/06-	3.5i 260hp 190kw	06/06-	<p>3 Avec rotule With ball joint</p> <table style="width: 100%; border-collapse: collapse;"> <tr><td>1.8i 155hp 115kw</td><td>06/06-</td></tr> <tr><td>2.1 CDi 90hp 65kw 110hp 80kw</td><td>06/06-</td></tr> <tr><td>2.1 CDi 130hp 95kw 150hp 110kw</td><td>06/06-</td></tr> <tr><td>2.2 CDi /FAP 90hp 65kw 95hp 70kw</td><td>06/06-</td></tr> <tr><td>110hp 80kw</td><td>06/06-</td></tr> <tr><td>2.2 CDi /FAP 130hp 95kw 150hp</td><td>06/06-</td></tr> <tr><td>110kw 165hp 120kw</td><td>06/06-</td></tr> <tr><td>3.0 CDI/FAP 185hp 135kw 190hp</td><td>140kw</td></tr> <tr><td></td><td>06/06-</td></tr> <tr><td>3.5i 260hp 190kw</td><td>06/06-</td></tr> </table>	1.8i 155hp 115kw	06/06-	2.1 CDi 90hp 65kw 110hp 80kw	06/06-	2.1 CDi 130hp 95kw 150hp 110kw	06/06-	2.2 CDi /FAP 90hp 65kw 95hp 70kw	06/06-	110hp 80kw	06/06-	2.2 CDi /FAP 130hp 95kw 150hp	06/06-	110kw 165hp 120kw	06/06-	3.0 CDI/FAP 185hp 135kw 190hp	140kw		06/06-	3.5i 260hp 190kw	06/06-
1.8i 155hp 115kw	06/06-																																								
2.1 CDi 90hp 65kw 110hp 80kw	06/06-																																								
2.1 CDi 130hp 95kw 150hp 110kw	06/06-																																								
2.2 CDi /FAP 90hp 65kw 95hp 70kw	06/06-																																								
110hp 80kw	06/06-																																								
2.2 CDi /FAP 130hp 95kw 150hp	06/06-																																								
110kw 165hp 120kw	06/06-																																								
3.0 CDI/FAP 185hp 135kw 190hp	140kw																																								
	06/06-																																								
3.5i 260hp 190kw	06/06-																																								
1.8i 155hp 115kw	06/06-																																								
2.1 CDi 90hp 65kw 110hp 80kw	06/06-																																								
2.1 CDi 130hp 95kw 150hp 110kw	06/06-																																								
2.2 CDi /FAP 90hp 65kw 95hp 70kw	06/06-																																								
110hp 80kw	06/06-																																								
2.2 CDi /FAP 130hp 95kw 150hp	06/06-																																								
110kw 165hp 120kw	06/06-																																								
3.0 CDI/FAP 185hp 135kw 190hp	140kw																																								
	06/06-																																								
3.5i 260hp 190kw	06/06-																																								

<p>7476151 Triangle de susp. G OE 9013302407 <i>Left track control arm</i></p>	<p>7476150 Triangle de susp. D OE 9013302507 <i>Right track control arm</i></p>												
<p>NEW</p>	<p>NEW</p>												
<p>4 Avec rotule With ball joint</p> <table style="width: 100%; border-collapse: collapse;"> <tr><td>2.2 CDi 80hp 60kw 110hp 80kw</td><td></td></tr> <tr><td>130hp 95kw Fourgon Combi</td><td>03/00-06/06</td></tr> <tr><td>2.7 CDi 155hp 115kw Fourgon Combi</td><td>03/00-06/06</td></tr> </table>	2.2 CDi 80hp 60kw 110hp 80kw		130hp 95kw Fourgon Combi	03/00-06/06	2.7 CDi 155hp 115kw Fourgon Combi	03/00-06/06	<p>3 Avec rotule With ball joint</p> <table style="width: 100%; border-collapse: collapse;"> <tr><td>2.2 CDi 80hp 60kw 110hp 80kw</td><td></td></tr> <tr><td>130hp 95kw Fourgon Combi</td><td>03/00-06/06</td></tr> <tr><td>2.7 CDi 155hp 115kw Fourgon Combi</td><td>03/00-06/06</td></tr> </table>	2.2 CDi 80hp 60kw 110hp 80kw		130hp 95kw Fourgon Combi	03/00-06/06	2.7 CDi 155hp 115kw Fourgon Combi	03/00-06/06
2.2 CDi 80hp 60kw 110hp 80kw													
130hp 95kw Fourgon Combi	03/00-06/06												
2.7 CDi 155hp 115kw Fourgon Combi	03/00-06/06												
2.2 CDi 80hp 60kw 110hp 80kw													
130hp 95kw Fourgon Combi	03/00-06/06												
2.7 CDi 155hp 115kw Fourgon Combi	03/00-06/06												

<p>9005538 OE 9013331227</p>	<p>Rotule de susp. inf. G/D <i>L/R lower suspension ball joint</i></p>																		
	<p>1/2</p> <table style="width: 100%; border-collapse: collapse;"> <tr><td>2.2 CDi</td><td>208 308 408</td><td>01/00-05/06</td></tr> <tr><td>2.2 CDi</td><td>211 311 411</td><td>01/00-05/06</td></tr> <tr><td>2.2 CDi</td><td>213 313 413</td><td>01/00-05/06</td></tr> <tr><td>2.3 D</td><td>208 308 408</td><td>01/95-12/00</td></tr> <tr><td>2.7 CDi</td><td>216 316 416</td><td>01/00-05/06</td></tr> <tr><td>2.9 D</td><td>212D 312D 412D</td><td>01/95-12/00</td></tr> </table>	2.2 CDi	208 308 408	01/00-05/06	2.2 CDi	211 311 411	01/00-05/06	2.2 CDi	213 313 413	01/00-05/06	2.3 D	208 308 408	01/95-12/00	2.7 CDi	216 316 416	01/00-05/06	2.9 D	212D 312D 412D	01/95-12/00
2.2 CDi	208 308 408	01/00-05/06																	
2.2 CDi	211 311 411	01/00-05/06																	
2.2 CDi	213 313 413	01/00-05/06																	
2.3 D	208 308 408	01/95-12/00																	
2.7 CDi	216 316 416	01/00-05/06																	
2.9 D	212D 312D 412D	01/95-12/00																	

... Sprinter



MERCEDES



Support d'amortisseur
Suspension mounting
Soporte amortiguador
Poduszka amortyzatora
Опора амортизатора

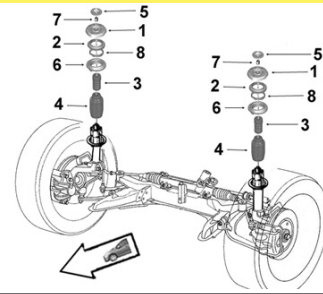

2656022 **Support suspension G/D**
 OE 9013230085 *L/R suspension mounting*



1	2.2 CDi	208 308 408	03/00-
	2.2 CDi	211 311 411	03/00-
	2.2 CDi	213 313 413	03/00-
	2.3 D	208 308 408	02/95-02/00
	2.7 CDi	216 316 416	03/00-
	2.9 D	212D 312D 412D	02/95-02/00



Barre stabilisatrice
Stabilizer bar
Barra estabilizadora
Drażek stabilizatora
стабилизатор поперечной устойчивости

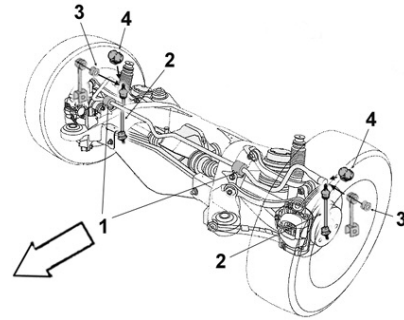

2306131 **Palier de barre milieu**
 OE 9013260081 *Middle bar main bearing*

NEW



1	Ø 21.6	2.2 CDi	311 313 3000 Kg	611981 /7 611DELA	BVM BVA	12/99-06/06
		2.3i	2000 kg 314 3000Kg	111984	BVM	03/00-06/06
		2.3i	214 314 414 2000 kg	111979	BVM BVA	05/95-06/06
		2.3 D	208 308 408 2000 kg	601943 /V	BVM	05/95-03/00
			308 3000 Kg			
		2.7 CDi	3000 Kg	612981	BVM BVA	03/00-06/06
		2.9 CDi	3000 Kg	602980 /VI	BVM BVA	05/95-06/06
		2.9 CDi	210 2000 kg	602980	BVA	05/95-11/99
		2.9 CDI	212 2000 kg	602980 /VI	BVM BVA	05/95-03/00
		2.9 D	2000 kg	602	BVM	05/95-03/00

2306101 **Palier de barre milieu**
 OE 9043260881 *Middle bar main bearing*



1	Ø 27	2.2 CDi	02/95-02/06
		2.2 CDi	02/06-
		2.3i	02/95-02/06
		2.3 D	02/95-02/06
		2.7 CDi	02/95-02/06
		2.9 CDi	02/95-02/06
		3.0 CDi	02/06-

2306100 **Art. barre stab. bout**
 OE 6013210350 *End Stabilizer bar bush*



3	Ø int.12 Ø ext.26.6 coll.30.5 long. tube int. 26 ext. 12.8 ep. coll. 4X2	2.1 CDi	02/95-07/09
		2.2 CDi	02/95-07/09
		2.3i	02/95-07/09
		2.3 D 2.4 D	02/95-07/09
		2.7 CDi	02/95-07/09
		2.9 CDi	02/95-07/09
		2.9 D	02/95-07/09
		3.0 CDi	02/95-07/09
		3.5i	02/95-07/09

Transporter /T1

Eléments DIRECTION
Steering parts
Elementos Direcciones
Elementy układ kierowniczy
Элементы рулевой системы

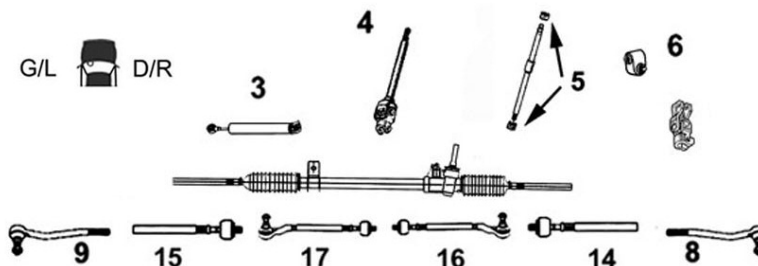

9006680

Rotule de direction G

OE 6013300535

Left tie rod end



9 M20 x 1.5

2.3 D 208 Fourgon 601361 602366
 2.3 D 308 Fourgon 601361 602366
 Empattement 3050mm

2.4 D 207 307 65hp 48kw 72hp 53kw
 601361 602366

9006681

Rotule de direction D

OE 6013300435

Right tie rod end



8 M20 x 1.5

2.3 D 208 Fourgon 601361 602366
 2.3 D 308 Fourgon 601361 602366
 Empattement 3050mm

2.4 D 207 307 65hp 48kw 72hp 53kw
 601361 602366



Barre stabilisatrice

Stabilizer bar

Barra estabilizadora

Drażek stabilizatora

стабилизатор поперечной устойчивости

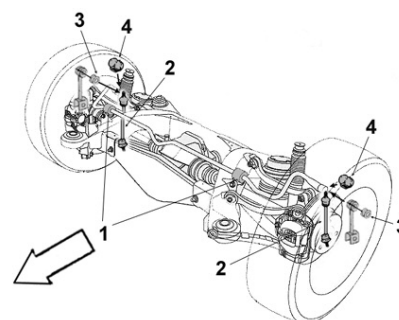

2306100

Art. barre stab. bout

OE 6013210350

End Stabilizer bar bush



3 Ø int.12 Ø ext.26.6 coll.30.5 long. tube int. 26 ext. 12.8 ep. coll. 4X2

2.3
 2.3 D
 2.4 D
 2.9 D
 3.0 D

04/77-02/96
 04/77-02/96
 04/77-02/96
 04/77-02/96
 04/77-02/96

Vaneo 02/02-



Barre stabilisatrice

Stabilizer bar

Barra estabilizadora

Drażek stabilizatora

стабилизатор поперечной устойчивости

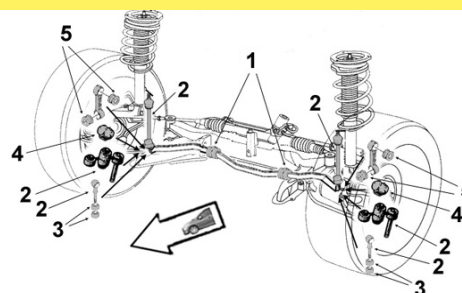

2306040

Biellette barre stab.

OE 4143200389

Stabilizer bar stub axle



2

1.6i
 1.7 CDi
 1.9i

01/02-06/05
 01/02-06/05
 01/02-06/05

Viano ...

Eléments DIRECTION

Steering parts

Elementos Direcciones

Elementy układ kierowniczy

Элементы рулевой системы

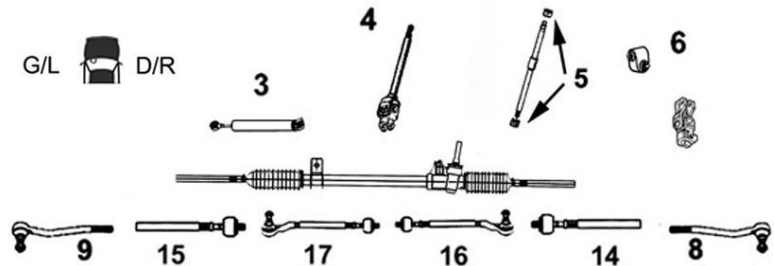

9006847

Axe de bielle G/D

OE 6394600255

L/R axial joint



14 Côté dir. M16x1.5 Côté rot. M16x1.5 long 284 mm

15

2.2 CDi /4WD

10/03-10/10

3.0i

10/03-09/07

3.0 CDi

02/06-10/10

3.2i

10/03-09/07

3.5

09/07-

3.7

01/05-09/07

9006679

Rotule de direction G

OE 6394600648

Left tie rod end



9 M16 x 1.5

2.2 CDi 110hp 80kw 646982 10/03-09/06

2.2 CDi /4WD 115hp 85kw
646980 05/07-10/10

2.2 CDi /4WD 150hp 110kw
646982 10/03-10/10

3.0i 190hp 140kw 112951 10/03-09/07

3.0 CDi 205hp 150kw
642990 02/06-10/10

3.2i 190hp 140kw 112951 10/03-09/07

3.2i 220hp 160kw 112951 10/03-12/04

3.7i 230hp 170kw 112976 01/05-09/07

9006678

Rotule de direction D

OE 6394600748

Right tie rod end



8 M16 x 1.5

2.2 CDi 110hp 80kw 646982 10/03-09/06

2.2 CDi /4WD 115hp 85kw
646980 05/07-10/10

2.2 CDi /4WD 150hp 110kw
646982 10/03-10/10

3.0i 190hp 140kw 112951 10/03-09/07

3.0 CDi 205hp 150kw
642990 02/06-10/10

3.2i 190hp 140kw 112951 10/03-09/07

3.2i 220hp 160kw 112951 10/03-12/04

3.7i 230hp 170kw 112976 01/05-09/07



Barre stabilisatrice

Stabilizer bar

Barra estabilizadora

Drażek stabilizatora

стабилизатор поперечной устойчивости

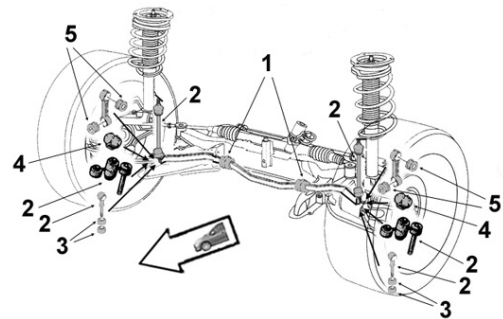

2306044

Biellette barre stab. G

OE 6393200489

Left stabilizer bar stub axle



2 Entraxe : 280 mm M12x150 X2

2.2 CDi /4WD 10/03-

3.0i BVA 10/03-09/07

3.0 CDi BVA 02/06-

3.2i BVA 10/03-09/07

3.7i BVA 06/04-09/07

2306043

Biellette barre stab. D

OE 6393200589

Right stabilizer bar stub axle



2 Entraxe : 280 mm M12x150 X2

2.2 CDi /4WD 10/03-

3.0i BVA 10/03-09/07

3.0 CDi BVA 02/06-

3.2i BVA 10/03-09/07

3.7i BVA 06/04-09/07

...Viano ...



Eléments SUSPENSION

Suspension parts
Elementos suspensión
Elementy zawieszenie
Элементы подвески

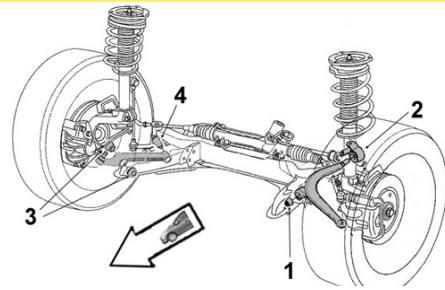

2256028

Articulation AV

OE 6393330314

Front bush

1 Ø int. 14 Ø ext. 42 coll. 51 long. tube int.75 ext.46



2.2 CDi /4WD
3.0i
3.0 CDi
3.2i
3.7i

10/03-
10/03-09/07
02/06-
10/03-09/07
01/05-09/07

Bras & Triangle de suspension

Control arm
Brazo y triángulo
Wahacz
Рычаг подвески

G/L D/R



7476213

Triangle de susp. G

OE 6393300810

Left track control arm

NEW

4 Avec rotule With ball joint Ø 22



2.2 DCi /4-matic	09/03-
3.0i	09/03-
3.0 CDi	03/06-
3.2i	09/03-
3.5i	09/07-
3.7i	06/04-

7476212

Triangle de susp. D

OE 6393300910

Right track control arm

NEW

3 Avec rotule With ball joint Ø 22



2.2 DCi /4-matic	09/03-
3.0i	09/03-
3.0 CDi	03/06-
3.2i	09/03-
3.5i	09/07-
3.7i	06/04-



Support d'amortisseur

Suspension mounting
Soporte amortiguador
Poduszka amortyzatora
Опора амортизатора

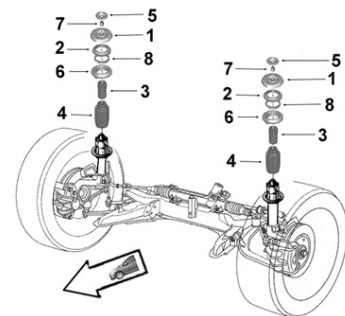

2656038

Butée à billes G/D

OE 6399810325

L/R ball bearing

2



2.2 CDi	110hp 80kw	646982	10/03-09/06
2.2 CDi	115hp 85kw	646980	05/07-10/10
2.2 CDi	150hp 110kw	646982	10/03-10/10
3.0i	190hp 140kw	112951	10/03-09/07
3.0 CDi	205hp 150kw	642990	05/07-10/10
3.2i	190hp 140kw	112951	10/03-09/07
3.2i	220hp 160kw	112951	10/03-12/04
3.7i	230hp 170kw	112976	01/05-09/07

Vito ...

Eléments DIRECTION
Steering parts
Elementos Direcciones
Elementy uklad kierowniczy
Элементы рулевой системы

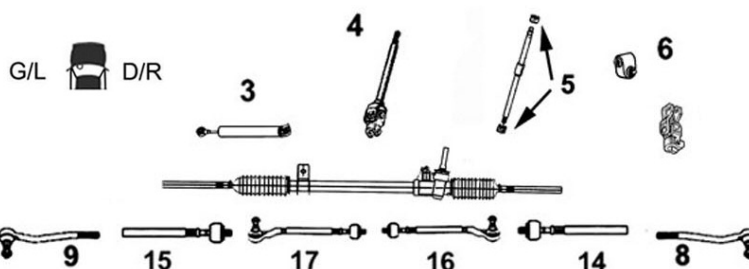

9006843

Axe de bielle G/D

OE 6384600055

L/R axial joint



14 Côté dir. M16x1.5 Côté rot. M16x1.5
 15 long 340 mm

TT /all models 638 02/96-08/03

9006847

Axe de bielle G/D

OE 6394600055

L/R axial joint



14 Côté dir. M16x1.5 Côté rot. M16x1.5
 15 long 284 mm

TT /all models 639 01/04-

9006684

Rotule de direction G/D

OE 6384600048

L/R tie rod end



8 M16 x 1.5
 9

TT /all models 638

02/96-12/04

9006679

Rotule de direction G

OE 6394600048

Left tie rod end



9 M16 x 1.5

TT /all models 639 01/04-

9006678

Rotule de direction D

OE 6394600348

Right tie rod end



8 M16 x 1.5

TT /all models 639 01/04-



Barre stabilisatrice

Stabilizer bar
Barra estabilizadora
Drażek stabilizatora
стабилизатор поперечной устойчивости

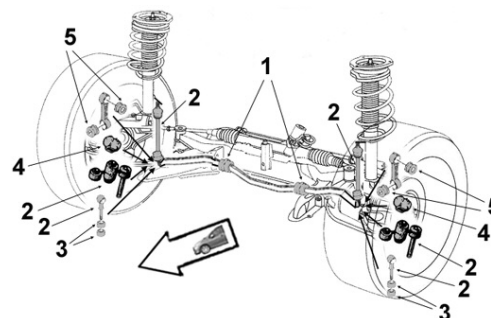

9005073

Biellette barre stab. G

OE 6383230268

Left stabilizer bar stub axle



2 Entraxe : 250 mm M10x150 X2
 2.0i 113 114 /VP Châssis Cabine
 -ch 267540 -22/12/99
 2.3i 114 /VP Châssis Cabine
 -ch 267540 -22/12/99
 2.3 D 108 /VP 04/96-02/00
 2.3 TD 110 /VP 04/96-02/00

9005074

Biellette barre stab. D

OE 6383230368

Right stabilizer bar stub axle













2 Entraxe : 250 mm M10x150 X2
 2.0i 113 114 /VP Châssis Cabine
 -ch 267540 -22/12/99
 2.3i 114 /VP Châssis Cabine
 -ch 267540 -22/12/99
 2.3 D 108 /VP 04/96-02/00
 2.3 TD 110 /VP 04/96-02/00

... Vito ...

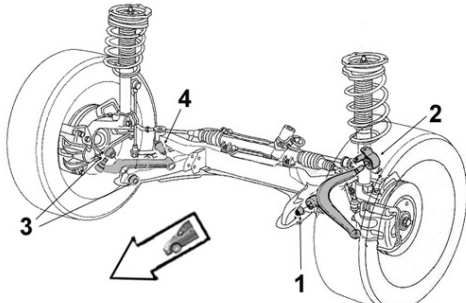
MERCEDES



<p>2306042 OE 6383230468</p> 	<p>Biellette barre stab. G <i>Left stabilizer bar stub axle</i></p> <p>2 Entraxe : 230 mm M10x150 X2</p> <p>2.0i 113 114 /VP Châssis Cabine Ch- 267541 23/12/99- 2.2 CDi 108 110 112 12/98-10/03 2.3i 114 /VP Châssis Cabine Ch- 267541 23/12/99-</p>	<p>2306041 OE 6383230568</p> 	<p>Biellette barre stab. D <i>Right stabilizer bar stub axle</i></p> <p>2 Entraxe : 230 mm M10x150 X2</p> <p>2.0i 113 114 /VP Châssis Cabine Ch- 267541 23/12/99- 2.2 CDi 108 110 112 12/98-10/03 2.3i 114 /VP Châssis Cabine Ch- 267541 23/12/99-</p>
<p>2306044 OE 6393200489</p> 	<p>Biellette barre stab. G <i>Left stabilizer bar stub axle</i></p> <p>2 Entraxe : 280 mm M12x150 X2</p> <p>2.2 CDi 109 111 115 /4WD 10/03-09/06 3.0i 119 BVA 10/03-09/07 3.2i 122 BVA 06/04-09/07 3.7i BVA 06/04-09/07</p>	<p>2306043 OE 6393200589</p> 	<p>Biellette barre stab. D <i>Right stabilizer bar stub axle</i></p> <p>2 Entraxe : 280 mm M12x150 X2</p> <p>2.2 CDi 109 111 115 /4WD 10/03-09/06 3.0i 119 BVA 10/03-09/07 3.2i 122 BVA 06/04-09/07 3.7i BVA 06/04-09/07</p>
<p>9001614 OE 6383230285</p>  <p>1 Barre Ø 25</p> <p>2.0i 113 114 2.2 CDi 108 110 112 /VP 2.3i 114 2.3 D 108 / VP 2.3 TD 110 / VP</p>			
 <p>Eléments SUSPENSION <i>Suspension parts</i> <i>Elementos suspensión</i> <i>Elementy zawieszenia</i> <i>Элементы подвески</i></p>			
<p>2256028 OE 6393330314</p> 	<p>Articulation AV <i>Front bush</i></p> <p>1 Ø int. 14 Ø ext. 42 coll. 51 long. tube int.75 ext.46</p> <p>2.0i 113 114 04/96-10/03 2.2 CDi 108 110 112 09/96-10/03 2.3i 114 12/96-10/03 2.3 D 108 04/96-10/03 2.3 TD 110 04/96-10/03</p>	<p>2256029 OE 6383330814</p> 	<p>Articulation AR <i>Rear bush</i></p> <p>2 Ø int. 14 Ø ext. 70.5 long. tube int.70 ext.39</p> <p>2.0i 113 114 04/96-10/03 2.2 CDi 108 110 112 09/96-10/03 2.3i 114 12/96-10/03 2.3 D 108 04/96-10/03 2.3 TD 110 04/96-10/03</p>
<p>2256028 OE 6393330314</p>  <p>1 Ø int. 14 Ø ext. 42 coll. 51 long. tube int.75 ext.46</p> <p>2</p> <p>2.2 CDi 109 111 115 /4WD 10/03- 3.0i 119 BVA 10/03-09/07 3.0 CDi BVA 02/06- 3.2i 122 BVA 10/03-01/05 3.7i BVA 06/04-09/07</p>			

... Vito ...

Bras & Triangle de suspension

Control arm
Brazo y triángulo
Wahacz
Рычаг подвески

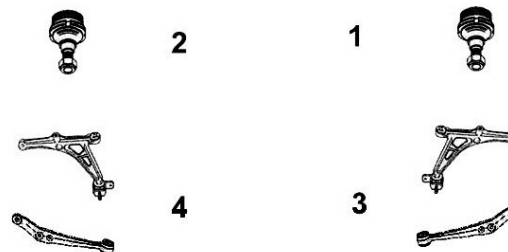

9005741 Triangle de susp. G
OE 6383300010 Left track control arm

4 Avec rotule With ball joint

TT /all models 638 02/96-08/03



9005740 Triangle de susp. D
OE 6383300110 Right track control arm

3 Avec rotule With ball joint

TT /all models 638 02/96-08/03



7476213 Triangle de susp. G
OE 6393300810 Left track control arm

NEW **4** Avec rotule With ball joint Ø 22

2.2 CDi /4WD	639	09/03-
3.0i	639	09/03-
3.0 CDi	639	09/03-
3.2i	639	09/03-
3.5i	639	09/07-
3.7i		06/04-



7476212 Triangle de susp. D
OE 6393300910 Right track control arm

NEW **3** Avec rotule With ball joint Ø 22

2.2 CDi /4WD	639	09/03-
3.0i	639	09/03-
3.0 CDi	639	09/03-
3.2i	639	09/03-
3.5i	639	09/07-
3.7i		06/04-



9005534 Rotule de susp. inf. G/D
OE 6383330027 L/R lower suspension ball joint

1
2

TT /all models 638 02/96-12/04



9005537 Rotule de susp. inf. G/D
Part/oe 6393300410 L/R lower suspension ball joint

1
2

TT /all models 639 01/04-



Support d'amortisseur

Suspension mounting
Soporte amortiguador
Poduszka amortyzatora
Опора амортизатора

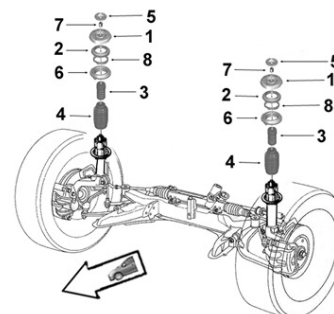

2656038 Butée à billes G/D
OE 6399810325 L/R ball bearing

2

2.2 CDi	109 111 115 /4WD	10/03-09/10
3.0i	119	10/03-09/07
3.0 CDi		02/06-09/10
3.2i	122	10/03-01/05
3.7i		01/05-09/07



...Vito



Eléments SUSPENSION
Suspension parts
Elementos suspensión
Elementy zawieszenie
Элементы подвески

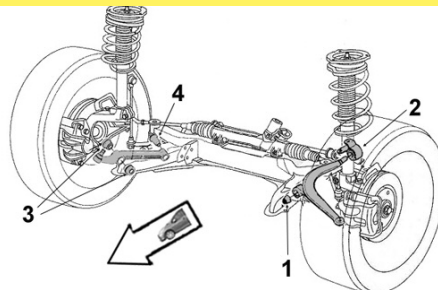

MERCEDDES



MINI



2256048

Art. AV/AR triangle inf.

OE 6393530050

Lower track control Arm Bush F/R



1 Ø int.14 Ø ext.47 coll.54 x2 long. tube int.75 ext.48 ep. coll.6X2

2.2 CDi	109 111 115 /4WD /VP	BVA5	10/03-09/10
3.0i	119	BVA5	10/03-09/07
3.0 CDi	205hp 150kw	BVA5	02/06-09/10
3.2i	122	BVA5	10/03-01/05
3.7i	230hp 170kw VL	BVA5	06/04-09/07

Mini I R50 R53 06/01-09/06 ...

Eléments DIRECTION

Steering parts
Elementos Direcciones
Elementy układ kierowniczy
Элементы рулевой системы

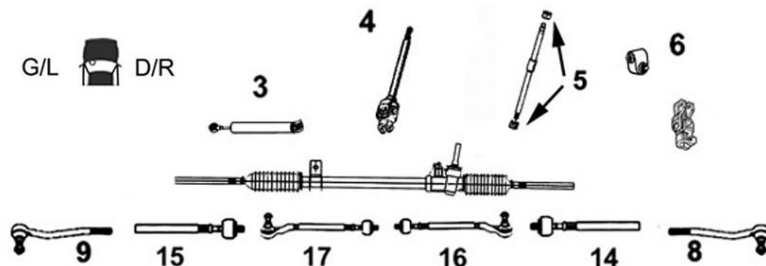

9006813

Axe de bielle G/D

Part/oe 32116780786 *L/R axial joint*



14 Côté dir. M16x1.5 Côté rot. M14x1.5 long 184 mm
15

1.6i 16v. One 90hp 66kw /Cooper	115hp 85kw	-01/05/03
1.6i 16v. Cooper S 165hp	120kw	-01/05/03

9006427

Rotule de direction G

OE 32216754565

Left tie rod end



9 M14 x 1.5 long mm 250

1.4 D One 75hp 55kw 90hp 65kw	-05/03
1.6i 16v. One 90hp 66kw /Cooper	115hp 85kw -05/03
1.6i 16v. Cooper S 165hp	120kw -05/03

9006424

Rotule de direction D

OE 32216754566

Right tie rod end



8 M14 x 1.5 long mm 250

1.4 D One 75hp 55kw 90hp 65kw	-05/03
1.6i 16v. One 90hp 66kw /Cooper	115hp 85kw -05/03
1.6i 16v. Cooper S 165hp	120kw -05/03

7676059

Rotule de direction G

OE 32136761559

Left tie rod end



NEW

9 M14 x 1.5 long 255 mm

1.4 D One 75hp 55kw 90hp 65kw	06/03-
1.6i 16v. One 90hp 66kw /Cooper	115hp 85kw 06/03-
1.6i 16v. Cooper S 165hp	120kw 06/03-
1.6i 16v. Cooper S 165hp	170hp 125kw 06/03-
1.6i 16v. JCW 210hp	155kw 06/03-

9006425

Rotule de direction D

OE 32116761560

Right tie rod end



8 M14 x 1.5 long 255 mm

1.4 D One 75hp 55kw 90hp 65kw	06/03-
1.6i 16v. One 90hp 66kw /Cooper	115hp 85kw 06/03-
1.6i 16v. Cooper S 165hp	120kw 06/03-
1.6i 16v. Cooper S 165hp	170hp 125kw 06/03-
1.6i 16v. JCW 210hp	155kw 06/03-

...Mini I R50 R53 06/01-09/06...

SASIC

MINI



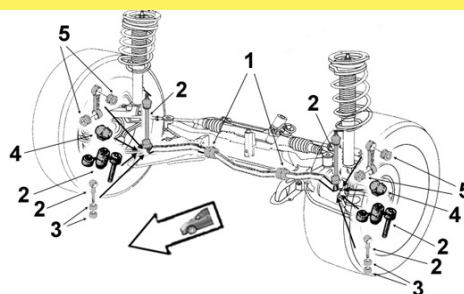

Barre stabilisatrice
 Stabilizer bar
 Barra estabilizadora
 Drażek stabilizatora
 стабилизатор поперечной устойчивости



9005026	Biellette barre stab.	
OE 31351507989	<i>Stabilizer bar stub axle</i>	
	2	1.6i 16v. One 90hp 66kw /Cooper 115hp 85kw -01/03/02

9005028	Biellette barre stab.	
OE 31356778831	<i>Stabilizer bar stub axle</i>	
	2	1.4 D One 75hp 55kw 90hp 65kw 1.6i 16v. One 90hp 66kw /Cooper 115hp 85kw 01/03/02- 1.6i 16v. Cooper S 165hp 120kw 170hp 125kw 1.6i 16v. JCW 210hp 155kw 03/05-

2306077	Palier de barre milieu	
OE 31356757069	<i>Middle bar main bearing</i>	
	1 Ø 16	1.4 D One 75hp 55kw -09/05 1.6i 16v. One 90hp 66kw -09/05

2306078	Palier de barre milieu	
OE 31356757146	<i>Middle bar main bearing</i>	
	1 Ø 22.5	1.4 D One 75hp 55kw Susp. sport -09/05 1.6i 16v. One 90hp 66kw Susp. sport 1.6i 16v. Cooper 115hp 85kw

2306081	Palier de barre milieu	
OE 31356758302	<i>Middle bar main bearing</i>	
	1 Ø 24	1.6i 16v. One 90hp 66kw Susp. sport 07/04- 1.6i 16v. Cooper 115hp 85kw Susp. sport 1.6i 16v. Cooper S 165hp 120kw -07/04 1.6i 16v. Cooper S 170hp 125kw Susp. sport



Eléments SUSPENSION
 Suspension parts
 Elementos suspensión
 Elementy zawieszenie
 Элементы подвески

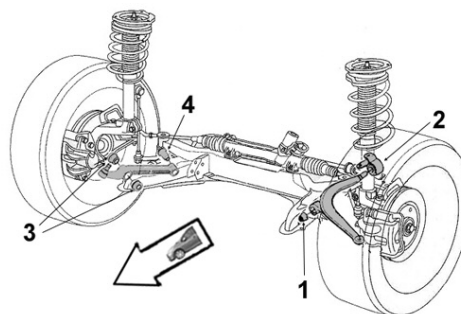

2256034	Articulation AR	
OE 31126757551	<i>Rear bush</i>	
	2 Ø ext. 66 long. tube int. 61 ext. 61	1.4 D One 75hp 55kw -09/05 1.4 D One 90hp 65kw 09/05- 1.6i 16v. One 90hp 66kw /Cooper 115hp 85kw 1.6i 16v. Cooper S 165hp 120kw 170hp 125kw 1.6i 16v. JCW 210hp 155kw 03/05-

... Mini I R50 R53 06/01-09/06 ...

Bras & Triangle de suspension

Control arm
Brazo y triángulo
Wahacz
Рычаг подвески

G/L  D/R

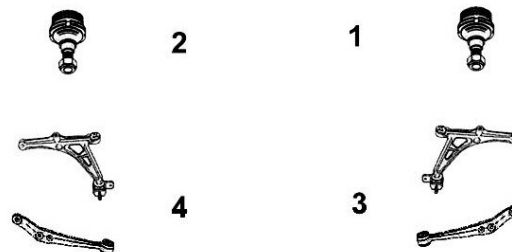

MINI

SASIC

7476023

Triangle de susp. G

OE 31126761409

Left track control arm



4 Sans rotule Without tie rod end

1.4 D One 75hp 55kw 90hp 65kw
1.6i 16v. One 90hp 66kw /Cooper
115hp 85kw
1.6i 16v. Cooper S 165hp 120kw -07/04
1.6i 16v. Cooper S 170hp 125kw /JCW
210hp 155kw

7476022

Triangle de susp. D

OE 31126761410

Right track control arm



3 Sans rotule Without tie rod end

1.4 D One 75hp 55kw 90hp 65kw
1.6i 16v. One 90hp 66kw /Cooper
115hp 85kw
1.6i 16v. Cooper S 165hp 120kw -07/04
1.6i 16v. Cooper S 170hp 125kw /JCW
210hp 155kw

9005520

Rotule de susp. inf. G/D ext.

OE 31126756309

Outer L R lower susp. ball joint



1
2

1.4 D One 75hp 55kw 90hp 65kw
1.6i 16v. One 90hp 66kw /Cooper 115hp 85kw
1.6i 16v. Cooper S 165hp 120kw 170hp 125kw
1.6i 16v. JCW 210hp 155kw

03/05-

9005522

Rotule de susp. inf. G int.

OE 31106779437

L lower susp. ball joint



2

1.4 D One 75hp 55kw 90hp 65kw
1.6i 16v. One 90hp 66kw /Cooper
115hp 85kw
1.6i 16v. Cooper S 165hp 120kw
170hp 125kw
1.6i 16v. JCW 210hp 155kw 03/05-

9005521

Rotule de susp. inf. D int.

OE 31106779438

R lower susp. ball joint



1

1.4 D One 75hp 55kw 90hp 65kw
1.6i 16v. One 90hp 66kw /Cooper
115hp 85kw
1.6i 16v. Cooper S 165hp 120kw
170hp 125kw
1.6i 16v. JCW 210hp 155kw 03/05-



Support d'amortisseur

Suspension mounting
Soporte amortiguador
Poduszka amortyzatora
Опора амортизатора

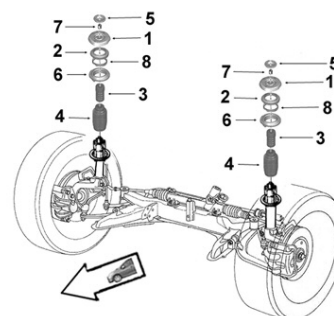

2656065

Support suspension G/D

OE 31306778833

L/R suspension mounting

NEW



1

1.4 D One 75hp 55kw 90hp 65kw
1.6i 16v. One 90hp 66kw /Cooper 115hp 85kw
1.6i 16v. Cooper S 165hp 120kw 170hp 125kw
1.6i 16v. JCW 210hp 155kw

01/03/02-

03/05-

... Mini I R50 R53 06/01-09/06



Barre stabilisatrice
 Stabilizer bar
 Barra estabilizadora
 Drażek stabilizatora
 стабилизатор поперечной устойчивости

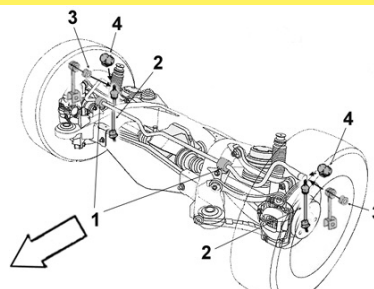

9005027

Biellette barre stab.

OE 33551507999

Stabilizer bar stub axle



2

1.4 D One 5hp 55kw
 1.6i 16v. One 90hp 66kw /Cooper
 115hp 85kw
 1.6i 16v. Cooper S 165hp 120kw
 170hp 125kw
 1.6i 16v. JCW 210hp 155kw

2306084

Palier de barre milieu

OE 33556756151

Middle bar main bearing



1 Ø 17

1.4 D One 75hp 55kw
 Susp. sport -09/05
 1.6i 16v. One 90hp 66kw /Cooper
 115hp 85kw Susp. sport
 1.6i 16v. Cooper S 165hp
 120kw 170hp 125kw

Mini II R56 09/06- ...

Eléments DIRECTION

Steering parts

Elementos Direcciones

Elementy układ kierowniczy

Элементы рулевой системы

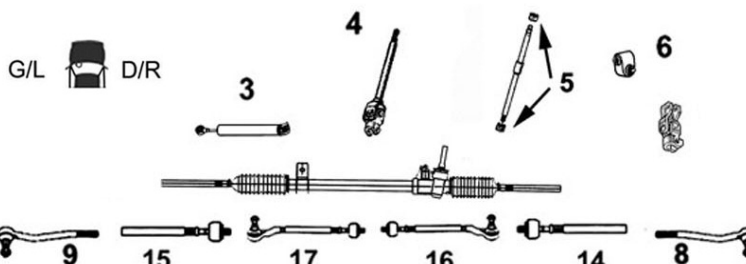

7776097

Axe de bielle G/D

Part/oe 32106778548 *L/R axial joint*

NEW



14 Côté dir. M14x1.5 Côté rot. M14x1.5
15 long 195 mm

1.4i One 75hp 55kw 95hp 70kw
 1.6i 16v. One 75hp 55kw 100hp 72kw /Cooper 120hp 90kw
 1.6i 16v. Cooper S 175hp 128kw 185hp 135kw
 1.6i 16v. JCW 210hp 155kw
 1.6 D One 90hp 66kw /Cooper 110hp 80kw

7676054

Rotule de direction G

OE 32106778437 *Left tie rod end*

NEW



9 M14 x 1.5

1.4i One 75hp 55kw 95hp 70kw
 1.6i 16v. One 75hp 55kw 100hp 72kw /Cooper 120hp 90kw
 1.6i 16v. Cooper S 175hp 128kw 185hp 135kw
 1.6i 16v. JCW 210hp 155kw
 1.6 D One 90hp 66kw /Cooper 110hp 80kw

7676055

Rotule de direction D

OE 32106778438 *Right tie rod end*

NEW



8 M14 x 1.5

1.4i One 75hp 55kw 95hp 70kw
 1.6i 16v. One 75hp 55kw 100hp 72kw /Cooper 120hp 90kw
 1.6i 16v. Cooper S 175hp 128kw 185hp 135kw
 1.6i 16v. JCW 210hp 155kw
 1.6 D One 90hp 66kw /Cooper 110hp 80kw

... Mini II R56 09/06- ...



Barre stabilisatrice
 Stabilizer bar
 Barra estabilizadora
 Drażek stabilizatora
 стабилизатор поперечной устойчивости

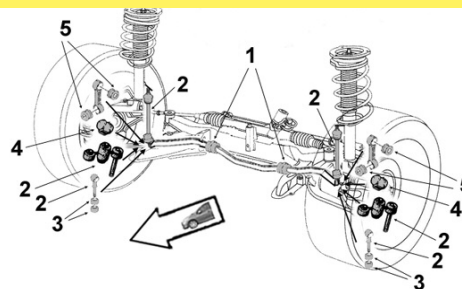

MINI



9005028

Biellette barre stab.

OE 31356778831

Stabilizer bar stub axle



2

1.4i One	75hp 55kw	95hp 70kw
1.6i 16v. One	75hp 55kw	100hp 72kw /Cooper 120hp 90kw
1.6i 16v. Cooper S	175hp 128kw	185hp 135kw
1.6i 16v. JCW	210hp 155kw	
1.6 D One	90hp 66kw /Cooper	110hp 80kw

2306078

Palier de barre milieu

OE 31356757146

Middle bar main bearing



1 Ø 22.5

1.4i One	95hp 70kw
1.6i 16v. One	100hp 72kw /Cooper 120hp 90kw
1.6i 16v. Cooper S	175hp 128kw 185hp 135kw
1.6i 16v. JCW	210hp 155kw
1.6 D Cooper	110hp 80kw

2306079

Palier de barre milieu

OE 31356772843

Middle bar main bearing



1 Ø 21.5

1.4i One	75hp 55kw	95hp 70kw
1.6i 16v. One	75hp 55kw	100hp 72kw /Cooper 120hp 90kw
1.6 D One	90hp 66kw /Cooper	110hp 80kw

2306080

Palier de barre milieu

OE 31356772844

Middle bar main bearing



1 Ø 23.5

1.4i One	75hp 55kw	95hp 70kw	Susp. Sport
1.6i 16v. One	75hp 55kw	100hp 72kw /Cooper 120hp 90kw	Susp. Sport
1.6i 16v. Cooper S	175hp 128kw	185hp 135kw	
1.6i 16v. JCW	210hp 155kw		
1.6 D One	90hp 66kw /Cooper	110hp 80kw	Susp. Sport

2306081

Palier de barre milieu

OE 31356758302

Middle bar main bearing



1 Ø 24

1.4i One	95hp 70kw	Susp. sport
1.6i 16v. One	100hp 72kw /Cooper 120hp 90kw	Susp. sport
1.6i 16v. Cooper S	175hp 128kw	185hp 135kw
1.6i 16v. JCW	210hp 155kw	Susp. sport
1.6 D Cooper	110hp 80kw	Susp. sport



Eléments SUSPENSION

Suspension parts
Elementos suspensión
Elementy zawieszenie
Элементы подвески

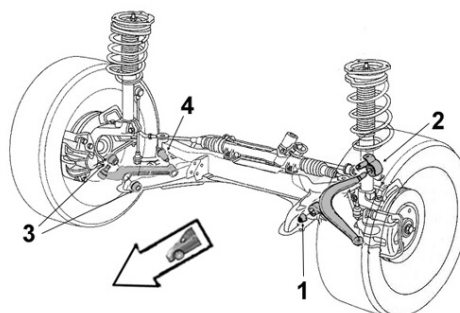

2256035

Articulation AR

OE 31126767530

Rear bush



2 Ø ext. 66 long. tube int. 61 ext. 61

1.4i One	75hp 55kw	95hp 70kw
1.6i 16v. One	100hp 72kw /Cooper	120hp 90kw
1.6i 16v. Cooper S	175hp 128kw	185hp 135kw
1.6 D One	90hp 66kw /Cooper	110hp 80kw

...Mini II R56 09/06-...

SASIC

MINI

Bras & Triangle de suspension

Control arm
Brazo y triángulo
Wahacz
Рычаг подвески

G/L  D/R

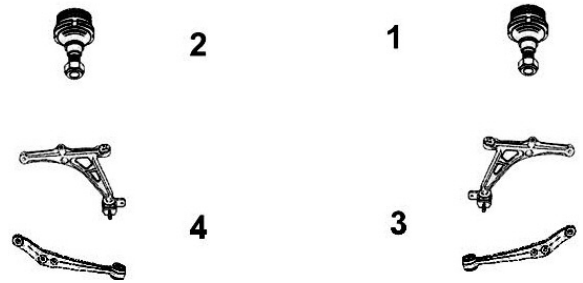

7476160

OE 31126772301

Triangle de susp. G

Left track control arm

4 Sans rotule Without tie rod end

1.4i One 75hp 55kw 95hp 70kw
1.6i 16v. One 75hp 55kw 100hp 72kw /Cooper 120hp 90kw
1.6i 16v. Cooper S 175hp 128kw 185hp 135kw
1.6i 16v. JCW 210hp 155kw
1.6 D One 90hp 66kw /Cooper 110hp 80kw



7476159

OE 31126772302

Triangle de susp. D

Right track control arm

3 Sans rotule Without tie rod end

1.4i One 75hp 55kw 95hp 70kw
1.6i 16v. One 75hp 55kw 100hp 72kw /Cooper 120hp 90kw
1.6i 16v. Cooper S 175hp 128kw 185hp 135kw
1.6i 16v. JCW 210hp 155kw
1.6 D One 90hp 66kw /Cooper 110hp 80kw



7576021

OE 31126772303

Rotule de susp. inf. G

Left lower suspension ball joint

2
1.4i One 75hp 55kw 95hp 70kw
1.6i 16v. One 75hp 55kw 100hp 72kw /Cooper 120hp 90kw
1.6i 16v. Cooper S 175hp 128kw 185hp 135kw
1.6i 16v. JCW 210hp 155kw
1.6 D One 90hp 66kw /Cooper 110hp 80kw



7576022

OE 31126772304

Rotule de susp. inf. D

Right lower suspension ball joint

1
1.4i One 75hp 55kw 95hp 70kw
1.6i 16v. One 75hp 55kw 100hp 72kw /Cooper 120hp 90kw
1.6i 16v. Cooper S 175hp 128kw 185hp 135kw
1.6i 16v. JCW 210hp 155kw
1.6 D One 90hp 66kw /Cooper 110hp 80kw



Support d'amortisseur

Suspension mounting
Soporte amortiguador
Poduszka amortyzatora
Опора амортизатора

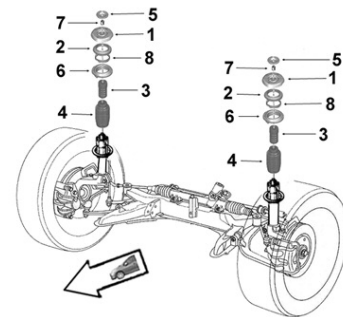

2656019

OE 31306772749

Support suspension G/D

L/R suspension mounting

1

1.4i One 75hp 55kw 95hp 70kw
1.6i 16v. One 75hp 55kw 100hp 72kw /Cooper 120hp 90kw
1.6i 16v. Cooper S 175hp 128kw 185hp 135kw
1.6i 16v. JCW 210hp 155kw
1.6 D One 90hp 66kw /Cooper 110hp 80kw



... Mini II R56 09/06-



Barre stabilisatrice
 Stabilizer bar
 Barra estabilizadora
 Drażek stabilizatora
 стабилизатор поперечной устойчивости

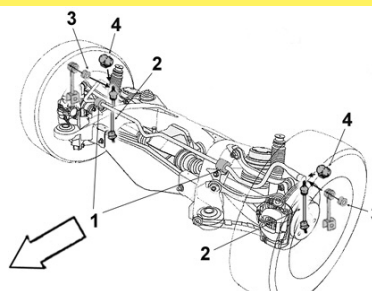

MINI



2306057 **Biellette barre stab.**
 OE 33506772789 *Stabilizer bar stub axle*



2

1.4i One 75hp 55kw 95hp 70kw
 1.6i 16v. One 75hp 55kw 100hp 72kw /Cooper 120hp 90kw
 1.6i 16v. Cooper S 175hp 128kw 185hp 135kw
 1.6i 16v. JCW 210hp 155kw
 1.6 D One 90hp 66kw /Cooper 110hp 80kw

2306083 **Palier de barre milieu**
 OE 33556754823 *Middle bar main bearing*



1 Ø 16

1.4i One 75hp 55kw 95hp 70kw
 1.6i 16v. One 75hp 55kw 100hp 72kw
 /Cooper 120hp 90kw
 1.6i 16v. Cooper S 185hp 135kw
 1.6 D One 90hp 66kw /Cooper
 110hp 80kw

2306084 **Palier de barre milieu**
 OE 33556756151 *Middle bar main bearing*



1 Ø 17

1.4i One 95hp 70kw Susp. sport
 1.6i 16v. One 100hp 72kw /Cooper
 120hp 90kw Susp. sport
 1.6i 16v. Cooper S 175hp 128kw
 185hp 135kw Susp. sport
 1.6i 16v. JCW 210hp 155kw
 1.6 D Cooper 110hp 80kw Susp. sport

2306082 **Palier de barre milieu**
 OE 33556772788 *Middle bar main bearing*



1 Ø 18 Susp. sport

1.4i One 75hp 55kw 95hp 70kw
 1.6i 16v. One 75hp 55kw 100hp 72kw /Cooper 120hp 90kw
 1.6i 16v. Cooper S 175hp 128kw 185hp 135kw
 1.6i 16v. JCW 210hp 155kw
 1.6 D Cooper 110hp 80kw

Mini Cab. R52 -02/09 ...

Eléments DIRECTION
 Steering parts
 Elementos Direcciones
 Elementy układ kierowniczy
 Элементы рулевой системы

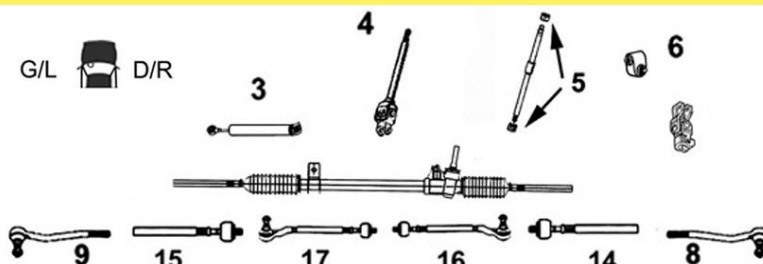

7676059 **Rotule de direction G**
 OE 32136761559 *Left tie rod end*

NEW



9 M14 x 1.5 long 255 mm

1.6i 16v. One 90hp 66kw /Cooper
 115hp 85kw
 1.6i 16v. Cooper S 170hp 125kw /JCW
 210hp 155kw

9006425 **Rotule de direction D**
 OE 32116761560 *Right tie rod end*



8 M14 x 1.5 long 255 mm

1.6i 16v. One 90hp 66kw /Cooper
 115hp 85kw
 1.6i 16v. Cooper S 170hp 125kw /JCW
 210hp 155kw

... Mini Cab. R52 -02/09 ...

SASIC

MINI



Barre stabilisatrice
 Stabilizer bar
 Barra estabilizadora
 Drażek stabilizatora
 стабилизатор поперечной устойчивости

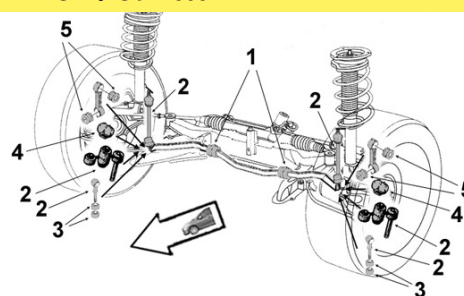

9005028 **Biellette barre stab.**
 OE 31356778831 *Stabilizer bar stub axle*



2

1.6i 16v. One 90hp 66kw /Cooper 115hp 85kw
 1.6i 16v. Cooper S 170hp 125kw
 1.6i 16v. JCW 210hp 155kw

03/05-

2306077 **Palier de barre milieu**
 OE 31356757069 *Middle bar main bearing*



1 Ø 16

1.6i 16v. One 90hp 66kw /Cooper
 115hp 85kw

2306078 **Palier de barre milieu**
 OE 31356757146 *Middle bar main bearing*



1 Ø 22.5

1.6i 16v. One 90hp 66kw /Cooper
 115hp 85kw Susp. sport

2306081 **Palier de barre milieu**
 OE 31356758302 *Middle bar main bearing*



1 Ø 24

1.6i 16v. Cooper S 170hp 125kw Susp. sport



Eléments SUSPENSION
 Suspension parts
 Elementos suspensión
 Elementy zawieszenie
 Элементы подвески

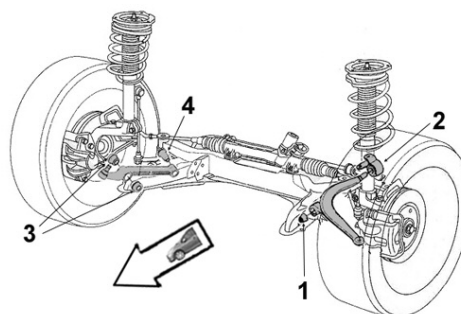

2256034 **Articulation AR**
 OE 31126757551 *Rear bush*



2 Ø ext. 66 long. tube int. 61 ext. 61

1.6i 16v. One 90hp 66kw /Cooper 115hp 85kw
 1.6i 16v. Cooper S 170hp 125kw
 1.6i 16v. JCW 210hp 155kw

03/05-

...Mini Cab. R52 -02/09...

Bras & Triangle de suspension

Control arm
Brazo y triángulo
Wahacz
Рычаг подвески

G/L  D/R



MINI



7476023

OE 31126761409

Triangle de susp. G

Left track control arm



4 Sans rotule Without tie rod end

1.6i 16v. One 90hp 66kw /Cooper 115hp 85kw
1.6i 16v. Cooper S 170hp 125kw /JCW 210hp 155kw

7476022

OE 31126761410

Triangle de susp. D

Right track control arm



3 Sans rotule Without tie rod end

1.6i 16v. One 90hp 66kw /Cooper 115hp 85kw
1.6i 16v. Cooper S 170hp 125kw /JCW 210hp 155kw

9005520

OE 31126756309

Rotule de susp. inf. G/D ext.

Outer L/R lower susp. ball joint



1
2

1.6i 16v. One 90hp 66kw /Cooper 115hp 85kw
1.6i 16v. Cooper S 170hp 125kw
1.6i 16v. JCW 210hp 155kw

03/05-

9005522

OE 31106779437

Rotule de susp. inf. G int.

L lower susp. ball joint



2

1.6i 16v. One 90hp 66kw /Cooper 115hp 85kw
1.6i 16v. Cooper S 165hp 120kw 170hp 125kw
1.6i 16v. JCW 210hp 155kw 03/05-

9005521

OE 31106779438

Rotule de susp. inf. D int.

R lower susp. ball joint



1

1.6i 16v. One 90hp 66kw /Cooper 115hp 85kw
1.6i 16v. Cooper S 165hp 120kw 170hp 125kw
1.6i 16v. JCW 210hp 155kw 03/05-



Support d'amortisseur

Suspension mounting
Soporte amortiguador
Poduszka amortyzatora
Опора амортизатора

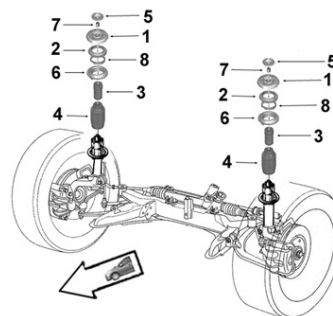

2656065

OE 31306778833

Support suspension G/D

L/R suspension mounting

NEW



1

1.6i 16v. One 90hp 66kw /Cooper 115hp 85kw
1.6i 16v. Cooper S 170hp 125kw
1.6i 16v. JCW 210hp 155kw

03/05-

... Mini Cab. R52 -02/09



Barre stabilisatrice
Stabilizer bar
Barra estabilizadora
Drażek stabilizatora
 стабилизатор поперечной устойчивости

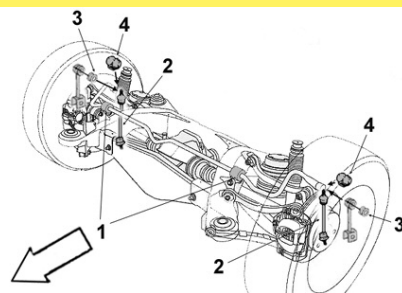

9005027 **Biellette barre stab.**
 OE 33551507999 *Stabilizer bar stub axle*



2

1.6i 16v. One 90hp 66kw /Cooper 115hp 85kw
 1.6i 16v. Cooper S 170hp 125kw

2306084 **Palier de barre milieu**
 OE 33556756151 *Middle bar main bearing*



1 Ø17

1.6i 16v. One 90hp 66kw /Cooper 115hp 85kw Susp. sport
 1.6i 16v. Cooper S 170hp 125kw

Mini Cab. R57 03/09- ...

Eléments DIRECTION
Steering parts
Elementos Direcciones
Elementy układ kierowniczy
 Элементы рулевой системы

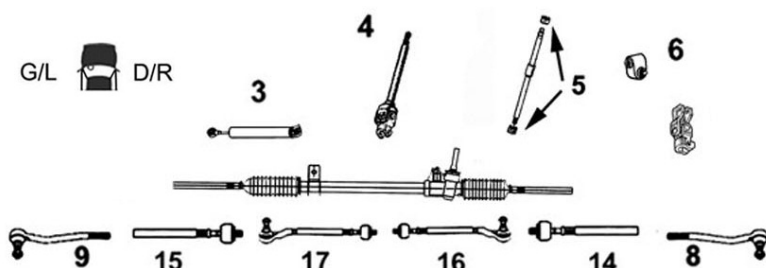

7776097 **Axe de bielle G/D**
 Part/oe 32106778548 *L/R axial joint*

NEW



14 Côté dir. M14x1.5 Côté rot. M14x1.5 long 195 mm

15

1.6i 16v. One 100hp 72kw /Cooper 120hp 90kw
 1.6i 16v. Cooper S 175hp 128kw 185hp 135kw
 1.6i 16v. JCW 210hp 155kw
 1.6 D Cooper 110hp 80kw

7676054 **Rotule de direction G**
 OE 32106778437 *Left tie rod end*

NEW



9 M14 x 1.5

1.6i 16v. One 100hp 72kw /Cooper 120hp 90kw
 1.6i 16v. Cooper S 175hp 128kw 185hp 135kw
 1.6i 16v. JCW 210hp 155kw
 1.6 D Cooper 110hp 80kw

7676055 **Rotule de direction D**
 OE 32106778438 *Right tie rod end*

NEW



8 M14 x 1.5

1.6i 16v. One 100hp 72kw /Cooper 120hp 90kw
 1.6i 16v. Cooper S 175hp 128kw 185hp 135kw
 1.6i 16v. JCW 210hp 155kw
 1.6 D Cooper 110hp 80kw

... Mini Cab. R57 03/09- ...



Barre stabilisatrice
 Stabilizer bar
 Barra estabilizadora
 Drażek stabilizatora
 стабилизатор поперечной устойчивости

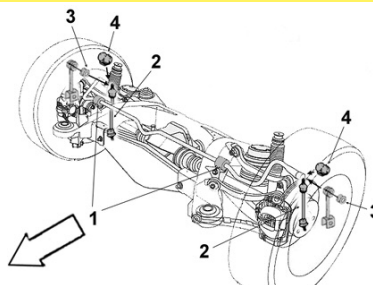

MINI



9005028 **Biellette barre stab.**
 OE 31356778831 *Stabilizer bar stub axle*



2

1.6i 16v. One 100hp 72kw /Cooper 120hp 90kw
 1.6i 16v. Cooper S 175hp 128kw 185hp 135kw
 1.6i 16v. JCW 210hp 155kw
 1.6 D Cooper 110hp 80kw

2306078 **Palier de barre milieu**
 OE 31356757146 *Middle bar main bearing*



1 Ø 22.5

1.6i 16v. One 100hp 72kw /Cooper
 120hp 90kw
 1.6i 16v. Cooper S 175hp 128kw
 185hp 135kw
 1.6 D Cooper 110hp 80kw

2306081 **Palier de barre milieu**
 OE 31356758302 *Middle bar main bearing*



1 Ø 24

1.6i 16v. One 100hp 72kw /Cooper
 120hp 90kw Susp. sport
 1.6i 16v. Cooper S 175hp 128kw
 185hp 135kw Susp. sport
 1.6i 16v. JCW 210hp 155kw
 Susp. sport

2306080 **Palier de barre milieu**
 OE 31356772844 *Middle bar main bearing*



1 Ø 23.5

1.6i 16v. Cooper S 175hp 128kw 185hp 135kw
 1.6i 16v. JCW 210hp 155kw



Eléments SUSPENSION
 Suspension parts
 Elementos suspensión
 Elementy zawieszenie
 Элементы подвески

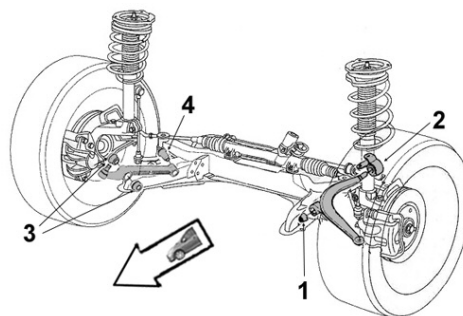

2256035 **Articulation AR**
 OE 31126767530 *Rear bush*



2 Ø ext. 66 long. tube int. 61 ext. 61

1.6i 16v. One 100hp 72kw /Cooper 120hp 90kw
 1.6i 16v. Cooper S 175hp 128kw 185hp 135kw
 1.6 D Cooper 110hp 80kw

...Mini Cab. R57 03/09-

SASIC

MINI

Bras & Triangle de suspension

Control arm
Brazo y triángulo
Wahacz
Рычаг подвески

G/L  D/R

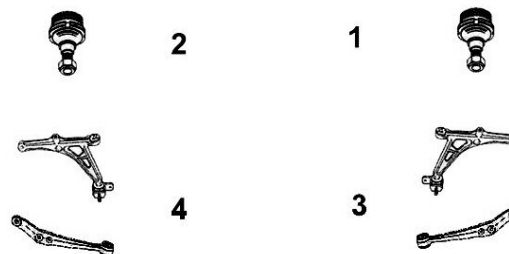

7476160

Triangle de susp. G

OE 31126772301

Left track control arm

NEW



4 Sans rotule Without tie rod end

1.6i 16v. One 100hp 72kw /Cooper 120hp 90kw
1.6i 16v. Cooper S 175hp 128kw 185hp 135kw
1.6i 16v. JCW 210hp 155kw
1.6 D Cooper 110hp 80kw

7476159

Triangle de susp. D

OE 31126772302

Right track control arm

NEW



3 Sans rotule Without tie rod end

1.6i 16v. One 100hp 72kw /Cooper 120hp 90kw
1.6i 16v. Cooper S 175hp 128kw 185hp 135kw
1.6i 16v. JCW 210hp 155kw
1.6 D Cooper 110hp 80kw

7576021

Rotule de susp. inf. G

OE 31126772303

Left lower suspension ball joint

NEW



2

1.6i 16v. One 100hp 72kw /Cooper 120hp 90kw
1.6i 16v. Cooper S 175hp 128kw 185hp 135kw
1.6i 16v. JCW 210hp 155kw
1.6 D Cooper 110hp 80kw

7576022

Rotule de susp. inf. D

OE 31126772304

Right lower suspension ball joint

NEW



1

1.6i 16v. One 100hp 72kw /Cooper 120hp 90kw
1.6i 16v. Cooper S 175hp 128kw 185hp 135kw
1.6i 16v. JCW 210hp 155kw
1.6 D Cooper 110hp 80kw



Support d'amortisseur

Suspension mounting
Soporte amortiguador
Poduszka amortyzatora
Опора амортизатора

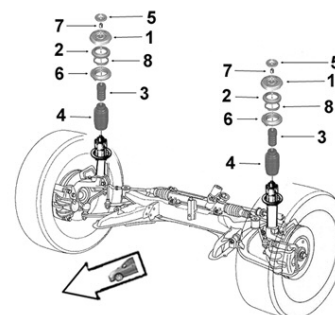

2656019

Support suspension G/D

OE 31306772749

L/R suspension mounting



1

1.6i 16v. One 100hp 72kw /Cooper 120hp 90kw
1.6i 16v. Cooper S 175hp 128kw 185hp 135kw
1.6i 16v. JCW 210hp 155kw
1.6 D Cooper 110hp 80kw

... Mini Cab. R57 03/09- ...



Barre stabilisatrice
Stabilizer bar
Barra estabilizadora
Drażek stabilizatora
 стабилизатор поперечной устойчивости

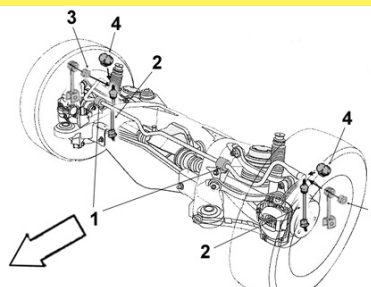

MINI



2306057 **Biellette barre stab.**
 OE 33506772789 *Stabilizer bar stub axle*



2

1.6i 16v. One 100hp 72kw /Cooper 120hp 90kw
 1.6i 16v. Cooper S 175hp 128kw 185hp 135kw
 1.6i 16v. JCW 210hp 155kw
 1.6 D Cooper 110hp 80kw

2306083 **Palier de barre milieu**
 OE 33556754823 *Middle bar main bearing*



1 Ø 16

1.6i 16v. One 100hp 72kw /Cooper
 120hp 90kw
 1.6i 16v. Cooper S 175hp 128kw
 185hp 135kw
 1.6i 16v. JCW 210hp 155kw

2306084 **Palier de barre milieu**
 OE 33556756151 *Middle bar main bearing*



1 Ø 17

1.6i 16v. One 100hp 72kw /Cooper
 120hp 90kw Susp. sport
 1.6i 16v. Cooper S 175hp 128kw
 185hp 135kw Susp. sport
 1.6i 16v. JCW 210hp 155kw Susp. sport
 1.6 D Cooper 110hp 80kw Susp. sport

Mini Clubman R55 08/07- ...

Eléments DIRECTION
Steering parts
Elementos Direcciones
Elementy układ kierowniczy
 Элементы рулевой системы

G/L D/R

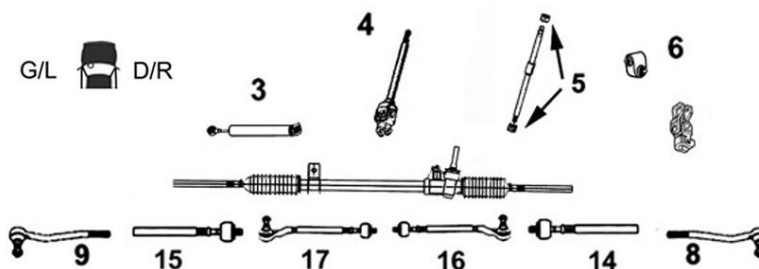

7776097 **Axe de bielle G/D**
 Part/oe 32106778548 *L/R axial joint*

NEW



14 Côté dir. M14x1.5 Côté rot. M14x1.5 long 195 mm
15

1.4i One 95hp 70kw
 1.6i 16v. One 100hp 72kw /Cooper 120hp 90kw
 1.6i 16v. Cooper S 175hp 128kw 185hp 135kw
 1.6i 16v. JCW 210hp 155kw
 1.6 D One 90hp 66kw /Cooper 110hp 82kw

7676054 **Rotule de direction G**
 OE 32106778437 *Left tie rod end*

NEW



9 M14 x 1.5

1.4i One 95hp 70kw
 1.6i 16v. One 100hp 72kw /Cooper
 120hp 90kw
 1.6i 16v. Cooper S 175hp 128kw
 185hp 135kw
 1.6i 16v. JCW 210hp 155kw
 1.6 D One 90hp 66kw /Cooper
 110hp 82kw

7676055 **Rotule de direction D**
 OE 32106778438 *Right tie rod end*

NEW



8 M14 x 1.5

1.4i One 95hp 70kw
 1.6i 16v. One 100hp 72kw /Cooper
 120hp 90kw
 1.6i 16v. Cooper S 175hp 128kw
 185hp 135kw
 1.6i 16v. JCW 210hp 155kw
 1.6 D One 90hp 66kw /Cooper
 110hp 82kw

... Mini Clubman R55 08/07- ...

SASIC

MINI



Barre stabilisatrice
Stabilizer bar
Barra estabilizadora
Drażek stabilizatora
 стабилизатор поперечной устойчивости

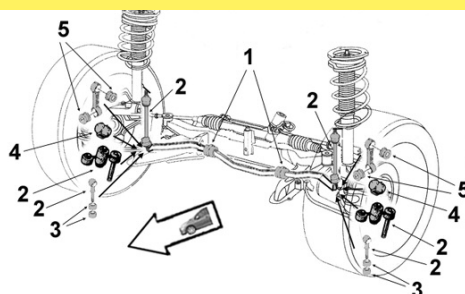

9005028 **Biellette barre stab.**
 OE 31356778831 *Stabilizer bar stub axle*



2

1.4i One 95hp 70kw
 1.6i 16v. One 100hp 72kw /Cooper 120hp 90kw
 1.6i 16v. Cooper S 175hp 128kw 185hp 135kw
 1.6i 16v. JCW 210hp 155kw
 1.6 D One 90hp 66kw /Cooper 110hp 82kw

2306078 **Palier de barre milieu**
 OE 31356757146 *Middle bar main bearing*



1 Ø 22.5

1.4i One 95hp 70kw
 1.6i 16v. One 100hp 72kw /Cooper
 120hp 90kw
 1.6i 16v. Cooper S 175hp 128kw
 1.6 D Cooper 110hp 82kw

2306079 **Palier de barre milieu**
 OE 31356772843 *Middle bar main bearing*



1 Ø 21.5

1.6i 16v. Cooper 120hp 90kw
 1.6 D Cooper 110hp 82kw

2306081 **Palier de barre milieu**
 OE 31356758302 *Middle bar main bearing*



1 Ø 24

1.4i One 95hp 70kw Susp. sport
 1.6i 16v. One 100hp 72kw /Cooper
 120hp 90kw Susp. sport
 1.6i 16v. Cooper S 175hp 128kw
 185hp 135kw Susp. sport
 1.6i 16v. JCW 210hp 155kw Susp. sport
 1.6 D Cooper 110hp 82kw Susp. sport

2306080 **Palier de barre milieu**
 OE 31356772844 *Middle bar main bearing*



1 Ø 23.5

1.6i 16v. Cooper 120hp 90kw
 Susp. Sport
 1.6i 16v. Cooper S 175hp 128kw
 185hp 135kw
 1.6i 16v. JCW 210hp 155kw
 1.6 D One 90hp 66kw /Cooper
 110hp 82kw Susp. Sport



Eléments SUSPENSION
Suspension parts
Elementos suspensión
Elementy zawieszenie
 Элементы подвески

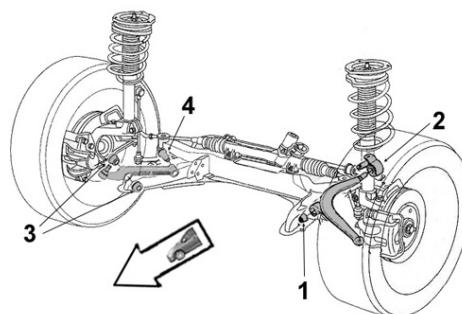

2256035 **Articulation AR**
 OE 31126767530 *Rear bush*



Ø ext. 66 long. tube int. 61 ext. 61

1.4i One 95hp 70kw
 1.6i 16v. One 100hp 72kw /Cooper 120hp 90kw
 1.6i 16v. Cooper S 175hp 128kw 185hp 135kw
 1.6 D One 90hp 66kw /Cooper 110hp 82kw

... Mini Clubman R55 08/07-

Bras & Triangle de suspension

Control arm
Brazo y triángulo
Wahacz
Рычаг подвески

G/L  D/R

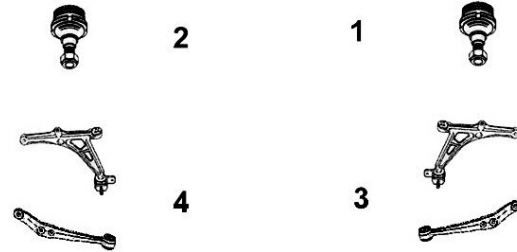

7476160

OE 31126772301

Triangle de susp. G

Left track control arm

NEW



4 Sans rotule Without tie rod end
1.4i One 95hp 70kw
1.6i 16v. One 100hp 72kw /Cooper 120hp 90kw
1.6i 16v. Cooper S 175hp 128kw 185hp 135kw
1.6i 16v. JCW 210hp 155kw
1.6 D One 90hp 66kw /Cooper 110hp 82kw

7476159

OE 31126772302

Triangle de susp. D

Right track control arm

NEW



3 Sans rotule Without tie rod end
1.4i One 95hp 70kw
1.6i 16v. One 100hp 72kw /Cooper 120hp 90kw
1.6i 16v. Cooper S 175hp 128kw 185hp 135kw
1.6i 16v. JCW 210hp 155kw
1.6 D One 90hp 66kw /Cooper 110hp 82kw

7576021

OE 31126772303

Rotule de susp. inf. G

Left lower suspension ball joint

NEW



2
1.4i One 95hp 70kw
1.6i 16v. One 100hp 72kw /Cooper 120hp 90kw
1.6i 16v. Cooper S 175hp 128kw 185hp 135kw
1.6i 16v. JCW 210hp 155kw
1.6 D One 90hp 66kw /Cooper 110hp 82kw

7576022

OE 31126772304

Rotule de susp. inf. D

Right lower suspension ball joint

NEW



1
1.4i One 95hp 70kw
1.6i 16v. One 100hp 72kw /Cooper 120hp 90kw
1.6i 16v. Cooper S 175hp 128kw 185hp 135kw
1.6i 16v. JCW 210hp 155kw
1.6 D One 90hp 66kw /Cooper 110hp 82kw



Support d'amortisseur

Suspension mounting
Soporte amortiguador
Poduszka amortyzatora
Опора амортизатора

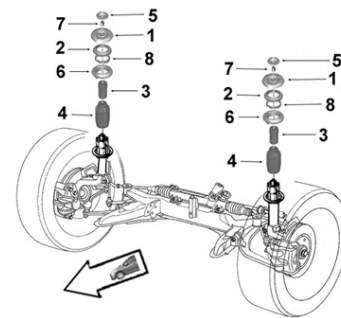

2656019

OE 31306772749

Support suspension G/D

L/R suspension mounting



1
1.4i One 95hp 70kw
1.6i 16v. One 100hp 72kw /Cooper 120hp 90kw
1.6i 16v. Cooper S 175hp 128kw 185hp 135kw
1.6i 16v. JCW 210hp 155kw
1.6 D One 90hp 66kw /Cooper 110hp 82kw

... Mini Clubman R55 08/07-



Barre stabilisatrice
 Stabilizer bar
 Barra estabilizadora
 Drażek stabilizatora
 стабилизатор поперечной устойчивости

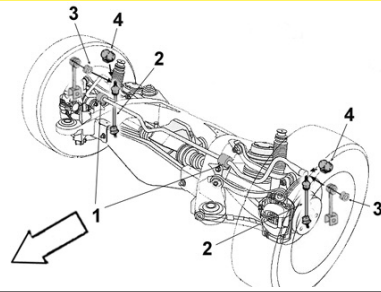

2306057 **Biellette barre stab.**
 OE 33506772789 *Stabilizer bar stub axle*



2

1.4i One 95hp 70kw
 1.6i 16v. One 100hp 72kw /Cooper 120hp 90kw
 1.6i 16v. Cooper S 175hp 128kw 185hp 135kw
 1.6i 16v. JCW 210hp 155kw
 1.6 D One 90hp 66kw /Cooper 110hp 82kw

2306083 **Palier de barre milieu**
 OE 33556754823 *Middle bar main bearing*



1 Ø16

1.4i One 95hp 70kw
 1.6i 16v. One 100hp 72kw /Cooper 120hp 90kw
 1.6i 16v. Cooper S 185hp 135kw
 1.6i 16v. JCW 210hp 155kw
 1.6 D One 90hp 66kw

2306084 **Palier de barre milieu**
 OE 33556756151 *Middle bar main bearing*



1 Ø17

1.4i One 95hp 70kw Susp. sport
 1.6i 16v. One 100hp 72kw /Cooper 120hp 90kw Susp. sport
 1.6i 16v. Cooper S 175hp 128kw 185hp 135kw Susp. sport
 1.6i 16v. JCW 210hp 155kw
 1.6 D Cooper 110hp 82kw Susp. sport

Mini Coupé R58 09/11- ...

Eléments DIRECTION
 Steering parts
 Elementos Direcciones
 Elementy układ kierowniczy
 Элементы рулевой системы

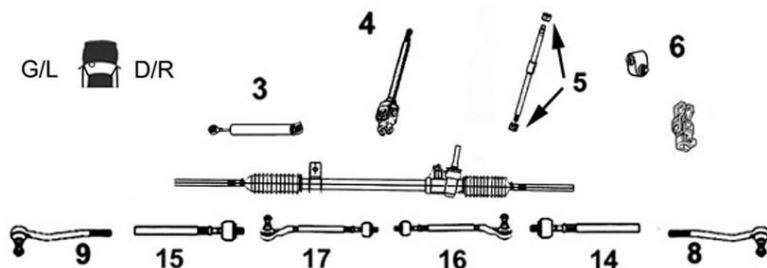

7776097 **Axe de bielle G/D**
 Part/oe 32106778548 *L/R axial joint*

NEW



14 Côté dir. M14x1.5 Côté rot. M14x1.5 long 195 mm
 15

1.6i 16v. Cooper 115hp 85kw 120hp 90kw
 1.6i 16v. Cooper S 185hp 135kw /JCW 210hp 155kw
 2.0 D Cooper SD 142hp 105kw

7676054 **Rotule de direction G**
 OE 32106778437 *Left tie rod end*

NEW



9 M14 x 1.5

1.6i 16v. Cooper 115hp 85kw 120hp 90kw
 1.6i 16v. Cooper S 185hp 135kw /JCW 210hp 155kw
 2.0 D Cooper SD 142hp 105kw

7676055 **Rotule de direction D**
 OE 32106778438 *Right tie rod end*

NEW



8 M14 x 1.5

1.6i 16v. Cooper 115hp 85kw 120hp 90kw
 1.6i 16v. Cooper S 185hp 135kw /JCW 210hp 155kw
 2.0 D Cooper SD 142hp 105kw

... Mini Coupé R58 09/11- ...



Barre stabilisatrice
 Stabilizer bar
 Barra estabilizadora
 Drążek stabilizatora
 стабилизатор поперечной устойчивости

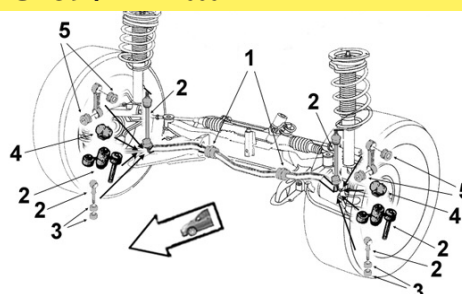

MINI



9005028

Biellette barre stab.

OE 31356778831

Stabilizer bar stub axle



2

1.6i 16v. Cooper 115hp 85kw
 120hp 90kw
 1.6i 16v. Cooper S 185hp 135kw
 /JCW 210hp 155kw
 2.0 D Cooper SD 142hp 105kw

2306078

Palier de barre milieu

OE 31356757146

Middle bar main bearing



1 Ø 22.5

1.6i 16v. Cooper 120hp 90kw
 1.6i 16v. Cooper S 185hp 135kw
 /JCW 210hp 155kw
 2.0 D Cooper SD 142hp 105kw



Eléments SUSPENSION

Suspension parts
 Elementos suspensión
 Elementy zawieszenia
 Элементы подвески

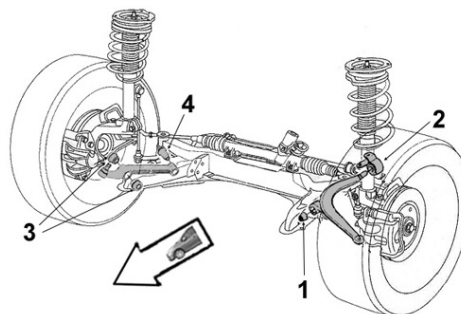

2256035

Articulation AR

OE 31126767530

Rear bush



2

Ø ext. 66 long. tube int. 61 ext. 61

1.6i 16v. Cooper 115hp 85kw 120hp 90kw
 1.6i 16v. Cooper S 185hp 135kw
 2.0 D Cooper SD 142hp 105kw

Bras & Triangle de suspension

Control arm
 Brazo y triángulo
 Wahacz
 Рычаг подвески

G/L  D/R

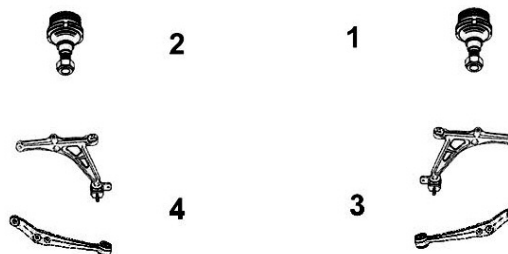

7476160

Triangle de susp. G

OE 31126772301

Left track control arm

NEW



4 Sans rotule Without tie rod end

1.6i 16v. Cooper 115hp 85kw
 120hp 90kw
 1.6i 16v. Cooper S 185hp 135kw
 /JCW 210hp 155kw
 2.0 D Cooper SD 142hp 105kw

7476159

Triangle de susp. D

OE 31126772302

Right track control arm

NEW



3 Sans rotule Without tie rod end

1.6i 16v. Cooper 115hp 85kw
 120hp 90kw
 1.6i 16v. Cooper S 185hp 135kw
 /JCW 210hp 155kw
 2.0 D Cooper SD 142hp 105kw

... Mini Coupé R58 09/11-

Bras & Triangle de suspension

Control arm
Brazo y triángulo
Wahacz
Рычаг подвески

G/L  D/R

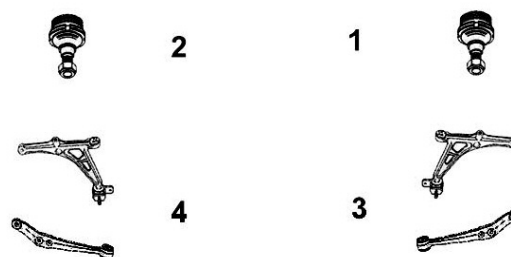

7576021

Rotule de susp. inf. G

OE 31126772303

Left lower suspension ball joint

NEW

2



1.6i 16v. Cooper 115hp 85kw
120hp 90kw
1.6i 16v. Cooper S 185hp 135kw
/JCW 210hp 155kw
2.0 D Cooper SD 142hp 105kw

7576022

Rotule de susp. inf. D

OE 31126772304

Right lower suspension ball joint

NEW

1



1.6i 16v. Cooper 115hp 85kw
120hp 90kw
1.6i 16v. Cooper S 185hp 135kw
/JCW 210hp 155kw
2.0 D Cooper SD 142hp 105kw



Barre stabilisatrice

Stabilizer bar
Barra estabilizadora
Drażek stabilizatora
стабилизатор поперечной устойчивости

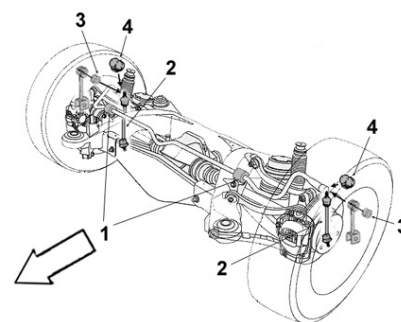

2306057

Biellette barre stab.

OE 33506772789

Stabilizer bar stub axle

2



1.6i 16v. Cooper 115hp 85kw
120hp 90kw
1.6i 16v. Cooper S 185hp 135kw
/JCW 210hp 155kw

2306082

Palier de barre milieu

OE 33556772788

Middle bar main bearing

1 Ø 18



1.6i 16v. Cooper 120hp 90kw
1.6i 16v. Cooper S 185hp 135kw
/JCW 210hp 155kw
2.0 D Cooper SD 142hp 105kw

Mini Roadster R59 02/12- ...

Eléments DIRECTION

Steering parts
Elementos Direcciones
Elementy układ kierowniczy
Элементы рулевой системы

G/L  D/R

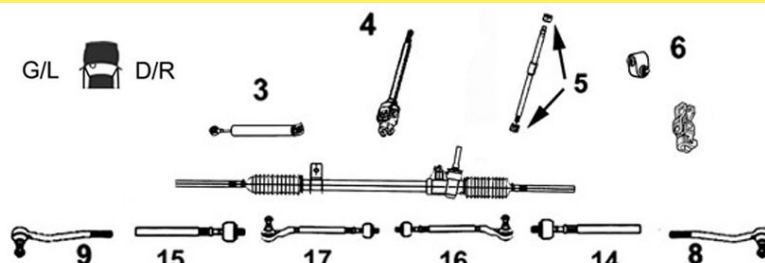

7776097

Axe de bielle G/D

Part/oe 32106778548 *L/R axial joint*

NEW

14 Côté dir. M14x1.5 Côté rot. M14x1.5 long 195 mm
15





1.6i 16v. Cooper 115hp 85kw 120hp 90kw
1.6i 16v. Cooper S 185hp 135kw /JCW 210hp 155kw
2.0 D Cooper SD 142hp 105kw

... Mini Roadster R59 02/12-

MINI





7676054	Rotule de direction G	7676055	Rotule de direction D
OE 32106778437	<i>Left tie rod end</i>	OE 32106778438	<i>Right tie rod end</i>
NEW	9 M14 x 1.5	NEW	8 M14 x 1.5
	1.6i 16v. Cooper 115hp 85kw 120hp 90kw 1.6i 16v. Cooper S 185hp 135kw /JCW 210hp 155kw 2.0 D Cooper SD 142hp 105kw		1.6i 16v. Cooper 115hp 85kw 120hp 90kw 1.6i 16v. Cooper S 185hp 135kw /JCW 210hp 155kw 2.0 D Cooper SD 142hp 105kw

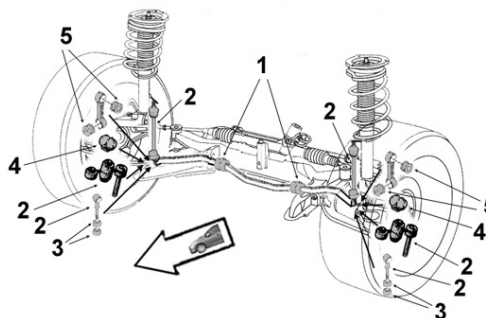

Barre stabilisatrice
Stabilizer bar
Barra estabilizadora
Drażek stabilizatora
стабилизатор поперечной устойчивости





9005028	Biellette barre stab.		
OE 31356778831	<i>Stabilizer bar stub axle</i>		
2			
	1.6i 16v. Cooper 115hp 85kw 120hp 90kw 1.6i 16v. Cooper S 185hp 135kw /JCW 210hp 155kw 2.0 D Cooper SD 142hp 105kw		

2306078	Palier de barre milieu		
OE 31356757146	<i>Middle bar main bearing</i>		
1 Ø 22.5			
	1.6i 16v. Cooper 120hp 90kw		

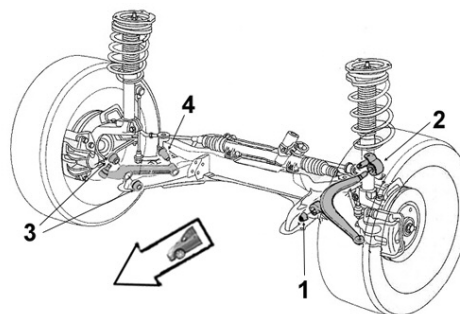

Eléments SUSPENSION
Suspension parts
Elementos suspensión
Elementy zawieszenie
Элементы подвески



2256035	Articulation AR		
OE 31126767530	<i>Rear bush</i>		
Ø ext. 66 long. tube int. 61 ext. 61			
	1.6i 16v. Cooper 115hp 85kw 120hp 90kw 1.6i 16v. Cooper S 185hp 135kw 2.0 D Cooper SD 142hp 105kw		

... Mini Roadster R59 02/12-

SASIC

MINI

Bras & Triangle de suspension

Control arm
Brazo y triángulo
Wahacz
Рычаг подвески

G/L  D/R

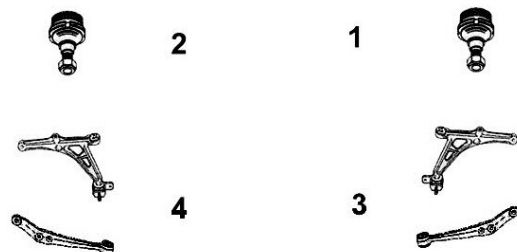

7476160

Triangle de susp. G

OE 31126772301

Left track control arm

NEW

4 Sans rotule Without tie rod end



1.6i 16v. Cooper 115hp 85kw
120hp 90kw
1.6i 16v. Cooper S 185hp 135kw
/JCW 210hp 155kw
2.0 D Cooper SD 142hp 105kw

7476159

Triangle de susp. D

OE 31126772302

Right track control arm

NEW

3 Sans rotule Without tie rod end



1.6i 16v. Cooper 115hp 85kw
120hp 90kw
1.6i 16v. Cooper S 185hp 135kw
/JCW 210hp 155kw
2.0 D Cooper SD 142hp 105kw

7576021

Rotule de susp. inf. G

OE 31126772303

Left lower suspension ball joint

NEW

2



1.6i 16v. Cooper 115hp 85kw
120hp 90kw
1.6i 16v. Cooper S 185hp 135kw
/JCW 210hp 155kw
2.0 D Cooper SD 142hp 105kw

7576022

Rotule de susp. inf. D

OE 31126772304

Right lower suspension ball joint

NEW

1



1.6i 16v. Cooper 115hp 85kw
120hp 90kw
1.6i 16v. Cooper S 185hp 135kw
/JCW 210hp 155kw
2.0 D Cooper SD 142hp 105kw



Barre stabilisatrice

Stabilizer bar
Barra estabilizadora
Drażek stabilizatora
стабилизатор поперечной устойчивости

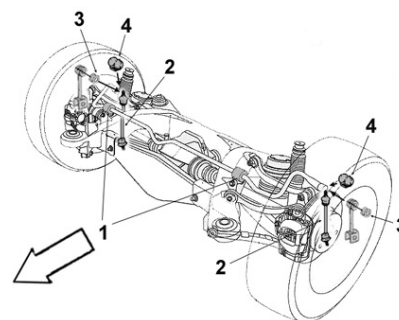

2306057

Biellette barre stab.

OE 33506772789

Stabilizer bar stub axle

2



1.6i 16v. Cooper 115hp 85kw 120hp 90kw
1.6i 16v. Cooper S 185hp 135kw /JCW 210hp 155kw
2.0 D Cooper SD 142hp 105kw

2306082

Palier de barre milieu

OE 33556772788

Middle bar main bearing

1 Ø 18



1.6i 16v. Cooper 120hp 90kw

Mini Countryman R60 06/10-

Eléments DIRECTION

Steering parts

Elementos Direcciones

Elementy układu kierowniczy

Элементы рулевой системы

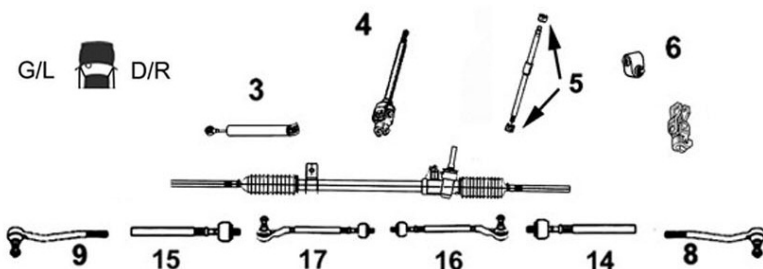

7776097

Axe de bielle G/D

Part/oe 32106778548 L/R axial joint

NEW



14 Côté dir. M14x1.5 Côté rot. M14x1.5 long 195 mm

15
 1.6i 16v. One 100hp 72kw
 1.6i 16v. Cooper 120hp 88kw
 1.6i 16v. Cooper S 185hp 135kw /4WD
 1.6 D One 90hp 66kw
 1.6 D Cooper 110hp 80kw /4WD



Support d'amortisseur

Suspension mounting

Soporte amortiguador

Poduszka amortyzatora

Опора амортизатора

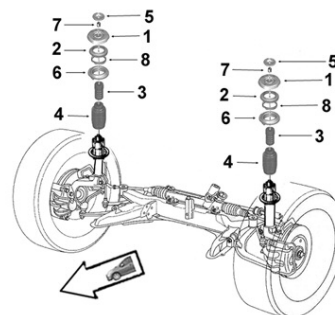

2656019

Support suspension G/D

OE 31306772749 L/R suspension mounting



1

1.6 D One 90hp 66kw
 1.6 D Cooper 110hp 80kw /4WD



Barre stabilisatrice

Stabilizer bar

Barra estabilizadora

Drażek stabilizatora

стабилизатор поперечной устойчивости

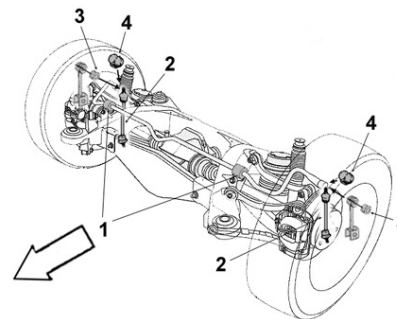

2306083

Palier de barre milieu

OE 33556754823 Middle bar main bearing



1 Ø 16

1.6i 16v. Cooper 120hp 88kw
 1.6 D One 90hp 66kw

2306084

Palier de barre milieu

OE 33556756151 Middle bar main bearing



1 Ø 17

1.6i 16v. Cooper 120hp 88kw
 Susp. sport
 1.6 D Cooper 110hp 80kw /4WD
 Susp. sport

ASX

Éléments DIRECTION
Steering parts
Elementos Direcciones
Elementy układ kierowniczy
Элементы рулевой системы

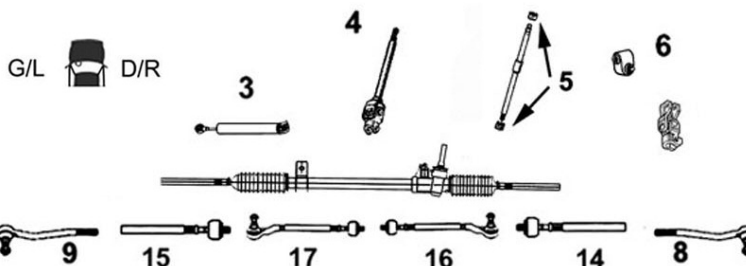

7770014

OE 4422A076

Axe de bielle G/D

L/R axial joint

NEW



14 Côté dir. M14x1.5 Côté rot. M14x1.5
15 long 341 mm

1.6i 120hp 86kw	4A92 BVM5
1.8 DiD 115hp 85kw	150hp 110kw
	4N13 BVM6

7670018

OE 4422A052

Rotule de direction G/D

L/R tie rod end

NEW



8 M14 x 1.5
9

1.6i 120hp 86kw	4A92 BVM5
1.8 DiD 115hp 85kw	150hp 110kw
	4N13 BVM6



Support d'amortisseur

Suspension mounting
Soporte amortiguador
Poduszka amortyzatora
Опора амортизатора

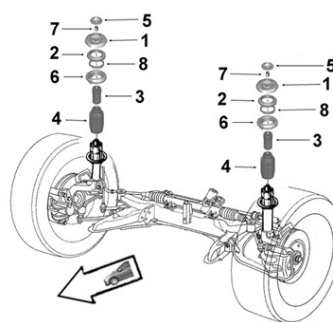

2650036

OE MN101372

Support suspension

Suspension mounting



1 Sans roulement *Without bearing*

1.6i	120hp 86kw	4A92
1.8 DiD	115hp 85kw 150hp 110kw	4N13

Carisma ...



Barre stabilisatrice

Stabilizer bar
Barra estabilizadora
Drażek stabilizatora
стабилизатор поперечной устойчивости

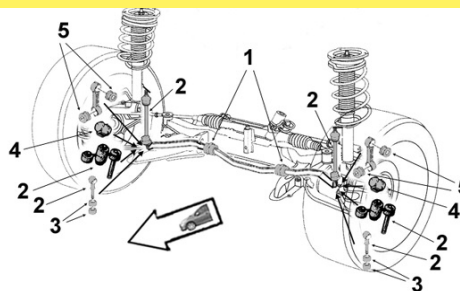

2306069

OE MR131680

Biellette barre stab.

Stabilizer bar stub axle



2

1.6i	10/96-08/04
1.8i 16v.	10/96-08/04
1.8 GD i 16v.	09/97-08/04
1.9 DCi	05/00-08/04
1.9 DiD	05/00-08/04

...Carisma



Eléments SUSPENSION
Suspension parts
Elementos suspensión
Elementy zawieszenie
Элементы подвески

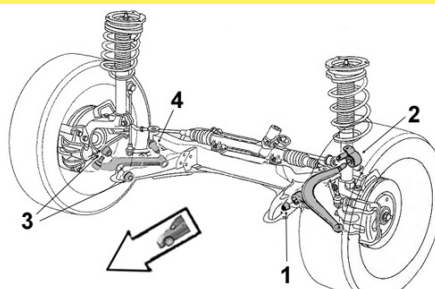

2256041 Articulation AR G

OE MB808909 *Left rear bush*



2 Ø int. 20.5

1.6/i	10/96-08/04
1.8i 16v.	10/96-08/04
1.8 GD <i>i</i> 16v.	09/97-08/04
1.9 DC <i>i</i>	05/00-08/04
1.9 DiD	05/00-08/04
1.9 TD	10/96-07/00

2256042 Articulation AR D

OE MB808910 *Right rear bush*



2 Ø int. 20.5

1.6/i	10/96-08/04
1.8i 16v.	10/96-08/04
1.8 GD <i>i</i> 16v.	09/97-08/04
1.9 DC <i>i</i>	05/00-08/04
1.9 DiD	05/00-08/04
1.9 TD	10/96-07/00

2256044 Articulation AV

OE - *Front bush*



1 Ø int.12 Ø ext.36 coll.40 long. tube int. 60 ext. 37

1.6/i	10/96-12/99
1.8i 16v.	10/96-12/99
1.8 GD <i>i</i> 16v.	09/97-08/04
1.9 TD	10/96-07/00

Colt



Barre stabilisatrice
Stabilizer bar
Barra estabilizadora
Drażek stabilizatora
стабилизатор поперечной устойчивости

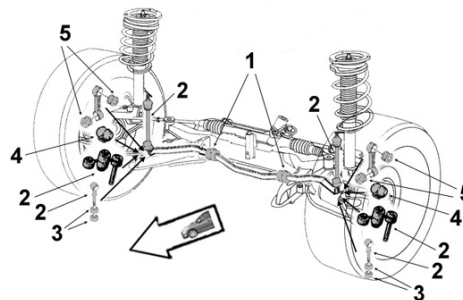

2306073 Bielle barre stab.

OE 4543200010 *Stabilizer bar stub axle*



2

1.1i	BVM	05/04-03/06
1.3i		03/05-10/08
1.5i		03/05-04/07
1.5 DiD		09/04-10/08

Outlander

Eléments DIRECTION

Steering parts

Elementos Direcciones

Elementy układ kierowniczy

Элементы рулевой системы

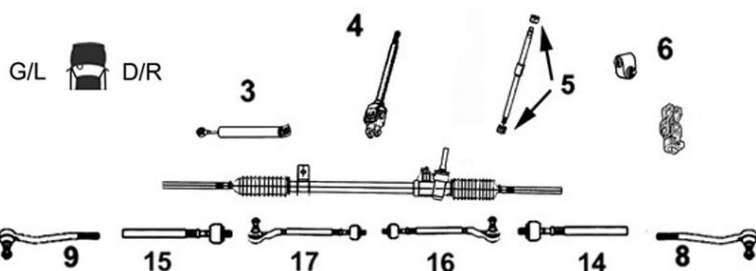

7770021

Axe de bielle G/D

OE 4422A012

L/R axial joint

NEW



14 Côté dir. M14x1.5 Côté rot. M14x1.5
15 long 342 mm

2.0i	CW	11/06-06/12
2.0 DiD	CW	11/06-06/12
2.2 DID	CW	11/06-06/12
2.4i	CW	11/06-06/12

7670007

Rotule de direction G/D

OE 4422A018

L/R tie rod end



8 M14 x 1.5
9

2.0 DiD	03/07-
2.2 DID	08/07-
2.4	09/07-



Barre stabilisatrice

Stabilizer bar

Barra estabilizadora

Drażek stabilizatora

стабилизатор поперечной устойчивости

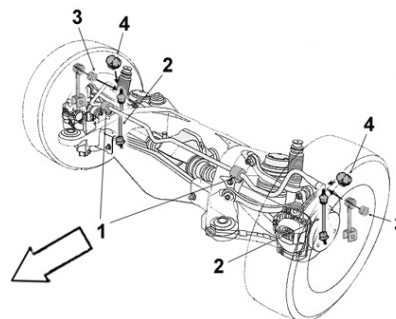

2300046

Palier de barre milieu

OE 4156A028

Middle bar main bearing

NEW



1 Ø 19

2.0i	4B11	09/09-08/12
2.0 DiD 4WD		03/07-08/12
2.2 DiD /FAP /4WD		09/07-08/12
2.4i 4WD		05/07-08/12

Pajero

Eléments DIRECTION

Steering parts

Elementos Direcciones

Elementy układ kierowniczy

Элементы рулевой системы

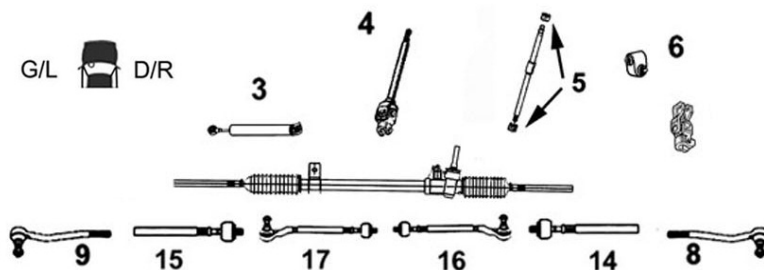

9006547

Rotule de direction G/D Ext.

OE MB241171

L/R outer tie rod end



8 M16 x 1.5
9

TT /all models	04/82-09/90
L041G/43G/44G/46G	
L048G/49G/141G/144G	
L146G/149G	

9006548

Rotule de direction G/D Ext.

OE MB831043

L/R outer tie rod end



8
9

TT /all models	10/90-
V14V V23C W V24C V	
V24W WG V34V V43W	
V44W WG	

Space Star



Eléments SUSPENSION

Suspension parts

Elementos suspensión

Elementy zawieszenie

Элементы подвески

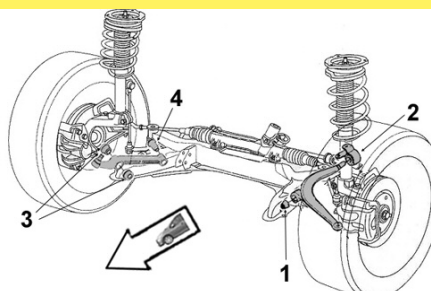

2256041

Articulation AR G

OE MB808909

Left rear bush

2 Ø int. 20.5



1.3i	10/98-03/06
1.6i	03/01-03/05
1.8 GDi 16v.	07/00-03/06
1.9 DCi	09/02-03/05
1.9 DiD	07/00-03/06

2256042

Articulation AR D

OE MB808910

Right rear bush

2 Ø int. 20.5



1.3i	10/98-03/06
1.6i	03/01-03/05
1.8 GDi 16v.	07/00-03/06
1.9 DCi	09/02-03/05
1.9 DiD	07/00-03/06

200 SX

Eléments DIRECTION

Steering parts

Elementos Direcciones

Elementy układ kierowniczy

Элементы рулевой системы

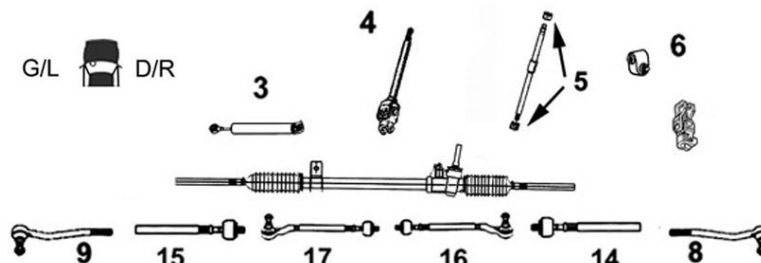

7676035

Rotule de direction G/D

OE 485200M085

L/R tie rod end

8 M14x15
9



2.0i	10/93-12/99
2.0i 16v. Turbo	10/93-12/99

Almera ...

Eléments DIRECTION

Steering parts

Elementos Direcciones

Elementy układ kierowniczy

Элементы рулевой системы

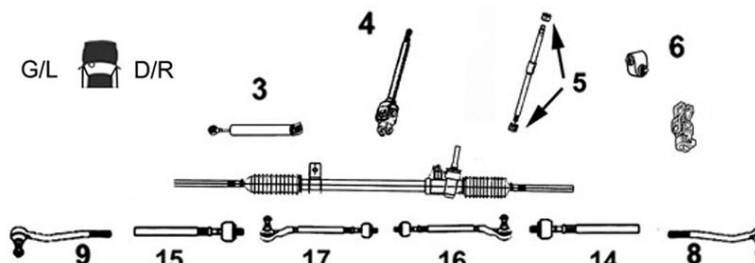

7776104

Axe de bielle G/D

OE 485211M210

L/R axial joint

NEW



14 Côté dir. M16x1.0 Côté rot. M12x1.25
15 long 275 mm

1.4i 16v. DA	09/95-07/00
1.6i 16v. DA	09/95-07/00

9006849

Axe de bielle G/D

Part/oe 4852165F01

L/R axial joint



14 Côté dir. M16x1.0 Côté rot. M14x1.5
15 long 276 mm

2.0 GTi	-03/00
2.0 D	-03/00

... Almera ...

Eléments DIRECTION

Steering parts

Elementos Direcciones

Elementy uklad kierowniczy

Элементы рулевой системы

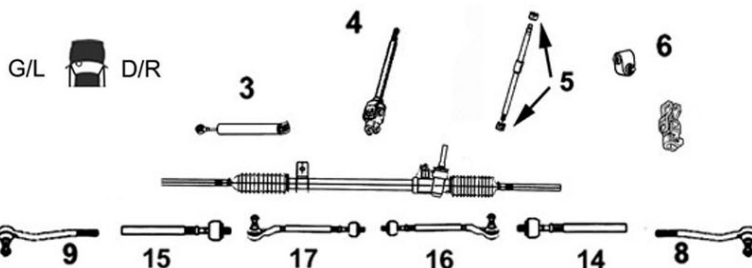

NISSAN

7776057

Axe de bielle G/D

Part/oe 49001BN013 L/R axial joint

NEW



14 Côté dir. M14x1.5 Côté rot. M12x1.25
15 long 278 mm

1.5i 16v. 3/5ptes	04/00-12/05
1.8i 16v. 115hp 85kw 3/5ptes	04/00-12/05
2.2 DCi 136hp 100kw 3/5ptes	04/03-12/05
2.2 D VDi 110hp 81kw 3/5ptes	04/00-12/05

7776070

Axe de bielle G/D

OE 485214M500 L/R axial joint

NEW



14 Côté dir. M16x1.0 Côté rot. M14x1.5
15 long 286 mm

1.5i 16v. /Break QG15DE	04/00-12/05
1.5 DCi	01/03-
1.6i 16v.	10/05-12/06
1.8i 16v. /Break	04/00-12/05
2.2 DCi	12/02-12/05
2.2 VDi /Break	04/00-12/05

9006688

Rotule de direction G/D

OE 4852050Y25 L/R tie rod end



8 M12 x 1.25
9

1.4i 16v.	-03/00
1.6i 16v.	-03/00

7676035

Rotule de direction G/D

OE 485200M085 L/R tie rod end



8 M14 x 1.5
9

1.5i 16v.	07/00-12/05
1.5 DCi	01/03-12/06
1.8i 16v.	01/00-12/05
2.0 GTi	10/96-04/98
2.0 D	10/95-07/00
2.2 DCi	03/00-12/05

9006580

Rotule de direction G/D

OE 48520BM425 L/R tie rod end



8 M12 x 1.25
9

1.5i 16v.	3/5ptes	04/00-
1.5 DCi	3/5ptes	01/02-
1.8i 16v.	3/5ptes	04/00-
2.2 DCi	3/5ptes	01/00-
2.2 D VDi	3/5ptes	04/00-



Barre stabilisatrice

Stabilizer bar

Barra estabilizadora

Drażek stabilizatora

стабилизатор поперечной устойчивости

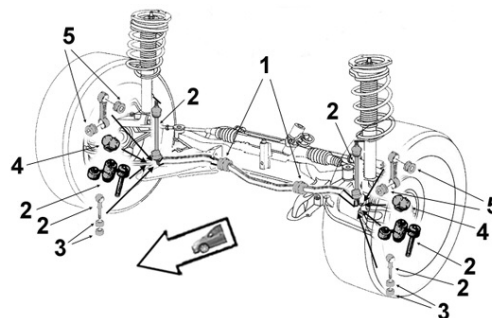

2306050

Biellette barre stab.

OE 546184M400 Stabilizer bar stub axle



2

1.5i 16v.	BVM	04/00-12/05
1.5 DCi	BVM	01/03-12/05
1.8i 16v.		04/00-12/05
2.2 DCi		04/03-
2.2 D VDi	BVM	04/00-12/05

... Almera

Bras & Triangle de suspension

Control arm
Brazo y triángulo
Wahacz
Рычаг подвески

G/L  D/R

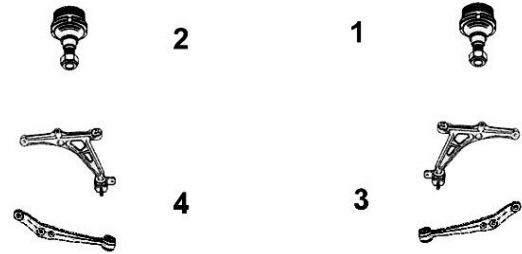

9005827 Triangle de susp. G
OE 545010M060 Left track control arm

4 Avec rotule With ball joint



1.4i 16v.	-03/00
1.6i 16v.	-03/00
2.0 D	-03/00

9005826 Triangle de susp. D
OE 545000M060 Right track control arm

3 Avec rotule With ball joint



1.4i 16v.	-03/00
1.6i 16v.	-03/00
2.0 D	-03/00

9005829 Triangle de susp. G
OE 54501F4600 Left track control arm

4 Avec rotule With ball joint



1.5i 16v.	3/5ptes	04/00-
1.5 DCi	3/5ptes	09/02-
1.8i 16v.	3/5ptes	04/00-
2.2 DCi	3/5ptes	09/02-
2.2 D VDi	3/5ptes	04/00-

9005828 Triangle de susp. D
OE 54500F4600 Right track control arm

3 Avec rotule With ball joint



1.5i 16v.	3/5ptes	04/00-
1.5 DCi	3/5ptes	09/02-
1.8i 16v.	3/5ptes	04/00-
2.2 DCi	3/5ptes	09/02-
2.2 D VDi	3/5ptes	04/00-

Almera Tino

Eléments DIRECTION

Steering parts
Elementos Direcciones
Elementy układ kierowniczy
Элементы рулевой системы

G/L  D/R

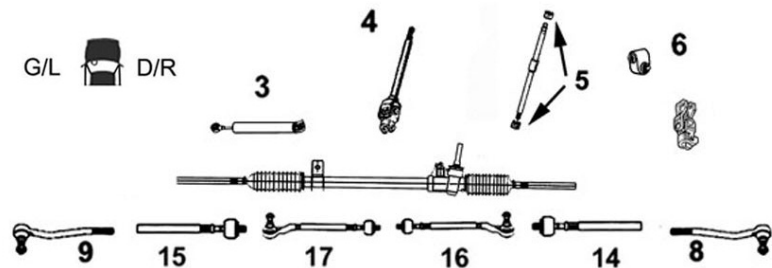

7776031 Axe de bielle G/D
OE 485214U110 L/R axial joint

14 Côté dir. M16x1.0 Côté rot. M14x1.5 long 305 mm
15



1.8i 16v.	08/00-
2.0i 16v.	08/00-
2.2 DCi	08/00-

7676035 Rotule de direction G/D
OE 485200M085 L/R tie rod end

8 M14x1.5
9



1.8 16v.	08/00-09/06
2.0 16v.	08/00-04/03
2.2 DCi	08/00-09/06

Cube

SASIC

NISSAN



Support d'amortisseur
 Suspension mounting
 Soporte amortiguador
 Poduszka amortyzatora
 Опора амортизатора

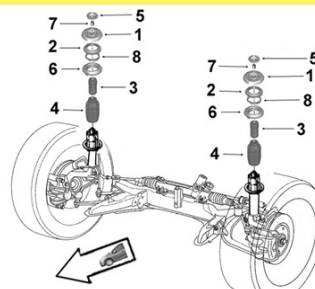

8005213

Butée à billes

OE 54325ED02A

Ball bearing

2



1.5 DCi
1.6i

Juke ...



Barre stabilisatrice
 Stabilizer bar
 Barra estabilizadora
 Drażek stabilizatora
 стабилизатор поперечной устойчивости

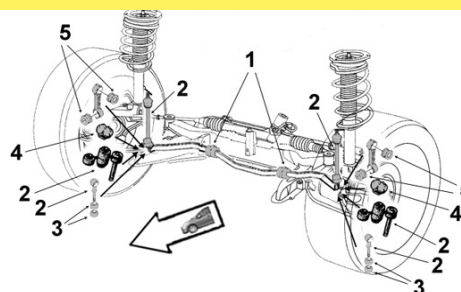

2306115

Palier de barre milieu

OE 54613JD04A

Middle bar main bearing

1 repère jaune Yellow mark Ø 22



1.6i

HR16

BVM5 /Seq.

Bras & Triangle de suspension

Control arm
 Brazo y triángulo
 Wahacz
 Рычаг подвески

G/L  D/R

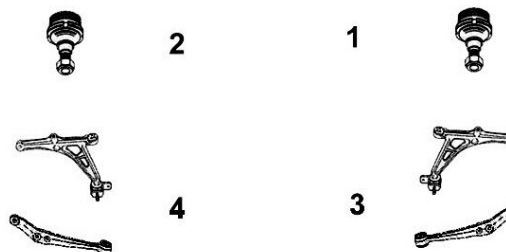

7476237

Triangle de susp. G

OE 545011KA0B

Left track control arm

NEW

3 Ø18 Avec rotule With ball joint



1.5 DCi
1.6i

7476235

Triangle de susp. D

OE 545001KA1B

Right track control arm

NEW

4 Ø18 Avec rotule With ball joint



1.5 DCi
1.6i

... Juke



Support d'amortisseur
 Suspension mounting
 Soporte amortiguador
 Poduszka amortyzatora
 Опора амортизатора

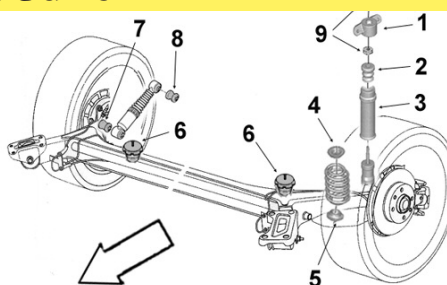

2654029

Coupelle sup. ressort AR

OE 55034JD00A

Rear spring upper cup

4



1.5 DCi
 1.6i

NISSAN



Leaf



Support d'amortisseur
 Suspension mounting
 Soporte amortiguador
 Poduszka amortyzatora
 Опора амортизатора

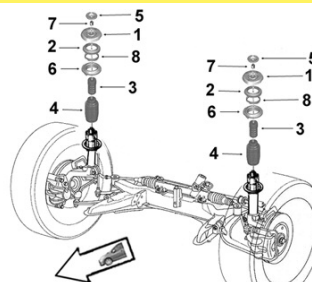

2306115

Palier de barre milieu

OE 54613JD04A

Middle bar main bearing

1 repère jaune Yellow mark Ø 22



Electric

Bras & Triangle de suspension

Control arm
 Brazo y triángulo
 Wahacz
 Рычаг подвески

G/L  D/R

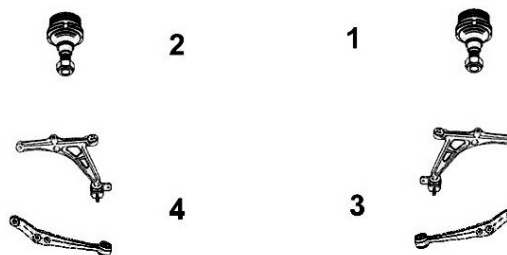

7476237

Triangle de susp. G

OE 545011KA0B

Left track control arm

NEW

3 Ø18 Avec rotule With ball joint



Electric

7476235

Triangle de susp. D

OE 545001KA1B

Right track control arm

NEW

4 Ø18 Avec rotule With ball joint



Electric

Maxima

Eléments DIRECTION
 Steering parts
 Elementos Direcciones
 Elementy układ kierowniczy
 Элементы рулевой системы

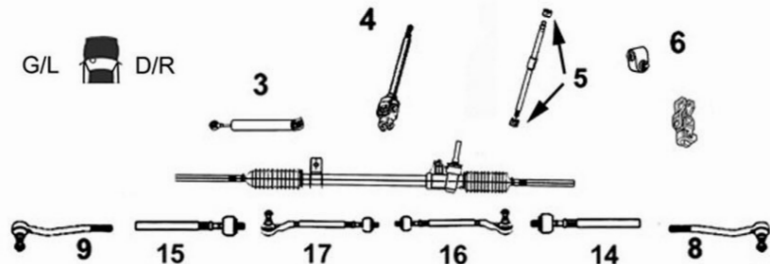

7776105

Axe de bielle G/D

OE 485210C005

L/R axial joint

NEW



14 Côté dir. M16x1.0 Côté rot. M14x1.5
 15 long 310 mm

2.0i QX 03/95-04/00
 2.5i V6 10/97-
 3.0i QX 03/95-04/00

7676035

Rotule de direction G/D

OE 485200M085

L/R tie rod end



8 M14 x 1.5
 9

2.0 V6 02/95-08/04
 3.0 V6 01/95-08/04

Micra ...

Eléments DIRECTION
 Steering parts
 Elementos Direcciones
 Elementy układ kierowniczy
 Элементы рулевой системы

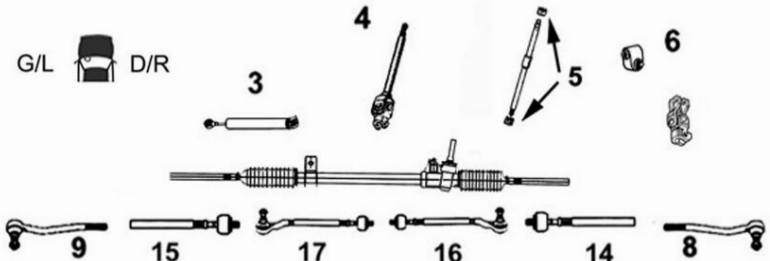

7776107

Axe de bielle G/D

Part/oe D85211HA0A L/R axial joint

NEW



14 Côté dir. M14x1.5 Côté rot. M12x1.25
 15 long 230 mm

1.2i /Komp K13 07/10-

9006551

Rotule de direction G/D

OE 4852017B25

L/R tie rod end



8 M12 x 1.25
 9

TT /all models K10/11 -07/92

9006578

Rotule de direction G

OE 48640AX600

Left tie rod end



9 M14 x 1.5

1.2i 16v. K12 11/02-03/04
 1.4i 16v. K12 BVM BVA 11/02-03/04
 1.5 DCi 65hp 48kw 80hp 60kw
 K12 11/02-03/04

9006577

Rotule de direction D

OE 48520AX600

Right tie rod end



8 M14 x 1.5

1.2i 16v. K12 11/02-03/04
 1.4i 16v. K12 BVM BVA 11/02-03/04
 1.5 DCi 65hp 48kw 80hp 60kw
 K12 11/02-03/04

4006134

Rotule de direction G

OE 48640AX602

Left tie rod end



9

1.2i 16v. K12 04/04-10/07
 1.4i 16v. /Cab. K12 04/04-10/07
 1.5 DCi K12 04/04-10/07
 1.6i 16v. /Cab. K12 04/04-10/07

4006135

Rotule de direction D

OE 48520AX602

Right tie rod end





8



1.2i 16v. K12 04/04-10/07
 1.4i 16v. /Cab. K12 04/04-10/07
 1.5 DCi K12 04/04-10/07
 1.6i 16v. /Cab. K12 04/04-10/07

... Micra ...

NISSAN





7676038 OE 486471U61A	Rotule de direction G <i>Left tie rod end</i>	7676037 OE 485271U61A	Rotule de direction D <i>Right tie rod end</i>
	9 M12x1.25 1.2i 16v. K12 11/07-10/10 1.4i 16v. /Cab. K12 11/07-10/10 1.5 DCi K12 11/07-10/10 1.6i 16v. /Cab. K12 11/07-10/10		8 M12x1.25 1.2i 16v. K12 11/07-10/10 1.4i 16v. /Cab. K12 11/07-10/10 1.5 DCi K12 11/07-10/10 1.6i 16v. /Cab. K12 11/07-10/10

7676094 OE D86401HA0A	Rotule de direction G <i>Left tie rod end</i>	7676093 OE D85201HA0A	Rotule de direction D <i>Right tie rod end</i>
	9 M12x1.25 1.2i /Komp K13 11/10-		8 M12x1.25 1.2i /Komp K13 11/10-

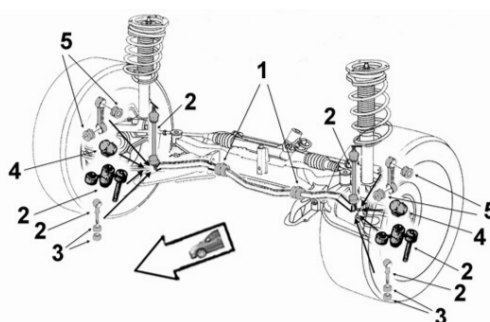

Barre stabilisatrice
 Stabilizer bar
 Barra estabilizadora
 Drażek stabilizatora
 стабилизатор поперечной устойчивости





2306049 OE (3oe) 5461847B0A+56112V0100+5611360U0A	Biellette barre stab. <i>Stabilizer bar stub axle</i>	4005147 OE 54618BC40A	Biellette barre stab. <i>Stabilizer bar stub axle</i>
	2 1.0i 16v. K11 04/98-12/00 1.3i K11 04/98-12/00 1.5 D K11 BVM 04/98-09/00		2 Entraxe : 250 mm M10x150 X2 1.2i 16v. K12 01/03-10/10 1.4i 16v. /Cab K12 01/03-10/10 1.5 DCi K12 BVM 03/03-10/10 1.6i 16v./Cab K12 07/05-10/10

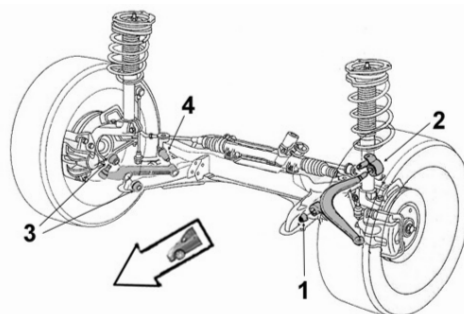

Eléments SUSPENSION
 Suspension parts
 Elementos suspensión
 Elementy zawieszenie
 Элементы подвески



2256047 OE 54570AX600	Articulation AR <i>Rear bush</i>	4001585 OE 54560AX600	Articulation AV <i>Front bush</i>
	2 Ø int.12 Ø ext.58 long. tube int.53 ext.21 1.2i 16v. K12 BVM BVA 11/02-10/10 1.4i 16v. K12 BVM BVA 11/02-10/10 1.5 DCi 65hp 48kw 80hp 60kw K12 BVM BVA 11/02-10/10		1 Ø int.12 Ø ext.36 coll.40 long. tube int.55 ext.39 ep. coll.5X2 1.2i 16v. K12 BVM BVA 11/02-10/10 1.4i 16v. K12 BVM BVA 11/02-10/10 1.5 DCi 65hp 48kw 80hp 60kw K12 BVM BVA 11/02-10/10

... Micra



NISSAN

Bras & Triangle de suspension

Control arm
Brazo y triángulo
Wahacz
Рычаг подвески

G/L D/R

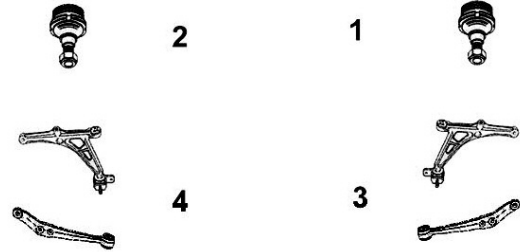

7476065

Triangle de susp. G

OE 545014F105

Left track control arm

4 Avec rotule With ball joint



1.0i 16v. K10/K11 08/92-03/00
1.3i 16v. K10/K11 08/92-08/00

7476064

Triangle de susp. D

OE 545006F600

Right track control arm

3 Avec rotule With ball joint



1.0i 16v. K10/K11 08/92-08/00
1.3i 16v. K10/K11 08/92-08/00

9005836

Triangle de susp. inf. G

OE 545016F600

Lower left track control arm

4 Avec rotule With ball joint



1.0 3/5ptes K11 04/98-11/02
1.2i 16v. K12 11/02-10/10
1.3i K11 08/92-09/00
1.4i 16v. K11 BVM BVA 09/00-11/02
1.4i 16v./Cab. K12 BVM BVA 11/02-10/10
1.5 D K11 04/98-11/02
1.5 DCi 65hp 48kw 80hp 60kw
K12 11/02-10/10
1.6i 16v./Cab. K12 07/05-10/10

9005834

Triangle de susp. inf. D

OE 54500BC42A

Lower right track control arm

3 Avec rotule With ball joint



1.0 3/5ptes K11 04/98-11/02
1.2i 16v. K12 11/02-10/10
1.3i K11 08/92-09/00
1.4i 16v. K11 BVM BVA 09/00-11/02
1.4i 16v./Cab. K12 BVM BVA 11/02-10/10
1.5 D K11 04/98-11/02
1.5 DCi 65hp 48kw 80hp 60kw
K12 11/02-10/10
1.6i 16v./Cab. K12 07/05-10/10

9005430

Rotule de susp. inf. G/D

OE 401604F100

L/R lower suspension ball joint

1
2



TT /all models

K10/K11

08/92-11/02



Support d'amortisseur

Suspension mounting
Soporte amortiguador
Poduszka amortyzatora
Опора амортизатора

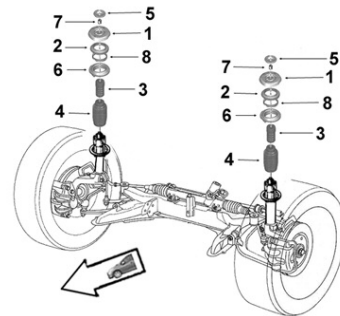

2656001

Butée protecteur susp. G/D

OE 54050AX601

L/R suspension bush

3
4



1.2i 16v. K12 01/03-11/10
1.4i 16v./Cab. K12 01/03-11/10
1.5 DCi K12 BVM 03/03-11/10
1.6i 16v./Cab. K12 07/05-11/10

8005213

Butée à billes

OE 54325ED02A

Ball bearing

2



1.2i 16v. K12 BVM BVA
01/03-11/10
1.4i 16v. /Cab. K12 BVM BVA
01/03-11/10
1.5 DCi K12 03/03-11/10
1.6i 16v. /Cab. K12 07/05-11/10

Note ...

Eléments DIRECTION

Steering parts

Elementos Direcciones

Elementy układ kierowniczy

Элементы рулевой системы

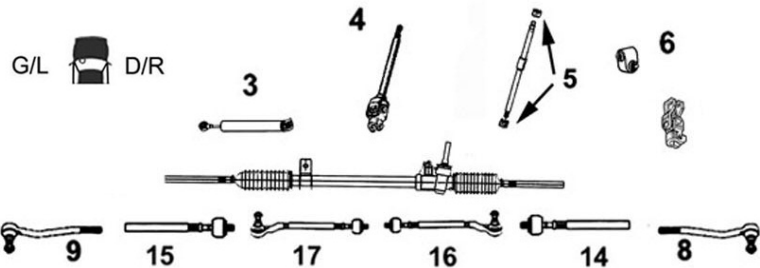

7676038

Rotule de direction G

OE 486471U61A

Left tie rod end



9 M12x1.25

1.4i 16v.
1.5 DCi
1.6i 16v.

7676037

Rotule de direction D

OE 485271U61A

Right tie rod end



8 M12x1.25

1.4i 16v.
1.5 DCi
1.6i 16v.



Barre stabilisatrice

Stabilizer bar

Barra estabilizadora

Drażek stabilizatora

стабилизатор поперечной устойчивости

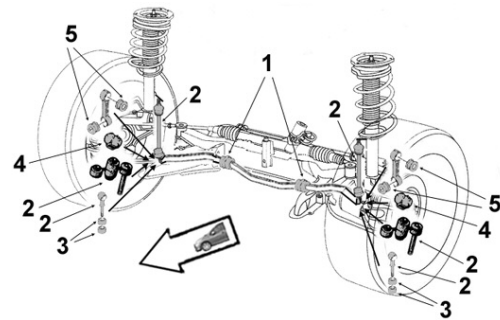

4005147

Biellette barre stab.

OE 54618BC40A

Stabilizer bar stub axle



2 Entraxe : 250 mm M10x150 X2

1.4i 16v.
1.5 DCi
1.6i 16v.



Eléments SUSPENSION

Suspension parts

Elementos suspensión

Elementy zawieszenie

Элементы подвески

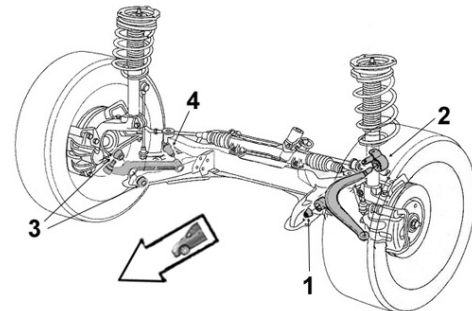

2256047

Articulation AR

OE 54570AX600

Rear bush



2 Ø int.12 Ø ext.58 long. tube int.53 ext.21

1.4i 16v.
1.5 DCi
1.6i 16v.

4001585

Articulation AV

OE 54560AX600

Front bush



**1 Ø int.12 Ø ext.36 coll.40
long. tube int.55 ext.39 ep. coll.5X2**

1.4i 16v.
1.5 DCi
1.6i 16v.

...Note

Bras & Triangle de suspension

Control arm
Brazo y triángulo
Wahacz
Рычаг подвески

G/L  D/R

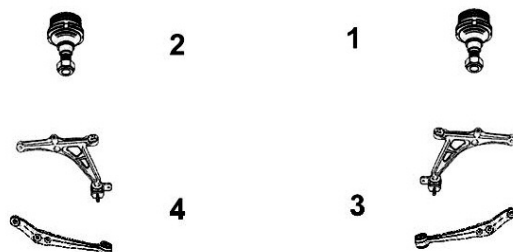

9005836

Triangle de susp. inf. G

OE 545016F600

Lower left track control arm

4 Avec rotule *With ball joint*



1.4i 16v.
1.5 DCi
1.6i 16v.

9005834

Triangle de susp. inf. D

OE 54500BC42A

Lower right track control arm

3 Avec rotule *With ball joint*



1.4i 16v.
1.5 DCi
1.6i 16v.



Support d'amortisseur

Suspension mounting
Soporte amortiguador
Poduszka amortyzatora
Опора амортизатора

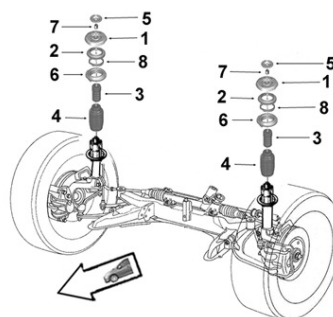

2656029

Support suspension G

OE 543219U01A

Left suspension mounting

1



1.4i 16v. CR14
1.5 DCi 70hp 50kw K9K274
1.5 DCi 85hp 63kw K9K276
1.5 DCi 105hp 76kw K9K288
1.6i 16v. HR16DE

2656030

Support suspension D

OE 543209U01A

Right suspension mounting

1



1.4i 16v. CR14
1.5 DCi 70hp 50kw K9K274
1.5 DCi 85hp 63kw K9K276
1.5 DCi 105hp 76kw K9K288
1.6i 16v. HR16DE

8005213

Butée à billes

OE 54325ED02A

Ball bearing

2



1.4i 16v.
1.5 DCi
1.6i 16v.

Primera

Eléments DIRECTION
 Steering parts
 Elementos Direcciones
 Elementy układ kierowniczy
 Элементы рулевой системы

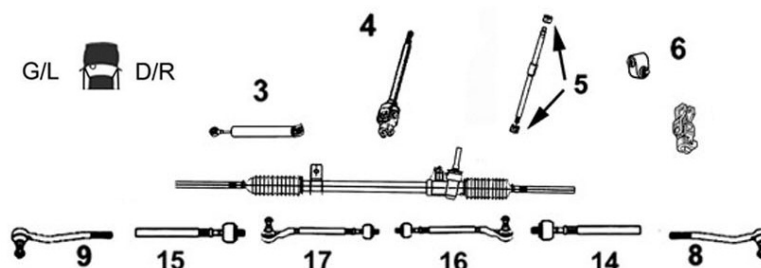

9006688 Rotule de direction G/D

OE 4852073J25

L/R tie rod end



8 **M12 x 1.25**

9 TT /all models

P10/1

10/90-12/98

01/99-02/02

03/02-

01/99-02/02

03/02-

03/02-

01/99-02/02

03/02-

01/99-02/02

03/02-

03/02-

1.6
 1.6 4ptes
 1.8i 16v.
 1.8i 16v. 4/5ptes
 1.9 DCi 4/5ptes
 2.0i /16v.
 2.0 4/5ptes
 2.0 TD
 2.2 DCi
 2.2 VDi 4/5ptes

BVM5 BVA

BVM BVA

BVM6/Séqu.

Bras & Triangle de suspension

Control arm
 Brazo y triángulo
 Wahacz
 Рычаг подвески

G/L D/R

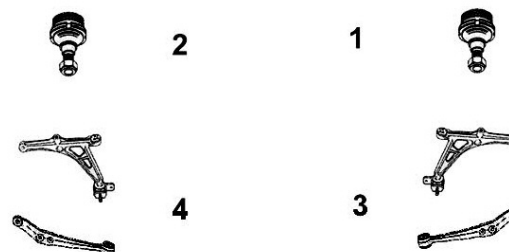

9005831 Triangle de susp. inf. G

OE 545019F500

Lower left track control arm



4 Avec rotule With ball joint

1.6 01/99-02/02
 1.8i 16v. 01/99-02/02
 2.0i /16v. 01/99-02/02
 2.0 TD 01/99-02/02

9005830 Triangle de susp. inf. D

OE 545009F500

Lower right track control arm



3 Avec rotule With ball joint

1.6 01/99-02/02
 1.8i 16v. 01/99-02/02
 2.0i /16v. 01/99-02/02
 2.0 TD 01/99-02/02

9005833 Triangle de susp. inf. G

OE 54501AV60C

Lower left track control arm



4 Avec rotule With ball joint

1.6 4ptes 03/02-
 1.8i 16v. 4/5ptes BVM5 BVA 03/02-
 1.9 DCi 4/5ptes 03/02-
 2.0 4/5ptes BVM6 BV Séqu. 03/02-
 2.2 DCi 4/5ptes 03/02-
 2.2 VDi 4/5ptes 03/02-

9005832 Triangle de susp. inf. D

OE 54500AV60C

Lower right track control arm



3 Avec rotule With ball joint

1.6 4ptes 03/02-
 1.8i 16v. 4/5ptes BVM5 BVA 03/02-
 1.9 DCi 4/5ptes 03/02-
 2.0 4/5ptes BVM6 BV Séqu. 03/02-
 2.2 DCi 4/5ptes 03/02-
 2.2 VDi 4/5ptes 03/02-

9005299 Rotule de susp. inf. G/D

Part/oe 5450086J00

L/R lower suspension ball joint



1/2

TT /all models

P10

10/90-12/95

Qashqai ...

Eléments DIRECTION
 Steering parts
 Elementos Direcciones
 Elementy układ kierowniczy
 Элементы рулевой системы

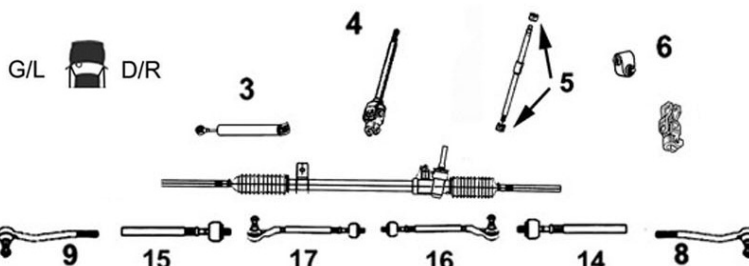

7676040 Rotule de direction G

OE 48647JD01A *Left tie rod end*



9 M14x1.5

1.5 DCi
 1.6i 16v.
 1.6 DCi /4WD 06/11-
 2.0i 16v.
 2.0 DCi /4WD FAP

7676039 Rotule de direction D

OE 48527JD01A *Right tie rod end*



8 M14x1.5

1.5 DCi
 1.6i 16v.
 1.6 DCi /4WD 06/11-
 2.0i 16v.
 2.0 DCi /4WD FAP



Barre stabilisatrice
 Stabilizer bar
 Barra estabilizadora
 Drażek stabilizatora
 стабилизатор поперечной устойчивости

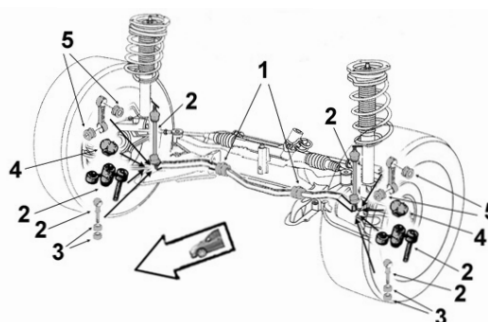

2304010 Bielle barre stab. G

OE 546681AA0A *Left stabilizer bar stub axle*



2

1.5 DCi BVM
 1.6i 16v. BVM
 2.0i 16v. /4WD
 2.0 DCi /4WD FAP

2304009 Bielle barre stab. D

OE 546181AA0A *Right stabilizer bar stub axle*



2

1.5 DCi BVM
 1.6i 16v. BVM
 2.0i 16v. /4WD
 2.0 DCi /4WD FAP

2306115 Palier de barre milieu

OE 54613JD04A *Middle bar main bearing*



1 repère jaune *Yellow mark* Ø 22

1.6 DCi FAP 130hp 96kw / 4WD
 2.0 DCi FAP 150hp 110kw /4WD

BVM6
 BVM6 BVA6

06/11-

... Qashqai ...

Bras & Triangle de suspension

Control arm
Brazo y triángulo
Wahacz
Рычаг подвески

G/L  D/R

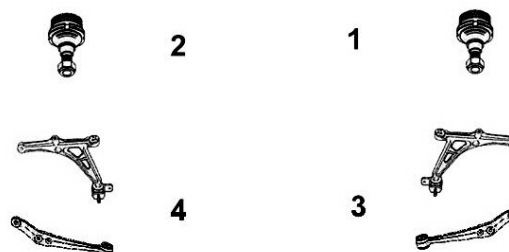

7476070

Triangle de susp. G

OE 54501BB00A

Left track control arm



4 Avec rotule With ball joint

1.5 DCi 105hp 78kw 110hp 81kw
1.6i 16v. 115hp 84kw
1.6 DCi 130hp 96kw 06/11-
2.0i 16v. 141hp 104kw
2.0 DCi 150hp 110kw

7476069

Triangle de susp. D

OE 54500BB00A

Right track control arm



3 Avec rotule With ball joint

1.5 DCi 105hp 78kw 110hp 81kw
1.6i 16v. 115hp 84kw
1.6 DCi 130hp 96kw 06/11-
2.0i 16v. 141hp 104kw
2.0 DCi 150hp 110kw



Support d'amortisseur

Suspension mounting
Soporte amortiguador
Poduszka amortyzatora
Опора амортизатора

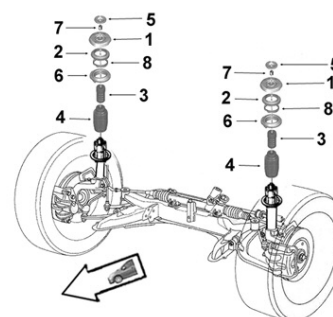

8005213

Butée à billes

OE 54325ED02A

Ball bearing



2

1.5 DCi
1.6i 16v.
2.0i 16v.
2.0 DCi

2656061

Coupelle ressort inf.

OE 54035JD00A

Lower rear spring cup



6

1.5 DCi
1.6i 16v.
2.0i 16v. /4WD
2.0 DCi /4WD FAP



Barre stabilisatrice

Stabilizer bar
Barra estabilizadora
Drażek stabilizatora
стабилизатор поперечной устойчивости

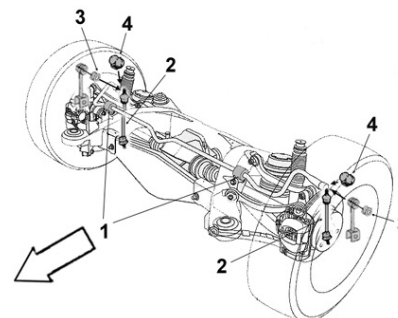

2304013

Biellette barre stab. G

OE 55619JY00B

Left stabilizer bar stub axle



2

1.5 DCi
1.6i 16v.
2.0i 16v.
2.0 DCi

2304012

Biellette barre stab. D

OE 55618JY00B

Right stabilizer bar stub axle



2

1.5 DCi
1.6i 16v.
2.0i 16v.
2.0 DCi

... Qashqai



Barre stabilisatrice
Stabilizer bar
Barra estabilizadora
Drażek stabilizatora
 стабилизатор поперечной устойчивости

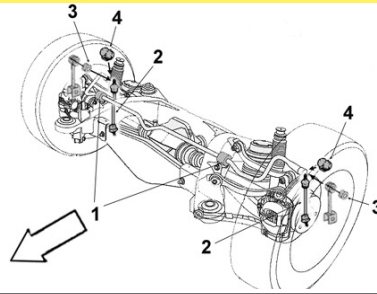

2306117 **Palier de barre milieu**
 OE 54613JD17A *Middle bar main bearing*



1 Ø17

1.5 DCi 105hp 77kw
 1.5 DCi FAP 105hp 77kw
 1.6i 16v.
 1.6 DCi FAP 130hp 96kw/ 4WD
 2.0i 16v. /4WD
 2.0 DCi FAP 150hp 110kw 2WD

BVM6 -09/10
 BVM6 03/09-
 BVM5 -09/10
 BVM6 06/11-
 BVM6 /Séq.
 BVM6 BVA6 -09/10



Support d'amortisseur
Suspension mounting
Soporte amortiguador
Poduszka amortyzatora
 Опора амортизатора

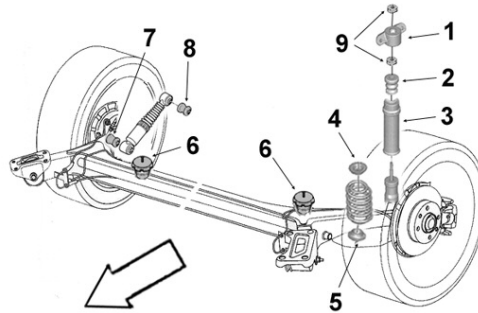

2654029 **Coupelle sup. ressort AR**
 OE 55034JD00A *Rear spring upper cup*



4

1.5 DCi
 1.6i 16v.
 2.0i 16v. /4WD
 2.0 DCi /4WD FAP

2656054 **Butée de talonnage**
 OE 55240JD000 *Bushing*



6

1.5 DCi 105hp 78kw BVM6
 1.5 DCi 110hp 81kw BVM6 10/10-
 1.5 DCi FAP 105hp 78kw BVM6
 03/09-09/10
 1.6i 16v. BVM5
 1.6 DCi FAP 130hp 96kw BVM6 06/11-
 2.0i BVM6 /Séq.
 2.0 DCi FAP 150hp 110kw BVM/A6

Sunny ...

Eléments DIRECTION
Steering parts
Elementos Direcciones
Elementy układu kierowniczy
 Элементы рулевой системы

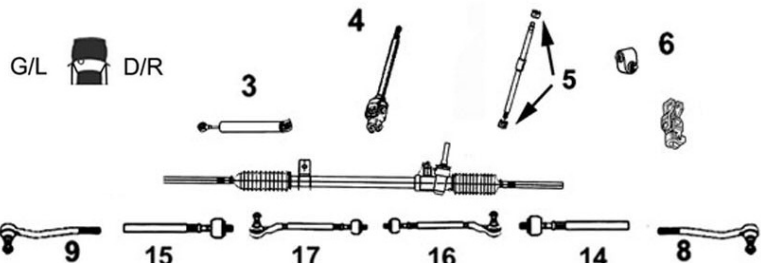

9006552 **Rotule de direction G/D**
 OE 4852050A26 *L/R tie rod end*

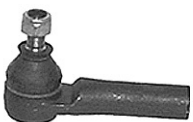

8
9 M12 x 1.25

TT /all models Sauf 4WD B12
 09/85-12/91

9006688 **Rotule de direction G/D**
 OE 485200M025 *L/R tie rod end*



8
9 M12 x 1.25

TT /all models 01/91-

... Sunny

Bras & Triangle de suspension

Control arm
Brazo y triángulo
Wahacz
Рычаг подвески

G/L  D/R

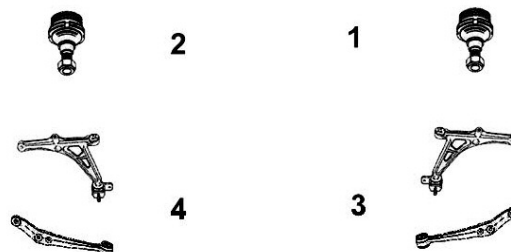

9005427

Rotule de susp. inf. G/D

OE 40160W2200

L/R lower suspension ball joint



1 M12 x 1.25
2

TT /all models

B12

09/85-12/91

Terrano II ...



Barre stabilisatrice

Stabilizer bar
Barra estabilizadora
Drażek stabilizatora
стабилизатор поперечной устойчивости

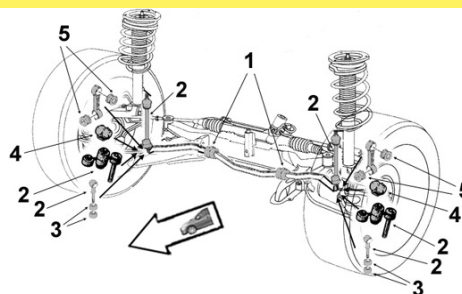

9005032

Biellette barre stab.

OE 54618MB40A

Stabilizer bar stub axle



2

2.4i
2.7 TD
2.7 TDi



Eléments SUSPENSION

Suspension parts
Elementos suspensión
Elementy zawieszenie
Элементы подвески

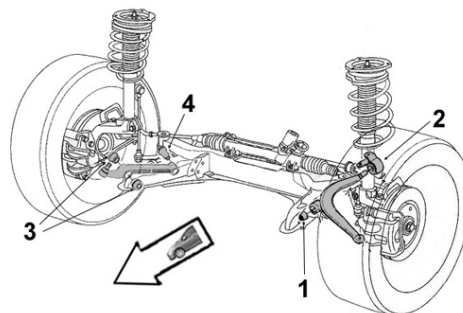

9003127

Articulation

OE 545600F001

Bush



1 Ø int.18 Ø ext.41 long. tube int.81 ext.64.5

2.4i
2.7 TD
2.7 TDi

...Terrano II

Bras & Triangle de suspension

Control arm
 Brazo y triángulo
 Wahacz
 Рычаг подвески

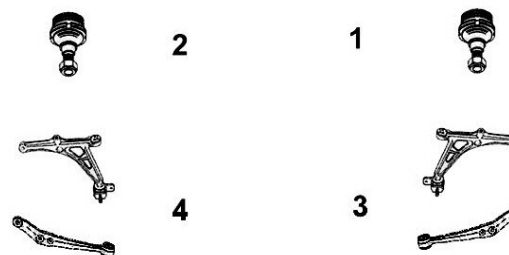
G/L  D/R**9005539****Rotule de susp. inf. G/D**

OE 401607F000

L/R lower suspension ball joint1
2

TT /all models

01/97-

Tiida...

Eléments DIRECTION

Steering parts
 Elementos Direcciones
 Elementy układ kierowniczy
 Элементы рулевой системы

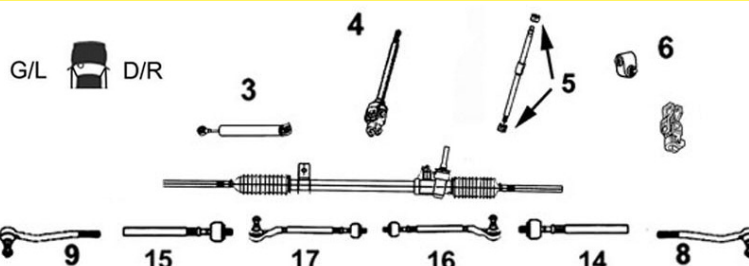
**7676038****Rotule de direction G**

OE 486471U61A

Left tie rod end

9

M12x1.25

1.5 DCi
 1.6i 16v.
 1.8i 16v.

7676037**Rotule de direction D**

OE 485271U61A

Right tie rod end

8

M12x1.25

1.5 DCi
 1.6i 16v.
 1.8i 16v.

**Barre stabilisatrice**

Stabilizer bar
 Barra estabilizadora
 Drażek stabilizatora
 стабилизатор поперечной устойчивости

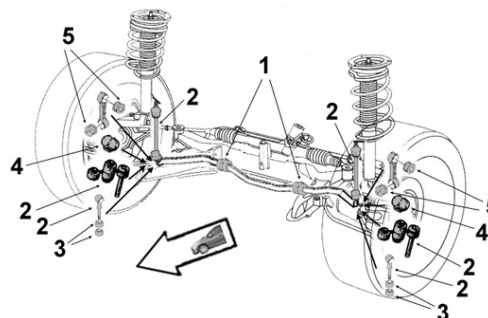
**4005147****Biellette barre stab.**

OE 54618BC40A

Stabilizer bar stub axle

2

Entraxe : 250 mm M10x150 X2

1.5 DCi
 1.6i 16v.
 1.8i 16v.

...Tiida



Eléments SUSPENSION

Suspension parts

Elementos suspensión

Elementy zawieszenia

Элементы подвески

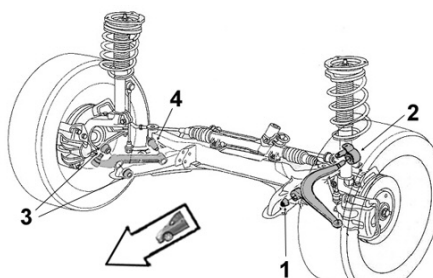

NISSAN



2256047

Articulation AR

OE 54570AX600

Rear bush



2 Ø int.12 Ø ext.58 long.tube int.53 ext.21
Sauf Amérique du sud

1.5 DCi
1.6i 16v.
1.8i 16v.

4001585

Articulation AV

OE 54560AX600

Front bush



1 Ø int.12 Ø ext.36 coll.40 long.tube int.55 ext.39 ep. coll.5X2

Sauf Amérique du sud

1.5 DCi
1.6i 16v.
1.8i 16v.

Bras & Triangle de suspension

Control arm

Brazo y triángulo

Wahacz

Рычаг подвески

G/L  D/R



7476090

Triangle de susp. G

OE 54501EL000

Left track control arm

NEW



4 Avec rotule With ball joint

Sauf Amérique du sud

1.5 DCi
1.6i 16v.
1.8i 16v.

7476089

Triangle de susp. D

OE 54500EL000

Right track control arm

NEW



3 Avec rotule With ball joint

Sauf Amérique du sud

1.5 DCi
1.6i 16v.
1.8i 16v.

7576017

Rotule de susp. inf. G/D

Part/oe 54500EL000 L/R lower suspension ball joint

NEW



1 Ø 18

2 Sauf Amérique du sud

1.5 DCi
1.6i 16v.
1.8i 16v.

X-Trail ...

Eléments DIRECTION

Steering parts

Elementos Direcciones

Elementy uklad kierowniczy

Элементы рулевой системы

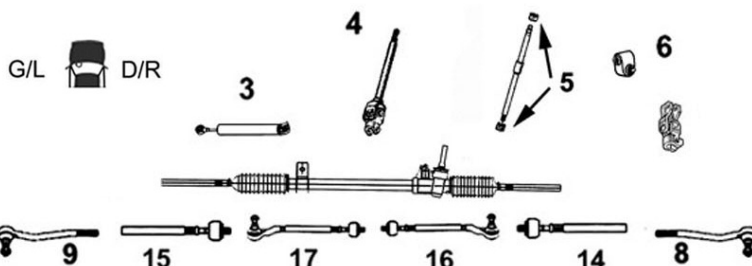

SASIC

NISSAN

7776032

Axe de bielle G/D

OE 485218H385

L/R axial joint



14 Côté dir. M16x1.0
15 Côté rot. M14x1.5 long 287 mm

2.0i 16v.	4WD	07/01-12/03
2.2 DCi /VDi	4WD	07/01-12/03
2.5i 16v.	4WD	09/02-12/03

7774019

Axe de bielle G/D

Part/oe D8521JD00B

L/R axial joint



14 Côté dir. M22x1.5
15 Côté rot. M14x1.5 long 233 mm

2.0i 16v.	T31	03/07-
2.0 DCi 150hp	110kw	175hp 127kw
2.5i 16v.	T31	03/07-
	T31	03/07-

9006579

Rotule de direction G/D

OE D85200P725

L/R tie rod end



8 M14 x 1.5
9

2.0i 16v.	4WD	QR20DE	07/01-05/05
2.0i 16v.		QR20DE	05/05-12/06
2.2 DCi	4WD	YD22	07/01-11/07
2.2 DCi		YD22	05/05-11/07
2.5i 16v.	4WD	QR25DE	09/02-12/06



Barre stabilisatrice

Stabilizer bar

Barra estabilizadora

Drażek stabilizatora

стабилизатор поперечной устойчивости

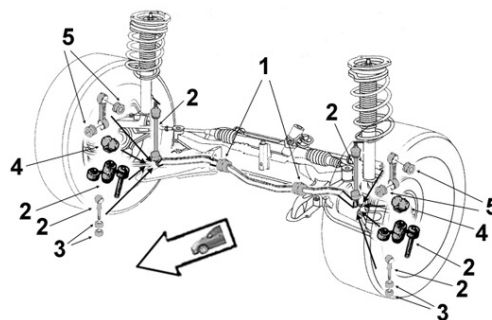

2304010

Biellette barre stab. G

OE 546681AA0A

Left stabilizer bar stub axle



2

2.0i 16v.	4WD	07/07-10/10
2.0 DCi	4WD /FAP	07/07-10/10
2.5i 16v.	4WD	07/07-10/10

2304009

Biellette barre stab. D

OE 546181AA0A

Right stabilizer bar stub axle



2

2.0i 16v.	4WD	07/07-10/10
2.0 DCi	4WD /FAP	07/07-10/10
2.5i 16v.	4WD	07/07-10/10

... X-Trail ...

Bras & Triangle de suspension

Control arm
Brazo y triángulo
Wahacz
Рычаг подвески

G/L  D/R



7476068

Triangle de susp. G

OE 545018H31A

Left track control arm

4 Avec rotule With ball joint



2.0i 16v.	07/01-12/06
2.2 DCi	07/01-11/07
2.5i 16v. 4WD	09/02-12/06

7476067

Triangle de susp. D

OE 545008H31A

Right track control arm

3 Avec rotule With ball joint



2.0i 16v.	07/01-12/06
2.2 DCi	07/01-11/07
2.5i 16v. 4WD	09/02-12/06



Support d'amortisseur

Suspension mounting
Soporte amortiguador
Poduszka amortyzatora
Опора амортизатора

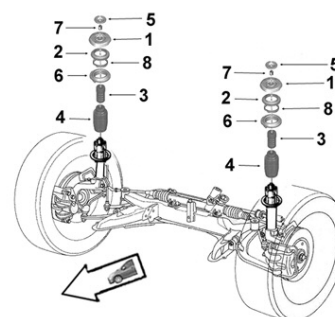

2654022

Support suspension G

OE 54320JG01B

Left suspension mounting

NEW

1



2.0i 16v.	Fabrication Japon	MR20	07/07-11/09
2.0i 16v.	Fabrication Russie	MR20	10/09-12/10
2.0 DCi	Fabrication Japon	M9R	07/07-11/09
2.0 DCi	Fabrication Russie	M9R	10/09-12/10
2.5i 16v.	Fabrication Japon	QR25DE	07/07-11/09
2.5i 16v.	Fabrication Russie	QR25DE	10/09-12/10



Barre stabilisatrice

Stabilizer bar
Barra estabilizadora
Drażek stabilizatora
стабилизатор поперечной устойчивости

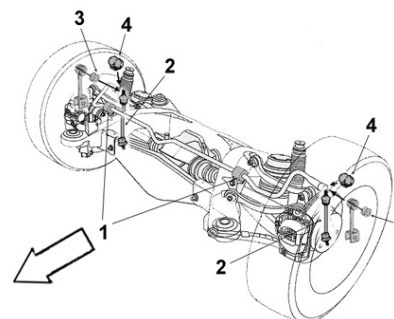

2304013

Biellette barre stab. G

OE 55619JY00B

Left stabilizer bar stub axle

2



2.0 DCi 4WD /FAP	07/07-
------------------	--------

2304012

Biellette barre stab. D

OE 55618JY00B

Right stabilizer bar stub axle

2



2.0 DCi 4WD /FAP	07/07-
------------------	--------

... X-Trail



Support d'amortisseur
 Suspension mounting
 Soporte amortiguador
 Poduszka amortyzatora
 Опора амортизатора

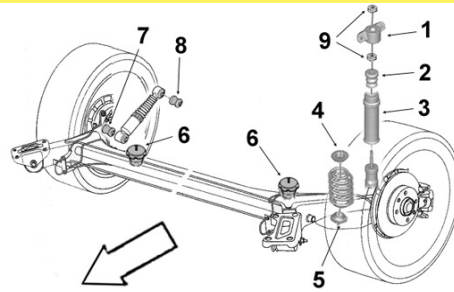

2654029

Coupelle sup. ressort AR

OE 55034JD00A

Rear spring upper cup

4



2.0i 16v.	4WD	07/07-10/10
2.0 DCi	150hp 110kw 175hp 127kw 4WD	07/07-
2.5i 16v.	4WD	07/07-10/10

Interstar ...

Eléments DIRECTION

Steering parts

Elementos Direcciones

Elementy uklad kierowniczy

Элементы рулевой системы

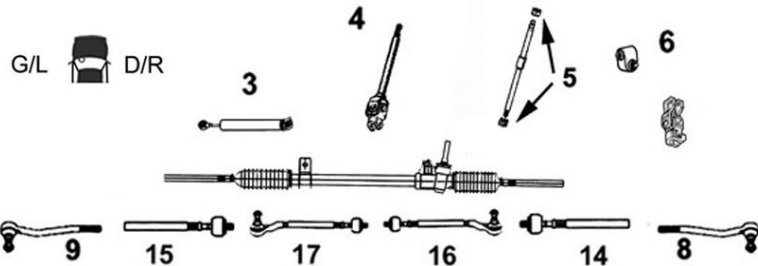

3008249

Axe de bielle G/D

OE 4852100QAF

L/R axial joint

14
15

Côté dir. M14x1.5 Côté rot. M16x1.5 long 176 mm



TT /all models

4006153

Rotule de direction G

OE 4852000QAH

Left tie rod end

9



TT /all models

4006154

Rotule de direction D

OE 4852000QAJ

Right tie rod end

8



TT /all models

... Interstar ...



Eléments SUSPENSION
Suspension parts
Elementos suspensión
Elementy zawieszenie
Элементы подвески

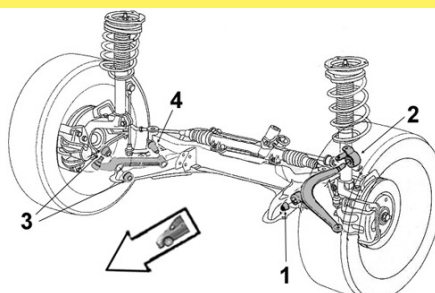

NISSAN



4001545 OE 5442300QAA	Art. AR triangle inf. <i>Lower track control arm rear bush</i>	4001548 OE 5457000QAA	Art. AV triangle inf. <i>Lower track control arm front bush</i>
	2 Ø int.28 Ø ext.55 coll.75 long. tube int.89 ext.58 ep. coll.14 1.9 DCi 2.2 DCi 2.5 DCi 3.0 DCi		1 Ø int.28 Ø ext.55 coll.75 long. tube int.74 ext.58 ep. coll.6 1.9 DCi 2.2 DCi 2.5 DCi 3.0 DCi

Bras & Triangle de suspension <i>Control arm</i> <i>Brazo y triángulo</i> <i>Wahacz</i> <i>Рычаг подвески</i>	G/L D/R	 2	1	 4	 3
--	----------	--------------	----------	--------------	--------------

9005768 OE 5450100Q0C	Triangle de susp. inf. G <i>Lower left track control arm</i>	9005767 OE 5450000Q0C	Triangle de susp. inf. D <i>Lower right track control arm</i>
	4 Fonte Iron Avec rotule With ball joint 1.9 DCi -08/07 2.2 DCi -08/07 2.5 DCi -08/07 3.0 DCi -08/07		3 Fonte Iron Avec rotule With ball joint 1.9 DCi -08/07 2.2 DCi -08/07 2.5 DCi -08/07 3.0 DCi -08/07

7474006 OE 8200750273	Triangle de susp. inf. G <i>Lower left track control arm</i>	7474007 OE 8200750274	Triangle de susp. inf. D <i>Lower right track control arm</i>
	4 Avec rotule With ball joint 1.9 DCi 09/07- 2.2 DCi 09/07- 2.5 DCi 09/07- 3.0 DCi 09/07-		3 Avec rotule With ball joint 1.9 DCi 09/07- 2.2 DCi 09/07- 2.5 DCi 09/07- 3.0 DCi 09/07-

4005276 OE 4016000QAD	Rotule de susp. inf. G/D <i>L/R lower suspension ball joint</i>	4005279 OE 4016000QAB	Rotule de susp. sup. G/D <i>L/R upper susp. ball joint</i>
	1 Ø 22 TT /all models		1 TT /all models

... Interstar

Bras & Triangle de suspension

Control arm
Brazo y triángulo
Wahacz
Рычаг подвески

G/L  D/R

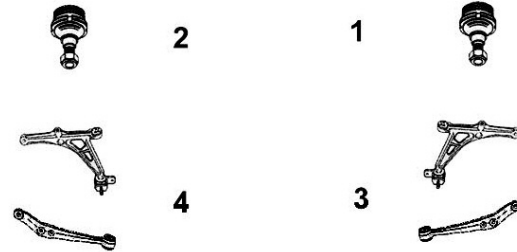

7574007

Rotule de susp. inf. G/D

OE 4016000Q0B

L/R lower suspension ball joint



1
2 Ø24

1.9 DCi 09/07-
2.2 DCi 09/07-
2.5 DCi 09/07-
3.0 DCi 09/07-

7574001

Rotule appui ressort

OE 4011000QAB

Ball joint Spring support



1
2

1.9 DCi
2.2 DCi
2.5 DCi
2.5 DCi
3.0 DCi
10/07-
11/03-

Kubistar

Eléments DIRECTION

Steering parts
Elementos Direcciones
Elementy układ kierowniczy
Элементы рулевой системы

G/L  D/R

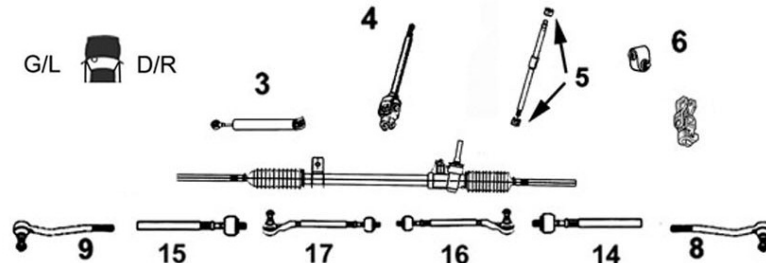

4006134

Rotule de direction G

OE 4852000QAN

Left tie rod end



9

1.2i /16v. VU -11/09
1.5 DCi VU -11/09

4006135

Rotule de direction D

OE 4852000QAP

Right tie rod end



8

1.2i /16v. VU -11/09
1.5 DCi VU -11/09

Primastar ...

Eléments DIRECTION

Steering parts
Elementos Direcciones
Elementy układ kierowniczy
Элементы рулевой системы

G/L  D/R

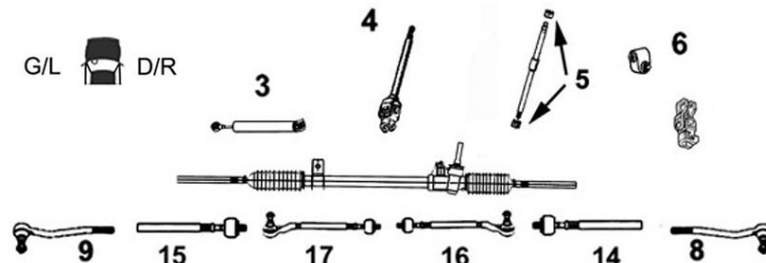

3008247

Axe de bielle G/D

Part/oe 4852000QAM

L/R axial joint



14 Côté dir. M12x1.0 Côté rot. M14x1.5 long 263 mm
15

TT /all models

... Primastar ...

NISSAN



<p>4006147 Rotule de direction G OE 4852000QAK <i>Left tie rod end</i></p>	<p>4006148 Rotule de direction D OE 4852000QAL <i>Right tie rod end</i></p>
<p>9</p>	<p>8</p>
<p>TT /all models</p>	<p>TT /all models</p>

Eléments SUSPENSION
Suspension parts
Elementos suspensión
Elementy zawieszenie
Элементы подвески

<p>2254008 Articulation AR Part/oe 5450200QAA <i>Rear bush</i></p>	<p>2254007 Articulation AV Part/oe 5450200QAA <i>Front bush</i></p>
<p>2</p>	<p>1</p>
<p>Ø int. 14 Ø ext. 58 long. tube int. 54 ext. 29</p> <p>1.9 DCi 2.0i 16v. 2.5 DCi</p>	<p>Ø int.18 Ø ext.55 long. tube int. 50 ext. 31</p> <p>1.9 DCi 2.0i 16v. 2.5 DCi</p>

Bras & Triangle de suspension
Control arm
Brazo y triángulo
Wahacz
Рычаг подвески

G/L D/R

2

1

4

3

<p>9005770 Triangle de susp. inf. G OE 5450300Q0B <i>Lower left track control arm</i></p>	<p>9005769 Triangle de susp. inf. D OE 5450200Q0B <i>Lower right track control arm</i></p>
<p>4</p>	<p>3</p>
<p>Avec rotule With ball joint</p> <p>TT /all models -10/06</p>	<p>Avec rotule With ball joint</p> <p>TT /all models -10/06</p>

<p>7474026 Triangle de susp. inf. G OE 5450300Q0C <i>Lower left track control arm</i></p>	<p>7474025 Triangle de susp. inf. D OE 5450200Q0C <i>Lower right track control arm</i></p>
<p>NEW</p> <p>4</p>	<p>NEW</p> <p>3</p>
<p>Avec rotule With ball joint</p> <p>2.0i 11/06- 2.0 DCi /FAP 11/06- 2.5 DCi /FAP 11/06-</p>	<p>Avec rotule With ball joint</p> <p>2.0i 11/06- 2.0 DCi /FAP 11/06- 2.5 DCi /FAP 11/06-</p>



NISSAN

... Primastar

Bras & Triangle de suspension

Control arm
Brazo y triángulo
Wahacz
Рычаг подвески

G/L  D/R



4005278

Rotule de susp. inf. G/D

Part/oe 5450200QAB *L/R lower suspension ball joint*



1
2

TT /all models

Adam



Support d'amortisseur
 Suspension mounting
 Soporte amortiguador
 Poduszka amortyzatora
 Опора амортизатора

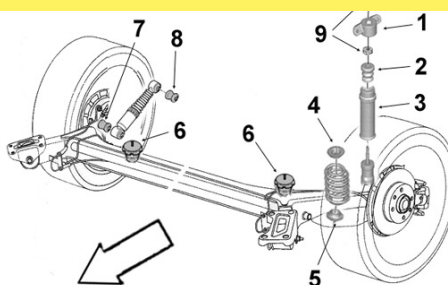

2656041
 OE 436773

Support suspension G
 Left suspension mounting



1

1.2 70hp 51kw Châssis standard 03/13-
 1.4 87hp 64kw 100hp 74kw
 Châssis standard 03/13-

2656040
 OE 436774

Support suspension D
 Right suspension mounting



1

1.2 70hp 51kw Châssis standard 03/13-
 1.4 87hp 64kw 100hp 74kw
 Châssis standard 03/13-

Agila ...

Eléments DIRECTION
 Steering parts
 Elementos Direcciones
 Elementy układ kierowniczy
 Элементы рулевой системы

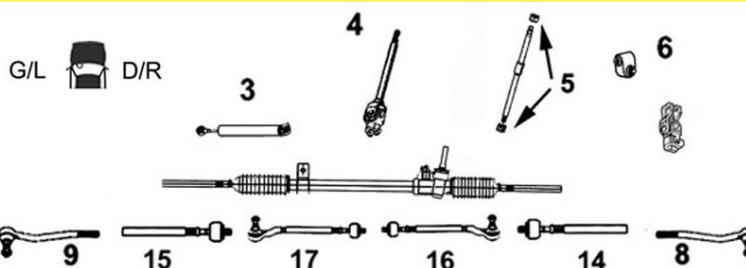

7776095
 OE 4709161

Axe de bielle G/D
 L/R axial joint

NEW



14 Côté dir. M18x1.5
 15 Côté rot. M12x1.25 long 306 mm

1.0i 16v. 03/08-
 1.2i 16v. 03/08-
 1.3 CDTi 03/08-

7676085
 OE 4709195

Rotule de direction G/D
 L/R tie rod end

NEW



8 M12x1.25
 9

1.0i 16v. 03/08-
 1.2i 16v. 03/08-
 1.3 CDTi 03/08-

Bras & Triangle de suspension

Control arm
 Brazo y triángulo
 Wahacz
 Рычаг подвески

G/L D/R

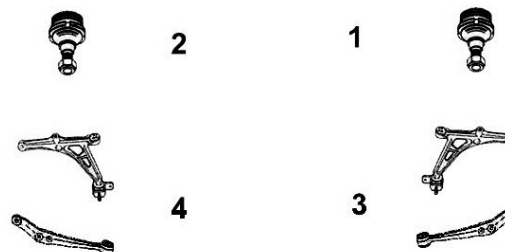

7476104
 OE 4708300

Triangle de susp. G
 Left track control arm

NEW



4 Avec rotule With ball joint Ø 16.5

1.0i K10B BVM 03/08-
 1.2i K12B BVM BVA 03/08-
 1.3 CDTi D13A BVM 03/08-

7476105
 OE 4708299

Triangle de susp. D
 Right track control arm

NEW



3 Avec rotule With ball joint Ø 16.5

1.0i K10B BVM 03/08-
 1.2i K12B BVM BVA 03/08-
 1.3 CDTi D13A BVM 03/08-

... Agila

Bras & Triangle de suspension

Control arm
Brazo y triángulo
Wahacz
Рычаг подвески

G/L  D/R

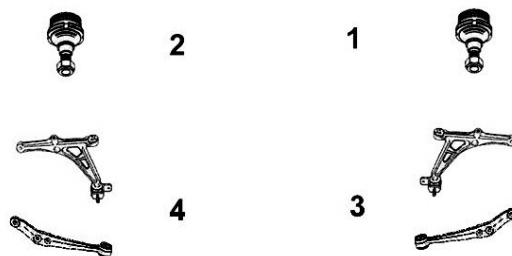

7476232

Bras de susp. AV inf. G/D

OE 4708233

L/R front lower track control arm

NEW

3
4 Ø15 Avec rotule With ball joint



1.0i
1.2i
1.3 CDTi

-ch 1G075421
-ch 1G075421
-ch 1G075421

-12/07
-12/07
-12/07

Ampera

Eléments DIRECTION

Steering parts
Elementos Direcciones
Elementy układ kierowniczy
Элементы рулевой системы

G/L  D/R

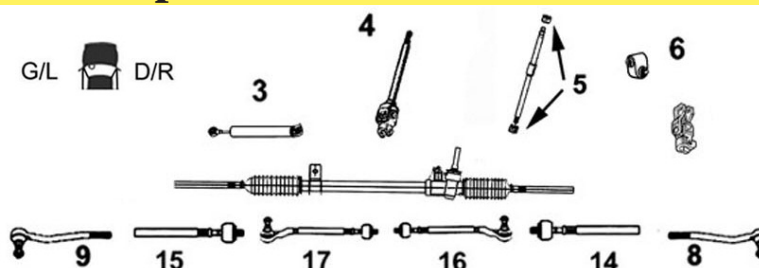

7776093

Axe de bielle G/D

OE 1609027

L/R axial joint

NEW

14 Côté dir. M16x1.5
15 Côté rot. M16x1.5 long 289 mm



1.4i Elect. 06/11-

7676069

Rotule de direction G/D

OE 1609026

L/R tie rod end

NEW

8
9 M16 x 1.5



1.4i Elect. 06/11-

Bras & Triangle de suspension

Control arm
Brazo y triángulo
Wahacz
Рычаг подвески

G/L  D/R



7476215

Triangle de susp. G

OE 352492

Left track control arm

NEW

4 Avec rotule With ball joint Ø 20



1.4i Elect. 06/11-

7476214

Triangle de susp. D

OE 352493

Right track control arm

NEW

3 Avec rotule With ball joint Ø 20



1.4i Elect. 06/11-

Antara

Bras & Triangle de suspension

Control arm
Brazo y triángulo
Wahacz
Рычаг подвески

G/L  D/R

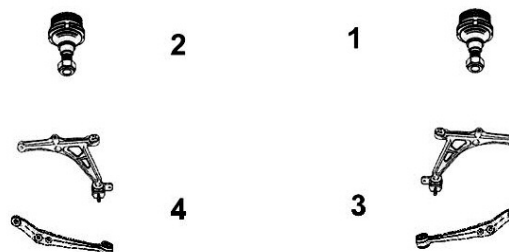

OPEL

SASIC

7476171

Triangle de susp. G

OE 4810831

Left track control arm

NEW



4	Avec rotule With ball joint			
2.0 CDTI	-ch 80999999 -ch 9B999999 -ch 93999999	Z20DM/H	05/06-	
	Ch AB000001-AB999999	Z20DM/H		
	Ch A3000001- A3999999	Z20DM/H		
2.0 VCDi /4WD	-ch 80999999 -ch 9B999999 -ch 93999999	Z20S	01/07-11/10	
	Ch AB000001-AB999999	Z20S		
	Ch A3000001- A3999999	Z20S		
2.2 CDTi /4WD	-ch 80999999 -ch 9B999999 -ch 93999999	Z22D1	01/11-	
	Ch AB000001-AB999999	Z22D1		
	Ch A3000001- A3999999	Z22D1		
2.4i /4WD	-ch 80999999 -ch 9B999999 -ch 93999999	Z24XED A24XF /E	05/06-	
	Ch AB000001-AB999999	Z24XED A24XF /E		
	Ch A3000001- A3999999	Z24XED A24XF /E		
3.0i 4WD	-ch 80999999 -ch 9B999999 -ch 93999999	A30XH A30XF	11/10-	
	Ch AB000001-AB999999	A30XH A30XF		
	Ch A3000001- A3999999	A30XH A30XF		
3.2i 4WD	-ch 80999999 -ch 9B999999 -ch 93999999	10HM	01/07-11/10	
	Ch AB000001-AB999999	10HM		
	Ch A3000001- A3999999	10HM		
3.2i Turbo V6 24v. 4WD	-ch 80999999 -ch 9B999999 -ch 93999999	Z32SE	01/07-11/10	
	Ch AB000001-AB999999	Z32SE		
	Ch A3000001- A3999999	Z32SE		

7476170

Triangle de susp. D

OE 4812870

Right track control arm

NEW



3	Avec rotule With ball joint			
2.0 CDTI	-ch 80999999 -ch 9B999999 -ch 93999999	Z20DM/H	05/06-	
	Ch AB000001-AB999999	Z20DM/H		
	Ch A3000001- A3999999	Z20DM/H		
2.0 VCDi /4WD	-ch 80999999 -ch 9B999999 -ch 93999999	Z20S	01/07-11/10	
	Ch AB000001-AB999999	Z20S		
	Ch A3000001- A3999999	Z20S		
2.2 CDTi /4WD	-ch 80999999 -ch 9B999999 -ch 93999999	Z22D1	01/11-	
	Ch AB000001-AB999999	Z22D1		
	Ch A3000001- A3999999	Z22D1		
2.4i /4WD	-ch 80999999 -ch 9B999999 -ch 93999999	Z24XED A24XF /E	05/06-	
	Ch AB000001-AB999999	Z24XED A24XF /E		
	Ch A3000001- A3999999	Z24XED A24XF /E		
3.0i 4WD	-ch 80999999 -ch 9B999999 -ch 93999999	A30XH A30XF	11/10-	
	Ch AB000001-AB999999	A30XH A30XF		
	Ch A3000001- A3999999	A30XH A30XF		
3.2i 4WD	-ch 80999999 -ch 9B999999 -ch 93999999	10HM	01/07-11/10	
	Ch AB000001-AB999999	10HM		
	Ch A3000001- A3999999	10HM		
3.2i Turbo V6 24v. 4WD	-ch 80999999 -ch 9B999999 -ch 93999999	Z32SE	01/07-11/10	
	Ch AB000001-AB999999	Z32SE		
	Ch A3000001- A3999999	Z32SE		

7576047

Rotule de susp. G/D

Part/oe 4812870

L/R suspension ball joint

NEW



1				
2	2.0 CDTI	-ch 80999999 -ch 9B999999 -ch 93999999	Z20DM/H	05/06-
		Ch AB/A3000001-AB/A3999999	Z20DM/H	
	2.0 VCDi /4WD	-ch 80999999 -ch 9B999999 -ch 93999999	Z20S	01/07-11/10
		Ch AB/A3000001-AB/A3999999	Z20S	
	2.2 CDTi /4WD	-ch 80999999 -ch 9B999999 -ch 93999999	Z22D1	01/11-
		Ch AB/A3000001-AB/A3999999	Z22D1	
	2.4i /4WD	-ch 80999999 -ch 9B999999 -ch 93999999	Z24XED A24XF/E	05/06-
		Ch AB/A3000001-AB/A3999999	Z24XED A24XF /E	
	3.0i 4WD	-ch 80999999 -ch 9B999999 -ch 93999999	A30XH A30XF	11/10-
		Ch AB/A3000001-AB/A3999999	A30XH A30XF	
	3.2i 4WD	-ch 80999999 -ch 9B999999 -ch 93999999	10HM	01/07-11/10
		Ch AB/A3000001-AB/A3999999	10HM	
	3.2i Turbo V6 24v. 4WD	-ch 80999999 -ch 9B999999 -ch 93999999	Z32SE	01/07-11/10
		Ch AB/A3000001-AB/A3999999	Z32SE	

Ascona C

Eléments DIRECTION

Steering parts

Elementos Direcciones

Elementy uklad kierowniczy

Элементы рулевой системы

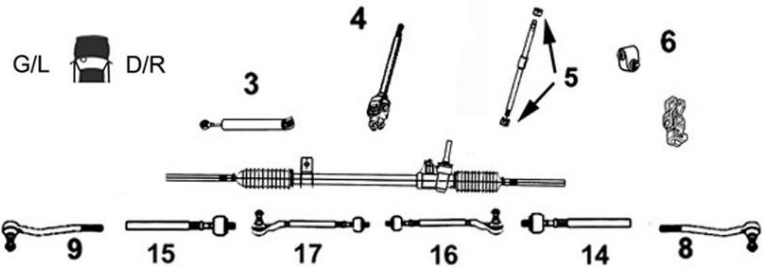

9006205

Axe de bielle D

OE 322126

Right axial joint



14 M16x1.5

TT /all models 08/81-10/88

9006372

Rotule de direction G

OE 324039

Left tie rod end



9 M16x1.5

TT /all models 08/81-10/88

9006373

Rotule de direction D

OE 324038

Right tie rod end



8 M16x1.5

TT /all models 08/81-10/88

Bras & Triangle de suspension

Control arm

Brazo y triángulo

Wahacz

Рычаг подвески

G/L D/R

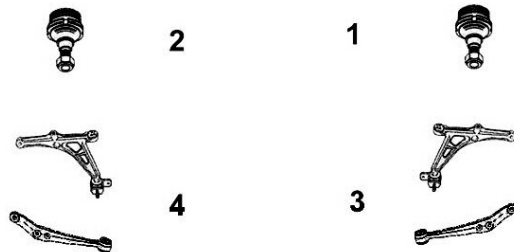

9005250

Rotule de susp. inf. G/D

OE 1603121

L/R lower suspension ball joint



1

TT /all models

08/81-10/88

Astra F...

Eléments DIRECTION

Steering parts

Elementos Direcciones





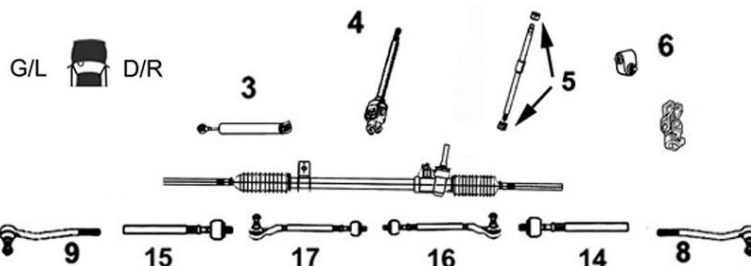



Elementy układ kierowniczy

Элементы рулевой системы

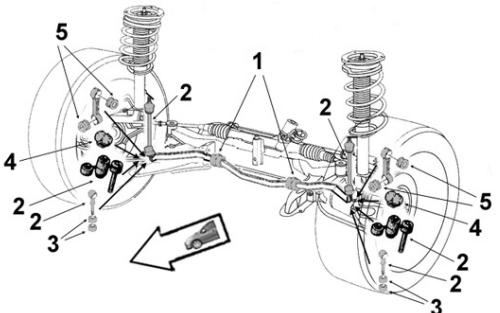

OPEL

SASIC

9006204 OE 322147	Axe de bielle G <i>Left axial joint</i>	9006203 OE 322146	Axe de bielle D <i>Right axial joint</i>
	15 M16x1.5 TT /all models 09/91-12/97		14 M16x1.5 TT /all models 09/91-12/97
9006370 OE 324055	Rotule de direction G <i>Left tie rod end</i>	9006371 OE 324056	Rotule de direction D <i>Right tie rod end</i>
	9 M16x1.5 TT /all models 09/91-12/97		8 M16x1.5 TT /all models 09/91-12/97
 <p>Barre stabilisatrice <i>Stabilizer bar</i> <i>Barra estabilizadora</i> <i>Drażek stabilizatora</i> стабилизатор поперечной устойчивости</p>			
9001512 OE 350261	Biellette barre stab. <i>Stabilizer bar stub axle</i>	9005077 OE 350263	Biellette barre stab. <i>Stabilizer bar stub axle</i>
	2 Barre Ø 18 1.4i /Break 09/91-04/98 1.4i 16v. 09/91-04/98 1.6i /16v. /Break 09/91-04/98 1.7 D TD 09/91-04/98 1.8i 09/91-04/98 1.8i 16v. /Break 09/91-04/98 2.0i 09/91-04/98 2.0i 16v. 09/91-04/98		2 Barre Ø 20 1.4i /Break 09/91-04/98 1.4i 16v. /Break 09/91-04/98 1.6i /16v. /Break 09/91-04/98 1.7 D TD /Break 09/91-04/98 1.8i 09/91-04/98 1.8i 16v. 09/91-04/98 2.0i 09/91-04/98 2.0i 16v. /Break 09/91-04/98
9001510 OE 350260	Biellette barre stab. <i>Stabilizer bar stub axle</i>	9001529 OE 350153	Liaison élastique <i>Elastic link</i>
	2 Barre Ø 22 1.4i /Break 09/91-04/98 1.4i 16v. 09/91-04/98 1.6i /16v. /Break 09/91-04/98 1.7 D TD /Break 09/91-04/98 1.8i 09/91-04/98 1.8i 16v. /Break 09/91-04/98 2.0i 09/91-04/98 2.0i 16v. /Break 09/91-04/98		3 Ø int.8.5 Ø ext.30 long. tube int.19.5 ext.17 1.4i 09/91-04/98 1.6i /16v. 09/91-04/98 1.7 D TD 09/91-04/98 1.8i 09/91-04/98 1.8i 16v. 09/91-04/98 2.0i 09/91-04/98 2.0i 16v. 09/91-04/98

...Astra F...

SASIC

OPEL



Barre stabilisatrice
 Stabilizer bar
 Barra estabilizadora
 Drażek stabilizatora
 стабилизатор поперечной устойчивости

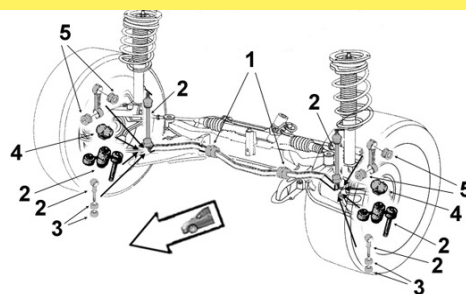

9001533

Palier de barre

OE 350081

Bar main bearing

1 Barre Ø 18



1.4i /Break	09/91-04/98
1.6i /Break	09/91-04/98
1.6i 16v. /Break	09/91-04/98
1.7 D	09/91-04/98
1.8i 16v. /Break	09/91-04/98

9001659

Palier de barre milieu

OE 350078

Middle bar main bearing

1 Barre Ø 22



1.4i /Break	09/91-04/98
1.6i 16v. /Break	09/91-04/98
1.6i /Break	09/91-04/98
1.7 D	09/91-04/98
1.7 TD /Break	09/91-04/98
1.8i 16v. /Break	09/91-04/98
2.0i 16v. /Break	09/91-04/98

1005070

Kit rép. barre stab. G et D

OE -

L R Stabilizing bar repair kit



Barre Ø 22 Bar Ø22

TT /all models

09/91-04/98



Eléments SUSPENSION

Suspension parts
Elementos suspensión
Elementy zawieszenie
Элементы подвески

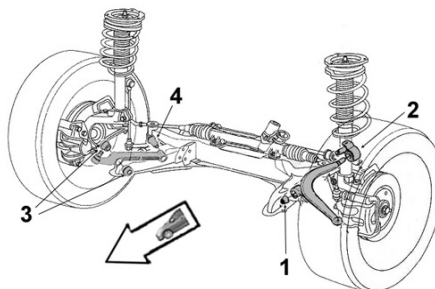

9001513

Articulation AV

OE 352300

Front bush



1 Ø int.12 Ø ext.38 coll.43 long. tube int.59 ext.30 ep. coll.7

1.4i	-ch P8146889	
1.4i 16v. / Break		
1.4i /Break	-ch P2603822	
1.6i /16v.	-ch P8146889	
1.6i /16v. / Break	-ch P2603822	
1.7 D/TD	-ch P2603822	-ch P8146889
1.7 TD Break	-ch P2603822	
1.8i /16v.	-ch P2603822	-ch P8146889
1.8i 16v. Break		
2.0i /16v.	-ch P8146889	
2.0i /16v./ Break	-ch P2603822	

9001643

Articulation AV

OE 352351

Front bush







1 Ø int.12 Ø ext.39.5 coll.44 long. tube int.59.5 ext.28 ep. coll.7

1.4i	Ch P2603823-R2587415	Ch P8146890-R8145949	Ch R2587415-R5111734
1.4i Break	Ch P2603823-R2587415	Ch R2587415-R5111734	
1.6i Break	Ch P2603823-R2587415	Ch R2587415-R5111734	
1.6i /16v.	Ch P2603823-R2587415	Ch P8146890-R8145949	Ch R2587415-R5111734
1.6i 16v. Break	Ch P2603823-R2587415	Ch R2587415-R5111734	
1.7 D/TD	Ch P2603823-R2587415	Ch P8146890-R8145949	Ch R2587415-R5111734
1.7 TD Break	Ch P2603823-R2587415	Ch R2587415-R5111734	
1.8i /16v.	Ch P2603823-R2587415	Ch P8146890-R8145949	Ch R2587415-R5111734
2.0i	Ch P2603823-R2587415	Ch P8146890-R8145949	Ch-R2587415-R5111734
2.0i 16v.	Ch P2603823-R2587415	Ch P8146890-R8145949	Ch R2587415-R5111734
2.0i 16v. Break	Ch P2603823-R2587415	Ch R2587415-R5111734	

...Astra F...

OPEL



9001765 Articulation AV						
<i>Front bush</i>						
	1	Ø int.12 Ø ext.38 coll.43 x2 long. tube int.59.5 ext.28 ep. coll.7x2				
		1.4i /Break	Ch R2587416-R5111735	Ch R5111735-R8145950		
		1.6i /Break	Ch R2587416-R5111735	Ch R5111735-R8145950		
		1.6i 16v. /Break	Ch R2587416-R5111735	Ch R5111735-R8145950		
		1.7 D	Ch R2587416-R5111735	Ch R5111735-R8145950		
		1.7 TD /Break	Ch R2587416-R5111735	Ch R5111735-R8145950		
		1.8i /16v.	Ch R2587416-R5111735	Ch R5111735-R8145950		
		2.0i /16v. /Break	Ch R2587416-R5111735	Ch R5111735-R8145950		
		9001516 Articulation AR				
		<i>Rear bush</i>				
	2	Ø int.16 Ø ext.60 coll.66.5 long. tube int.58 ext.24 ep. coll.3				
		1.4i	-ch P2603822	-ch P8146889		
		1.4i Break	-ch P2603822			
		1.6i Break	-ch P2603822			
		1.6i /16v.	-ch P2603822	-ch P8146889		
		1.6i 16v. Break	-ch P2603822			
		1.7 D/TD	-ch P2603822	-ch P8146889		
		1.7 TD Break	-ch P2603822			
		1.8i Break	-ch P2603822			
		1.8i /16v.	-ch P2603822	-ch P8146889		
2.0i /16v.	-ch P2603822	-ch P8146889				
2.0i 16v. Break						
9001652 Articulation AR						
<i>Rear bush</i>						
	2	Ø int.16 Ø ext.60 coll.67 long. tube int.58 ext.24 ep. coll.3				
		1.4 / Break	Ch P2603823-R2587415			
		1.6i /16v.	Ch P2603823-R2587415			
		1.6i 16v. Break	Ch P2603823-R2587415			
		1.6i Break	Ch P2603823-R2587415			
		1.7 TD	Ch P2603823-R2587415			
		1.7 TD /Break	Ch P2603823-R2587415			
9001638 Articulation AR						
<i>Rear bush</i>						
	2	Ø int.12 Ø ext.47.5 coll.61 long. tube int.60 ext.44 ep. coll.9				
		1.4i	Ch P2603823-R2587415	Ch P8146890-R8145949	Ch R2587415-R5111734	
		1.6i /16v.	Ch P2603823-R2587415	Ch P8146890-R8145949	Ch R2587415-R5111734	
		1.7 D	Ch P2603823-R2587415	Ch P8146890-R8145949	Ch R2587415-R5111734	
		1.7 TD	Ch P2603823-R2587415	Ch P8146890-R8145949	Ch R2587415-R5111734	
		1.8i /16v.	Ch P2603823-R2587415	Ch P8146890-R8145949	Ch R2587415-R5111734	
		2.0i	Ch P2603823-R2587415	Ch P8146890-R8145949	Ch R2587415-R5111734	
		2.0i 16v.	Ch- P2603823-R2587415	Ch P8146890-R8145949	Ch R2587415-R5111734	
		9001648 Articulation AR				
		<i>Rear bush</i>				
	2	Ø int.16 Ø ext.60 coll.67.5 long. tube int.58 ext.24 ep. coll.3				
		1.4i	Ch R2587416-R5111735	Ch R5111735-R8145950		
		1.4i 16v. /Break				
		1.4i Break	Ch R2587416-R5111735	Ch R5111735-R8145950		
		1.6i / Break	Ch R2587416-R5111735	Ch R5111735-R8145950		
		1.6i 16v. / Break	Ch R2587416-R5111735	Ch R5111735-R8145950		
		1.7 D	Ch R2587416-R5111735	Ch R5111735-R8145950		
		1.7 TD /Break	Ch R2587416-R5111735	Ch R5111735-R8145950		
		1.8i /16v.	Ch R2587416-R5111735	Ch R5111735-R8145950		
		2.0i /16v.	Ch R2587416-R5111735	Ch R5111735-R8145950		
2.0i 16v. Break	Ch R2587416-R5111735	Ch R5111735-R8145950				

... Astra F ...

SASIC

OPEL

Bras & Triangle de suspension

Control arm
Brazo y triángulo
Wahacz
Рычаг подвески

G/L  D/R

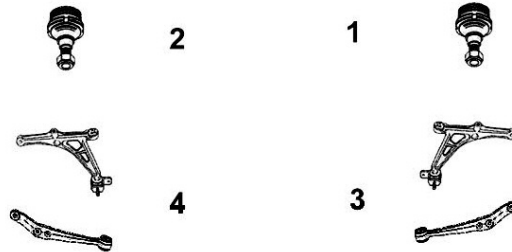

9005189

OE 352077

Triangle de susp. G

Left track control arm



4 Avec rotule With ball joint

1.4	-ch R2588487-ch 5111734	Ch R2588488-6036588	-ch R6036587-8145949	09/91-12/97
1.4i 16v.				09/91-12/97
1.6i	-ch R2588487-ch 5111734	Ch R2588488-6036588	-ch R6036587-8145949	09/91-12/97
1.7 D	-ch R2588487-ch 5111734	Ch R2588488-6036588	-ch R6036587-8145949	09/91-12/97
1.7 TD	-ch R2588487-ch 5111734	Ch R2588488-6036588	-ch R6036587-8145949	09/91-12/97
1.8i 16v.		Ch R2588488-6036588		07/93-06/94
2.0i		Ch R2588488-6036588		09/91-12/97
2.0i Sauf 2.0 XE Break GSi	-ch R2588487-ch 5111734		-ch R6036587-8145949	09/91-12/97

9005188

OE 352076

Triangle de susp. D

Right track control arm



3 Avec rotule With ball joint

1.4	-ch R2588487-ch 5111734	Ch R2588488-6036588	-ch R6036587-8145949	09/91-12/97
1.4i 16v.				09/91-12/97
1.6i	-ch R2588487-ch 5111734	Ch R2588488-6036588	-ch R6036587-8145949	09/91-12/97
1.7 D	-ch R2588487-ch 5111734	Ch R2588488-6036588	-ch R6036587-8145949	09/91-12/97
1.7 TD	-ch R2588487-ch 5111734	Ch R2588488-6036588	-ch R6036587-8145949	09/91-12/97
1.8i 16v.		Ch R2588488-6036588		07/93-06/94
2.0i		Ch R2588488-6036588		09/91-12/97
2.0i Sauf 2.0 XE Break GSi	-ch R2588487-ch 5111734		-ch R6036587-8145949	09/91-12/97

9005250

OE 1603121

Rotule de susp. inf. G/D

L/R lower suspension ball joint



1
2

TT /all models

09/91-12/97



Support d'amortisseur

Suspension mounting
Soporte amortiguador
Poduszka amortyzatora
Опора амортизатора

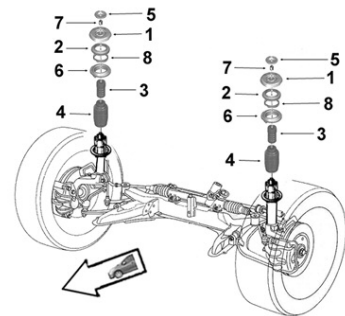

9005609

OE 344531

Support suspension G/D

L/R suspension mounting



1

1.4i / 16v. /Break	09/91-04/98
1.6i / 16v. /Break	09/91-04/98
1.7 D	09/91-04/98
1.7 TD /Break	09/91-04/98
1.8i	09/91-04/98
1.8i 16v. /Break	09/91-04/98
2.0i	09/91-04/98
2.0i 16v. /Break	09/91-04/98

8005207

OE 344524

Butée à billes G/D



L/R ball bearing



2

1.4i / 16v. /Break	-03/98
1.6i / 16v.	-03/98
1.7 D	-03/98
1.7 TD /Break	-03/98
1.8i / 16v.	-03/98
2.0i / 16v. /Break	-03/98

... Astra F

9005356 OE 344401	Butée de suspension G/D <i>L/R suspension bush</i>	9005357 OE 344402	Butée de suspension G/D <i>L/R suspension bush</i>
	3 1.4i /16v. /Break 09/91-04/98 1.6i /16v. /Break 09/91-04/98 1.7 D TD /Break 09/91-04/98 1.8i/16v. 09/91-04/98 2.0i/16v./Break sauf GSi 09/91-04/98		3 2.0i 16v. GSi -09/98

Eléments TRAIN ARRIERE



Rear axle parts

Tren TRAS

Elementy zawieszenia tylnego

элементы задней оси.



9001656 OE 402647	Articulation essieu AR <i>Rear axle bush</i>	9001655 OE 402645	Articulation essieu AR <i>Rear axle bush</i>
	Ø int.12 Ø ext.59 coll.66 long. tube int.75 ext.62 ep. coll.8 1.4/i 16v. 09/91-04/98 1.6i/16v. 09/91-04/98 1.7 D TD 09/91-04/98 1.8i 16v. C18XE 07/93-06/94 2.0i/16v./GSi 16v. 09/91-04/98		Ø int.12 Ø ext.59 coll.65.5 long. tube int.75 ext.62 ep. coll.7 1.4i/16v. Break 09/91-04/98 1.6i/16v. Break 09/91-04/98 1.7 TD Break 09/91-04/98 1.8i 09/91-04/98 1.8i 16v. Break X18 09/91-04/98 2.0i 16v. Break X20XE 09/91-04/98

Astra G ...

Eléments DIRECTION



Steering parts

Elementos Direcciones

Elementy układ kierowniczy

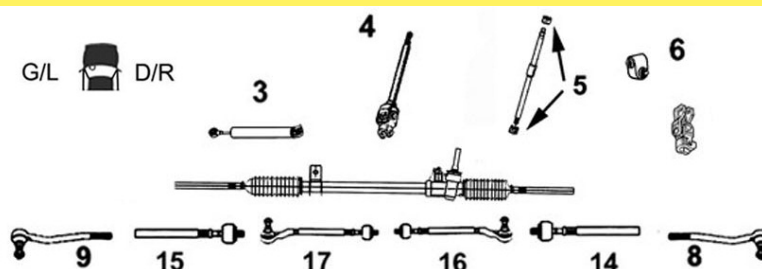
Элементы рулевой системы



9006855 Part/oe 1603216	Axe de bielle G/D <i>L/R axial joint</i>
	14 Côté dir. M18x1.5 Côté rot. M14x1.5 long 285 mm 1.4i 16v. 1.6i /16v. 1.7 CDTi DTi TD 1.8i 16v. 2.0i 16v. sauf OPC 2.0 Di DTi 16v. 2.2i 16v. 2.2 DTi
9006691 OE 1603215	Rotule de direction G/D <i>L/R tie rod end</i>
	8 M14x1.5 9 1.4i 16v. 1.6i /16v. 1.7 CDTi DTi TD 1.8i 16v. 2.0i 16v. /OPC/Turbo 2.0 Di 16v. DTi 16v. 2.2i 16v. 2.2 DTi

... Astra G ...

SASIC

OPEL



Barre stabilisatrice
 Stabilizer bar
 Barra estabilizadora
 Drażek stabilizatora
 стабилизатор поперечной устойчивости

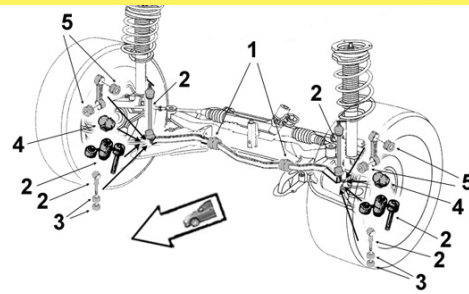

9005016

Biellette barre stab.

OE 350614

Stabilizer bar stub axle



2	1.4i 16v.	04/98-
	1.6i/16v.	04/98-
	1.7 CDTi	
	1.7 DTi TD	04/98-
	1.8i 16v.	04/98-
	2.0i 16v.	04/98-
	2.0i 16v. GSi	
	2.0i 16v. Turbo	04/02-
	2.0 Di DTi 16v.	04/98-
	2.2i 16v.	02/01-
2.2 DTi	07/02-	

9001784

Palier de barre milieu

OE 350138

Middle bar main bearing



1	Barre Ø 22	
	1.4i 16v.	04/98-
	1.6i/16v.	04/98-
	1.7 CDTi	11/02-
	1.7 DTi TD	04/98-
	1.8i 16v.	04/98-
	2.0i 16v.	04/98-
	2.0i 16v. Turbo	
	2.0 Di 16v. DTi 16v.	04/98-
	2.2i 16v.	08/00-
2.2 DTi	04/98-	

2306093

Palier de barre milieu

OE 350117

Middle bar main bearing



1	Barre Ø 20	
	1.6i 16v. Cab.	02/01-10/05
	1.8i 16v. Cab.	01/03-10/05
	2.0i 16v. Turbo Cab.	01/02-10/05
	2.2i 16v. Cab.	02/01-10/05
	2.2 DTi Cab.	08/02-10/05



Eléments SUSPENSION

Suspension parts
Elementos suspensión
Elementy zawieszenie
Элементы подвески

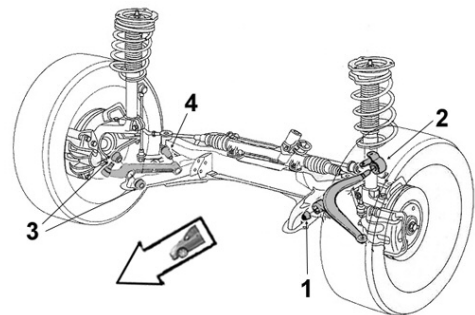

9001649

Articulation AV

OE 352364

Front bush



1	Ø int.12 Ø ext.36 coll.42.5	
	long. tube int.59.5 ext.34 ep. coll.8	
	1.4i 16v. /Break	04/98-
	1.6i /Break	04/98-
	1.6i 16v. /Break	04/98-
	1.7 CDTi /Break	11/02-
	1.7 DTi /Break	04/98-
	1.7 TD /Break	04/98-
	1.8i 16v. /Break	04/98-
	2.0i 16v./Break. sauf OPC	04/98-
	2.0 Di 16v. /Break	04/98-
	2.0 DTi 16v. /Break	04/98-
	2.2i 16v. /Break	
	2.2 DTi /Break	04/98-

9001640

Articulation AR

OE 352365

Rear bush



2	Ø int.12 Ø ext.47.5 coll.61	
	long. tube int.60 ext.44 ep. coll.9	
	1.4i 16v. /Break	04/98-
	1.6i /Break	04/98-
	1.6i 16v. /Break	04/98-
	1.7 CDTi /Break	11/02-
	1.7 DTi /Break	04/98-
	1.7 TD /Break	04/98-
	1.8i 16v. /Break	04/98-
	2.0i 16v. /Break sauf OPC	04/98-
	2.0 Di 16v. /Break	04/98-
	2.0 DTi 16v. /Break	04/98-
	2.2i 16v. /Break	
	2.2 DTi /Break	04/98-

... Astra G ...

Bras & Triangle de suspension

Control arm
Brazo y triángulo
Wahacz
Рычаг подвески

G/L  D/R

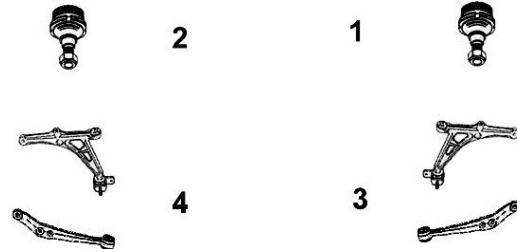

9005192
OE 5352016

Triangle de susp. G
Left track control arm



4 Avec rotule With ball joint
1.4i 16v. /Break
1.6i /16v. /Break
1.7 CDTi DTi TD /Break
1.8i 16v. /Break
2.0i 16v. /Break sauf OPC
2.0 Di DTi 16v. /Break
2.2i 16v. /Break
2.2 DTi /Break

9005193
OE 5352017

Triangle de susp. D
Right track control arm



3 Avec rotule With ball joint
1.4i 16v. /Break
1.6i /16v. /Break
1.7 CDTi DTi TD /Break
1.8i 16v. /Break
2.0i 16v. /Break sauf OPC
2.0 Di DTi 16v. /Break
2.2i 16v. /Break
2.2 DTi /Break

9005189
OE 352128

Triangle de susp. G
Left track control arm



4 Avec rotule With ball joint

2.0i 16v. Break
F35 C20XE X20XEV

9005188
OE 352127

Triangle de susp. D
Right track control arm



3 Avec rotule With ball joint

2.0i 16v. Break
F35 C20XE X20XEV

9005256
OE 352830

Rotule de susp. inf. G/D
L/R lower suspension ball joint



1
2 1.4i 16v.
1.6i /16v.
1.7 CDTi DTi TD
1.8i 16v.
2.0i 16v. /Turbo
2.0 Di DTi 16v.
2.2i 16v.
2.2 DTi



Support d'amortisseur
Suspension mounting
Soporte amortiguador
Poduszka amortyzatora
Опора амортизатора

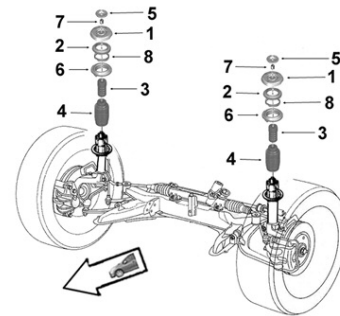

2656012
OE 344523

Support suspension
Suspension mounting



1 Sans joint incorporé Without built attached
1.4i 16v. /Break 04/98-
1.6i /16v. /Break 04/98-
1.7 DTi 16v. /Break 01/00-
1.7 TD /Break 04/98-
1.8i 16v. /Break 07/98-
2.0i 16v. /Break 04/98-
2.0i 16v. Turbo /Break 08/00-
2.0 Di DTi 16v. /Break 04/98-
2.2i 16v. /Break 05/00-

9001688
OE 344525

Support suspension G/D
L/R suspension mounting



1 Avec joint incorporé With built attached
1.4i 16v. /Break 04/98-
1.6i /16v. /Break 04/98-
1.7 DTi TD /Break 04/98-
1.8i 16v. /Break 04/98-
2.0i 16v. /Turbo /Break 04/98-
2.0 Di DTi 16v. /Break 04/98-
2.2i 16v. /Break
2.2 DTi /Break 04/98-

... Astra G

SASIC



Support d'amortisseur
Suspension mounting
Soporte amortiguador
Poduszka amortyzatora
Опора амортизатора

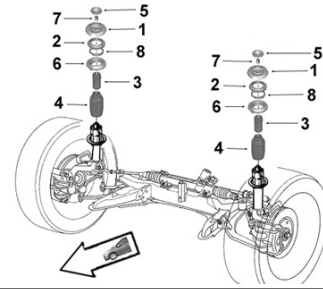

2656063

OE 0312510

Butée à billes G/D

L/R ball bearing

NEW

2



TT /all models

2656014

OE 344421

Butée de suspension

Shock bush



3

H53

1.4i 16v. /Break	07/98-
1.6i /16v. /Break /Cab.	04/98-
1.7 CDTi /Break	04/03-
1.7 DTi 16v. /Break	01/00-
1.7 TD /Break	04/98-
1.8i 16v. /Coupé Cab.	07/98-
2.0i 16v.	04/98-
2.0i 16v. Turbo/Coupé Cab.	08/00-
2.0 Di 16v. /Break	02/98-
2.0 DTi 16v. /Break	04/98-
2.2i 16v.	05/00-
2.2 DTi	07/02-

9005360

OE 344417

Butée de suspension

Shock bush



3

H63

1.4i 16v.	04/98-
1.6i/16v.	04/98-
1.7 CDTi	11/02-
1.7 DTi TD	04/98-
1.8i 16v.	04/98-
2.0i 16v.	04/98-
2.0i 16v. Turbo	
2.0 Di 16v.	04/98-
2.0 DTi 16v.	04/98-
2.2i 16v.	
2.2 DTi	04/98-

Astra H ...

Eléments DIRECTION

Steering parts

Elementos Direcciones

Elementy układu kierowniczy

Элементы рулевой системы

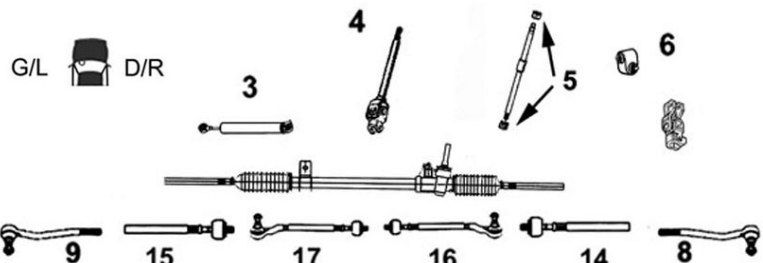

7776034

OE 1603357

Axe de bielle G/D

L/R axial joint



14

ZF Côté dir. M16x1.5

15

Côté rot. M14x1.5 long 280 mm

1.3 CDTi /Break	
1.4i 16v. /Break	
1.6i 16v. /Break /Cab.	
1.7 CDTi /Break	
1.8i 16v. /Break /Cab.	
1.9 CDTi /Break /Cab.	
2.0i 16v. Turbo /Break /Cab.	

7776042

OE 1603358

Axe de bielle G/D

L/R axial joint



14

ZF Côté dir. M16x1.5

15

Côté rot. M14x1.5 long 277 mm









Châssis sport jante 15 /16 /17 Pouces

1.3 CDTi /Break	
1.4i 16v. /Break /Cab.	
1.6i 16v. /Break /Cab.	
1.6i Turbo /Cab.	
1.7 CDTi /Break	
1.8i 16v. /Break /Cab.s	
1.9 CDTi /Break /Cab.	
2.0i 16v. Turbo /Break /Cab.	
2.0i 16v. Turbo OPCs	

... Astra H ...

OPEL



7776060 OE 1603359	Axe de bielle G/D <i>L/R axial joint</i>	9006855 Part/oe 1603643	Axe de bielle G/D <i>L/R axial joint</i>
	<p>NEW</p> <p>14 Côté dir. M16x1.5 15 Côté rot. M14x1.5 long 279 mm</p> <p>Châssis sport jante 18/19 Pouces</p> <p>1.3 CDTi /GTC /Break 04/05- 1.3 CDTi Van 08/05- 1.4i 16v. /Break GPL 08/09- 1.4i 16v. /GTC /Break 03/04- 1.6 Turbo /GTC /Break 02/07- 1.6i /GTC /Break /GPL 03/04- 1.6i Turbo Twintop 02/07- 1.6i Twintop 09/05- 1.7 CDTi /GTC /Break 03/04- 1.8 Twintop 09/05- 1.8i /GTC /Break 03/04- 1.9 CDTi/16v./GTC/Break 09/04- 1.9 CDTi /FAP Twintop 09/05- 2.0 Turbo /GTC /Break 08/04- 2.0 Turbo Twintop 09/05-</p>		<p>14 Côté dir. M18x1.5 15 Côté rot. M14x1.5 long 285 mm</p> <p>1.3 CDTi /Break 1.4i 16v. /Break 1.6i 16v. /Break /Cab. 1.6i Turbo /Cab. 1.7 CDTi /Break 1.8i 16v. /Break /Cab. 1.9 CDTi /Break /Cab. 2.0i 16v. Turbo /Break /Cab.</p>
9006564 OE 1603289	Rotule de direction G <i>Left tie rod end</i>	9006563 OE 1603288	Rotule de direction D <i>Right tie rod end</i>
	<p>9 M14 x 1.5</p> <p>1.3 CDTi /Break 1.4i 16v. /Break 1.6i 16v. /Break /Cab. 1.6 Turbo /Cab. 1.7 CDTi /Break 1.8i 16v. /Break /Cab. 1.9 CDTi /Break /Cab. 2.0i 16v. Turbo /OPC /Break /Cab.</p>		<p>8 M14 x 1.5</p> <p>1.3 CDTi /Break 1.4i 16v. /Break 1.6i 16v. /Break /Cab. 1.6 Turbo /Cab. 1.7 CDTi /Break 1.8i 16v. /Break / Cab. 1.9 CDTi /Break / Cab. 2.0i 16v. Turbo /OPC /Break /Cab.</p>
<div style="display: flex; justify-content: space-between;"> <div data-bbox="247 1231 371 1289"> </div> <div data-bbox="256 1301 718 1464"> <p>Barre stabilisatrice Stabilizer bar Barra estabilizadora Drażek stabilizatora стабилизатор поперечной устойчивости</p> </div> <div data-bbox="908 1173 1404 1487"> </div> </div>			
9005016 OE 350614	Biellette barre stab. <i>Stabilizer bar stub axle</i>	2306051 OE 350613	Biellette barre stab. <i>Stabilizer bar stub axle</i>
	<p>2 Sans ids</p> <p>1.3 CDTi 1.4i 16v. 1.6i 16v. 1.7 CDTi 1.8i 16v. 1.9 CDTi 2.0i 16v. Turbo</p>		<p>2 Système ids</p> <p>1.3 CDTi 02/05-12/06 1.4i 16v. 02/05-12/06 1.6i 16v. 04/04- 1.6i Turbo 01/07- 1.7 CDTi 08/04- 1.8i 16v. 04/04- 1.9 CDTi 08/04- 2.0i 16v. Turbo 04/04-</p>
2306093 OE 350117	Palier de barre milieu <i>Middle bar main bearing</i>	2306094 OE 350161	Palier de barre milieu <i>Middle bar main bearing</i>
	<p>1 Barre Ø 20 -ch5599999 -ch52999999 -ch58999999</p> <p>1.3 CDTi Break 09/05- 1.4i 16v. Break 09/04- 1.6i 16v. Break 09/04- 1.7 CDTi Break 09/04- 1.8i 16v. Break 09/04- 1.9 CDTi Break 12/05- 2.0i 16v. Turbo Break 09/04-</p>		<p>1 Barre Ø 21 -ch5599999 -ch52999999 -ch58999999</p> <p>1.3 CDTi Berline 02/05- 1.4i 16v. Berline/Break 04/04- 1.6i 16v. Berline/Break 04/04- 1.7 CDTi Berline/Break 04/04- 1.8i 16v. Berline/Break 04/04- 1.9 CDTi Berline/Break 08/04- 2.0i 16v. Turbo Berline/Break 04/04- 2.0i 16v. Turbo OPC Berline 09/05-</p>

... Astra H ...



Barre stabilisatrice
Stabilizer bar
Barra estabilizadora
Drażek stabilizatora
 стабилизатор поперечной устойчивости

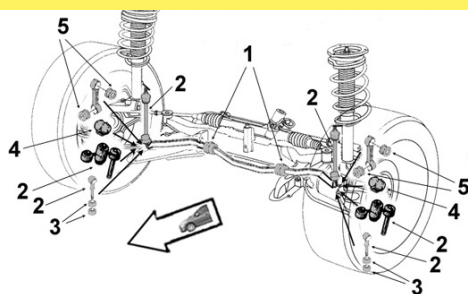

2306099

Palier de barre milieu sup.

OE 350204

Upper middle bar main bearing



1 Barre Ø 22
Ch-6200001 Ch-6500001 Ch-6800001
 1.3 CDTi 02/05-
 1.4i 16v. Berline/Break 04/04-
 1.6i 16v. Berline/Break 04/04-
 1.7 CDTi Berline/Break 04/04-
 1.8i 16v. Berline/Break 04/04-
 1.9 CDTi Berline/Break 08/04-
 2.0i 16v. Turbo Berline/Break 04/04-
 2.0i 16v. Turbo OPC Berline 09/05-

2306098

Palier de barre milieu inf.

OE 350205

Lower middle bar main bearing

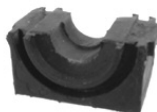

1 Barre Ø 22
Ch-6200001 Ch-6500001 Ch-6800001
 1.3 CDTi 02/05-
 1.4i 16v. Berline/Break 04/04-
 1.6i 16v. Berline/Break 04/04-
 1.7 CDTi Berline/Break 04/04-
 1.8i 16v. Berline/Break 04/04-
 1.9 CDTi Berline/Break 08/04-
 2.0i 16v. Turbo Berline/Break 04/04-
 2.0i 16v. Turbo OPC Berline 09/05-



Eléments SUSPENSION
Suspension parts
Elementos suspensión
Elementy zawieszenia
 Элементы подвески

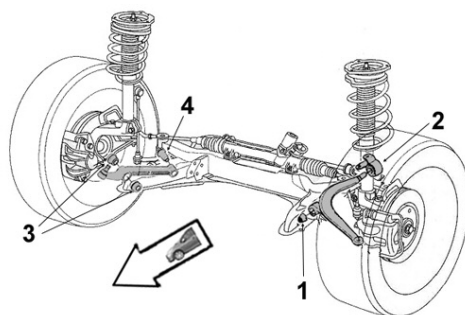

9001649

Articulation AV

OE 352364

Front bush



1 Ø int.12 Ø ext.36 coll.42.5 long. tube int.59.5 ext.34 ep. coll.8
 1.3 CDTi
 1.4i 16v.
 1.6i 16v.
 1.7 CDTi
 1.8i 16v.
 1.9 CDTi
 2.0i 16v. Turbo

Bras & Triangle de suspension

G/L D/R

Control arm
Brazo y triángulo
Wahacz
 Рычаг подвески

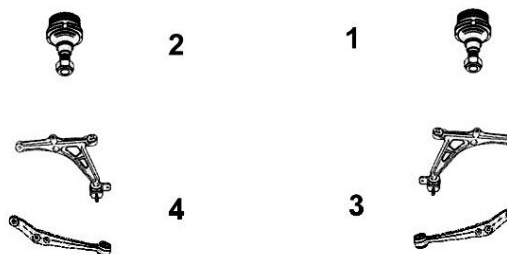

7476072

Triangle de susp. G

OE 5352029

Left track control arm



4 Avec rotule With ball joint
 1.3 CDTi /Break
 1.4i 16v. /Break
 1.6i 16v. /Break /Cab.
 1.6i Turbo /Break /Cab.
 1.7 CDTi /Break
 1.8i 16v. /Break /Cab.
 1.9 CDTi /Break /Cab.
 2.0i 16v. Turbo /Break /Cab.

7476071

Triangle de susp. D

OE 5352030

Right track control arm



3 Avec rotule With ball joint
 1.3 CDTi /Break
 1.4i 16v. /Break
 1.6i 16v. /Break /Cab.
 1.6i Turbo /Break /Cab.
 1.7 CDTi /Break
 1.8i 16v. /Break /Cab.
 1.9 CDTi /Break /Cab.
 2.0i 16v. Turbo /Break /Cab.

... Astra H

OPEL



9005256

Rotule de susp. inf. G/D

OE 352830

L/R lower suspension ball joint



- 1** 1.3 CDTi
- 2** 1.4i 16v.
- 1.6i 16v./Turbo
- 1.7 CDTi
- 1.8i 16v.
- 1.9 CDTi
- 2.0i 16v. /Turbo



Support d'amortisseur

*Suspension mounting
Soporte amortiguador
Poduszka amortyzatora
Опора амортизатора*

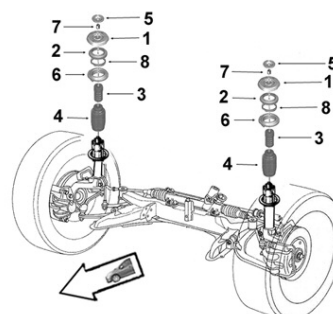

2656021

Support suspension

OE 344544

Suspension mounting



- 1** 1.3 CDTi Break
- 1.4i 16v. Break
- 1.6i 16v. Break
- 1.6i Turbo Break
- 1.7 CDTi Break
- 1.8i 16v. /Break
- 1.9 CDTi /Break
- 2.0i 16v. Turbo /Break

2656017

Butée de suspension

OE 344956

Shock bush



- 3 H40**
- 1.3 CDTi /Break
- 1.4i 16v. /Break
- 1.6i 16v. /Break /Cab.
- 1.6i Turbo /Cab.
- 1.7 CDTi /Break
- 1.8i 16v. /Break /Cab.
- 1.9 CDTi /Break /Cab.
- 2.0i 16v. Turbo /Break /Cab.

2656013

Butée de suspension

OE 344349

Shock bush



- 3 H50**
- 1.3 CDTi /Break
- 1.4i 16v. /Break
- 1.6i 16v. /Break
- 1.7 CDTi /Break
- 1.8i 16v. /Break
- 1.9 CDTi /Break
- 2.0i 16v. Turbo /Break

Eléments TRAIN ARRIERE

Rear axle parts

Tren TRAS

Elementy zawieszenia tylnego

элементы задней оси.



2606004

Articulation essieu AR

OE 0402952

Rear axle bush



Ø int.13 Ø ext.70.5 coll.85 long. tube int. 91 ext. 56 ep coll. 21

- | | |
|----------------------|--------|
| 1.3 CDTi | 02/05- |
| 1.4i 16v. | 04/04- |
| 1.6i 16v. | 04/04- |
| 1.6i Turbo | 01/07- |
| 1.7 CDTi | 04/04- |
| 1.8i 16v. | 04/04- |
| 1.9 CDTi | 08/04- |
| 2.0i 16v. Turbo /OPC | 08/04- |

Astra J ...

Eléments DIRECTION
Steering parts
Elementos Direcciones
Elementy układ kierowniczy
Элементы рулевой системы

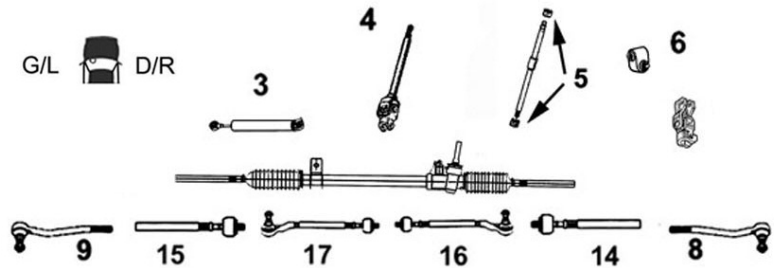

OPEL

7776090

Axe de bielle G/D

OE 920005

L/R axial joint

NEW



14 Côté dir. M16x1.5 Côté rot. M16x1.5 long 293 mm
15 DA Hydraulique POC NXC

-chA3999999 -chA8999999 -chAG999999

1.3 CDTi /FAP	06/10-
1.4i /Turbo	01/10-
1.6i /Turbo	01/10-
1.7 CDTi FAP	01/10-
2.0 CDTi FAP	01/10-

7776091

Axe de bielle G/D

OE 920007

L/R axial joint

NEW



14 Côté dir. M16x1.5 Côté rot. M16x1.5 long 293 mm
15 DA Hydraulique POC N40 NV7

-ch A3999999 -ch A8999999 -ch AG999999 Ch- C0000001
 ch- C1000001 ch- B3000001 ch- B8000001 ch- BG000001

1.3 CDTi /FAP	06/10-
1.4i /Turbo	01/10-
1.6i /Turbo	01/10-
1.7 CDTi FAP	01/10-
2.0 CDTi FAP	01/10-

7776093

Axe de bielle G/D

OE 1609027

L/R axial joint

NEW



14 Côté dir. M16x1.5 Côté rot. M16x1.5 long 289 mm
15 DA Electricque POC NJ1

1.3 CDTi /FAP 5ptes /Break	01/10-
1.4i /Turbo 5ptes /Break	01/10-
1.6i /Turbo 5ptes /Break	01/10-
1.7 CDTi FAP 5ptes /Break	01/10-
2.0 CDTi FAP 5ptes /Break	01/10-

7776094

Axe de bielle G/D

OE 1609029

L/R axial joint

NEW



14 Côté dir. M16x1.5 Côté rot. M16x1.5 long 289 mm
15 DA Electricque POC NJ0

1.3 CDTi /FAP 5ptes /Break	01/10-
1.4i /Turbo / 5ptes /Break	01/10-
1.6i /Turbo 5ptes /Break	01/10-
1.7 CDTi FAP 5ptes /Break	01/10-
2.0 CDTi FAP 5ptes /Break	01/10-

7676069

Rotule de direction G/D

OE 1609026

L/R tie rod end

NEW



8 M16 x 1.5 DA Electricque
9

1.3 CDTi /FAP 5ptes /Break	01/10-
1.4i /Turbo / 5ptes /Break	01/10-
1.6i /Turbo 5ptes /Break	01/10-
1.7 CDTi FAP 5ptes /Break	01/10-
2.0 CDTi FAP 5ptes /Break	01/10-

7676069

Rotule de direction G/D

OE 920008

L/R tie rod end

NEW



8 M16 x 1.5 DA Hydraulique
9

1.3 CDTi /FAP	01/10-
1.4i /Turbo	01/10-
1.6i /Turbo	01/10-
1.7 CDTi FAP	01/10-
2.0 CDTi FAP	01/10-

... Astra J



Barre stabilisatrice
 Stabilizer bar
 Barra estabilizadora
 Drażek stabilizatora
 стабилизатор поперечной устойчивости

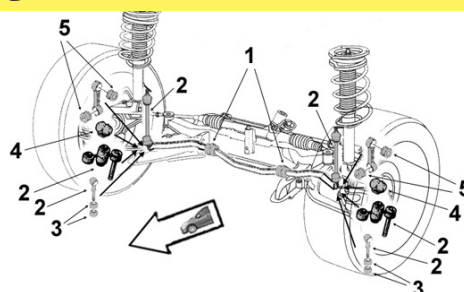

OPEL



2306140

OE 350618

Biellette barre stab.

Stabilizer bar stub axle

NEW



2

1.3 CDTi 95hp 70kw 5ptes/Break
 1.4i /Turbo 5ptes /Break
 1.6i /Turbo 5ptes /Break
 1.7 CDTi 5ptes /Break
 2.0 CDTi 5ptes /Break

06/10-
 01/10-
 01/10-
 01/11-
 01/10-

Bras & Triangle de suspension

Control arm
Brazo y triángulo
Wahacz
Рычаг подвески

G/L D/R



7476215

OE 352492

Triangle de susp. G

Left track control arm

NEW



4

Avec rotule With ball joint Ø 20

1.3 CDTi 5ptes/ Break 01/10-
 1.4i /Turbo / GPL 5ptes/ Break 01/10-
 1.6i /Turbo 5ptes/ Break 01/10-
 1.7 CDTi 5ptes/ Break 01/10-
 2.0 CDTi 5ptes/ Break Sauf Biturbo 01/10-

7476214

OE 352493

Triangle de susp. D

Right track control arm

NEW



3

Avec rotule With ball joint Ø 20

1.3 CDTi 5ptes/ Break 01/10-
 1.4i /Turbo / GPL 5ptes/ Break 01/10-
 1.6i /Turbo 5ptes/ Break 01/10-
 1.7 CDTi 5ptes/ Break 01/10-
 2.0 CDTi 5ptes/ Break Sauf Biturbo 01/10-

Eléments TRAIN ARRIERE

Rear axle parts
Tren TRAS
Elementy zawieszenia tylnego
элементы задней оси.



2606009

OE 402027

Articulation essieu AR

Rear axle bush



Ø int.12 Ø ext.68 coll.78 long. tube int.90 ext.64 ep. coll.11

1.3 CDTi
 1.4i
 1.4i Turbo
 1.6i
 1.6i Turbo
 1.7 CDTi
 1.8i
 2.0 CDTi

06/10-
 01/10-
 01/10-
 01/10-
 01/10-
 01/10-
 01/12-
 01/10-

Calibra ...

Eléments DIRECTION
 Steering parts
 Elementos Direcciones
 Elementy układ kierowniczy
 Элементы рулевой системы

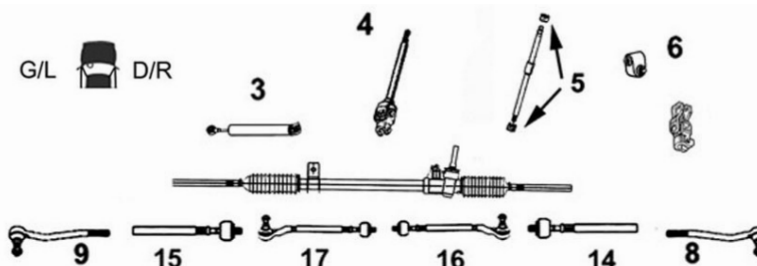

OPEL

SASIC

9006204 **Axe de bielle G**
 OE 322147 *Left axial joint*



15 M16x1.5

 TT /all models 01/89-

9006203 **Axe de bielle D**
 OE 322146 *Right axial joint*



14 M16x1.5

 TT /all models 01/89-

9006370 **Rotule de direction G**
 OE 324055 *Left tie rod end*



9 M16x1.5

 TT /all models 01/89-

9006371 **Rotule de direction D**
 OE 324056 *Right tie rod end*



8 M16x1.5

 TT /all models 01/89-



Barre stabilisatrice
 Stabilizer bar
 Barra estabilizadora
 Drażek stabilizatora
 стабилизатор поперечной устойчивости

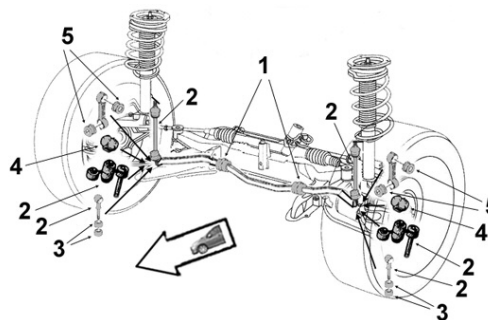

9005077 **Biellette barre stab.**
 OE 350263 *Stabilizer bar stub axle*



2 Barre Ø 20

 2.0
 2.0 Turbo 4WD
 2.0i 16v.
 2.5 V6

9001510 **Biellette barre stab.**
 OE 350260 *Stabilizer bar stub axle*



2 Barre Ø 22

 2.0
 2.0 Turbo 4WD
 2.0i 16v.
 2.5 V6

9001529 **Liaison élastique**
 OE 350153 *Elastic link*



3 Ø int.8.5 Ø ext.30
 long. tube int.19.5 ext.17

 2.0
 2.0 Turbo 4WD
 2.0i 16v.
 2.5 V6

9001659 **Palier de barre milieu**
 OE 350078 *Middle bar main bearing*



1 Barre Ø 22

 2.0
 2.0i 16v.
 2.0 Turbo 4WD
 2.5 V6

... Calibra ...





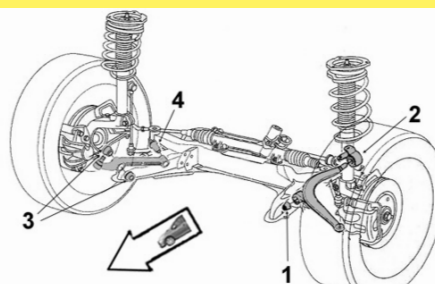







Eléments SUSPENSION
Suspension parts
Elementos suspensión
Elementy zawieszenie
Элементы подвески



OPEL



9001513 OE 352300	Articulation AV <i>Front bush</i>	9001765 OE 352346	Articulation AV <i>Front bush</i>
	1 Ø int.12 Ø ext.38 coll.43 long. tube int.59 ext.30 ep. coll.7 2.0 -ch R9003127		1 Ø int.12 Ø ext.38 coll.43 x2 long. tube int.59.5 ext.28 ep. coll.7x2 2.0 Ch- R9003128 2.0i 16v. Ch- R9003128
9001516 OE 352348	Articulation AR <i>Rear bush</i>	9001648 OE 352356	Articulation AR <i>Rear bush</i>
	2 Ø int.16 Ø ext.60 coll.66.5 long. tube int.58 ext.24 ep. coll.3 2.0 -ch R9003127 2.0 Ch- R9003128 2.0 4WD Ch- R9003128		2 Ø int.16 Ø ext.60 coll.67.5 long. tube int.58 ext.24 ep. coll.3 2.0i 16v. Ch- R9003128 2.0 Turbo 4WD Ch- R9003128
<p>Bras & Triangle de suspension <i>Control arm</i> <i>Brazo y triángulo</i> <i>Wahacz</i> <i>Рычаг подвески</i></p> <div style="display: flex; justify-content: space-around; align-items: center;"> <div style="text-align: center;"> <p>G/L  D/R</p> </div> <div style="text-align: center;"> <p>2</p>  <p>4</p> </div> <div style="text-align: center;"> <p>1</p>  <p>3</p> </div> </div>			
9005189 OE 352077	Triangle de susp. G <i>Left track control arm</i>	9005188 OE 352076	Triangle de susp. D <i>Right track control arm</i>
	4 Avec rotule With ball joint 2.0i 01/89- 2.0i 16v. 01/89- 2.0i Turbo 4WD 01/89-		3 Avec rotule With ball joint 2.0i 01/89- 2.0i 16v. 01/89- 2.0i Turbo 4WD 01/89-
9005250 OE 1603167	Rotule de susp. inf. G/D <i>L/R lower suspension ball joint</i>		
	1 2 2.0i T1 C20NE 01/89- 2.0i 16v. T1 C20XE 01/89- 2.0i 16v. T9 X20XE 01/89- 2.0i Turbo 4WD T9 C20LET 01/89-		

... Calibra

SASIC

OPEL



Support d'amortisseur
Suspension mounting
Soporte amortiguador
Poduszka amortyzatora
Опора амортизатора

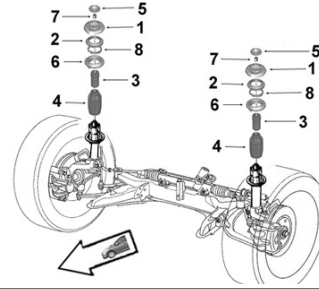

9005607
 OE 344513

Support suspension G/D
L/R suspension mounting



1

2.0
 2.0i 16v.
 2.0 Turbo 4WD

9005359
 OE 344411

Butée de suspension G/D
L/R suspension bush



3

H67

2.0 Turbo 4WD 03/92-07/97

Eléments TRAIN ARRIERE

Rear axle parts
Tren TRAS
Elementy zawieszenia tylnego
элементы задней оси.



9001663
 OE 402937

Articulation essieu AR
Rear axle bush



Ø int.19 Ø ext.96 coll.120 Long. tube int.72 ext.76 ep. Coll.12

2.0
 2.0i 16v.
 2.0 Turbo 4WD
 2.5 V6

Corsa A ...

Eléments DIRECTION

Steering parts
Elementos Direcciones
Elementy uklad kierowniczy
Элементы рулевой системы

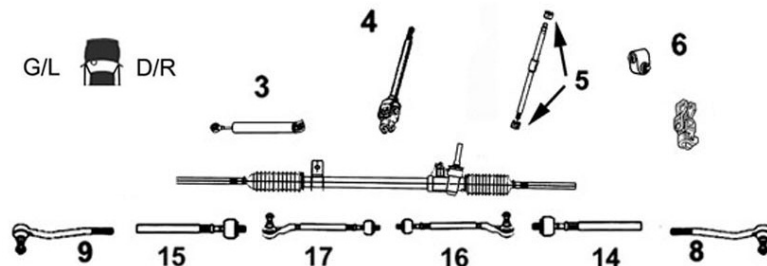

9006200
 OE 322149

Axe de bielle G/D
L/R axial joint



14 Côté dir. M14x1.5
15 Côté rot. M12x1.5 long 293 mm

TT /all models 09/82-12/93

9006374
 OE 1603645

Rotule de direction G/D
L/R tie rod end



8

M12 x 1.5

9

TT /all models 09/82-12/93

... Corsa A ...



Barre stabilisatrice
 Stabilizer bar
 Barra estabilizadora
 Drażek stabilizatora
 стабилизатор поперечной устойчивости

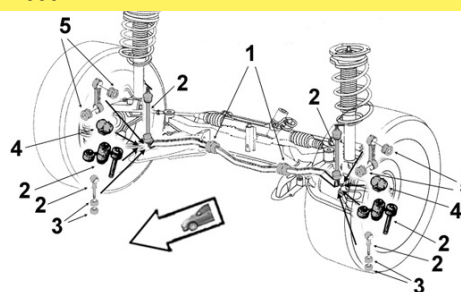

OPEL



9001517
 OE 353560

Palier tirant de barre
Stabilizer bar tie rod bearing



1 Ø int.14 Ø ext.33 coll.45
 long. tube int.37 ext.16.5 ep. coll.7

1.0	-03/93
1.2	-03/93
1.3	-03/93
1.4	-03/93
1.5 D	-03/93
1.5 TD	-03/93
1.6	-03/93

9001535
 OE 350109

Palier de barre
Bar main bearing



1 Barre Ø 17.5

1.0	-03/93
1.2	-03/93
1.3	-03/93
1.4i	07/91-03/93

Bras & Triangle de suspension

Control arm
 Brazo y triángulo
 Wahacz
 Рычаг подвески

G/L D/R

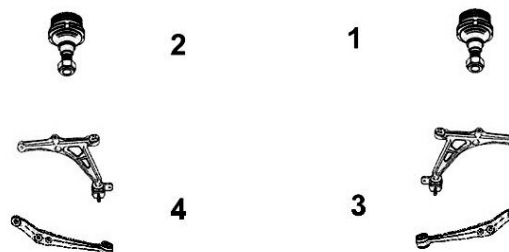

9005186
 OE 352044

Bras de susp. D
Right track control arm



3 Sans rotule *Without tie rod end*

TT /all models 09/82-12/93

9005252
 OE 1603161

Rotule de susp. inf. G/D
L/R lower suspension ball joint



1 Ø 15
2

TT /all models 09/82-12/93



Support d'amortisseur
 Suspension mounting
 Soporte amortiguador
 Poduszka amortyzatora
 Опора амортизатора

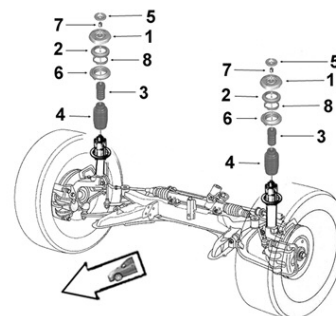

8005202
 OE 312503

Butée à billes G/D
L/R ball bearing



2 Ø 12 x 130 x 28

1.0	-03/93
1.2	-03/93
1.3 Break	-03/93
1.4	-03/93
1.5 D	-03/93

...Corsa A

Eléments TRAIN ARRIERE

Rear axle parts

Tren TRAS

Elementy zawieszenia tylnego

элементы задней оси.

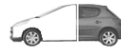

SASIC

OPEL

9001654

Articulation essieu AR

OE 402643

Rear axle bush

Ø int.10 Ø ext.41 coll.53 long. tube int.65 ext.44.5 ep. coll.8



1.0
1.2
1.3
1.4
1.5 D
1.5 TD
1.6

-03/93
-03/93
-03/93
-03/93
-03/93
-03/93
-03/93

Corsa B...

Eléments DIRECTION

Steering parts

Elementos Direcciones

Elementy układ kierowniczy

Элементы рулевой системы

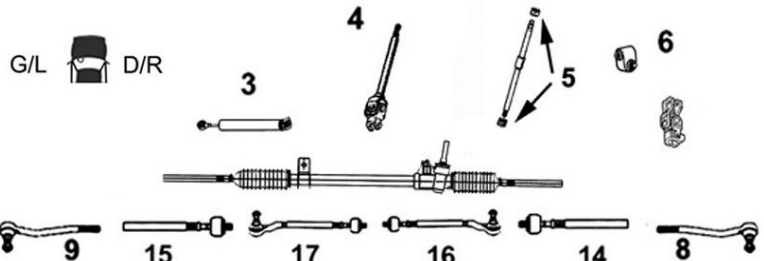

9006201

Axe de bielle G/D

OE 1603453

L/R axial joint



14 Côté dir. M14x1.5
15 Côté rot. M12x1.5 long 322 mm

TT /all models 01/93-12/00
DNA assistance électronique

9006202

Axe de bielle G/D

OE 322158

L/R axial joint



14 Côté dir. M14x1.5
15 Côté rot. M12x1.5 long 281 mm

TT /all models DA 01/93-12/00

9006374

Rotule de direction G/D

OE 1603645

L/R tie rod end



8
9 M12 x 1.5

TT /all models -ch V3023597 -ch V4166925 -ch V6066279 01/93-

9006692

Rotule de direction G/D

OE 1603455

L/R tie rod end



8
9 M12 x 1.5

TT /all models Ch- V3023598 Ch- V4166926 Ch- V6066280 -12/00

...Corsa B...



Barre stabilisatrice
 Stabilizer bar
 Barra estabilizadora
 Drażek stabilizatora
 стабилизатор поперечной устойчивости

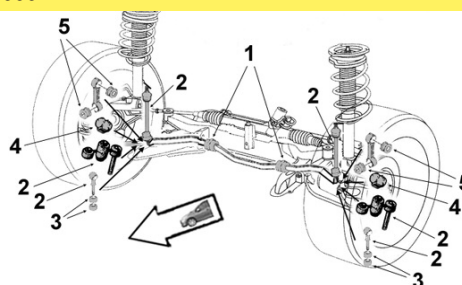

9001509
 OE 350127

Palier de barre milieu
 Middle bar main bearing



1 Barre Ø 21.5			
1.0i 12v.	X10XE	04/93-	
1.2	C12NZ	04/93-	
1.2i	X12SZ	04/97-07/98	
1.2i 16v.	X12XE	04/93-	
1.4	C14NZ/SE	04/93-	
1.4i	X14SZ	04/97-08/00	
1.4i 16v.	X14XE	04/93-	
1.5 D TD		04/93-	
1.6i 16v. GSi	C16XE	04/93-	
1.7 D		04/93-	

9001657
 OE 0353282

Art. tirant de barre
 Rod bushing



3 Ø int.14 Ø ext. 58 coll.62 long. tube int.36 ext.23.5 coll.4.5		
1.0i 12v.		04/97-10/00
1.2/i 16v.		04/97-10/00
1.4		04/97-10/00
1.4i 16v.	X14XE	04/97-10/00
1.5 TD		04/97-10/00
1.6i 16v.		04/97-10/00
1.7 D		04/97-10/00



Eléments SUSPENSION
 Suspension parts
 Elementos suspensión
 Elementy zawieszenie
 Элементы подвески

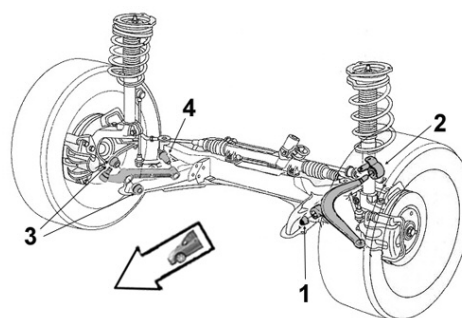

9001514
 OE 352301

Articulation int.
 Inner bush



4 Ø int.10 Ø ext.37 coll.44 long. tube int.52 ext.28 ep. coll.6		
1.0i 12v.		04/93-
1.2i /16v.		04/93-
1.4i /16v.		04/93-
1.5 D		04/93-
1.5 TD		04/93-
1.6i 16v. GSi		04/93-
1.7 D		04/93-

Bras & Triangle de suspension

Control arm
 Brazo y triángulo
 Wahacz
 Рычаг подвески

G/L D/R

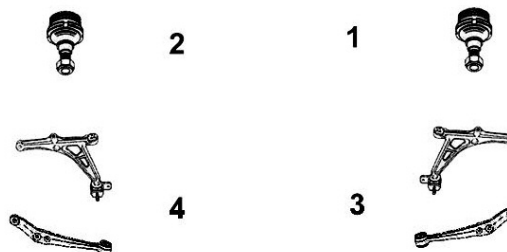

9005184
 OE 352181

Bras de suspension G
 Left track control arm



4 Sans rotule Without tie rod end	
TT /all models	-ch V3023597 01/93-12/00

9005183
 OE 352002

Bras de suspension D
 Right track control arm



3 Sans rotule Without tie rod end	
TT /all models	-ch V3023597 01/93-12/00

... Corsa B ...

SASIC

OPEL

Bras & Triangle de suspension

Control arm
Brazo y triángulo
Wahacz
Рычаг подвески

G/L  D/R



9005766

OE 5352011

Bras de suspension G

Left track control arm

4 Sans rotule Without tie rod end



TT /all models Ch- V3023598
01/93-12/00

9005764

OE 5352012

Bras de suspension D

Right track control arm

3 Sans rotule Without tie rod end



TT /all models Ch- V3023598
01/93-12/00

7476130

OE 1603128+352003

Bras de suspension G

Left track control arm

4 Avec rotule With ball joint Ø 15

NEW



TT /all models -ch V3023597
01/93-12/00

7476129

OE 1603187+352002

Bras de suspension D

Right track control arm

3 Avec rotule With ball joint Ø 15

NEW



TT /all models -ch V3023597
01/93-12/00

7476132

OE 5352011+1603202

Bras de suspension G

Left track control arm

4 Avec rotule With ball joint Ø 15

NEW



TT /all models Ch- V3023598
01/93-12/00

7476131

OE 5352012+1603202

Bras de suspension D

Right track control arm

3 Avec rotule With ball joint Ø 15

NEW



TT /all models Ch- V3023598
01/93-12/00

9005252

OE 1603187

Rotule de susp. inf. G/D

L/R lower suspension ball joint

1 Ø 15
2



TT /all models -ch V3023597 01/93-12/00

9005542

OE 1603202

Rotule de susp. inf. G/D

L/R lower suspension ball joint

1 Ø 15
2



TT /all models Ch- V3023598 01/93-12/00

... Corsa B



Support d'amortisseur
Suspension mounting
Soporte amortiguador
Poduszka amortyzatora
Опора амортизатора

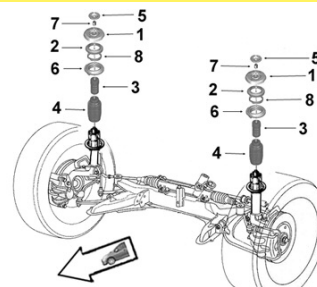

OPEL

ASAC

2656063

OE 0312510

Butée à billes G/D

L/R ball bearing

NEW

2



TT /all models

9001687

OE 344519

Support suspension G/D

L/R suspension mounting

1



1.0i 12v.	X10XE	04/93-
1.2	C12NZ	04/93-
1.2i 16v.	X12XE	04/93-
1.4	C14NZ/SE	04/93-
1.4i 16v.	X14XE	04/93-
1.5 D TD		04/93-
1.6i 16v.	X16XE	04/93-
1.7 D		04/93-

9005358

OE 344410

Butée de suspension G/D

L/R suspension bush

3



1.0i 12v.	X10XE	04/93-
1.2		04/93-
1.2i 16v.		04/93-
1.4 Avec clim.		04/93-
1.4i 16v.	X14XE	04/93-
1.5 D TD		04/93-
1.6i 16v.		04/93-
1.7 D		04/93-



Barre stabilisatrice

Stabilizer bar
Barra estabilizadora
Drażek stabilizatora
стабилизатор поперечной устойчивости

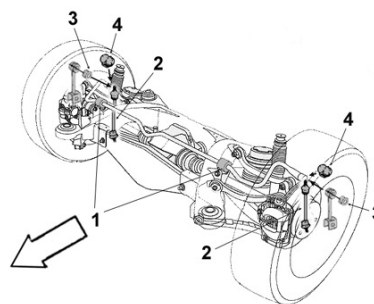

2306130

OE 444332

Palier de barre milieu

Middle bar main bearing

NEW

1 Ø 12



1.5 TD	04/97-08/00
1.7 D	04/97-10/00

9001654

OE 402643

Articulation essieu AR

Rear axle bush



Ø int.10 Ø ext.41 coll.53
 long. tube int.65 ext.44.5 ep. coll.8

1.0i 12v.	X10XE	04/93-
1.2	C12NZ	04/93-
1.2i 16v.	X12XE	07/98-10/00
1.4	C14NZ/SE	04/93-
1.4i 16v.	X14XE	04/93-
1.5 D TD		04/93-
1.6i 16v. GSi	C16XE	04/93-
1.7 D		04/93-

Eléments TRAIN ARRIERE

Rear axle parts
Tren TRAS
Elementy zawieszenia tylnego
элементы задней оси.



Corsa C ...

Eléments DIRECTION
 Steering parts
 Elementos Direcciones
 Elementy układ kierowniczy
 Элементы рулевой системы

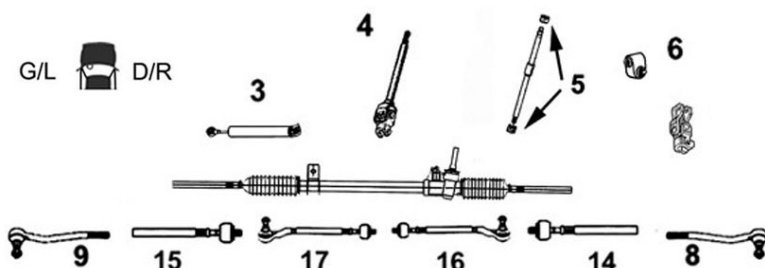

9006854 Axe de bielle G/D

Part/oe 1603845 L/R axial joint



14 Côté dir. M14x1.5 Côté rot. M12x1.5 long 310 mm
15 -ch 33/34/36 999999

1.0i 12v.	01/01-
1.2i 16v.	01/01-
1.3 CDTi	08/03-
1.4i 16v.	01/01-
1.7 CDTi	08/03-
1.7 Di 16v. / DTi 16v.	01/01-
1.8i 16v.	01/01-

7776035 Axe de bielle G/D

OE 1603844 L/R axial joint



14 Côté dir. M14x1.5 Côté rot. M12x1.5 long 305 mm
15 Ch- 43/44/46 000001

1.0i 12v.
 1.2i 16v.
 1.3 CDTi
 1.4i 16v.
 1.7 CDTi
 1.7 Di DTi
 1.8i 16v.

7776037 Axe de bielle G/D

Part/oe 1603018 L/R axial joint



14 Côté dir. M14x1.5
15 Côté rot. M12x1.5 long 310 mm

1.7 CDTi Ch- 43/44/46000001
 Hayon camionnette F08-F68

9006374 Rotule de direction G/D

OE 1603009 L/R tie rod end



8 M12 x 1.5
9

1.0i 12v.	01/01-
1.2i 16v.	01/01-
1.3 CDTi	08/03-
1.4i 16v.	01/01-
1.7 CDTi	08/03-
1.7 Di 16v.	01/01-
1.7 DTi 16v.	01/01-
1.8i 16v.	01/01-



Barre stabilisatrice
 Stabilizer bar
 Barra estabilizadora
 Drażek stabilizatora
 стабилизатор поперечной устойчивости

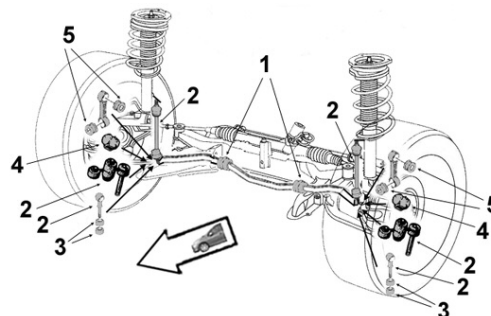

9005014 Bielle barre stab.

OE 350610 Stabilizer bar stub axle



2
 1.0i 12v.
 1.2i 16v.
 1.3 CDTi 16v.
 1.4i 16v.
 1.7 CDTi
 1.7 Di 16v.
 1.7 DTi 16v.
 1.8i 16v.

2306129 Palier de barre milieu

OE 350130 Middle bar main bearing



1 Ø17
 1.0i 12v.
 1.2i 16v.
 1.3 CDTi
 1.4i 16v.
 1.7 CDTi
 1.7 Di 16v.
 1.7 DTi 16v.
 1.8i 16v.

... Corsa C ...



Eléments SUSPENSION

Suspension parts

Elementos suspensión

Elementy zawieszenie

Элементы подвески

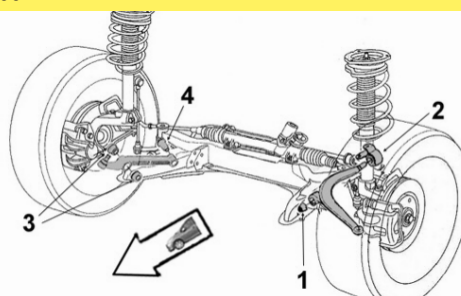

OPEL



9001757

Articulation AV

OE 352378

Front bush



1 Ø int.12.3 -Ch13/14/16 999999

1.0i 12v.
1.2i 16v.
1.3 CDTi 16v.
1.4i 16v.
1.7 CDTi
1.7 Di 16v.
1.7 DTi 16v.
1.8i 16v.

9001775

Articulation AR

OE 352320

Rear bush



2 Ø int.12.5 Ø ext.60 long. tube int.45.5 ext.27

1.0i 12v.
1.2i 16v.
1.3 CDTi 16v.
1.4i 16v.
1.7 CDTi
1.7 Di DTi 16v.
1.8i 16v.

Bras & Triangle de suspension

Control arm
Brazo y triángulo
Wahacz
Рычаг подвески

G/L D/R

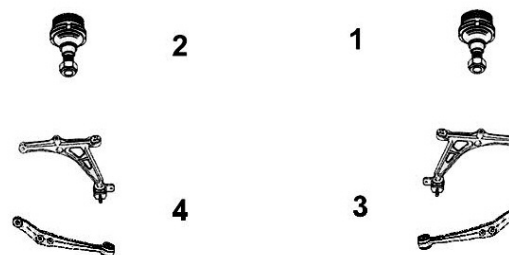

9005190

Triangle de suspension G

OE 352061

Left track control arm



4 Avec rotule With ball joint

1.0i 12v.
1.2i 16v.
1.3 CDTi
1.4i 16v.
1.7 CDTi
1.7 Di 16v.
1.7 DTi 16v.
1.8i 16v.

9005191

Triangle de suspension D

OE 352063

Right track control arm



3 Avec rotule With ball joint

1.0i 12v.
1.2i 16v.
1.3 CDTi
1.4i 16v.
1.7 CDTi
1.7 Di 16v.
1.7 DTi 16v.
1.8i 16v.

9005541

Rotule de susp. inf. G/D

OE 352803

L/R lower suspension ball joint



1
2

1.0i 12v.
1.2i 16v.
1.3 CDTi
1.4i 16v.
1.7 CDTi
1.7 Di 16v.
1.7 DTi 16v.
1.8i 16v.

... Corsa C

SASIC



Support d'amortisseur
Suspension mounting
Soporte amortiguador
Poduszka amortyzatora
Опора амортизатора

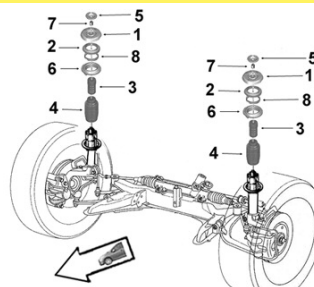

2656012

OE 344523

Support suspension

Suspension mounting



1 Sans joint incorporé *Without built attached*

1.0i 12v.
 1.2i 16v.
 1.3 CDTi
 1.4i 16v.
 1.7 CDTi
 1.7 Di 16v.
 1.7 DTi 16v.
 1.8i 16v.

2656063

OE 0312510

Butée à billes G/D

L/R ball bearing

NEW



2

TT /all models

Corsa D ...

Eléments DIRECTION

Steering parts

Elementos Direcciones

Elementy uklad kierowniczy

Элементы рулевой системы

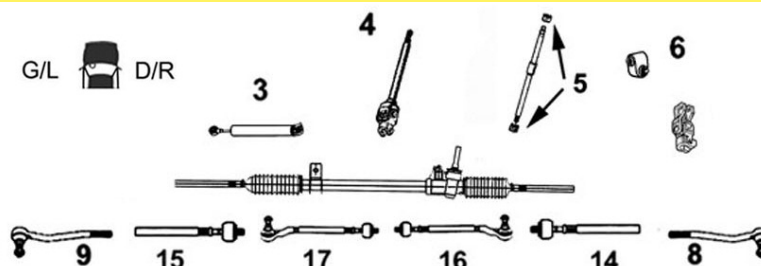

7776038

OE 1603543

Axe de bielle G/D

L/R axial joint



14 Côté dir. M14x1.5 Côté rot. M14x1.5 long 293 mm

15

1.0
 1.2i 16v.
 1.3 CDTi
 1.4i 16v.
 1.6 Turbo
 1.7 CDTi

7676014

OE 1603544

Rotule de direction G

Left tie rod end



9 M14 x 1.5

1.0
 1.2i 16v. / GPL
 1.3 CDTi
 1.4i 16v.
 1.6i Turbo
 1.7 CDTi

7676013

OE 1603545

Rotule de direction D

Right tie rod end



8 M14 x 1.5

1.0
 1.2i 16v. / GPL
 1.3 CDTi
 1.4i 16v.
 1.6i Turbo
 1.7 CDTi

... Corsa D ...



Barre stabilisatrice
 Stabilizer bar
 Barra estabilizadora
 Drążek stabilizatora
 стабилизатор поперечной устойчивости

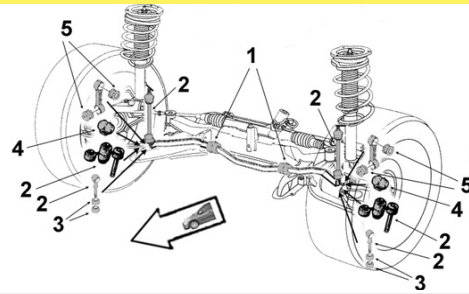

2306023
 OE 350616

Biellette barre stab.
Stabilizer bar stub axle



2

1.2i 16v.
 1.3 CDTi
 1.4i 16v.
 1.6i Turbo
 1.7 CDTi FAP



Eléments SUSPENSION
Suspension parts
 Elementos suspensión
 Elementy zawieszenie
 Элементы подвески

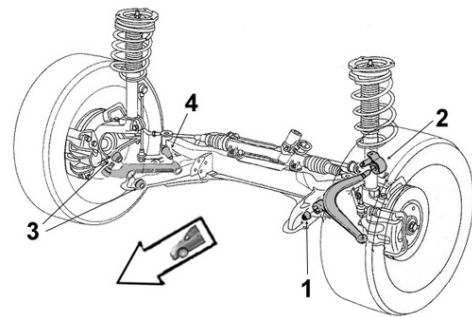

2256032
 OE 352947

Articulation AV
Front bush



1 Ø int. 12.5 Ø ext. 42 coll. 43 coll. 50.5
 long.tube int. 67.5 ext. 41

1.0i /12v.
 1.2i /16v. / GPL
 1.3 CDTi
 1.4i /16v.
 1.6i Turbo
 1.7 CDTi /FAP

2256033
 OE 352864

Articulation AR
Rear bush



2 Ø int. 12.5 Ø ext. 72
 long. tube int. 66 ext. 27.5

1.0i /12v.
 1.2i /16v. / GPL
 1.3 CDTi
 1.4i /16v.
 1.6i Turbo
 1.7 CDTi /FAP

Bras & Triangle de suspension

Control arm
 Brazo y triángulo
 Wahacz
 Рычаг подвески

G/L D/R

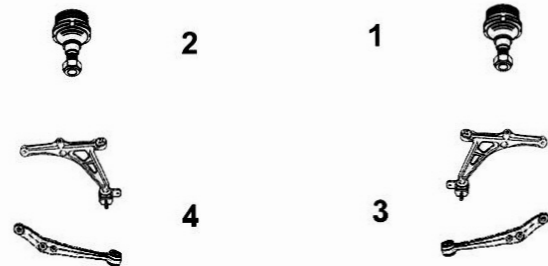

7476079
 OE 5352039

Triangle de susp. G
Left track control arm



4 Avec rotule With ball joint

1.0
 1.2i 16v. / GPL
 1.3 CDTi
 1.4i 16v.
 1.6i Turbo
 1.7 CDTi

7476078
 OE 5352038

Triangle de susp. D
Right track control arm



3 Avec rotule With ball joint

1.0
 1.2i 16v. / GPL
 1.3 CDTi
 1.4i 16v.
 1.6i Turbo
 1.7 CDTi

... Corsa D ...

SASIC

OPEL

Bras & Triangle de suspension

Control arm
Brazo y triángulo
Wahacz
Рычаг подвески

G/L  D/R

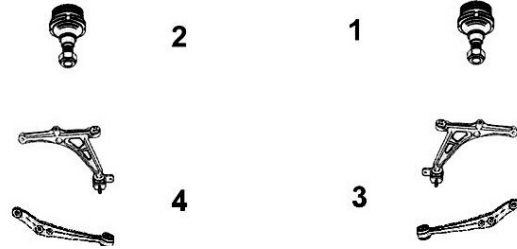

7570004

Rotule de susp. inf. G/D

OE 352087

L/R lower suspension ball joint



1
2

1.0i
1.2i 16v.
1.3 CDTi
1.4i 16v.
1.6i Turbo
1.7 CDTi



Support d'amortisseur

Suspension mounting
Soporte amortiguador
Poduszka amortyzatora
Опора амортизатора

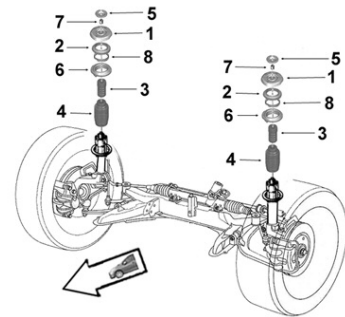

2656025

Support suspension

OE 344653

Suspension mounting



1

1.0i 12v.
1.2i 16v.
1.3 CDTi
1.4i 16v.
1.6i Turbo /OPC
1.7 CDTi

2656015

Butée de suspension

OE 344651

Shock bush



3 H71

1.0i
1.2i 16v. / GPL
1.3 CDTi
1.4i 16v.
1.6i Turbo
1.7 CDTi

2656017

Butée de suspension

OE 344956

Shock bush



3 H40

1.0i
1.2i 16v.
1.3 CDTi
1.4i 16v.
1.6i Turbo
1.7 CDTi

... Corsa D



Support d'amortisseur
 Suspension mounting
 Soporte amortiguador
 Poduszka amortyzatora
 Опора амортизатора

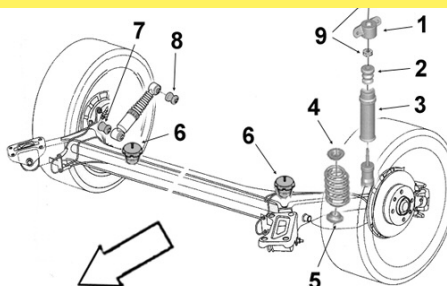

OPEL

SASIC

2656041
 OE 436773

Support suspension G
 Left suspension mounting



1 Châssis standard

1.0 12v.
 1.2
 1.2i 16v.
 1.3 CDTi
 1.4 16v.
 1.7 CDTi

2656040
 OE 436774

Support suspension D
 Right suspension mounting



1 Châssis standard

1.0 12v.
 1.2
 1.2i 16v.
 1.3 CDTi
 1.4 16v.
 1.7 CDTi

Frontera

Bras & Triangle de suspension

Control arm
 Brazo y triángulo
 Wahacz
 Рычаг подвески

G/L D/R

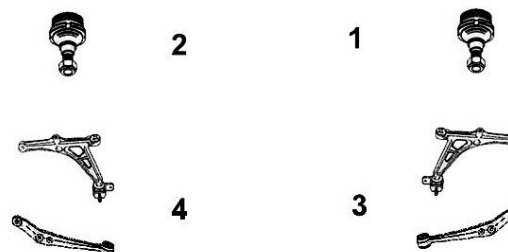

9005257
 OE 352828

Rotule de susp. inf. G/D
 L/R lower suspension ball joint



1
2

TT /all models

04/93-

Insignia ...

Éléments DIRECTION

Steering parts
 Elementos Direcciones
 Elementy układ kierowniczy
 Элементы рулевой системы

G/L D/R

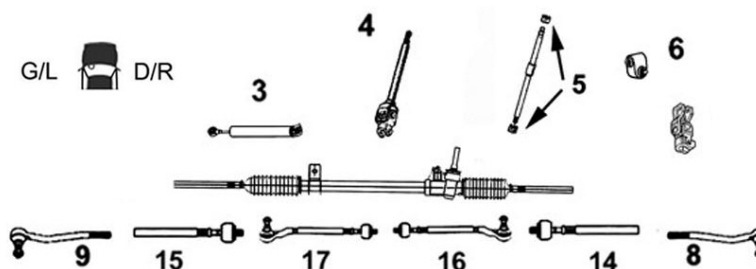

7676069
 OE 1609026

Rotule de direction G/D
 L/R tie rod end

NEW



8
9 M16 x 1.5 DA Electrique

1.4i Turbo / GPL / Break
 1.6i / Turbo / Break
 1.8i / Break
 2.0i Turbo / ETH / Break
 2.0 CDTi FAP / Break

... Insignia



Barre stabilatrice
 Stabilizer bar
 Barra estabilizadora
 Drażek stabilizatora
 стабилизатор поперечной устойчивости

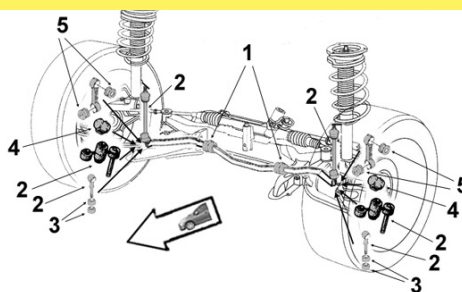

2306140

OE 350618

Biellette barre stab.

Stabilizer bar stub axle

NEW

2



2.0 CDTi FAP 160hp 118kw /Break
 2.8i Turbo 4WD 260hp 191kw /Break

01/09-
 01/09-

Kadett E ...

Eléments DIRECTION
 Steering parts
 Elementos Direcciones
 Elementy układ kierowniczy
 Элементы рулевой системы

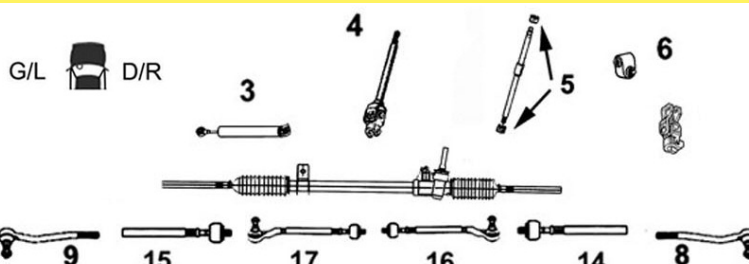

9006205

OE 322126

Axe de bielle D

Right axial joint



14 M16x1.5

TT /all models

09/84-01/92

9006372

OE 324039

Rotule de direction G

Left tie rod end



9 M16x1.5

TT /all models 09/84-01/92

9006373

OE 324038

Rotule de direction D

Right tie rod end



8 M16x1.5

TT /all models 09/84-01/92

... Kadett E ...



Barre stabilisatrice
 Stabilizer bar
 Barra estabilizadora
 Drążek stabilizatora
 стабилизатор поперечной устойчивости

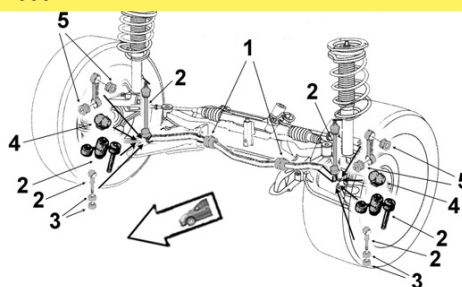

OPEL



9001529
 OE 350153

Liaison élastique
 Elastic link



3 Ø int.8.5 Ø ext.30 long. tube int.19.5 ext.17
 1.2
 1.3
 1.4
 1.5 TD
 1.6
 1.6 D
 1.7 D
 1.8
 2.0/i 16v.

9001660
 OE 350113

Palier de barre
 Bar main bearing



1 Barre Ø 20
 1.2
 1.3
 1.4
 1.5 TD
 1.6
 1.6 D
 1.7 D
 1.8
 2.0/i 16v.



Eléments SUSPENSION
 Suspension parts
 Elementos suspensión
 Elementy zawieszenie
 Элементы подвески

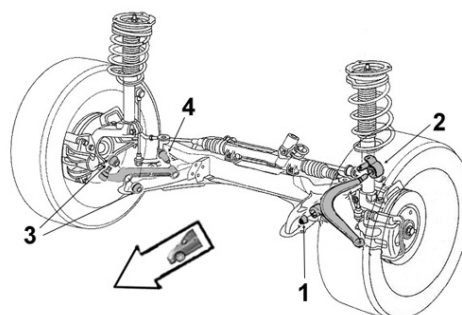

9001650
 OE 352349

Articulation AV
 Front bush



1 Ø int.14.5 Ø ext.38.5 coll.43
 long. tube int.59 ext.31 ep. coll.9
 1.2 -08/91
 1.3 -08/91
 1.4 -08/91
 1.5 TD -08/91
 1.6 -08/91
 1.6 D -08/91
 1.7 D -08/91

9001646
 OE 352330

Articulation AV
 Front bush



1 Ø int.14 Ø ext.42 coll.43
 long. tube int.59 ep. coll.8
 1.8 E -08/91
 1.8 GSi -08/91
 1.8 S -08/91
 2.0 GSi -08/91
 2.0 GSi 16v. -08/91

9001515
 OE 352335

Articulation AR
 Rear bush



2 Ø int.22
 1.2
 1.3
 1.4
 1.5 TD
 1.6
 1.8

9001642
 OE 352345

Articulation AR
 Rear bush



2
 1.6 D -01/89
 1.7 D -08/91

... Kadett E

Bras & Triangle de suspension

Control arm
Brazo y triángulo
Wahacz
Рычаг подвески

G/L  D/R**9005251****Rotule de susp. inf. G/D**

OE 1603164

L/R lower suspension ball joint1
2

TT /all models

09/84-01/92

**Support d'amortisseur**

Suspension mounting
Soporte amortiguador
Poduszka amortyzatora
Опора амортизатора

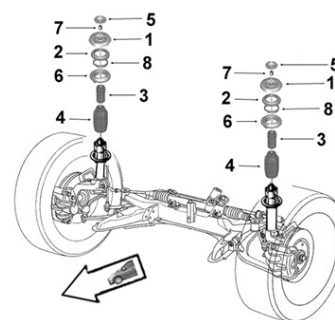
**9001686****Support suspension G/D**

OE 344509

L/R suspension mounting**1 Avec roulement With bearing**

1.5 TD	-08/91
1.6 S	-08/91
1.6 D	-08/91
1.7 D	-08/91
1.8	-02/93
1.8 GSi	-02/93
2.0	-02/93
2.0 GSi /16v.	-08/91

9005356**Butée de suspension G/D**

OE 344401

L/R suspension bush**3**

1.2
1.3
1.4
1.5 TD
1.6
1.6 D
1.7 D
1.8

Meriva ...

Eléments DIRECTION

Steering parts
Elementos Direcciones
Elementy układu kierowniczy
Элементы рулевой системы

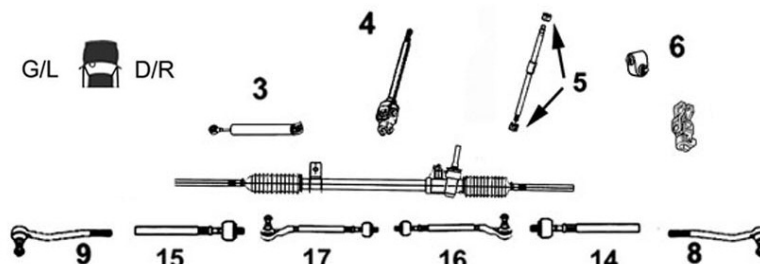
G/L  D/R**7776039****Axe de bielle G/D**

Part/oe 1603239

L/R axial joint

14 Côté dir. M14x1.5
15 Côté rot. M14x1.5 long 310 mm

1.3 CDTi	09/03-05/10
1.4 16v.	07/04-05/10
1.6	05/03-05/10
1.6 Turbo	09/05-05/10
1.7 CDTi	09/03-05/10
1.7 DTi	09/03-05/10
1.8	05/03-05/10

7776040**Axe de bielle G/D**

Part/oe 1603429

L/R axial joint

14 Côté dir. M14x1.5
15 Côté rot. M14x1.5 long 318 mm

1.3 CDTi	09/03-05/10
1.4 16v.	07/04-05/10
1.6	05/03-05/10
1.6 Turbo	09/05-05/10
1.7 CDTi	09/03-05/10
1.7 DTi	09/03-05/10
1.8	05/03-05/10

... Meriva ...

7776092 Axe de bielle G/D Part/oe 1609000 <i>L/R axial joint</i>	9006562 Rotule de direction G/D OE 1603430 <i>L/R tie rod end</i>
14 Côté dir. M18x1.5 15 Côté rot. M14x1.5 long 277 mm 1.3 CDTi Sauf DA POC NR1 06/10- 1.4i /Turbo / GPL Sauf DA POC NR1 06/10- 1.7 CDTi /FAP Sauf DA POC NR1 06/10-	8 M14 x 1.5 9 1.3 CDTi 04/05-09/10 1.4i 16v. 07/04-09/10 1.6i/16v. 04/03-09/10 1.6i Turbo OPC 01/06-09/10 1.7 CDTi 08/03-09/10 1.7 DTi 16v. Y17DT BVM 08/03-12/05 1.8i 16v. Z18XE BVM/Easy 04/03-09/10
7676084 Rotule de direction G OE 1609013 <i>Left tie rod end</i>	7676083 Rotule de direction D OE 1609012 <i>Right tie rod end</i>
9 M14 x 1.5 1.3 CDTi 09/10- 1.4i /Turbo / GPL 09/10- 1.7 CDTi /FAP 09/10-	8 M14 x 1.5 1.3 CDTi 09/10- 1.4i /Turbo / GPL 09/10- 1.7 CDTi /FAP 09/10-



Barre stabilisatrice
 Stabilizer bar
 Barra estabilizadora
 Drażek stabilizatora
 стабилизатор поперечной устойчивости

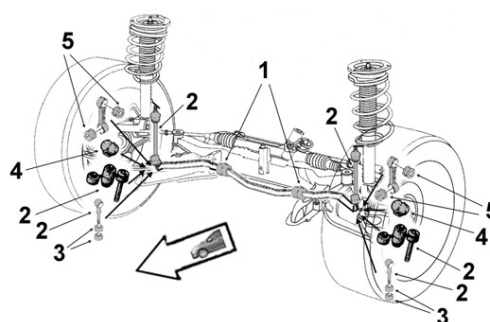

9005014 Biellette barre stab. OE 350610 <i>Stabilizer bar stub axle</i>	2306094 Palier de barre milieu OE 350161 <i>Middle bar main bearing</i>
2 1.3 CDTi 04/05-09/10 1.4i 07/04-09/10 1.6i 04/03-12/05 1.6i 16v. /Turbo 04/03-09/10 1.7 CDTi 08/03-09/10 1.7 DTi 16v. 08/03-12/05 1.8i 16v. 04/03-09/10	1 Barre Ø 21 1.3 CDTi 08/03-05/10 1.4i 16v. 07/04-05/10 1.6i 04/03-12/05 1.6i 16v. 04/03-05/10 1.6i Turbo OPC 01/06-05/10 1.7 CDTi 08/03-05/10 1.7 DTi 16v. 08/03-12/05 1.8i 16v. 04/03-05/10



Eléments SUSPENSION
 Suspension parts
 Elementos suspensión
 Elementy zawieszenie
 Элементы подвески

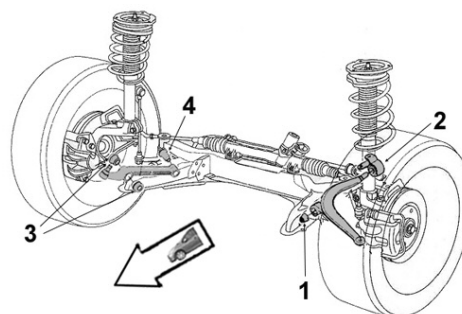

9001757 Articulation AV OE 352378 <i>Front bush</i>	9001649 Articulation AV OE 352364 <i>Front bush</i>
1 Ø int. 12.3 1.3 CDTi 04/05-09/10 1.4i 07/04-09/10 1.6i 04/03-12/05 1.6i 16v. Sauf Turbo 04/03-09/10 1.7 CDTi 08/03-09/10 1.7 DTi 16v. 08/03-12/05 1.8i 16v. 04/03-09/10	1 Ø int.12 Ø ext.36 coll.42.5 long. tube int.59.5 ext.34 ep. coll.8 1.3 CDTi 09/10- 1.4i /Turbo 09/10- 1.7 CDTi 09/10-

... Meriva ...



Eléments SUSPENSION
Suspension parts
Elementos suspensión
Elementy zawieszenie
Элементы подвески

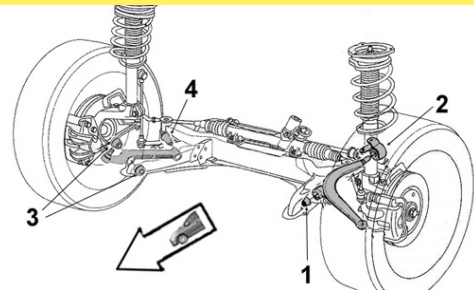

SASIC

OPEL

9001775

Articulation AR

OE 352320

Rear bush



2 Ø int.12.5 Ø ext.60 long. tube int.45.5 ext.27

1.3 CDTi	04/05-09/10
1.4i	07/04-09/10
1.6i	04/03-12/05
1.6i 16v.	04/03-09/10
1.6i 16v. Turbo	01/06-09/10
1.7 CDTi	08/03-09/10
1.7 DTi 16v.	08/03-12/05
1.8i 16v.	04/03-09/10

Bras & Triangle de suspension

Control arm
Brazo y triángulo
Wahacz
Рычаг подвески

G/L D/R

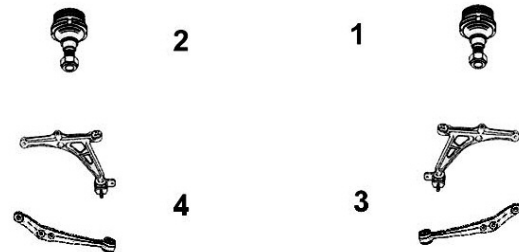

7476074

Triangle de susp. G

OE 5352027

Left track control arm



4 Avec rotule With ball joint

1.3 CDTi	04/05-05/10
1.4i 16v.	07/04-05/10
1.6i	04/03-05/10
1.6i 16v.	04/03-05/10
1.7 CDTi	08/03-05/10
1.7 DTi 16v.	08/03-
1.8i 16v.	04/03-05/10

7476073

Triangle de susp. D

OE 5352028

Right track control arm



3 Avec rotule With ball joint

1.3 CDTi	04/05-05/10
1.4i 16v.	07/04-05/10
1.6i	04/03-05/10
1.6i 16v.	04/03-05/10
1.7 CDTi	08/03-05/10
1.7 DTi 16v.	08/03-
1.8i 16v.	04/03-05/10

7476072

Triangle de susp. G

OE 5352029

Left track control arm



4 Avec rotule With ball joint

1.3 CDTi	09/10-
1.4i 16v. /Turbo	09/10-
1.7 CDTi	09/10-

7476071

Triangle de susp. D

OE 5352030

Right track control arm



3 Avec rotule With ball joint

1.3 CDTi	09/10-
1.4i 16v. /Turbo	09/10-
1.7 CDTi	09/10-

9005544

Rotule de susp. inf. G

OE 352085

Left lower suspension ball joint



2

1.3 CDTi	04/05-05/10
1.4i 16v.	07/04-05/10
1.6	-05/10
1.6i 16v.	-05/10
1.6i Turbo OPC	01/06-05/10
1.7 CDTi	-05/10
1.7 DTi 16v.	-05/10
1.8i 16v.	-05/10

9005543

Rotule de susp. inf. D

OE 352086

Right lower suspension ball joint



1

1.3 CDTi	04/05-12/05
1.4i 16v.	07/04-05/10
1.6	-05/10
1.6i 16v.	-05/10
1.6i Turbo OPC	01/06-05/10
1.7 CDTi	-05/10
1.7 DTi 16v.	-05/10
1.8i 16v.	-05/10

... Meriva

OPEL



9005256

Rotule de susp. inf. G/D

OE 352830

L/R lower suspension ball joint



1
2

1.3 CDTi
1.4i 16v. /Turbo
1.7 CDTi

06/10-
06/10-
06/10-



Support d'amortisseur

Suspension mounting
Soporte amortiguador
Poduszka amortyzatora
Опора амортизатора

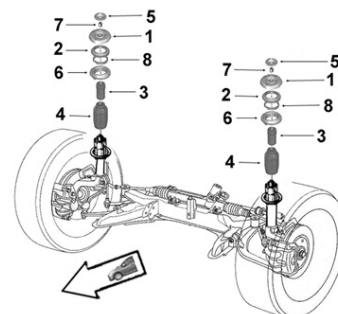

9001688

Support suspension G/D

OE 344525

L/R suspension mounting



1 Avec joint incorporé With built attached

1.3 CDTi	04/05-09/10
1.4i	07/04-09/10
1.6i	04/03-12/05
1.6i 16v.	04/03-12/05
1.6i 16v. Turbo	01/06-09/10
1.7 CDTi	01/06-09/10
1.7 DTi 16v.	08/03-12/05
1.8i 16v.	04/03-09/10

2656063

Butée à billes G/D

OE 0312510

L/R ball bearing

NEW



2

TT /all models -09/10

2656017

Butée de suspension

OE 344956

Shock bush



3 H40

1.3 CDTi
1.4i
1.7 CDTi

09/10-
09/10-
09/10-

Eléments TRAIN ARRIERE

Rear axle parts

Tren TRAS

Elementy zawieszenia tylnego

элементы задней оси.



2606004

Articulation essieu AR

OE 0402952

Rear axle bush



Ø int.13 Ø ext.70.5 coll.85 long. tube int. 91 ext. 56 ep coll. 21

1.3 CDTi
1.4i /Turbo
1.7 CDTi

09/10-
09/10-
09/10-

Omega A

Eléments DIRECTION
 Steering parts
 Elementos Direcciones
 Elementy układ kierowniczy
 Элементы рулевой системы

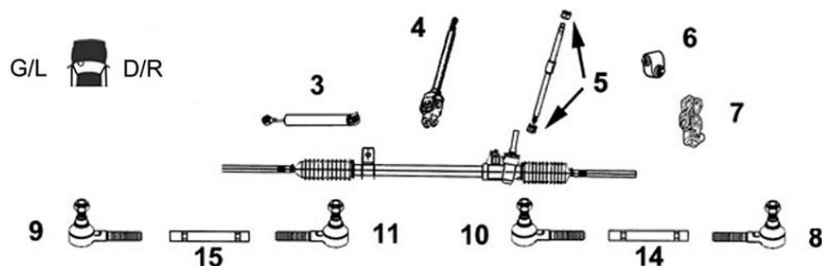

9006379 Rotule de direction G Int.
 OE 322171 Left inner tie rod end

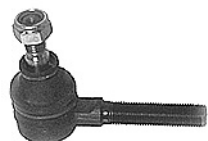

11 M14x1.5
 TT /all models 09/86-03/94

9006378 Rotule de direction D Int.
 OE 322172 Right inner tie rod end

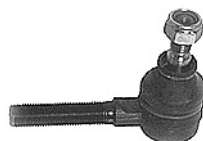

10 M14x1.5
 TT /all models 09/86-03/94

9006555 Rotule de direction G Ext.
 OE 322175 Left outer tie rod end



9 M14x1.5
 TT /all models 09/86-03/94

9006554 Rotule de direction D Ext.
 OE 322176 Right outer tie rod end



8 M14x1.5
 TT /all models 09/86-03/94

Bras & Triangle de suspension

Control arm
 Brazo y triángulo
 Wahacz
 Рычаг подвески

G/L D/R

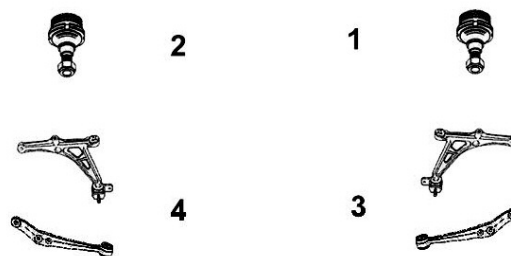

9005254 Rotule de susp. inf. G
 OE 352826 Left lower suspension ball joint



2
 TT /all models 09/86-03/94

9005253 Rotule de susp. inf. D
 OE 352827 Right lower suspension ball joint



1
 TT /all models 09/86-03/94

Eléments TRAIN ARRIERE
 Rear axle parts
 Tren TRAS
 Elementy zawieszenia tylnego
 элементы задней оси.



9001769 Articulation essieu AR
 OE 402935 Rear axle bush



Ø int.19 Ø ext.96 coll.120
 long. tube int.79 ext.44 ep. Coll.14

1.8
 2.0
 2.3 TD
 2.6

Omega B

Eléments DIRECTION

Steering parts

Elementos Direcciones

Elementy układ kierowniczy

Элементы рулевой системы

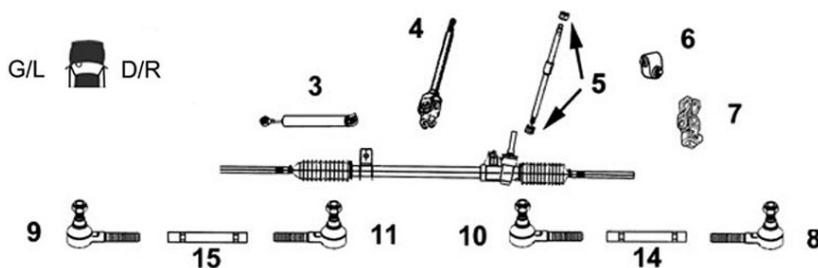

OPEL

SASIC

9006379

Rotule de direction G Int.

OE 322177

Left inner tie rod end

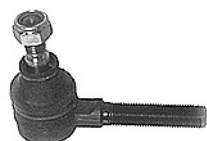

11 M14x1.5

TT /all models

04/94-

9006378

Rotule de direction D Int.

OE 322178

Right inner tie rod end

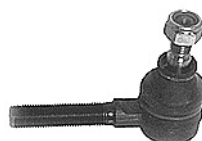

10 M14x1.5

TT /all models

04/94-

9006560

Rotule de direction G Ext.

OE 322179

Left outer tie rod end



9 M14x1.5

TT /all models

04/94-

9006559

Rotule de direction D Ext.

OE 322180

Right outer tie rod end



8 M14x1.5

TT /all models

04/94-

Bras & Triangle de suspension

Control arm

Brazo y triángulo

Wahacz

Рычаг подвески

G/L D/R

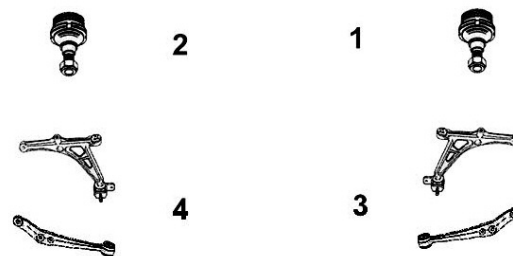

9005256

Rotule de susp. inf. G/D

OE 352800

L/R lower suspension ball joint



1
2

TT /all models

04/94-

Signum ...

Eléments DIRECTION

Steering parts

Elementos Direcciones

Elementy układ kierowniczy

Элементы рулевой системы

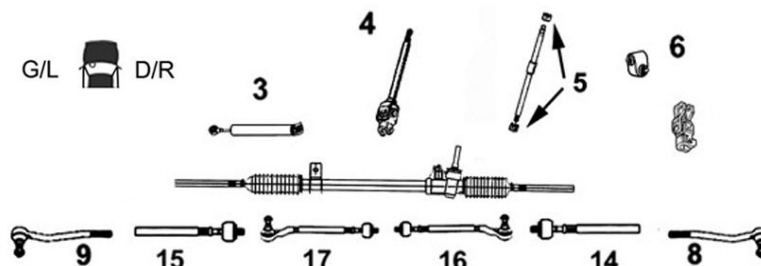

7776059

Axe de bielle G/D

Part/oe 1609050

L/R axial joint

NEW



14 Côté dir. M18x1.5 Côté rot. M14x1.5 long 285 mm
15 Jante 15/16/17 Pouces

1.8i 16v.	06/03-09/05
1.9 CDTi/FAP	07/04-12/08
2.0i 16v. Turbo	06/03-09/05
2.2i 16v.	06/03-12/08
2.2 DTi	06/03-09/05
2.8i Turbo	09/05-12/06
3.0 CDTi /FAP	06/03-12/08
3.2i V6 24v.	06/03-09/05

9006558

Rotule de direction G

OE 1603227

Left tie rod end



9 M14 x 1.5	
1.8i 16v.	06/03-09/05
1.9 CDTi	07/04-
2.0i 16v. Turbo	06/03-09/05
2.2i 16v.	06/03-
2.2 DTi	06/03-09/05
2.8 Turbo	09/05-12/06
3.0 CDTi	06/03-
3.2i V6 24v.	06/03-09/05

9006557

Rotule de direction D

OE 1603228

Right tie rod end



8 M14 x 1.5	
1.8i 16v.	06/03-09/05
1.9 CDTi	07/04-
2.0i 16v. Turbo	06/03-09/05
2.2i 16v.	06/03-
2.2 DTi	06/03-09/05
2.8 Turbo	09/05-12/06
3.0 CDTi	06/03-
3.2i V6 24v.	06/03-09/05

Bras & Triangle de suspension

Control arm

Brazo y triángulo

Wahacz

Рычаг подвески

G/L D/R

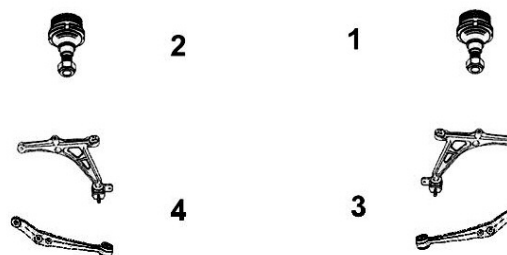

7476077

Triangle de susp. G

OE 352051

Left track control arm



4 Avec rotule With ball joint

Sauf OPC VXR

1.8i 16v.	
1.9 CDTi	
2.0i 16v. Turbo	
2.2i 16v.	
2.2 DTi	
2.8i Turbo	
3.0 CDTi	
3.2i V6 24v.	

7476075

Triangle de susp. D

OE 352052

Right track control arm



3 Avec rotule With ball joint

Sauf OPC VXR

1.8i 16v.	
1.9 CDTi	
2.0i 16v. Turbo	
2.2i 16v.	
2.2 DTi	
2.8i Turbo	
3.0 CDTi	
3.2i V6 24v.	

... Signum



Support d'amortisseur
Suspension mounting
Soporte amortiguador
Poduszka amortyzatora
Опора амортизатора

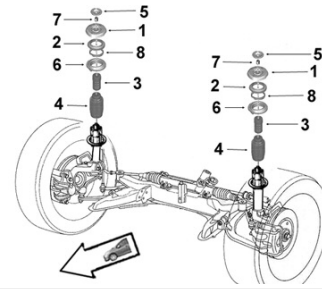

2656013

Butée de suspension

OE 344349

Shock bush



3 H50

1.8i 16v.	BVM	06/03-09/05
1.9 CDTi		07/04-09/05
2.0i 16v. Turbo	BVM	06/03-09/05
2.2i 16v.		06/03-09/05
2.2 DTi		06/03-09/05
3.0 CDTi		06/03-09/05
3.2i V6 24v.		06/03-09/05

Tigra ...

Eléments DIRECTION

Steering parts

Elementos Direcciones

Elementy uklad kierowniczy

Элементы рулевой системы

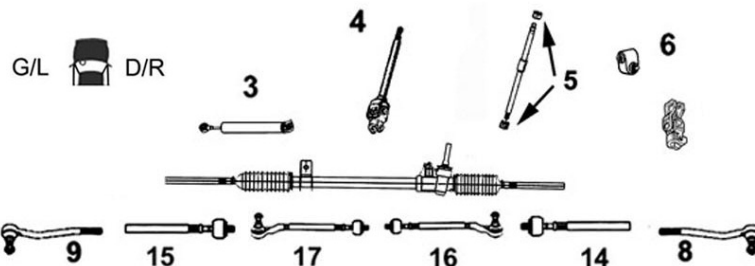

9006201

Axe de bielle G/D

OE 1603453

L/R axial joint



14 Côté dir. M14x1.5
15 Côté rot. M12x1.5 long 322 mm

1.4i 16v. DNA	09/94-09/00
1.6i 16v. DNA	09/94-09/00

9006202

Axe de bielle G/D

OE 322158

L/R axial joint



14 Côté dir. M14x1.5
15 Côté rot. M12x1.5 long 281 mm

1.4i 16v. DA	09/94-09/00
1.6i 16v. DA	09/94-09/00

7776037

Axe de bielle G/D

Part/oe 1603018

L/R axial joint



14 Côté dir. M14x1.5 Côté rot. M12x1.5 long 310 mm
15

1.3 CDTi Twintop	06/04-
1.4i 16v. Twintop	06/04-
1.8i 16v. Twintop	06/04-

9006374

Rotule de direction G/D

OE 1603645

L/R tie rod end



8 M12 x 1.5
9

TT /all models	-ch V3023597
	-ch V4166925 -ch V6066279
	07/94-

9006692

Rotule de direction G/D

OE 1603455

L/R tie rod end



8 M12 x 1.5
9

TT /all models	Ch- V3023598
	Ch- V4166926 Ch- V6066280
	-12/00

... Tigma ...





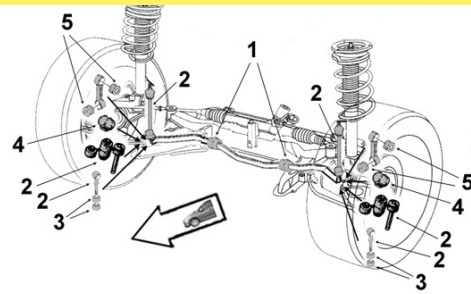

SASIC

OPEL



Barre stabilisatrice
Stabilizer bar
Barra estabilizadora
Drażek stabilizatora
 стабилизатор поперечной устойчивости

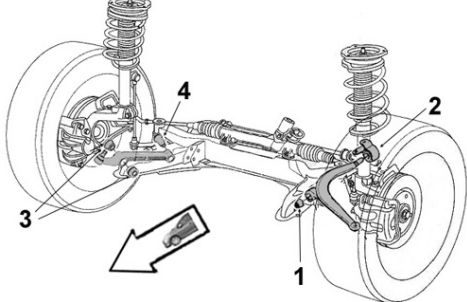

<p>9005014 OE 350610</p> 	<p>Biellette barre stab. <i>Stabilizer bar stub axle</i></p> <p>2</p> <p>1.3 CDTi 03/05- 1.4i 16v. 09/04- 1.8i 16v. 09/04-</p>	<p>2306129 OE 350130</p> <p>NEW</p> 	<p>Palier de barre milieu <i>Middle bar main bearing</i></p> <p>1 Ø 17</p> <p>1.3 CDTi Twintop 03/05- 1.4i 16v. Twintop 09/04- 1.8i 16v. Twintop 09/04-</p>
<p>9001784 OE 350138</p> 	<p>Palier de barre milieu <i>Middle bar main bearing</i></p> <p>1 Barre Ø 22</p> <p>1.3 CDTi 03/05- 1.4i 16v. 09/04- 1.8i 16v. 09/04-</p>	<p>9001509 OE 350127</p> 	<p>Palier de barre milieu <i>Middle bar main bearing</i></p> <p>1 Barre Ø 21.5</p> <p>1.4i 16v. 04/93- 1.6i 16v. 04/93-</p>
<p>9001657 OE 0353282</p> 	<p>Art. tirant de barre <i>Rod bushing</i></p> <p>Ø int.14 Ø ext. 58 coll.62 long. tube int.36 ext.23.5 coll.4.5</p> <p>1.4i 16v. 04/93- 1.6i 16v. 04/93-</p>		
<p>Eléments SUSPENSION <i>Suspension parts</i> <i>Elementos suspensión</i> <i>Elementy zawieszenie</i> Элементы подвески</p>			
<p>9001514 OE 352301</p> 	<p>Articulation int. <i>Inner bush</i></p> <p>4 Ø int.10 Ø ext.37 coll.44 long. tube int.52 ext.28 ep. coll.6</p> <p>1.4i 16v. 09/94-09/00 1.6i 16v. 09/94-09/00</p>	<p>9001775 OE 352320</p> 	<p>Articulation AR <i>Rear bush</i></p> <p>2 Ø int.12.5 Ø ext.60 long. tube int.45.5 ext.27</p> <p>1.3 CDTi Twintop 03/05- 1.4i 16v. Twintop 09/04- 1.8i 16v. Twintop 09/04-</p>

... Tigua ...

Bras & Triangle de suspension

Control arm
Brazo y triángulo
Wahacz
Рычаг подвески

G/L  D/R



9005184 OE 352181	Bras de susp. G <i>Left track control arm</i>	9005183 OE 352002	Bras de susp. D <i>Right track control arm</i>
	4 Sans rotule Without tie rod end TT /all models -ch V3023597 10/94-		3 Sans rotule Without tie rod end TT /all models -ch V3023597 10/94-
9005766 OE 5352011	Bras de susp. G <i>Left track control arm</i>	9005764 OE 5352012	Bras de susp. D <i>Right track control arm</i>
	4 Sans rotule Without tie rod end TT /all models Ch- V3023598 10/94-		3 Sans rotule Without tie rod end TT /all models Ch- V3023598 10/94-
7476130 OE 1603128+352003	Bras de suspension G <i>Left track control arm</i>	7476129 OE 1603187+352002	Bras de suspension D <i>Right track control arm</i>
 NEW	4 Avec rotule With ball joint Ø 15 TT /all models -ch V3023597 10/94-	 NEW	3 Avec rotule With ball joint Ø 15 TT /all models -ch V3023597 10/94-
7476132 OE (2oe)5352011+1603202	Bras de suspension G <i>Left track control arm</i>	7476131 OE (2oe)5352012+1603202	Bras de suspension D <i>Right track control arm</i>
 NEW	4 Avec rotule With ball joint Ø 15 TT /all models Ch- V3023598 10/94-	 NEW	3 Avec rotule With ball joint Ø 15 TT /all models Ch- V3023598 10/94-
9005190 OE 352064	Triangle de suspension G <i>Left track control arm</i>	9005191 OE 352065	Triangle de suspension D <i>Right track control arm</i>
	4 Avec rotule With ball joint 1.3 CDTi 03/05- 1.4i 16v. 09/04- 1.8i 16v. 09/04-		3 Avec rotule With ball joint 1.3 CDTi 03/05- 1.4i 16v. 09/04- 1.8i 16v. 09/04-

OPEL



... Tigrá ...

SASIC

OPEL

Bras & Triangle de suspension

Control arm
Brazo y triángulo
Wahacz
Рычаг подвески

G/L  D/R

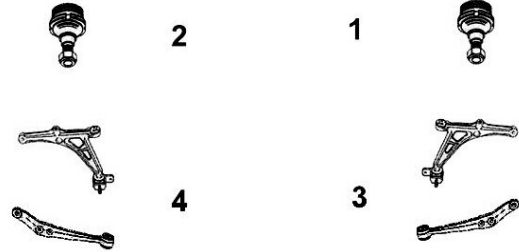

9005252
OE 1603187

Rotule de susp. inf. G/D
L/R lower suspension ball joint



1
2 Ø 15

TT /all models -ch V3023597 10/94-

9005542
OE 1603202

Rotule de susp. inf. G/D
L/R lower suspension ball joint



1
2 Ø 15

TT /all models Ch- V3023598 10/94-

9005541
OE 352803

Rotule de susp. inf. G/D
L/R lower suspension ball joint



1
2

1.3 CDTi
1.4i 16v.
1.8i 16v.

03/05-
09/04-
09/04-



Support d'amortisseur

Suspension mounting
Soporte amortiguador
Poduszka amortyzatora
Опора амортизатора

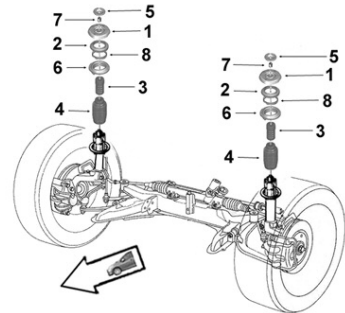

2656012
OE 344523

Support suspension
Suspension mounting



1 **Sans joint incorporé** *Without built attached*

1.3 CDTi Twintop 03/05-
1.4i 16v. Twintop 09/04-
1.8i 16v. Twintop 09/04-

9001687
OE 344519

Support suspension G/D
L/R suspension mounting



1

1.4i 16v. 04/93-
1.6i 16v. 04/93-

8005202
OE 312503

Butée à billes G/D
L/R ball bearing



2 Ø 12 x 130 x 28

1.4i 16v. 04/93-
1.6i 16v. 04/93-

2656063
OE 0312510

Butée à billes G/D
L/R ball bearing



2

TT /all models 09/04-

... Tigra

9005358
OE 344410

Butée de suspension G/D
L/R suspension bush



3

1.4i 16v.
1.6i 16v.

04/93-
04/93-

Eléments TRAIN ARRIERE

Rear axle parts

Tren TRAS

Elementy zawieszenia tylnego

элементы задней оси.



9001654
OE 402643

Articulation essieu AR
Rear axle bush



Ø int.10 Ø ext.41 coll.53 long. tube int.65 ext.44.5 ep. coll.8

1.4i 16v.
1.6i 16v.

04/93-
04/93-

Vectra A ...

Eléments DIRECTION

Steering parts

Elementos Direcciones

Elementy uklad kierowniczy

Элементы рулевой системы

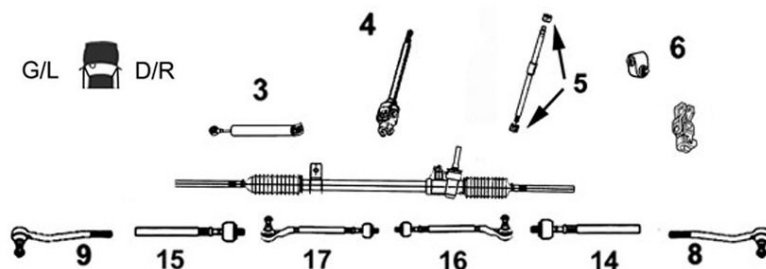

9006204
OE 322147

Axe de bielle G
Left axial joint



15 M16x1.5

TT /all models 09/88-10/95

9006203
OE 322146

Axe de bielle D
Right axial joint



14 M16x1.5

TT /all models 09/88-10/95

9006370
OE 324055

Rotule de direction G
Left tie rod end



9 M16x1.5

TT /all models 09/88-10/95

9006371
OE 324056

Rotule de direction D
Right tie rod end



8 M16x1.5

TT /all models 09/88-10/95

... Vectra A ...



Barre stabilisatrice
Stabilizer bar
Barra estabilizadora
Drażek stabilizatora
 стабилизатор поперечной устойчивости

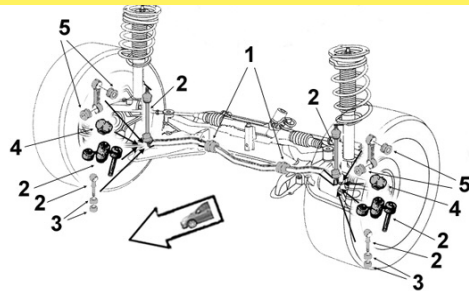

OPEL



9001512
OE 350261

Biellette barre stab.
Stabilizer bar stub axle



2 Barre Ø 18	
1.4	09/88-09/95
1.6	09/88-09/95
1.7 D	09/88-09/95
1.7 TD	09/88-09/95
1.8	09/88-09/95
2.0i	09/88-09/95
2.0i 16v./Turbo	09/88-09/95
2.5i V6 24v.	09/88-09/95

9005077
OE 350263

Biellette barre stab.
Stabilizer bar stub axle



2 Barre Ø 20	
1.4	09/88-09/95
1.6	09/88-09/95
1.7 D	09/88-09/95
1.7 TD	09/88-09/95
1.8	09/88-09/95
2.0i	09/88-09/95
2.0i 16v./Turbo	09/88-09/95
2.5i V6 24v.	09/88-09/95

9001510
OE 350260

Biellette barre stab.
Stabilizer bar stub axle



2 Barre Ø 22	
1.4	09/88-09/95
1.6	09/88-09/95
1.7 D	09/88-09/95
1.7 TD	09/88-09/95
1.8	09/88-09/95
2.0i	09/88-09/95
2.0i 16v. /Turbo	09/88-09/95
2.5i V6 24v.	09/88-09/95

9001529
OE 350153

Liaison élastique
Elastic link



3 Ø int.8.5 Ø ext.30 long. tube int.19.5 ext.17	
1.4	09/88-09/95
1.6	09/88-09/95
1.7 D TD	09/88-09/95
1.8	09/88-09/95
2.0i	09/88-09/95
2.0i 16v. /Turbo	09/88-09/95
2.5i V6 24v.	09/88-09/95

9001659
OE 350078

Palier de barre milieu
Middle bar main bearing



1 Barre Ø 22	
1.4	09/88-09/95
1.6	09/88-09/95
1.7 D	09/88-09/95
1.7 TD	09/88-09/95
1.8	09/88-09/95
2.0i	09/88-09/95
2.0i 16v. /Turbo	09/88-09/95
2.5i V6 24v.	09/88-09/95

9001533
OE 350081

Palier de barre
Bar main bearing



1 Barre Ø 18	
1.7 D	07/92-01/94
2.5i V6 24v.	07/93-06/95



Eléments SUSPENSION
Suspension parts
Elementos suspensión
Elementy zawieszenia
 Элементы подвески

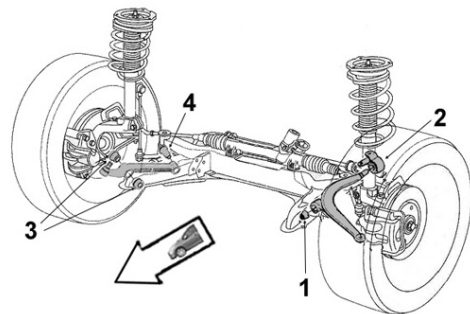

9001513
OE 352300

Articulation AV
Front bush



1 Ø int.12 Ø ext.38 coll.43 long. tube int.59 ext.30 ep. coll.7	
1.4	Ch- L1186119
1.6	Ch- L1186119
1.7 D	Ch- L1186119
1.7 TD	Ch- L1186119
1.8	Ch- L1186119
2.0i sauf GT 16v.	Ch- L1186119
2.0i 16v. GT -ch	L1186118 09/88-09/95
2.5i V6 24v. -ch	L1186118 09/88-09/95

9001513
OE 352300

Articulation AV
Front bush



1 Ø int.12 Ø ext.38 coll.43 long. tube int.59 ext.30 ep. coll.7	
1.4	Ch- L5270763 09/88-09/95
1.6	Ch- L5270763 09/88-09/95
1.7 D TD	Ch- L5270763 09/88-09/95
1.8	Ch- L5270763 09/88-09/95
2.0i sauf GT 16v.	Ch- L5270763 09/88-09/95
2.0i 16v. GT -ch	L5270762 09/88-09/95
2.5i V6 24v. -ch	L5270762 09/88-09/95

... Vectra A ...



Support d'amortisseur
Suspension mounting
Soporte amortiguador
Poduszka amortyzatora
Опора амортизатора

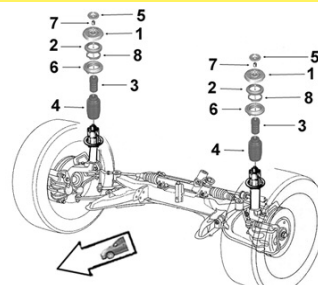

OPEL



9001765 OE 352346	Articulation AV <i>Front bush</i>	9001643 OE 352351	Articulation AV <i>Front bush</i>
	<p>1 Ø int.12 Ø ext.38 coll.43 x2 long. tube int.59.5 ext.28 ep. coll.7x2</p> <p>2.0i BVM BVA 09/88-09/95</p>		<p>1 Ø int.12 Ø ext.39.5 coll.44 long. tube int.59.5 ext.28 ep. coll.7</p> <p>2.0i 16v. 09/88-09/95 2.0i 16v. 4WD Ch- P5004911 09/88-09/95 2.0i 16v. 4WD Ch- P7535972 09/88-09/95</p>

9001516 OE 352348	Articulation AR <i>Rear bush</i>																																						
	<p>2 Ø int.16 Ø ext.60 coll.66.5 long. tube int.58 ext.24 ep. coll.3</p> <table border="0"> <tr> <td>1.4</td> <td>Ch- L1186119</td> <td>1.4</td> <td>-ch R7540515</td> <td>Ch L5270763-R5112256</td> <td>09/88-09/95</td> </tr> <tr> <td>1.6i</td> <td>Ch- L1186119</td> <td>1.6i</td> <td>-ch R7540515</td> <td>Ch L5270763-R5112256</td> <td>09/88-09/95</td> </tr> <tr> <td>1.7 D</td> <td>Ch- L1186119</td> <td>1.7 D</td> <td>-ch R7540515</td> <td>Ch L5270763-R5112256</td> <td>09/88-09/95</td> </tr> <tr> <td>1.7 TD</td> <td>Ch- L1186119</td> <td>1.7 TD</td> <td>-ch R7540515</td> <td>Ch L5270763-R5112256</td> <td>09/88-09/95</td> </tr> <tr> <td>1.8i</td> <td>Ch- L1186119</td> <td>1.8i</td> <td>-ch R7540515</td> <td>Ch L5270763-R5112256</td> <td>09/88-09/95</td> </tr> <tr> <td>2.0i</td> <td></td> <td></td> <td>-ch R1049314</td> <td>Ch L5270763-R5112256</td> <td>09/88-09/95</td> </tr> </table>			1.4	Ch- L1186119	1.4	-ch R7540515	Ch L5270763-R5112256	09/88-09/95	1.6i	Ch- L1186119	1.6i	-ch R7540515	Ch L5270763-R5112256	09/88-09/95	1.7 D	Ch- L1186119	1.7 D	-ch R7540515	Ch L5270763-R5112256	09/88-09/95	1.7 TD	Ch- L1186119	1.7 TD	-ch R7540515	Ch L5270763-R5112256	09/88-09/95	1.8i	Ch- L1186119	1.8i	-ch R7540515	Ch L5270763-R5112256	09/88-09/95	2.0i			-ch R1049314	Ch L5270763-R5112256	09/88-09/95
1.4	Ch- L1186119	1.4	-ch R7540515	Ch L5270763-R5112256	09/88-09/95																																		
1.6i	Ch- L1186119	1.6i	-ch R7540515	Ch L5270763-R5112256	09/88-09/95																																		
1.7 D	Ch- L1186119	1.7 D	-ch R7540515	Ch L5270763-R5112256	09/88-09/95																																		
1.7 TD	Ch- L1186119	1.7 TD	-ch R7540515	Ch L5270763-R5112256	09/88-09/95																																		
1.8i	Ch- L1186119	1.8i	-ch R7540515	Ch L5270763-R5112256	09/88-09/95																																		
2.0i			-ch R1049314	Ch L5270763-R5112256	09/88-09/95																																		

9001648 OE 352356	Articulation AR <i>Rear bush</i>	9001652 OE 352352	Articulation AR <i>Rear bush</i>																																																
	<p>2 Ø int.16 Ø ext.60 coll.67.5 long. tube int.58 ext.24 ep. coll.3</p> <table border="0"> <tr> <td>1.4</td> <td>Ch R5112257-R7540516</td> <td></td> <td></td> </tr> <tr> <td>1.6i</td> <td>Ch R5112257-R7540516</td> <td></td> <td></td> </tr> <tr> <td>1.7 D TD</td> <td>Ch R5112257-R7540516</td> <td></td> <td></td> </tr> <tr> <td>1.8i</td> <td>Ch R5112257-R7540516</td> <td></td> <td></td> </tr> <tr> <td>2.0i 16v. 4WD</td> <td></td> <td></td> <td>09/88-09/95</td> </tr> <tr> <td>2.0i 16v. GT</td> <td></td> <td></td> <td>09/88-09/95</td> </tr> </table>	1.4	Ch R5112257-R7540516			1.6i	Ch R5112257-R7540516			1.7 D TD	Ch R5112257-R7540516			1.8i	Ch R5112257-R7540516			2.0i 16v. 4WD			09/88-09/95	2.0i 16v. GT			09/88-09/95		<p>2 Ø int.16 Ø ext.60 coll.67 long. tube int.58 ext.24 ep. coll.3</p> <table border="0"> <tr> <td>2.0i 16v.</td> <td>Ch P1001687-P5004911</td> <td></td> <td></td> </tr> <tr> <td></td> <td></td> <td></td> <td>09/88-09/95</td> </tr> <tr> <td>2.0i 16v.</td> <td>Ch P7535972-R7540515</td> <td></td> <td></td> </tr> <tr> <td></td> <td></td> <td></td> <td>09/88-09/95</td> </tr> <tr> <td>2.0i 16v.</td> <td>Ch P5004911-R5112256</td> <td></td> <td></td> </tr> <tr> <td></td> <td></td> <td></td> <td>09/88-09/95</td> </tr> </table>	2.0i 16v.	Ch P1001687-P5004911						09/88-09/95	2.0i 16v.	Ch P7535972-R7540515						09/88-09/95	2.0i 16v.	Ch P5004911-R5112256						09/88-09/95
1.4	Ch R5112257-R7540516																																																		
1.6i	Ch R5112257-R7540516																																																		
1.7 D TD	Ch R5112257-R7540516																																																		
1.8i	Ch R5112257-R7540516																																																		
2.0i 16v. 4WD			09/88-09/95																																																
2.0i 16v. GT			09/88-09/95																																																
2.0i 16v.	Ch P1001687-P5004911																																																		
			09/88-09/95																																																
2.0i 16v.	Ch P7535972-R7540515																																																		
			09/88-09/95																																																
2.0i 16v.	Ch P5004911-R5112256																																																		
			09/88-09/95																																																

Bras & Triangle de suspension

Control arm
Brazo y triángulo
Wahacz
Рычаг подвески

G/L D/R

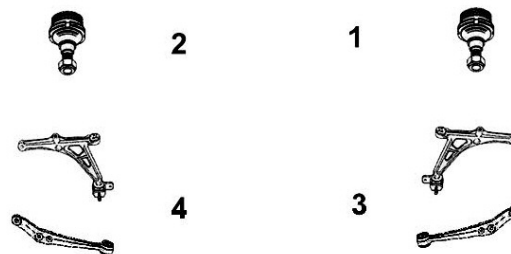

9005189 OE 352193	Triangle de susp. G <i>Left track control arm</i>	9005188 OE 5352000	Triangle de susp. D <i>Right track control arm</i>
	<p>4 Avec rotule <i>With ball joint</i></p> <p>TT /all models Sauf 4WD 09/88-10/95</p>		<p>3 Avec rotule <i>With ball joint</i></p> <p>TT /all models Sauf 4WD 09/88-10/95</p>

... Vectra A ...

SASIC

OPEL

Bras & Triangle de suspension

Control arm
Brazo y triángulo
Wahacz
Рычаг подвески

G/L  D/R

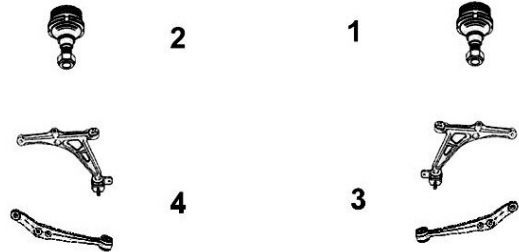

9005250

Rotule de susp. inf. G/D

OE 1603167

L/R lower suspension ball joint



1
2

TT /all models Sauf 2.5 V6 24v. mot. C25XE

09/88-10/95



Support d'amortisseur

Suspension mounting
Soporte amortiguador
Poduszka amortyzatora
Опора амортизатора

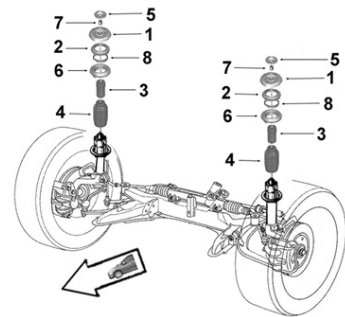

9005608

Support suspension G/D

OE 344514

L/R suspension mounting



1

1.4	09/88-09/95
1.6	09/88-09/95
1.7 D	09/88-09/95
1.7 TD	09/88-09/95
1.8	09/88-09/95
2.0i	09/88-09/95
2.5i V6 24v.	09/88-09/95

9005607

Support suspension G/D

OE 344513

L/R suspension mounting



1

2.0i 16v.

09/88-09/95

8005203

Butée à billes G/D

OE 344516

L/R ball bearing



2

Ø 16.1 x 41 x 11

1.4	09/88-09/95
1.6	09/88-09/95
1.7 D	09/88-09/95
1.7 TD	09/88-09/95
1.8	09/88-09/95
2.0i	09/88-09/95
2.0i 16v.	09/88-09/95
2.5i V6 24v.	09/88-09/95

9005359

Butée de suspension G/D

OE 344411

L/R suspension bush



3

H67

1.4	09/88-09/95
1.6	09/88-09/95
1.7 D	09/88-09/95
1.7 TD	09/88-09/95
1.8	09/88-09/95
2.0i	09/88-09/95
2.0i 16v.	09/88-09/95
2.5i V6 24v.	09/88-09/95

... Vectra A

Eléments TRAIN ARRIERE

Rear axle parts

Tren TRAS

Elementy zawieszenia tylnego

элементы задней оси.



OPEL



9001653

Articulation essieu AR

OE 402642

Rear axle bush



Ø int.12 Ø ext.48 coll.57 long. tube int.75 ext.62 ep. coll.7

-ch NV299999 -ch N1999999 -ch N5999999

1.4
1.6
1.7 D /TD
1.8 sauf 4WD
2.0i 16v. sauf 4WD
2.0i Sauf 4WD
2.5i V6 24v.

9001655

Articulation essieu AR

OE 402645

Rear axle bush



Ø int.12 Ø ext.59 coll.65.5 long. tube int.75 ext.62 ep. coll.7

Ch- P1000001 Ch- P5000001 Ch- P7000001

1.4
1.6
1.7 D /TD
1.8 sauf 4WD
2.0i/ 16v. sauf 4WD
2.5i V6 24v.

9001769

Articulation essieu AR

OE 402935

Rear axle bush



Ø int.19 Ø ext.96 coll.120
long. tube int.79 ext.44 ep. Coll.14

Ch K1000001-L1095238

2.0i /4WD
2.0i 16v. 4WD
2.0i 16v. Turbo 4WD

9001663

Articulation essieu AR

OE 402937

Rear axle bush



Ø int.19 Ø ext.96 coll.120
long. tube int.72 ext.76 ep. Coll.12

Ch-L1/ L5/LV095239

2.0i/4WD
2.0i 16v. 4WD
2.0i 16v. Turbo 4WD

Vectra B ...

Eléments DIRECTION

Steering parts

Elementos Direcciones

Elementy uklad kierowniczy

Элементы рулевой системы

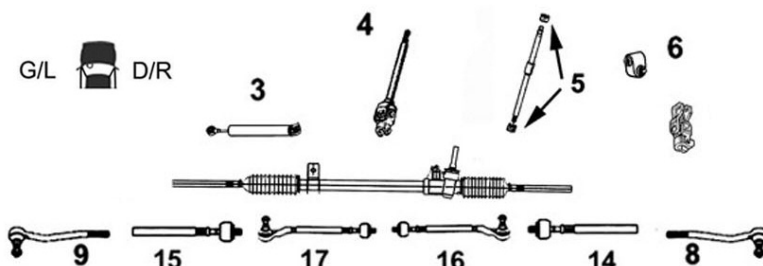

9006857

Axe de bielle G/D

Part/oe 1603199

L/R axial joint



14 Côté dir. M16x1.5
15 Côté rot. M14x1.5 long 347 mm

TT /all models Dir. Saginaw 01/96-
TT /all models Dir. ZF 01/96-

9006561

Rotule de direction G/D

OE 1603286

L/R tie rod end



8
9 M14 x 1.5

TT /all models 01/96-

... Vectra B ...



Barre stabilisatrice
 Stabilizer bar
 Barra estabilizadora
 Drażek stabilizatora
 стабилизатор поперечной устойчивости

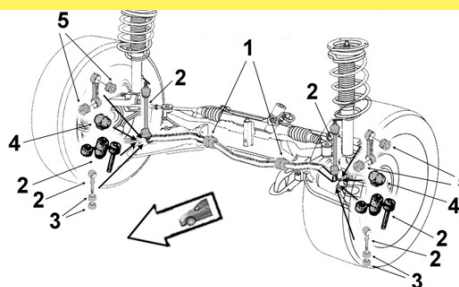

9005014

Biellette barre stab.

OE 350610

Stabilizer bar stub axle



2

1.6i 16v.	10/95-
1.7 TD	10/95-
1.8i 16v.	10/95-
2.0i 16v.	10/95-
2.0 Di DTi 16v.	10/95-
2.2i 16v.	10/95-
2.2 DTi 16v.	10/95-
2.5i V6 24v.	10/95-
2.6i V6 24v.	09/00-05/01

2306129

Palier de barre milieu

OE 350130

Middle bar main bearing

NEW

1 Ø 17



1.6i 16v.	Ch -W1/5/7999999				01/97-02/99
1.7 TD					11/95-12/96
1.8i 16v.	Ch -W1/5/7999999	Ch -XL999999			08/97-09/00
	Ch -X1999999	Ch -X7999999			02/99-09/00
2.0i 16v.	Ch -W1999999	Ch -W5999999	Ch -W7999999	Ch -XL999999	11/95-09/00
2.0 Di 16v.	Ch -W1999999	Ch -W5999999	Ch -W7999999	Ch -XL999999	01/97-09/00
2.0 DTi 16v.	Ch -W1999999	Ch -W5999999	Ch -W7999999	Ch -XL999999	08/97-06/00
2.0 DTi 16v.	Ch -X1999999	Ch -X7999999			02/99-06/00
2.2i 16v.	Ch -W1999999	Ch -W5999999	Ch -W7999999	Ch -XL999999	09/00-06/02
2.2 DTi	Ch -W1999999	Ch -W5999999	Ch -W7999999	Ch -XL999999	09/00-06/02
2.5i V6 24v.	Ch -W1999999	Ch -W5999999	Ch -W7999999	Ch -XL999999	11/95-09/00
2.6i V6 24v.	Ch -W1999999	Ch -W5999999	Ch -W7999999	Ch -XL999999	09/00-05/01



Eléments SUSPENSION

Suspension parts
Elementos suspensión
Elementy zawieszenie
Элементы подвески

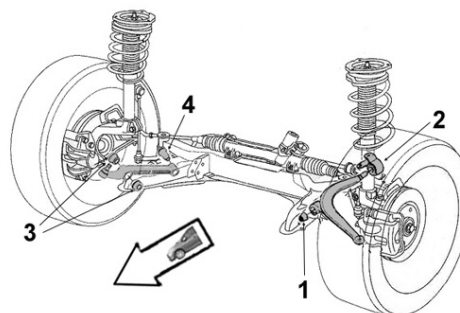

9001645

Articulation AV

OE 352357

Front bush



1

Ø int.12 Ø ext.36 coll.42.5
 long. tube int.59.5 ext.34 ep. coll.8

1.6i 16v.	10/95-
1.7 TD	10/95-
1.8i 16v.	10/95-
2.0i 16v.	10/95-
2.0 DI DTi 16v.	10/95-
2.2i 16v.	10/95-
2.2 DTi 16v.	10/95-
2.5i V6 24v.	10/95-
2.6i V6 24v.	10/95-

9001638

Articulation AR

OE 352358

Rear bush



2

Ø int.12 Ø ext.47.5 coll.61
 long. tube int.60 ext.44 ep. coll.9

1.6i 16v.	10/95-
1.7 TD	10/95-
1.8i 16v.	10/95-
2.0i 16v.	10/95-
2.0 DI DTi 16v.	10/95-
2.2i 16v.	10/95-
2.2 DTi 16v.	10/95-
2.5i V6 24v.	10/95-
2.6i V6 24v.	10/95-

... Vectra B ...

Bras & Triangle de suspension

Control arm
Brazo y triángulo
Wahacz
Рычаг подвески

G/L  D/R



9005256

OE 352800

Rotule de susp. inf. G/D

L/R lower suspension ball joint



1
2

TT /all models

01/96-



Support d'amortisseur

Suspension mounting
Soporte amortiguador
Poduszka amortyzatora
Опора амортизатора

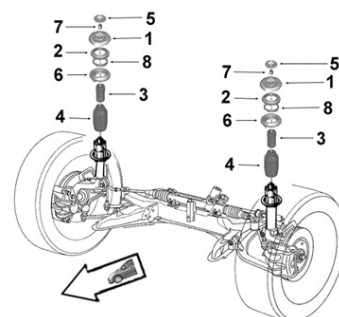

2656012

OE 344523

Support suspension

Suspension mounting



1 Sans joint incorporé Without built attached

1.6i 16v.	11/95-
1.7 TD	11/95-
1.8i 16v.	08/97-

9001688

OE 344525

Support suspension G/D

L/R suspension mounting



1 Avec joint incorporé With built attached

2.0i 16v.	10/95-
2.0 Di 16v.	01/97-
2.0 DTi 16v.	10/95-
2.2i 16v.	10/95-
2.2 DTi 16v.	09/00-
2.5i V6 24v.	10/95-
2.6i V6 24v.	09/00-

2656063

OE 0312510

Butée à billes G/D

L/R ball bearing

NEW



2

TT /all models

9005360

OE 344417

Butée de suspension

Shock bush



3

H63	
1.6i 16v.	10/95-
1.7 TD	10/95-
1.8i 16v.	10/95-
2.0i 16v.	01/97-
2.0 Di DTi 16v.	08/97-
2.2i 16v.	10/95-
2.2 DTi 16v.	09/00-
2.5i V6 24v.	01/97-
2.6i V6 24v.	09/00-

... Vectra B

Eléments TRAIN ARRIERE

Rear axle parts

Tren TRAS

Elementy zawieszenia tylnego

элементы задней оси.



SASIC

OPEL

9001644

Articulation AV

OE 423302

Front bush



Ø int.13 Ø ext.60 coll.75.5
long. tube int.55.5 ext.31 ep. coll.18
1.6i 16v. 10/95-
1.7 TD 10/95-
1.8i 16v. 10/95-
2.0i 16v. 10/95-
2.0 DI DTi 16v. 10/95-
2.2i 16v. 10/95-
2.2 DTi 16v. 10/95-
2.5i V6 24v. 10/95-
2.6i V6 24v. 10/95-

9001637

Articulation AR

OE 423121

Rear bush



Ø int.12 Ø ext.45 long. tube int.52 ext.24
1.6i 16v. 10/95-
1.7 TD 10/95-
1.8i 16v. 10/95-
2.0i 16v. 10/95-
2.0 DI DTi 16v. 10/95-
2.2i 16v. 10/95-
2.2 DTi 16v. 10/95-
2.5i V6 24v. 10/95-
2.6i V6 24v. 10/95-

9001744

Articulation essieu AR

OE 5402631

Rear axle bush



Ø int.14 Ø ext.63.5 coll.81.5 long. tube int.60 ext.45 ep. coll.10.5
1.6i 16v. 10/95-
1.7 TD 10/95-
1.8i 16v. 10/95-
2.0i 16v. 10/95-
2.0 Di DTi 16v. 10/95-
2.2i 16v. 10/95-
2.2 DTi 16v. 10/95-
2.5i V6 24v. 10/95-

Vectra C ...

Eléments DIRECTION

Steering parts

Elementos Direcciones

Elementy uklad kierowniczy

Элементы рулевой системы

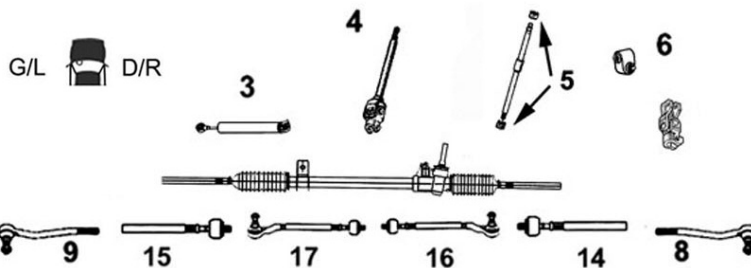

7776041

Axe de bielle G/D

Part/oe 1603229

L/R axial joint



14 Côté dir. M18x1.5 Côté rot. M14x1.5 long 285 mm

15

Sauf châssis sport ch- 31032140 ch- 3804065

1.6i 16v. 06/04-
1.8i 16v. 04/02-
1.9 CDTi 04/04-
2.0i 16v. Turbo 03/03-
2.0 DTi 16v. 04/02-
2.2i 16v. / DTi 04/02-
2.8i Turbo 08/06-
3.0 CDTi 06/03-
3.2i V6 24v. 08/02-

... Vectra C ...

OPEL



7776059

Axe de bielle G/D

Part/oe 1609050

L/R axial joint

NEW

14 Côté dir. M18x1.5 Côté rot. M14x1.5 long 285 mm
15 Jante 15/16/17 Pouces



1.8i 16v.	Ch-31032141 Ch-38040656	09/02-08/08
1.8i 16v. GTS	Ch-31032141 Ch-38040656	09/02-10/05
1.9 CDTi	Ch-31032141 Ch-38040656	03/04-08/08
1.9 CDTi GTS	Ch-31032141 Ch-38040656	03/04-10/05
2.0i 16v. Turbo		12/03-10/05
2.0i 16v. Turbo GTS	Châssis sport Ch-31032141 Ch-38040656	08/03-10/05
2.0 DTi 16v		12/03-10/05
2.2i 16v.	Ch-31032141 Ch-38040656	03/04-08/08
2.2i 16v. GTS	Châssis sport Ch-31032141 Ch-38040656	09/02-10/05
2.2 DTi		12/03-07/04
2.2 DTi GTS	Châssis sport Ch-31032141 Ch-38040656	09/02-10/05
2.8i Turbo OPC	Châssis sport Ch-31032141 Ch-38040656	10/05-08/08
2.8i Turbo OPC		10/05-08/08
3.0 CDTi	Ch-31032141 Ch-38040656	12/03-08/08
3.0 CDTi GTS	Châssis sport Ch-31032141 Ch-38040656	08/03-10/05
3.2i V6 24v. GTS	Châssis sport Ch-31032141 Ch-38040656	09/02-10/05

9006558

Rotule de direction G

OE 1603227

Left tie rod end



9 M14 x 1.5
 1.8i 16v.
 1.9 CDTi
 2.0i 16v. Turbo/DTi 16v.
 2.2i 16v.
 2.2 DTi
 2.8i Turbo OPC
 3.0 CDTi
 3.2i V6 24v.

9006557

Rotule de direction D

OE 1603228

Right tie rod end



8 M14 x 1.5
 1.8i 16v.
 1.9 CDTi
 2.0i 16v. Turbo/DTi 16v.
 2.2i 16v.
 2.2 DTi
 2.8i Turbo OPC
 3.0 CDTi
 3.2i V6 24v.



Barre stabilisatrice

Stabilizer bar

Barra estabilizadora

Drażek stabilizatora

стабилизатор поперечной устойчивости

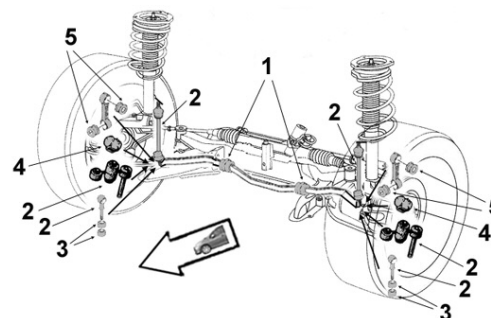

2306052

Biellette barre stab.

OE 350615

Stabilizer bar stub axle



2 Sauf Ids +
 1.8i 16v.
 1.9 CDTi
 2.0i 16v. Turbo
 2.0 DTi 16v.
 2.2i 16v.
 2.2 DTi
 2.8i Turbo OPC
 3.0 CDTi
 3.0 CDTi FAP
 3.2i V6 24v.

... Vectra C ...

SASIC

OPEL



Eléments SUSPENSION
Suspension parts
Elementos suspensión
Elementy zawieszenie
Элементы подвески

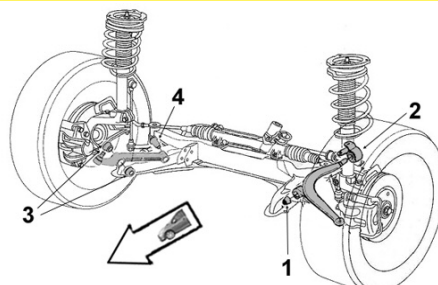

9003116

Articulation AR

OE 352319

Rear bush



2

1.8i 16v.
 1.9 CDTi
 2.0i 16v. Turbo
 2.0 DTi 16v.
 2.2i 16v.
 2.2 DTi
 2.8i Turbo OPC
 3.0 CDTi /FAP
 3.2i V6 24v.

01/02-
 03/04-
 08/03-
 01/02-
 01/02-
 01/02-
 01/02-
 10/05-08/08
 08/03-08/08
 09/02-10/05

Bras & Triangle de suspension

Control arm
Brazo y triángulo
Wahacz
Рычаг подвески

G/L D/R



7476077

Triangle de susp. G

OE 352051

Left track control arm



4

Avec rotule With ball joint
Sauf OPC VXR
 1.6i 16v.
 1.8i 16v.
 1.9 CDTi
 2.0i 16v. Turbo
 2.0 DTi 16v.
 2.2i 16v. /DTi
 2.8i V6 Turbo
 3.0 CDTi
 3.2i V6 24v.

7476075

Triangle de susp. D

OE 352052

Right track control arm



3

Avec rotule With ball joint
Sauf OPC VXR
 1.6i 16v.
 1.8i 16v.
 1.9 CDTi
 2.0i 16v. Turbo
 2.0 DTi 16v.
 2.2i 16v. /DTi
 2.8i V6 Turbo
 3.0 CDTi
 3.2i V6 24v.



Support d'amortisseur

Suspension mounting
Soporte amortiguador
Poduszka amortyzatora
Опора амортизатора

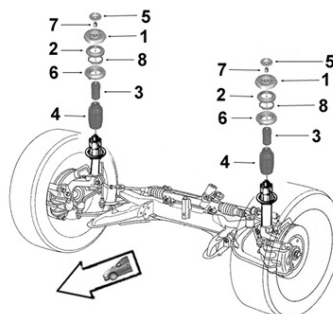

2656013

Butée de suspension

OE 344349

Shock bush



3

H50
 1.8i 16v.
 1.9 CDTi
 2.0i 16v. Turbo
 2.0 DTi 16v.
 2.2i 16v.
 2.2 DTi
 2.8i Turbo OPC
 3.0 CDTi
 3.2i V6 24v.

06/02-08/08
 03/04-08/08
 08/03-10/05
 06/02-10/05
 06/02-08/08
 06/02-10/05
 10/05-08/08
 08/03-08/08
 09/02-10/05

... Vectra C



Barre stabilisatrice
 Stabilizer bar
 Barra estabilizadora
 Drażek stabilizatora
 стабилизатор поперечной устойчивости

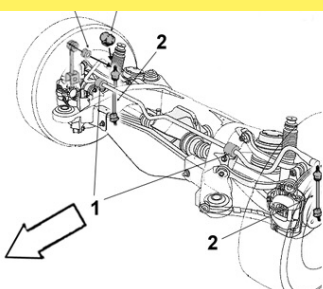

2306053

OE 444275

Biellette barre stab.

Stabilizer bar stub axle



2 Sauf Ids +

1.8i 16v.
 1.9 CDTi
 2.0i 16v. Turbo /DTi 16v.
 2.2i 16v. /DTi
 2.8i Turbo OPC
 3.0 CDTi
 3.2i V6 24v.

Zafira ...

Éléments DIRECTION
 Steering parts
 Elementos Direcciones
 Elementy układ kierowniczy
 Элементы рулевой системы

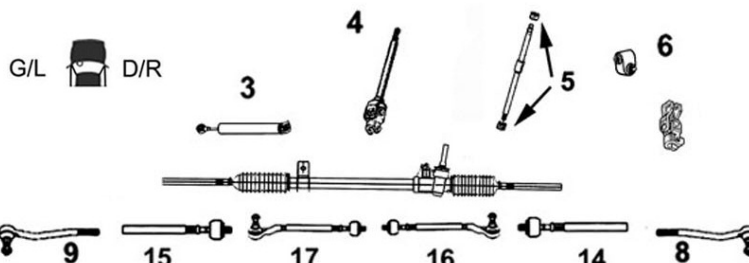

9006855

Axe de bielle G/D

OE 1603302

L/R axial joint



14 Côté dir. M18x1.5 Côté rot. M14x1.5
15 long 285 mm
 Dir. TRW /Delphi

1.6i 16v.	-06/05
1.8i 16v.	-06/05
2.0 Di DTi 16v.	-06/05
2.2i 16v.	-06/05
2.2 DTi 16v.	-06/05

7776042

Axe de bielle G/D

OE 1603358

L/R axial joint



14 ZF Côté dir. M16x1.5
15 Côté rot. M14x1.5 long 277 mm
 Jante 15 /16 /17 Pouces

1.6i 16v.	07/05-
1.7 CDTi	01/08-
1.8i 16v.	07/05-
1.9 CDTi	07/05-
2.0i 16v. Turbo /OPC	07/05-
2.2i 16v.	07/05-

7776060

Axe de bielle G/D

OE 1603359

L/R axial joint



14 Côté dir. M16x1.5
15 Côté rot. M14x1.5 long 279 mm
 Jante 18 pouces

1.6i 16v. /GNV	07/05-
1.6i Turbo GNV	01/06-
1.7 CDTi	01/08-
1.8	07/05-
1.9 CDTi	07/05-
2.0i 16v. Turbo	07/05-
2.2i 16v.	07/05-

7776072

Axe de bielle G/D

OE 1603642

L/R axial joint



14 Côté dir. M18x1.5 Côté rot. M14x1.5
15 long 278 mm
 Ch- 72095157 7G066982

1.6i 16v.	07/05-10/11
1.7 CDTi FAP	01/08-10/11
1.8i 16v.	07/05-10/11
1.9 CDTi	07/05-10/11
2.0i 16v. Turbo /OPC	07/05-10/11
2.2i 16v.	07/05-12/07

7776089

Axe de bielle G/D

OE 1609184

L/R axial joint



14 Côté dir. M16x1.5 Côté rot. M16x1.5 long 310 mm
15

1.4i Turbo	11/11-
1.6i Turbo GNV 150	01/12-
1.8i	11/11-
2.0 CDTi FAP	11/11-

9006691

Rotule de direction G/D

OE 1603215

L/R tie rod end



8 M14 x 1.5
9 Dir. Delphi TRW

1.6i 16v.	-06/05
1.8i 16v.	-06/05
2.0i 16v. Turbo	-06/05
2.0 Di DTi 16v.	-06/05
2.2i 16v.	-06/05
2.2 DTi 16v.	-06/05

... Zafira ...

Eléments DIRECTION

Steering parts

Elementos Direcciones

Elementy uklad kierowniczy

Элементы рулевой системы

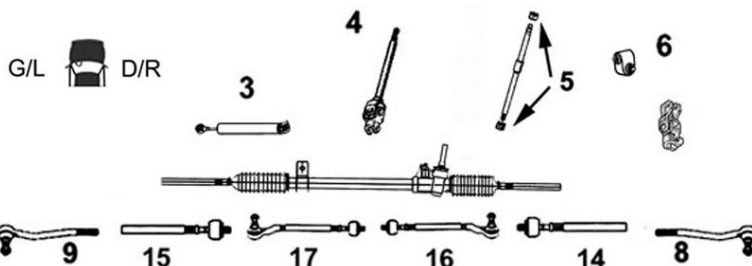

9006564

Rotule de direction G

OE 1603289

Left tie rod end



9

M14 x 1.5

1.6i 16v.	07/05-
1.7 CDTi	01/08-
1.8i 16v.	07/05-
1.9 CDTi	07/05-
2.0i 16v. Turbo /OPC	07/05-
2.2i 16v.	07/05-12/07

9006563

Rotule de direction D

OE 1603288

Right tie rod end



8

M14 x 1.5

1.6i 16v.	07/05-
1.7 CDTi	01/08-
1.8i 16v.	07/05-
1.9 CDTi	07/05-
2.0i 16v. Turbo /OPC	07/05-
2.2i 16v.	07/05-12/07

7676069

Rotule de direction G/D

OE 1609026

L/R tie rod end

NEW



8

M16 x 1.5

9

DA Electrique

1.4i Turbo / GPL	11/11-
1.6i Turbo GNV 150	11/11-
1.8i	11/11-
2.0 CDTi FAP	11/11-



Barre stabilisatrice

Stabilizer bar

Barra estabilizadora

Drażek stabilizatora

стабилизатор поперечной устойчивости

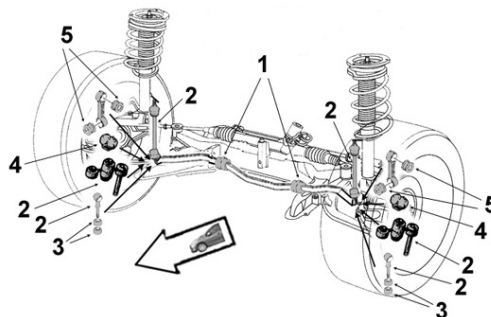

9005016

Biellette barre stab.

OE 350614

Stabilizer bar stub axle



2

1.6i 16v. /GNV	01/99-
1.7 CDTi FAP	01/08-
1.8i 16v.	01/99-
1.9 CDTi	07/05-
2.0i 16v. Turbo	01/02-12/07
2.0 Di 16v.	01/99-05/00
2.0 DTi 16v.	01/99-07/05
2.2i 16v.	01/99-
2.2 DTi 16v.	07/03-07/05

2306051

Biellette barre stab.

OE 350613

Stabilizer bar stub axle



2

Systeme IDS

1.6i 16v.	07/05-12/07
1.7 CDTi FAP	01/08-
1.8i 16v.	07/05-
1.9 CDTi FAP	07/05-
2.0i 16v. Turbo	07/05-
2.2i 16v.	07/05-12/07

2306140

Biellette barre stab.

OE 350618

Stabilizer bar stub axle

NEW



2

1.4i Turbo 120hp 88kw 140hp 103kw	11/11-
1.6i Turbo GNV 150 150hp 110kw	01/12-
1.8 115hp 85kw 140hp 103kw	11/11-
2.0 CDTi FAP 110hp 81kw 130hp 96kw 165hp 121kw	11/11-

... Zafira ...





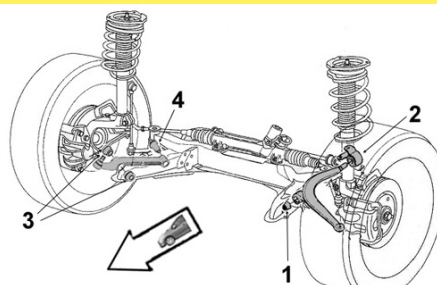



Eléments SUSPENSION
Suspension parts
Elementos suspensión
Elementy zawieszenie
Элементы подвески







OPEL



9001649 OE 352364	Articulation AV <i>Front bush</i>	9001640 OE 352365	Articulation AR <i>Rear bush</i>
	1 Ø int.12 Ø ext.36 coll.42.5 long. tube int.59.5 ext.34 ep. coll.8 1.6i 16v. 01/99-07/05 1.7 CDTi 01/08-07/05 1.8i 16v. 01/99-07/05 1.9 CDTi 07/05-07/05 2.0 16v. Turbo 01/02-07/05 2.0 DI DTi 16v. 01/99-07/05 2.2i 16v. 01/99-07/05 2.2 DTi 16v. 07/03-07/05		2 Ø int.12 Ø ext.47.5 coll.61 long. tube int.60 ext.44 ep. coll.9 1.6i 16v. 01/99-07/05 1.8i 16v. 01/99-07/05 2.0 DI 16v. 01/99-07/05 2.0 DTi 16v. 01/99-07/05 2.2i 16v. 01/99-07/05 2.2 DTi 16v. 07/03-07/05

Bras & Triangle de suspension <i>Control arm</i> <i>Brazo y triángulo</i> <i>Wahacz</i> <i>Рычаг подвески</i>	G/L  D/R	 2	 1
		 4	 3

9005192 OE 5352016	Triangle de suspension G <i>Left track control arm</i>	9005193 OE 5352017	Triangle de suspension D <i>Right track control arm</i>
	4 Avec rotule With ball joint -ch 42125089 -ch4G00000 1.6i 16v. 1.8i 16v. 04/99- 2.0 Di 16v. 04/99- 2.0 DTi 16v. 04/99- 2.2i 16v. 04/99- 2.2 DTi 16v. 04/99-		3 Avec rotule With ball joint -ch 42125089 -ch4G00000 1.6i 16v. 1.8i 16v. 04/99- 2.0 Di 16v. 04/99- 2.0 DTi 16v. 04/99- 2.2i 16v. 04/99- 2.2 DTi 16v. 04/99-

7476072 OE 5352029	Triangle de susp. G <i>Left track control arm</i>	7476071 OE 5352030	Triangle de susp. D <i>Right track control arm</i>
	4 Avec rotule With ball joint Ch-4212590 Ch-4G000001 1.6i 16v. 1.7 CDTi 01/08- 1.8i 16v. 1.9 CDTi 07/05- 2.0i 16v. Turbo 2.0 Di 16v. -05/00 2.0 DTi 16v. -07/05 2.2i 16v. 2.2 DTi 16v. -07/05		3 Avec rotule With ball joint Ch-4212590 Ch-4G000001 1.6i 16v. 1.7 CDTi 01/08- 1.8i 16v. 1.9 CDTi 07/05- 2.0i 16v. Turbo 2.0 Di 16v. -05/00 2.0 DTi 16v. -07/05 2.2i 16v. 2.2 DTi 16v. -07/05

9005256 OE 352830	Rotule de susp. inf. G/D <i>L/R lower suspension ball joint</i>		
	1 1.6i 16v. 2 1.7 CDTi 1.8i 16v. 1.9 CDTi 2.0i 16v. Turbo /OPC 2.0 Di 16v. 2.0 DTi 16v. 2.2i 16v. 2.2 DTi 16v.		01/08- 07/05- 01/02-

... Zafira ...

SASIC







OPEL

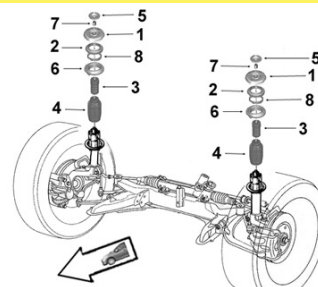

Support d'amortisseur

Suspension mounting
Soporte amortiguador
Poduszka amortyzatora
Опора амортизатора



9001688 OE 344525	Support suspension G/D <i>L/R suspension mounting</i>	2656012 OE 344523	Support suspension <i>Suspension mounting</i>																										
	1 Avec joint incorporé <i>With built attached</i>		1 Sans joint incorporé <i>Without built attached</i>																										
	<table border="0"> <tr><td>1.6i 16v.</td><td>01/99-07/05</td></tr> <tr><td>1.8i 16v.</td><td>01/99-07/05</td></tr> <tr><td>2.0 DI 16v.</td><td>01/99-07/05</td></tr> <tr><td>2.0 DTi 16v.</td><td>01/99-07/05</td></tr> <tr><td>2.2i 16v.</td><td>01/99-07/05</td></tr> <tr><td>2.2 DTi 16v.</td><td>07/03-07/05</td></tr> </table>	1.6i 16v.	01/99-07/05	1.8i 16v.	01/99-07/05	2.0 DI 16v.	01/99-07/05	2.0 DTi 16v.	01/99-07/05	2.2i 16v.	01/99-07/05	2.2 DTi 16v.	07/03-07/05		<table border="0"> <tr><td>1.6i 16v.</td><td>03/99-07/05</td></tr> <tr><td>1.8i 16v.</td><td>03/99-07/05</td></tr> <tr><td>2.0i 16v. Turbo</td><td>01/02-07/05</td></tr> <tr><td>2.0 Di 16v.</td><td>10/99-05/00</td></tr> <tr><td>2.0 DTi 16v.</td><td>05/00-07/05</td></tr> <tr><td>2.2i 16v.</td><td>05/00-07/05</td></tr> <tr><td>2.2 DTi 16v.</td><td>01/02-07/05</td></tr> </table>	1.6i 16v.	03/99-07/05	1.8i 16v.	03/99-07/05	2.0i 16v. Turbo	01/02-07/05	2.0 Di 16v.	10/99-05/00	2.0 DTi 16v.	05/00-07/05	2.2i 16v.	05/00-07/05	2.2 DTi 16v.	01/02-07/05
1.6i 16v.	01/99-07/05																												
1.8i 16v.	01/99-07/05																												
2.0 DI 16v.	01/99-07/05																												
2.0 DTi 16v.	01/99-07/05																												
2.2i 16v.	01/99-07/05																												
2.2 DTi 16v.	07/03-07/05																												
1.6i 16v.	03/99-07/05																												
1.8i 16v.	03/99-07/05																												
2.0i 16v. Turbo	01/02-07/05																												
2.0 Di 16v.	10/99-05/00																												
2.0 DTi 16v.	05/00-07/05																												
2.2i 16v.	05/00-07/05																												
2.2 DTi 16v.	01/02-07/05																												
2656021 OE 344544	Support suspension <i>Suspension mounting</i>																												
	1																												
	<table border="0"> <tr><td>1.6i 16v.</td><td>12/06-</td></tr> <tr><td>1.7 CDTi FAP</td><td>01/08-</td></tr> <tr><td>1.8i 16v.</td><td>07/05-</td></tr> <tr><td>1.9 CDTi</td><td>07/05-</td></tr> <tr><td>2.0i 16v. Turbo</td><td>07/05-</td></tr> <tr><td>2.2i 16v.</td><td>07/05-</td></tr> </table>	1.6i 16v.	12/06-	1.7 CDTi FAP	01/08-	1.8i 16v.	07/05-	1.9 CDTi	07/05-	2.0i 16v. Turbo	07/05-	2.2i 16v.	07/05-																
1.6i 16v.	12/06-																												
1.7 CDTi FAP	01/08-																												
1.8i 16v.	07/05-																												
1.9 CDTi	07/05-																												
2.0i 16v. Turbo	07/05-																												
2.2i 16v.	07/05-																												
2656063 OE 0312510	Butée à billes G/D <i>L/R ball bearing</i>																												
	2																												
NEW	TT /all models		-07/05																										
9005360 OE 344417	Butée de suspension <i>Shock bush</i>																												
	3 H63																												
	<table border="0"> <tr><td>1.6i 16v. /GNV</td><td>01/99-07/05</td></tr> <tr><td>1.8i 16v.</td><td>01/99-07/05</td></tr> <tr><td>2.0i 16v. Turbo</td><td>01/02-07/05</td></tr> <tr><td>2.0 Di 16v.</td><td>01/99-07/05</td></tr> <tr><td>2.0 DTi 16v.</td><td>01/99-07/05</td></tr> <tr><td>2.2i 16v.</td><td>01/99-07/05</td></tr> <tr><td>2.2 DTi 16v.</td><td>01/99-07/05</td></tr> </table>	1.6i 16v. /GNV	01/99-07/05	1.8i 16v.	01/99-07/05	2.0i 16v. Turbo	01/02-07/05	2.0 Di 16v.	01/99-07/05	2.0 DTi 16v.	01/99-07/05	2.2i 16v.	01/99-07/05	2.2 DTi 16v.	01/99-07/05														
1.6i 16v. /GNV	01/99-07/05																												
1.8i 16v.	01/99-07/05																												
2.0i 16v. Turbo	01/02-07/05																												
2.0 Di 16v.	01/99-07/05																												
2.0 DTi 16v.	01/99-07/05																												
2.2i 16v.	01/99-07/05																												
2.2 DTi 16v.	01/99-07/05																												
2656017 OE 344956	Butée de suspension <i>Shock bush</i>																												
	3 H40																												
	<table border="0"> <tr><td>1.6i 16v.</td><td>07/05-10/11</td></tr> <tr><td>1.6i GNV</td><td>09/06-10/11</td></tr> <tr><td>1.7 CDTi FAP</td><td>01/08-10/11</td></tr> <tr><td>1.8i 16v.</td><td>07/05-10/11</td></tr> <tr><td>1.9 CDTi FAP</td><td>07/05-10/11</td></tr> <tr><td>2.0i 16v. Turbo</td><td>07/05-10/11</td></tr> <tr><td>2.2i 16v.</td><td>07/05-12/07</td></tr> </table>	1.6i 16v.	07/05-10/11	1.6i GNV	09/06-10/11	1.7 CDTi FAP	01/08-10/11	1.8i 16v.	07/05-10/11	1.9 CDTi FAP	07/05-10/11	2.0i 16v. Turbo	07/05-10/11	2.2i 16v.	07/05-12/07														
1.6i 16v.	07/05-10/11																												
1.6i GNV	09/06-10/11																												
1.7 CDTi FAP	01/08-10/11																												
1.8i 16v.	07/05-10/11																												
1.9 CDTi FAP	07/05-10/11																												
2.0i 16v. Turbo	07/05-10/11																												
2.2i 16v.	07/05-12/07																												

... Zafira

Eléments TRAIN ARRIERE

Rear axle parts

Tren TRAS



Elementy zawieszenia tylnego

элементы задней оси.



OPEL



2606004 OE 0402952	Articulation essieu AR <i>Rear axle bush</i>	2606009 OE 402027	Articulation essieu AR <i>Rear axle bush</i>
	<p>Ø int.13 Ø ext.70.5 coll.85 long. tube int. 91 ext. 56 ep coll. 21</p> <p>1.6i 16v. 07/05-12/07 1.7 CDTi FAP 01/08-10/11 1.8i 16v. 07/05-10/11 1.9 CDTi 07/05-10/11 2.0i 16v. Turbo /OPC 07/05-10/11 2.2i 16v. 07/05-12/07</p>		<p>Ø int.12 Ø ext.68 coll.78 long. tube int.90 ext.64 ep. coll.11</p> <p>Tringlerie Watt POC GNG</p> <p>1.4i Turbo 11/11- 1.6i Turbo GNV 150 01/12- 1.8i 11/11- 2.0 CDTi FAP 11/11-</p>

Combo ...

Eléments DIRECTION

Steering parts

Elementos Direcciones

Elementy układ kierowniczy

Элементы рулевой системы

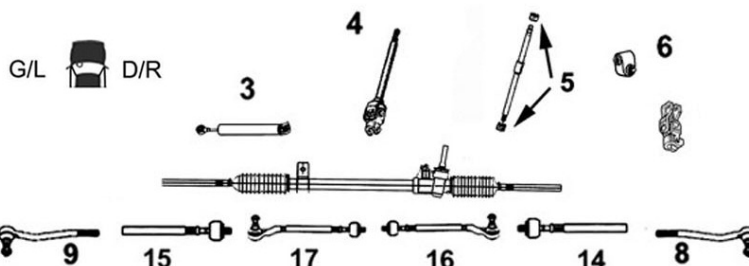

9006201 OE 1603453	Axe de bielle G/D <i>L/R axial joint</i>	9006692 OE 1603455	Rotule de direction G/D <i>L/R tie rod end</i>
	<p>14 Côté dir. M14x1.5 Côté rot. M12x1.5 long 322 mm 15</p> <p>TT /all models DNA assistance électronique 07/94-</p>		<p>8 M12 x 1.5 9</p> <p>TT /all models -ch V3023597 07/94-</p>
9006202 OE 322158	Axe de bielle G/D <i>L/R axial joint</i>		
	<p>14 Côté dir. M14x1.5 Côté rot. M12x1.5 long 281 mm 15</p> <p>TT /all models DA 07/94-</p>		
9006374 OE 1603645	Rotule de direction G/D <i>L/R tie rod end</i>		
	<p>8 M12 x 1.5 9</p> <p>TT /all models -ch V3023597 07/94-</p>		

... Combo ...

SASIC

OPEL



Barre stabilisatrice
 Stabilizer bar
 Barra estabilizadora
 Drażek stabilizatora
 стабилизатор поперечной устойчивости

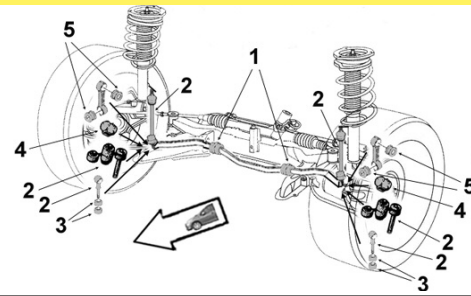

9001509
OE 350127

Palier de barre milieu
Middle bar main bearing

9001657
OE 0353282

Art. tirant de barre
Rod bushing



1 Barre Ø 21.5

1.2	04/93-10/01
1.4	04/93-10/01
1.7 D	04/93-10/01



Ø int.14 Ø ext. 58 coll.62
long. tube int.36 ext.23.5 coll.4.5

1.4	04/97-10/00
1.7 D	04/97-10/00



Eléments SUSPENSION
 Suspension parts
 Elementos suspensión
 Elementy zawieszenie
 Элементы подвески

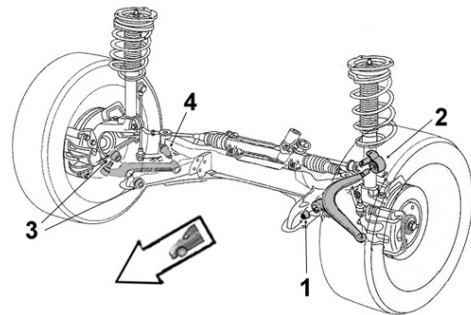

9001514
OE 352301

Articulation int.
Inner bush



4 Ø int.10 Ø ext.37 coll.44 long. tube int.52 ext.28 ep. coll.6

1.2	04/93-10/01
1.4	04/93-10/01
1.7 D	04/93-10/01

Bras & Triangle de suspension
 Control arm
 Brazo y triángulo
 Wahacz
 Рычаг подвески

G/L D/R

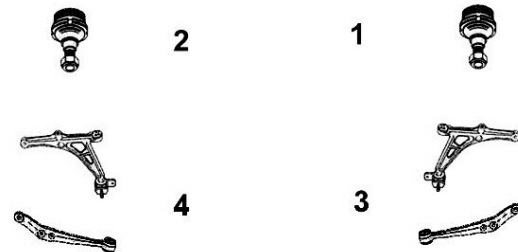

9005184
OE 352181

Bras de susp. G
Left track control arm

9005183
OE 352002

Bras de susp. D
Right track control arm



4 Sans rotule Without tie rod end











TT /all models -ch V3023597 07/94-



3 Sans rotule Without tie rod end

TT /all models -ch V3023597 07/94-

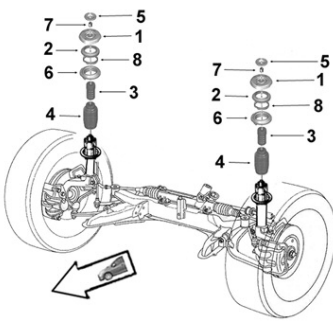
... Combo ...

9005766 OE 5352011	Bras de susp. G <i>Left track control arm</i>	9005764 OE 5352012	Bras de susp. D <i>Right track control arm</i>
	4 Sans rotule <i>Without tie rod end</i> TT /all models Ch- V3023598 07/94-		3 Sans rotule <i>Without tie rod end</i> TT /all models Ch- V3023598 07/94-
7476130 OE 1603128+352003	Bras de suspension G <i>Left track control arm</i>	7476129 OE 1603187+352002	Bras de suspension D <i>Right track control arm</i>
	4 Avec rotule <i>With ball joint Ø 15</i> TT /all models -ch V3023597 07/94-		3 Avec rotule <i>With ball joint Ø 15</i> TT /all models -ch V3023597 07/94-
7476132 OE 5352011+1603202	Bras de suspension G <i>Left track control arm</i>	7476131 OE 5352012+1603202	Bras de suspension D <i>Right track control arm</i>
	4 Avec rotule <i>With ball joint Ø 15</i> TT /all models Ch- V3023598 07/94-		3 Avec rotule <i>With ball joint Ø 15</i> TT /all models Ch- V3023598 07/94-
9005252 OE 1603187	Rotule de susp. inf. G/D <i>L/R lower suspension ball joint</i>	9005542 OE 1603202	Rotule de susp. inf. G/D <i>L/R lower suspension ball joint</i>
	1 Ø 15 2 TT /all models -ch V3023597 07/94-		1 Ø 15 2 TT /all models Ch- V3023598 07/94-
 <p> Support d'amortisseur <i>Suspension mounting</i> <i>Soporte amortiguador</i> <i>Poduszka amortyzatora</i> <i>Опора амортизатора</i> </p>			
9005358 OE 344410	Butée de suspension G/D <i>L/R suspension bush</i>		
	3 1.2 1.4 1.7 D	04/93- 04/93- 04/93-	

OPEL



... Combo



Barre stabilisatrice
 Stabilizer bar
 Barra estabilizadora
 Drażek stabilizatora
 стабилизатор поперечной устойчивости

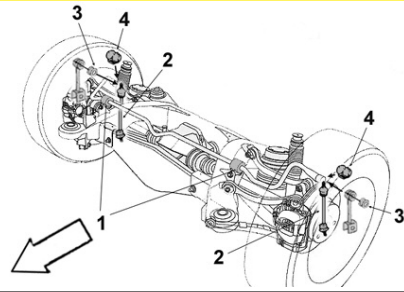

2306130 **Palier de barre milieu**
 OE 444332 *Middle bar main bearing*

NEW

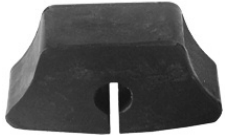

1 Ø 12

1.2i
 1.4i
 1.7 D

08/93-03/96
 12/93-12/01
 08/90-09/01

Eléments TRAIN ARRIERE
 Rear axle parts
 Tren TRAS
 Elementy zawieszenia tylnego
 элементы задней оси.



9001654 **Articulation essieu AR**
 OE 402643 *Rear axle bush*



Ø int.10 Ø ext.41 coll.53
 long. tube int.65 ext.44.5 ep. coll.8

1.2 04/93-
 1.4 04/93-
 1.7 D 04/93-

Movano ...

Eléments DIRECTION
 Steering parts
 Elementos Direcciones
 Elementy uklad kierowniczy
 Элементы рулевой системы

G/L D/R

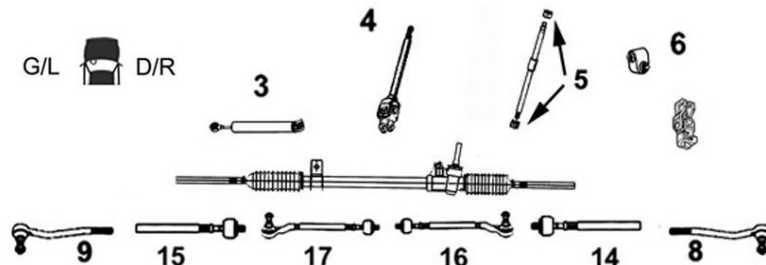

3008249 **Axe de bielle G/D**
 Part/oe 4501261 *L/R axial joint*



14 Côté dir. M14x1.5 Côté rot. M16x1.5
 15 long 176 mm

1.9 DTi
 2.2 DTi
 2.5 CDTi
 2.5 D
 2.8 DTi
 3.0 CDTi

11/03-02/07

7774017 **Axe de bielle G/D**
 Part/oe 4420096 *L/R axial joint*

NEW



14 Côté dir. M16x1.5 Côté rot. M18x1.5
 15 long mm 251

2.3 CDTi M9T 04/10-

4006153 **Rotule de direction G**
 OE 4501262 *Left tie rod end*



9

1.9 DTi -04/10
 2.2 DTi -04/10
 2.5 CDTi -04/10
 2.5 D -04/10
 2.8 DTi -04/10





4006154 **Rotule de direction D**
 OE 4501263 *Right tie rod end*



8

1.9 DTi -04/10
 2.2 DTi -04/10
 2.5 CDTi -04/10
 2.5 D -04/10
 2.8 DTi -04/10



... Movano ...

7674013 OE 4420097	Rotule de direction G <i>Left tie rod end</i>	7674015 OE 4420098	Rotule de direction D <i>Right tie rod end</i>
9		8	
 	2.3 CDTi M9T6 04/10-	 	2.3 CDTi M9T6 04/10-

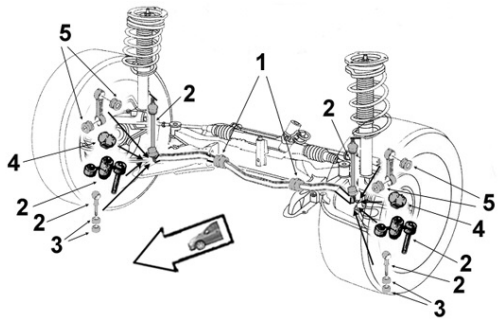

Barre stabilisatrice
Stabilizer bar
Barra estabilizadora
Drażek stabilizatora
стабилизатор поперечной устойчивости





4005140 OE 4418192	Biellette barre stab. G <i>Left stabilizer bar stub axle</i>	4005139 OE 4418193	Biellette barre stab. D <i>Right stabilizer bar stub axle</i>
2		2	
	1.9 DTi 08/00-07/02 2.2 DTi 08/00-02/07 2.5 CDTi 07/98-10/01 2.5 CDTi 02/06-04/10 2.8 DTi 01/99-10/01 3.0 CDTi 11/03-02/07		1.9 DTi 08/00-07/02 2.2 DTi 08/00-02/07 2.5 CDTi 07/98-10/01 2.5 CDTi 02/06-04/10 2.8 DTi 01/99-10/01 3.0 CDTi 11/03-02/07

2304030 OE 4419291	Biellette barre stab. <i>Stabilizer bar stub axle</i>		
2			
	2.3 CDTi	M9T	04/10-

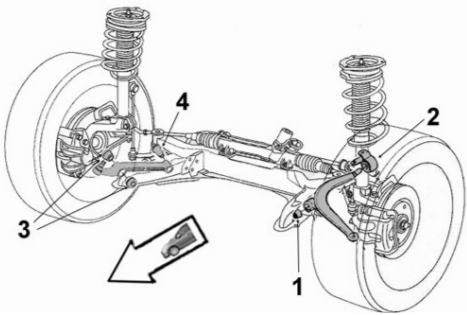

Eléments SUSPENSION
Suspension parts
Elementos suspensión
Elementy zawieszanie
Элементы подвески



2254001 Part/oe 4500091	Articulation Sup. <i>Upper bush</i>	4001548 OE 4500094	Art. AV triangle inf. <i>Lower track control arm front bush</i>
4		1	
	Ø int. 22 Ø ext. 47 coll. 58 x2 long. tube int. 60 ext. 45 ep. coll.3x2 1.9 DTi 08/00-07/02 2.2 DTi 08/00-11/03 2.5 CDTi 10/01-04/10 2.5 D 11/99-11/03 2.8 DTi 11/99-11/03		Ø int.28 Ø ext.55 coll.75 long. tube int.74 ext.58 ep. coll.6 1.9 DTi 08/00-07/02 2.2 DTi 08/00-11/03 2.5 CDTi 10/01-04/10 2.5 D 01/99-11/03 2.8 DTi 01/99-11/03 3.0 CDTi 11/03-02/07

... Movano ...



Eléments SUSPENSION
Suspension parts
Elementos suspensión
Elementy zawieszenie
Элементы подвески

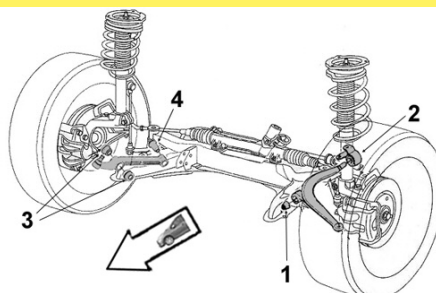

SASIC

OPEL

4001545

Art. AR triangle inf.

OE 4500095

Lower track control arm rear bush



2 Ø int.28 Ø ext.55 coll.75 long.tube int.89 ext.58 ep.coll.14

1.9 DTi	08/00-07/02
2.2 DTi	08/00-11/03
2.5 CDTi	10/01-04/10
2.5 D	11/99-11/03
2.8 DTi	11/99-11/03
3.0 CDTi	11/03-02/07

Bras & Triangle de suspension

Control arm
Brazo y triángulo
Wahacz
Рычаг подвески

G/L D/R

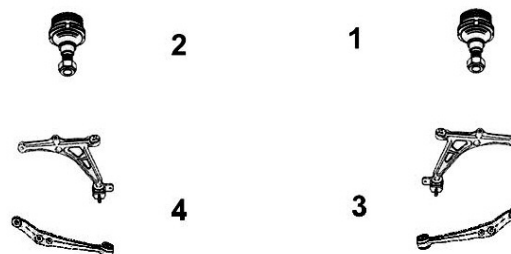

9005768

Triangle de susp. inf. G

OE 4401852

Lower left track control arm



4 Fonte Iron Avec rotule With ball joint

1.9 DTi	-08/07
2.2 DTi	-08/07
2.5 CDTi	-08/07
2.5 D	-10/01
2.8 DTi	
3.0 CDTi	-02/07

9005767

Triangle de susp. inf. D

OE 4401853

Lower right track control arm



3 Fonte Iron Avec rotule With ball joint

1.9 DTi	-08/07
2.2 DTi	-08/07
2.5 CDTi	-08/07
2.5 D	-10/01
2.8 DTi	
3.0 CDTi	-02/07

7474006

Triangle de susp. inf. G

OE 4418629

Lower left track control arm



4 Avec rotule With ball joint

1.9 DTi	09/07-
2.5 CDTi	09/07-

7474007

Triangle de susp. inf. D

OE 4418630

Lower right track control arm



3 Avec rotule With ball joint

1.9 DTi	09/07-
2.5 CDTi	09/07-

7474009

Triangle de susp. inf. G

OE 4419215

Lower left track control arm

NEW



4 Sans rotule Without tie rod end

2.3 CDTi	M9T	05/10-
----------	-----	--------

7474008

Triangle de susp. inf. D

OE 4419216

Lower right track control arm











NEW



3 Sans rotule Without tie rod end

2.3 CDTi	M9T	05/10-
----------	-----	--------

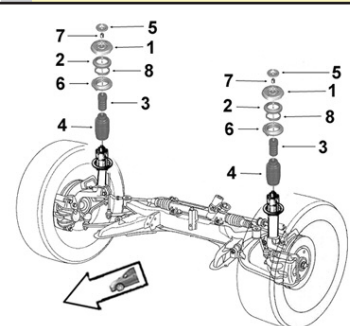
... Movano ...

4005279		Rotule de susp. sup. G/D		4005276		Rotule de susp. inf. G/D	
OE 4500254		<i>L/R upper susp. ball joint</i>		OE 4401909		<i>L/R lower suspension ball joint</i>	
	1 2	1.9 DTi 2.2 DTi 2.5 CDTi 2.5 D 2.8 DTi			1 2	Ø 22 1.9 DTi -08/07 2.2 DTi -08/07 2.5 CDTi -08/07 2.5 D 2.8 DTi	
7574007		Rotule de susp. inf. G/D		7574006		Rotule de susp. G	
OE 4418631		<i>L/R lower suspension ball joint</i>		OE 4419219		<i>L Susp. ball joint</i>	
	1 2	1.9 DTi 09/07- 2.5 CDTi 09/07-			2	2.3 CDTi M9T 04/10-	
7574006		Rotule de susp. D		7574012		Rotule de susp. D	
OE 4419219		<i>R Susp. ball joint</i>		OE 4408252		<i>R Suspension ball joint</i>	
	1	2.3 CDTi M9T 04/10-22/07/10			1	2.3 CDTi M9T 23/07/10-	
7574001		Rotule appui ressort		7574001		Rotule appui ressort	
OE 4401910		<i>Ball joint Spring support</i>		OE 4401910		<i>Ball joint Spring support</i>	
	1 2	1.9 DTi 08/00-07/02 2.2 DTi 08/00-11/03 2.5 CDTi 2.5 D 01/99-10/01			1 2	2.8 DTi 01/99-10/01 3.0 CDTi	
 <p>Support d'amortisseur Suspension mounting Soporte amortiguador Poduszka amortyzatora Опора амортизатора</p>							
2654027		Butée de suspension G/D					
OE 4419286		<i>L/R suspension bush</i>					
	3	H146					
		2.3 CDTi		M9T		04/10-	

OPEL



... Movano



Barre stabilisatrice
Stabilizer bar
Barra estabilizadora
Drażek stabilizatora
 стабилизатор поперечной устойчивости

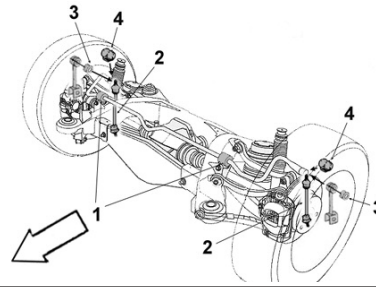

2304039

Biellette barre stab.

OE 4419304

Stabilizer bar stub axle

NEW



2

2.3 CDTi Propulsion Roues simples
 2.3 CDTi Traction

M9T
 M9T

04/10-
 04/10-

2304007

Palier de barre milieu

OE 4401134

Middle bar main bearing

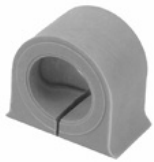

1 Ø 22.4

1.9 DTi
 2.2 DTi
 2.5 CDTi
 2.5 D
 2.8 DTi

08/00-07/02
 08/00-11/03
 10/01-04/10
 01/99-11/03
 11/99-11/03

Vivaro ...

Eléments DIRECTION

Steering parts

Elementos Direcciones

Elementy układ kierowniczy

Элементы рулевой системы

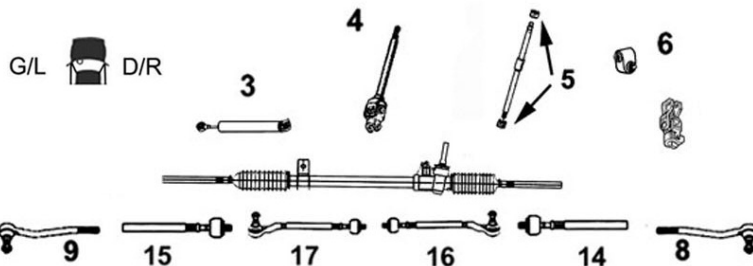

3008247

Axe de bielle G/D

Part/oe 4408474

L/R axial joint



14 Côté dir. M12x1.0 Côté rot. M14x1.5 long 263 mm

15

1.9 Di
 1.9 DTi
 2.0i 16v.
 2.0 CDTi
 2.5 CDTi
 2.5 DTi

4006147

Rotule de direction G

OE 4408510

Left tie rod end



9

1.9 Di
 1.9 DTi
 2.0i 16v.
 2.0 CDTi
 2.5 CDTi

4006148

Rotule de direction D

OE 4408511

Right tie rod end



8

1.9 Di
 1.9 DTi
 2.0i 16v.
 2.0 CDTi
 2.5 CDTi

... Vivaro ...



Barre stabilisatrice
 Stabilizer bar
 Barra estabilizadora
 Drażek stabilizatora
 стабилизатор поперечной устойчивости

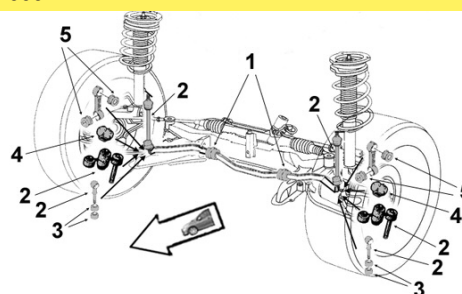

OPEL



4005141

Biellette barre stab.

OE 4417973

Stabilizer bar stub axle



2

1.9 Di 80hp 60kw
 1.9 DTi 100hp 74kw
 2.0i 16v.
 2.0 CDTi
 2.5 CDTi
 2.5 DTi

05/01-08/06
 05/01-08/06
 05/01-
 08/06-
 08/06-
 10/02-08/06



Eléments SUSPENSION

Suspension parts
 Elementos suspensión
 Elementy zawieszenie
 Элементы подвески

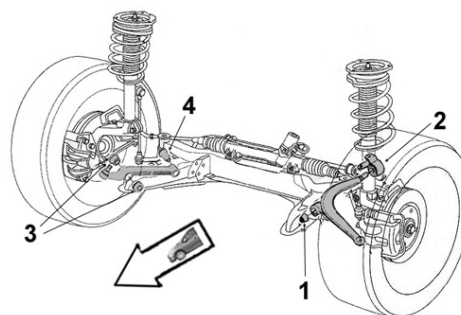

2254007

Articulation AV

Part/oe 4412934

Front bush



1 Ø int.18 Ø ext.55 long. tube int. 50 ext. 31

1.9 Di 05/01-
 1.9 DTi 05/01-
 2.0i 16v. 07/02-
 2.0 CDTi 08/06-
 2.5 CDTi
 2.5 DTi -ch 6V69999 -ch 6Y69999

2254008

Articulation AR

Part/oe 4412936

Rear bush



2 Ø int. 14 Ø ext. 58
 long. tube int. 54 ext. 29

1.9 Di 05/01-
 1.9 DTi 05/01-
 2.0i 16v. 07/02-
 2.0 CDTi 08/06-
 2.5 CDTi

Bras & Triangle de suspension

Control arm
 Brazo y triángulo
 Wahacz
 Рычаг подвески

G/L D/R

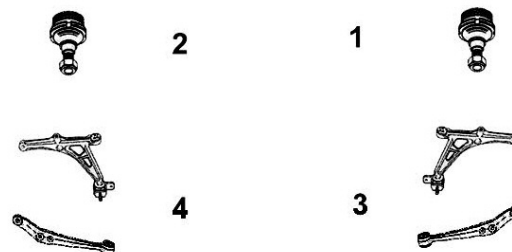

9005770

Triangle de susp. inf. G

OE 4418223

Lower left track control arm



4 Avec rotule With ball joint

1.9 Di -11/12/06
 1.9 DTi -11/12/06
 2.0i 16v. -11/12/06
 2.5 DTi -11/12/06

9005769

Triangle de susp. inf. D

OE 4418224

Lower right track control arm



3 Avec rotule With ball joint

1.9 Di -11/12/06
 1.9 DTi -11/12/06
 2.0i 16v. -11/12/06
 2.5 DTi -11/12/06

...Vivaro

SASIC

OPEL

Bras & Triangle de suspension

Control arm
Brazo y triángulo
Wahacz
Рычаг подвески

G/L  D/R



7474026

OE 4421647

Triangle de susp. inf. G

Lower left track control arm

NEW

4 Avec rotule With ball joint



2.0i 16v. 11/12/06-11/03/10
2.0 CDTi /FAP 11/12/06-11/03/10
2.5 CDTi /FAP 11/12/06-11/03/10

7474025

OE 4421646

Triangle de susp. inf. D

Lower right track control arm

NEW

3 Avec rotule With ball joint



2.0i 16v. 11/12/06-11/03/10
2.0 CDTi /FAP 11/12/06-11/03/10
2.5 CDTi /FAP 11/12/06-11/03/10

4005278

OE 4419075

Rotule de susp. inf. G/D

L/R lower suspension ball joint



1
2 -ch 7V621197 -ch 7Y721612

1.9 Di DTi
2.0i 16v.
2.0 CDTi
2.5 CDTi
2.5 DTi

4005281

OE 4431869

Rotule de susp. inf. G/D

L/R lower suspension ball joint



1
2 Ch- 7V621198 Ch- 7Y721613

1.9 Di DTi
2.0i 16v.
2.0 CDTi
2.5 CDTi
2.5 DTi



Support d'amortisseur

Suspension mounting
Soporte amortiguador
Poduszka amortyzatora
Опора амортизатора

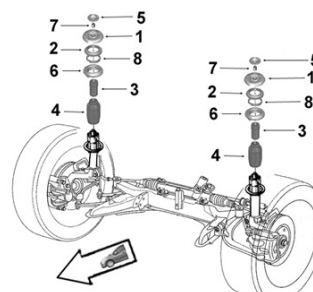

4001637

OE 4408054

Support suspension G/D

L/R suspension mounting



1
1.9 Di
1.9 DTi
2.0i 16v.
2.0 CDTi
2.5 DTi



Support d'amortisseur

Suspension mounting
Soporte amortiguador
Poduszka amortyzatora
Опора амортизатора

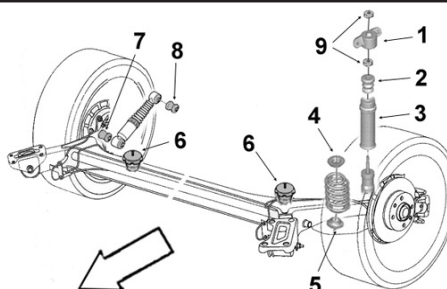

2654003

OE 4412357

Appui inf. ressort AR

Lower support Rear spring



5 -ch 6V999999

1.9 Di
1.9 DTi
2.0i 16v.

Eléments DIRECTION

Steering parts
Elementos Direcciones
Elementy układ kierowniczy
Элементы рулевой системы

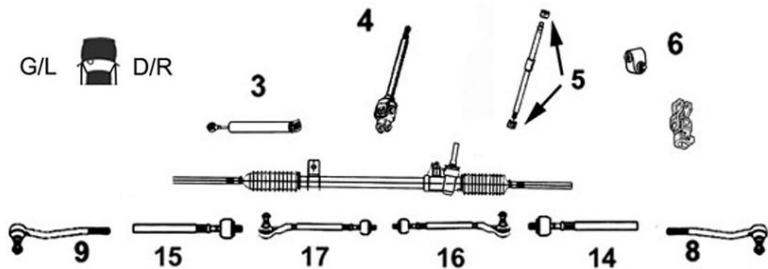

3008153

Axe de bielle G/D

OE -

L/R axial joint



14 Côté dir. M12x1.0 Côté rot. M14x1.5
15 long 262 mm

TT /all models dir. 4005.48 / 4005.52

8123153B1

Bielle de direction G/D

OE 381215

L/R steering rod



16
17

TT /all models dir. 4005.48 / 4005.52

8173183

Rotule de direction G/D

OE 381750

L/R tie rod end



8
9 M14 x 1.5

TT /all models dir. 4005.48 / 4005.52



Barre stabilisatrice

Stabilizer bar
Barra estabilizadora
Drażek stabilizatora
стабилизатор поперечной устойчивости

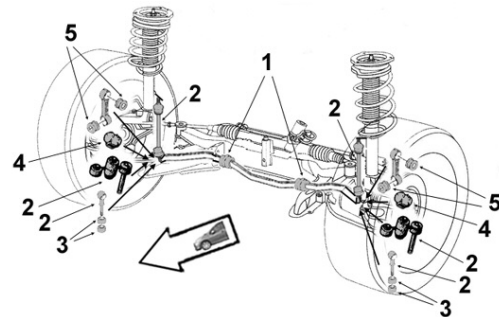

0945335

Palier de barre

OE 509433

Bar main bearing



1 Barre Ø 20

TT /all models

0935045

Liaison élastique

OE 509304

Elastic link



Ø 17.5 x Ø 48 - 11

TT /all models



Eléments SUSPENSION
Suspension parts
Elementos suspensión
Elementy zawieszenie
Элементы подвески

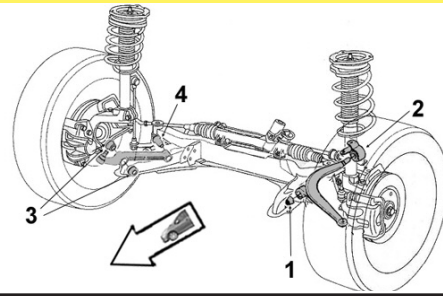

SASIC

PEUGEOT

5233143
OE 352314

Articulation ext.
Outer bush



3 Ø int.14 Ø ext.38
long. tube int.42 ext.24

TT /all models Côté roue

5233203
OE 352320

Articulation int.
Inner bush



4 Ø int.10 Ø ext.28
long. tube int.34 ext.28

TT /all models Coupé
Côté berceau 01/79-

Bras & Triangle de suspension

Control arm
Brazo y triángulo
Wahacz
Рычаг подвески

G/L D/R



5203343
OE 352035

Bras de suspension G
Left track control arm



4 Avec rotule *With ball joint*

TT /all models Berline Coupé
sauf XW3S / XY6B Ch- 5310515

5213233
OE 352123

Bras de suspension D
Right track control arm



3 Avec rotule *With ball joint*

TT /all models Berline Coupé
sauf XW3S / XY6B Ch- 5310515

1003544
OE -

Kit rép. bras susp. G ou D

L or R track control arm bearing repair kit



TT /all models Coupé 01/79-



Support d'amortisseur
 Suspension mounting
 Soporte amortiguador
 Poduszka amortyzatora
 Опора амортизатора

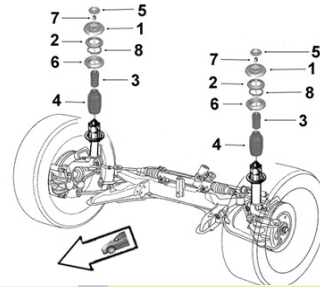

2545075
 OE 525407

Protecteur amortisseur G/D
 L/R shock absorber protector



4 Ø 50

TT /all models



Support d'amortisseur
 Suspension mounting
 Soporte amortiguador
 Poduszka amortyzatora
 Опора амортизатора

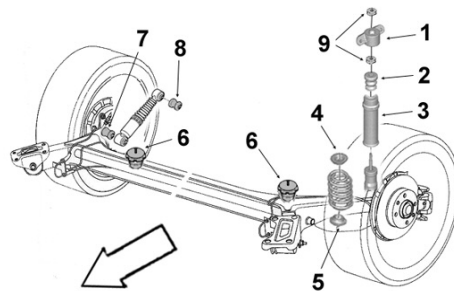

5143123
 OE 351412

Butée de talonnage G/D
 L/R bushing



6 Ø 53 H 55

TT /all models

106 ...

Eléments DIRECTION
 Steering parts
 Elementos Direcciones
 Elementy uklad kierowniczy
 Элементы рулевой системы

G/L D/R

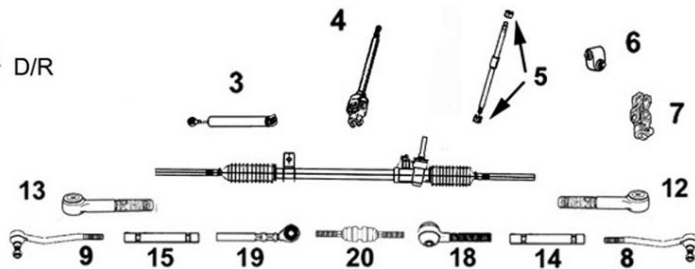

3008075
 Part/oe 3812A0

Axe de bielle G/D
 L/R axial joint



14 Côté dir. M14x1.5 Côté rot. M14x1.5
 15 long 380 mm

TT /all models DNA DA -03/96
 TT /all models DA 29/04/96-
 TT /all models DNA 28/05/96-

3008074
 OE 381733

Embout axe de bielle G/D
 L/R nozzle Axial joint



18
 19

TT /all models DNA DA -03/96
 TT /all models DA 03/96-28/04/96
 TT /all models DNA 03/96-27/05/96

Eléments DIRECTION
 Steering parts
 Elementos Direcciones
 Elementy układ kierowniczy
 Элементы рулевой системы

G/L  D/R

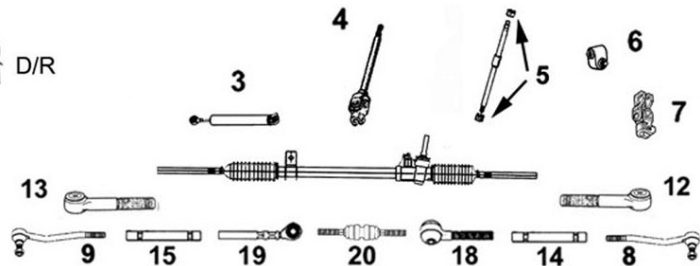

3008077 **Rotule centrale dir.**
 OE 381747 *Middle tie rods end*



20

TT /all models DA 29/04/96-
 TT /all models DNA 28/05/96-

8173303 **Rotule de direction G**
 OE 381741 *Left tie rod end*



9 M14 x 1.5

TT /all models DNA DA

8173313 **Rotule de direction D**
 OE 381742 *Right tie rod end*



8 M14 x 1.5

TT /all models DNA DA



Barre stabilisatrice
 Stabilizer bar
 Barra estabilizadora
 Drażek stabilizatora
 стабилизатор поперечной устойчивости

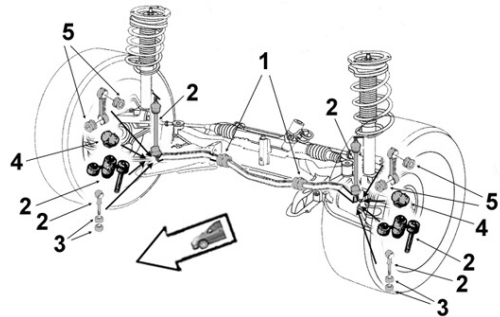

0875335 **Biellette barre stab.**
 OE 508733 *Stabilizer bar stub axle*



2

1.3i Rallye -05/95
 1.6i Griffie -05/95
 TT /all models Sport -05/95

0875405 **Biellette barre stab.**
 OE 508740 *Stabilizer bar stub axle*



2

1.1i Sport Susp. normale TU1JP/1M+ 03/96-
 1.3i Rallye 05/95-03/96
 1.4 TU3 TU3.2 03/96-
 1.4i TU3JP 03/96-
 1.6i /16v. /VTS TU5JP/J2/J4 03/96-
 1.6i Griffie 05/95-03/96
 TT /all models Sport 05/95-03/96

0945765 **Palier de barre milieu**
 OE 509476 *Middle bar main bearing*



1 Barre Ø 16

1.6i TU5JP 03/96-











0945725 **Palier de barre milieu**
 OE 509472 *Middle bar main bearing*



1 Barre Ø 18 Susp. normale

1.1i Sport TU1JP/M+ 03/96-
 1.4 Niveau 2S Sport TU3.2 03/96-
 1.4i Niveau 2S Sport Pneu 165x65x14H TU3JP 03/96-
 1.6i 90hp 66kw TU5JP 03/96-

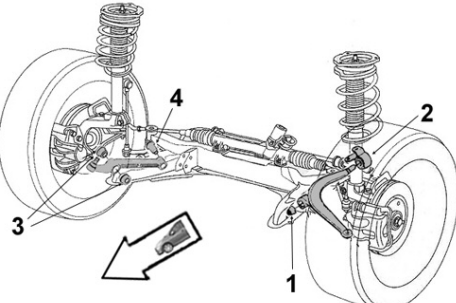
... 106 ...

0945565 OE 509456	Palier de barre milieu <i>Middle bar main bearing</i>	0945585 OE 509458	Palier de barre milieu <i>Middle bar main bearing</i>
	1 Barre Ø 19 TT /all models Essence Diesel -03/96 Electric 30 (20kw) 07/95- 1.0/i TU9/M 03/96- 1.1/i TU1/M+ 03/96- 1.4i Clim. / DA Susp. normale Sauf niveau 2S / Sport ABS TU3JP 03/96- 1.5 D TUD5 03/96- 1.6i Susp. renforcée TU5JP 03/96-		1 Barre Ø 20 1.3i Rallye -07/93 1.4i Xsi -07/93
0945685 OE 509468	Palier de barre milieu <i>Middle bar main bearing</i>	0945575 OE 509457	Palier de barre milieu <i>Middle bar main bearing</i>
	1 Barre Ø 20 1.3i Rallye 07/93-03/96 1.4i Xsi 07/93-03/96 1.6i Xsi Susp. normale TU5J2 -03/96		1 Barre Ø 21 TT /all models Essence Diesel -03/96 1.0/i TU9/M 03/96- 1.1/i TU1/M+ 03/96- 1.4i Airbag conducteur Susp. normale Sauf niveau 2S / Sport TU3JP 03/96- 1.5 D TUD5 03/96-
0945715 OE 509471	Palier de barre milieu <i>Middle bar main bearing</i>	0945595 OE 509459	Palier de barre bout <i>End bar main bearing</i>
	1 Barre Ø 22 1.3i Rallye 01/94-03/96 1.6 S16 /VTS TU5J4 03/96- 1.6i Rallye TU5J2 03/96-		4 Barre Ø 19 noir TT /all models Essence Diesel -03/96 Electric Susp. renforcée Electric 30 (20kw) 07/95- 1.0/i TU9/M 03/96- 1.1/i TU1/M+ 03/96- 1.4i Clim. / DA Susp. normale Sauf niveau 2S / Sport ABS TU3JP 03/96- 1.5 D TUD5 03/96- 1.6i Susp. renforcée TU5JP 03/96-06/98
0945605 OE 509460	Palier de barre bout <i>End bar main bearing</i>		
	4 Barre Ø 21 blanc TT /all models Essence Diesel -03/96 1.0/i TU9/M 03/96- 1.1/i TU1/M+ 03/96- 1.4i Airbag conducteur Susp. normale Sauf niveau 2S / Sport TU3JP 03/96- 1.5 D TUD5 03/96-		
 <p>Eléments SUSPENSION <i>Suspension parts</i> <i>Elementos suspensión</i> <i>Elementy zawieszenie</i> <i>Элементы подвески</i></p>			
5233503 OE 352350	Articulation AV <i>Front bush</i>	5233523 OE 352352	Articulation AV <i>Front bush</i>
	1 Ø int.12 Ø ext.34 coll.28 long. tube int.48.5 ext.30 TT /all models Ess. et Dies. sauf TU3JP TU2J2 TU5JP/JP2 -03/96 TT /all models TU3/3.2 03/96- 1.0/i TU9/M 03/96- 1.1/i TU1/M+ 03/96- 1.5 D TUD5 03/96- 1.6i TU5JP 03/96- Electric 30 03/96-		1 Ø int.12 Ø ext.34 coll.44 long. tube int.48 ext.35.5 ep. coll.5 1.1i Sport TU1JP/1M+ 03/96- 1.3i Rallye TU2J2 -03/96 1.4 TU3J 1.6i TU5JP 1.6i TU5J2 -03/96 1.6i /16v. /VTS TU5J4 03/96- 1.6i Rallye TU5J2 03/96-



Eléments SUSPENSION
 Suspension parts
 Elementos suspensión
 Elementy zawieszenie
 Элементы подвески

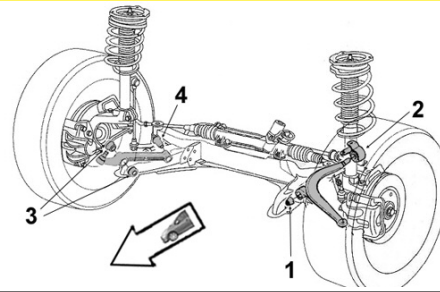

5233513

OE 352351

Articulation AR

Rear bush



2 Ø int.17

TT /all models Essence Diesel sauf injection -03/96

1.0/i	TU9/M	03/96-
1.1/i	TU1/M+	03/96-
1.4 sauf injection	TU3/3.2	03/96-
1.5 D	TUD5	03/96-
Electric	Electric 30	07/95-

2005251

OE -

Articulation AR

Rear bush



2 Ø int.17

TT /all models Essence Diesel Injection -03/96

1.4i	TU3JP	03/96-
1.6i /16v. /VTS	TU5JP/J2/J4	03/96-

Bras & Triangle de suspension

Control arm
 Brazo y triángulo
 Wahacz
 Рычаг подвески

G/L D/R



5203783

OE 352078

Triangle de susp. G

Left track control arm



4 Avec rotule With ball joint

TT /all models Sauf

1.1 mot. TU1M + Sport	03/96-
1.3i mot. TU2J2	-03/96
1.4 mot. TU3J	-03/96
1.4 mot. TU3JP niveau 2S - Sport	03/96-
1.4 mot. TU3.2	03/96-
1.6 Rallye mot. TU5J2	03/96-
1.6i mot. TU5J2 BVM	-03/96
1.6i mot. TU5JP	
1.6 16v. mot. TU5J4	03/96-

5203793

OE 352079

Triangle de susp. D







Right track control arm



3 Avec rotule With ball joint

TT /all models Sauf

1.1 mot. TU1M + Sport	03/96-
1.3i mot. TU2J2	-03/96
1.4 mot. TU3J	-03/96
1.4 mot. TU3JP niveau 2S - Sport	03/96-
1.4 mot. TU3.2	03/96-
1.6 Rallye mot. TU5J2	03/96-
1.6i mot. TU5J2 BVM	-03/96
1.6i mot. TU5JP	
1.6 16v. mot. TU5J4	03/96-

5203923		Triangle de susp. G		5203933		Triangle de susp. D		
OE 352092		<i>Left track control arm</i>		OE 352093		<i>Right track control arm</i>		
	4 Avec rotule <i>With ball joint</i>					3 Avec rotule <i>With ball joint</i>		
	1.1i	TU1M/JP + Sport	03/96-	1.1i		TU1M/JP + Sport	03/96-	
	1.3i	TU2J2	-03/96	1.3i		TU2J2	-03/96	
	1.4	TU3J		1.4		TU3J		
	1.4	TU32	03/96-	1.4		TU32	03/96-	
	1.4i niveau 2S - Sport	TU3JP	03/96-	1.4i niveau 2S - Sport		TU3JP	03/96-	
	1.6i	TU5J2	-03/96	1.6i		TU5J2	-03/96	
	1.6i	TU5JP BVM	-03/96	1.6i		TU5JP BVM	-03/96	
	1.6i	TU5JP	03/96-	1.6i		TU5JP	03/96-	
	1.6 Rallye	TU5J2	03/96-	1.6 Rallye		TU5J2	03/96-	
1.6i 16v. /VTS	TU5J4	03/96-	1.6i 16v. /VTS	TU5J4	03/96-			
6403363		Rotule de susp. inf. G/D		1153578		Kit rép. train AV		
OE 364036		<i>L/R lower suspension ball joint</i>		OE -		<i>Front axle repair kit</i>		
	1		Ø 16			Barre Ø 19		
	2		TT /all models			TT /all models 01/90- Sauf 1.6 mot. TU5JP 1.6 S16 mot. TU5J4		
1153579		Kit rép. train AV		Kit rép. train AV				
OE -		<i>Front axle repair kit</i>		<i>Front axle repair kit</i>				
	Barre Ø 21				Barre Ø 21			
	TT /all models		03/96-		TT /all models 03/96- Sauf 1.6 mot. TU5JP 1.6 S16 mot. TU5J4			
1003561		Kit rép. triangle susp. G ou D		Kit rép. triangle susp. G ou D				
OE 359904		<i>L or R track control arm bearing repair kit</i>		<i>L or R track control arm bearing repair kit</i>				
	Avec visserie <i>With screws and bolts</i>				Avec visserie <i>With screws and bolts</i>			
	TT /all models Sauf				TT /all models Sauf			
	1.1	TU1M + Sport	03/96-	1.1	TU1M + Sport	03/96-		
	1.3i	TU2J2	-03/96	1.3i	TU2J2	-03/96		
	1.4	TU3J	-03/96	1.4	TU3J	-03/96		
	1.6i	TU5J2 BVM & TU5JP		1.6i	TU5J2 BVM & TU5JP			
	1.4	TU3.2/3JP niveau 2S - Sport	03/96-	1.4	TU3.2/3JP niveau 2S - Sport	03/96-		
	1.6 Rallye	TU5J2	03/96-	1.6 Rallye	TU5J2	03/96-		
1.6i 16v.	TU5J4	03/96-	1.6i 16v.	TU5J4	03/96-			
1003560		Kit rép. triangle susp. G ou D		Kit rép. triangle susp. G ou D				
OE 359905		<i>L or R track control arm bearing repair kit</i>		<i>L or R track control arm bearing repair kit</i>				
	Avec visserie <i>With screws and bolts</i>				Avec visserie <i>With screws and bolts</i>			
	1.1	TU1M + Sport	03/96-	1.1	TU1M + Sport	03/96-		
	1.3i	TU2J2	-03/96	1.3i	TU2J2	-03/96		
	1.4i	TU3J	-03/96	1.4i	TU3J	-03/96		
	1.4	TU32	03/96-	1.4	TU32	03/96-		
	1.4i niveau 2S - Sport	TU3JP	03/96-	1.4i niveau 2S - Sport	TU3JP	03/96-		
	1.6i	TU5J2	-03/96	1.6i	TU5J2	-03/96		
	1.6i	TU5JP BVM	-03/96	1.6i	TU5JP BVM	-03/96		
	1.6i	TU5JP	03/96-	1.6i	TU5JP	03/96-		
	1.6 Rallye	TU5J2	03/96-	1.6 Rallye	TU5J2	03/96-		
1.6i 16v. /VTS	TU5J4	03/96-	1.6i 16v. /VTS	TU5J4	03/96-			



Support d'amortisseur
 Suspension mounting
 Soporte amortiguador
 Poduszka amortyzatora
 Опора амортизатора

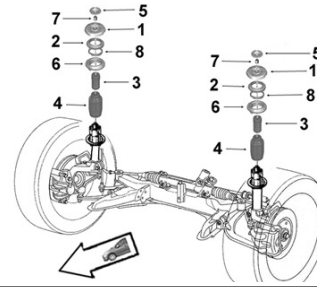





<p>2001003 OE 503852</p> 	<p>Support suspension G/D <i>L/R suspension mounting</i></p> <p>1</p> <p>TT /all models Essence Diesel -06/94</p>	<p>0385155 OE 503850</p> 	<p>Support suspension G/D <i>L/R suspension mounting</i></p> <p>1 TT /all models Essence Diesel 06/94-03/96</p> <table border="0"> <tr><td>1.0/i</td><td>TU9/M</td><td>03/96-</td></tr> <tr><td>1.1/i</td><td>TU1/M+ /1JP</td><td>03/96-</td></tr> <tr><td>1.4</td><td>TU3/3.2</td><td>03/96-</td></tr> <tr><td>1.4i</td><td>TU3JP</td><td>03/96-</td></tr> <tr><td>1.5 D</td><td>TUD5/B</td><td>03/96-</td></tr> <tr><td>1.6i /16v. /VTS</td><td>TU5JP/J2/J4</td><td>03/96-</td></tr> <tr><td>Electric</td><td>Electric 30 (20kw)</td><td></td></tr> </table>	1.0/i	TU9/M	03/96-	1.1/i	TU1/M+ /1JP	03/96-	1.4	TU3/3.2	03/96-	1.4i	TU3JP	03/96-	1.5 D	TUD5/B	03/96-	1.6i /16v. /VTS	TU5JP/J2/J4	03/96-	Electric	Electric 30 (20kw)																												
1.0/i	TU9/M	03/96-																																																	
1.1/i	TU1/M+ /1JP	03/96-																																																	
1.4	TU3/3.2	03/96-																																																	
1.4i	TU3JP	03/96-																																																	
1.5 D	TUD5/B	03/96-																																																	
1.6i /16v. /VTS	TU5JP/J2/J4	03/96-																																																	
Electric	Electric 30 (20kw)																																																		
<p>0355275 OE 503563</p> 	<p>Butée à billes G/D <i>L/R ball bearing</i></p> <p>2 TT /all models Essence Diesel -03/96</p> <table border="0"> <tr><td>1.0/i</td><td>TU9/M</td><td>03/96-</td></tr> <tr><td>1.1</td><td>TU1</td><td>03/96-</td></tr> <tr><td>1.1i</td><td>TU1M+ /1JP</td><td>03/96-</td></tr> <tr><td>1.4</td><td>TU3/3.2</td><td>03/96-</td></tr> <tr><td>1.4i</td><td>TU3JP</td><td>03/96-</td></tr> <tr><td>1.5 D</td><td>TUD5/B</td><td>03/96-</td></tr> <tr><td>1.6i /16v. /VTS</td><td>TU5JP/J2/J4</td><td>03/96-</td></tr> <tr><td>Electric</td><td>Electric 30 (20kw)</td><td></td></tr> </table>	1.0/i	TU9/M	03/96-	1.1	TU1	03/96-	1.1i	TU1M+ /1JP	03/96-	1.4	TU3/3.2	03/96-	1.4i	TU3JP	03/96-	1.5 D	TUD5/B	03/96-	1.6i /16v. /VTS	TU5JP/J2/J4	03/96-	Electric	Electric 30 (20kw)		<p>0335355 OE 503335</p> 	<p>Butée de suspension G/D <i>L/R suspension bush</i></p> <p>3 H66 TT /all models Essence Diesel -03/96</p> <table border="0"> <tr><td>1.0/i</td><td>TU9/M</td><td>03/96-</td></tr> <tr><td>1.1</td><td>TU1</td><td>03/96-</td></tr> <tr><td>1.1i</td><td>TU1M+ /1JP</td><td>03/96-</td></tr> <tr><td>1.4</td><td>TU3/3.2</td><td>03/96-</td></tr> <tr><td>1.4i</td><td>TU3JP</td><td>03/96-</td></tr> <tr><td>1.5 D</td><td>TUD5/B</td><td>03/96-</td></tr> <tr><td>1.6i /16v. /VTS</td><td>TU5JP/J2/J4</td><td>03/96-</td></tr> <tr><td>Electric</td><td>Electric 30 (20kw)</td><td>07/95-</td></tr> </table>	1.0/i	TU9/M	03/96-	1.1	TU1	03/96-	1.1i	TU1M+ /1JP	03/96-	1.4	TU3/3.2	03/96-	1.4i	TU3JP	03/96-	1.5 D	TUD5/B	03/96-	1.6i /16v. /VTS	TU5JP/J2/J4	03/96-	Electric	Electric 30 (20kw)	07/95-
1.0/i	TU9/M	03/96-																																																	
1.1	TU1	03/96-																																																	
1.1i	TU1M+ /1JP	03/96-																																																	
1.4	TU3/3.2	03/96-																																																	
1.4i	TU3JP	03/96-																																																	
1.5 D	TUD5/B	03/96-																																																	
1.6i /16v. /VTS	TU5JP/J2/J4	03/96-																																																	
Electric	Electric 30 (20kw)																																																		
1.0/i	TU9/M	03/96-																																																	
1.1	TU1	03/96-																																																	
1.1i	TU1M+ /1JP	03/96-																																																	
1.4	TU3/3.2	03/96-																																																	
1.4i	TU3JP	03/96-																																																	
1.5 D	TUD5/B	03/96-																																																	
1.6i /16v. /VTS	TU5JP/J2/J4	03/96-																																																	
Electric	Electric 30 (20kw)	07/95-																																																	
<p>0335365 OE 503336</p> 	<p>Butée de suspension G/D <i>L/R suspension bush</i></p> <p>3 H90 TT /all models Essence Diesel -03/96</p> <table border="0"> <tr><td>1.0/i</td><td>TU9/M</td><td>03/96-</td></tr> <tr><td>1.1</td><td>TU1</td><td>03/96-</td></tr> <tr><td>1.1i</td><td>TU1M+/1JP</td><td>03/96-</td></tr> <tr><td>1.4</td><td>TU3/3.2</td><td>03/96-</td></tr> <tr><td>1.4i</td><td>TU3JP</td><td>03/96-</td></tr> <tr><td>1.5 D</td><td>TUD5</td><td>03/96-</td></tr> <tr><td>1.6i /16v. /VTS</td><td>TU5JP/J2/J4</td><td>03/96-</td></tr> </table>	1.0/i	TU9/M	03/96-	1.1	TU1	03/96-	1.1i	TU1M+/1JP	03/96-	1.4	TU3/3.2	03/96-	1.4i	TU3JP	03/96-	1.5 D	TUD5	03/96-	1.6i /16v. /VTS	TU5JP/J2/J4	03/96-	<p>2545185 OE 525418</p> 	<p>Protecteur amortisseur G/D <i>L/R shock absorber protector</i></p> <p>4 TT /all models Essence Diesel -03/96</p> <table border="0"> <tr><td>1.0/i</td><td>TU9/M</td><td>03/96-</td></tr> <tr><td>1.1</td><td>TU1</td><td>03/96-</td></tr> <tr><td>1.1i</td><td>TU1M+/1JP</td><td>03/96-</td></tr> <tr><td>1.4</td><td>TU3/3.2</td><td>03/96-</td></tr> <tr><td>1.4i</td><td>TU3JP</td><td>03/96-</td></tr> <tr><td>1.5 D</td><td>TUD5/B</td><td>03/96-</td></tr> <tr><td>1.6i /16v. /VTS</td><td>TU5JP/J2/J4</td><td>03/96-</td></tr> <tr><td>Electric</td><td>Electric 30 (20kw)</td><td></td></tr> </table>	1.0/i	TU9/M	03/96-	1.1	TU1	03/96-	1.1i	TU1M+/1JP	03/96-	1.4	TU3/3.2	03/96-	1.4i	TU3JP	03/96-	1.5 D	TUD5/B	03/96-	1.6i /16v. /VTS	TU5JP/J2/J4	03/96-	Electric	Electric 30 (20kw)				
1.0/i	TU9/M	03/96-																																																	
1.1	TU1	03/96-																																																	
1.1i	TU1M+/1JP	03/96-																																																	
1.4	TU3/3.2	03/96-																																																	
1.4i	TU3JP	03/96-																																																	
1.5 D	TUD5	03/96-																																																	
1.6i /16v. /VTS	TU5JP/J2/J4	03/96-																																																	
1.0/i	TU9/M	03/96-																																																	
1.1	TU1	03/96-																																																	
1.1i	TU1M+/1JP	03/96-																																																	
1.4	TU3/3.2	03/96-																																																	
1.4i	TU3JP	03/96-																																																	
1.5 D	TUD5/B	03/96-																																																	
1.6i /16v. /VTS	TU5JP/J2/J4	03/96-																																																	
Electric	Electric 30 (20kw)																																																		
<p>1005260 OE -</p> 	<p>Kit rép. suspension G ou D <i>L/R stabilizing bar repair kit</i></p> <p>TT /all models -06/94</p>																																																		
<p>1005262 OE -</p> 	<p>Kit rép. suspension G ou D <i>L/R stabilizing bar repair kit</i></p> <p>TT /all models 06/94-03/96</p> <table border="0"> <tr><td>1.0</td><td>TU9 TU9M</td><td>03/96-</td></tr> <tr><td>1.1</td><td>TU1 TU1M+</td><td>03/96-</td></tr> <tr><td>1.4</td><td>TU3 TU3.2</td><td>03/96-</td></tr> <tr><td>1.4i</td><td>TU3JP</td><td>03/96-</td></tr> <tr><td>1.5 D</td><td>TUD5</td><td>03/96-</td></tr> <tr><td>1.6i /16v. /VTS</td><td>TU5J4 TU5JP</td><td>03/96-</td></tr> <tr><td>1.6i</td><td>TU5J2</td><td>03/96-</td></tr> </table>			1.0	TU9 TU9M	03/96-	1.1	TU1 TU1M+	03/96-	1.4	TU3 TU3.2	03/96-	1.4i	TU3JP	03/96-	1.5 D	TUD5	03/96-	1.6i /16v. /VTS	TU5J4 TU5JP	03/96-	1.6i	TU5J2	03/96-																											
1.0	TU9 TU9M	03/96-																																																	
1.1	TU1 TU1M+	03/96-																																																	
1.4	TU3 TU3.2	03/96-																																																	
1.4i	TU3JP	03/96-																																																	
1.5 D	TUD5	03/96-																																																	
1.6i /16v. /VTS	TU5J4 TU5JP	03/96-																																																	
1.6i	TU5J2	03/96-																																																	

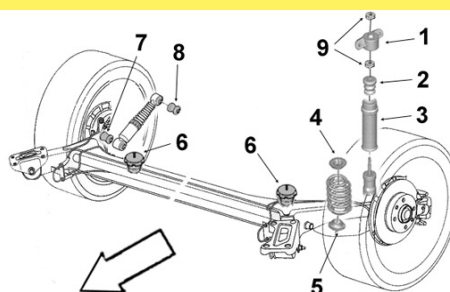

Support d'amortisseur
 Suspension mounting
 Soporte amortiguador
 Poduszka amortyzatora
 Опора амортизатора





1715105 OE 517110	Art. sup. amortisseur <i>Upper shock absorber bush</i>	1715095 OE 517109	Art. inf. amortisseur <i>Lower shock absorber bush</i>
	8 Ø int.12.2 Ø ext.30 coll.33.5 x2 long. tube int.39.8 ext.35 ep. coll.3x2 1.0/i TU9/M 03/96- 1.1i TU1/M+ 03/96- 1.4 TU3/3.2 03/96- 1.4i TU3JP 03/96- 1.5 D TUD5 03/96- 1.6i /16v. /VTS TU5JP/J2/J4 03/96-		7 Ø int.14.6 Ø ext.34.9 coll.37.5 x2 long. tube int.39.8 ext.33.7 ep. coll.3.2x2 1.0/i TU9/M 03/96- 1.1i TU1/M+ 03/96- 1.4 TU3/3.2 03/96- 1.4i TU3JP 03/96- 1.5 D TUD5 03/96- 1.6i /16v. /VTS TU5JP/J2/J4 03/96-
1665375 OE 516637	Butée de talonnage <i>Bushing</i>	1665625 OE 516662	Butée de talonnage <i>Bushing</i>
	6 H48 TT /all models Ess. et Dies. -03/96 sauf berline comm. 3ptes Susp. normale sans barre stab. AV 1.0i sans barre stab. AV TU9M 03/96- 1.1 sans barre stab. AV TU1 carbu 03/96- 1.1i sans barre stab. AV TU1M+ 03/96-		6 H56 1.0i avec barre stab. AV susp. normale TU9M 03/96- 1.1 avec barre stab. AV susp. normale TU1 carbu 03/96- 1.1i avec barre stab. AV susp. normale TU1JP /M+ 03/96- 1.4 Carbu. Susp. normale TU32 03/96- 1.4i susp. normale TU3JP 03/96- 1.5 D susp. normale TUD5 03/96- 1.6i /16v. /VTS TU5JP/J2/J4 03/96-

Éléments TRAIN ARRIERE

Rear axle parts
 Tren TRAS
 Elementy zawieszenia tylnego
 элементы задней оси.



1315635 OE 513163	Articulation traverse <i>Cross bar bush</i>
	Ø int.12 Ø ext.33 coll.57 long. tube int.47 ext.25.5 ep. coll.13 Avec barre anti-devers ou Sport TT /all models Essence Diesel -03/96 1.0/i TU9/M 03/96- 1.1/i TU1/M+ 03/96- 1.4 TU3 TU3.2 03/96- 1.4i TU3JP 03/96- 1.5 D TUD5 03/96- 1.6i /16v. /VTS TU5JP/J2/J4 03/96-
1315655 OE 513165	Articulation traverse AR <i>Rear cross bar bush</i>
	Ø int.12 Ø ext.33 coll.57 long. tube int.47 ext.25.5 ep. coll.13 Sans barre anti-devers TT /all models Essence Diesel -03/96 1.0/i TU9/M 03/96- 1.1/i TU1/M+ 03/96- 1.4 TU3 TU3.2 03/96- 1.4i TU3JP 03/96- 1.5 D TUD5 03/96- 1.6i /16v. /VTS TU5JP/J2/J4 03/96-

107 ...



PEUGEOT

Eléments DIRECTION

Steering parts

Elementos Direcciones

Elementy układ kierowniczy

Элементы рулевой системы

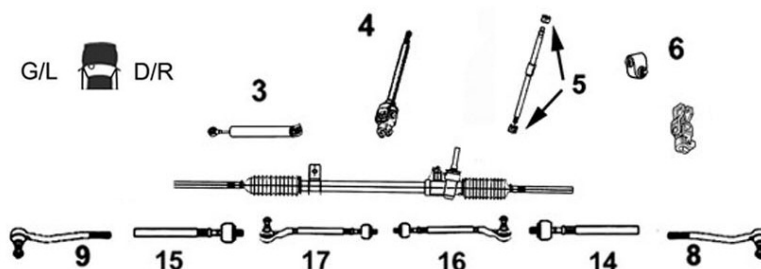

7770011

Axe de bielle G/D

Part/oe 400133

L/R axial joint

NEW



14 Côté dir. M14x1.5 **15** Côté rot. M12x1.25 long 223 mm

1.0i 12v.
1.4 HDi 55hp 40kw

384F
DV4TD

06/05-
06/05-

8173633

Rotule de direction G

OE 381763

Left tie rod end



9 M12 x 1.25

1.0i 12v. 384F 06/05-
1.4 HDi 55hp 40kw DV4TD 06/05-

8173643

Rotule de direction D

OE 381764

Right tie rod end



8 M12 x 1.25

1.0i 12v. 384F 06/05-
1.4 HDi 55hp 40kw DV4TD 06/05-



Barre stabilisatrice

Stabilizer bar

Barra estabilizadora

Drażek stabilizatora

стабилизатор поперечной устойчивости

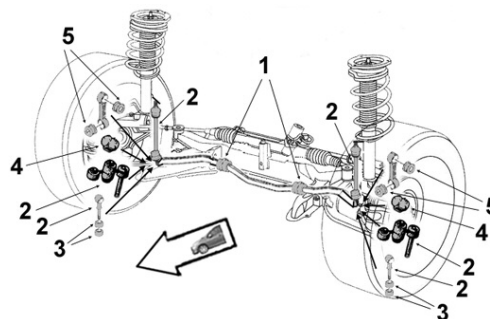

2300016

Palier de barre milieu

OE 5094A8

Middle bar main bearing



1

1.0i 12v. 384F
1.4 HDi 55hp 40kw DV4TD

2300044

Liaison élastique

OE 5094A7

Elastic link





3



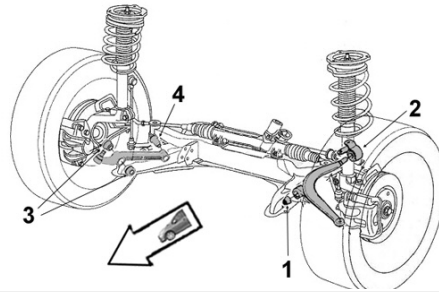

1.0i 12v. 384F
1.4 HDi 55hp 40kw DV4TD





Eléments SUSPENSION
Suspension parts
Elementos suspensión
Elementy zawieszenie
Элементы подвески



2250003 Part/oe 3520Q2	Articulation AV <i>Front bush</i>	2250006 Part/oe 3520Q2	Articulation AR <i>Rear bush</i>
	1 Ø int. 12 Ø ext. 33 coll. 34 long. tube int. 53 ext. 31 ep. coll.6X2 1.0i 12v. 384F 1.4 HDi 55hp 40kw DV4TD		2 Ø int. 19 Ø ext. 57 long. tube int. 62 ext. 26 1.0i 12v. 384F 1.4 HDi 55hp 40kw DV4TD

Bras & Triangle de suspension <i>Control arm</i> <i>Brazo y triángulo</i> <i>Wahacz</i> <i>Рычаг подвески</i>	G/L  D/R	 2	1 
		 4	 3

5203Q23 OE 3520Q2	Triangle de susp. inf. G <i>Lower left track control arm</i>	5213L33 OE 3521L3	Triangle de susp. inf. D <i>Lower right track control arm</i>
	4 Avec rotule With ball joint 1.0i 12v. 384F 06/05- 1.4 HDi 55hp 40kw DV4TD 06/05-		3 Avec rotule With ball joint 1.0i 12v. 384F 06/05- 1.4 HDi 55hp 40kw DV4TD 06/05-

7570002 Part/oe 3521L3	Rotule de susp. inf. G/D <i>L/R lower suspension ball joint</i>		
	1 2 1.0i 12v. 384F 06/05- 1.4 HDi 55hp 40kw DV4TD 06/05-		



Support d'amortisseur
 Suspension mounting
 Soporte amortiguador
 Poduszka amortyzatora
 Опора амортизатора

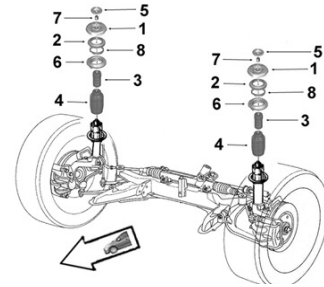

2650022
 OE 5038F6

Support suspension G/D
 L/R suspension mounting



1 Sans roulement Without bearing

1.0i 12v. 384F
 1.4 HDi 55hp 40kw DV4TD

2650004
 OE 503557

Butée à billes G/D
 L/R ball bearing



2

1.0i 12v. 384F
 1.4 HDi 55hp 40kw DV4TD

2650008
 OE 503396

Butée de suspension G/D
 L/R suspension bush



3

1.0i 12v. 384F 06/05-
 1.4 HDi 55hp 40kw DV4TD 06/05-

Eléments TRAIN ARRIERE
 Rear axle parts
 Tren TRAS
 Elementy zawieszenia tylnego
 элементы задней оси.



2600003
 OE 5131C9

Articulation essieu
 Axle bush



Ø int. 12 Ø ext. 60 coll. 75
 long. tube int.85 ext.53 ep. coll.6

1.0i 12v. 384F
 1.4 HDi 55hp 40kw DV4TD

1007 ...

Eléments DIRECTION
 Steering parts

Elementos Direcciones
 Elementy układ kierowniczy
 Элементы рулевой системы

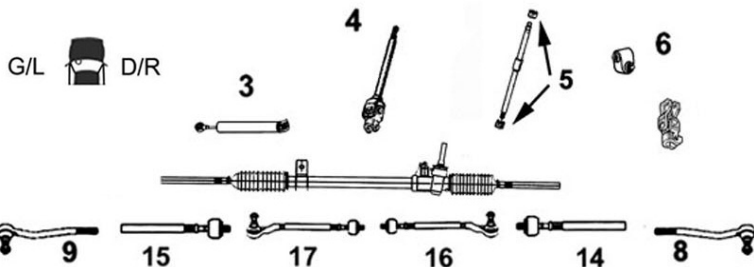

3008080

Axe de bielle G/D

Part/oe 3812E1

L/R axial joint



14 Côté dir. M12x1.0 Côté rot. M14x1.5
15 long 239 mm

1.4i TU3A
 1.4i Conduite à D TU3A -04/12/05
 1.4i TU3JP
 1.4i Conduite à D TU3JP -04/12/05
 1.4i 16v. ET3J4
 1.4 HDi Conduite à G DV4TD
 1.4 HDi Conduite à D DV4TD
 -04/12/05
 1.6i 16v. TU5JP4 -04/12/05

7770018

Axe de bielle G/D

OE 3812E6

L/R axial joint

NEW





14 Côté dir. M12x1.0 Côté rot. M16x1.5
15 long 236 mm

1.4i /16v. Conduite à D 05/12/05-
 1.4 HDi Conduite à D 05/12/05-
 1.6i 16v. TU5JP4 05/12/05-
 1.6 HDi FAP Conduite à G
 DV6TED4

... 1007 ...

PEUGEOT





8173553 OE 381755	Rotule de direction G <i>Left tie rod end</i>	8173563 OE 381756	Rotule de direction D <i>Right tie rod end</i>
	9 1.4i TU3A 1.4i Conduite à D TU3A -04/12/05 1.4i TU3JP 1.4i Conduite à D TU3JP -04/12/05 1.4i 16v. ET3J4 1.4 HDi Conduite à G DV4TD 1.4 HDi Conduite à D DV4TD -04/12/05 1.6i 16v. TU5JP4 -04/12/05		8 1.4i TU3A 1.4i Conduite à D TU3A -04/12/05 1.4i TU3JP 1.4i Conduite à D TU3JP -04/12/05 1.4i 16v. ET3J4 1.4 HDi Conduite à G DV4TD 1.4 HDi Conduite à D DV4TD -04/12/05 1.6i 16v. TU5JP4 -04/12/05

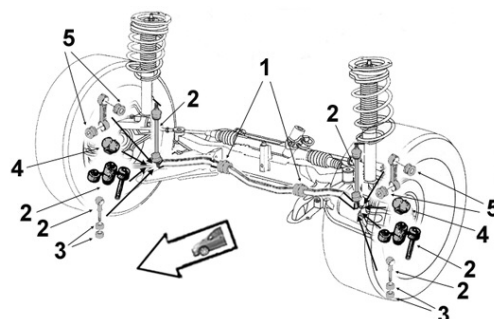

Barre stabilisatrice
Stabilizer bar
Barra estabilizadora
Drążek stabilizatora
стабилизатор поперечной устойчивости





0875455 OE 508759	Biellette barre stab. <i>Stabilizer bar stub axle</i>	2300025 OE 5094A2	Palier de barre milieu <i>Middle bar main bearing</i>
	2 1.4i TU3A/JP 1.4i 16v. ET3J4 1.4 HDi DV4TD 1.6i 16v. TU5JP4 1.6 HDi FAP DV6TED4 0875455QT réservée à l'export <i>(for export only)</i>		1 Barre Ø 22 1.4i TU3A/JP -03/09/06 1.4i 16v. ET3J4 -03/09/06 1.4 HDi DV4TD -03/09/06 1.6i 16v. TU5JP4 -03/09/06 1.6 HDi FAP DV6TED4 -03/09/06

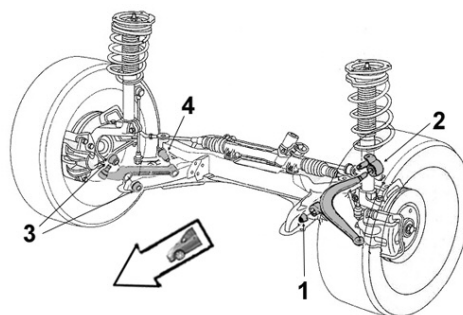

Eléments SUSPENSION
Suspension parts
Elementos suspensión
Elementy zawieszenie
Элементы подвески



5233983 OE 352398	Articulation AV <i>Front bush</i>		
	1 Ø int.18 Ø ext.56 coll.73 long. tube int.48 ext.20 ep. coll.10 Susp. normale 1.4i TU3A/JP -07/01/07 1.4i 16v. ET3J4 -07/01/07 1.4 HDi DV4TD -07/01/07 1.6i 16v. TU5JP4 -07/01/07		
5233AA3 OE 3523AA	Articulation AR <i>Rear bush</i>		
	2 Ø int.18 Ø ext.57 coll.73 long. tube int.48 ext.20 ep. coll.9 Susp. normale 1.4i TU3A/JP -07/01/07 1.4i 16v. ET3J4 -07/01/07 1.4 HDi DV4TD -07/01/07 1.6i 16v. TU5JP4 -07/01/07		

Bras & Triangle de suspension

Control arm
Brazo y triángulo
Wahacz
Рычаг подвески

G/L  D/R

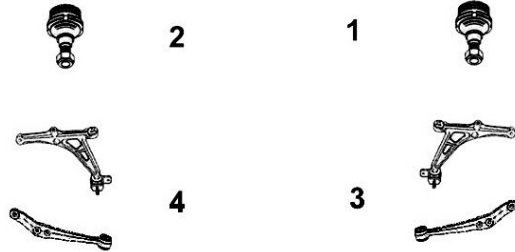

5203T33
OE 3520T3

Triangle de susp. G inf.
Lower left track control arm

5213Q43
OE 3521Q4

Triangle de susp. D inf.
Lower right track control arm



4 Sans rotule *Without ball joint*

1.4i	TU3A/JP
1.4i 16v.	ET3J4
1.4 HDi	DV4TD
1.6i 16v.	TU5JP4
1.6 HDi FAP	Susp. normale DV6TED4



3 Sans rotule *Without ball joint*

1.4i	TU3A/JP
1.4i 16v.	ET3J4
1.4 HDi	DV4TD
1.6i 16v.	TU5JP4
1.6 HDi FAP	Susp. normale DV6TED4

6403663
OE 364066

Rotule de susp. inf. G/D
L/R lower suspension ball joint



1
2

1.4i	TU3A/JP
1.4i 16v.	ET3J4
1.4 HDi	DV4TD
1.6i 16v.	TU5JP4
1.6 HDi FAP	Susp. normale DV6TED4



Support d'amortisseur
Suspension mounting
Soporte amortiguador
Poduszka amortyzatora
Опора амортизатора

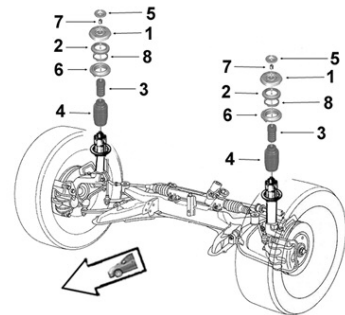

2650038
OE 503375

Coupelle rebond.
Spring cup

2650015
OE 5038F5

Support suspension
Suspension mounting



5

TT /all models



1

1.4i	TU3A/JP
1.4i 16v.	ET3J4
1.4 HDi	DV4TD
1.6i 16v.	TU5JP4
1.6 HDi FAP	DV6TED4

0355275
OE 503563

Butée à billes G/D
L/R ball bearing



2

1.4i	TU3A/JP
1.4i 16v.	ET3J4
1.4 HDi	DV4TD
1.6i 16v.	TU5JP4
1.6 HDi FAP	DV6TED4

... 1007



Support d'amortisseur
Suspension mounting
Soporte amortiguador
Poduszka amortyzatora
Опора амортизатора

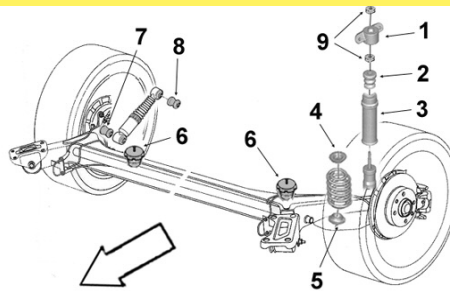

1665675
 OE 516694

Butée de talonnage G/D
L/R bushing



6 H78 Tambours AR sauf monte pneus 14 pouces / Disques AR

1.4i	TU3A TU3JP
1.4i 16v.	ET3J4
1.4 HDi	DV4TD
1.6i 16v.	TU5JP4
1.6 HDi FAP	DV6TED4

Eléments TRAIN ARRIERE
Rear axle parts
Tren TRAS
Elementy zawieszenia tylnego
элементы задней оси.



2600013
 OE 5131C6

Articulation essieu
Axle bush



Ø int. 12 Ø ext. 61 coll. 70
 long. tube int.68 ext.46 ep. Coll.7.6

1.4i	TU3A/JP
1.4i 16v.	ET3J4
1.4 HDi	DV4TD
1.6i 16v.	TU5JP4
1.6 HDi FAP	DV6TED4

204 ...

Eléments DIRECTION
Steering parts

Elementos Direcciones
Elementy uklad kierowniczy
Элементы рулевой системы

G/L D/R

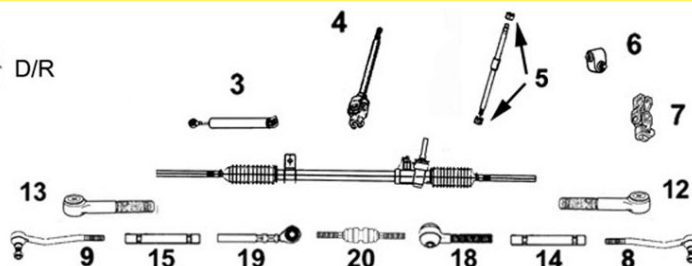

8993113
 OE 389911

Kit rép. de rotule direction G ou D
L/R tie rod end repair kit



Rondelle ep. 6.5 Washers thickness 6.5

TT /all models

8993173
 OE 389917

Kit rép. de rotule direction G ou D
L/R tie rod end repair kit



Rondelle ep. 8 Washers thickness 8

TT /all models



Eléments SUSPENSION
Suspension parts
Elementos suspensión
Elementy zawieszenie
Элементы подвески

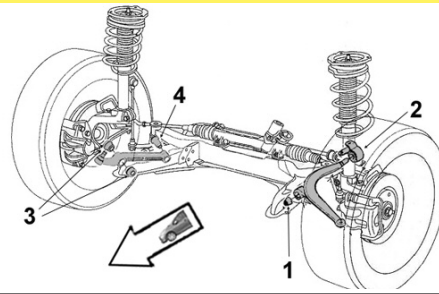

5233113
 OE 352311

Articulation AV/AR
Front rear bush



1 Ø int.10 Ø ext.34 long. tube int.41 ext.31
2

TT /all models

Bras & Triangle de suspension

Control arm
Brazo y triángulo
Wahacz
Рычаг подвески

G/L D/R



6403073
 OE 364007

Kit rép. rotule pivot fusée G ou D
L/R suspension ball joint repair kit



1 Côté 1 side

TT /all models



Support d'amortisseur

Suspension mounting
Soporte amortiguador
Poduszka amortyzatora
Опора амортизатора

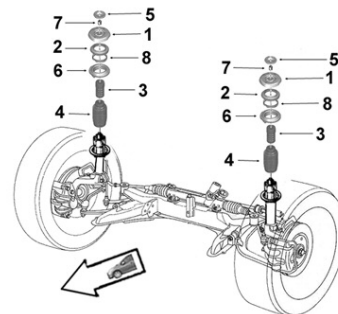

2545075
 OE 525407

Protecteur amortisseur G/D
L/R shock absorber protector



4 Ø 50

TT /all models

... 204



Support d'amortisseur
Suspension mounting
Soporte amortiguador
Poduszka amortyzatora
Опора амортизатора

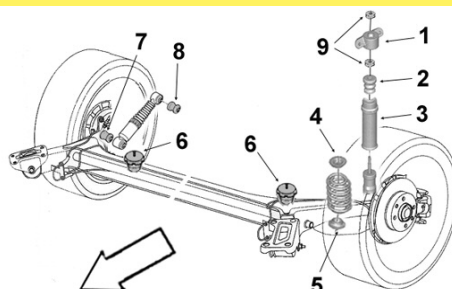

5143123

OE 351412

Butée de talonnage G/D

L/R bushing

6 Ø 53 H 55



TT /all models

PEUGEOT



205 ...

Eléments DIRECTION

Steering parts

Elementos Direcciones

Elementy uklad kierowniczy

Элементы рулевой системы

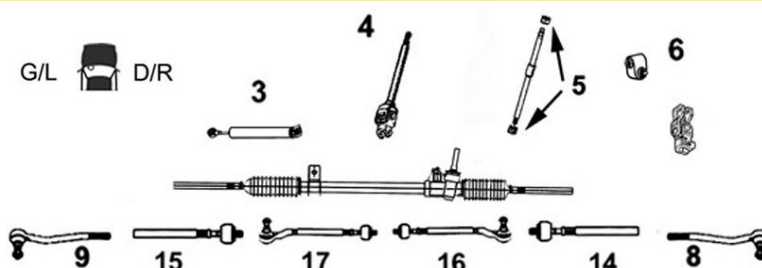

0114444

OE 401144

Vérin dir. assistée

Power steering jack

3



TT /all models Essence carburateur
 Sauf GTi Rallye 01/91-

TT /all models Diesel sauf TD
 01/91-

8123953

Part/oe 381295

Axe de bielle G/D

L/R axial joint

14

15



Côté dir. M12x1.0 Côté rot. M14x1.5
 long 314 mm

TT /all models

8123323B1

OE 381232

Bielle de direction G/D

L/R steering rod

16

17

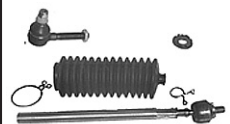

TT /all models DNA
 TT /all models DA Côté pignon

8173183

OE 381750

Rotule de direction G/D

L/R tie rod end

8

9



M14 x 1.5

TT /all models

1034E94

OE 4103E9

Axe de volant

Steering wheel shaft

4



TT /all models
 DNA Pignon cannelé
 Cannelures haut axe de volant L 40mm
 -06/90

1034964

OE 410396

Axe de volant

Steering wheel shaft

4



TT /all models
 DNA Pignon cannelé
 Cannelures haut axe de volant L 60mm
 -ch 23391891 -06/90

Eléments DIRECTION

Steering parts

Elementos Direcciones

Elementy układ kierowniczy

Элементы рулевой системы

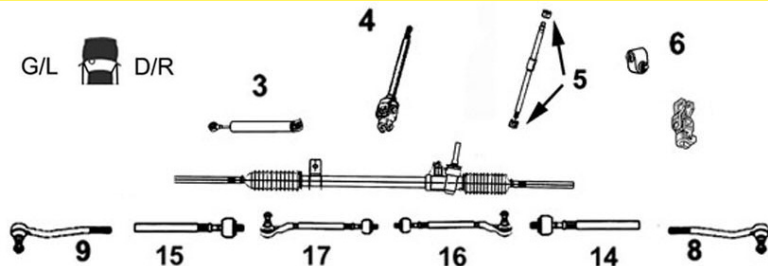

1034A84

OE 4103A8

Axe de volant

Steering wheel shaft



4

TT /all models DNA Pignon avec plats
Cannelures haut axe de volant L 60mm
Sauf GTi Rallye TD Ch- 23391892
06/90-

1034944

OE 410394

Axe de volant

Steering wheel shaft



4

TT /all models DA 01/91-



Barre stabilisatrice

Stabilizer bar

Barra estabilizadora

Drażek stabilizatora

стабилизатор поперечной устойчивости

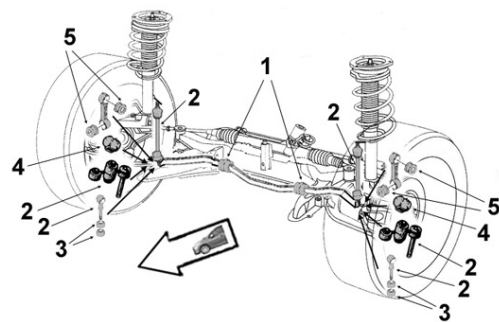

0875325

OE 508732

Biellette barre stab.

Stabilizer bar stub axle



2

Ø 10

TT /all models GTi Rallye TD

0945365

OE 509436

Palier de barre milieu

Middle bar main bearing



1

Barre Ø 20 blanc

TT /all models Sauf GTi Rallye TD

0945375

OE 509437

Palier de barre milieu

Middle bar main bearing



1

Barre Ø 22 vert

TT /all models Sauf GTi Rallye TD

0945405

OE 509440

Palier de barre milieu

Middle bar main bearing



1

Barre Ø 23 bleu foncé

TT /all models Sauf GTi Rallye TD

0945425

OE 509442

Palier de barre G

Left bar main bearing



1

Barre Ø 17 orange

TT /all models GTi Rallye TD

0945435

OE 509443

Palier de barre D

Right bar main bearing



1

Barre Ø 17 bleu clair

TT /all models GTi Rallye TD

1005079

OE -

Kit rép. barre stab. G et D

L R Stabilizing bar repair kit

Barre Ø 17 Bar Ø17

TT /all models GTi Rallye
1.8 TD



Eléments SUSPENSION

Suspension parts

Elementos suspensión

Elementy zawieszenie

Элементы подвески

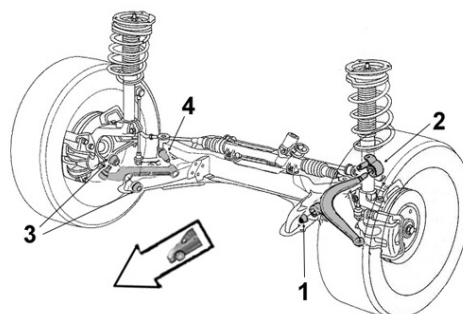

5233313

OE 352331

Articulation AV

Front bush

1 Ø int.10 Ø ext.28 long. tube int.34 ext.25

TT /all models GTi Rallye TD



5233233

OE 352323

Articulation AR

Rear bush

2 Ø int.12 Ø ext.31 coll.42
long. tube int.38 ext.26.5 ep. coll.6.5

TT /all models GTi Rallye TD



5233273UN

OE 352349

Articulation ext.

Outer bush

3 Ø int.12 Ø ext.36 coll.47
long. tube int.25 ext.15 ep. coll.8.5

TT /all models Sauf GTi Rallye TD



5233203

OE 352320

Articulation int.

Inner bush

4 Ø int.10 Ø ext.28 long. tube int.34 ext.28

TT /all models Sauf GTi Rallye TD



Bras & Triangle de suspension

Control arm

Brazo y triángulo

Wahacz

Рычаг подвески

G/L D/R



5203513

OE 352051

Bras de suspension G

Left track control arm

4 Avec rotule *With ball joint*

TT /all models Sauf GTi Rallye TD



5213343

OE 352134

Bras de suspension D

Right track control arm

3 Avec rotule *With ball joint*

TT /all models Sauf GTi Rallye TD









Bras & Triangle de suspension

Control arm
Brazo y triángulo
Wahacz
Рычаг подвески

G/L  D/R



<p>5203543 OE 352054</p> 	<p>Triangle de susp. G <i>Left track control arm</i></p> <p>4 Avec rotule <i>With ball joint</i></p> <p>TT /all models GTi Rallye 1.8 TD</p>	<p>5213373 OE 352137</p> 	<p>Triangle de susp. D <i>Right track control arm</i></p> <p>3 Avec rotule <i>With ball joint</i></p> <p>TT /all models GTi Rallye 1.8 TD</p>
<p>1003545 OE -</p> 	<p>Kit rép. bras susp. G ou D <i>L or R track control arm bearing repair kit</i></p> <p>Avec visserie <i>With screws and bolts</i></p> <p>TT /all models Sauf GTi Rallye TD</p>	<p>1003546 OE -</p> 	<p>Kit rép. triangle susp. G ou D <i>L or R track control arm bearing repair kit</i></p> <p>Avec visserie <i>With screws and bolts</i></p> <p>TT /all models GTi Rallye 1.8 TD</p>
<p>1003591S OE -</p> 	<p>Kit rép. bras susp. G ou D <i>L or R track control arm bearing repair kit</i></p> <p>Sans visserie <i>Without screws and bolts</i></p> <p>TT /all models Sauf GTi Rallye TD</p>	<p>105A545S OE -</p> 	<p>Kit rép. train AV <i>Front axle repair kit</i></p> <p>Sans visserie <i>Without screws and bolts</i> Barre Ø 20</p> <p>TT /all models Sauf GTi Rallye TD</p>
<p>106A545S OE -</p> 	<p>Kit rép. train AV <i>Front axle repair kit</i></p> <p>Sans visserie <i>Without screws and bolts</i> Barre Ø 22</p> <p>TT /all models Sauf GTi Rallye TD</p>	<p>107A545S OE -</p> 	<p>Kit rép. train AV <i>Front axle repair kit</i></p> <p>Sans visserie <i>Without screws and bolts</i> Barre Ø 23</p> <p>TT /all models Sauf GTi Rallye TD</p>
<p>1173545 OE -</p> 	<p>Kit rép. train AV <i>Front axle repair kit</i></p> <p>Avec écrous <i>with Nut s</i> Barre Ø 23</p> <p>TT /all models Sauf GTi Rallye TD</p>	<p>105A546S OE -</p> 	<p>Kit rép. train AV <i>Front axle repair kit</i></p> <p>Sans visserie <i>Without screws and bolts</i> Barre Ø 17</p> <p>TT /all models GTi Rallye 1.8 TD</p>

1073545B	Kit rép. train AV complet
OE -	<i>Front axle complete repair kit</i>
	Avec visserie <i>With screws and bolts</i> Barre Ø 23
	TT /all models Sauf GTi Rallye TD

	Support d'amortisseur		
	<i>Suspension mounting</i> <i>Soporte amortiguador</i> <i>Poduszka amortyzatora</i> <i>Опора амортизатора</i>		

8003208	Tampon suspension G/D	0355275	Butée à billes G/D
OE 503733	<i>L/R susp. rebound stop</i>	OE 503563	<i>L/R ball bearing</i>
	1 TT /all models		2 TT /all models

0335235	Butée de suspension G/D	0335275	Butée de suspension G/D
OE 503323	<i>L/R suspension bush</i>	OE 503327	<i>L/R suspension bush</i>
	3 H57 TT /all models DNA BVM Sauf GTi Rallye TD		3 H97 TT /all models Inj. sauf Cab.

2545135	Protecteur amortisseur G/D	0355185	Kit rép. support susp. G/D
OE 525413	<i>L/R shock absorber protector</i>	OE 503155	<i>L/R susp. mounting repair kit</i> <i>(Tampon caoutchouc+Butée à billes)</i> <i>Rubber top + Ball bearing</i>
	4 TT /all models		TT /all models



Support d'amortisseur
 Suspension mounting
 Soporte amortiguador
 Poduszka amortyzatora
 Опора амортизатора

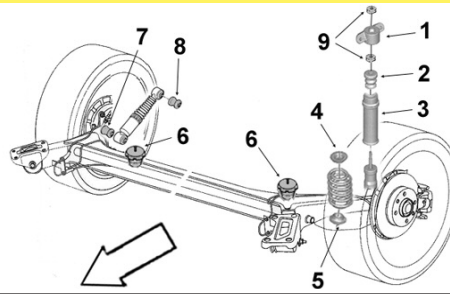

1715105
 OE 517110

Art. sup. amortisseur
 Upper shock absorber bush



8 Ø int.12.2 Ø ext.30 coll.33.5 x2
 long. tube int.39.8 ext.35 ep. coll.3x2

TT /all models 01/91-

1715095
 OE 517109

Art. inf. amortisseur
 Lower shock absorber bush



7 Ø int.14.6 Ø ext.34.9 coll.37.5 x2
 long. tube int.39.8 ext.33.7 ep. coll.3.2x2

TT /all models 01/91-

Eléments TRAIN ARRIERE

Rear axle parts
 Tren TRAS
 Elementy zawieszenia tylnego
 элементы задней оси.



1515105
 OE 515110

Support train AR
 Rear axle mounting



TT /all models

1315435
 OE 513143

Art. AR de traverse
 Cross bar rear bush



Ø int.12.5 Ø ext.30 coll.41
 long. tube int.34 ext.25 ep. coll.6

TT /all models

1315745
 OE 513174

Articulation traverse
 Cross bar bush



Ø int.12 Ø ext.30 coll.41
 long. tube int.34 ext.25 ep. coll.6

TT /all models

1005116
 OE -

Kit rép. train AR G ou D
 L/R rear axle repair kit



TT /all models

206 ...

Eléments DIRECTION
Steering parts
Elementos Direcciones
Elementy układ kierowniczy
Элементы рулевой системы

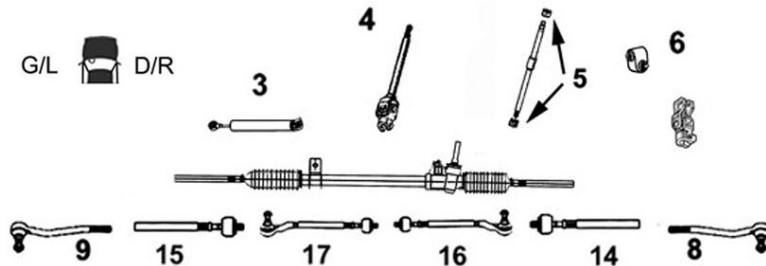

3008157 **Axe de bielle G/D**
 Part/oe 3812C5 *L/R axial joint*



14 Côté dir. M14x1.5 Côté rot. M14x1.5 long 300 mm
15

TT /all models Sauf DA non variable 08/12/08-

8173313 **Rotule de direction G**
 OE 381742 *Left tie rod end*



9 M14 x 1.5

TT /all models
 Sauf DA non variable 08/12/08-

8173303 **Rotule de direction D**
 OE 381741 *Right tie rod end*



8 M14 x 1.5

TT /all models
 Sauf DA non variable 08/12/08-



Barre stabilisatrice
Stabilizer bar
Barra estabilizadora
Drażek stabilizatora
 стабилизатор поперечной устойчивости

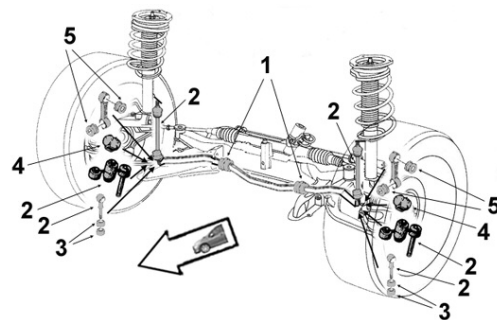

0875455 **Biellette barre stab.**
 OE 508759 *Stabilizer bar stub axle*



2

TT /all models Sauf 1.4i TU3JP Berline 03/08/09-

0875455QT réservée à l'export
(for export only)

0945815 **Palier de barre milieu**
 OE 509481 *Middle bar main bearing*



1 Barre Ø 18

1.1i Berline comm. 3ptes	TU1JP/L3 HFZ	09/98-09/00
1.1i Berline 3ptes	TU1JP/L3A HFY	09/98-01/04/02
1.1i Berline 3ptes Comm.	TU1JP/L4 HFX	09/00-01/04/02
1.1i Berline 5ptes	TU1JP/L3 HFZ	09/98-09/00
1.1i Berline 5ptes	TU1JP/L3A HFY	09/98-01/04/02
1.1i Berline 5ptes	TU1JP/L4 HFX	09/00-01/04/02
1.4i Berline 3/5ptes VP/ Comm.	TU3JP	-01/04/02
1.4 HDi Berline 3/5ptes VP/ Comm. susp. normale	DV4TD	-06/01/02
1.9 D 3ptes	DW8/B	-01/04/02



Barre stabilisatrice
 Stabilizer bar
 Barra estabilizadora
 Drażek stabilizatora
 стабилизатор поперечной устойчивости

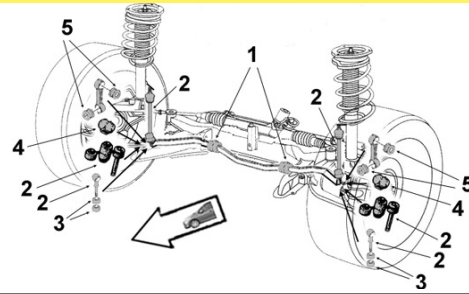

0945805

OE 509480

Palier de barre milieu

Middle bar main bearing



1 Barre Ø 19

1.6i	Berline 3/5ptes	VP/ Comm.	TU5JP	-30/10/01
1.6i 16v.	Berline 3/5ptes	VP/ Comm.	TU5JP4	-30/10/01
2.0 HDi	Berline 3/5ptes	VP/ Comm.	DW10TD	-23/09/01

2300005

OE 509482

Palier de barre milieu

Middle bar main bearing



1 Barre Ø 20

1.1i	Berline 3/5ptes		TU1JP	02/04/02-
1.4i 16v.	Berline 3/5ptes		ET3J4	
1.4i	Berline 3/5ptes		TU3JP	02/04/02-
1.4i	Berline 3/5ptes		TU3A	
1.4 HDi	Berline 3/5ptes		DV4TD	07/01/02-
1.6i 16v.	Berline 3/5ptes		TU5JP4	31/10/01-
1.6i 16v.	CC		TU5JP4	
1.6 HDi	Berline 3/5ptes		DV6TED4	
1.9 D	Berline 3/5ptes		DW8	02/04/02-
1.9 D	Berline 3/5ptes		DW8B	02/04/02-
2.0i 16v.	Berline 3/5ptes		EW10J4	
2.0i 16v.	CC		EW10J4	02/10/05-
2.0 HDi	Berline 3/5ptes		DW10TD	24/09/01-

2300006

OE 509495

Palier de barre milieu

Middle bar main bearing



1 Barre Ø 21

1.4i	Berline 4/5ptes		TU3A/F	
1.6i 16v.	Berline 4ptes		TU5JP4G	
1.6i 16v.	Berline 4ptes	Susp. normale	TU5JP4	
1.6i 16v.	Berline 5ptes		TU5JP4	-10/05
1.6 HDi	Break		DV6TED4	
1.6 HDi	CC FAP		DV6TED4	
2.0i 16v.	Berline 3ptes		EW10J4S	
2.0i 16v.	CC		EW10J4	-03/10/05
2.0 HDi	Break		DW10TD	

2300007

OE 509494

Palier de barre milieu

Middle bar main bearing



1 Barre Ø 22

1.1i	SW		TU1JP	
1.4i 16v.	SW		ET3J4	
1.4i	SW		TU3A/JP	
1.4 HDi	SW		DV4TD	
1.6i 16v.	SW		TU5JP4	
2.0i 16v.	SW		EW10J4	



Eléments SUSPENSION
Suspension parts
Elementos suspensión
Elementy zawieszenie
Элементы подвески

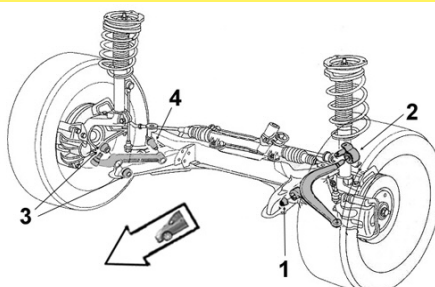

5233763

OE 352376

Articulation AV

Front bush



1 Ø int.14 Ø ext.55 long. tube int.50 ext.26

1.1i Berline comm. 3ptes	TU1JP/L3 HFZ	09/98-09/00
1.1i Berline 3ptes	TU1JP/L3A HFY	09/98-
1.1i Berline 3ptes Comm.	TU1JP/L4 HFX	09/00-
1.1i Berline 5ptes	TU1JP/L3 HFZ	09/98-09/00
1.1i Berline 5ptes	TU1JP/L3A HFY	09/98-
1.1i Berline 5ptes	TU1JP/L4 HFX	09/00-
1.1i SW	TU1JP/L4 HFX	05/02-
1.4i /SW	TU3JP	-12/09/02
1.4 HDi	DV4TD	-12/09/02
1.6i 16v. CC	TU5JP4	-12/09/02
1.6i 90hp 66kw	TU5JP	
1.9 D	DW8/B	-12/09/02
2.0 HDi	DW10TD	-13/09/02

2250001

OE 3523AG

Articulation AV

Front bush



1 Ø int.15 Ø ext.55 long. tube int.50 ext.32

1.1i	TU1JP	13/09/02-
1.1i SW	TU1JP	14/09/02-
1.4i	TU3JP	13/09/02-
1.4i	TU3A	
1.4i 16v./ SW	ET3J4	
1.4i SW	TU3JP	14/09/02-
1.4i SW	TU3A	
1.4 HDi	DV4TD	13/09/02-
1.4 HDi SW	DV4TD	14/09/02-
1.6i 16v. Berline 3ptes	TU5JP4	19/11/02-
1.6i 16v. Berline 4ptes	TU5JP4	26/05/05-
1.6i 16v. Berline 5ptes	TU5JP4	27/06/05-
1.6i 16v. CC	TU5JP4	13/09/02-
1.6i 16v. SW sauf Escapade	TU5JP4	25/09/02-
1.6 HDi Sans FAP	DV6TED4	
1.6 HDi CC FAP Coupé Cab.	DV6TED4	
1.6 HDi FAP sauf GTi /S16	DV6TED4	
1.9 D	DW8/B	13/09/02-
2.0i 16v. CC	EW10J4	14/09/02-
2.0 HDi	DW10TD	13/09/02-
2.0 HDi SW	DW10TD	14/09/02-

5233773

OE 352377

Articulation AR

Rear bush



2 Ø int.14 Ø ext.55 coll.61 long. tube int.49 ext.22 ep. coll.2.5

1.1i Berline comm. 3ptes	TU1JP/L3 HFZ	09/98-09/00
1.1i Berline 3ptes	TU1JP/L3A HFY	09/98-
1.1i Berline 3ptes Comm.	TU1JP/L4 HFX	09/00-
1.1i Berline 5ptes	TU1JP/L3 HFZ	09/98-09/00
1.1i Berline 5ptes	TU1JP/L3A HFY	09/98-
1.1i Berline 5ptes	TU1JP/L4 HFX	09/00-
1.1i SW	TU1JP/L4 HFX	05/02-
1.4i /SW	TU3JP ET3J4	
1.4 HDi	DV4TD	
1.6i 16v. Berline 5ptes VP/ Comm. / CC Coupé Cab.	TU5JP4	
1.6i 90hp 66kw	TU5JP	
1.9 D	DW8/B	
2.0i 16v. CC	EW10J4	
2.0 HDi	DW10TD	

Bras & Triangle de suspension

Control arm
Brazo y triángulo
Wahacz
Рычаг подвески

G/L  D/R



5203G83
OE 3520G8

Triangle de susp. G
Left track control arm



4 Avec rotule *With ball joint*

1.1i Berline	TU1JP/L3 HFZ	09/98-09/00
1.1i Berline	TU1JP/L3A HFY	09/98-12/09/02
1.1i Berline	TU1JP/L4 HFX	09/00-12/09/02
1.1i SW	TU1JP/L4 HFX	05/02-13/09/02
1.4i Berline 3/5ptes VP/ Comm.	TU3JP	-12/09/02
1.4i Break	TU3JP	-13/09/02
1.4 HDi Berline 3/5ptes VP/ Comm.	DV4TD	-12/09/02
1.6i 16v. CC	TU5JP4	-12/09/02
1.6i 90hp 66kw Berline 3/5ptes VP/ Comm.	TU5JP	-12/09/02
1.6i 16v. Berline 3/5ptes VP/ Comm.	TU5JP4	-18/11/02
1.6i 16v. Break	TU5JP4	-24/09/02
1.6 HDi FAP GTi / S16 Berline Break	DV6TED4	
1.9 D Berline 3/5ptes VP/ Comm.	DW8/B	-12/09/02
2.0i 16v. CC	EW10J4	-12/09/02
2.0i 16v. Berline 3ptes VP/ Comm.	EW10J4/S	
2.0i 16v. Break	EW10J4	
2.0 HDi Berline 3/5ptes VP/ Comm.	DW10TD	-12/09/02
2.0 HDi Break	DW10TD	-13/09/02

5213C83
OE 3521C8

Triangle de susp. D
Right track control arm



3 Avec rotule *With ball joint*

1.1i Berline	TU1JP/L3 HFZ	09/98-09/00
1.1i Berline	TU1JP/L3A HFY	09/98-12/09/02
1.1i Berline	TU1JP/L4 HFX	09/00-12/09/02
1.1i SW	TU1JP/L4 HFX	05/02-13/09/02
1.4i Berline 3/5ptes VP/ Comm.	TU3JP	-12/09/02
1.4i Break	TU3JP	-13/09/02
1.4 HDi Berline 3/5ptes VP/ Comm.	DV4TD	-12/09/02
1.6i 90hp 66kw Berline 3/5ptes VP/ Comm.	TU5JP	-12/09/02
1.9 D Berline 3/5ptes VP/ Comm.	DW8/B	-12/09/02
2.0 HDi Berline 3/5ptes VP/ Comm.	DW10TD	-12/09/02
2.0 HDi Break	DW10TD	-13/09/02
1.6i 16v. CC	TU5JP4	-12/09/02
1.6i 16v. Berline 3/5ptes VP/ Comm.	TU5JP4	-18/11/02
1.6i 16v. Break	TU5JP4	-24/09/02
1.6 HDi FAP GTi / S16 Berline Break	DV6TED4	
2.0i 16v. CC	EW10J4	-12/09/02
2.0i 16v. Berline 3ptes VP/ Comm.	EW10J4/S	
2.0i 16v. Break	EW10J4	

5203L73
OE 3520W0





Triangle de susp. inf. G
Lower left track control arm



4 Avec rotule *With ball joint*

1.1i Berline 3/5ptes VP/ Comm.	TU1JP	13/09/02-
1.1i Break	TU1JP	14/09/02-
1.4i Berline 3/5ptes VP/ Comm.	TU3JP	13/09/02-
1.4i Break	TU3JP	14/09/02-
1.4i Berline Break /5ptes	TU3A/AF	
1.4i 16v. SW	ET3J4	
1.4 HDi Berline 3/5ptes VP/ Comm.	DV4TD	13/09/02-
1.4 HDi Break	DV4TD	14/09/02-
1.6i 16v. CC	TU5JP4 BVA	13/09/02-
1.6i 90hp 66kw Berline 3/5ptes VP/ Comm.	TU5JP	13/09/02-
1.9 D Berline 3/5ptes VP/ Comm.	DW8/B	13/09/02-
2.0 HDi Berline 3/5ptes VP/ Comm.	DW10TD	13/09/02-
2.0 HDi Break	DW10TD	14/09/02-







... 206 ...																																																					
<p>5213H93 OE 3521S1</p> 	<p>Triangle de susp. inf. D <i>Lower right track control arm</i></p> <p>3 Avec rotule <i>With ball joint</i></p> <table border="0"> <tr><td>1.1i Berline 3/5ptes VP/ Comm.</td><td>TU1JP</td><td></td><td>13/09/02-</td></tr> <tr><td>1.1i Break</td><td>TU1JP</td><td></td><td>14/09/02-</td></tr> <tr><td>1.4i Berline 3/5ptes VP/ Comm.</td><td>TU3JP</td><td></td><td>13/09/02-</td></tr> <tr><td>1.4i Break</td><td>TU3JP</td><td></td><td>14/09/02-</td></tr> <tr><td>1.4i Berline Break / 5ptes</td><td>TU3A/AF</td><td></td><td></td></tr> <tr><td>1.4i 16v. SW</td><td>ET3J4</td><td></td><td></td></tr> <tr><td>1.4 HDi Berline 3/5ptes VP/ Comm.</td><td>DV4TD</td><td></td><td>13/09/02-</td></tr> <tr><td>1.4 HDi Break</td><td>DV4TD</td><td></td><td>14/09/02-</td></tr> <tr><td>1.6i 16v. CC</td><td>TU5JP4</td><td>BVA</td><td>13/09/02-</td></tr> <tr><td>1.6i 90hp 66kw Berline 3/5ptes VP/ Comm.</td><td>TU5JP</td><td></td><td>13/09/02-</td></tr> <tr><td>1.9 D Berline 3/5ptes VP/ Comm.</td><td>DW8/B</td><td></td><td>13/09/02-</td></tr> <tr><td>2.0 HDi Berline 3/5ptes VP/ Comm.</td><td>DW10TD</td><td></td><td>13/09/02-</td></tr> <tr><td>2.0 HDi Break</td><td>DW10TD</td><td></td><td>14/09/02-</td></tr> </table>	1.1i Berline 3/5ptes VP/ Comm.	TU1JP		13/09/02-	1.1i Break	TU1JP		14/09/02-	1.4i Berline 3/5ptes VP/ Comm.	TU3JP		13/09/02-	1.4i Break	TU3JP		14/09/02-	1.4i Berline Break / 5ptes	TU3A/AF			1.4i 16v. SW	ET3J4			1.4 HDi Berline 3/5ptes VP/ Comm.	DV4TD		13/09/02-	1.4 HDi Break	DV4TD		14/09/02-	1.6i 16v. CC	TU5JP4	BVA	13/09/02-	1.6i 90hp 66kw Berline 3/5ptes VP/ Comm.	TU5JP		13/09/02-	1.9 D Berline 3/5ptes VP/ Comm.	DW8/B		13/09/02-	2.0 HDi Berline 3/5ptes VP/ Comm.	DW10TD		13/09/02-	2.0 HDi Break	DW10TD		14/09/02-
1.1i Berline 3/5ptes VP/ Comm.	TU1JP		13/09/02-																																																		
1.1i Break	TU1JP		14/09/02-																																																		
1.4i Berline 3/5ptes VP/ Comm.	TU3JP		13/09/02-																																																		
1.4i Break	TU3JP		14/09/02-																																																		
1.4i Berline Break / 5ptes	TU3A/AF																																																				
1.4i 16v. SW	ET3J4																																																				
1.4 HDi Berline 3/5ptes VP/ Comm.	DV4TD		13/09/02-																																																		
1.4 HDi Break	DV4TD		14/09/02-																																																		
1.6i 16v. CC	TU5JP4	BVA	13/09/02-																																																		
1.6i 90hp 66kw Berline 3/5ptes VP/ Comm.	TU5JP		13/09/02-																																																		
1.9 D Berline 3/5ptes VP/ Comm.	DW8/B		13/09/02-																																																		
2.0 HDi Berline 3/5ptes VP/ Comm.	DW10TD		13/09/02-																																																		
2.0 HDi Break	DW10TD		14/09/02-																																																		
<p>5203L83 OE 3520V7</p> 	<p>Triangle de susp. inf. G <i>Lower left track control arm</i></p> <p>4 Avec rotule <i>With ball joint</i></p> <table border="0"> <tr><td>1.4i 16v. Berline 3/5ptes VP/ Comm.</td><td>ET3J4</td><td></td><td></td></tr> <tr><td>1.6i 16v. CC</td><td>TU5JP4</td><td>BVM</td><td>13/09/02-</td></tr> <tr><td>1.6i 16v. /CC</td><td>TU5JP4</td><td></td><td>19/11/02-</td></tr> <tr><td>1.6i 16v. Break</td><td>TU5JP4</td><td></td><td>25/09/02-</td></tr> <tr><td>1.6 HDi FAP CC</td><td>DV6TED4</td><td></td><td></td></tr> <tr><td>1.6 HDi FAP Berline 3/5ptes VP/ Comm. Sauf niveau GTi/S16</td><td>DV6TED4</td><td></td><td></td></tr> <tr><td>2.0i 16v. CC</td><td>EW10J4</td><td></td><td>13/09/02-</td></tr> </table>	1.4i 16v. Berline 3/5ptes VP/ Comm.	ET3J4			1.6i 16v. CC	TU5JP4	BVM	13/09/02-	1.6i 16v. /CC	TU5JP4		19/11/02-	1.6i 16v. Break	TU5JP4		25/09/02-	1.6 HDi FAP CC	DV6TED4			1.6 HDi FAP Berline 3/5ptes VP/ Comm. Sauf niveau GTi/S16	DV6TED4			2.0i 16v. CC	EW10J4		13/09/02-																								
1.4i 16v. Berline 3/5ptes VP/ Comm.	ET3J4																																																				
1.6i 16v. CC	TU5JP4	BVM	13/09/02-																																																		
1.6i 16v. /CC	TU5JP4		19/11/02-																																																		
1.6i 16v. Break	TU5JP4		25/09/02-																																																		
1.6 HDi FAP CC	DV6TED4																																																				
1.6 HDi FAP Berline 3/5ptes VP/ Comm. Sauf niveau GTi/S16	DV6TED4																																																				
2.0i 16v. CC	EW10J4		13/09/02-																																																		
<p>5213J03 OE 3521R9</p> 	<p>Triangle de susp. inf. D <i>Lower right track control arm</i></p> <p>3 Avec rotule <i>With ball joint</i></p> <table border="0"> <tr><td>1.4i 16v. Berline 3/5ptes VP/ Comm.</td><td>ET3J4</td><td></td><td></td></tr> <tr><td>1.6i 16v. CC</td><td>TU5JP4</td><td>BVM</td><td>13/09/02-</td></tr> <tr><td>1.6i 16v. /CC</td><td>TU5JP4</td><td></td><td>19/11/02-</td></tr> <tr><td>1.6i 16v. Break</td><td>TU5JP4</td><td></td><td>25/09/02-</td></tr> <tr><td>1.6 HDi FAP CC</td><td>DV6TED4</td><td></td><td></td></tr> <tr><td>1.6 HDi FAP Berline 3/5ptes VP/ Comm. Sauf niveau GTi/S16</td><td>DV6TED4</td><td></td><td></td></tr> <tr><td>2.0i 16v. CC</td><td>EW10J4</td><td></td><td>13/09/02-</td></tr> </table>	1.4i 16v. Berline 3/5ptes VP/ Comm.	ET3J4			1.6i 16v. CC	TU5JP4	BVM	13/09/02-	1.6i 16v. /CC	TU5JP4		19/11/02-	1.6i 16v. Break	TU5JP4		25/09/02-	1.6 HDi FAP CC	DV6TED4			1.6 HDi FAP Berline 3/5ptes VP/ Comm. Sauf niveau GTi/S16	DV6TED4			2.0i 16v. CC	EW10J4		13/09/02-																								
1.4i 16v. Berline 3/5ptes VP/ Comm.	ET3J4																																																				
1.6i 16v. CC	TU5JP4	BVM	13/09/02-																																																		
1.6i 16v. /CC	TU5JP4		19/11/02-																																																		
1.6i 16v. Break	TU5JP4		25/09/02-																																																		
1.6 HDi FAP CC	DV6TED4																																																				
1.6 HDi FAP Berline 3/5ptes VP/ Comm. Sauf niveau GTi/S16	DV6TED4																																																				
2.0i 16v. CC	EW10J4		13/09/02-																																																		
<p>1003588 OE -</p> 	<p>Kit rép. triangle susp. G ou D <i>L or R track control arm bearing repair kit</i></p> <p>Sans visserie <i>Without screws and bolts</i></p> <table border="0"> <tr><td>1.1i Berline</td><td>TU1JP/L3 HFZ</td><td></td><td>09/98-09/00</td></tr> <tr><td>1.1i Berline</td><td>TU1JP/L3A HFY</td><td></td><td>09/98-12/09/02</td></tr> <tr><td>1.1i Berline</td><td>TU1JP/L4 HFX</td><td></td><td>09/00-12/09/02</td></tr> <tr><td>1.1i SW</td><td>TU1JP/L4 HFX</td><td></td><td>05/02-13/09/02</td></tr> <tr><td>1.4 Berline</td><td>TU3JP</td><td></td><td>-12/09/02</td></tr> <tr><td>1.4 Break</td><td>TU3JP</td><td></td><td>-13/09/02</td></tr> <tr><td>1.4 HDi Berline</td><td>DV4TD</td><td></td><td>-12/09/02</td></tr> <tr><td>1.4 HDi Break</td><td>DV4TD</td><td></td><td>-13/09/02</td></tr> <tr><td>1.6i 16v. CC</td><td>TU5JP4</td><td>BVM</td><td>-12/09/02</td></tr> <tr><td>1.6 90hp 66kw Berline</td><td>TU5JP</td><td></td><td>-12/09/02</td></tr> <tr><td>1.9 D Berline</td><td>DW8</td><td></td><td>-12/09/02</td></tr> <tr><td>2.0 HDi Berline</td><td>DW10TD</td><td></td><td>-12/09/02</td></tr> <tr><td>2.0 HDi Break</td><td>DW10TD</td><td></td><td>-13/09/02</td></tr> </table>	1.1i Berline	TU1JP/L3 HFZ		09/98-09/00	1.1i Berline	TU1JP/L3A HFY		09/98-12/09/02	1.1i Berline	TU1JP/L4 HFX		09/00-12/09/02	1.1i SW	TU1JP/L4 HFX		05/02-13/09/02	1.4 Berline	TU3JP		-12/09/02	1.4 Break	TU3JP		-13/09/02	1.4 HDi Berline	DV4TD		-12/09/02	1.4 HDi Break	DV4TD		-13/09/02	1.6i 16v. CC	TU5JP4	BVM	-12/09/02	1.6 90hp 66kw Berline	TU5JP		-12/09/02	1.9 D Berline	DW8		-12/09/02	2.0 HDi Berline	DW10TD		-12/09/02	2.0 HDi Break	DW10TD		-13/09/02
1.1i Berline	TU1JP/L3 HFZ		09/98-09/00																																																		
1.1i Berline	TU1JP/L3A HFY		09/98-12/09/02																																																		
1.1i Berline	TU1JP/L4 HFX		09/00-12/09/02																																																		
1.1i SW	TU1JP/L4 HFX		05/02-13/09/02																																																		
1.4 Berline	TU3JP		-12/09/02																																																		
1.4 Break	TU3JP		-13/09/02																																																		
1.4 HDi Berline	DV4TD		-12/09/02																																																		
1.4 HDi Break	DV4TD		-13/09/02																																																		
1.6i 16v. CC	TU5JP4	BVM	-12/09/02																																																		
1.6 90hp 66kw Berline	TU5JP		-12/09/02																																																		
1.9 D Berline	DW8		-12/09/02																																																		
2.0 HDi Berline	DW10TD		-12/09/02																																																		
2.0 HDi Break	DW10TD		-13/09/02																																																		
<p>1003588S (en/in Skinpack)</p>																																																					

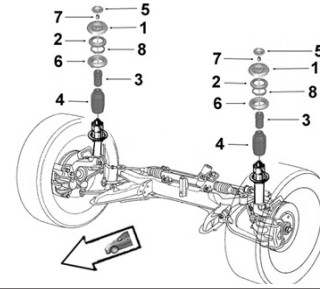

Support d'amortisseur
Suspension mounting
Soporte amortiguador
Poduszka amortyzatora
Опора амортизатора



<p>0385345 OE 5038C7</p> 	<p>Support suspension G <i>Left suspension mounting</i></p> <p>1 1.1i Berline 5ptes /comm. 3ptes DNA susp. normale avec barre stab. TU1JP/L3 HFZ 09/98-09/00 1.1i Berline 3ptes/ 5ptes DNA susp. normale avec barre stab. TU1JP/L3A HFY 09/98- 1.1i Berline DNA susp. normale avec barre stab. TU1JP/L4 HFX 09/00- 1.4i Berline 3/5ptes DNA susp. normale susp. renforcée TU3JP</p>	<p>0385A15 OE 5038C8</p> 	<p>Support suspension D <i>Right suspension mounting</i></p> <p>1 1.1i Berline 5ptes /comm. 3ptes DNA susp. normale avec barre stab. TU1JP/L3 HFZ 09/98-09/00 1.1i Berline 3ptes/ 5ptes DNA susp. normale avec barre stab. TU1JP/L3A HFY 09/98- 1.1i Berline DNA susp. normale avec barre stab. TU1JP/L4 HFX 09/00- 1.4i Berline 3/5ptes DNA susp. normale susp. renforcée TU3JP</p>
<p>0385565 OE 503856</p> 	<p>Support suspension G <i>Left suspension mounting</i></p> <p>1 1.1i Berline comm. 3ptes DA susp. normale sans barre stab. TU1JP/L3 HFZ 09/98-09/00 1.1i Berline 5ptes DA susp. normale sans barre stab. TU1JP/L3 HFY 09/98- 1.1i Berline 5ptes DA susp. renforcée TU1JP/L3 HFZ 09/98-09/00 1.1i Berline 3ptes DA susp. normale sans barre stab. TU1JP/L3A HFY 09/98- 1.1i Berline 3ptes /5ptes DA susp. renforcée TU1JP/L3A HFY 09/98- 1.1i Berline DA susp. normale sans barre stab. TU1JP/L4 HFX 09/00- 1.1i Berline DA susp. renforcée TU1JP/L4 HFX 09/00- 1.4 HDi Berline 3ptes Comm. susp. normale /renforcée DV4TD 1.9 D Berline 3/5ptes /Comm. susp. normale /renforcée DW8/B</p>		
<p>0385605 OE 503860</p> 	<p>Support suspension D <i>Right suspension mounting</i></p> <p>1 1.1i Berline comm. 3ptes DA susp. normale sans barre stab. TU1JP/L3 HFZ 09/98-09/00 1.1i Berline 5ptes DA susp. normale sans barre stab. TU1JP/L3 HFY 09/98- 1.1i Berline 5ptes DA susp. renforcée TU1JP/L3 HFZ 09/98-09/00 1.1i Berline 3ptes DA susp. normale sans barre stab. TU1JP/L3A HFY 09/98- 1.1i Berline 3ptes /5ptes DA susp. renforcée TU1JP/L3A HFY 09/98- 1.1i Berline DA susp. normale sans barre stab. TU1JP/L4 HFX 09/00- 1.1i Berline DA susp. renforcée TU1JP/L4 HFX 09/00- 1.4 HDi Berline 3ptes /Comm. susp. normale /renforcée DV4TD 1.9 D Berline 3/5ptes /Comm. susp. normale /renforcée DW8/B</p>		
<p>0385365 OE 5038C5</p> 	<p>Support suspension G <i>Left suspension mounting</i></p> <p>1 1.1i Berline comm. 3ptes DA susp. normale avec barre stab. TU1JP/L3 HFZ 09/98-09/00 1.1i Berline 3ptes /Comm. DA susp. normale avec barre stab. TU1JP/L4 HFX 09/00- 1.1i Berline 3ptes /Comm. DA susp. normale avec barre stab. TU1JP/L3A HFY 09/98- 1.1i Berline 5ptes DA susp. normale avec barre stab. TU1JP/L3 HFZ 09/98-09/00 1.1i Berline 5ptes DA susp. normale avec barre stab. TU1JP/L4 HFX 09/00- 1.1i Berline 5ptes DA susp. normale avec barre stab. TU1JP/L3A HFY 09/98- 1.1i SW DA TU1JP/L4 HFX 05/02- 1.4i 16v. Berline 5ptes Break 5ptes susp. normale ET3J4 1.4i Berline 3/5ptes DA susp. normale susp. renforcée TU3JP 1.4i Break 5ptes TU3JP 1.4 HDi Berline 5ptes VP/ Comm. susp. normale /renforcée DV4TD 1.4 HDi Break 5ptes DV4TD 1.6i 16v. Berline 3/5ptes susp. normale /renforcée TU5JP4 1.6i 16v. Break 5ptes /CC TU5JP4 1.6i Berline 3/5ptes susp. normale /renforcée TU5JP 1.6 HDi Berline 3/5ptes Break 5ptes susp. normale DV6TED4 1.6 HDi Fap CC DV6TED4 1.9 D Berline 3/5ptes susp. normale /renforcée DW8/B 2.0i 16v. EW10J4/S 2.0i 16v. Break 5ptes /CC EW10J4 2.0 HDi Berline 3/5ptes /Comm. susp. normale /renforcée DW10TD 2.0 HDi Break 5ptes DW10TD</p>		



0385405

Support suspension D

OE 503858 /5038C6 /503858 *Right suspension mounting*



1	1.1i Berline comm. 3ptes DA susp. normale avec barre stab.	TU1JP/L3 HFZ	09/98-09/00
	1.1i Berline 3ptes /Comm. DA susp. normale avec barre stab.	TU1JP/L4 HFX	09/00-
	1.1i Berline 3ptes /Comm. DA susp. normale avec barre stab.	TU1JP/L3A HFY	09/98-
	1.1i Berline 5ptes DA susp. normale avec barre stab.	TU1JP/L3 HFZ	09/98-09/00
	1.1i Berline 5ptes DA susp. normale avec barre stab.	TU1JP/L4 HFX	09/00-
	1.1i Berline 5ptes DA susp. normale avec barre stab.	TU1JP/L3A HFY	09/98-
	1.1i SW DA	TU1JP/L4 HFX	05/02-
	1.4i 16v. Berline 5ptes Break 5ptes susp. normale	ET3J4	
	1.4i Berline 3/5ptes DA susp. normale susp. renforcée	TU3JP	
	1.4i Break 5ptes	TU3JP	
	1.4 HDi Berline 5ptes VP/ Comm. susp. normale /renforcée	DV4TD	
	1.4 HDi Break 5ptes	DV4TD	
	1.6i 16v. Berline 3/5ptes susp. normale /renforcée	TU5JP4	
	1.6i 16v. Break 5ptes /CC	TU5JP4	
	1.6i Berline 3/5ptes susp. normale /renforcée	TU5JP	
	1.6 HDi Berline 3/5ptes Break 5ptes susp. normale	DV6TED4	
	1.6 HDi Fap CC	DV6TED4	
	1.9 D Berline 3/5ptes susp. normale /renforcée	DW8/B	
	2.0i 16v.	EW10J4/S	
	2.0i 16v. Break 5ptes /CC	EW10J4	
2.0 HDi Berline 3/5ptes /Comm. susp. normale /renforcée	DW10TD		
2.0 HDi Break 5ptes	DW10TD		

0355275

Butée à billes G/D

OE 503563 *L/R ball bearing*



2	1.1i Berline 3ptes Comm.	TU1JP/L3 HFZ	09/98-09/00
	1.1i Berline 3ptes	TU1JP/L3A HFY	09/98-
	1.1i Berline 3ptes Comm.	TU1JP/L4 HFX	09/00-
	1.1i Berline 5ptes	TU1JP/L3 HFZ	09/98-09/00
	1.1i Berline 5ptes	TU1JP/L3A HFY	09/98-
	1.1i Berline 5ptes	TU1JP/L4 HFX	09/00-
	1.1i SW	TU1JP/L4 HFX	05/02-
	1.4i	TU3JP	
	1.4i 16v.	ET3J4	10/03-
	1.4 HDi	DV4TD	
	1.6i	TU5JP	
	1.6i 16v.	TU5JP4	
	1.6 HDi	DV6TED4	
	1.9 D	DW8/B	
	2.0i 16v.	EW10J4/S	
2.0 HDi	DW10TD		

0335585

Butée de suspension G/D

OE 503358 *L/R suspension bush*



3	H73		
	1.1i Berline 3ptes susp. normale	TU1JP/L3A HFY	09/98-
	1.1i Berline 3ptes susp. renforcée	TU1JP/L3A HFY	09/98-
	1.1i Berline 3ptes /Comm. susp. normale	TU1JP/L3 HFZ	09/98-09/00
	1.1i Berline 3ptes /Comm. susp. renforcée	TU1JP/L3 HFZ	09/98-09/00
	1.1i Berline 3ptes /Comm. susp. normale	TU1JP/L4 HFX	09/00-31/10/00
	1.1i Berline 3ptes /Comm. susp. renforcée	TU1JP/L4 HFX	09/00-
	1.1i Berline 5ptes susp. normale	TU1JP/L3A HFY	09/98-
	1.1i Berline 5ptes susp. renforcée	TU1JP/L3A HFY	09/98-
	1.1i Berline 5ptes susp. normale	TU1JP/L3 HFZ	09/98-09/00
	1.1i Berline 5ptes susp. renforcée	TU1JP/L3 HFZ	09/98-09/00
	1.1i Berline 5ptes susp. normale	TU1JP/L4 HFX	09/00-31/10/00
	1.1i Berline 5ptes susp. renforcée	TU1JP/L4 HFX	09/00-
	1.4i Berline 3/5ptes susp. normale /renforcée	TU3JP	
	1.4 HDi Berline/ comm. susp. normale /renforcée	DV4TD	
	1.6i 16v. Berline 3/5ptes susp. normale /renforcée	TU5JP4	
	1.6i Berline 3/5ptes susp. normale /renforcée	TU5JP	
	1.6 HDi Berline Break sauf GTi S16 susp. normale	DV6TED4	
	1.9 D Berline 3/5ptes /Comm. susp. normale /renforcée	DW8/B	



Support d'amortisseur
 Suspension mounting
 Soporte amortiguador
 Poduszka amortyzatora
 Опора амортизатора

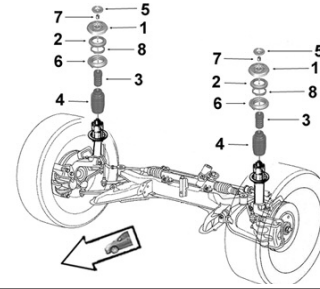

0335685

OE 503368

Butée de suspension G/D

L/R suspension bush



3 H70

1.1i Berline comm. / 3ptes susp. normale	TU1JP/L4 HFX	11/00-
1.1i Berline 5ptes susp. normale	TU1JP/L4 HFX	11/00-

2650007

OE 503360

Butée de suspension G/D

L/R suspension bush



3 H80

1.1i Break 5ptes	TU1JP	
1.4i 16v. Berline 3/5ptes susp. normale	ET3J4	
1.4i 16v. Break 5ptes susp. normale	ET3J4	
1.4i Berline 4ptes Break	TU3A	
1.4i Berline 5ptes	TU3AF	
1.4i Break 5ptes	TU3JP	
1.4 HDi Break 5ptes	DV4TD	
1.6i 16v. Berline 4ptes	TU5JP4	
1.6i 16v. Berline 4ptes	TU5JP4G	
1.6i 16v. Berline 5ptes Susp. renforcée AV AR	TU5JP4	31/10/05-
1.6i 16v. Break 5ptes	TU5JP4	
1.6i 16v. CC	TU5JP4	
1.6 HDi CC	DV6TED4	
2.0i 16v. Berline 3ptes /Comm.	EW10J4	-07/03/04
2.0i 16v. Break 5ptes	EW10J4	
2.0i 16v. CC	EW10J4	
2.0 HDi	DW10TD	

2545335

OE 525433

Protecteur amortisseur G/D

L/R shock absorber protector

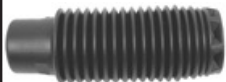

4

1.1i SW	TU1JP/L4 HFX	05/02-
1.4i 16v. susp. normale	ET3J4	
1.4i Berline susp. normale	TU3JP	-15/06/03
1.4i Berline susp. renforcée	TU3JP	-18/02/04
1.4i Break 5ptes	TU3JP	-15/06/03
1.4 HDi Berline comm. 5ptes susp. normale /renforcée	DV4TD	
1.4 HDi Break 5ptes	DV4TD	
1.6i susp. normale	TU5JP	
1.6i 16v. Berline 3ptes susp. renforcée AV AR	TU5JP4	02/09/00-18/02/04
1.6i 16v. Berline 5ptes susp. normale	TU5JP4	
1.6i 16v. Berline 5ptes susp. renforcée AV AR	TU5JP4	04/09/00-
1.6i 16v. Break 5ptes	TU5JP4	18/02/02-
1.6i 16v. CC	TU5JP4	-10/06/03
1.6 HDi	DV6TED4	
1.9 D Berline 3ptes susp. renforcée AV AR	DW8/B	04/01/99-18/02/04
1.9 D Berline 5ptes susp. normale	DW8/B	
1.9 D Berline 5ptes susp. renforcée AV AR	DW8B	02/05/00-
2.0i 16v.	EW10J4S	
2.0i 16v. Berline 3ptes susp. normale	EW10J4	
2.0i 16v. Break 5ptes	EW10J4	-15/06/03

Suite

... 206 ...

... 2545335

OE 525433

Protecteur amortisseur G/D

L/R shock absorber protector



4

2.0i 16v. CC	EW10J4	-10/06/03
2.0 HDi Berline 3/5ptes susp. normale	DW10TD	
2.0 HDi Break 5ptes	DW10TD	18/02/02-

1005274

OE -

Kit rép. suspension G

Left susp. mounting repair kit



1.1i Berline DA susp. normale avec barre stab.	TU1JP/L3 HFZ	09/98-09/00
1.1i Berline DA susp. normale avec barre stab.	TU1JP/L3A HFY	09/98-
1.1i Berline DA susp. normale avec barre stab.	TU1JP/L4 HFX	09/00-
1.1i SW	TU1JP/L4 HFX	05/02-
1.4 Berline 3/5ptes DA susp. normale	TU3JP	
1.4 Berline 3/5ptes DA susp. renforcée	TU3JP	
1.4 Break 5ptes	TU3JP	
1.4 HDi Berline 5ptes VP/ Comm. susp. normale /renforcée	DV4TD	
1.4 HDi Break 5ptes	DV4TD	
1.6 Berline 3/5ptes susp. normale /renforcée	TU5JP	
1.6i 16v. Berline 3/5ptes susp. normale /renforcée	TU5JP4	
1.6i 16v. Break 5ptes	TU5JP4	
1.6i 16v. CC	TU5JP4	
1.9 D Berline 3/5ptes susp. normale /renforcée	DW8/B	
2.0i 16v.	EW10J4/S	
2.0i 16v. Break 5ptes	EW10J4	
2.0i 16v. CC	EW10J4	
2.0 HDi Berline 3/5ptes /Comm. susp. normale /renforcée	DW10TD	
2.0 HDi Break 5ptes	DW10TD	

1005276

OE -

Kit rép. suspension D

Right susp. mounting repair kit



1.1i Berline DA susp. normale avec barre stab.	TU1JP/L3 HFZ	09/98-09/00
1.1i Berline DA susp. normale avec barre stab.	TU1JP/L3A HFY	09/98-
1.1i Berline DA susp. normale avec barre stab.	TU1JP/L4 HFX	09/00-
1.1i SW	TU1JP/L4 HFX	05/02-
1.4 DA susp. normale	TU3JP	
1.4 Berline 3/5ptes DA susp. renforcée	TU3JP	
1.4 Break 5ptes	TU3JP	
1.4 HDi Berline 5ptes VP/ Comm. susp. normale /renforcée	DV4TD	
1.4 HDi Break 5ptes	DV4TD	
1.6 Berline 3/5ptes susp. normale /renforcée	TU5JP	
1.6i 16v. Berline 3/5ptes susp. normale /renforcée	TU5JP4	
1.6i 16v. Break 5ptes	TU5JP4	
1.6i 16v. CC	TU5JP4	
1.9 D Berline 3/5ptes susp. normale /renforcée	DW8/B	
2.0i 16v.	EW10J4/S	
2.0i 16v. Break 5ptes	EW10J4	
2.0i 16v. CC	EW10J4	
2.0 HDi Berline 3/5ptes /Comm. susp. normale /renforcée	DW10TD	
2.0 HDi Break 5ptes	DW10TD	

PEUGEOT



... 206 ...



PEUGEOT



Support d'amortisseur
 Suspension mounting
 Soporte amortiguador
 Poduszka amortyzatora
 Опора амортизатора

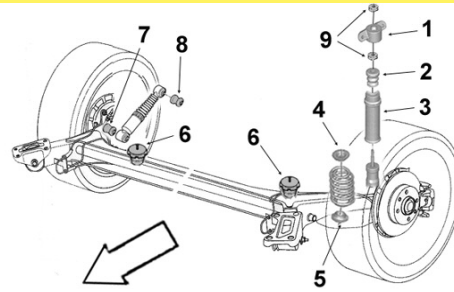

1665375

OE 516637

Butée de talonnage

Bushing



6 H48

1.1i Berline susp. normale	TU1JP/L3 HFZ	09/98-09/00
1.1i Berline susp. normale	TU1JP/L3A HFY	09/98-
1.1i Berline susp. normale	TU1JP/L4 HFX	09/00-
1.4i Berline 3/5ptes susp. normale	TU3JP	
1.6i Berline 3/5ptes susp. normale	TU5JP	
1.9 D Berline 3/5ptes susp. normale	DW8/B	
2.0i 16v. Berline 3/5ptes /CC	EW10J4	
2.0 HDi Berline 3/5ptes susp. normale	DW10TD	

Eléments TRAIN ARRIERE

Rear axle parts

Tren TRAS

Elementy zawieszenia tylnego

элементы задней оси.



1315935

OE 5131F8

Art. AV de traverse

Cross bar front bush



Ø int.17 Ø ext.48 coll.68 long. tube int.61 ext.44 ep. coll.13

1.1i Berline	TU1JP/L3 HFZ	09/98-09/00
1.1i Berline	TU1JP/L3A HFY	09/98-
1.1i Berline	TU1JP/L4 HFX	09/00-
1.4i Berline 3/5ptes	TU3JP	
1.4 HDi 3/5ptes Berline	DV4TD	
1.6i Berline 3/5ptes	TU5JP	
1.6i 16v. 3/5ptes Berline/ CC Coupé Cab.	TU5JP4	
1.9 D Berline 3/5ptes	DW8/B	
2.0i 16v. 3/5ptes Berline/ CC Coupé Cab.	EW10J4	
2.0 HDi 3/5ptes Berline	DW10TD	

1315945

OE 513194

Art. AR de traverse

Cross bar rear bush



Ø int.17 Ø ext.48 coll.70 long. tube int.65 ext.44 ep. coll.16

1.1i Berline	TU1JP/L3 HFZ	09/98-09/00
1.1i Berline	TU1JP/L3A HFY	09/98-
1.1i Berline	TU1JP/L4 HFX	09/00-
1.1i SW	TU1JP/L4 HFX	05/02-
1.4i	TU3JP	
1.4 HDi	DV4TD	
1.6i	TU5JP	
1.6i 16v.	TU5JP4	
1.9 D	DW8/B	
2.0i 16v.	EW10J4/S	
2.0 HDi	DW10TD	

1005117		Kit rép. train AR G ou D	
OE -		<i>L/R rear axle repair kit</i>	
	1.1i Berline	TU1JP/L3 HFZ	09/98-09/00
	1.1i Berline	TU1JP/L3A HFY	09/98-
	1.1i Berline	TU1JP/L4 HFX	09/00-
	1.1i SW	TU1JP/L4 HFX	05/02-
	1.4i	TU3JP	
	1.4i Berline 3/5ptes susp. normale	TU3A	
	1.4i Break	TU3A/AF	
	1.4i Berline 5ptes	TU3AF	
	1.4i 16v.	ET3J4	
	1.4 HDi Berline 3/5ptes VP/ Comm.	DV4TD	
	1.6i 16v. CC	TU5JP4	13/11/02-
	1.6i 90hp 66kw	TU5JP	
	1.6i 16v. Berline 3/5ptes VP/ Comm.	TU5JP4	13/11/02-
	1.6i 16v. Break	TU5JP4	
	1.6 HDi FAP CC	DV6TED4	
	1.6 HDi FAP Berline 3/5ptes VP/ Comm.	DV6TED4	
1.9 D Berline 3/5ptes VP/ Comm.	DW8/B		
2.0i 16v. CC	EW10J4	13/11/02-	
2.0i 16v. Berline 3ptes VP/ Comm.	EW10J4	13/11/02-	
2.0i 16v. Break	EW10J4		
2.0i 16v. Berline 3ptes VP/ Comm.	EW10J4S		
2.0 HDi Berline 3/5ptes VP/ Comm.	DW10TD		

1005117		Kit rép. train AR D	
OE -		<i>Right rear axle repair kit</i>	
	1.6i 16v. CC	TU5JP4	-12/11/02
	1.6i 16v. Berline 3/5ptes VP/ Comm.	TU5JP4	-12/11/02
	2.0i 16v. CC	EW10J4	-12/11/02
	2.0i 16v. Berline 3ptes VP/ Comm.	EW10J4	-12/11/02

206+ 04/09- ...

Eléments DIRECTION

Steering parts

Elementos Direcciones

Elementy układ kierowniczy

Элементы рулевой системы

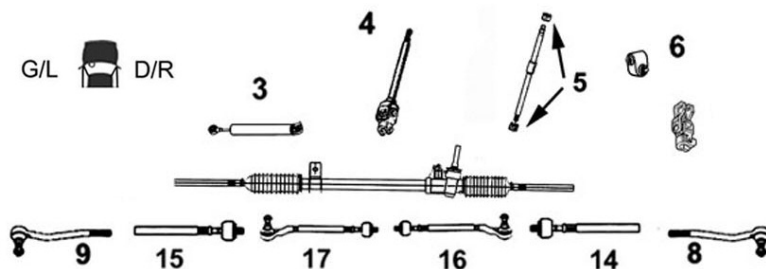

3008157		Axe de bielle G/D	
Part/oe 3812C5		<i>L/R axial joint</i>	
	14	Côté dir. M14x1.5 Côté rot. M14x1.5	
	15	long 300 mm	
	1.1i	TU1A/E5	
	1.4i	TU3A/E5	
	1.4 HDi	DV4TD DV4C	
1.6i 16v.	TU5JP4		

8173313		Rotule de direction G	
OE 381742		<i>Left tie rod end</i>	
	9	M14 x 1.5	
	1.1i	TU1A/E5	
	1.4i	TU3A/E5	
	1.4 HDi	DV4TD DV4C	
	1.6i 16v.	TU5JP4	

8173303		Rotule de direction D	
OE 381741		<i>Right tie rod end</i>	
	8	M14 x 1.5	
	1.1i	TU1A/E5	
	1.4i	TU3A/E5	
	1.4 HDi	DV4TD DV4C	
	1.6i 16v.	TU5JP4	

... 206+ 04/09- ...

SASIC

PEUGEOT



Barre stabilisatrice
 Stabilizer bar
 Barra estabilizadora
 Drażek stabilizatora
 стабилизатор поперечной устойчивости

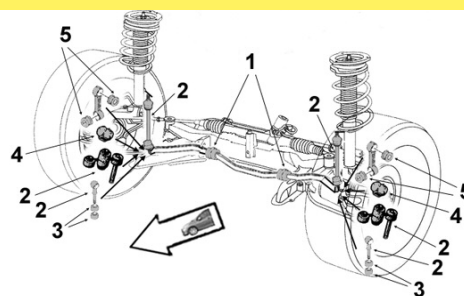

0875455

OE 508759

Biellette barre stab.

Stabilizer bar stub axle



2

1.1i TU1A
 1.4i TU3A
 1.4 HDi DV4C/TD

0875455QT réservée à l'export
(for export only)

2300005

OE 509482

Palier de barre milieu

Middle bar main bearing



1 Barre Ø 20

1.1i TU1A
 1.4i TU3A
 1.4 HDi DV4C/TD

2300006

OE 509495

Palier de barre milieu

Middle bar main bearing



1 Barre Ø 21

1.1i TU1A
 1.4i TU3A
 1.4 HDi DV4C/TD



Eléments SUSPENSION

Suspension parts
Elementos suspensión
Elementy zawieszenie
Элементы подвески

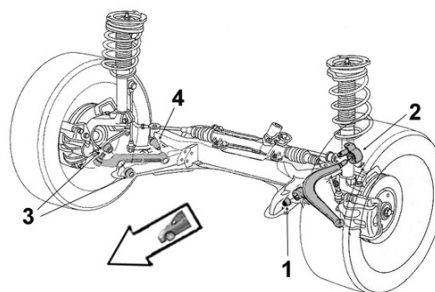

2250001

OE 3523AG

Articulation AV

Front bush



1 Ø int.15 Ø ext.55 long. tube int.50 ext.32

1.1i TU1A
 1.4i TU3A
 1.4 HDi DV4TD/C

5233773

OE 352377

Articulation AR

Rear bush



2 Ø int.14 Ø ext.55 coll.61
 long. tube int.49 ext.22 ep. coll.2.5

1.1i TU1A
 1.4i TU3A
 1.4 HDi DV4TD/C

... 206+ 04/09- ...

Bras & Triangle de suspension

Control arm
Brazo y triángulo
Wahacz
Рычаг подвески

G/L  D/R

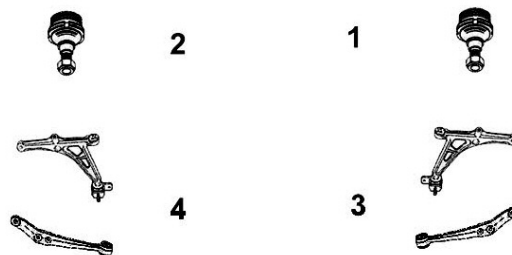

PEUGEOT



5203L73
OE 3520W0

Triangle de susp. inf. G
Lower left track control arm

4 Avec rotule With ball joint

1.1i TU1A/E5
1.4i TU3A /E5
1.4 HDi DV4C/TD
1.6i 16v. TU5JP4



5213H93
OE 3521S1

Triangle de susp. inf. D
Lower right track control arm

3 Avec rotule With ball joint

1.1i TU1A/E5
1.4i TU3A /E5
1.4 HDi DV4C/TD
1.6i 16v. TU5JP4



Support d'amortisseur

Suspension mounting
Soporte amortiguador
Poduszka amortyzatora
Опора амортизатора

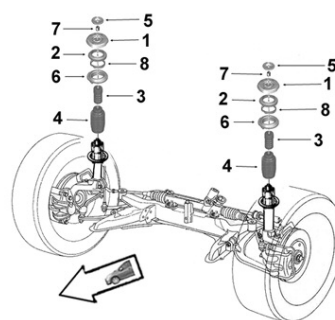

0385565
OE 503856

Support suspension G
Left suspension mounting

1
Sauf susp. renforcée AV

1.1i TU1A
1.4i TU3A



0385605
OE 503860

Support suspension D
Right suspension mounting

1
Sauf susp. renforcée AV

1.1i TU1A
1.4i TU3A



0385365
OE 5038C5

Support suspension G
Left suspension mounting

1
1.1i Susp. renforcée AV TU1A
1.4i Susp. renforcée AV TU3A
1.4 HDi DV4TD



0385405
OE 5038C6

Support suspension D
Right suspension mounting

1
1.1i Susp. renforcée AV TU1A
1.4i Susp. renforcée AV TU3A
1.4 HDi DV4TD



0355275
OE 503563

Butée à billes G/D
L/R ball bearing

2
1.1i TU1A
1.4i TU3A
1.4 HDi DV4TD/C



0335685
OE 503368

Butée de suspension G/D
L/R suspension bush

3 H70
Susp. normale
1.1i TU1A
1.4i TU3A



... 206+ 04/09- ...



PEUGEOT



Support d'amortisseur

Suspension mounting
Soporte amortiguador
Poduszka amortyzatora
Опора амортизатора

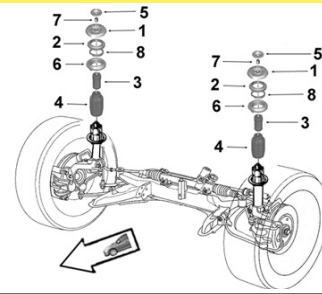

0335585

OE 503358

Butée de suspension G/D

L/R suspension bush

3 H73

Susp. renforcée AV AR

1.1i TU1A
1.4i TU3A



2650007

OE 503360

Butée de suspension G/D

L/R suspension bush

3 H80

1.1i Susp. renforcée AV TU1A
1.4i Susp. renforcée AV TU3A
1.4 HDi DV4TD/C



1005274

OE -

Kit rép. suspension G

Left susp. mounting repair kit

1.1i Susp. renforcée AV TU1A/E5
1.4i Susp. renforcée AV TU3A/E5
1.4 HDi DV4TD
1.4 HDi DV4C
1.6i 16v. TU5JP4



1005276

OE -

Kit rép. suspension D

Right susp. mounting repair kit

1.1i Susp. renforcée AV TU1A/E5
1.4i Susp. renforcée AV TU3A/E5
1.4 HDi DV4TD
1.4 HDi DV4C
1.6i 16v. TU5JP4



Support d'amortisseur

Suspension mounting
Soporte amortiguador
Poduszka amortyzatora
Опора амортизатора

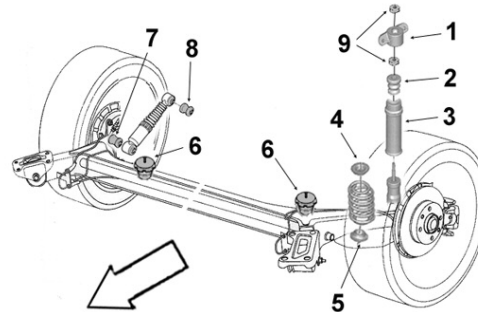

1665375

OE 516637

Butée de talonnage

Bushing

6 H48 Susp. normale / renforcée AV

1.1i TU1A/E5
1.4i TU3A/E5
1.4 HDi DV4C/TD
1.6i 16v. TU5JP4



... 206+ 04/09-

Eléments TRAIN ARRIERE

Rear axle parts

Tren TRAS

Elementy zawieszenia tylnego

элементы задней оси.



PEUGEOT



1315935 OE 5131F8	Art. AV de traverse <i>Cross bar front bush</i>	1315945 OE 513194	Art. AR de traverse <i>Cross bar rear bush</i>
	Ø int.17 Ø ext.48 coll.68 long. tube int.61 ext.44 ep. coll.13		Ø int.17 Ø ext.48 coll.70 long. tube int.65 ext.44 ep. coll.16
	1.1i TU1A 1.4i TU3A 1.4 HDi DV4TD		1.1i TU1A 1.4i TU3A 1.4 HDi DV4TD

1005117 OE -	Kit rép. train AR G ou D <i>L/R rear axle repair kit</i>
	Avec barre anti devers AR
	1.1i TU1A/E5 -03/10/10 1.4i TU3A/E5 -03/10/10 1.4 HDi DV4TD -03/10/10 1.4 HDi DV4C -03/10/10

207 ...

Eléments DIRECTION

Steering parts



Elementos Direcciones

Elementy układ kierowniczy

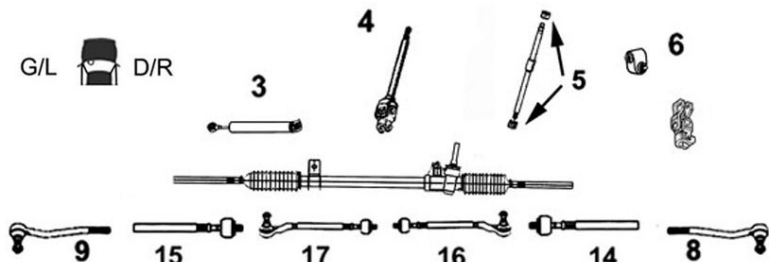
Элементы рулевой системы







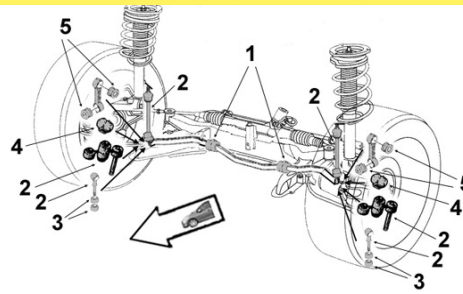

8123E83 OE 3812E8	Axe de bielle G/D <i>L/R axial joint</i>
	14 Côté dir. M12x1.0 Côté rot. M16x1.5 long 213 mm
	15 1.4i TU3A/E5 1.4i 16v. ET3J4 1.4 VTi EP3/C 1.4 HDi DV4C/TD 1.6i 16v. EP6/C TU5JP4 1.6i 16v. THP EP6DT/S 1.6 HDi/ CC DV6C 1.6 HDi DV6ATED4/DTED/TED4 1.6 HDi FAP DV6TED4B

8173673 OE 381767	Rotule de direction G <i>Left tie rod end</i>	8173683 OE 381768	Rotule de direction D <i>Right tie rod end</i>
	9 M16 x 1.5 1.4i TU3A/E5 1.4i 16v. ET3J4 1.4 VTi /SW EP3/C 1.4 HDi DV4C/TD 1.6i 16v. EP6/C TU5JP4 1.6i 16v. THP EP6DT/S 1.6 HDi /FAP DV6TED4 1.6 HDi DV6ATED4 /C/DTED 1.6 HDi FAP DV6TED4B		8 M16 x 1.5 1.4i TU3A/E5 1.4i 16v. ET3J4 1.4 VTi /SW EP3/C 1.4 HDi DV4C/TD 1.6i 16v. EP6/C TU5JP4 1.6i 16v. THP EP6DT/S 1.6 HDi /FAP DV6TED4 1.6 HDi DV6ATED4 /C/DTED 1.6 HDi FAP DV6TED4B



Barre stabilisatrice
 Stabilizer bar
 Barra estabilizadora
 Drażek stabilizatora
 стабилизатор поперечной устойчивости



<p>2300013 OE 508769</p> 	<p>Biellette de barre stab. G <i>Left stabilizer bar stub axle</i></p> <p>2</p> <p>1.4i TU3A/E5 1.4i 16v. ET3J4 1.4 VTi EP3 1.4 HDi DV4TD 1.6i 16v. EP6/C TU5JP4 1.6i THP 16v. EP6DT/S 1.6 HDi DV6ATED4/C/DTED/TED4 1.6 HDi FAP 90hp 66kw DV6TED4B</p>	<p>2300012 OE 508768</p> 	<p>Biellette de barre stab. D <i>Right stabilizer bar stub axle</i></p> <p>2</p> <p>1.4i TU3A/E5 1.4i 16v. ET3J4 1.4 VTi EP3 1.4 HDi DV4TD 1.6i 16v. EP6/C TU5JP4 1.6i THP 16v. EP6DT/S 1.6 HDi DV6ATED4/C/DTED/TED4 1.6 HDi FAP 90hp 66kw DV6TED4B</p>
<p>2300014 OE 5094C1</p> 	<p>Palier de barre milieu <i>Middle bar main bearing</i></p> <p>1 Barre Ø 20</p> <p>1.4i TU3AE5 1.4i /SW TU3A 1.4i 16v. ET3J4 1.4 VTi /SW EP3</p> <p>1.4 HDi DV4TD</p> <p>1.6i 16v. TU5JP4 1.6i 16v. EP6/C 1.6i 16v. CC EP6/C 1.6i 16v. THP EP6DTS 1.6i THP 16v./ CC EP6DT</p> <p>1.6 HDi DV6ATED4 1.6 HDi DV6TED4 1.6 HDi DV6C/DTED 1.6 HDi CC DV6TED4 1.6 HDi FAP 90hp 66kw DV6TED4B</p>	<p>2300015 OE 5094C2</p> 	<p>Palier de barre milieu <i>Middle bar main bearing</i></p> <p>1 Barre Ø 21</p> <p>1.4i TU3AE5 1.4i /SW TU3A 1.4i 16v. ET3J4 1.4 VTi /SW EP3</p> <p>1.4 HDi DV4TD</p> <p>1.6i 16v. TU5JP4 1.6i 16v. EP6/C 1.6i 16v. CC EP6/C 1.6i 16v. THP EP6DTS 1.6i THP 16v./ CC EP6DT</p> <p>1.6 HDi DV6ATED4 1.6 HDi DV6TED4 1.6 HDi DV6C/DTED 1.6 HDi CC DV6TED4 1.6 HDi FAP 90hp 66kw DV6TED4B</p>
<p>2300031 OE 5094C3</p> 	<p>Palier de barre milieu <i>Middle bar main bearing</i></p> <p>1 Barre Ø 22</p> <p>1.4i TU3AE5 1.4i /SW TU3A 1.4i 16v. ET3J4 1.4 VTi /SW EP3/C</p> <p>1.4 HDi DV4C/ TD</p> <p>1.6i 16v. TU5JP4 1.6i 16v. EP6/C 1.6i 16v. CC EP6/C 1.6i 16v. THP EP6DTS 1.6i THP 16v. /CC EP6DT</p> <p>1.6 HDi DV6ATED4 1.6 HDi DV6TED4 1.6 HDi DV6C/DTED 1.6 HDi CC DV6TED4 1.6 HDi FAP 90hp 66kw DV6TED4B</p>	<p>2300032 OE 5094C5</p> 	<p>Palier de barre milieu <i>Middle bar main bearing</i></p> <p>1 Barre Ø 23</p> <p>1.4i TU3AE5 1.4i /SW TU3A 1.4i 16v. ET3J4 1.4 VTi /SW EP3/C</p> <p>1.4 HDi DV4C/ TD</p> <p>1.6i 16v. TU5JP4 1.6i 16v. EP6/C 1.6i 16v. CC EP6/C 1.6i 16v. THP EP6DTS 1.6i THP 16v. /CC EP6DT</p> <p>1.6 HDi DV6ATED4 1.6 HDi DV6TED4 1.6 HDi DV6C/DTED 1.6 HDi CC DV6TED4 1.6 HDi FAP 90hp 66kw DV6TED4B</p>



Eléments SUSPENSION
Suspension parts
Elementos suspensión
Elementy zawieszenie
Элементы подвески

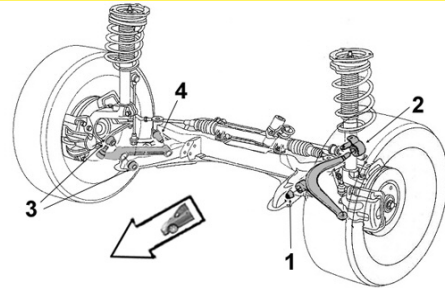

2250012 Part/oe 3520R7	Articulation AV Front bush	2250007 Part/oe 3520R7	Articulation AR Rear bush
	1 Ø int. 14 Ø ext. 56 long. tube int.48 ext.30		2 Ø int. 14 Ø ext. 56 long. tube int. 48 ext. 28
	1.4i 16v. ET3J4 1.4i TU3A/E5 1.4 VTi EP3/C 1.4 HDi DV4TD 1.6i 16v. EP6/C TU5JP4 1.6i 16v. CC EP6/C 1.6i THP 16v./CC EP6DT 12/11/07- 1.6 HDi DV6ATED4 /C 1.6 HDi DV6DTED 1.6 HDi/CC DV6TED4 1.6 HDi FAP 90hp 66kw DV6TED4B		1.4i 16v. ET3J4 1.4i TU3A/E5 1.4 VTi EP3/C 1.4 HDi DV4TD 1.6i 16v. EP6/C TU5JP4 1.6i 16v. CC EP6/C 1.6i THP 16v./ CC EP6DT 12/11/07- 1.6 HDi DV6ATED4 /C 1.6 HDi DV6DTED 1.6 HDi /CC DV6TED4 1.6 HDi FAP 90hp 66kw DV6TED4B

Bras & Triangle de suspension Control arm Brazo y triángulo Wahacz Рычаг подвески	G/L D/R	2	1
		4	3

5203Q93 OE 3520R7	Triangle de susp. inf. G Lower left track control arm	5213N03 OE 3521N8	Triangle de susp. inf. D Lower right track control arm
	4 Avec rotule With ball joint		3 Avec rotule With ball joint
	1.4i TU3A/E5 1.4i 16v. ET3J4 1.4 VTi /SW EP3 1.4 VTi EP3C 1.4 HDi DV4C/ TD 1.6i 16v. TU5JP4 1.6i 16v. /CC EP6/C 1.6i 16v. THP /CC EP6DT 1.6i 16v. THP SW EP6DTS 1.6 HDi DV6DTED -27/02/11 1.6 HDi Sauf couple pont 19x63 DV6DTED 28/02/11- 1.6 HDi /CC DV6TED4 1.6 HDi DV6ATED4 /C 1.6 HDi FAP DV6TED4B		1.4i TU3A/E5 1.4i 16v. ET3J4 1.4 VTi /SW EP3 1.4 VTi EP3C 1.4 HDi DV4C/ TD 1.6i 16v. TU5JP4 1.6i 16v. /CC EP6/C 1.6i 16v. THP /CC EP6DT 1.6i 16v. THP SW EP6DTS 1.6 HDi DV6DTED -27/02/11 1.6 HDi Sauf couple pont 19x63 DV6DTED 28/02/11- 1.6 HDi /CC DV6TED4 1.6 HDi DV6ATED4 /C 1.6 HDi FAP DV6TED4B

Bras & Triangle de suspension

Control arm
Brazo y triángulo
Wahacz
Рычаг подвески

G/L  D/R

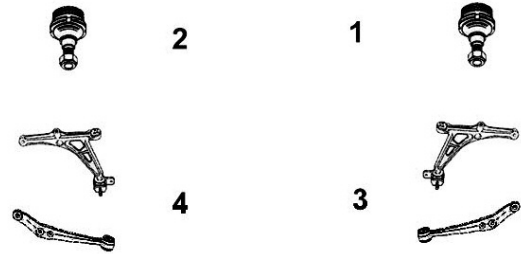

6403623

OE 364062

Rotule de susp. inf. G/D

L/R lower suspension ball joint



1	1.4i	TU3A/E5
2	1.4i 16v.	ET3J4
	1.4 VTi /SW	EP3
	1.4 VTi	EP3C
	1.4 HDi	DV4C /TD
	1.6i 16v.	EP6/C TU5JP4
	1.6i 16v. THP	EP6DT/S
	1.6 HDi	DV6ATED4/DTED
	1.6 HDi /CC	DV6C/TED4
	1.6 HDi FAP	DV6TED4B



Support d'amortisseur

Suspension mounting
Soporte amortiguador
Poduszka amortyzatora
Опора амортизатора

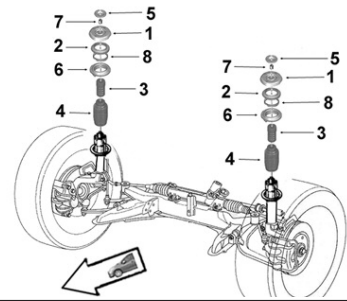

2650038

OE 503375

Coupelle rebond.

Spring cup



5	TT /all models
----------	----------------

2650014

OE 5038E7

Support suspension

Suspension mounting



1	1.4i	TU3AE5	1.6i 16v.	TU5JP4
	1.4i /SW	TU3A	1.6i 16v. /CC	EP6/C
	1.4i 16v.	ET3J4	1.6i 16v. THP	EP6DTS
	1.4 VTi	EP3C	1.6i THP 16v. /CC	EP6DT
	1.4 VTi /SW	EP3	1.6 HDi	DV6ATED4/ C/ DTED
	1.4 HDi	DV4TD	1.6 HDi /CC	DV6TED4

0355275

OE 503563

Butée à billes G/D

L/R ball bearing



2	1.4i	TU3A/E5	1.6 HDi	DV6ATED4
	1.4i 16v.	ET3J4	1.6 HDi /CC	DV6TED4
	1.4 VTi	EP3/C	1.6 HDi	DV6TED4B
	1.4 HDi	DV4TD	1.6 HDi	DV6C
	1.6i 16v.	TU5JP4	1.6 HDi	DV6DTED
	1.6i 16v. /CC	EP6/C		
	1.6i 16v. THP /CC	EP6DT		
	1.6i 16v. THP	EP6DTS		

2650043		Coupelle amortisseur G/D			
OE 5033C3		<i>L/R shock absorber cup</i>			
 	6	1.4i	TU3A/E5	1.6i 16v. THP	EP6DTS
		1.4i 16v.	ET3J4	1.6i 16v. THP /CC	EP6DT
		1.4 VTi	EP3/C	1.6 HDi /CC	DV6TED4
		1.4 HDi	DV4C/ TD	1.6 HDi	DV6ATED4/ C/ DTED
		1.6i 16v.	TU5JP4	1.6 HDi FAP	DV6TED4B
		1.6i 16v. /CC	EP6/C		

2650044		Protecteur amortisseur G/D						
OE 525448		<i>L/R shock absorber protector</i>						
 	4	1.4i / GPL	TU3A	12/02/09-	1.6i 16v.	EP6C		
		1.4i / GPL	TU3AE5		1.6i 16v.	TU5JP4		12/02/09-
		1.4i 16v.	ET3J4	12/02/09-	1.6i 16v. /Turbo	EP6 EP6DT/DTS		12/02/09-
		1.4i VTi	EP3	12/02/09-	1.6 HDi /FAP	DV6C /DTED		
		1.4i VTi	EP3C		1.6 HDi /FAP	DV6ATED4/TED4/B		12/02/09-
		1.4 HDi	DV4TD	12/02/09-				
		1.4 HDi /FAP	DV4C					

Eléments TRAIN ARRIERE

Rear axle parts

Tren TRAS

Elementy zawieszenia tylnego

элементы задней оси.



2600006		Articulation essieu		
OE 5131E9		<i>Axle bush</i>		
 	Ø int. 12.2 Ø ext. 72 coll. 83 long. tube int. 82.7 ext. 60 ep. coll.6.7		Susp. normale	
	1.4i Berline	TU3A	1.6i 16v. THP Berline	EP6DT
	1.4i 16v.	ET3J4	1.6 HDi Berline	DV6ATED4/ C /DTED
	1.4i Berline	TU3AE5	1.6 HDi Sans FAP	DV6TED4
	1.4 VTi Berline	EP3/C	1.6 HDi /FAP /SW	DV6TED4
	1.4 HDi	DV4C /TD	1.6 HDi FAP Berline	DV6TED4B
	1.6i 16v.	TU5JP4		
	1.6i 16v. Berline	EP6/C		

2600014		Articulation essieu	
OE 5131F0		<i>Axle bush</i>	
 	Ø int. 12.2 Ø ext. 72 coll. 83.7 long. tube int.82.5 ext.60 ep. Coll.6.7		
	1.4i	Susp. normale réhaussée/ AR renforcée	TU3A/E5
	1.4i 16v.	Susp. normale réhaussée/ AR renforcée	ET3J4
	1.4 VTi	Susp. normale réhaussée/ AR renforcée	EP3
	1.4 VTi	Susp. AR renforcée	EP3C
	1.4 VTi	Trendy outdoor/ sport outdoor Break	EP3/C
	1.4 HDi	Susp. normale réhaussée	DV4C
	1.4 HDi	Susp. normale réhaussée/ AR renforcée	DV4TD
	1.6i 16v.	Susp. normale réhaussée/ AR renforcée	TU5JP4
	1.6i 16v. Break	Susp. normale réhaussée/ AR renforcée	EP6/ C
	1.6i 16v. Break	Susp. normale Sauf Trendy outdoor Sauf sport+outdoor	EP6/ C
	1.6i 16v. CC		EP6/ C
	1.6i 16v. THP Break		EP6DTS
	1.6i 16v. THP CC		EP6DT
	1.6 HDi	Susp. normale réhaussée/ AR renforcée	DV6ATED4
	1.6 HDi Berline	Susp. normale réhaussée	DV6DTED
1.6 HDi CC	Susp. normale	DV6C	
1.6 HDi FAP	Susp. normale réhaussée/ AR renforcée	DV6TED4	
1.6 HDi FAP	Susp. AR renforcée	DV6TED4B	
1.6 HDi FAP CC	Susp. normale	DV6TED4	

Eléments TRAIN ARRIERE

Rear axle parts

Tren TRAS

Elementy zawieszenia tylnego

элементы задней оси.

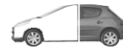

2600016
OE 5131F9

Articulation essieu

Axle bush

Ø int. 12.2 Ø ext. 72 coll. 84 long. tube int.82.5 ext.60 ep. Coll.6.7

Break Susp. normale



1.4i
1.4 VTi Sauf Trendy outdoor Sauf sport+outdoor
1.6i 16v.
1.6i 16v. Trendy outdoor/ sport outdoor
1.6 HDi
1.6 HDi FAP

TU3A/E5
EP3/C
EP6
EP6C
DV6ATED4/ C / DTED
DV6TED4/B

208 ...

Eléments DIRECTION

Steering parts

Elementos Direcciones

Elementy uklad kierowniczy

Элементы рулевой системы

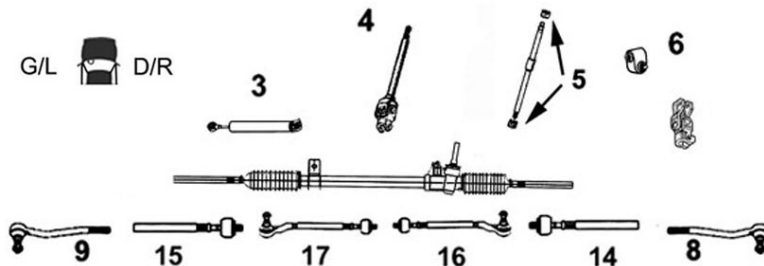

7770019

Axe de bielle G/D

OE 1608025380

L/R axial joint

NEW



14 Côté dir. M12x1.0 Côté rot. M14x1.5 long 225 mm
15

1.0i EB0
1.2i EB2
1.4i EP3C
1.4 HDi DV4C
1.6i EP6C
1.6 HDi DV6C DV6DTED/M

7670025

Rotule de direction G

OE 1608025180

Left tie rod end

NEW



9 M14 x 1.5

1.0i EB0
1.2i EB2
1.4i EP3C
1.4 HDi DV4C
1.6i EP6C
1.6 HDi DV6C
1.6 HDi DV6DTED/M

7670026

Rotule de direction D

OE 1608025280

Right tie rod end

NEW



8 M14 x 1.5

1.0i EB0
1.2i EB2
1.4i EP3C
1.4 HDi DV4C
1.6i EP6C
1.6 HDi DV6C
1.6 HDi DV6DTED/M

8173673

Rotule de direction G

OE 381767

Left tie rod end



9 M16 x 1.5

1.6i THP EP6CDT/X

8173683

Rotule de direction D

OE 381768

Right tie rod end



8 M16 x 1.5

1.6i THP EP6CDT/X



Barre stabilisatrice
 Stabilizer bar
 Barra estabilizadora
 Drażek stabilizatora
 стабилизатор поперечной устойчивости

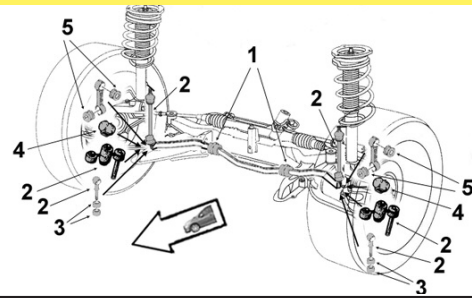

<p>2300013 OE 508769</p>	<p>Biellette de barre stab. G <i>Left stabilizer bar stub axle</i></p>	<p>2300012 OE 508768</p>	<p>Biellette de barre stab. D <i>Right stabilizer bar stub axle</i></p>
	<p>2 Disques Ø 302 1.4i 16v. 1.4 HDi 1.6i 16v. 1.6i THP 16v. 1.6 HDi FAP</p>		<p>2 Disques Ø 302 1.4i 16v. 1.4 HDi 1.6i 16v. 1.6i THP 16v. 1.6 HDi FAP</p>
<p>2300014 OE 5094C1</p>	<p>Palier de barre milieu <i>Middle bar main bearing</i></p>	<p>2300015 OE 5094C2</p>	<p>Palier de barre milieu <i>Middle bar main bearing</i></p>
	<p>1 Barre Ø 20 Disques Ø 302 1.4i 16v. 1.4 HDi 1.6i 16v. 1.6i THP 16v. 1.6 HDi FAP</p>		<p>1 Barre Ø 21 Disques Ø 302 1.4i 16v. 1.4 HDi 1.6i 16v. 1.6i THP 16v. 1.6 HDi FAP</p>



Eléments SUSPENSION
 Suspension parts
 Elementos suspensión
 Elementy zawieszenia
 Элементы подвески

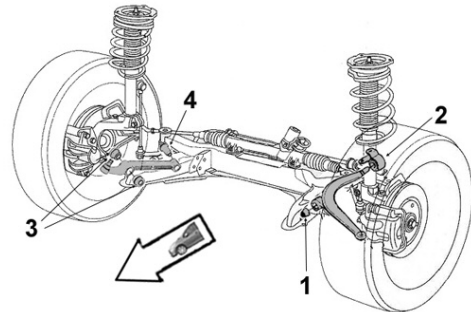

<p>2250012 Part/oe 3520R7</p>	<p>Articulation AV <i>Front bush</i></p>	<p>2250007 Part/oe 3520R7</p>	<p>Articulation AR <i>Rear bush</i></p>
	<p>1 Ø int. 14 Ø ext. 56 long. tube int.48 ext.30 Disques Ø 302 1.4i 16v. 1.4 HDi 1.6i 16v. 1.6i THP 16v. 1.6 HDi FAP</p>		<p>2 Ø int. 14 Ø ext. 56 long. tube int. 48 ext.28 Disques Ø 302 1.4i 16v. 1.4 HDi 1.6i 16v. 1.6i THP 16v. 1.6 HDi FAP</p>

Bras & Triangle de suspension

Control arm
Brazo y triángulo
Wahacz
Рычаг подвески

G/L  D/R

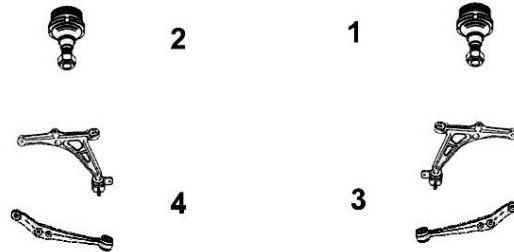

5203Q93
OE 3520R7

Triangle de susp. inf. G
Lower left track control arm



4 Avec rotule *With ball joint*
Susp. normale Pivot roue Ø82
Disques AV Ø302 ep.26
1.0i EB0
1.2i EB2
1.4i EP3C
1.4 HDi DV4C
1.6i EP6C
1.6i THP EP6CDT/X
1.6 HDi DV6ETED M
1.6 HDi DV6C DV6DTED/M

5213N03
OE 3521N8

Triangle de susp. inf. D
Lower right track control arm



3 Avec rotule *With ball joint*
Susp. normale Pivot roue Ø82
Disques AV Ø302 ep.26
1.0i EB0
1.2i EB2
1.4i EP3C
1.4 HDi DV4C
1.6i EP6C
1.6i THP EP6CDT/X
1.6 HDi DV6ETED M
1.6 HDi DV6C DV6DTED/M

6403623
OE 364062

Rotule de susp. inf. G/D
L/R lower suspension ball joint



1
2 Pivot roue Ø82
Disques AV Ø302 ep.26
1.0i EB0
1.2i EB2
1.4i EP3C
1.4 HDi DV4C
1.6i EP6C
1.6i THP EP6CDT/X
1.6 HDi DV6DTED/M
1.6 HDi DV6C DV6ETED M

7570007
OE 364078

Rotule de susp. inf. G/D
L/R lower suspension ball joint

NEW



1 Ø18 Susp. normale sauf XY
2 Disques AV Ø266 ep.22
1.0i
1.2i
1.4i
1.4 HDi FAP
1.6i /Turbo
1.6 HDi/ FAP



Support d'amortisseur

Suspension mounting
Soporte amortiguador
Poduszka amortyzatora
Опора амортизатора

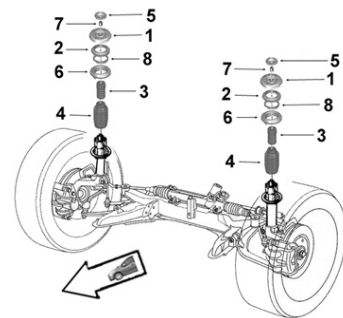

2650038
OE 503375

Coupelle rebond.
Spring cup



5
1.0i EB0
1.2i EB2
1.4i EP3C
1.4 HDi DV4C
1.6i EP6C
1.6i THP EP6CDT
1.6 HDi DV6C DV6ETED M
1.6 HDi DV6DTED/M

2650021
OE 5038G6

Support suspension
Suspension mounting



1
1.0i
1.2i
1.4i
1.4 HDi
1.6i
1.6i THP
1.6 HDi

0355275
OE 503563

Butée à billes G/D
L/R ball bearing



2
1.0i
1.2i
1.4i
1.4 HDi
1.6i
1.6i THP
1.6 HDi

2650043
OE 5033C3





Coupelle amortisseur G/D
L/R shock absorber cup

NEW





6
1.0i EB0
1.2i EB2
1.4i EP3C
1.4 HDi DV4C
1.6i EP6C
1.6i THP EP6CDT/X
1.6 HDi DV6C DV6ETED M
1.6 HDi DV6DTED/M

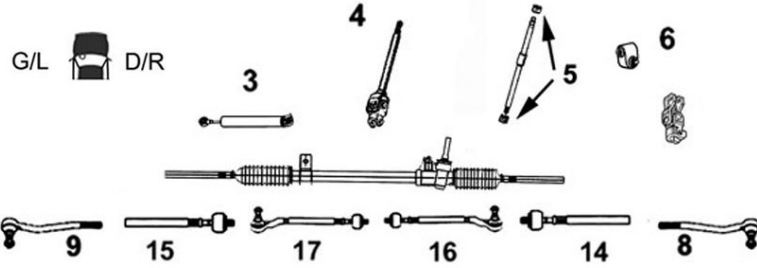

... 208

<p>2650042 OE 9677609080</p>	<p>Butée de suspension <i>Shock bush</i></p>	<p>2650044 OE 525448</p>	<p>Protecteur amortisseur G/D <i>L/R shock absorber protector</i></p>
	<p>3 H 75.5 1.0i Berline Susp. normale EB0 BVM 1.2i Berline Susp. normale EB2 BVM BV rob. 1.6i THP Berline Susp. AR renforcée EP6CDT BVM</p>		<p>4 1.0i EB0 1.2i EB2 1.4i EP3 1.4 HDi FAP DV4C 1.6i /Turbo EP6 1.6 HDi /FAP DV6</p>
<p>Eléments TRAIN ARRIERE <i>Rear axle parts</i> <i>Tren TRAS</i> <i>Elementy zawieszenia tylnego</i> <i>элементы задней оси.</i></p> 		<p>2600009 OE 5131H4</p>	<p>Articulation essieu <i>Axle bush</i> Ø int. 12 Ø ext. 72 coll. 83 long. tube int. 83 ext. 60 ep. coll.5.5 Sauf susp. normale réhaussée 1.0i EB0 1.2i 12v. VTi EB2 1.4 16v. VTi EP3C 1.4 HDi DV4C 1.6i 16v. VTi EP6C 1.6 HDi DV6ETED M 1.6 HDi DV6C DV6DTED/M</p>
			

2008 ...

<p>Eléments DIRECTION <i>Steering parts</i> <i>Elementos Direcciones</i> <i>Elementy układ kierowniczy</i> <i>Элементы рулевой системы</i></p>			
---	---	--	--

<p>7770019 OE 1608025380</p>	<p>Axe de bielle G/D <i>L/R axial joint</i></p>
	<p>14 15 Côté dir. M12x1.0 Côté rot. M14x1.5 long 225 mm</p> <p>1.2 VTi EB2 1.4 HDi DV4C 1.6i 16v. EP6C 1.6 HDi DV6C 1.6 HDi DV6DTED</p>

<p>7670025 OE 1608025180</p>	<p>Rotule de direction G <i>Left tie rod end</i></p>	<p>7670026 OE 1608025280</p>	<p>Rotule de direction D <i>Right tie rod end</i></p>
	<p>9 M14 x 1.5</p> <p>1.2 VTi EB2 1.4 HDi DV4C 1.6i 16v. EP6C 1.6 HDi DV6C 1.6 HDi DV6DTED</p>		<p>8 M14 x 1.5</p> <p>1.2 VTi EB2 1.4 HDi DV4C 1.6i 16v. EP6C 1.6 HDi DV6C 1.6 HDi DV6DTED</p>



Barre stabilisatrice
 Stabilizer bar
 Barra estabilizadora
 Drażek stabilizatora
 стабилизатор поперечной устойчивости

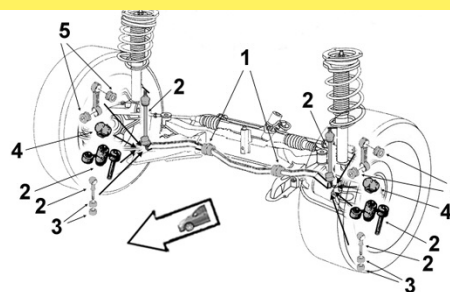

0875455

Biellette barre stab.

OE 508759

Stabilizer bar stub axle



2

1.2 VTi	EB2	-17/11/13
1.4 HDi	DV4C	-17/11/13
1.6i 16v.	EP6C	-17/11/13
1.6 HDi	EP6C	-17/11/13

0875455QT réservée à l'export
(for export only)



Support d'amortisseur
 Suspension mounting
 Soporte amortiguador
 Poduszka amortyzatora
 Опора амортизатора

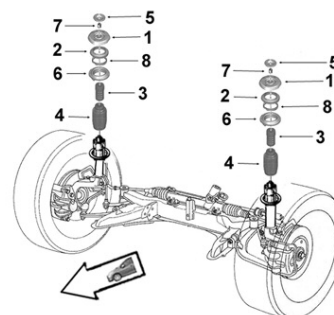

2650043

Coupelle amortisseur G/D

OE 5033C3

L/R shock absorber cup

NEW

6



1.2 VTi	EB2
1.4 HDi	DV4C
1.6i 16v.	EP6C
1.6 HDi	DV6C
1.6 HDi	DV6DTED

2650044

Protecteur amortisseur G/D

OE 525448

L/R shock absorber protector

NEW

4



1.2 VTi	EB2
1.4 HDi /FAP	DV4
1.6i 16v.	EP6C
1.6 HDi /FAP	DV6

Eléments TRAIN ARRIERE

Rear axle parts
Tren TRAS
Elementy zawieszenia tylnego
элементы задней оси.



2600009

Articulation essieu

OE 5131H4

Axle bush

Ø int. 12 Ø ext. 72 coll. 83 long. tube int. 83 ext. 60 ep. coll.5.5



1.2 VTi	EB2
1.4 HDi	DV4C
1.6i 16v.	EP6C
1.6 HDi	DV6

301 ...

Eléments DIRECTION
Steering parts
Elementos Direcciones
Elementy układ kierowniczy
Элементы рулевой системы

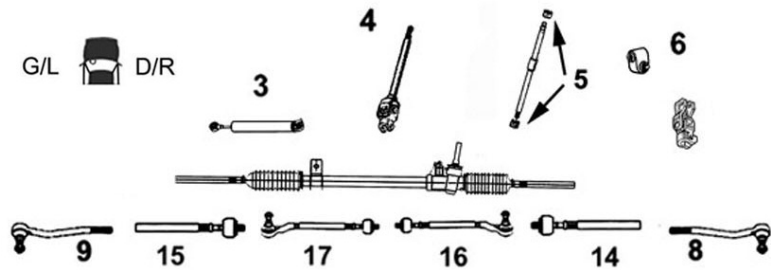

7770015 **Axe de bielle G/D**
 OE 1608652180 *L/R axial joint*

NEW



14 Côté dir. M16x1.5 Côté rot. M12x1.0 long 230 mm
15

1.2i	EB2 M
1.6i	EC5
1.6 HDi /FAP	DV6DTED/M

8173673 **Rotule de direction G**
 OE 381767 *Left tie rod end*



9 M16 x 1.5

1.2i	EB2 M
1.6i	EC5
1.6 HDi	DV6DTED /M

8173683 **Rotule de direction D**
 OE 381768 *Right tie rod end*



8 M16 x 1.5

1.2i	EB2 M
1.6i	EC5
1.6 HDi	DV6DTED /M



Barre stabilisatrice
Stabilizer bar
Barra estabilizadora
Drażek stabilizatora
стабилизатор поперечной устойчивости

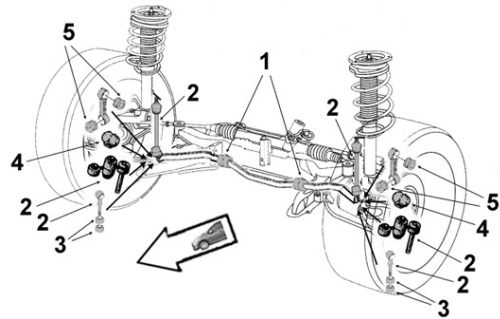

2300013 **Biellette de barre stab. G**
 OE 508769 *Left stabilizer bar stub axle*



2

1.2i
1.6i
1.6 HDi

2300012 **Biellette de barre stab. D**
 OE 508768 *Right stabilizer bar stub axle*



2

1.2i
1.6i
1.6 HDi



Support d'amortisseur
 Suspension mounting
 Soporte amortiguador
 Poduszka amortyzatora
 Опора амортизатора

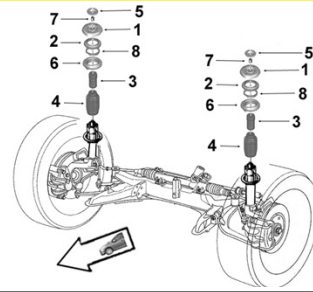

<p>2650038 OE 503375</p> 	<p>Coupelle rebond. <i>Spring cup</i></p> <p>5</p> <p>1.2i EB2 M 1.6i EC5 1.6 HDi DV6DTED/M</p>	<p>2650021 OE 5038G6</p> 	<p>Support suspension <i>Suspension mounting</i></p> <p>1</p> <p>1.2i 1.6i 1.6 HDi</p>
<p>0355275 OE 503563</p> 	<p>Butée à billes G/D <i>L/R ball bearing</i></p> <p>2</p> <p>1.2i 1.6i 1.6 HDi</p>	<p>2650043 OE 5033C3</p> <p>NEW</p> 	<p>Coupelle amortisseur G/D <i>L/R shock absorber cup</i></p> <p>6</p> <p>1.2i EB2 M 1.6i EC5 1.6 HDi DV6DTED/M</p>
<p>2650042 OE 9677609080</p> <p>NEW</p> 	<p>Butée de suspension <i>Shock bush</i></p> <p>3 H 75.5</p> <p>1.2i EB2 M -09/01/13 1.6i EC5 -09/01/13 1.6 HDi DV6DTED/M -09/01/13</p>	<p>2650044 OE 525448</p> <p>NEW</p> 	<p>Protecteur amortisseur G/D <i>L/R shock absorber protector</i></p> <p>4</p> <p>1.2i EB2 M 1.6i EC5 1.6 HDi /FAP DV6</p>

Eléments TRAIN ARRIERE
 Rear axle parts
 Tren TRAS
 Elementy zawieszenia tylnego
 элементы задней оси.



<p>2600009 OE 5131H4</p> 	<p>Articulation essieu <i>Axle bush</i></p> <p>Ø int. 12 Ø ext. 72 coll. 83 long. tube int. 83 ext. 60 ep. coll.5.5</p> <p>1.2 1.6i 1.6 HDi</p>
---	---

Eléments DIRECTION





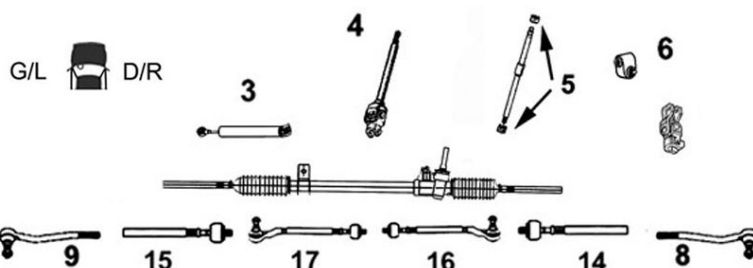

Steering parts

Elementos Direcciones

Elementy układ kierowniczy

Элементы рулевой системы

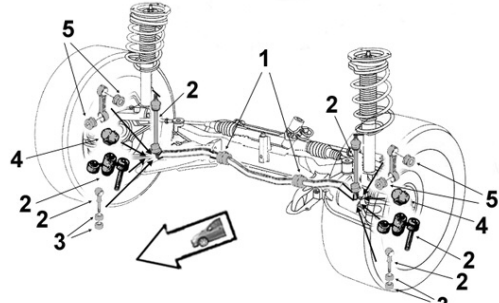

<p>8123973 OE 381297</p> 	<p>Axe de bielle G/D <i>L/R axial joint</i></p> <p>14 15 Côté dir. M12x1.0 Côté rot. M14x1.5 long 320 mm</p> <p>TT /all models dir. 0024644</p>	<p>8173183 OE 381750</p> 	<p>Rotule de direction G/D <i>L/R tie rod end</i></p> <p>8 9 M14 x 1.5</p> <p>TT /all models dir. 0024644</p>
<p>8993113 OE 389911</p> 	<p>Kit rép. rotule direction G ou D <i>L/R tie rod end repair kit</i></p> <p>Rondelle ep. 6.5 Washers thickness 6.5</p> <p>TT /all models Dir. 0024374</p>	<p>8993173 OE 389917</p> 	<p>Kit rép. rotule direction G ou D <i>L/R tie rod end repair kit</i></p> <p>Rondelle ep. 8 Washers thickness 8</p> <p>TT /all models Dir. 0024374</p>
<p></p> <p>Barre stabilisatrice <i>Stabilizer bar</i> <i>Barra estabilizadora</i> <i>Drażek stabilizatora</i> стабилизатор поперечной устойчивости</p>			
<p>1815065 OE 518106</p> 	<p>Liaison élastique <i>Elastic link</i></p> <p>Ø int.10 Ø ext.30 long. tube int.20 ext.20</p> <p>TT /all models Berline</p>	<p>0945245 OE 509424</p> 	<p>Palier de barre <i>Bar main bearing</i></p> <p>1 Barre Ø 26</p> <p>TT /all models 01/78-</p>



Eléments SUSPENSION
Suspension parts
Elementos suspensión
Elementy zawieszenie
Элементы подвески

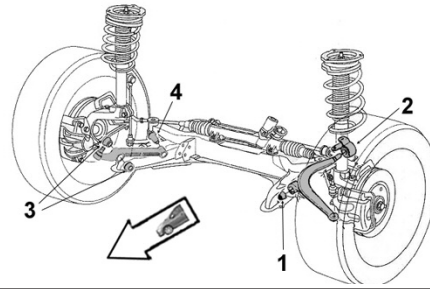

5233113
 OE 352311

Articulation AV/AR
Front rear bush



1 Ø int.10 Ø ext.34 long. tube int.41 ext.31
2

TT /all models

Bras & Triangle de suspension

Control arm
Brazo y triángulo
Wahacz
Рычаг подвески

G/L D/R

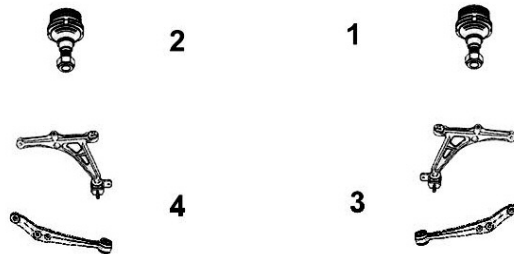

5203373
 OE 352037

Bras de suspension G
Left track control arm



4 Avec rotule With ball joint

TT /all models 10/77-

5213263
 OE 352126

Bras de suspension D
Right track control arm



3 Avec rotule With ball joint

TT /all models 10/77-

1003547
 OE -

Kit rép. bras susp. G ou D
L or R track control arm bearing repair kit



TT /all models 10/77-

6403073
 OE 364007

Kit rép. rotule pivot fusée
Susp. ball joint repair kit



1 côté / side

TT /all models



Support d'amortisseur
Suspension mounting
Soporte amortiguador
Poduszka amortyzatora
Опора амортизатора

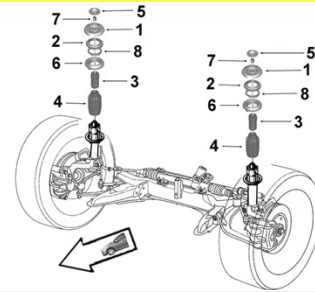

2545075
 OE 525407

Protecteur amortisseur G/D
L/R shock absorber protector



4 Ø 50

TT /all models

Eléments TRAIN ARRIERE
Rear axle parts
Tren TRAS
Elementy zawieszenia tylnego
элементы задней оси.



5143123
 OE 351412

Butée de talonnage G/D
L/R bushing



6 Ø 53 H 55

TT /all models

Eléments DIRECTION
Steering parts
Elementos Direcciones
Elementy uklad kierowniczy
Элементы рулевой системы

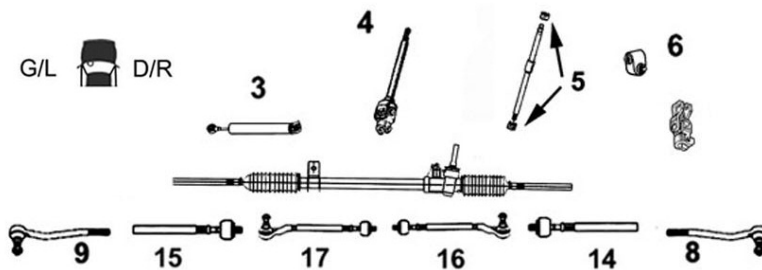

8123973
 OE 381297

Axe de bielle G/D
L/R axial joint



14 Côté dir. M12x1.0 Côté rot. M14x1.5
15 long 320 mm

TT /all models Sauf mot. XU
 Ch- 8139333 -12/83
 TT /all models XU 07/83-07/84

8123963
 OE 381296

Axe de bielle G/D
L/R axial joint



14 Côté dir. M12x1.0 Côté rot. M14x1.5
15 long 176 mm

TT /all models Ch- 9370001 XU
 08/84-

8123473
 OE 381247

Bielle de direction G
Left steering rod



17

TT /all models Ch- 9370001 XU
 08/84-

8123483
 OE 381248

Bielle de direction D
Right steering rod



16

TT /all models Ch- 9370001 XU
 08/84-

... 305 ...

Eléments DIRECTION

Steering parts

Elementos Direcciones

Elementy układ kierowniczy

Элементы рулевой системы

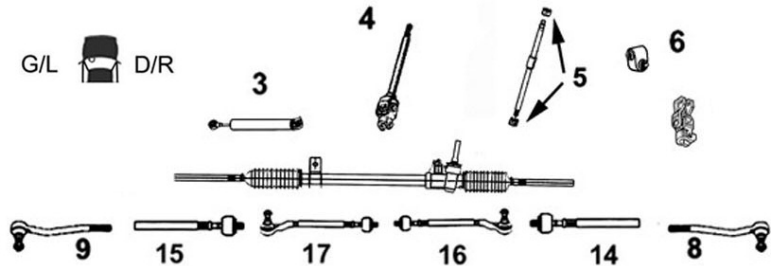

PEUGEOT

SASIC

8173263

OE 381748

Rotule de direction G

Left tie rod end

9 M14 x 1.5

TT /all models dir. 0054844 XU
01/83-



8173273

OE 381749

Rotule de direction D

Right tie rod end

8 M14 x 1.5

TT /all models dir. 0054844 XU
01/83-



8173303

OE 381741

Rotule de direction G

Left tie rod end

9 M14 x 1.5

TT /all models Sauf mot. XU
dir. (4005.62) 01/83-



8173313

OE 381742

Rotule de direction D

Right tie rod end

8 M14 x 1.5

TT /all models Sauf mot. XU
dir. (4005.62) 01/83-



8173183

OE 381750

Rotule de direction G/D

L/R tie rod end

8
9 M14 x 1.5

TT /all models pour dir.Sasic 0054294 XU 01/83-

TT /all models dir. 0024644 / 0024864 Sauf mot. XU



Barre stabilisatrice

Stabilizer bar

Barra estabilizadora

Drażek stabilizatora

стабилизатор поперечной устойчивости

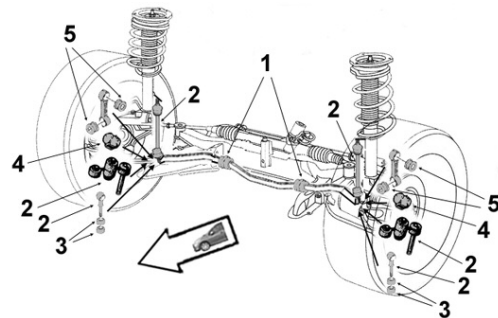

0875215

OE 508721

Biellette barre stab.

Stabilizer bar stub axle

2

TT /all models Essence sauf XU
Côté gauche Ch- 8987001 BVA 01/83-



0945245

OE 509424

Palier de barre

Bar main bearing

1 Barre Ø 26



TT /all models Essence Diesel -12/82



... 305 ...

PEUGEOT

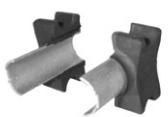





<p>0945355UN OE 509435</p> 	<p>Palier de barre <i>Bar main bearing</i></p> <p>1 Barre Ø 20</p> <p>TT /all models Essence Diesel XU 01/83-</p>	<p>0945345UN OE 509434</p> 	<p>Palier de barre <i>Bar main bearing</i></p> <p>1 Barre Ø 22</p> <p>TT /all models Essence Sauf XU 01/83-</p>
---	---	--	---

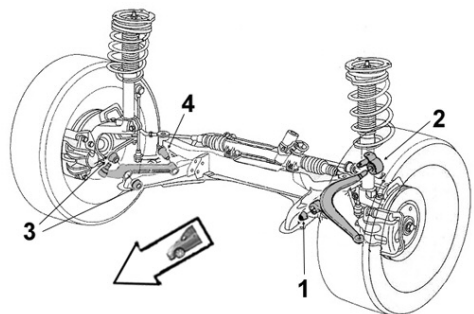

Eléments SUSPENSION
Suspension parts
Elementos suspensión
Elementy zawieszenie
Элементы подвески





<p>5233223UN OE 352322</p> 	<p>Articulation ext. <i>Outer bush</i></p> <p>3 Ø int.14 Ø ext.38 coll.50 long. tube int.30 ext.15 ep. coll.12</p> <p>TT /all models Essence Diesel -12/82</p>	<p>5233173 OE 352317</p> 	<p>Articulation int. <i>Inner bush</i></p> <p>4 Ø int.12 Ø ext.31 coll.42 long. tube int.38 ext.28 ep. coll.5</p> <p>TT /all models Essence Diesel -12/82</p>
--	--	---	---

<p>5233233 OE 352323</p> 	<p>Articulation AV <i>Front bush</i></p> <p>1 Ø int.12 Ø ext.31 coll.42 long. tube int.38 ext.26.5 ep. coll.6.5</p> <p>TT /all models Essence Diesel XU 01/83-</p>	<p>5233243 OE 352324</p> 	<p>Articulation AR <i>Rear bush</i></p> <p>2 Ø int.16 Ø ext.34 coll.45 long. tube int.40 ext.28.5 ep. coll.6.5</p> <p>TT /all models Essence Diesel XU 01/83-</p>
---	--	--	---

Bras & Triangle de suspension
Control arm
Brazo y triángulo
Wahacz
Рычаг подвески

G/L  D/R



<p>5203373 OE 352037</p> 	<p>Bras de suspension G <i>Left track control arm</i></p> <p>4 Avec rotule With ball joint</p> <p>TT /all models Sauf mot. XU -12/83</p>	<p>5213263 OE 352126</p> 	<p>Bras de suspension D <i>Right track control arm</i></p> <p>3 Avec rotule With ball joint</p> <p>TT /all models Sauf mot. XU -12/83</p>
---	--	--	---

Bras & Triangle de suspension

Control arm
Brazo y triángulo
Wahacz
Рычаг подвески

G/L  D/R

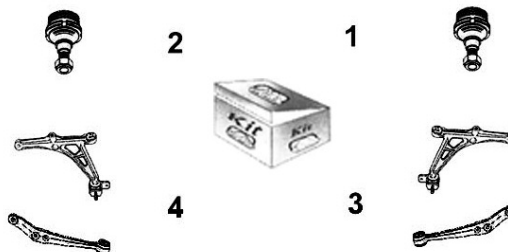

6403213
OE 364021

Rotule de susp. inf. G/D
L/R lower suspension ball joint



1
2 Ø 12 x 1.25

TT /all models XU 01/83-

1003547

Kit rép. bras susp. G ou D

OE - *L or R track control arm bearing repair kit*



TT /all models Sauf mot. XU -12/83

1003548
OE -

Kit rép. triangle susp. G ou D
L or R track control arm bearing repair kit



Avec visserie With screws and bolts

TT /all models XU 01/83-

1003536

Kit rép. triangle susp. G ou D

OE - *L or R track control arm bearing repair kit*



Sans visserie Without screws and bolts

TT /all models XU 01/83-



Support d'amortisseur

Suspension mounting
Soporte amortiguador
Poduszka amortyzatora
Опора амортизатора

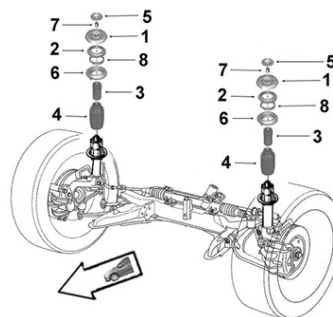

8003208
OE 503733

Tampon suspension G/D
L/R susp. rebound stop



1
TT /all models Essence Diesel 01/83-

0355275
OE 503563

Butée à billes G/D
L/R ball bearing



2
TT /all models
Essence Diesel XU 01/83-

0325235
OE 503223

Butée de suspension G/D
L/R suspension bush



3
TT /all models Essence Diesel -12/82

2545075
OE 525407

Protecteur amortisseur G/D
L/R shock absorber protector



4 Ø 50
TT /all models Essence Diesel -12/82

... 305

0355185

OE 503155

Kit rép. support susp. G/D

L/R susp. mounting repair kit

(Tampon caoutchouc+Butée à billes) *Rubber top + Ball bearing*



TT /all models Essence Diesel XU

01/83-



Support d'amortisseur

Suspension mounting

Soporte amortiguador

Poduszka amortyzatora

Опора амортизатора

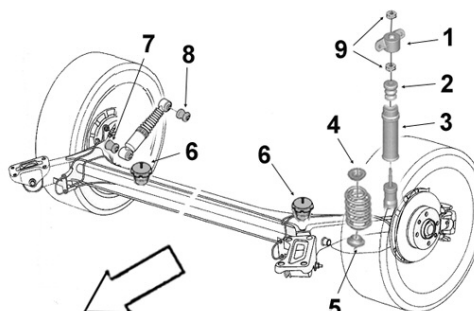

5143123

OE 351412

Butée de talonnage G/D

L/R bushing

6 Ø53 H 55



TT /all models Essence Diesel

306 ...

Eléments DIRECTION

Steering parts

Elementos Direcciones

Elementy uklad kierowniczy

Элементы рулевой системы

G/L  D/R

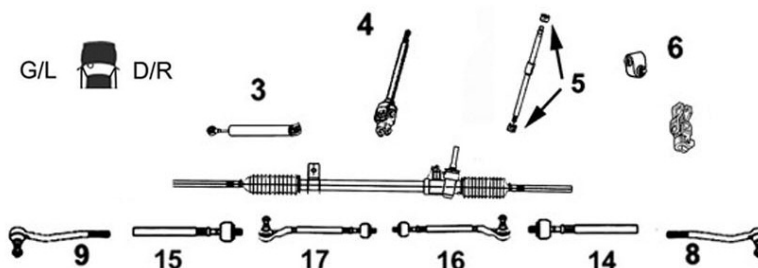

0114444

OE 401144

Vérin dir. assistée

Power steering jack

3



TT /all models
Sauf 2.0 16v. GTi mot. XU10J4RS

8123923

OE 381292

Axe de bielle G/D

L/R axial joint

14

15 Côté dir. M12x1.0 Côté rot. M14x1.5
long 355 mm



TT /all models DNA DA

3001220

OE -

Bielle de direction G/D

L/R steering rod

16
17



TT /all models -17/08/95

8173183

OE 381750

Rotule de direction G/D

L/R tie rod end

8
9

M14 x 1.5



TT /all models DNA DA

Eléments DIRECTION
 Steering parts
 Elementos Direcciones
 Elementy układ kierowniczy
 Элементы рулевой системы

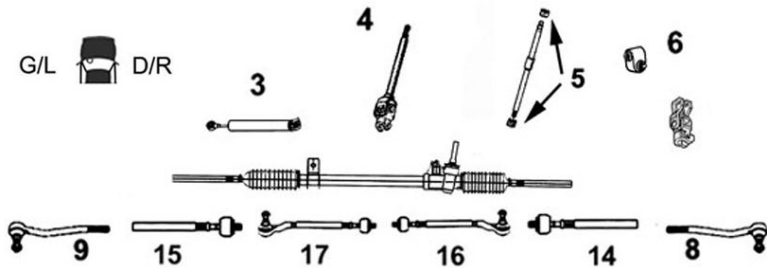



1034C84 OE 4103C8	Axe de volant <i>Steering wheel shaft</i>
	4 TT /all models DA

1034C94 OE 4103C1	Axe de volant <i>Steering wheel shaft</i>
	4 TT /all models Conduite à G



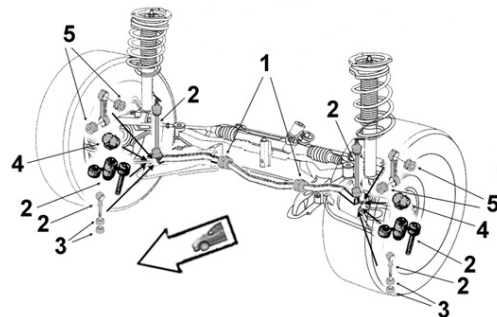

Barre stabilisatrice
 Stabilizer bar
 Barra estabilizadora
 Drążek stabilizatora
 стабилизатор поперечной устойчивости





0875395 OE 508761	Biellette barre stab. <i>Stabilizer bar stub axle</i>
	2 1.1i TU1M -05/09/94 1.4 TU3 TU32 -05/09/94 1.4i TU3JP/MC -05/09/94 1.6i TU5JP -05/09/94 1.8i 16v. XU7JP -05/09/94 1.8 D XUD7 -05/09/94 1.9 D XUD9 DW8/B -05/09/94 1.9 TD XUD9TE -05/09/94 2.0i XU10J2/4 -05/09/94

0875425 OE 508742	Biellette barre stab. <i>Stabilizer bar stub axle</i>
	2 1.1i TU1M 06/09/94- 1.4i TU3/2/JP/MC 06/09/94- 1.6i TU5JP 06/09/94- 1.8i 16v. XU7JP/JP4 06/09/94- 1.8 D XUD7 06/09/94- 1.9 D XUD9 DW8/B 06/09/94- 1.9 TD XUD9TE 06/09/94- 2.0i XU10J2 06/09/94- 2.0i 16v. XU10J4R/S 06/09/94- 2.0 HDi DW10TD 06/09/94-

0945635 OE 509463	Palier de barre milieu <i>Middle bar main bearing</i>
	1 Barre Ø 17 1.1i TU1M 1.4 TU3 TU32 1.4i TU3JP TU3MC 1.6i TU5JP

0945645 OE 509464	Palier de barre milieu <i>Middle bar main bearing</i>
	1 Barre Ø 18 1.1i TU1M 1.4/i TU3/32 TU3JP /MC 1.6i TU5JP 1.8i 16v. XU7JP/JP4 1.8 D XUD7 1.9 D XUD9 DW8/B 1.9 TD XUD9TE 2.0i XU10J2 2.0i 16v. XU10J4R/S/Z 2.0 HDi DW10TD

0945665 OE 509466	Palier de barre milieu <i>Middle bar main bearing</i>
	1 Barre Ø 19 1.1i TU1M 1.4/i TU3/32 TU3JP/MC 1.6i TU5JP 1.8i 16v. XU7JP/JP4 1.8 D XUD7 1.9 D XUD9 DW8/B 1.9 TD XUD9TE 2.0i XU10J2 2.0i 16v. XU10J4R/S 2.0 HDi DW10TD

0945795 OE 509479	Palier de barre milieu <i>Middle bar main bearing</i>
	1 Barre Ø 20 1.4/i Break TU3/32 TU3JP/MC 1.6i Break TU5JP BVA 1.8i 16v. XU7JP/JP4 1.8 D XUD7 1.9 D XUD9 DW8/B 1.9 TD XUD9TE 2.0i XU10J2 2.0i 16v. XU10J4R/S 2.0 HDi DW10TD

<p>0945655 OE 509465</p> 	<p>Palier de barre milieu <i>Middle bar main bearing</i></p> <p>1 Barre Ø 21 1.8i 16v. XU7JP/JP4 1.8 D XU7 1.9 D XUD9 DW8/B 1.9 TD XUD9TE 2.0i XU10J2 2.0i 16v. XU10J4R/S/D 2.0 HDi DW10TD</p>	<p>0945775 OE 509477</p> 	<p>Palier de barre milieu <i>Middle bar main bearing</i></p> <p>1 Barre Ø 22 Break 5ptes VP/VU Susp. normale 1.9 D DW8/B 2.0 HDi DW10TD</p>
---	--	--	--



Eléments SUSPENSION



Suspension parts

Elementos suspensión

Elementy zawieszenie

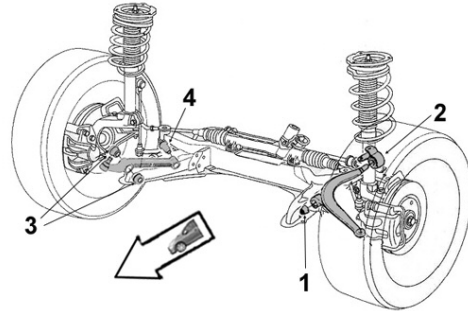
Элементы подвески



<p>2005250 OE -</p> 	<p>Articulation AV <i>Front bush</i></p> <p>1 Ø int.12 Ø ext.33 coll.44 long. tube int.31 ext.27 ep. coll.4.5 1.1i TU1M 1.4/i TU3/32 TU3JP/MC 1.6i TU5JP 1.8i 16v. XU7JP/JP4 1.8 D XU7 1.9 D XUD9 DW8/B 1.9 TD XUD9TE 2.0i/ 16v. XU10J2 XU10J4R/S 2.0 HDi DW10TD</p>	<p>5233623 OE 352375</p> 	<p>Articulation AR <i>Rear bush</i></p> <p>2 Ø int.19 1.1i TU1M 1.4/i TU3/32 TU3JP/MC 1.6i TU5JP 1.8i 16v. XU7JP/JP4 1.8 D XU7 1.9 D XUD9 DW8/B 1.9 TD XUD9TE 2.0i/ 16v. XU10J2 XU10J4R/S 2.0 HDi DW10TD</p>
---	--	---	--

Bras & Triangle de suspension

Control arm





Brazo y triángulo

Wahacz

Рычаг подвески

G/L  D/R











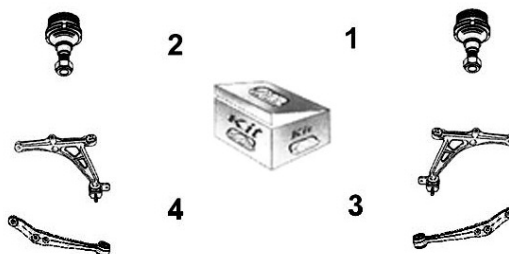

<p>5203F33 OE 3520F3</p> 	<p>Triangle de susp. G <i>Left track control arm</i></p> <p>4 Avec rotule With ball joint Ø 16 TT /all models</p>	<p>5213A33 OE 3521A3</p> 	<p>Triangle de susp. D <i>Right track control arm</i></p> <p>3 Avec rotule With ball joint Ø 16 TT /all models</p>
<p>5203H33 OE 3520H3</p> 	<p>Triangle de susp. G <i>Left track control arm</i></p> <p>4 Avec rotule With ball joint Ø 18 TT /all models Sauf Sport /Susp. ferme ou renforcée</p>	<p>5213E33 OE 3521E3</p> 	<p>Triangle de susp. D <i>Right track control arm</i></p> <p>3 Avec rotule With ball joint Ø 18 TT /all models Sauf Sport /susp. ferme ou renforcée</p>

Bras & Triangle de suspension

Control arm
Brazo y triángulo
Wahacz
Рычаг подвески

G/L  D/R



<p>5203F73 OE 3520F7</p> 	<p>Triangle de susp. G <i>Left track control arm</i></p> <p>4 Sans rotule <i>Without tie rod end</i></p> <p>TT /all models</p>	<p>5213A73 OE 3521A7</p> 	<p>Triangle de susp. D <i>Right track control arm</i></p> <p>3 Sans rotule <i>Without tie rod end</i></p> <p>TT /all models</p>
<p>6403313 OE 364044</p> 	<p>Rotule de susp. inf. G/D <i>L/R lower suspension ball joint</i></p> <p>1/2 Ø 16</p> <p>TT /all models DNA DA</p>	<p>6403483 OE 364049</p> 	<p>Rotule de susp. inf. G/D <i>L/R lower suspension ball joint</i></p> <p>1/2 Ø 18</p> <p>TT /all models DNA DA</p>
<p>109A562S OE -</p> 	<p>Kit rép. train AV <i>Front axle repair kit</i></p> <p>Sans visserie <i>Without screws and bolts</i> Barre Ø 17 Art. AR Ø 19</p> <p>TT /all models</p>	<p>110A562S OE -</p> 	<p>Kit rép. train AV <i>Front axle repair kit</i></p> <p>Sans visserie <i>Without screws and bolts</i> Barre Ø 18 Art. AR Ø 19</p> <p>TT /all models</p>
<p>106A562S OE -</p> 	<p>Kit rép. train AV <i>Front axle repair kit</i></p> <p>Sans visserie <i>Without screws and bolts</i> Barre Ø 19 Art. AR Ø 19</p> <p>TT /all models</p>	<p>107A562S OE -</p> 	<p>Kit rép. train AV <i>Front axle repair kit</i></p> <p>Sans visserie <i>Without screws and bolts</i> Barre Ø 21 Art. AR Ø 19</p> <p>TT /all models</p>
<p>1093562B OE -</p> 	<p>Kit rép. train AV complet <i>Front axle complete repair kit</i></p> <p>Avec visserie <i>With screws and bolts</i> Barre Ø 17 Art. AR Ø 19</p> <p>TT /all models</p>	<p>1073562B OE -</p> 	<p>Kit rép. train AV complet <i>Front axle complete repair kit</i></p> <p>Avec visserie <i>With screws and bolts</i> Barre Ø 21 Art. AR Ø 19</p> <p>TT /all models</p>

1003562

Kit rép. triangle susp. G ou D

OE -

L or R track control arm bearing repair kit



Avec visserie *With screws and bolts*
Articulation AR Ø 19

TT /all models



Support d'amortisseur

Suspension mounting
Soporte amortiguador
Poduszka amortyzatora
Опора амортизатора

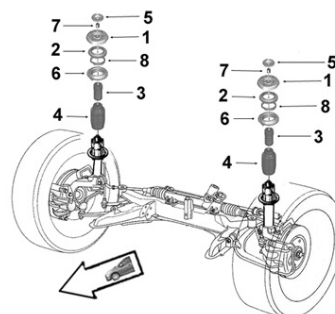

0385225

Support suspension G/D

OE 503862

L/R suspension mounting



1	1.1i	TU1M
	1.4/i	TU3/32 TU3JP/MC
	1.6i	TU5JP
	1.8i 16v.	XU7JP/JP4
	1.8 D	XUD7
	1.9 D	XUD9 DW8/B
	1.9 TD	XUD9TE
	2.0i/ 16v.	XU10J2 XU10J4R/S
	2.0 HDi	DW10TD

0355275

Butée à billes G/D

OE 503563

L/R ball bearing



2	1.1i	TU1M
	1.4/i	TU3/32 TU3JP/MC
	1.6i	TU5JP
	1.8i 16v.	XU7JP/JP4
	1.8 D	XUD7
	1.9 D	XUD9 DW8/B
	1.9 TD	XUD9TE
	2.0i/ 16v.	XU10J2 XU10J4R/S
	2.0 HDi	DW10TD

0335235

Butée de suspension G/D

OE 503323

L/R suspension bush



3	H57 Berline Susp. normale	
	1.1i	TU1M/+ -03/97
	1.4 165/70/13	TU32 -03/97
	1.4	TU32 04/97-
	1.4i 175/70/13 175/65/14	TU3MC -03/97
	1.4i Niveau 1 2	TU3JP -03/97
	1.4i	TU3JP 04/97-

0335275

Butée de suspension G/D

OE 503327

L/R suspension bush



3	H97	
	1.1i	TU1M
	1.4/i	TU3/32 TU3JP/MC
	1.6i	TU5JP
	1.8i /16v.	XU7JP/4
	1.8 D	XUD7
	1.9 D Berline 4ptes /Break 5ptes	DW8/B
	1.9 D/TD	XUD9/TE
	2.0i/ 16v.	XU10J2 XU10J4R/S
2.0 HDi	DW10TD	

2545135

Protecteur amortisseur G/D

OE 525413

L/R shock absorber protector



4	1.1i	TU1M
	1.4/i	TU3/32 TU3JP/MC
	1.6i	TU5JP
	1.8i 16v.	XU7JP/JP4
	1.8 D	XUD7
	1.9 D	XUD9 DW8/B
	1.9 TD	XUD9TE
	2.0i/ 16v.	XU10J2 XU10J4R/S
	2.0 HDi	DW10TD

1005250

Kit rép. protection amort. G et D

OE -

L/R susp. mounting repair kit



	Butée H 97	
	1.1i	TU1M
	1.4/i	TU3/32 TU3MC/JP
	1.6i	TU5JP
	1.8i	XU7JP
	1.8i 16v.	XU7JP4
	1.8 D	XUD7
	1.9 D/ TD	XUD9A/TE
	2.0i/ 16v.	XU10J2 XU10J4R/S

1005268

Kit rép. suspension G ou D

OE -

L/R stabilizing bar repair kit



	1.1i	TU1M
	1.4/i	TU3/32 TU3MC/JP
	1.6i	TU5JP
	1.8i	XU7JP
	1.8i 16v.	XU7JP4
	1.8 D	XUD7
	1.9 D	XUD9A
	1.9 TD	XUD9TE
	2.0i/ 16v.	XU10J2 XU10J4R/S

... 306 ...



Support d'amortisseur

Suspension mounting
Soporte amortiguador
Poduszka amortyzatora
Опора амортизатора

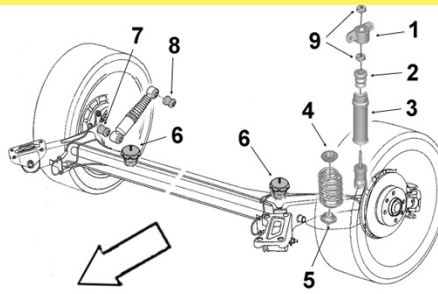

PEUGEOT

SASIC

1715105

OE 517110

Art. sup. amortisseur

Upper shock absorber bush



8 Ø int.12.2 Ø ext.30 coll.33.5 x2 long. tube int.39.8 ext.35 ep. coll.3x2

1.1	TU1M		-03/97
1.4/i	TU3/32	TU3JP/MC	-03/02
1.6i	TU5JP		-03/02
1.8i	XU7JP		-03/97
1.8i 16v.	XU7JP/JP4		04/97-03/02
1.9 D /TD	XUD9 DW8/B	XUD9TE	-03/02
2.0i	XU10J2/J4		-03/97
2.0i 16v.	XU10J4R/S		04/97-03/02
2.0 HDi	DW10TD		04/97-03/02

1715095

OE 517109

Art. inf. amortisseur

Lower shock absorber bush



7 Ø int.14.6 Ø ext.34.9 coll.37.5 x2 long. tube int.39.8 ext.33.7 ep. coll.3.2x2

1.1	TU1M		-03/97
1.4/i	TU3/32	TU3JP/MC	-03/02
1.6i	TU5JP		-03/02
1.8i	XU7JP		-03/97
1.8i 16v.	XU7JP/JP4		04/97-03/02
1.9 D /TD	XUD9 DW8/B	XUD9TE	-03/02
2.0i	XU10J2/J4		-03/97
2.0i 16v.	XU10J4R/S		04/97-03/02
2.0 HDi	DW10TD		04/97-03/02

1665315

OE 516631

Butée de talonnage

Bushing



6 Ø 49.5 H 63

1.1i			TU1M	
1.4/i			TU3/32	TU3JP/MC
1.6i			TU5JP	
1.8i 16v.	Sauf Série 2 cab. Mot. XU inj. tambours AR ABS		XU7JP/JP4	
1.8 D	Sauf Série 2 cab. Mot. XU inj. tambours AR ABS		XUD7	
1.9 D /TD	Sauf Série 2 cab. Mot. XU inj. tambours AR ABS		XUD9 DW8/B	XUD9TE
2.0i /16v.	Sauf Série 2 cab. Mot. XU inj. tambours AR ABS		XU10J2	XU10J4R/S
2.0 HDi	Sauf Série 2 cab. Mot. XU inj. tambours AR ABS		DW10TD	

Eléments TRAIN ARRIERE

Rear axle parts

Tren TRAS

Elementy zawieszenia tylnego

элементы задней оси.



1315695

OE 513169

Support AVG traverse

Cross bar left front mounting



Paulstra

1.1i	TU1M	
1.4/i	TU3/32	TU3JP/MC
1.6i	TU5JP	
1.8i 16v.	XU7JP/JP4	
1.8 D	XUD7	
1.9 D	XUD9 DW8/B	
1.9 TD	XUD9TE	
2.0i /16v.	XU10J2	XU10J4R/S/D
2.0 HDi	DW10TD	

1315705

OE 513170

Support AVD traverse



Cross bar right front mounting



Paulstra

1.1i	TU1M	
1.4/i	TU3/32	TU3JP/MC
1.6i	TU5JP	
1.8i 16v.	XU7JP/JP4	
1.8 D	XUD7	
1.9 D	XUD9 DW8/B	
1.9 TD	XUD9TE	
2.0i /16v.	XU10J2	XU10J4R/S/D
2.0 HDi	DW10TD	

... 306

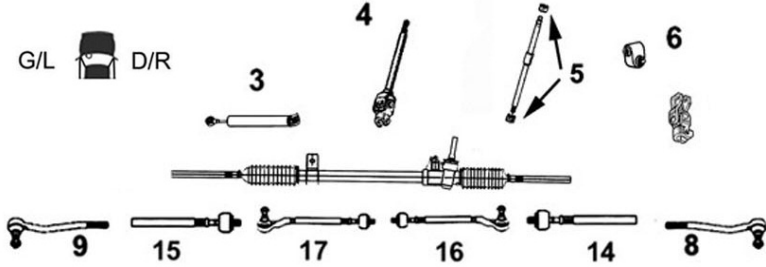

1315715 OE 513171	Support train AR <i>Rear axle mounting</i>	1005116 OE -	Kit rép. train AR G ou D <i>L/R rear axle repair kit</i>																
	<table border="0"> <tr><td>1.1i</td><td>TU1M</td></tr> <tr><td>1.4/i</td><td>TU3/32 TU3JP/MC</td></tr> <tr><td>1.6i</td><td>TU5JP</td></tr> <tr><td>1.8i 16v.</td><td>XU7JP/JP4</td></tr> <tr><td>1.8 D</td><td>XUD7</td></tr> <tr><td>1.9 D/TD</td><td>XUD9 DW8/B XUD9TE</td></tr> <tr><td>2.0i/ 16v.</td><td>XU10J2 XU10J4R/S/D</td></tr> <tr><td>2.0 HDi</td><td>DW10TD</td></tr> </table>	1.1i	TU1M	1.4/i	TU3/32 TU3JP/MC	1.6i	TU5JP	1.8i 16v.	XU7JP/JP4	1.8 D	XUD7	1.9 D/TD	XUD9 DW8/B XUD9TE	2.0i/ 16v.	XU10J2 XU10J4R/S/D	2.0 HDi	DW10TD		TT /all models
1.1i	TU1M																		
1.4/i	TU3/32 TU3JP/MC																		
1.6i	TU5JP																		
1.8i 16v.	XU7JP/JP4																		
1.8 D	XUD7																		
1.9 D/TD	XUD9 DW8/B XUD9TE																		
2.0i/ 16v.	XU10J2 XU10J4R/S/D																		
2.0 HDi	DW10TD																		

307 ...

<p>Eléments DIRECTION <i>Steering parts</i> <i>Elementos Direcciones</i> <i>Elementy układ kierowniczy</i> <i>Элементы рулевой системы</i></p>	
---	--

3008159 Part/oe 3812E0	Axe de bielle G/D <i>L/R axial joint</i>																				
	14 Côté dir. M14x1.5 Côté rot. M14x1.5 15 long 322 mm DA variable	<table border="0"> <tr><td>1.4i /16v.</td><td>TU3JP ET3J4</td><td>-30/01/05</td></tr> <tr><td>1.4 HDi</td><td>DV4TD</td><td>-30/01/05</td></tr> <tr><td>1.6i 16v.</td><td>TU5JP4</td><td>-30/01/05</td></tr> <tr><td>1.6 HDi</td><td>DV6ATED4</td><td>-30/01/05</td></tr> <tr><td>2.0i 16v.</td><td>EW10J4/S EW10A</td><td>-30/01/05</td></tr> <tr><td>2.0 HDi</td><td>DW10TD/BTED4</td><td>-30/01/05</td></tr> </table>	1.4i /16v.	TU3JP ET3J4	-30/01/05	1.4 HDi	DV4TD	-30/01/05	1.6i 16v.	TU5JP4	-30/01/05	1.6 HDi	DV6ATED4	-30/01/05	2.0i 16v.	EW10J4/S EW10A	-30/01/05	2.0 HDi	DW10TD/BTED4	-30/01/05	
1.4i /16v.	TU3JP ET3J4	-30/01/05																			
1.4 HDi	DV4TD	-30/01/05																			
1.6i 16v.	TU5JP4	-30/01/05																			
1.6 HDi	DV6ATED4	-30/01/05																			
2.0i 16v.	EW10J4/S EW10A	-30/01/05																			
2.0 HDi	DW10TD/BTED4	-30/01/05																			

8123E53 OE 3812E5	Axe de bielle G/D <i>L/R axial joint</i>																																																																										
	14 Côté dir. M14x1.5 Côté rot. M14x1.5 15 long 340 mm	<table border="0"> <tr><td>1.4i 16v.</td><td>DA</td><td>ET3J4</td><td>31/01/05-27/03/05</td></tr> <tr><td>1.4i 16v.</td><td></td><td>ET3J4</td><td>28/03/05-</td></tr> <tr><td>1.4i</td><td>DA</td><td>TU3JP</td><td>31/01/05-27/03/05</td></tr> <tr><td>1.4 HDi</td><td>DA</td><td>DV4TD</td><td>31/01/05-27/03/05</td></tr> <tr><td>1.6i 16v.</td><td>DA</td><td>TU5JP4</td><td>31/01/05-27/03/05</td></tr> <tr><td>1.6i 16v.</td><td></td><td>TU5JP4</td><td>28/03/05-</td></tr> <tr><td>1.6 HDi</td><td>DA</td><td>DV6ATED4</td><td>31/01/05-27/03/05</td></tr> <tr><td>1.6 HDi</td><td></td><td>DV6ATED4</td><td>28/03/05-</td></tr> <tr><td>1.6 HDi 90hp 66kw FAP</td><td></td><td>DV6TED4B</td><td>28/03/05-</td></tr> <tr><td>1.6 HDi 110hp 80kw</td><td></td><td>DV6TED4</td><td>28/03/05-</td></tr> <tr><td>2.0i 16v.</td><td></td><td>EW10A</td><td>28/03/05-</td></tr> <tr><td>2.0i 16v.</td><td>DA</td><td>EW10J4/S</td><td>31/01/05-27/03/05</td></tr> <tr><td>2.0i 16v.</td><td></td><td>EW10J4S</td><td>28/03/05-</td></tr> <tr><td>2.0 HDi</td><td>DA</td><td>DW10TD</td><td>31/01/05-27/03/05</td></tr> <tr><td>2.0 HDi</td><td></td><td>DW10TD</td><td>28/03/05-</td></tr> <tr><td>2.0 HDi</td><td>DA</td><td>DW10BTED4</td><td>31/01/05-27/03/05</td></tr> <tr><td>2.0 HDi FAP</td><td></td><td>DW10BTED4</td><td>28/03/05-</td></tr> <tr><td>2.0 HDi sans FAP</td><td></td><td>DW10ATED</td><td>28/03/05-</td></tr> </table>	1.4i 16v.	DA	ET3J4	31/01/05-27/03/05	1.4i 16v.		ET3J4	28/03/05-	1.4i	DA	TU3JP	31/01/05-27/03/05	1.4 HDi	DA	DV4TD	31/01/05-27/03/05	1.6i 16v.	DA	TU5JP4	31/01/05-27/03/05	1.6i 16v.		TU5JP4	28/03/05-	1.6 HDi	DA	DV6ATED4	31/01/05-27/03/05	1.6 HDi		DV6ATED4	28/03/05-	1.6 HDi 90hp 66kw FAP		DV6TED4B	28/03/05-	1.6 HDi 110hp 80kw		DV6TED4	28/03/05-	2.0i 16v.		EW10A	28/03/05-	2.0i 16v.	DA	EW10J4/S	31/01/05-27/03/05	2.0i 16v.		EW10J4S	28/03/05-	2.0 HDi	DA	DW10TD	31/01/05-27/03/05	2.0 HDi		DW10TD	28/03/05-	2.0 HDi	DA	DW10BTED4	31/01/05-27/03/05	2.0 HDi FAP		DW10BTED4	28/03/05-	2.0 HDi sans FAP		DW10ATED	28/03/05-	
1.4i 16v.	DA	ET3J4	31/01/05-27/03/05																																																																								
1.4i 16v.		ET3J4	28/03/05-																																																																								
1.4i	DA	TU3JP	31/01/05-27/03/05																																																																								
1.4 HDi	DA	DV4TD	31/01/05-27/03/05																																																																								
1.6i 16v.	DA	TU5JP4	31/01/05-27/03/05																																																																								
1.6i 16v.		TU5JP4	28/03/05-																																																																								
1.6 HDi	DA	DV6ATED4	31/01/05-27/03/05																																																																								
1.6 HDi		DV6ATED4	28/03/05-																																																																								
1.6 HDi 90hp 66kw FAP		DV6TED4B	28/03/05-																																																																								
1.6 HDi 110hp 80kw		DV6TED4	28/03/05-																																																																								
2.0i 16v.		EW10A	28/03/05-																																																																								
2.0i 16v.	DA	EW10J4/S	31/01/05-27/03/05																																																																								
2.0i 16v.		EW10J4S	28/03/05-																																																																								
2.0 HDi	DA	DW10TD	31/01/05-27/03/05																																																																								
2.0 HDi		DW10TD	28/03/05-																																																																								
2.0 HDi	DA	DW10BTED4	31/01/05-27/03/05																																																																								
2.0 HDi FAP		DW10BTED4	28/03/05-																																																																								
2.0 HDi sans FAP		DW10ATED	28/03/05-																																																																								

8173313 OE 381742	Rotule de direction G <i>Left tie rod end</i>	8173303 OE 381741	Rotule de direction D <i>Right tie rod end</i>																																										
	9 M14 x 1.5 DA variable <table border="0"> <tr><td>1.4i /16v.</td><td>TU3JP ET3J4</td><td>-30/01/05</td></tr> <tr><td>1.4 HDi</td><td>DV4TD</td><td>-30/01/05</td></tr> <tr><td>1.6i 16v.</td><td>TU5JP4</td><td>-30/01/05</td></tr> <tr><td>1.6 HDi</td><td>DV6ATED4</td><td>-30/01/05</td></tr> <tr><td>2.0i 16v.</td><td>EW10J4/S EW10A</td><td>-30/01/05</td></tr> <tr><td>2.0 HDi</td><td>DW10TD</td><td>-30/01/05</td></tr> <tr><td>2.0 HDi</td><td>DW10BTED4</td><td>-30/01/05</td></tr> </table>	1.4i /16v.	TU3JP ET3J4	-30/01/05	1.4 HDi	DV4TD	-30/01/05	1.6i 16v.	TU5JP4	-30/01/05	1.6 HDi	DV6ATED4	-30/01/05	2.0i 16v.	EW10J4/S EW10A	-30/01/05	2.0 HDi	DW10TD	-30/01/05	2.0 HDi	DW10BTED4	-30/01/05		8 M14 x 1.5 DA variable <table border="0"> <tr><td>1.4i /16v.</td><td>TU3JP ET3J4</td><td>-30/01/05</td></tr> <tr><td>1.4 HDi</td><td>DV4TD</td><td>-30/01/05</td></tr> <tr><td>1.6i 16v.</td><td>TU5JP4</td><td>-30/01/05</td></tr> <tr><td>1.6 HDi</td><td>DV6ATED4</td><td>-30/01/05</td></tr> <tr><td>2.0i 16v.</td><td>EW10J4/S EW10A</td><td>-30/01/05</td></tr> <tr><td>2.0 HDi</td><td>DW10TD</td><td>-30/01/05</td></tr> <tr><td>2.0 HDi</td><td>DW10BTED4</td><td>-30/01/05</td></tr> </table>	1.4i /16v.	TU3JP ET3J4	-30/01/05	1.4 HDi	DV4TD	-30/01/05	1.6i 16v.	TU5JP4	-30/01/05	1.6 HDi	DV6ATED4	-30/01/05	2.0i 16v.	EW10J4/S EW10A	-30/01/05	2.0 HDi	DW10TD	-30/01/05	2.0 HDi	DW10BTED4	-30/01/05
1.4i /16v.	TU3JP ET3J4	-30/01/05																																											
1.4 HDi	DV4TD	-30/01/05																																											
1.6i 16v.	TU5JP4	-30/01/05																																											
1.6 HDi	DV6ATED4	-30/01/05																																											
2.0i 16v.	EW10J4/S EW10A	-30/01/05																																											
2.0 HDi	DW10TD	-30/01/05																																											
2.0 HDi	DW10BTED4	-30/01/05																																											
1.4i /16v.	TU3JP ET3J4	-30/01/05																																											
1.4 HDi	DV4TD	-30/01/05																																											
1.6i 16v.	TU5JP4	-30/01/05																																											
1.6 HDi	DV6ATED4	-30/01/05																																											
2.0i 16v.	EW10J4/S EW10A	-30/01/05																																											
2.0 HDi	DW10TD	-30/01/05																																											
2.0 HDi	DW10BTED4	-30/01/05																																											

... 307 ...

Eléments DIRECTION

Steering parts

Elementos Direcciones

Elementy uklad kierowniczy

Элементы рулевой системы

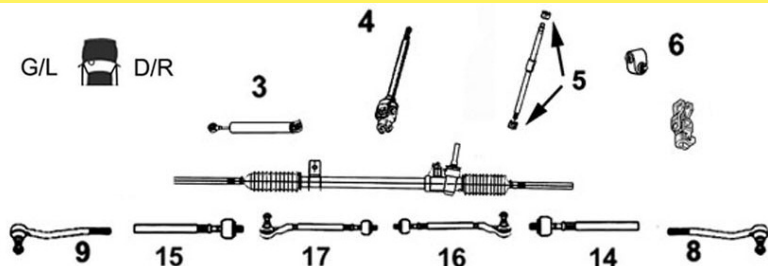

PEUGEOT

8173183

OE 381750

Rotule de direction G/D

L/R tie rod end



8

9

M14x1.5

1.4i
1.4i 16v.
1.4 HDi
1.6i 16v.
1.6 HDi
1.6 HDi 110hp 80kw
1.6 HDi 90hp 66kw FAP
2.0i 16v.
2.0i 16v.
2.0 HDi
2.0 HDi sans FAP

TU3JP
ET3J4
DV4TD
TU5JP4
DV6ATED4
DV6TED4
DV6TED4B
EW10J4/S
EW10A EW10J4S
DW10TD/BTED4
DW10ATED

31/01/05-27/03/05
31/01/05-
31/01/05-27/03/05
31/01/05-
31/01/05-
28/03/05-
28/03/05-
31/01/05-27/03/05
28/03/05-
31/01/05-
28/03/05-
28/03/05-



Barre stabilisatrice

Stabilizer bar

Barra estabilizadora

Drążek stabilizatora

стабилизатор поперечной устойчивости

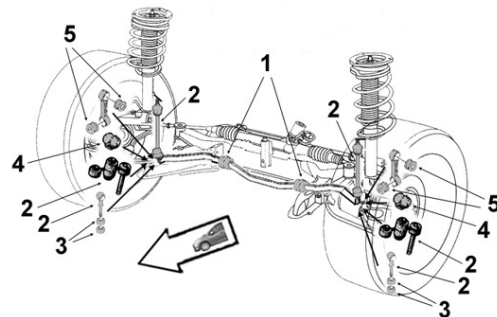

0875505

OE 508777

Biellette barre stab.

Stabilizer bar stub axle



2

1.4i
1.4i 16v.
1.4 HDi
1.6i 16v.
1.6 HDi
1.6 HDi FAP 90hp 66kw
2.0i 16v.
2.0i 16v.
2.0 HDi /FAP
2.0 HDi
2.0 HDi Sans FAP

TU3JP
ET3J4
DV4TD
TU5JP4
DV6TED4/ATED4
DV6TED4B
EW10A EW10J4S
EW10J4
DW10TD DW10BTED4
DW10ATED
DW10ATED

-27/03/05
-27/03/05
-27/03/05
28/03/05-
28/03/05-
-27/03/05
-27/03/05
-27/03/05
28/03/05-

0945875

OE 509487

Palier de barre milieu

Middle bar main bearing



1

Barre Ø 21

1.4i Berline 3/5ptes
1.4i 16v. Berline
1.4i 16v.

1.4 HDi

1.6i 16v. Berline 3/5ptes
1.6i 16v. Berline 5ptes
1.6i 16v.

1.6 HDi
1.6 HDi FAP 90hp 66kw

2.0i 16v.
2.0 HDi
2.0 HDi Sans FAP

TU3JP
ET3J4
ET3J4

DV4TD

TU5JP4
TU5JP4
TU5JP4

DV6TED4/ATED4
DV6TED4B

EW10A/J4S
DW10TD/BTED4
DW10ATED

08/01/01-27/03/05
-27/03/05
28/03/05-14/06/09

-27/03/05

12/03-07/07/04
08/07/04-27/03/05
28/03/05-14/06/09

28/03/05-14/06/09
28/03/05-14/06/09

28/03/05-14/06/09
28/03/05-14/06/09
28/03/05-14/06/09

0945885
OE 5094E0

Palier de barre milieu
Middle bar main bearing



1 Barre Ø 22			
1.4i Break	TU3JP		08/01/01-27/03/05
1.4i 16v. Break	ET3J4		-27/03/05
1.4i 16v.	ET3J4		28/03/05-
1.4 HDi Break	DV4TD		-27/03/05
1.6i 16v. Berline 4ptes Break	TU5JP4		12/03-07/07/04
1.6i 16v.	TU5JP4		28/03/05-
1.6 HDi	DV6TED4/ATED4		28/03/05-
1.6 HDi Berline	DV6TED4		-2703/05
1.6 HDi Berline	DV6ATED4		
1.6 HDi FAP 90hp 66kw	DV6TED4B		28/03/05-
2.0i 16v. Berline	EW10J4		12/03-07/07/04
2.0i 16v.	EW10J4		08/07/04-27/03/05
2.0i 16v. Berline 3/5ptes	EW10A		10/01/05-27/03/05
2.0i 16v.	EW10A/J4S		28/03/05-
2.0i 16v. Berline 3ptes	EW10J4S		07/03-27/03/05
2.0 HDi Berline 3/5ptes	DW10TD		28/12/03-07/07/04
2.0 HDi	DW10TD		08/07/04-
2.0 HDi FAP Berline 3/5ptes	DW10ATED		04/06/01-27/03/05
2.0 HDi Sans FAP	DW10ATED		28/03/05-
2.0 HDi FAP Berline 3/5ptes	DW10BTED4		24/11/03-27/03/05
2.0 HDi FAP	DW10BTED4		28/03/05-

0945895
OE 5094E3

Palier de barre milieu
Middle bar main bearing



1 Barre Ø 23			
1.4i 16v.	ET3J4		28/03/05-
1.6i 16v.	TU5JP4		28/03/05-
1.6 HDi	DV6ATED4		28/03/05-
1.6 HDi Break	DV6TED4/ ATED4		
1.6 HDi FAP 90hp 66kw	DV6TED4B		28/03/05-
2.0i 16v. Break	EW10A		10/01/05-27/03/05
2.0i 16v.	EW10A/J4S		28/03/05-
2.0i 16v. Break	EW10J4		12/03-27/03/05
2.0 HDi Break	DW10TD		28/12/03-07/07/04
2.0 HDi	DW10TD		28/03/05-
2.0 HDi FAP Break	DW10ATED		04/06/01-27/03/05
2.0 HDi	DW10ATED		28/03/05-
2.0 HDi FAP Break	DW10BTED4		24/11/03-27/03/05
2.0 HDi FAP	DW10BTED4		28/03/05-



Eléments SUSPENSION
Suspension parts
Elementos suspensión
Elementy zawieszenie
Элементы подвески

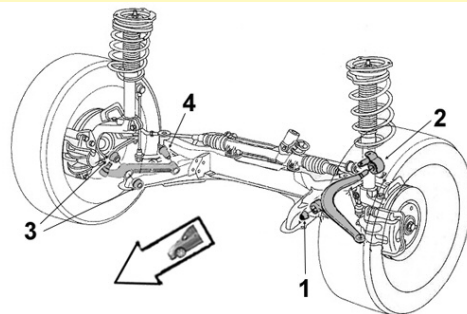

5233913
OE 352391

Articulation AV
Front bush



1 Ø int.14 Ø ext.55 long. tube int.56 ext.32			
1.4i	TU3JP		-27/03/05
1.4i 16v.	ET3J4		
1.4 HDi	DV4TD		-27/03/05
1.6i 16v.	TU5JP4		
1.6 HDi	DV6TED4/ATED4		
1.6 HDi FAP 90hp 66kw	DV6TED4B		28/03/05-
2.0i 16v.	EW10A/J4S		
2.0i 16v.	EW10J4		-27/03/05
2.0 HDi	DW10TD		
2.0 HDi	DW10ATED		-27/03/05
2.0 HDi Sans FAP	DW10ATED		28/03/05-
2.0 HDi /FAP	DW10BTED4		

5233923
OE 352392

Articulation AR
Rear bush



2 Ø int.14 Ø ext.55 coll.62 long. tube int.49 ext.25 ep. coll.3			
1.4i	TU3JP		-27/03/05
1.4i 16v.	ET3J4		
1.4 HDi	DV4TD		-27/03/05
1.6i 16v.	TU5JP4		
1.6 HDi	DV6TED4/ ATED4		
1.6 HDi FAP 90hp 66kw	DV6TED4B		28/03/05-
2.0i 16v.	EW10A /J4S		
2.0i 16v.	EW10J4		-27/03/05
2.0 HDi	DW10TD		
2.0 HDi	DW10ATED		-27/03/05
2.0 HDi Sans FAP	DW10ATED		28/03/05-
2.0 HDi FAP	DW10BTED4		

Bras & Triangle de suspension

Control arm
Brazo y triángulo
Wahacz
Рычаг подвески

G/L  D/R

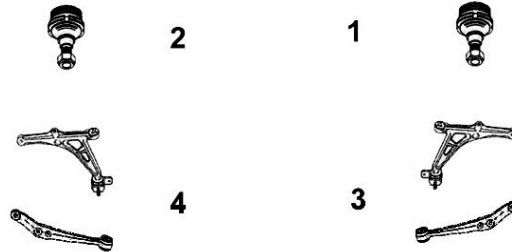

5203K83
OE 3520S2

Triangle de susp. inf. G
Lower left track control arm

4 **Sans rotule** Without ball joint

1.4i	TU3JP	-27/03/05
1.4i 16v.	ET3J4	
1.4 HDi	DV4TD	-27/03/05
1.6i 16v.	TU5JP4	
1.6 HDi	DV6ATED4	
1.6 HDi 90hp 66kw FAP	DV6TED4B	28/03/05-
1.6 HDi 110hp 81kw	DV6TED4	28/03/05-
2.0i 16v.	EW10J4/S	-27/03/05
2.0i 16v.	EW10A/J4S	28/03/05-
2.0 HDi	DW10TD	
2.0 HDi	DW10BTED4	-27/03/05
2.0 HDi FAP	DW10BTED4	28/03/05-
2.0 HDi sans FAP	DW10ATED	28/03/05-



5213G83
OE 3521P3

Triangle de susp. inf. D
Lower right track control arm

3 **Sans rotule** Without ball joint

1.4i	TU3JP	-27/03/05
1.4i 16v.	ET3J4	
1.4 HDi	DV4TD	-27/03/05
1.6i 16v.	TU5JP4	
1.6 HDi	DV6ATED4	
1.6 HDi 90hp 66kw FAP	DV6TED4B	28/03/05-
1.6 HDi 110hp 81kw	DV6TED4	28/03/05-
2.0i 16v.	EW10J4/S	-27/03/05
2.0i 16v.	EW10A/J4S	28/03/05-
2.0 HDi	DW10TD	
2.0 HDi	DW10BTED4	-27/03/05
2.0 HDi FAP	DW10BTED4	28/03/05-
2.0 HDi sans FAP	DW10ATED	28/03/05-



6403533
OE 364073

Rotule de susp. inf. G/D
L/R lower suspension ball joint

1 1.4i TU3JP -27/03/05

2 1.4i 16v. ET3J4

1.4 HDi DV4TD -27/03/05

1.6i 16v. TU5JP4

1.6 HDi DV6ATED4

1.6 HDi 110hp 81kw DV6TED4 28/03/05-

1.6 HDi 90hp 66kw FAP DV6TED4B 28/03/05-

2.0i 16v. EW10J4/S EW10A

2.0 HDi DW10TD DW10BTED4

2.0 HDi Sans FAP DW10ATED 28/03/05-



Support d'amortisseur
Suspension mounting
Soporte amortiguador
Poduszka amortyzatora
Опора амортизатора

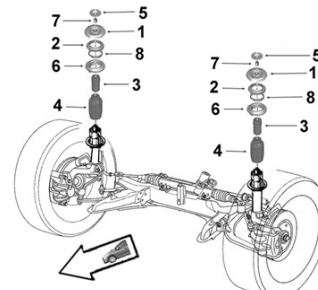

2650038
OE 503375

Coupelle rebond.
Spring cup

5

TT /all models



0385855
OE 5038G0

Support suspension G/D
L/R suspension mounting

1 1.4i TU3JP -27/03/05

1.4i 16v. ET3J4

1.4 HDi DV4TD -27/03/05

1.6i 16v. TU5JP4

1.6 HDi DV6ATED4/ATED4

1.6 HDi FAP 90hp 66kw DV6TED4B 28/03/05-

2.0i 16v. EW10A/J4S

2.0i 16v. EW10J4 -27/03/05





2.0 HDi DW10TD

2.0 HDi DW10ATED -27/03/05

2.0 HDi sans FAP DW10ATED 28/03/05-

2.0 HDi FAP DW10BTED4



... 307 ...			
0355275 Butée à billes G/D			
OE 503563 <i>L/R ball bearing</i>			
	2	1.4i	TU3JP -27/03/05
		1.4i 16v.	ET3J4
		1.4 HDi	DV4TD -27/03/05
		1.6i 16v.	TU5JP4
		1.6 HDi	DV6TED4/ATED4
		1.6 HDi FAP 90hp 66kw	DV6TED4B 28/03/05-
		2.0i 16v.	EW10A/J4S
		2.0i 16v.	EW10J4 -27/03/05
		2.0 HDi	DW10TD
		2.0 HDi	DW10ATED -27/03/05
		2.0 HDi sans FAP	DW10ATED 28/03/05-
		2.0 HDi FAP	DW10BTED4
2650035 Coupelle amortisseur G/D			
OE 503151 <i>L/R shock absorber cup</i>			
	6	1.4i	TU3JP -27/03/05
		1.4i 16v.	ET3J4
		1.4 HDi	DV4TD -27/03/05
		1.6i 16v.	TU5JP4
		1.6 HDi	DV6TED4/ ATED4
		1.6 HDi FAP	DV6TED4B 28/03/05-
		2.0i 16v.	EW10A/ J4S
		2.0i 16v.	EW10J4 -27/03/05
		2.0 HDi FAP	DW10ATED -27/03/05
		2.0 HDi	DW10ATED 28/03/05-
		2.0 HDi	DW10TD
		2.0 HDi FAP	DW10BTED4
2650001 Butée de suspension G/D			
OE 503370 <i>L/R suspension bush</i>			
	3	H96	
		1.4i	TU3JP -27/03/05
		1.4i 16v.	ET3J4
		1.4 HDi	DV4TD -27/03/05
		1.6i 16v.	TU5JP4
		1.6 HDi	DV6TED4/ ATED4
		1.6 HDi FAP 90hp 66kw	DV6TED4B 28/03/05-
		2.0i 16v.	EW10A/ J4S
		2.0i 16v.	EW10J4 -27/03/05
		2.0 HDi	DW10TD /ATED -27/03/05
		2.0 HDi sans FAP	DW10ATED4 28/03/05-
		2.0 HDi FAP	DW10BTED4
2650018 Butée de suspension G/D			
OE 503385 <i>L/R suspension bush</i>			
	3	H86	
		1.6i 16v.	TU5JP4 16/01/06-04/03/07
		2.0i 16v.	EW10A 16/01/06-04/03/07
		2.0 HDi	DW10TD 28/03/05-04/03/07
2650024 Butée de suspension G/D			
OE 5033C6 <i>L/R suspension bush</i>			
	3	H86	
		1.6i 16v.	TU5JP4 05/03/07-
		2.0i 16v.	EW10A 05/03/07-
		2.0 HDi	DW10TD 05/03/07-

... 307 ...



Support d'amortisseur
Suspension mounting
Soporte amortiguador
Poduszka amortyzatora
Опора амортизатора

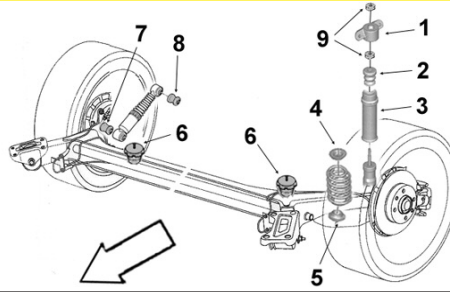

PEUGEOT

1425325
 OE 514232

Support suspension G/D
L/R suspension mounting



1	1.4i	TU3JP	-27/03/05
	1.4i 16v.	ET3J4	-03/09/06
	1.4 HDi	DV4TD	-27/03/05
	1.6i 16v.	TU5JP4	
	1.6 HDi	DV6ATED4 /TED4	-03/09/06
	1.6 HDi FAP 90hp 66kw	DV6TED4B	-03/09/06
	2.0i 16v.	EW10A	-03/09/06
	2.0i 16v. Berline 4/5ptes Susp. renforcée AV AR	EW10A	04/09/06-
	2.0i 16v.	EW10J4	-27/03/05
	2.0i 16v.	EW10J4S	-03/09/06
2.0 HDi	DW10TD/ ATED/ BTED4	-27/03/05	

2650041
 OE 525442

Protecteur amortisseur G/D
L/R shock absorber protector



2/3	1.4i	TU3JP	-27/03/05
	1.4i 16v.	ET3J4	
	1.4 HDi	DV4TD	-27/03/05
	1.6i 16v.	TU5JP4	
	1.6 HDi	DV6ATED4 /TED4	-27/03/05
	1.6 HDi	DV6ATED4	28/03/05-
	1.6 HDi 90hp 66kw FAP	DV6TED4B	28/03/05-
	1.6 HDi 110hp 80kw	DV6TED4	28/03/05-
	2.0i 16v.	EW10A EW10J4/S	-27/03/05
	2.0i 16v.	EW10A	28/03/05-
	2.0i 16v.	EW10J4S	28/03/05-
	2.0 HDi	DW10TD	
	2.0 HDi	DW10ATED	-27/03/05
2.0 HDi FAP	DW10BTED4		
2.0 HDi sans FAP	DW10ATED	28/03/05-	

Eléments TRAIN ARRIERE
Rear axle parts
Tren TRAS
Elementy zawieszenia tylnego
элементы задней оси.



2600002
 OE 5131A5

Articulation essieu
Axle bush



	Ø int. 12.5 Ø ext. 72 coll. 83 long. tube int. 82 ext. 60 ep. coll.5		
	1.4i Break	TU3JP	-27/03/05
	1.4i 16v. Break	ET3J4	-27/03/05
	1.4 HDi Break	DV4TD	-27/03/05
	1.6i 16v.	TU5JP4	16/01/06-
	1.6i 16v. Break	TU5JP4	-27/03/05
	1.6 HDi Break	DV6TED4	-27/03/05
	2.0i 16v. Break	EW10A/ J4/ S	-27/03/05
2.0 HDi Break	DW10TD	-27/03/05	
2.0 HDi Break	DW10ATED/ BTED4	-27/03/05	

... 307

2600001

Articulation traverse

OE 5131A4

Cross bar bush



Ø int. 16.8 Ø ext. 71.5 coll. 84 long. tube int. 82 ext. 60 ep. coll. 5

1.4i Berline	TU3JP	-27/03/05
1.4i 16v. Berline	ET3J4	-27/03/05
1.4i 16v.	ET3J4	28/03/05-
1.4 HDi Berline	DV4TD	-27/03/05
1.6i 16v. Berline	TU5JP4	-27/03/05
1.6i 16v.	TU5JP4	28/03/05-
1.6 HDi	DV6ATED4/TED4	
1.6 HDi FAP 90hp 66kw	DV6TED4B	28/03/05-
2.0i 16v. Berline	EW10A	-27/03/05
2.0i 16v.	EW10A	28/03/05-
2.0i 16v. Berline	EW10J4	-27/03/05
2.0i 16v.	EW10J4S	
2.0 HDi	DW10TD	
2.0 HDi Berline	DW10ATED	-27/03/05
2.0 HDi Sans FAP	DW10ATED	28/03/05-
2.0 HDi	DW10BTED4	

307 CC...

Eléments DIRECTION

Steering parts

Elementos Direcciones

Elementy uklad kierowniczy

Элементы рулевой системы

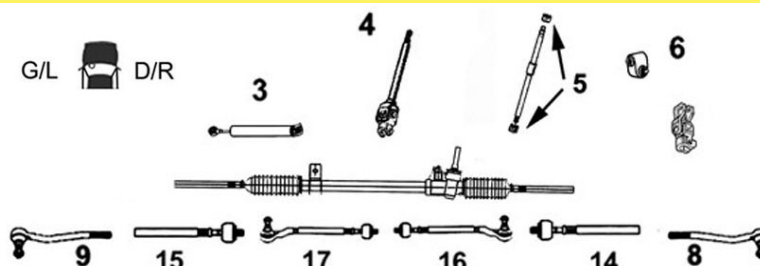

3008159

Axe de bielle G/D

Part/oe 3812E0

L/R axial joint



14 Côté dir. M14x1.5 Côté rot. M14x1.5
15 long 322 mm

1.6i 16v. TU5JP4 -30/01/05
2.0i 16v. EW10A/J4/S -30/01/05

8123E53

Axe de bielle G/D

OE 3812E5

L/R axial joint



14 Côté dir. M14x1.5 Côté rot. M14x1.5
15 long 340 mm

1.6i 16v. TU5JP4 31/01/05-
2.0i 16v. EW10A/J4S 31/01/05-
2.0 HDi FAP DW10BTED4 28/03/05-

8173313

Rotule de direction G

OE 381742

Left tie rod end



9 M14 x 1.5

1.6i 16v. TU5JP4 -30/01/05
2.0i 16v. EW10A/J4/S -30/01/05

8173303

Rotule de direction D

OE 381741

Right tie rod end



8 M14 x 1.5

1.6i 16v. TU5JP4 -30/01/05
2.0i 16v. EW10A/J4/S -30/01/05

8173183

Rotule de direction G/D

OE 381750

L/R tie rod end



8
9 M14 x 1.5

1.6i 16v. TU5JP4 31/01/05-
2.0i 16v. EW10A/J4S 31/01/05-
2.0 HDi FAP DW10BTED4 28/03/05-

... 307 CC ...

SASIC

PEUGEOT



Barre stabilisatrice
 Stabilizer bar
 Barra estabilizadora
 Drażek stabilizatora
 стабилизатор поперечной устойчивости

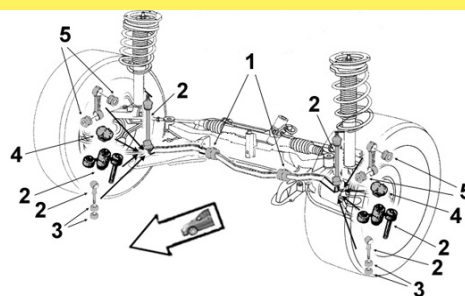

0875505

OE 508777

Biellette barre stab.

Stabilizer bar stub axle



2

1.6i 16v.	TU5JP4	
2.0i 16v.	EW10A /J4S	
2.0i 16v.	EW10J4	-27/03/05
2.0 HDi FAP	DW10BTED4	

0945885

OE 5094E0

Palier de barre milieu

Middle bar main bearing



1 Barre Ø 22

1.6i 16v.	TU5JP4	12/03-07/07/04
1.6i 16v.	TU5JP4	28/03/05-
2.0i 16v.	EW10A	28/03/05-
2.0i 16v.	EW10J4	12/03-07/07/04
2.0i 16v.	EW10J4	10/01/05-
2.0 HDi FAP	DW10BTED4	28/03/05-

0945895

OE 5094E3

Palier de barre milieu

Middle bar main bearing



1 Barre Ø 23

1.6i 16v.	TU5JP4	28/03/05-
2.0i 16v.	EW10A /J4	28/03/05-
2.0i 16v.	EW10J4S	07/03-
2.0 HDi FAP	DW10BTED4	28/03/05-



Eléments SUSPENSION

Suspension parts
Elementos suspensión
Elementy zawieszenie
Элементы подвески

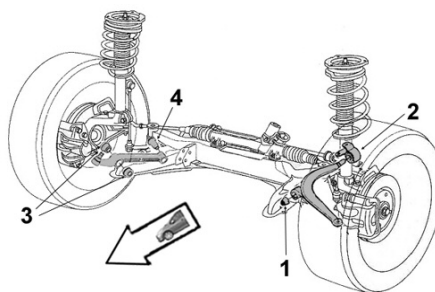

5233913

OE 352391

Articulation AV

Front bush



1 Ø int.14 Ø ext.55 long. tube int.56 ext.32

1.6i 16v.	TU5JP4
2.0i 16v.	EW10A
2.0i 16v.	EW10J4
2.0 HDi FAP	DW10BTED4

5233923

OE 352392

Articulation AR

Rear bush



2 Ø int.14 Ø ext.55 coll.62 long. tube int.49 ext.25 ep. coll.3

1.6i 16v.	TU5JP4
2.0i 16v.	EW10A
2.0i 16v.	EW10J4
2.0 HDi FAP	DW10BTED4

... 307 CC ...

Bras & Triangle de suspension

Control arm
Brazo y triángulo
Wahacz
Рычаг подвески

G/L  D/R

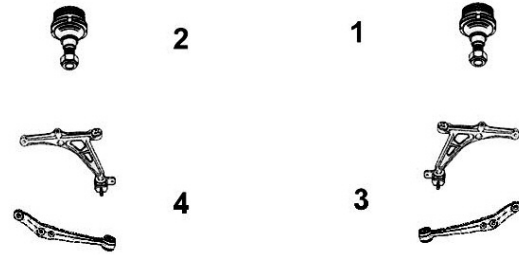

5203K83
OE 3520T0

Triangle de susp. inf. G
Lower left track control arm

4 Sans rotule Without ball joint



1.6i 16v. TU5JP4
2.0i 16v. EW10A/J4/S
2.0 HDi FAP DW10BTED4

5213G83
OE 3521Q1

Triangle de susp. inf. D
Lower right track control arm

3 Sans rotule Without ball joint



1.6i 16v. TU5JP4
2.0i 16v. EW10A/J4/S
2.0 HDi FAP DW10BTED4

6403533
OE 364073

Rotule de susp. inf. G/D
L/R lower suspension ball joint

1
2



1.6i 16v. TU5JP4
2.0i 16v. EW10A/J4/S
2.0 HDi FAP DW10BTED4



Support d'amortisseur

Suspension mounting
Soporte amortiguador
Poduszka amortyzatora
Опора амортизатора

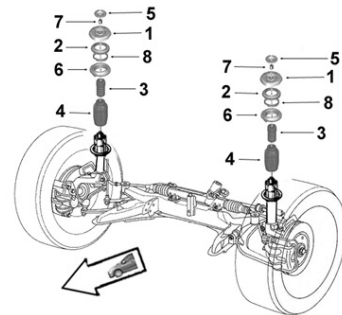

2650038
OE 503375

Coupelle rebond.
Spring cup

5



TT /all models

0385855
OE 5038G0

Support suspension G/D
L/R suspension mounting

1



1.6i 16v. TU5JP4
2.0i 16v. EW10A
2.0i 16v. EW10J4 -27/03/05
2.0i 16v. EW10J4S
2.0 HDi FAP DW10BTED4

0355275
OE 503563

Butée à billes G/D
L/R ball bearing

2



1.6i 16v. TU5JP4
2.0i 16v. EW10A
2.0i 16v. EW10J4 -27/03/05
2.0i 16v. EW10J4S
2.0 HDi FAP DW10BTED4

2650035
OE 503151

Coupelle amortisseur G/D
L/R shock absorber cup

6



1.6i 16v. TU5JP4
2.0i 16v. EW10
2.0 HDi DW10BTED4

... 307 CC ...

SASIC

PEUGEOT



Support d'amortisseur
Suspension mounting
Soporte amortiguador
Poduszka amortyzatora
Опора амортизатора

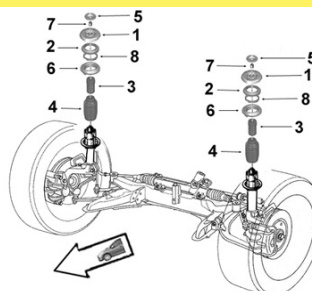

2650018
OE 503385

Butée de suspension G/D
L/R suspension bush



3 H86
 1.6i 16v. TU5JP4 -27/03/05
 1.6i 16v. TU5JP4 16/01/06-04/03/07
 2.0i 16v. EW10 -27/03/05
 2.0i 16v. EW10A 16/01/06-04/03/07
 2.0 HDi DW10BTED4 -27/03/05

2650001
OE 503370

Butée de suspension G/D
L/R suspension bush



3 H96
 1.6i 16v. TU5JP4 28/03/05-
 2.0i 16v. EW10A/J4S 28/03/05-
 2.0 HDi FAP DW10BTED4 28/03/05-

2650024
OE 5033C6

Butée de suspension G/D
L/R suspension bush



3 H86
 1.6i 16v. TU5JP4 05/03/07-
 2.0i 16v. EW10A 05/03/07-



Support d'amortisseur
Suspension mounting
Soporte amortiguador
Poduszka amortyzatora
Опора амортизатора

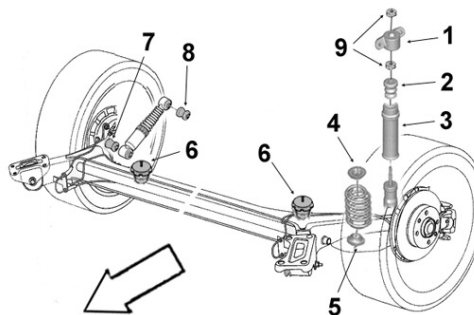

1425325
OE 514232

Support suspension G/D
L/R suspension mounting



1
 1.6i 16v. TU5JP4
 2.0i 16v. Susp. normale EW10A 03/03-
 2.0i 16v. EW10J4 /S 03/03-
 2.0 HDi FAP DW10BTED4 -03/09/06

2650041
OE 525442

Protecteur amortisseur G/D
L/R shock absorber protector



2/3
 1.6i 16v. TU5JP4
 2.0i 16v. EW10
 2.0 HDi FAP DW10BTED4

... 307 CC

Eléments TRAIN ARRIERE

Rear axle parts

Tren TRAS



Elementy zawieszenia tylnego

элементы задней оси.



PEUGEOT



2600002 OE 5131A5	Articulation essieu <i>Axle bush</i>	2600001 OE 5131A4	Articulation traverse <i>Cross bar bush</i>
	<p>Ø int. 12.5 Ø ext. 72 coll. 83 long. tube int. 82 ext. 60 ep. coll.5</p> <p>1.6i 16v. TU5JP4 -27/03/05 2.0i 16v. EW10A/J4/S -27/03/05 2.0 HDi FAP DW10BTED4 -27/03/05</p>		<p>Ø int. 16.8 Ø ext. 71.5 coll. 84 long. tube int. 82 ext. 60 ep. coll.5</p> <p>1.6i 16v. TU5JP4 28/03/05- 2.0i 16v. EW10A/J4 28/03/05- 2.0 HDi FAP DW10BTED4 28/03/05-</p>

308 -09/13 ...

Eléments DIRECTION

Steering parts

Elementos Direcciones

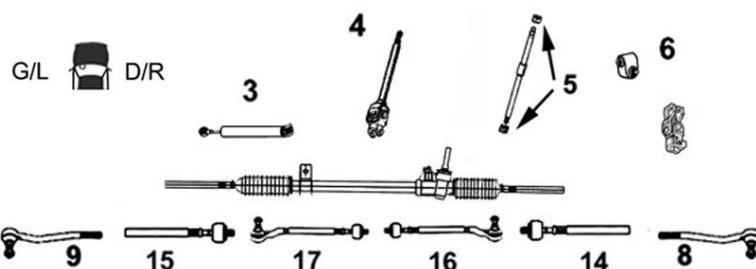

Elementy uklad kierowniczy

Элементы рулевой системы



7770002 OE 3812F2	Axe de bielle G/D <i>L/R axial joint</i>																									
	<p>14 Côté dir. M14x1.5 Côté rot. M14x1.5 long 278 mm 15</p> <table border="0"> <tr> <td>1.4 VTi</td> <td>EP3/C</td> <td>1.6 HDi</td> <td>DV6ATED4/TED4</td> </tr> <tr> <td>1.6i 16v.</td> <td>EP6/C/M</td> <td>1.6 HDi</td> <td>DV6C/M DV6DTED/M</td> </tr> <tr> <td>1.6i 16v.</td> <td>TU5JP4</td> <td>1.6 HDi FAP 90hp 66kw</td> <td>DV6TED4B</td> </tr> <tr> <td>1.6i 16v. THP</td> <td>EP6CDT/M/MD</td> <td>2.0i 16v.</td> <td>EW10A</td> </tr> <tr> <td>1.6i 16v. THP</td> <td>EP6DT/S</td> <td>2.0 HDi FAP</td> <td>DW10CB DTR DW10BTED4</td> </tr> <tr> <td></td> <td></td> <td>2.0 HDi FAP</td> <td>DW10CTED4/ DTR</td> </tr> </table>		1.4 VTi	EP3/C	1.6 HDi	DV6ATED4/TED4	1.6i 16v.	EP6/C/M	1.6 HDi	DV6C/M DV6DTED/M	1.6i 16v.	TU5JP4	1.6 HDi FAP 90hp 66kw	DV6TED4B	1.6i 16v. THP	EP6CDT/M/MD	2.0i 16v.	EW10A	1.6i 16v. THP	EP6DT/S	2.0 HDi FAP	DW10CB DTR DW10BTED4			2.0 HDi FAP	DW10CTED4/ DTR
1.4 VTi	EP3/C	1.6 HDi	DV6ATED4/TED4																							
1.6i 16v.	EP6/C/M	1.6 HDi	DV6C/M DV6DTED/M																							
1.6i 16v.	TU5JP4	1.6 HDi FAP 90hp 66kw	DV6TED4B																							
1.6i 16v. THP	EP6CDT/M/MD	2.0i 16v.	EW10A																							
1.6i 16v. THP	EP6DT/S	2.0 HDi FAP	DW10CB DTR DW10BTED4																							
		2.0 HDi FAP	DW10CTED4/ DTR																							

7770007 OE 3812F8	Axe de bielle G/D <i>L/R axial joint</i>	
	<p>14 Côté dir. M14x1.5 Côté rot. M14x1.5 long 365mm 15</p> <p>1.6i 16v. THP EP6CDTX 02/11/09-</p>	

7670017 OE 381789	Rotule de direction G <i>Left tie rod end</i>	7670016 OE 381788	Rotule de direction D <i>Right tie rod end</i>																																												
	<p>9 M14 x 1.5</p> <table border="0"> <tr> <td>1.4 VTi</td> <td>EP3/C</td> </tr> <tr> <td>1.6i 16v.</td> <td>EP6/C/M TU5JP4</td> </tr> <tr> <td>1.6i 16v. THP</td> <td>EP6CDT/M/MD</td> </tr> <tr> <td>1.6i 16v. THP</td> <td>EP6DT/S</td> </tr> <tr> <td>1.6 HDi</td> <td>DV6ATED4 DV6C/M</td> </tr> <tr> <td>1.6 HDi</td> <td>DV6DTED/M DV6TED4</td> </tr> <tr> <td>1.6 HDi FAP 90hp 66kw</td> <td>DV6TED4B</td> </tr> <tr> <td>2.0i 16v.</td> <td>EW10A</td> </tr> <tr> <td>2.0 HDi FAP</td> <td>DW10BTED4</td> </tr> <tr> <td>2.0 HDi FAP</td> <td>DW10CTED4/ DTR</td> </tr> <tr> <td>2.0 HDi FAP</td> <td>DW10CB DTR</td> </tr> </table>	1.4 VTi	EP3/C	1.6i 16v.	EP6/C/M TU5JP4	1.6i 16v. THP	EP6CDT/M/MD	1.6i 16v. THP	EP6DT/S	1.6 HDi	DV6ATED4 DV6C/M	1.6 HDi	DV6DTED/M DV6TED4	1.6 HDi FAP 90hp 66kw	DV6TED4B	2.0i 16v.	EW10A	2.0 HDi FAP	DW10BTED4	2.0 HDi FAP	DW10CTED4/ DTR	2.0 HDi FAP	DW10CB DTR		<p>8 M14 x 1.5</p> <table border="0"> <tr> <td>1.4 VTi</td> <td>EP3/C</td> </tr> <tr> <td>1.6i 16v.</td> <td>EP6/C/M TU5JP4</td> </tr> <tr> <td>1.6i 16v. THP</td> <td>EP6CDT/M/MD</td> </tr> <tr> <td>1.6i 16v. THP</td> <td>EP6DT/S</td> </tr> <tr> <td>1.6 HDi</td> <td>DV6ATED4 DV6C/M</td> </tr> <tr> <td>1.6 HDi</td> <td>DV6DTED/M DV6TED4</td> </tr> <tr> <td>1.6 HDi FAP 90hp 66kw</td> <td>DV6TED4B</td> </tr> <tr> <td>2.0i 16v.</td> <td>EW10A</td> </tr> <tr> <td>2.0 HDi FAP</td> <td>DW10BTED4</td> </tr> <tr> <td>2.0 HDi FAP</td> <td>DW10CTED4/ DTR</td> </tr> <tr> <td>2.0 HDi FAP</td> <td>DW10CB DTR</td> </tr> </table>	1.4 VTi	EP3/C	1.6i 16v.	EP6/C/M TU5JP4	1.6i 16v. THP	EP6CDT/M/MD	1.6i 16v. THP	EP6DT/S	1.6 HDi	DV6ATED4 DV6C/M	1.6 HDi	DV6DTED/M DV6TED4	1.6 HDi FAP 90hp 66kw	DV6TED4B	2.0i 16v.	EW10A	2.0 HDi FAP	DW10BTED4	2.0 HDi FAP	DW10CTED4/ DTR	2.0 HDi FAP	DW10CB DTR
1.4 VTi	EP3/C																																														
1.6i 16v.	EP6/C/M TU5JP4																																														
1.6i 16v. THP	EP6CDT/M/MD																																														
1.6i 16v. THP	EP6DT/S																																														
1.6 HDi	DV6ATED4 DV6C/M																																														
1.6 HDi	DV6DTED/M DV6TED4																																														
1.6 HDi FAP 90hp 66kw	DV6TED4B																																														
2.0i 16v.	EW10A																																														
2.0 HDi FAP	DW10BTED4																																														
2.0 HDi FAP	DW10CTED4/ DTR																																														
2.0 HDi FAP	DW10CB DTR																																														
1.4 VTi	EP3/C																																														
1.6i 16v.	EP6/C/M TU5JP4																																														
1.6i 16v. THP	EP6CDT/M/MD																																														
1.6i 16v. THP	EP6DT/S																																														
1.6 HDi	DV6ATED4 DV6C/M																																														
1.6 HDi	DV6DTED/M DV6TED4																																														
1.6 HDi FAP 90hp 66kw	DV6TED4B																																														
2.0i 16v.	EW10A																																														
2.0 HDi FAP	DW10BTED4																																														
2.0 HDi FAP	DW10CTED4/ DTR																																														
2.0 HDi FAP	DW10CB DTR																																														



Barre stabilisatrice
 Stabilizer bar
 Barra estabilizadora
 Drażek stabilizatora
 стабилизатор поперечной устойчивости

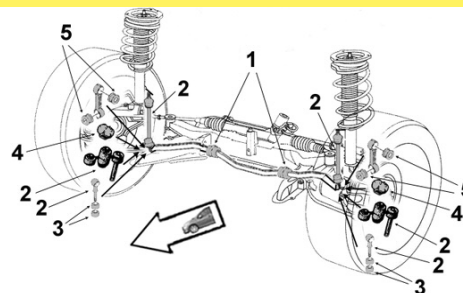

2300019

OE 508764

Biellette barre stab.

Stabilizer bar stub axle



2

1.4 VTi	EP3/C	
1.6i 16v.	EP6/C/CDT	TU5JP4
1.6i 16v. THP	EP6CDTX/DTS	
1.6i THP 16v.	EP6DT	
1.6 HDi	DV6ATED4/ TED4	
1.6 HDi	DV6C	DV6DTED
1.6 HDi FAP 90hp 66kw	DV6TED4B	
2.0i 16v.	EW10A	
2.0 HDi FAP	DW10BTED4/ CTED4	

0945875

OE 509487

Palier de barre milieu

Middle bar main bearing



1

Barre Ø 21		
1.4 VTi	EP3/C	
1.6i 16v.	EP6/C/CDT	TU5JP4
1.6i 16v. THP	EP6CDTX/ DTS	
1.6i THP 16v.	EP6DT	
1.6 HDi	DV6ATED4/ TED4	
1.6 HDi	DV6C	DV6DTED
1.6 HDi FAP 90hp 66kw	DV6TED4B	
2.0i 16v.	EW10A	
2.0 HDi FAP	DW10BTED4/ CTED4	

0945885

OE 5094E0

Palier de barre milieu

Middle bar main bearing



1

Barre Ø 22		
1.4 VTi	EP3/C	
1.6i 16v.	EP6/C/CDT	TU5JP4
1.6i 16v. THP	EP6CDTX /DTS	
1.6i THP 16v.	EP6DT	
1.6 HDi	DV6ATED4/ TED4	DV6C DV6DTED
1.6 HDi FAP 90hp 66kw	DV6TED4B	
2.0i 16v.	EW10A	
2.0 HDi FAP	DW10BTED4/ CTED4	

2300027

OE 5094E2

Palier de barre milieu

Middle bar main bearing



1

Barre Ø 22.5		
1.4 VTi	EP3/C	
1.6i 16v.	EP6/C	TU5JP4
1.6i 16v. /Turbo	EP6CDT	
1.6i 16v. THP	EP6CDTX/ DTS	
1.6i THP 16v.	EP6DT	
1.6 HDi	DV6ATED4/ TED4	DV6C DV6DTED
1.6 HDi FAP 90hp 66kw	DV6TED4B	
2.0i 16v.	EW10A	
2.0 HDi FAP	DW10BTED4 /CTED4	

0945895

OE 5094E3

Palier de barre milieu

Middle bar main bearing



1

Barre Ø 23		
1.4 VTi	EP3/C	
1.6i 16v.	EP6/C/CDT	TU5JP4
1.6i 16v. THP	EP6CDTX /DTS	
1.6i THP 16v.	EP6DT	
1.6 HDi	DV6ATED4 /TED4	DV6C DV6DTED
1.6 HDi FAP 90hp 66kw	DV6TED4B	
2.0i 16v.	EW10A	
2.0 HDi FAP	DW10BTED4 /CTED4	



Eléments SUSPENSION
Suspension parts
Elementos suspensión
Elementy zawieszenie
Элементы подвески

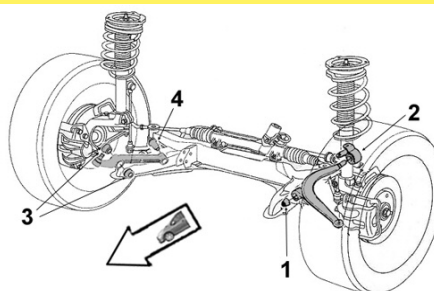

5233913

OE 352391

Articulation AV

Front bush



1	Ø int.14 Ø ext.55 long. tube int.56 ext.32		
	1.4 VTi	EP3/C	
	1.6i 16v.	EP6/C /CDT	TU5JP4
	1.6i 16v. THP	EP6CDTX/ DTS	
	1.6i THP 16v.	EP6DT	
	1.6 HDi	DV6ATED4/ TED4	DV6C DV6DTED
	1.6 HDi FAP 90hp 66kw	DV6TED4B	
	2.0i 16v.	EW10A	
	2.0 HDi FAP	DW10BTED4 /CTED4	

5233923

OE 352392

Articulation AR

Rear bush



2	Ø int.14 Ø ext.55 coll.62 long. tube int.49 ext.25 ep. coll.3		
	1.4 VTi	EP3/C	
	1.6i 16v.	EP6/ C/ CDT	TU5JP4
	1.6i 16v. THP	EP6CDTX/ DTS	
	1.6i THP 16v.	EP6DT	
	1.6 HDi	DV6ATED4/TED4	DV6C DV6DTED
	1.6 HDi FAP 90hp 66kw	DV6TED4B	
	2.0i 16v.	EW10A	
	2.0 HDi FAP	DW10BTED4 /CTED4	

Bras & Triangle de suspension

Control arm
Brazo y triángulo
Wahacz
Рычаг подвески

G/L D/R

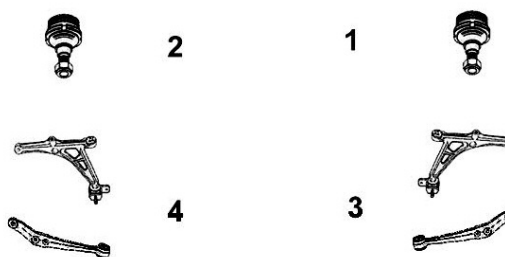

7470003

OE 3520V2

Triangle de susp. inf. G

Lower left track control arm



4	Sans rotule Without tie rod end	
	1.4 VTi	EP3/C
	1.6i 16v. THP	EP6CDT M/MD
	1.6i 16v.	EP6/C/M
	1.6i 16v.	TU5JP4
	1.6i 16v. THP	EP6CDT /X
	1.6i 16v. THP	EP6DT/S
	1.6 HDi	DV6ATED4
	1.6 HDi	DV6C/M
	1.6 HDi	DV6DTED/M
	1.6 HDi	DV6TED4
	1.6 HDi FAP 90hp 66kw	DV6TED4B
	2.0i 16v.	EW10A
	2.0 HDi FAP	DW10CB DTR
	2.0 HDi FAP	DW10BTED4
	2.0 HDi FAP	DW10CTED4/ DTR

7470004

OE 3521R3

Triangle de susp. inf. D

Lower right track control arm



3	Sans rotule Without tie rod end	
	1.4 VTi	EP3/C
	1.6i 16v. THP	EP6CDT M/MD
	1.6i 16v.	EP6/C/M
	1.6i 16v.	TU5JP4
	1.6i 16v. THP	EP6CDT /X
	1.6i 16v. THP	EP6DT/S
	1.6 HDi	DV6ATED4
	1.6 HDi	DV6C/M
	1.6 HDi	DV6DTED/M
	1.6 HDi	DV6TED4
	1.6 HDi FAP 90hp 66kw	DV6TED4B
	2.0i 16v.	EW10A
	2.0 HDi FAP	DW10CB DTR
	2.0 HDi FAP	DW10BTED4
	2.0 HDi FAP	DW10CTED4/ DTR

Bras & Triangle de suspension

Control arm
Brazo y triángulo
Wahacz
Рычаг подвески

G/L  D/R

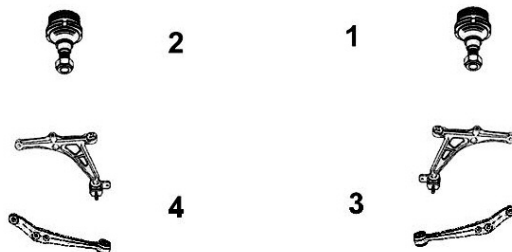

6403533

OE 364060

Rotule de susp. inf. G/D

L/R lower suspension ball joint



1	1.4 VTi	EP3/C		
2	1.6i 16v. THP	EP6CDT/X	EP6CDT M/MD	
	1.6i 16v.	EP6/C/M	TU5JP4	
	1.6i 16v. THP	EP6DT/S		
	1.6 HDi	DV6ATED4	DV6C/M	DV6DTED/M
	1.6 HDi FAP 90hp 66kw	DV6TED4B		DV6TED4
	2.0i 16v.	EW10A		
	2.0 HDi FAP	DW10CB DTR	DW10BTED4	
	2.0 HDi FAP	DW10CTED4/ DTR		



Support d'amortisseur

Suspension mounting
Soporte amortiguador
Poduszka amortyzatora
Опора амортизатора

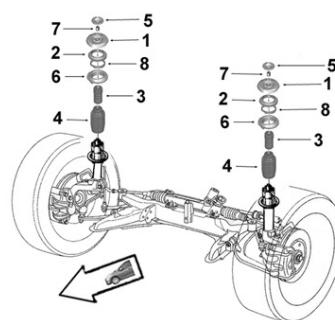

2650037

OE 5038G4

Support suspension G/D

L/R suspension mounting



1	1.4 VTi	EP3/C			
	1.6i 16v.	EP6/C/M	TU5JP4		
	1.6i 16v. THP	EP6CDT/ M/D	EP6CDTX	EP6DT/S	
	1.6 HDi	DV6ATED4	DV6C/M	DV6DTED/ M	DV6TED4
	1.6 HDi FAP 90hp 66kw	DV6TED4B			
	2.0i 16v.	EW10A			
	2.0 HDi FAP	DW10BTED4			
	2.0 HDi FAP /DTR	DW10CTED4			
	2.0 HDi FAP DTR	DW10CB			

0355275

OE 503563

Butée à billes G/D

L/R ball bearing



2	1.4 VTi	EP3/C			
	1.6i 16v.	EP6/C/M	TU5JP4		
	1.6i 16v. THP	EP6DT/S	EP6CDT/ M /MD / X		
	1.6 HDi	DV6ATED4	DV6TED4	DV6C/ M	DV6DTED /M
	1.6 HDi FAP 90hp 66kw	DV6TED4B			
	2.0i 16v.	EW10A			
	2.0 HDi FAP	DW10BTED4 /CTED4			

2650035

OE 503151

Coupelle amortisseur G/D

L/R shock absorber cup



6	1.4 VTi	EP3/C			
	1.6i 16v.	EP6C/ M	TU5JP4		
	1.6i 16v. THP	EP6CDT/ M / MD	EP6CDTX	EP6DT/S	
	1.6 HDi	DV6ATED4	DV6C/M	DV6DTED /M	DV6TED4
	1.6 HDi FAP	DV6TED4B			
	2.0i 16v.	EW10A			
	2.0 HDi FAP	DW10BTED4	DW10CB DTR	DW10CTED4 / DTR	

2650001

Butée de suspension G/D

OE 503370

L/R suspension bush



3

H96

1.4 VTi	EP3	1.6 HDi /CC	DV6C
1.6i 16v.	EP6 TU5JP4	1.6 HDi 90hp 66kw FAP /SW	DV6TED4B/DTED
1.6i 16v. THP Sauf CC	EP6DT/S	2.0i 16v. Sauf CC	EW10A
1.6i 16v. /SW /CC	EP6C	2.0 HDi FAP Sauf CC	DW10BTED4
1.6 HDi	DV6ATED4	2.0 HDi FAP/ SW Sauf CC	DW10CTED4
1.6 HDi	DV6TED4		



Support d'amortisseur

Suspension mounting

Soporte amortiguador

Poduszka amortyzatora

Опора амортизатора

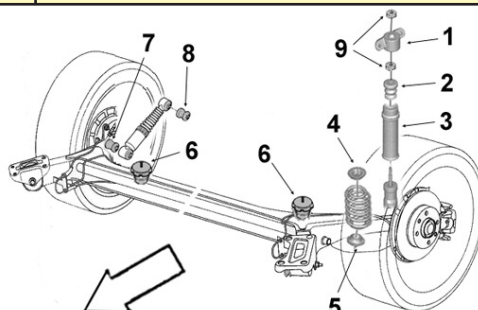

2650041

Protecteur amortisseur G/D

OE 525442

L/R shock absorber protector



2

3

1.4 VTi	EP3/C		
1.6i 16v.	TU5JP4		
1.6i 16v.	EP6/C/ M	EP6CDT/ M/ MD	
1.6i 16v. THP	EP6CDTX/ DTS		
1.6i THP 16v.	EP6DT		
1.6 HDi	DV6ATED4	DV6C/ M	DV6DTED/ M DV6TED4
1.6 HDi FAP 90hp 66kw	DV6TED4B		
2.0i 16v.	EW10A		
2.0 HDi FAP	DW10BTED4	DW10CTED4/ DTR	DW10CB DTR

Eléments TRAIN ARRIERE

Rear axle parts

Tren TRAS

Elementy zawieszenia tylnego

элементы задней оси.



2600011

Articulation essieu

OE 5131G4

Axle bush



Ø ext.72 coll.81 long. tube int.83 ext.60 ep. coll.8.4

Berline

1.4 VTi EP3/C	EP6/C/M	TU5JP4	
1.6i 16v.	EP6CDT/ MD/ X	EP6DT/S	EP6CDT M
1.6i 16v. THP	DV6ATED4	DV6C/M	DV6DTED/ M DV6TED4
1.6 HDi	DV6TED4B		
1.6 HDi FAP 90hp 66kw	EW10A		
2.0i 16v.	DW10CTED4		
2.0 HDi FAP /DTR	DW10BTED4		
2.0 HDi FAP			

2600008

Articulation essieu

OE 5131H7

Axle bush



Ø int.12 Ø ext.72 coll.82 long. tube int. 83 ext. 59 ep. coll.8

1.4 VTi Break	EP3/C		
1.6i 16v. Break	EP6 TU5JP4		
1.6i 16v. CC /Break	EP6C		
1.6i 16v. Break	EP6C M		
1.6i 16v. THP	EP6CDT		
1.6i 16v. THP Sauf berline 5 ptes	EP6CDT M		
1.6i 16v. THP CC /Break	EP6CDT MD		
1.6i 16v. THP CC	EP6CDTX		
1.6i 16v. THP Break	EP6DT/S		
1.6 HDi Break	DV6ATED4	DV6C/ M	DV6DTED M DV6TED4
1.6 HDi CC /Break	DV6DTED		
1.6 HDi FAP 90hp 66kw Break	DV6TED4B		
2.0i 16v. Break	EW10A		
2.0 HDi FAP Break	DW10BTED4		
2.0 HDi FAP DTR	DW10CB		
2.0 HDi FAP /DTR Break	DW10CTED4		

308 09/13-

Eléments DIRECTION

Steering parts

Elementos Direcciones

Elementy układ kierowniczy

Элементы рулевой системы

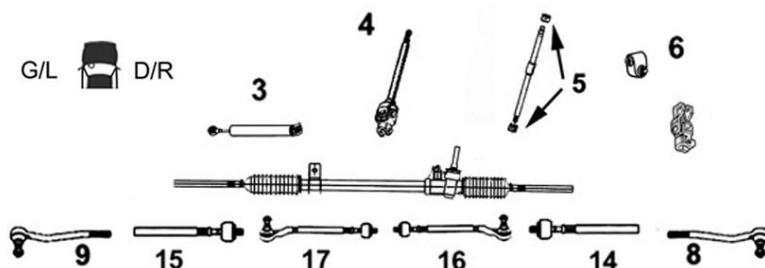

7670019

Rotule de direction G

OE 1610817780

Left tie rod end

NEW



9

M14 x 1.5

1.2 VTi
1.6i
1.6i 16v. THP
1.6 HDi
1.6 HDi

EB2
EC5
EP6CDT
DV6C
DV6DTED

7670021

Rotule de direction D

OE 1610817880

Right tie rod end

NEW



8

M14 x 1.5

1.2 VTi
1.6i
1.6i 16v. THP
1.6 HDi
1.6 HDi

EB2
EC5
EP6CDT
DV6C
DV6DTED

309 ...

Eléments DIRECTION

Steering parts

Elementos Direcciones

Elementy układ kierowniczy

Элементы рулевой системы

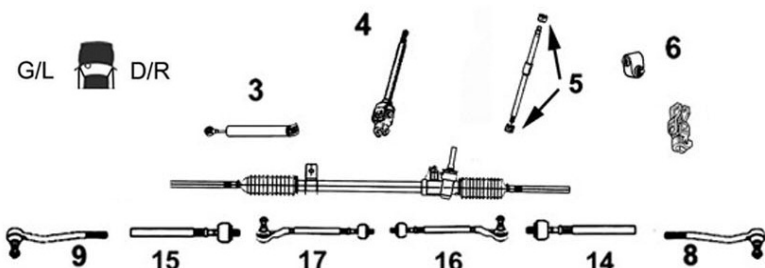

0114444

Vérin dir. assistée

OE 401144

Power steering jack



3

TT /all models Essence
sauf GTi -06/89
Sauf 1.9 16v. GTi mot. XU9J4 07/89-

TT /all models GTi
Sauf 1.9 16v. GTi mot. XU9J4

TT /all models Diesel & TD

8123973

Axe de bielle G/D

OE 381297

L/R axial joint



14

15

Côté dir. M12x1.0 Côté rot. M14x1.5
long 320 mm

TT /all models Essence Diesel & TD

8173183

Rotule de direction G/D

OE 381750

L/R tie rod end



8

9

M14 x 1.5

TT /all models Essence Diesel & TD

1034E94

Axe de volant

OE 4103E9

Steering wheel shaft



4

DNA Pignon cannelé Cannelures
haut axe de volant L 40mm

-ch 2349502

TT /all models

Essence sauf GTi -06/89
Diesel sauf TD

1034964

Axe de volant

OE 410396

Steering wheel shaft



4

DNA Pignon cannelé
Cannelures haut axe de volant L 60mm

Ch- 2349503

TT /all models

Essence sauf GTi -09/89
Diesel sauf TD -09/89

1034A84

Axe de volant

OE 4103A8

Steering wheel shaft











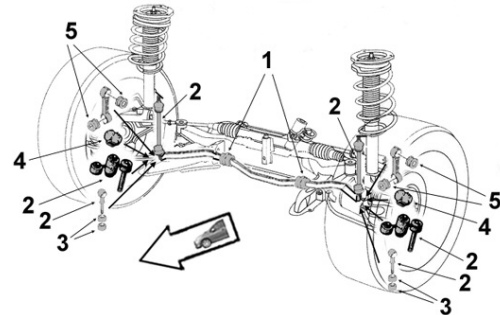

4

DNA Pignon avec plats
Cannelures haut axe de volant L 60mm

TT /all models

Essence GTi Diesel & TD 09/89-

<p>1034944 OE 410394</p> <p>Axe de volant <i>Steering wheel shaft</i></p>	
	<p>4</p> <p>TT /all models DA Ch- 2344936 07/89-</p>
 <p>Barre stabilisatrice <i>Stabilizer bar</i> <i>Barra estabilizadora</i> <i>Drażek stabilizatora</i> стабилизатор поперечной устойчивости</p>	
<p>0875325 OE 508732</p> 	<p>Biellette barre stab. <i>Stabilizer bar stub axle</i></p> <p>2 Ø 10</p> <p>TT /all models i/GTi Rallye TD</p>
<p>0945365 OE 509436</p> 	<p>Palier de barre milieu <i>Middle bar main bearing</i></p> <p>1 Barre Ø 20 blanc</p> <p>TT /all models E1 G1 G2 Y2 J2 TU</p> <p>TT /all models Sauf TD /GTi XU XUD</p>
<p>0945375 OE 509437</p> 	<p>Palier de barre milieu <i>Middle bar main bearing</i></p> <p>1 Barre Ø 22 vert</p> <p>TT /all models E1 G1 G2 Y2 J2 TU</p> <p>TT /all models Sauf TD /GTi XU XUD</p>
<p>0945405 OE 509440</p> 	<p>Palier de barre milieu <i>Middle bar main bearing</i></p> <p>1 Barre Ø 23 bleu foncé</p> <p>TT /all models E1 G1 G2 Y2 J2 TU</p> <p>TT /all models Sauf TD /GTi XU XUD</p>
<p>0945425 OE 509442</p> 	<p>Palier de barre G <i>Left bar main bearing</i></p> <p>1 Barre Ø 17 orange</p> <p>TT /all models i/GTi Rallye TD</p>
<p>0945435 OE 509443</p> 	<p>Palier de barre D <i>Right bar main bearing</i></p> <p>1 Barre Ø 17 bleu clair</p> <p>TT /all models i/GTi Rallye TD</p>
<p>1005079 OE -</p> 	<p>Kit rép. barre stab. G et D <i>L R Stabilizing bar repair kit</i></p> <p>Barre Ø 17 Bar Ø17</p> <p>TT /all models Essence 07/89-</p> <p>TT /all models GTi & TD</p>



Eléments SUSPENSION
Suspension parts
Elementos suspensión
Elementy zawieszenie
Элементы подвески

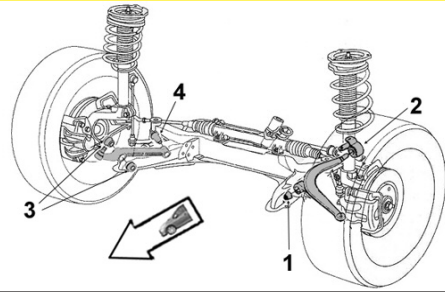

5233313
OE 352331

Articulation AV
Front bush



1 Ø int.10 Ø ext.28 long. tube int.34 ext.25

TT /all models XU XUD GTi Rallye TD

5233233
OE 352323

Articulation AR
Rear bush



2 Ø int.12 Ø ext.31 coll.42 long. tube int.38 ext.26.5 ep. coll.6.5

TT /all models GTi Rallye TD

5233583
OE 352358

Articulation ext.
Outer bush



3 Ø int.12 Ø ext.36 coll.51.5 long. tube int.25.5 ext.23 ep. coll.8

TT /all models TU
 TT /all models Sauf TD /GTi Pour bras XU XUD

5233233
OE 352323

Articulation ext.
Outer bush



3 Ø int.12 Ø ext.31 coll.42 long. tube int.38 ext.26.5 ep. coll.6.5

TT /all models E1 G1/2 Y2 J2

5233313
OE 352331

Articulation int.
Inner bush



4 Ø int.10 Ø ext.28 long. tube int.34 ext.25

TT /all models E1 G1 G2 XU XUD Y2 J2 TU

Bras & Triangle de suspension

Control arm
Brazo y triángulo
Wahacz
Рычаг подвески

G/L D/R



5203573
OE 352060

Bras de suspension G
Left track control arm



4 Avec rotule *With ball joint*

TT /all models Essence sauf GTi -06/89

TT /all models Diesel sauf TD

5213383
OE 352141









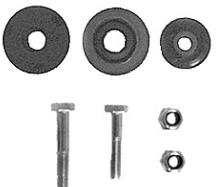

Bras de suspension D
Right track control arm

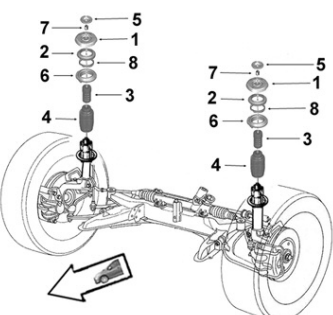

3 Avec rotule *With ball joint*

TT /all models Essence sauf GTi -06/89

TT /all models Diesel sauf TD

<p>1003565 OE -</p> 	<p>Kit rép. bras susp. G ou D <i>L or R track control arm bearing repair kit</i></p> <p>TT /all models Essence -06/89 sauf GTi</p> <p>TT /all models Diesel sauf TD</p>	<p>105A546S OE -</p> 	<p>Kit rép. train AV <i>Front axle repair kit</i></p> <p>Sans visserie <i>Without screws and bolts</i> Barre Ø 17</p> <p>TT /all models Essence 07/89- sauf GTi barre Ø21</p> <p>TT /all models GTi barre Ø21 TT /all models TD</p>
<p>105A565S OE -</p> 	<p>Kit rép. train AV <i>Front axle repair kit</i></p> <p>Sans visserie <i>Without screws and bolts</i> Barre Ø 20</p> <p>TT /all models Essence -06/89 sauf GTi</p> <p>TT /all models Diesel sauf TD</p>	<p>106A565S OE -</p> 	<p>Kit rép. train AV <i>Front axle repair kit</i></p> <p>Sans visserie <i>Without screws and bolts</i> Barre Ø 22</p> <p>TT /all models Essence -06/89 sauf GTi</p> <p>TT /all models Diesel sauf TD</p>
<p>107A565S OE -</p> 	<p>Kit rép. train AV <i>Front axle repair kit</i></p> <p>Sans visserie <i>Without screws and bolts</i> Barre Ø 23</p> <p>TT /all models Essence -06/89 sauf GTi</p> <p>TT /all models Diesel sauf TD</p>	<p>1003546 OE -</p> 	<p>Kit rép. triangle susp. G ou D <i>L or R track control arm bearing repair kit</i></p> <p>Avec visserie <i>With screws and bolts</i></p> <p>TT /all models Essence 07/89- TT /all models GTi & TD</p>
<div style="display: flex; justify-content: space-between;"> <div style="width: 45%;">  <p>Support d'amortisseur <i>Suspension mounting</i> <i>Soporte amortiguador</i> <i>Poduszka amortyzatora</i> <i>Опора амортизатора</i></p> </div> <div style="width: 45%;">  </div> </div>			
<p>8003208 OE 503733</p> 	<p>1</p> <p>Tampon suspension G/D <i>L/R susp. rebound stop</i></p> <p>TT /all models</p> <p>E1 G1 G2 XU XUD Y2 J2 TU GTi Rallye TD</p>	<p>0355275 OE 503563</p> 	<p>2</p> <p>Butée à billes G/D <i>L/R ball bearing</i></p> <p>TT /all models</p> <p>E1 G1 G2 XU XUD Y2 J2 TU GTi Rallye TD</p>
<p>0335235 OE 503323</p> 	<p>3</p> <p>Butée de suspension G/D <i>L/R suspension bush</i></p> <p>H57</p> <p>TT /all models E1 G1 G2 Y2 J2 TU</p> <p>TT /all models Sauf TD /GTi XU XUD</p>	<p>0335275 OE 503327</p> 	<p>3</p> <p>Butée de suspension G/D <i>L/R suspension bush</i></p> <p>H97</p> <p>TT /all models E1 G1 G2 XU XUD Y2 J2 TU</p> <p>TT /all models GTi Rallye TD Sauf Cab.</p>



Support d'amortisseur
 Suspension mounting
 Soporte amortiguador
 Poduszka amortyzatora
 Опора амортизатора

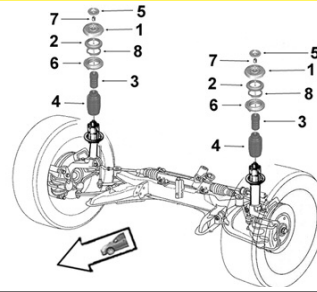

2545135
 OE 525413

Protecteur amortisseur G/D
 L/R shock absorber protector

0355185
 OE 503155

Kit rép. support susp. G/D
 L/R susp. mounting repair kit



4
 TT /all models



(Tampon caoutchouc+Butée à billes)
 Rubber top + Ball bearing
 TT /all models
 E1 G1 G2 XU XUD Y2 J2 TU
 GTi Rallye TD



Support d'amortisseur
 Suspension mounting
 Soporte amortiguador
 Poduszka amortyzatora
 Опора амортизатора

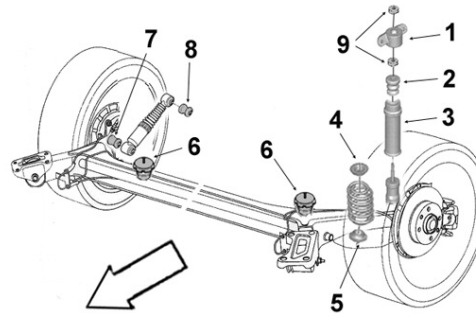

1715105
 OE 517110

Art. sup. amortisseur
 Upper shock absorber bush

1715095
 OE 517109

Art. inf. amortisseur
 Lower shock absorber bush



8 Ø int.12.2 Ø ext.30 coll.33.5 x2
 long. tube int.39.8 ext.35 ep. coll.3x2
 1.1 E1 TU -12/93
 1.4 -12/93
 1.6 XU -12/93
 1.8 D -12/93
 1.8 TD
 1.9i XU9M
 1.9 GTi
 1.9 D -12/93



7 Ø int.14.6 Ø ext.34.9 coll.37.5 x2
 long. tube int.39.8 ext.33.7 ep. coll.3.2x2
 1.1 E1 TU -12/93
 1.4 -12/93
 1.6 XU -12/93
 1.8 D -12/93
 1.8 TD
 1.9i XU9
 1.9 GTi
 1.9 D -12/93

1665105
 OE 516610

Butée de talonnage
 Bushing

1665315
 OE 516631

Butée de talonnage
 Bushing



6 H71 Susp. renforcée
 TT /all models
 E1 G1 G2 Y2 J2 TU XU XUD
 GTi Rallye TD



6 Ø49.5 H63 Sauf susp. renforcée
 1.9 GTi 16v. XU9J4

Eléments TRAIN ARRIERE





Rear axle parts

Tren TRAS

Elementy zawieszenia tylnego

элементы задней оси.



<p>1515105 OE 515110</p>	<p>Support train AR <i>Rear axle mounting</i></p>	<p>1315435 OE 513143</p>	<p>Art. AR de traverse <i>Cross bar rear bush</i></p>
	<p>TT /all models E1 G1/2 Y2 J2 TU XU XUD GTi Rallye Turbo D Sauf 1.9 GTi 16v. Mot. XU9J4</p>		<p>Ø int.12.5 Ø ext.30 coll.41 long. tube int.34 ext.25 ep. coll.6 TT /all models GTi Rallye TD</p>
<p>1315745 OE 513174</p>	<p>Articulation traverse <i>Cross bar bush</i></p>	<p>1005116 OE -</p>	<p>Kit rép. train AR G ou D <i>L/R rear axle repair kit</i></p>
	<p>Ø int.12 Ø ext.30 coll.41 long. tube int.34 ext.25 ep. coll.6 TT /all models E1 G1 G2 XU XUD Y2 J2 TU GTi Rallye TD</p>		<p>TT /all models Essence GTi Diesel & TD</p>

3008 ...

Eléments DIRECTION



Steering parts

Elementos Direcciones

Elementy uklad kierowniczy

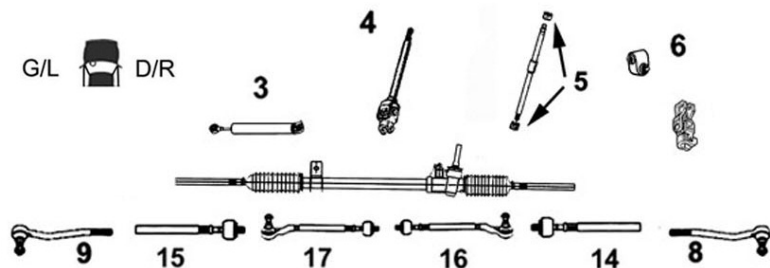
Элементы рулевой системы



<p>7770002 OE 3812F2</p>	<p>Axe de bielle G/D <i>L/R axial joint</i></p>		
	<p>14 Côté dir. M14x1.5 Côté rot. M14x1.5 long 278 mm 15 1.6i 16v. EP6 1.6i 16v. THP EP6DT EP6CDT /M/MD EP6FDT 1.6i VTi 16v. EP6C 1.6 HDi DV6C 1.6 HDi FAP DV6TED4 2.0 HDi FAP DW10CB DTR DW10CTED4</p>		
<p>7670017 OE 381789</p>	<p>Rotule de direction G <i>Left tie rod end</i></p>	<p>7670016 OE 381788</p>	<p>Rotule de direction D <i>Right tie rod end</i></p>
<p>NEW</p> 	<p>9 M14 x 1.5 1.6i 16v. EP6 1.6i 16v. THP EP6CDT /M/MD 1.6i 16v. THP EP6DT EP6FDT 1.6i VTi 16v. EP6C 1.6 HDi DV6C 1.6 HDi FAP DV6TED4 2.0 HDi FAP DW10CTED4 2.0 HDi FAP DW10CB DTR</p>	<p>NEW</p> 	<p>8 M14 x 1.5 1.6i 16v. EP6 1.6i 16v. THP EP6CDT /M/MD 1.6i 16v. THP EP6DT EP6FDT 1.6i VTi 16v. EP6C 1.6 HDi DV6C 1.6 HDi FAP DV6TED4 2.0 HDi FAP DW10CTED4 2.0 HDi FAP DW10CB DTR</p>



Barre stabilisatrice
 Stabilizer bar
 Barra estabilizadora
 Drażek stabilizatora
 стабилизатор поперечной устойчивости

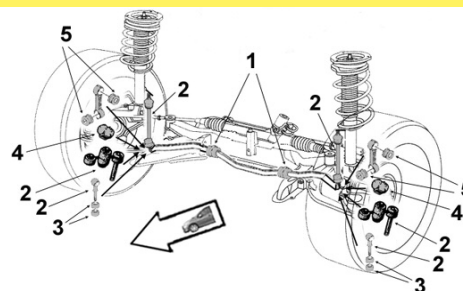

2300019

OE 508764

Biellette barre stab.

Stabilizer bar stub axle

2



1.6i THP 16v.	EP6DT	-17/10/10
1.6i 16v.	EP6CDT	-17/10/10
1.6i VTi 16v.	EP6	-17/10/10
1.6 HDi FAP	DV6TED4	-17/10/10
2.0 HDi FAP	DW10CTED4	-17/10/10

0945895

OE 5094E3

Palier de barre milieu

Middle bar main bearing

1 Barre Ø 23



1.6i THP 16v.	EP6DT	-17/10/10
1.6i 16v.	EP6CDT	-17/10/10
1.6i VTi 16v.	EP6	-17/10/10
1.6 HDi FAP	DV6TED4	-17/10/10
2.0 HDi FAP	DW10CTED4	-17/10/10
2.0 HDi FAP	Sauf hybride	-17/10/10
	DW10CTED4	18/10/10-

2300036

OE 5094E7

Palier de barre milieu

Middle bar main bearing

1 Barre Ø 25



2.0 HDi FAP Hybride	DW10CTED4	18/10/10-
---------------------	-----------	-----------



Eléments SUSPENSION

Suspension parts

Elementos suspensión

Elementy zawieszenie

Элементы подвески

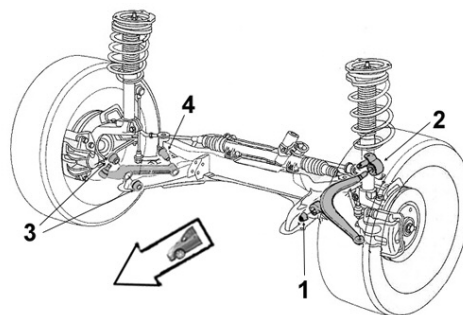

5233913

OE 352391

Articulation AV

Front bush

1 Ø int.14 Ø ext.55 long. tube int.56 ext.32



1.6i THP 16v.	EP6DT	-17/10/10
1.6i 16v.	EP6CDT	-17/10/10
1.6i VTi 16v.	EP6	-17/10/10
1.6 HDi FAP	DV6TED4	-17/10/10
2.0 HDi FAP	DW10CTED4	-17/10/10

5233923

OE 352392

Articulation AR

Rear bush

2 Ø int.14 Ø ext.55 coll.62 long. tube int.49 ext.25 ep. coll.3



1.6i THP 16v.	EP6DT	-17/10/10
1.6i 16v.	EP6CDT	-17/10/10
1.6i VTi 16v.	EP6	-17/10/10
1.6 HDi FAP	DV6TED4	-17/10/10
2.0 HDi FAP	DW10CTED4	-17/10/10

Bras & Triangle de suspension

Control arm
Brazo y triángulo
Wahacz
Рычаг подвески

G/L  D/R

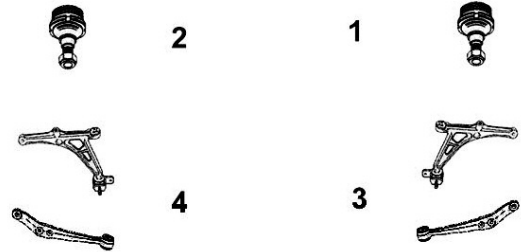

7470003
OE 3520V2

Triangle de susp. inf. G
Lower left track control arm

4 Sans rotule Without tie rod end



1.6i 16v. THP EP6CDT /M/MD
1.6i 16v. THP EP6DT EP6FDT
1.6i VTi 16v. EP6/C
1.6 HDi DV6C
1.6 HDi FAP DV6TED4
2.0 HDi FAP DW10CB DTR
2.0 HDi FAP DW10CTED4

7470004
OE 3521R3

Triangle de susp. inf. D
Lower right track control arm

3 Sans rotule Without tie rod end



1.6i 16v. THP EP6CDT /M/MD
1.6i 16v. THP EP6DT EP6FDT
1.6i VTi 16v. EP6/C
1.6 HDi DV6C
1.6 HDi FAP DV6TED4
2.0 HDi FAP DW10CB DTR
2.0 HDi FAP DW10CTED4

6403533
OE 364060

Rotule de susp. inf. G/D
L/R lower suspension ball joint

1
2



1.6i 16v. EP6
1.6i 16v. THP EP6CDT /M/MD EP6DT EP6FDT
1.6i VTi 16v. EP6C
1.6 HDi DV6C
1.6 HDi FAP DV6TED4
2.0 HDi FAP DW10CB DTR DW10CTED4



Support d'amortisseur
Suspension mounting
Soporte amortiguador
Poduszka amortyzatora
Опора амортизатора

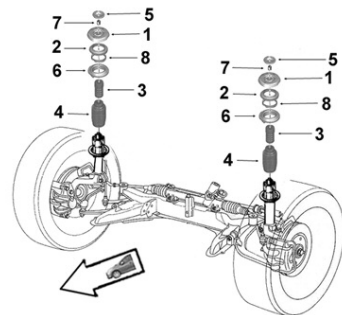

2650016
OE 5038H3

Support suspension G/D
L/R suspension mounting

1



1.6i 16v. THP EP6DT /CDT
1.6i VTi 16v. EP6/C
1.6 HDi DV6C
1.6 HDi FAP DV6TED4
2.0 HDi FAP Sauf hybride
DW10CTED4

0355275
OE 503527

Butée à billes G/D
L/R ball bearing

2



1.6i 16v. EP6
1.6i 16v. THP EP6DT /CDT
1.6i VTi 16v. EP6C
1.6 HDi DV6C
1.6 HDi FAP DV6TED4
2.0 HDi FAP Sauf hybride
DW10CTED4

2650035
OE 503151

Coupelle amortisseur G/D
L/R shock absorber cup

6



1.6i 16v. EP6
1.6i 16v. THP EP6CDT / M / MD
1.6i 16v. THP EP6DT
1.6i VTi 16v. EP6C
1.6 HDi DV6C
1.6 HDi FAP DV6TED4
2.0 HDi DW10CB DTR
2.0 HDi FAP DW10CTED4

2650001
OE 503370

Butée de suspension G/D
L/R suspension bush

3



H96
1.6i 16v. EP6
1.6i VTi 16v. EP6C
1.6 HDi DV6C
1.6 HDi FAP DV6TED4



Support d'amortisseur
 Suspension mounting
 Soporte amortiguador
 Poduszka amortyzatora
 Опора амортизатора

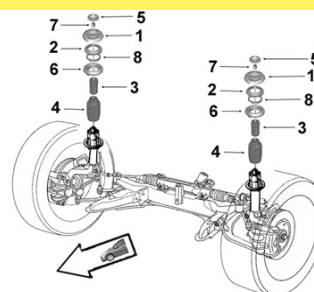

2650017
 OE 5033E4

Butée de suspension G/D
 L/R suspension bush



3 H96

1.6i 16v. THP	EP6DT/ CDT
2.0 HDi FAP Sauf hybride	DW10CTED4



Support d'amortisseur
 Suspension mounting
 Soporte amortiguador
 Poduszka amortyzatora
 Опора амортизатора

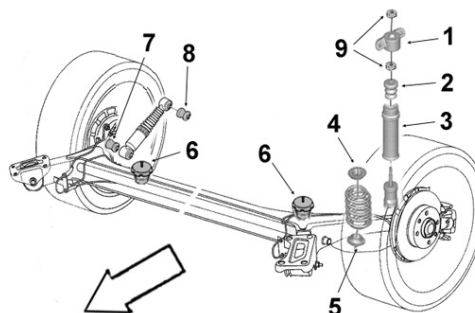

2650041
 OE 525442

Protecteur amortisseur G/D
 L/R shock absorber protector



2 Amortissement base

1.6i 16v.	EP6
1.6i 16v. THP	EP6DT EP6CDT/ M / MD
1.6i VTi 16v.	EP6C
1.6 HDi	DV6C
1.6 HDi FAP	DV6TED4
2.0 HDi FAP	DW10CB DTR
2.0 HDi FAP Sauf hybride	DW10CTED4

Eléments TRAIN ARRIERE

Rear axle parts
 Tren TRAS
 Elementy zawieszenia tylnego
 элементы задней оси.



2600008
 OE 5131H7

Articulation essieu
 Axle bush



Ø int. 12 Ø ext. 72 coll. 82 long. tube int. 83 ext. 59 ep. coll.8

1.6i 16v.	EP6	
1.6i 16v. THP	EP6CDT/ M/ MD	EP6DT
1.6i VTi 16v.	EP6C	
1.6 HDi	DV6C	
1.6 HDi FAP	DV6TED4	
2.0 HDi FAP Sauf hybride	DW10CTED4	DW10CB



Autres pièces

Other parts
Otras piezas
Inne części
другие части

0325135

OE 503213

Art. lame de ressort AV
Front spring leaf bush

Ø int.12 Ø ext.25 long. tube int.54 ext.50



TT /all models

404 ...

Eléments DIRECTION

Steering parts
Elementos Direcciones
Elementy układ kierowniczy
Элементы рулевой системы

G/L D/R

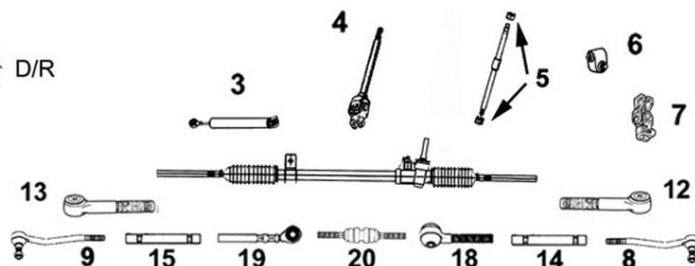
0574054

OE 405705

Oeil de crémaillère D
Right steering gear eye

 1 M16 x 1.5
2

TT /all models

8993113

OE 389911

Kit rép. rotule direction G ou D
L/R tie rod end repair kit

Rondelle ep. 6.5 Washers thickness 6.5



TT /all models

8993173

OE 389917

Kit rép. rotule direction G ou D
L/R tie rod end repair kit

Rondelle ep. 8 Washers thickness 8



TT /all models



Barre stabilisatrice
 Stabilizer bar
 Barra estabilizadora
 Drażek stabilizatora
 стабилизатор поперечной устойчивости

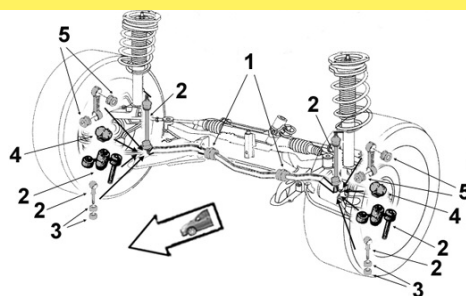

0945025

OE 509402

Palier de barre

Bar main bearing

1 Barre Ø 22

TT /all models



0885025

OE 508802

Articulation barre stab.

Stabilizer bar bush

Ø int.14 Ø ext.27 long. tube int.25 ext.17

TT /all models



Éléments SUSPENSION

Suspension parts
 Elementos suspensión
 Elementy zawieszenie
 Элементы подвески

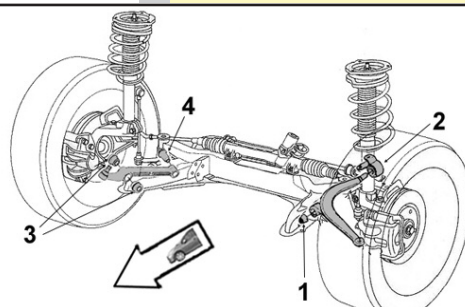

5233103

OE 352310

Articulation

Bush

3 Ø int.16 Ø ext.25 coll.30
 long. tube int.17 ext.12 ep. coll.5

TT /all models



5233093

OE 352309

Articulation

Bush

4 Ø int.12 Ø ext.28 long. tube int.38 ext.32

TT /all models



5613043

OE 356104

Articulation

Bush

4 Ø int.12 Ø ext.32 coll.43 long. tube int.50 ext.34 ep. coll.10

TT /all models



Bras & Triangle de suspension

Control arm
 Brazo y triángulo
 Wahacz
 Рычаг подвески

G/L D/R



1003527

OE -

Kit rép. bras susp. G ou D

L or R track control arm bearing repair kit

TT /all models
 Axe liaison bras avant côté rotule Ø16



6403123

OE 364012

Kit rép. rotule pivot fusée G ou D

L/R suspension ball joint repair kit

Montage avec bouchon fileté
 Assembly with threaded cap

TT /all models





Support d'amortisseur
 Suspension mounting
 Soporte amortiguador
 Poduszka amortyzatora
 Опора амортизатора

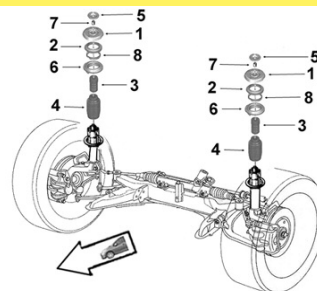

<p>2105145 OE 521014</p>	<p>Support suspension G/D L/R suspension mounting</p>	<p>2105135 OE 521013</p>	<p>Support suspension G/D L/R suspension mounting</p>
	<p>1 Ø 145</p> <p>TT /all models</p>		<p>1 Ø 165</p> <p>TT /all models</p>

<p>2545075 OE 525407</p>	<p>Protecteur amortisseur G/D L/R shock absorber protector</p>		
	<p>4 Ø 50</p> <p>TT /all models</p>		



Barre stabilisatrice
 Stabilizer bar
 Barra estabilizadora
 Drążek stabilizatora
 стабилизатор поперечной устойчивости

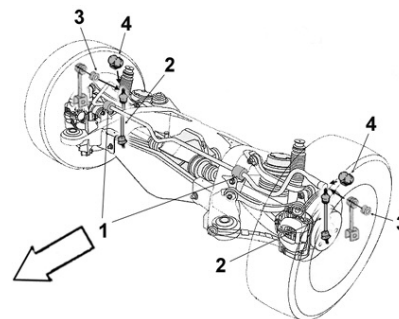

<p>1795025 OE 517902</p>	<p>Art. barre anti-devers Anti-banking bar bush</p>		
	<p>Ø int.10 Ø ext.27 long. tube int.22 ext.17</p> <p>TT /all models Berline</p>		

... 404



Support d'amortisseur
 Suspension mounting
 Soporte amortiguador
 Poduszka amortyzatora
 Опора амортизатора

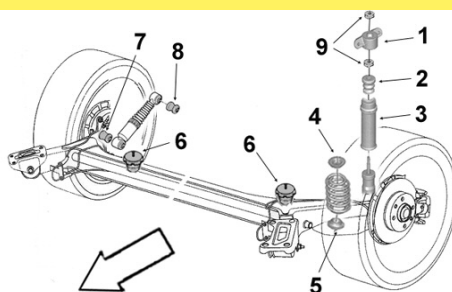

5143123
 OE 351412

Butée de talonnage G/D
 L/R bushing



6 Ø 53 H 55
 TT /all models

5143093
 OE 351409

Butée de talonnage G/D
 L/R bushing



6
 TT /all models

Eléments TRAIN ARRIERE

Rear axle parts
 Tren TRAS
 Elementy zawieszenia tylnego
 элементы задней оси.



1315045
 OE 513104

Art. lame de ressort AR
 Rear spring leaf bush



Ø int.16 Ø ext.32 long. tube int.54 ext.50
 TT /all models 404 Pick-up

1315395
 OE 513139

Art. balancier pont
 Beam bush



Ø int.16 Ø ext.32 long. tube int.69 ext.60
 TT /all models

405 ...

Eléments DIRECTION

Steering parts
 Elementos Direcciones
 Elementy uklad kierowniczy
 Элементы рулевой системы

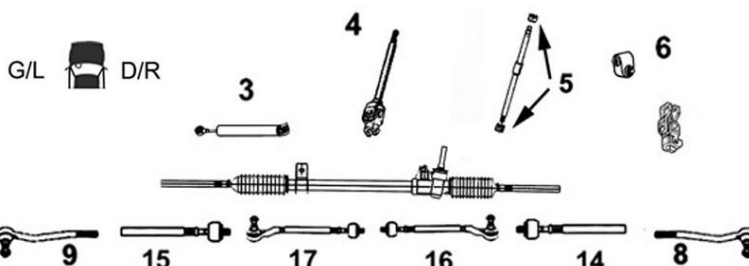

0114434
 OE 401143

Vérin dir. assistée
 Power steering jack



3
 TT /all models DA -12/93

0114384
 OE 401138

Vérin dir. assistée
 Power steering jack







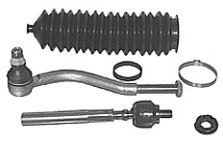
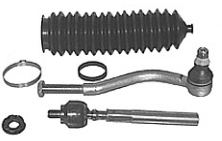

3 Repère jaune Yellow mark
 TT /all models 01/93-
 Sauf 2.0i Turbo 16 mot. XU10J4TE DA

... 405 ...

PEUGEOT



<p>8123983 OE 381298</p> <p>Axe de bielle G/D <i>L/R axial joint</i></p>	
	<p>14 15</p> <p>Côté dir. M12x1.0 Côté rot. M14x1.5 long 182 mm</p> <p>TT /all models DNA & DA</p>
<p>8123723 OE 381272</p> <p>Bielle de direction G <i>Left steering rod</i></p>	<p>17</p> <p>TT /all models DNA</p> <p>TT /all models DA 09/93- Sauf 2.0i 16v. Turbo mot. XU10J4TE</p>
	<p>8123733 OE 381273</p> <p>Bielle de direction D <i>Right steering rod</i></p>
	<p>16</p> <p>TT /all models DNA</p> <p>TT /all models DA 09/93- Sauf 2.0i 16v. Turbo mot. XU10J4TE</p>
<p>8173263 OE 381748</p> <p>Rotule de direction G <i>Left tie rod end</i></p>	<p>9</p> <p>M14 x 1.5</p> <p>TT /all models DNA</p> <p>TT /all models DA 09/93- Sauf 2.0i 16v. Turbo mot. XU10J4TE</p>
	<p>8173273 OE 381749</p> <p>Rotule de direction D <i>Right tie rod end</i></p>
	<p>8</p> <p>M14 x 1.5</p> <p>TT /all models DNA</p> <p>TT /all models DA 09/93- Sauf 2.0i 16v. Turbo mot. XU10J4TE DA</p>
<p>1034C34 OE 4103C3</p> <p>Axe de volant <i>Steering wheel shaft</i></p>	
	<p>4</p> <p>TT /all models DA Sauf Mi16 mot. XU9J4</p>
<p>1034C94 OE 4103C1</p> <p>Axe de volant <i>Steering wheel shaft</i></p>	
	<p>4</p> <p>TT /all models DNA -12/92</p>
<p>1034C54 OE 4103C5</p> <p>Axe de volant <i>Steering wheel shaft</i></p>	
	<p>4</p> <p>TT /all models DNA 01/93-</p>

... 405 ...

SASIC

PEUGEOT



Barre stabilisatrice
Stabilizer bar
Barra estabilizadora
Drażek stabilizatora
 стабилизатор поперечной устойчивости

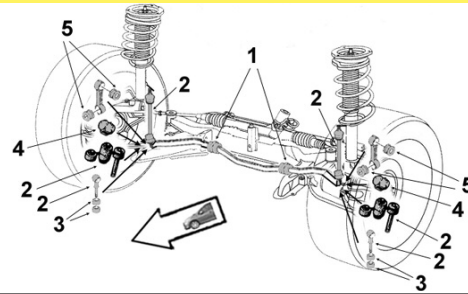

0875275
 OE 508727

Biellette barre stab.
Stabilizer bar stub axle



2

TT /all models TU & XU

0945355UN
 OE 509435

Palier de barre
Bar main bearing

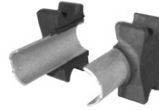

1 Barre Ø 20

TT /all models TU & XU

0945535UN
 OE 509453

Palier de barre
Bar main bearing

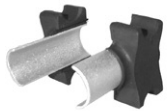

1 Barre Ø 21

TT /all models TU & XU

0945345UN
 OE 509434

Palier de barre
Bar main bearing



1 Barre Ø 22

TT /all models TU & XU



Eléments SUSPENSION
Suspension parts
Elementos suspensión
Elementy zawieszenie
 Элементы подвески

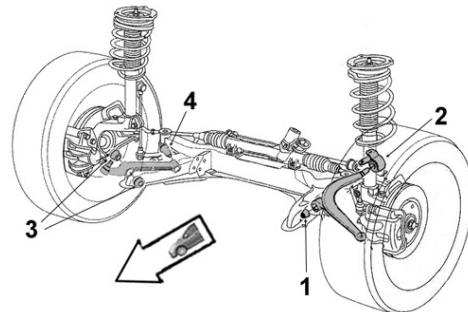

5233403
 OE 352340

Articulation AV
Front bush



1 Ø int.12 Ø ext.33 coll.42
 long. tube int.38 ext.26.5 ep. coll.6.5

TT /all models TU & XU

5233423
 OE 352389

Articulation AR
Rear bush



2 Ø int.18

TT /all models TU & XU

Bras & Triangle de suspension

Control arm
Brazo y triángulo
Wahacz
Рычаг подвески

G/L  D/R



... 405 ...

SASIC

PEUGEOT



Support d'amortisseur
 Suspension mounting
 Soporte amortiguador
 Poduszka amortyzatora
 Опора амортизатора

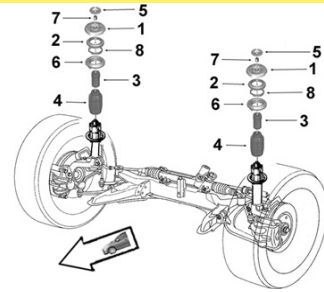

0375265
 OE 503726

Tampon suspension G/D
 L/R susp. rebound stop



1

TT /all models TU & XU

0355275
 OE 503563

Butée à billes G/D
 L/R ball bearing



2

TT /all models TU & XU

0335275
 OE 503327

Butée de suspension G/D
 L/R suspension bush



3

H97
 TT /all models TU & XU

2545135
 OE 525413

Protecteur amortisseur G/D
 L/R shock absorber protector



4

TT /all models TU & XU

1005250
 OE -

Kit rép. protection amort. G et D
 L/R susp. mounting repair kit



Butée H 97

TT /all models DNA & DA

1005261
 OE -

Kit rép. suspension G ou D
 L/R stabilizing bar repair kit



TT /all models DNA & DA



Support d'amortisseur
 Suspension mounting
 Soporte amortiguador
 Poduszka amortyzatora
 Опора амортизатора

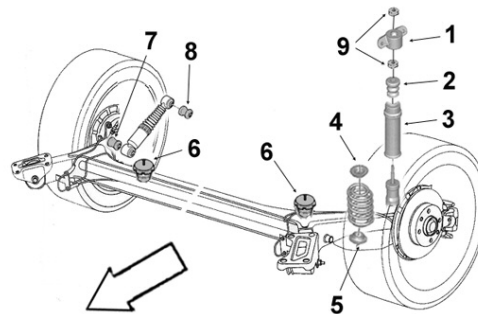

1665315
 OE 516631

Butée de talonnage
 Bushing



6

Ø 49.5 H 63
 TT /all models -92 TU XU
 Sauf 4WD /susp. renforcée
 TT /all models 2WD 93- TU XU BVM5
 Sauf susp. renforcée
 TT /all models TU XU
 Sauf BVM5 4WD 93-

... 405

1715125 OE 517112	Articulation amort. sup. AR <i>Rear upper shock absorber bush</i>	1715115 OE 517111	Articulation amort. inf. AR <i>Rear lower shock absorber bush</i>
	8 Ø int.16 Ø ext.33 coll.37 x2 long. tube int.45 ext.21 ep. coll.4x2 TT /all models TU & XU		7 Ø int.16 Ø ext.34 coll.37 x2 long. tube int.45 ext.21 ep. coll.4x2 TT /all models TU & XU

Eléments TRAIN ARRIERE

Rear axle parts



Tren TRAS

Elementy zawieszenia tylnego

элементы задней оси.



1315475 OE 513147	Articulation AV Bras <i>Arm front bush</i>	1515245 OE 515124	Articulation AR <i>Rear bush</i>
	Ø int.12.2 Ø ext. 46.9 coll. 54.5 long. tube int.27.5 ext.17 ep. coll.10 TT /all models Sauf 4WD TU & XU		TT /all models 4WD break TU XU -12/92 TT /all models TU XU 01/93- Sauf BVM5 4WD berline 4ptes TT /all models TU XU 01/93- Sauf BVM5 4WD XU10J4TE Inj. turbo Break 5ptes 1.9 MI16 XU9J4 -12/92 Sauf 4WD 1.9 MI16 -ch 70119980 XU9JAZ -12/92 Sauf 4WD

1515255 OE 515125	Articulation AR <i>Rear bush</i>	1005127 OE -	Kit rép. train AR G ou D <i>L/R rear axle repair kit</i>
	TT /all models 4WD TU XU -12/92 Sauf Break TT /all models 4WD berline 4ptes TU XU BVM5 01/93- 1.9 MI16 Ch- 70119981 XU9JAZ -12/92 Sauf 4WD		TT /all models DNA & DA Sauf 4WD

406 ...

Eléments DIRECTION

Steering parts

Elementos Direcciones

Elementy uklad kierowniczy

Элементы рулевой системы

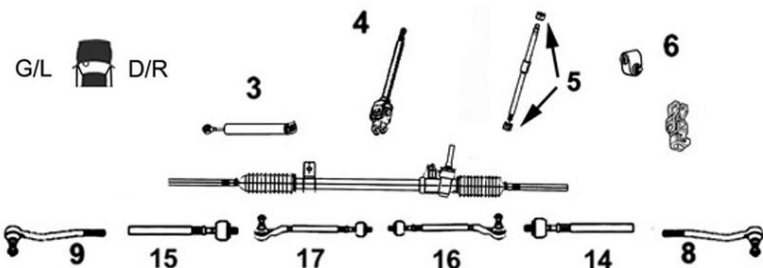

0114384 OE 401138	Vérin dir. assistée <i>Power steering jack</i>	3 Repère jaune Yellow mark DA Pas non variable	
	1.6 XU5JP -06/07/97 1.8 Berline XU7JB -06/07/97 1.8 Berline XU7JP -06/07/97 1.8 Conduite à D XU7JP -07/09/97 1.8i 16v. Berline Conduite à G XU7JP4 -06/07/97 1.8i 16v. Conduite à D XU7JP4 -07/09/97 1.9 TD SD Berline Conduite à G XUD9SD -06/07/97	1.6 Conduite à D XU5JP -07/09/97 1.8 Break XU7JB -07/09/97 1.8 Break XU7JP -07/09/97 1.8i 16v. Break Conduite à G XU7JP4 -07/09/97 1.9 TD SD Break Conduite à G XUD9SD -07/09/97	

Eléments DIRECTION
Steering parts
Elementos Direcciones
Elementy układ kierowniczy
Элементы рулевой системы

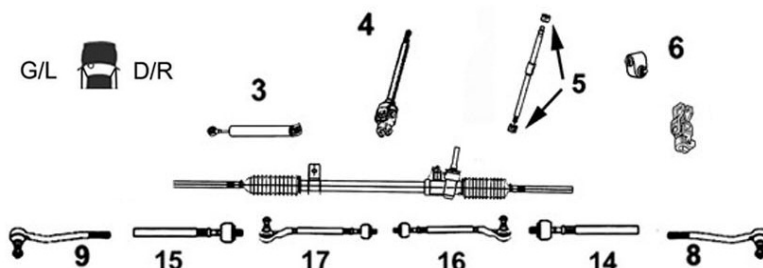

3008154

Axe de bielle G/D

Part/oe 3812A9

L/R axial joint



14 Côté dir. M12x1.0 Côté rot. M16x1.5 long 312 mm DA Pas non variable avec vérin extérieur

1.6		XU5JP	-03/99
1.8i /16v.		XU7JB/ JP /JP4	-03/99
1.9 TD /SD		XUD9TE/ SD	-03/99
2.0i 16v.		XU10J4R	-03/99
2.0 Turbo		XU10J2TE	-03/99
2.0 HDi		DW10ATED	-03/99
2.1 TD		XUD11BTE	-03/99
3.0i V6 24v.		ES9J4	-03/99

3008160

Axe de bielle G/D

OE 3812C4

L/R axial joint



14 Côté dir. M16x1.5 Côté rot. M16x1.5 long 303 mm

DA Pas non variable

1.6	Dir. avec vérin intégré	XU5JP	-03/99
1.6		XU5JP	03/99-
1.8	Dir. avec vérin intégré	XU7JP/ JB	-03/99
1.8		XU7JP/ JB	03/99-
1.8i 16v.	avec vérin intégré	XU7JP4	-03/99
1.8i 16v.		EW7J4 XU7JP4	03/99-
1.9 TD /SD	avec vérin intégré	XUD9TE/ SD	-03/99
2.0i 16v.	avec vérin intégré	XU10J4R	-03/99
2.0i 16v.		EW10J4 XU10J4R	03/99-
2.0 Turbo	avec vérin intégré	XU10J2TE	-03/99
2.0 HDi		DW10ATED/ TD	03/99-
2.0 HDi	avec vérin intégré	DW10ATED	-03/99
2.0 HPi		EW10D	03/99-
2.1 TD	avec vérin intégré	XUD11BTE	-03/99
2.2i 16v.		EW12J4	03/99-
2.2 HDi		DW12TED4	03/99-

DA Pas variable

2.1 TD		XUD11BTE	-03/99
3.0i V6		ES9J4	
3.0i V6 24v.		ES9J4S	03/99-

8173403

Rotule de direction G

OE 381740

Left tie rod end



9	M16 x 1.5		
1.6		XU5JP	
1.8		XU7JB/ JP	
1.8i 16v.		XU7JP4	
1.8i 16v.		EW7J4	03/99-
1.9 TD SD		XUD9SD	-03/99
1.9 TD		XUD9TE	-03/99
2.0i 16v.		XU10J4R	
2.0i 16v.		EW10J4	03/99-
2.0 Turbo		XU10J2TE	-03/99
2.0 HDi		DW10ATED	
2.0 HDi		DW10TD	03/99-
2.0 HPi		EW10D	03/99-
2.1 TD		XUD11BTE	-03/99
2.2i 16v.		EW12J4	03/99-
2.2 HDi		DW12TED4	03/99-
3.0i V6		ES9J4	
3.0i V6 24v.		ES9J4S	03/99-

8173393

Rotule de direction D

OE 381739

Right tie rod end



8	M16 x 1.5		
1.6		XU5JP	
1.8		XU7JB/ JP	
1.8i 16v.		XU7JP4	
1.8i 16v.		EW7J4	03/99-
1.9 TD SD		XUD9SD	-03/99
1.9 TD		XUD9TE	-03/99
2.0i 16v.		XU10J4R	
2.0i 16v.		EW10J4	03/99-
2.0 Turbo		XU10J2TE	-03/99
2.0 HDi		DW10ATED	
2.0 HDi		DW10TD	03/99-
2.0 HPi		EW10D	03/99-
2.1 TD		XUD11BTE	-03/99
2.2i 16v.		EW12J4	03/99-
2.2 HDi		DW12TED4	03/99-
3.0i V6		ES9J4	
3.0i V6 24v.		ES9J4S	03/99-



Barre stabilisatrice
 Stabilizer bar
 Barra estabilizadora
 Drążek stabilizatora
 стабилизатор поперечной устойчивости

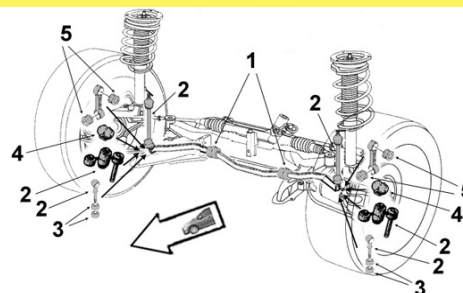

0875405

OE 508740

Biellette barre stab.

Stabilizer bar stub axle



2

1.6i	XU5JP	-02/11/97
1.8i /16v.	XU7JB/JP/JP4	-02/11/97
1.9 TD	XUD9TE/SD	-02/11/97
2.0i 16v.	XU10J	-02/11/97
2.0 HDi	DW10TD/ATED	-02/11/97
2.1 TD	XUD11BTE	-02/11/97
3.0i V6 24v.	ES9J4	-02/11/97

0875485

OE 508743

Biellette barre stab.

Stabilizer bar stub axle



2

M12 x 175		
1.6i	XU5JP	03/11/97-
1.8i 16v.	XU7JB/JP/JP4 EW7J4	03/11/97-
1.9 TD	XUD9TE/SD	03/11/97-
2.0i 16v.	EW10J4 XU10J4R	03/11/97-
2.0i Turbo	XU10J2TE	03/11/97-
2.0 HDi	DW10TD/ATED	03/11/97-
2.0 HPi	EW10D	03/11/97-
2.1 TD	XUD11BTE	03/11/97-
2.2i 16v.	EW12J4	03/11/97-
2.2 HDi	DW12TED4	03/11/97-
3.0i V6 24v.	ES9J4/S	03/11/97-

0945745

OE 509474

Palier de barre

Bar main bearing



1

Barre Ø 23		
1.6i	XU5JP	
1.8i /16v.	XU7JB/JP/JP4 EW7J4	
1.9 TD	XUD9TE/SD	
2.0i 16v.	EW10J4 XU10J4R	
2.0 HDi	DW10TD/ATED	
2.0 HPi	EW10D	
2.1 TD	XUD11BTE	
2.2i 16v.	EW12J4	
2.2 HDi	DW12TED4	

0945755

OE 509475

Palier de barre

Bar main bearing



1

Barre Ø 24		
1.6i	XU5JP	
1.8i /16v.	XU7JB/JP/JP4 EW7J4	
1.9 TD	XUD9TE/SD	
2.0i 16v.	EW10J4 XU10J4R	
2.0i Turbo	XU10J2TE	-03/99
2.0 HDi	DW10TD/ATED	
2.0 HPi	EW10D	
2.1 TD	XUD11BTE	
2.2i 16v.	EW12J4	
2.2 HDi	DW12TED4	
3.0i V6	ES9J4/S	



Eléments SUSPENSION

Suspension parts

Elementos suspensión

Elementy zawieszenie

Элементы подвески

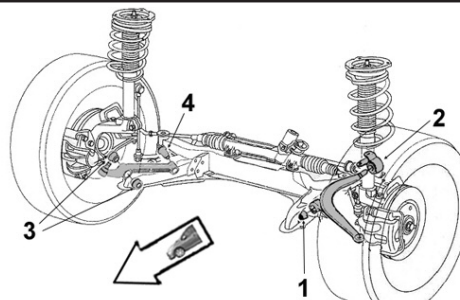

5233603

OE 352378

Articulation AV

Front bush



1

Ø int.14 Ø ext.37 coll.46 long. tube int.38 ext.33 ep. coll.5		
1.6i	XU5JP	
1.8i /16v.	XU7JB/JP/JP4 EW7J4	
1.9 TD	XUD9TE/SD	
2.0i 16v.	EW10J4 XU10J4R	
2.0i Turbo	XU10J2TE	
2.0 HDi	DW10TD/ATED	
2.0 HPi	EW10D	
2.1 TD	XUD11BTE	
2.2i 16v.	EW12J4	
2.2 HDi	DW12TED4	
3.0i V6 24v.	ES9J4/S	

5233613

OE 352361

Articulation AR

Rear bush



2

Ø int.20 Ø ext.45 long. tube int.45 ext.34		
1.6i	XU5JP	
1.8i /16v.	XU7JB/JP/JP4 EW7J4	
1.9 TD	XUD9TE/SD	
2.0i 16v.	EW10J4 XU10J4R	
2.0i Turbo	XU10J2TE	
2.0 HDi	DW10TD/ATED	
2.0 HPi	EW10D	
2.1 TD	XUD11BTE	
2.2i 16v.	EW12J4	
2.2 HDi	DW12TED4	
3.0i V6 24v.	ES9J4/S	

Bras & Triangle de suspension

Control arm
Brazo y triángulo
Wahacz
Рычаг подвески

G/L  D/R



5203H13
OE 3520H1

Triangle de susp. G
Left track control arm

4 Sans rotule *Without tie rod end*



1.6	XU5JP	
1.8	XU7JP/ JB	
1.8i 16v.	XU7JP4	
1.8i 16v.	EW7J4	03/99-
1.9 TD SD	XUD9SD	-03/99
1.9 TD	XUD9TE	-03/99
2.0i 16v.	XU10J4R	
2.0 Turbo	XU10J2TE	-03/99
2.0i 16v.	EW10J4	03/99-
2.0 HDi	DW10ATED	10/02/97-
2.0 HDi	DW10TD	03/99-
2.0 HPi	EW10D	03/99-
2.1 TD	XUD11BTE	-03/99
2.2i 16v.	EW12J4	03/99-
2.2 HDi	DW12TED4	03/99-
3.0i V6	ES9J4	
3.0i V6 24v.	ES9J4S	03/99-

5213E13
OE 3521E1

Triangle de susp. D
Right track control arm

3 Sans rotule *Without tie rod end*



1.6	XU5JP	
1.8	XU7JP/ JB	
1.8i 16v.	XU7JP4	
1.8i 16v.	EW7J4	03/99-
1.9 TD SD	XUD9SD	-03/99
1.9 TD	XUD9TE	-03/99
2.0i 16v.	XU10J4R	
2.0 Turbo	XU10J2TE	-03/99
2.0i 16v.	EW10J4	03/99-
2.0 HDi	DW10ATED	10/02/97-
2.0 HDi	DW10TD	03/99-
2.0 HPi	EW10D	03/99-
2.1 TD	XUD11BTE	-03/99
2.2i 16v.	EW12J4	03/99-
2.2 HDi	DW12TED4	03/99-
3.0i V6	ES9J4	
3.0i V6 24v.	ES9J4S	03/99-

6403343
OE 364071

Rotule de susp. inf. G/D
L/R lower suspension ball joint

1/2 M14x1.5



1.6	XU5JP		2.0 HDi	DW10ATED	
1.8	XU7JB/ JP		2.0 HDi	DW10TD	03/99-
1.8i 16v.	XU7JP4		2.0 HPi	EW10D	03/99-
1.8i 16v.	EW7J4	03/99-	2.1 TD	XUD11BTE	-03/99
1.9 TD SD	XUD9SD	-03/99	2.2i 16v.	EW12J4	03/99-
1.9 TD	XUD9TE	-03/99	2.2 HDi	DW12TED4	03/99-
2.0i 16v.	XU10J4R		3.0i V6	ES9J4	
2.0 Turbo	XU10J2TE	-03/99	3.0i V6 24v.	ES9J4S	03/99-
2.0i 16v.	EW10J4	03/99-			

1003587
OE -

Kit rép. triangle susp. G ou D
L or R track control arm bearing repair kit

Sans visserie *Without screws and bolts*

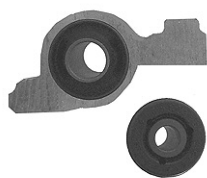

1.6	XU5JP	
1.8	XU7JB/ JP	
1.8i 16v.	XU7JP4	
1.8i 16v.	EW7J4	03/99-
1.9 TD SD	XUD9SD	-03/99
1.9 TD	XUD9TE	-03/99
2.0i 16v.	XU10J4R	
2.0 Turbo	XU10J2TE	-03/99
2.0i 16v.	EW10J4	03/99-
2.0 HDi	DW10ATED	
2.0 HDi	DW10TD	03/99-
2.0 HPi	EW10D	03/99-
2.1 TD	XUD11BTE	-03/99
2.2i 16v.	EW12J4	03/99-
2.2 HDi	DW12TED4	03/99-
3.0i V6	ES9J4	
3.0i V6 24v.	ES9J4S	03/99-

1003587S (en/in skinpack)



Support d'amortisseur

Suspension mounting
Soporte amortiguador
Poduszka amortyzatora
Опора амортизатора

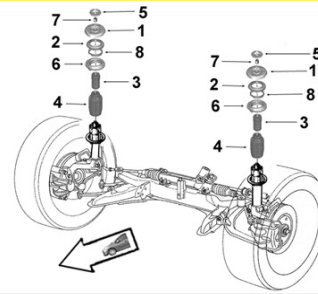

0385255

OE 503866

Support suspension G/D

L/R suspension mounting



1	1.6i Berline sans susp. variable bonne route /Route inégale	XU5JP	-02/11/97
	1.6i Berline susp. normale sans susp. variable /susp. renforcée	XU5JP	03/11/97-
	1.6i Break Bonne route sans susp. variable /Route inégale	XU5JP	-02/11/97
	1.6i Break susp. normale /renforcée	XU5JP	03/11/97-
	1.8i /16v. Berline sans susp. variable bonne route / Route inégale	XU7JB/JP/JP4	-02/11/97
	1.8i /16v. Berline susp. normale sans susp. variable /susp. renforcée	XU7JB/JP/JP4	03/11/97-
	1.8i /16v. Break Bonne route sans susp. variable /Route inégale	XU7JB/JP/JP4	-02/11/97
	1.8i /16v. Break susp. normale /renforcée	XU7JB/JP/JP4	03/11/97-
	1.8i 16v. Berline susp. normale sans susp. variable /susp. renforcée	EW7J4	03/11/97-
	1.8i 16v. Break susp. normale /renforcée	EW7J4	03/11/97-
	1.9 TD Berline sans susp. variable bonne route/Route inégale	XUD9TE/SD	-02/11/97
	1.9 TD Berline susp. normale sans susp. variable /susp. renforcée	XUD9TE/SD	03/11/97-
	1.9 TD Break Bonne route sans susp. variable /Route inégale	XUD9TE/SD	-02/11/97
	1.9 TD Break susp. normale /renforcée	XUD9TE/SD	03/11/97-
	2.0 Turbo Berline Break	XU10J2TE	-03/99
	2.0i 16v. Berline sans susp. variable bonne route /Route inégale	XU10J4R	-02/11/97
	2.0i 16v. Berline susp. normale sans susp. variable /susp. renforcée	XU10J4R	03/11/97-
	2.0i 16v. Berline Coupé	XU10J4R	03/11/97-03/99
	2.0i 16v. Break Bonne route sans susp. variable /Route inégale	XU10J4R	-02/11/97
	2.0i 16v. Break susp. normale /renforcée	XU10J4R	03/11/97-
	2.0i 16v. Coupé sans susp. variable	XU10J4R	-02/11/97
	2.0i 16v. Coupé susp. variable	XU10J4R	03/99-
	2.0i 16v. Berline susp. normale sans susp. variable /susp. renforcée	EW10J4	03/11/97-
	2.0i 16v. Break susp. normale /renforcée	EW10J4	03/11/97-
	2.0i 16v. Coupé sans susp. variable	EW10J4	03/01/97-
	2.0 HDi Berline susp. normale sans susp. variable /susp. renforcée	DW10TD/ATED	03/11/97-
	2.0 HDi Break susp. normale /renforcée	DW10TD/ATED	03/11/97-
	2.0 HPi Berline susp. normale sans susp. variable /susp. renforcée	EW10D	03/11/97-
	2.0 HPi Break susp. normale /renforcée	EW10D	03/11/97-
	2.1 TD Berline sans susp. variable bonne route /Route inégale	XUD11BTE	-02/11/97
	2.1 TD Berline susp. normale sans susp. variable /susp. renforcée	XUD11BTE	03/11/97-
	2.1 TD Break Bonne route sans susp. variable /Route inégale	XUD11BTE	-02/11/97
	2.1 TD Break susp. normale /renforcée	XUD11BTE	03/11/97-
2.2i 16v. Berline susp. normale sans susp. variable /susp. renforcée	EW12J4	03/11/97-	
2.2i 16v. Break susp. normale /renforcée	EW12J4	03/11/97-	
2.2i 16v. Coupé sans susp. variable	EW12J4	03/02-12/04	
2.2 HDi Berline susp. normale sans susp. variable /susp. renforcée	DW12TED4	03/11/97-	
2.2 HDi Break susp. normale /renforcée	DW12TED4	03/11/97-	
2.2 HDi Coupé susp. variable	DW12TED4	03/99-	
3.0i V6 Berline Break Coupé sans susp. variable	ES9J4/S		
TT /all models Coupé susp. variable	EW10J4/12J4	03/99-	

0385265

OE 503826

Support suspension G/D

L/R suspension mounting



1	1.6i Berline susp. variable bonne route	XU5JP	-02/11/97
	1.6i Berline susp. normale /variable	XU5JP	03/11/97-
	1.8i /16v. Berline susp. variable bonne route	XU7JB/JP/JP4	-02/11/97
	1.8i /16v. Berline susp. normale /variable	XU7JB/JP/JP4	03/11/97-
	1.8i 16v. Berline susp. normale /variable	EW7J4	03/11/97-
	1.9 TD Berline susp. variable bonne route	XUD9TE/SD	-02/11/97
	1.9 TD Berline susp. normale /variable	XUD9TE/SD	03/11/97-
	2.0i 16v. Berline susp. variable bonne route	XU10J4R	-02/11/97
	2.0i 16v. Berline susp. normale /variable	EW10J4 XU10J4R	03/11/97-
	2.0i 16v. Coupé susp. variable	XU10J4R	-02/11/97
	2.0 HDi Berline susp. normale /variable	DW10TD/ATED	03/11/97-
	2.0 HPi Berline susp. normale /variable	EW10D	03/11/97-
	2.1 TD Berline susp. variable bonne route	XUD11BTE	-02/11/97
	2.1 TD Berline susp. normale /variable	XUD11BTE	03/11/97-
	2.2i 16v. Berline susp. normale /variable	EW12J4	03/11/97-
	2.2 HDi Berline susp. normale /variable	DW12TED4	03/11/97-
	3.0i V6 24v. Berline susp. variable	ES9J4/S	
	3.0i V6 24v. Coupé susp. variable	ES9J4	-03/05/98



Support d'amortisseur

Suspension mounting
Soporte amortiguador
Poduszka amortyzatora
Опора амортизатора

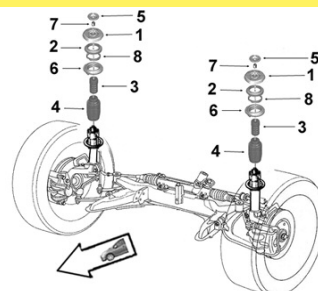

0355325

OE 503554

Butée à billes G/D

L/R ball bearing



2

1.6i	XU5JP	
1.8i /16v.	EW7J4	XU7JB/JP/JP4
1.9 TD	XUD9TE/SD	
2.0 Turbo	XU10J2TE	
2.0i 16v.	EW10J4	XU10J4R
2.0 HDi	DW10TD/ATED	
2.0 HPi	EW10D	
2.1 TD	XUD11BTE	
2.2i 16v.	EW12J4	
2.2 HDi	DW12TED4	
3.0i V6	ES9J4/S	

0335595

OE 503359

Butée de suspension G/D

L/R suspension bush



3

Ø 56 H 105		
1.6i Berline susp. normale	XU5JP	30/03/98-
1.8i /16v. Berline susp. normale	XU7JB/JP/JP4	30/03/98-
1.8i /16v. Berline Break susp. renforcée	XU7JP/JP4	30/03/98-
1.8i /16v. Break susp. renforcée	XU7JB XU7JP4	30/03/98-
1.8i 16v. Berline Break susp. normale	EW7J4	03/99-
1.9 TD SD Berline susp. normale	XUD9SD	30/03/98-03/99
1.9 TD SD Berline susp. renforcée	XUD9SD	30/03/98-
1.9 TD SD Break susp. normale	XUD9SD	30/03/98-
2.0i 16v. Berline susp. normale /renforcée	EW10J4 XU10J4R	03/04/00-
2.0i 16v. Break susp. normale	EW10J4	03/04/00-
2.0i 16v. Break susp. renforcée	EW10J4 XU10J4R	03/04/00-
2.0 HDi Berline susp. normale	DW10ATED	03/04/00-
2.0 HDi FAP Berline susp. renforcée	DW10ATED	03/99-
2.0 HDi FAP Break susp. normale /renforcée	DW10ATED	03/99-
2.0 HPi Berline Break susp. normale	EW10D	03/99-

0335405

OE 503340

Butée de suspension G/D

L/R suspension bush



3

Ø 56 H 109		
1.6i Berline 4ptes	XU5JP	-02/11/97
1.6i Berline 4ptes sans susp. variable Route inégale	XU5JP	-02/11/97
1.6i Berline 4ptes susp. normale	XU5JP	03/11/97-29/03/98
1.6i Break Bonne route /Route inégale	XU5JP	-02/11/97
1.8i /16v. Berline 4ptes	XU7JB/JP/JP4	-02/11/97
1.8i /16v. Berline 4ptes sans susp. variable Route inégale	XU7JB/JP/JP4	-02/11/97
1.8i /16v. Berline susp. renforcée	XU7JP/JP4	03/11/97-29/03/98
1.8i /16v. Berline 4ptes susp. normale	XU7JB/JP/JP4	03/11/97-29/03/98
1.8i /16v. Break Bonne route /Route inégale	XU7JB/JP/JP4	-02/11/97
1.8i /16v. Break susp. normale /renforcée	XU7JB XU7JP4	03/11/97-29/03/98
1.9 TD Berline 4ptes /sans susp. variable Route inégale	XUD9TE/SD	-02/11/97
1.9 TD Berline 4ptes susp. normale	XUD9TE	03/11/97-29/03/98
1.9 TD Break Bonne route /Route inégale	XUD9TE/SD	-02/11/97
1.9 TD Break susp. normale	XUD9TE	-03/99
1.9 TD Break susp. renforcée	XUD9TE	03/11/97-03/99
1.9 TD SD Berline susp. renforcée / 4ptes susp. normale	XUD9SD	03/11/97-29/03/98
1.9 TD SD Break susp. normale	XUD9SD	03/11/97-29/03/98
2.0i 16v. Berline 4ptes susp. normale	XU10J4R	03/11/97-29/03/98
2.0i 16v. Berline susp. renforcée	XU10J4R	-03/99
2.0i 16v. Break susp. normale	XU10J4R	
2.0i 16v. Break susp. renforcée	XU10J4R	-02/04/00
2.0i 16v. Berline susp. normale /susp. renforcée	EW10J4 XU10J4R	-02/04/00
2.0i 16v. Berline 4ptes	EW10J4 XU10J4R	-02/11/97
2.0i 16v. Berline 4ptes sans susp. variable Route inégale	EW10J4 XU10J4R	-02/11/97
2.0i 16v. Break susp. normale /susp. renforcée	EW10J4	-02/04/00
2.0i 16v. Break Bonne route /Route inégale	EW10J4 XU10J4R	-02/11/97
2.0i Turbo Berline Break	XU10J2TE	03/11/97-03/99 ...

... 0335405
OE 503340

Butée de suspension G/D
L/R suspension bush



3 Ø 56 H 109

2.0 HDi 110hp 81kw Berline 4ptes sans FAP susp. normale	DW10ATED BVM	03/11/97-29/03/98
2.0 HDi 110hp 81kw Break sans FAP susp. normale	DW10ATED	-03/99
2.0 HDi Berline susp. normale /renforcée	DW10TD	03/99-
2.0 HDi Break susp. normale /renforcée	DW10TD	03/99-
2.0 HDi Berline sans FAP susp. normale /renforcée	DW10ATED	-02/04/00
2.0 HDi Break sans FAP susp. normale	DW10ATED	03/99-
2.1 TD Berline 4ptes susp. normale	XUD11BTE	-02/11/97
2.1 TD Berline 4ptes sans susp. variable Route inégale	XUD11BTE	-02/11/97
2.1 TD Berline 4ptes susp. normale	XUD11BTE	03/11/97-29/03/98
2.1 TD Berline susp. renforcée	XUD11BTE	-03/99
2.1 TD Break susp. normale	XUD11BTE	-03/99
2.1 TD Break Bonne route /Route inégale	XUD11BTE	-02/11/97
2.2i 16v. Berline susp. normale / renforcée	EW12J4	03/99-
2.2i 16v. Break susp. normale	EW12J4	03/99-
2.2 HDi Break susp. normale	DW12TED4	03/99-
3.0i V6 24v. Berline Break susp. normale	ES9J4	

0335275
OE 503327

Butée de suspension G/D
L/R suspension bush



3 H97

2.0i 16v. Coupé	XU10J4R	-08/97
-----------------	---------	--------

2545265
OE 525426

Protecteur amortisseur G/D
L/R shock absorber protector



4

1.6i	XU5JP	
1.8i /16v.	EW7J4	XU7JB/JP/JP4
1.9 TD	XUD9TE/SD	
2.0i 16v.	EW10J4	XU10J4R
2.0i Turbo	XU10J2TE	
2.0 HDi	DW10TD/ATED	
2.0 HPi	EW10D	
2.1 TD	XUD11BTE	
2.2i 16v.	EW12J4	
2.2 HDi	DW12TED4	
3.0i V6 24v	ES9J4/S	

1005252
OE -

Kit rép. protection amort. G et D
L/R susp. mounting repair kit



Butée H 109

1.6 Berline / Break Bonne route	XU5JP	-02/11/97
1.6 Berline Susp. normale	XU5JP	03/11/97-29/03/98
1.8 Berline Break Bonne route	XU7JB XU7JP	-02/11/97
1.8 Berline Sans susp. variable Route inégale	XU7JB XU7JP	-02/11/97
1.8 Berline Break Susp. normale	XU7JB	03/11/97-29/03/98
1.8 Berline Susp. normale	XU7JP	03/11/97-29/03/98
1.8 Berline Break Susp. renforcée AV AR	XU7JP	03/11/97-29/03/98
1.8i 16v. Berline Break Bonne route	XU7JP4	-02/11/97
1.8i 16v. Berline Sans susp. variable Route inégale	XU7JP4	-02/11/97
1.8i 16v. Berline Break Susp. normale/renforcée AV AR	XU7JP4	03/11/97-29/03/98
1.9 TD SD Berline Sans susp. variable Route inégale	XUD9SD	-02/11/97
1.9 TD SD Berline Susp. renforcée AV AR	XUD9SD	03/11/97-29/03/98
1.9 TD SD Berline Break Bonne route	XUD9SD	-02/11/97
1.9 TD SD Berline Break Susp. normale	XUD9SD	03/11/97-29/03/98
1.9 TD Berline Sans susp. variable Route inégale	XUD9TE	-02/11/97
1.9 TD Berline Break Bonne route	XUD9TE	-02/11/97
1.9 TD Berline Break Susp. normale /renforcée AV AR	XUD9TE	03/11/97-03/99
2.0i 16v. Berline Susp. normale /renforcée AV AR	EW10J4	03/99-02/04/00
2.0i 16v. Break Susp. normale	EW10J4	03/99-02/04/00
2.0 Turbo Berline Sans susp. variable Route inégale	XU10J2TE	-02/11/97
2.0 Turbo Berline Susp. renforcée AV AR	XU10J2TE	03/11/97-03/99
2.0 Turbo Berline Break Bonne route	XU10J2TE	-02/11/97
2.0 Turbo Berline Break Susp. normale	XU10J2TE	03/11/97-03/99
2.0i 16v. Berline Sans susp. variable Route inégale	XU10J4R	-02/11/97
2.0i 16v. Berline Susp. normale /renforcée AV AR	XU10J4R	03/99-02/04/00
2.0i 16v. Berline Break Bonne route	XU10J4R	-02/11/97
2.0i 16v. Berline Break Susp. normale /renforcée AV AR	XU10J4R	03/11/97-03/99
2.0i 16v. Break Susp. normale	XU10J4R	03/99-
2.0 HDi Berline Susp. normale /renforcée AV AR	DW10ATED	03/99-02/04/00
2.0 HDi Berline Break sans FAP Susp. normale	DW10ATED	03/11/97-03/99
2.0 HDi Break sans FAP Susp. normale	DW10ATED	03/99-
2.0 HDi Berline Susp. normale /renforcée AV AR	DW10TD	03/99-
2.0 HDi Break Susp. normale	DW10TD	03/99-
2.1 TD Berline Sans susp. variable Route inégale	XUD11BTE	-02/11/97
2.1 TD Berline Break Bonne route	XUD11BTE	-02/11/97
2.1 TD Berline Break Susp. normale	XUD11BTE	03/11/97-03/99
2.1 TD Berline Susp. renforcée AV AR	XUD11BTE	03/11/97-03/99
2.2i 16v. Berline Susp. normale /renforcée AV AR	EW12J4	03/99-
2.2i 16v. Break Susp. normale	EW12J4	03/99-
2.2 HDi Break Susp. normale	DW12TED4	03/99-
3.0i V6 Berline Sans susp. variable Route inégale	ES9J4	-02/11/97
3.0i V6 Berline Break Bonne route	ES9J4	-02/11/97
3.0i V6 Berline Break Susp. normale	ES9J4	03/11/97
3.0i V6 24v. Berline Break Susp. normale	ES9J4S	03/99-



Barre stabilisatrice
 Stabilizer bar
 Barra estabilizadora
 Drażek stabilizatora
 стабилизатор поперечной устойчивости

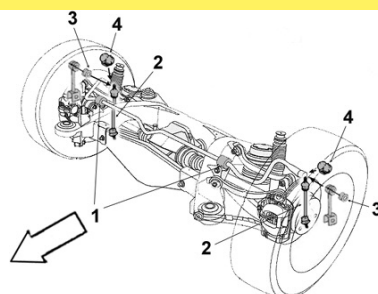

1785385
 OE 517838

Biellette barre stab. AR
 Rear stabilizer bar stub axle



2	1.6i	XU5JP	
	1.8i /16v.	XU7JB/JP/JP4	EW7J4
	1.9 TD	XUD9TE/SD	
	2.0i 16v.	EW10J4	XU10J4R
	2.0i Turbo	XU10J2TE	
	2.0 HDi	DW10TD/ATED	
	2.0 HPi	EW10D	
	2.1 TD	XUD11BTE	
	2.2i 16v.	EW12J4	
	2.2 HDi	DW12TED4	
	3.0i V6 24v.	ES9J4/S	

1725425
 OE 517242

Palier de barre milieu TR AR
 Rear axle middle bar main bearing



1	Ø21		
	1.6i Berline	XU5JP	
	1.8i Berline	XU7JP	11/97-
	1.8i Break	XU7JP	03/11/97-
	1.8i Break	XU7JB	
	1.8i 16v. Berline	niveau 1/1+2	XU7JP4
	1.8i 16v. Berline	niveau 3	XU7JP4
			-02/11/97
	1.8i 16v. Break	XU7JP4	
	1.8i Berline	XU7JB	
	1.9 TD SD Berline	XUD9SD	

1725435
 OE 517243

Palier de barre milieu TR AR
 Rear axle middle bar main bearing



1	Ø22		
	1.8i 16v. Berline Break	EW7J4	
	1.8i Break	XU7JP	-02/11/97
	1.8i 16v. / GPL Berline	niveau 3	XU7JP4
	1.9 TD SD Break	XUD9SD	
	1.9 TD Berline Break	XUD9TE	
	2.0i 16v. Berline Break Coupé	EW10J4	
	2.0i Turbo Berline Break	XU10J2TE	
	2.0i 16v. Berline Break Coupé	XU10J4R	
	2.0 HDi Berline Break sans FAP	DW10ATED	
	2.0 HDi Berline Break	DW10TD	
	2.0 HPi Berline Break	EW10D	
	2.1 TD Berline Break	XUD11BTE	
	2.2i 16v. Berline Break Coupé	EW12J4	
	2.2 HDi Berline FAP	DW12TED4	03/99-
	2.2 HDi Break	DW12TED4	
	3.0i V6 Berline	ES9J4/S	03/11/97-
	3.0i V6 Break	ES9J4/S	03/99-



Eléments SUSPENSION
 Suspension parts
 Elementos suspensión
 Elementy zawieszenie
 Элементы подвески

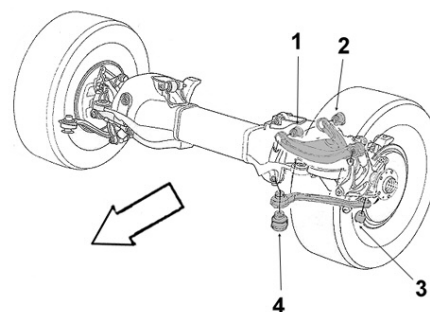

1315785
 OE 513178

Articulation sup.
 Upper bush



3	Ø int.12 Ø ext.27 coll.41 long. tube int.40 ext.24.5 ep. coll.8		
	1.6i	XU5JP	2.1 TD
	1.8i /16v.	XU7JB/JP/JP4	EW7J4
	1.9 TD	XUD9TE/SD	2.2i 16v.
	2.0i 16v.	EW10J4	EW12J4
	2.0i Turbo	XU10J2TE	2.2 HDi
	2.0 HDi	DW10TD/ATED	DW12TED4
	2.0 HPi	EW10D	3.0i V6
			ES9J4/S

1315805

Articulation AR inf.

OE 513180

Rear lower bush



4 Ø int.14 Ø ext.32 long. tube int.60 ext.48

1.6i	XU5JP	2.0 HPi	EW10D
1.8i /16v.	XU7JB/JP/JP4 EW7J4	2.1 TD	XUD11BTE
1.9 TD	XUD9TE/SD	2.2i 16v.	EW12J4
2.0i 16v.	EW10J4 XU10J4R	2.2 HDi	DW12TED4
2.0i Turbo	XU10J2TE	3.0i V6	ES9J4/S
2.0 HDi	DW10TD/ATED		

1315995

Articulation support bras

OE 513199

Arm bush mounting



4 Ø int.14 Ø ext.55 long. tube int.65 ext.46

1.6i	XU5JP	2.0 HDi	DW10TD/ATED
1.8i /16v.	XU7JB/JP/JP4	2.0 HPi	EW10D
1.8i 16v.	EW7J4	2.1 TD	XUD11BTE
1.9 TD	XUD9TE/SD	2.2i 16v.	EW12J4
2.0i 16v.	EW10J4 XU10J4R	2.2 HDi	DW12TED4
2.0i Turbo	XU10J2TE	3.0i V6	ES9J4/S

03/99-



Support d'amortisseur

Suspension mounting
Soporte amortiguador
Poduszka amortyzatora
Опора амортизатора

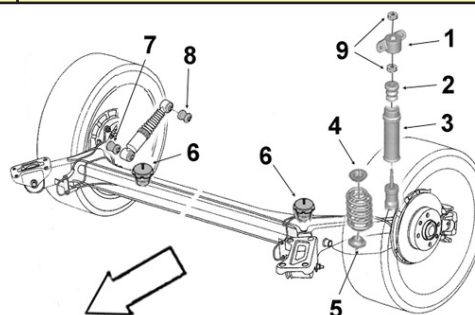

1615205

Support suspension G/D

Part/oe 516120

L/R suspension mounting



1 Ø int.11 Ø ext.60 coll.69 long. tube int.24 ext.26 ep. coll.9

1.6i Berline Break	sans susp. variable	bonne route	XU5JP	-03/99
1.6i Berline Break	Route inégale		XU5JP	-03/99
1.6i Berline Break	susp. normale	sans susp. variable	XU5JP	03/99-
1.6i Berline Break	susp. renforcée		XU5JP	03/99-
1.8i 16v. Berline Break	susp. normale	sans susp. variable	EW7J4	03/99-
1.8i 16v. Berline Break	susp. renforcée		EW7J4	03/99-
1.8i 16v. Berline Break	sans susp. variable	bonne route	XU7JB/JP/JP4	-03/99
1.8i 16v. Berline Break	Route inégale		XU7JB/JP/JP4	-03/99
1.8i 16v. Berline Break	susp. normale	sans susp. variable	XU7JB/JP/JP4	03/99-
1.8i 16v. Berline Break	susp. renforcée		XU7JB/JP/JP4	03/99-
1.9 TD Berline Break	Bonne route	sans susp. variable	XUD9TE/SD	
1.9 TD Berline Break	Route inégale		XUD9TE/SD	-03/99
1.9 TD Berline Break	susp. renforcée		XUD9TE/SD	03/99-
2.0 Turbo Berline Break	sans susp. variable	bonne route	XU10J2TE	-03/99
2.0 Turbo Berline Break	Route inégale		XU10J2TE	-03/99
2.0i 16v. Berline Break	sans susp. variable	bonne route	XU10J4R	-03/99
2.0i 16v. Berline Break	Route inégale		XU10J4R	-03/99
2.0i 16v. Berline Break	susp. normale	sans susp. variable	XU10J4R	03/99-
2.0i 16v. Berline Break	susp. renforcée		XU10J4R	03/99-
2.0i 16v. Berline Break	susp. normale	sans susp. variable	EW10J4	03/99-
2.0i 16v. Berline Break	susp. renforcée		EW10J4	03/99-
2.0 HDi Berline Break	Bonne route	sans susp. variable	DW10TD/ATED	
2.0 HDi Berline Break	Route inégale		DW10TD/ATED	-03/99
2.0 HDi Berline Break	susp. renforcée		DW10TD/ATED	03/99-
2.0 HPi Berline Break	susp. normale	sans susp. variable	EW10D	03/99-
2.0 HPI Berline Break	susp. renforcée		EW10D	03/99-
2.1 TD Berline Break	Bonne route	sans susp. variable	XUD11BTE	
2.1 TD Berline Break	Route inégale		XUD11BTE	-03/99
2.2i 16v. Berline Break	susp. normale	sans susp. variable	EW12J4	03/99-
2.2i 16v. Berline Break	susp. renforcée		EW12J4	03/99-
2.2 HDi Berline Break	Bonne route	sans susp. variable	DW12TED4	
2.2 HDi Berline Break	susp. renforcée		DW12TED4	03/99-
3.0i V6 Berline Break	sans susp. variable	bonne route	ES9J4/S	-03/99
3.0i V6 Berline Break	Route inégale		ES9J4/S	-03/99
3.0i V6 Berline Break	susp. normale	sans susp. variable	ES9J4/S	03/99-
3.0i V6 Berline Break	susp. renforcée		ES9J4/S	03/99-



Support d'amortisseur
 Suspension mounting
 Soporte amortiguador
 Poduszka amortyzatora
 Опора амортизатора

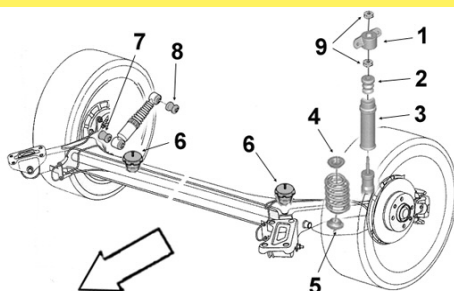

1615235 Support suspension G/D

Part/oe 516123 L/R suspension mounting



1 Ø int.11 Ø ext.60 coll.69 long. tube int.24 ext.26 ep. coll.9

Coupé sans susp. variable

2.0i 16v.	EW10J4	XU10J4R
2.2i 16v.	EW12J4	
2.2 HDi	DW12TED4	
3.0i V6	ES9J4/S	

1665575 Butée attaque

OE 516657 Bushing



2	1.6i Berline Break sans susp. variable	XU5JP	-03/99
	1.6i Berline Break susp. normale avec susp. variable	XU5JP	04/99-
	1.6i Berline Break susp. renforcée AV AR	XU5JP	04/99-
	1.8i 16v. Berline Break sans susp. variable	XU7JB/JP/JP4	-03/99
	1.8i 16v. Berline Break susp. normale sans susp. variable	XU7JB/JP/JP4	04/99-
	1.8i 16v. Berline Break susp. renforcée AV AR	XU7JB/JP/JP4	04/99-
	1.8i 16v. Berline Break susp. normale sans susp. variable	EW7J4	04/99-
	1.8i 16v. Berline Break susp. renforcée AV AR	EW7J4	04/99-
	1.9 TD Berline Break sans susp. variable	XUD9TE/SD	-03/99
	1.9 TD Berline Break susp. normale sans susp. variable	XUD9TE/SD	04/99-
	1.9 TD Berline Break susp. renforcée AV AR	XUD9TE/SD	04/99-
	2.0i Turbo Berline Break sans susp. variable	XU10J2TE	-03/99
	2.0i 16v. Berline Break sans susp. variable	XU10J4R	-03/99
	2.0i 16v. Berline Break susp. normale sans susp. variable	XU10J4R	04/99-
	2.0i 16v. Berline Break susp. renforcée AV AR	XU10J4R	04/99-
	2.0i 16v. Coupé sans susp. variable	XU10J4R	
	2.0i 16v. Berline Break susp. normale sans susp. variable	EW10J4	04/99-
	2.0i 16v. Berline Break susp. renforcée AV AR	EW10J4	04/99-
	2.0i 16v. Coupé sans susp. variable	EW10J4	
	2.0 HDi Berline Break sans susp. variable	DW10TD/ATED	-03/99
	2.0 HDi Berline Break susp. normale sans susp. variable	DW10TD/ATED	04/99-
	2.0 HDi Berline Break susp. renforcée AV AR	DW10TD/ATED	04/99-
	2.0 HPi Berline Break susp. normale sans susp. variable	EW10D	04/99-
	2.0 HPi Berline Break susp. renforcée AV AR	EW10D	04/99-
	2.1 TD Berline Break sans susp. variable	XUD11BTE	-03/99
	2.2i 16v. Berline Break susp. normale sans susp. variable	EW12J4	04/99-
	2.2i 16v. Berline Break susp. renforcée AV AR	EW12J4	04/99-
	2.2i 16v. Coupé sans susp. variable	EW12J4	
	2.2 HDi Berline Break susp. normale sans susp. variable	DW12TED4	04/99-
	2.2 HDi Berline Break susp. renforcée AV AR	DW12TED4	04/99-
	2.2 HDi Coupé sans susp. variable	DW12TED4	
	3.0i V6 24v. Berline Break Coupé sans susp. variable	ES9J4/S	-03/99
	3.0i V6 24v. Berline Break Coupé susp. normale sans susp. variable	ES9J4/S	04/99-
	3.0i V6 24v. Berline Break Coupé susp. renforcée AV AR	ES9J4/S	04/99-

1665585

OE 516658

Butée attaque

Bushing



2	1.6i Berline Break susp. variable bonne route	XU5JP	-03/99
	1.6i Berline Break susp. normale avec susp. variable	XU5JP	04/99-
	1.8i 16v. Berline Break susp. normale avec susp. variable	EW7J4	04/99-
	1.8i 16v. Berline Break susp. variable bonne route	XU7JB/JP/JP4	-03/99
	1.8i 16v. Berline Break susp. normale avec susp. variable	XU7JB/JP/JP4	04/99-
	1.9 TD Berline Break susp. variable bonne route	XUD9TE/SD	-03/99
	1.9 TD Berline Break susp. normale avec susp. variable	XUD9TE/SD	04/99-
	2.0i 16v. Berline Break susp. variable bonne route	XU10J4R	-03/99
	2.0i 16v. Berline Break susp. normale avec susp. variable	XU10J4R	04/99-
	2.0i 16v. Coupé susp. variable	XU10J4R	
	2.0i 16v. Berline Break susp. normale avec susp. variable	EW10J4	04/99-
	2.0i 16v. Coupé susp. variable	EW10J4	
	2.0 HDi Berline Break susp. variable bonne route	DW10TD/ATED	-03/99
	2.0 HDi Berline Break susp. normale avec susp. variable	DW10TD/ATED	04/99-
	2.0 HPi Berline Break susp. normale avec susp. variable	EW10D	04/99-
	2.1 TD Berline Break susp. variable bonne route	XUD11BTE	-03/99
	2.2i 16v. Berline Break susp. normale avec susp. variable	EW12J4	04/99-
	2.2 HDi Berline Break susp. normale avec susp. variable	DW12TED4	04/99-
	2.2 HDi Coupé susp. variable	DW12TED4	
	3.0i V6 24v. Berline Break susp. variable bonne route	ES9J4	-03/99
3.0i V6 24v. Berline Break susp. normale avec susp. variable	ES9J4S	04/99-	

Eléments TRAIN ARRIERE

Rear axle parts

Tren TRAS

Elementy zawieszenia tylnego

элементы задней оси.



1525595

OE 515259

Art. traverse sup.

Upper cross bar bush



Ø int.12 Ø ext.40 coll.51 long. tube int.20 ext.12 ep. coll.3

1.6i	XU5JP	
1.8i /16v.	XU7JB/JP/JP4	EW7J4
1.9 TD	XUD9TE/SD	
2.0i 16v.	EW10J4 XU10J4R	
2.0 HDi	DW10TD/ATED	
2.0 HPi	EW10D	
2.1 TD	XUD11BTE	
2.2i 16v.	EW12J4	
2.2 HDi	DW12TED4	

6403353

OE 364035

Art. inf. de fusée

Lower swivel bush



Ø int.14.2 Ø ext.45 long. tube int.57 ext.24

1.6i Berline Break	XU5JP	-02/11/97
1.8i 16v. Berline Break	XU7JB/JP/JP4	-02/11/97
1.9 TD Berline Break	XUD9TE/SD	-02/11/97
2.0i 16v. Berline Break	XU10J	-02/11/97
2.0 HDi Berline Break	DW10TD/ATED	-02/11/97
2.1 TD Berline Break	XUD11BTE	-02/11/97
3.0i V6 24v. Berline Break	ES9J4	-02/11/97

6403413

OE 364041

Art. inf. de fusée

Lower swivel bush



Ø int.14.2 Ø ext.45 long. tube int.57 ext.26

1.6i	XU5JP	03/99-
1.6i Berline Break	XU5JP	03/11/97-03/99
1.8i /16v. Berline Break	XU7JB/JP/JP4	03/11/97-03/99
1.8i 16v.	XU7JB/JP/JP4 EW7J4	03/99-
1.9 TD	XUD9TE/SD	03/11/97-
2.0i 16v.	EW10J4 XU10J4R	03/11/97-
2.0 HDi	DW10TD/ATED	03/11/97-
2.0 HPi	EW10D	03/99-
2.1 TD	XUD11BTE	03/11/97-
2.2i 16v.	EW12J4	03/99-
2.2 HDi	DW12TED4	03/11/97-
3.0i V6 24v.	ES9J4/S	03/11/97-

407 ...

Eléments DIRECTION
 Steering parts
 Elementos Direcciones
 Elementy układ kierowniczy
 Элементы рулевой системы

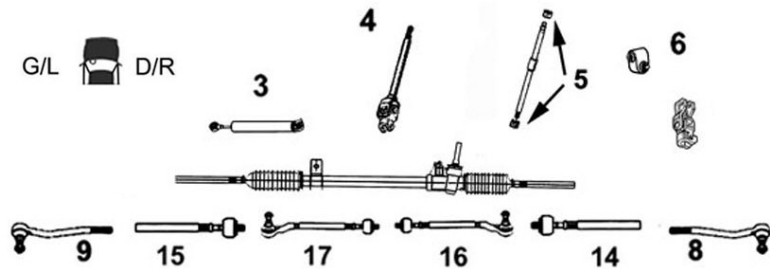

8123E73 **Axe de bielle G/D**
 OE 3812E7 *L/R axial joint*



14 Côté dir. M16x1.5 Côté rot. M14x1.5 long 105 mm

15	1.6 HDi	DV6TED4	
	1.8i 16v.	EW7J4	EW7A
	2.0i 16v.	EW10J4	EW10A
	2.0 HDi	DW10BTED4	
	2.0 HDi FAP	DW10CTED4	
	2.2i 16v.	EW12J4	
	2.2 HDi FAP	DW12BTED4	
	2.7 HDi	DT17TED4	
	3.0i V6	ES9A	
	3.0 HDi	DT20C	

8173585 **Rotule de direction G**
 OE 381758 *Left tie rod end*



9 M14 x 1.5

1.6 HDi Berline Break	DV6TED4	-13/11/05
1.8i 16v. Berline Break	EW7A/J4	-13/11/05
2.0i 16v. Berline Break	EW10A/J4	-13/11/05
2.0 HDi Berline Break	DW10BTED4	-13/11/05
2.0 HDi Coupé	DW10BTED4	-09/11/05
2.0 HDi FAP Berline Break	DW10CTED4	-13/11/05
2.0 HDi FAP Coupé	DW10CTED4	-09/11/05
2.2i 16v. Berline Break	EW12J4	-13/11/05
2.2i 16v. Coupé	EW12J4	-09/11/05
2.2 HDi FAP Berline Break	DW12BTED4	-13/11/05
2.7 HDi Berline Break	DT17TED4	-13/11/05
2.7 HDi Coupé	DT17TED4	-09/11/05
3.0i V6 Berline Break	ES9A	-13/11/05
3.0i V6 Coupé	ES9A	-09/11/05
3.0 HDi Coupé	DT20C	-09/11/05

8173573 **Rotule de direction D**
 OE 381757 *Right tie rod end*



8 M14 x 1.5

1.6 HDi Berline Break	DV6TED4	-13/11/05
1.8i 16v. Berline Break	EW7A/J4	-13/11/05
2.0i 16v. Berline Break	EW10A/J4	-13/11/05
2.0 HDi Berline Break	DW10BTED4	-13/11/05
2.0 HDi Coupé	DW10BTED4	-09/11/05
2.0 HDi FAP Berline Break	DW10CTED4	-13/11/05
2.0 HDi FAP Coupé	DW10CTED4	-09/11/05
2.2i 16v. Berline Break	EW12J4	-13/11/05
2.2i 16v. Coupé	EW12J4	-09/11/05
2.2 HDi FAP Berline Break	DW12BTED4	-13/11/05
2.7 HDi Berline Break	DT17TED4	-13/11/05
2.7 HDi Coupé	DT17TED4	-09/11/05
3.0i V6 Berline Break	ES9A	-13/11/05
3.0i V6 Coupé	ES9A	-09/11/05
3.0 HDi Coupé	DT20C	-09/11/05

7670005

Rotule de direction G

OE 381765

Left tie rod end



9 M14 x 1.5

1.6 HDi Berline Break	DV6TED4	14/11/05-
1.8i 16v. Berline Break	EW7J4	14/11/05-
1.8i 16v. Berline Break	EW7A	14/11/05-
2.0i 16v. Berline Break	EW10J4	14/11/05-
2.0i 16v. Berline Break	EW10A	14/11/05-
2.0 HDi Berline Break	DW10BTED4	14/11/05-
2.0 HDi Coupé	DW10BTED4	10/11/05-
2.0 HDi FAP Berline Break	DW10CTED4	14/11/05-
2.0 HDi FAP Coupé	DW10CTED4	10/11/05-
2.2i 16v. Berline Break	EW12J4	14/11/05-
2.2i 16v. Coupé	EW12J4	10/11/05-
2.2 HDi FAP Berline Break	DW12BTED4	14/11/05-
2.7 HDi Berline Break	DT17TED4	14/11/05-
2.7 HDi Coupé	DT17TED4	10/11/05-
3.0i V6 Berline Break	ES9A	14/11/05-
3.0i V6 Coupé	ES9A	10/11/05-
3.0 HDi Coupé	DT20C	10/11/05-

7670006

Rotule de direction D

OE 381766

Right tie rod end



8 M14 x 1.5

1.6 HDi Berline Break	DV6TED4	14/11/05-
1.8i 16v. Berline Break	EW7J4	14/11/05-
1.8i 16v. Berline Break	EW7A	14/11/05-
2.0i 16v. Berline Break	EW10J4	14/11/05-
2.0i 16v. Berline Break	EW10A	14/11/05-
2.0 HDi Berline Break	DW10BTED4	14/11/05-
2.0 HDi Coupé	DW10BTED4	10/11/05-
2.0 HDi FAP Berline Break	DW10CTED4	14/11/05-
2.0 HDi FAP Coupé	DW10CTED4	10/11/05-
2.2i 16v. Berline Break	EW12J4	14/11/05-
2.2i 16v. Coupé	EW12J4	10/11/05-
2.2 HDi FAP Berline Break	DW12BTED4	14/11/05-
2.7 HDi Berline Break	DT17TED4	14/11/05-
2.7 HDi Coupé	DT17TED4	10/11/05-
3.0i V6 Berline Break	ES9A	14/11/05-
3.0i V6 Coupé	ES9A	10/11/05-
3.0 HDi Coupé	DT20C	10/11/05-



Barre stabilisatrice

Stabilizer bar

Barra estabilizadora

Drażek stabilizatora

стабилизатор поперечной устойчивости

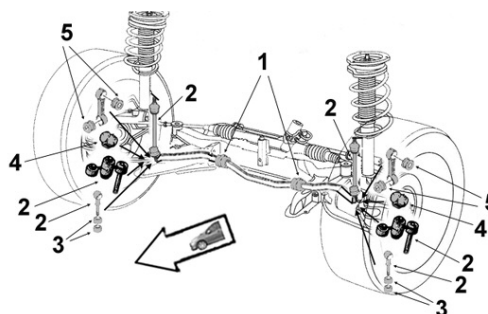

2300011

Biellette barre stab. G

OE 508752

Left stabilizer bar stub axle



2

1.6 HDi	DV6TED4
1.8i 16v.	EW7A/J4
2.0i 16v.	EW10A /J4
2.0 HDi	DW10BTED4
2.0 HDi FAP	DW10CTED4
2.2i 16v.	EW12J4
2.2 HDi FAP	DW12BTED4
2.7 HDi	DT17TED4
3.0i V6	ES9A
3.0 HDi	DT20

2300009

Biellette barre stab. D

OE 508753

Right stabilizer bar stub axle



2

1.6 HDi	DV6TED4
1.8i 16v.	EW7A/J4
2.0i 16v.	EW10A /J4
2.0 HDi	DW10BTED4
2.0 HDi FAP	DW10CTED4
2.2i 16v.	EW12J4
2.2 HDi FAP	DW12BTED4
2.7 HDi	DT17TED4
3.0i V6	ES9A
3.0 HDi	DT20



Barre stabilisatrice
 Stabilizer bar
 Barra estabilizadora
 Drażek stabilizatora
 стабилизатор поперечной устойчивости

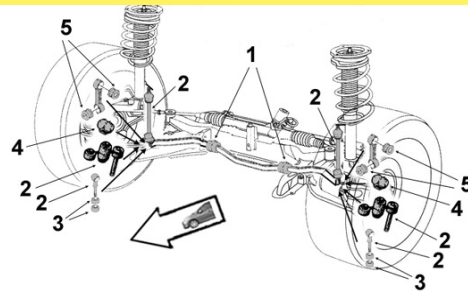

2300023
 OE 509498

Palier de barre milieu
Middle bar main bearing



- 1 Barre Ø 23.5**
- | | |
|-------------|-----------------|
| 1.6 HDi | DV6TED4 |
| 1.8i 16v. | EW7A/J4 |
| 2.0i 16v. | EW10A |
| 2.0 HDi FAP | DW10BTED4/CTED4 |
| 2.2i 16v. | EW12J4 |
| 2.2 HDi FAP | DW12BTED4 |
| 2.7 HDi | DT17TED4 |
| 3.0i V6. | ES9A |
| 3.0 HDi | DT20 |

2300004
 OE 509499

Palier de barre milieu
Middle bar main bearing



- 1 Barre Ø 24**
- | | |
|-------------|-----------|
| 1.6 HDi | DV6TED4 |
| 1.8i 16v. | EW7A/J4 |
| 2.0i 16v. | EW10A /J4 |
| 2.0 HDi | DW10BTED4 |
| 2.0 HDi FAP | DW10CTED4 |
| 2.2i 16v. | EW12J4 |
| 2.2 HDi FAP | DW12BTED4 |
| 2.7 HDi | DT17TED4 |
| 3.0i V6 | ES9A |
| 3.0 HDi | DT20 |

2300024
 OE 5094A0

Palier de barre milieu
Middle bar main bearing



- 1 Barre Ø 24.5**
- | | |
|--------------|-----------|
| 1.6 HDi | DV6TED4 |
| 1.8i 16v. | EW7A/J4 |
| 2.0i 16v. | EW10A /J4 |
| 2.0 HDi /FAP | DW10BTED4 |
| 2.0 HDi FAP | DW10CTED4 |
| 2.2i 16v. | EW12J4 |
| 2.2 HDi FAP | DW12BTED4 |
| 2.7 HDi | DT17TED4 |
| 3.0i V6. | ES9A |
| 3.0 HDi | DT20 |

2300008
 OE 5094A1

Palier de barre milieu
Middle bar main bearing



- 1 Barre Ø 25**
- | | |
|-------------|-----------|
| 1.6 HDi | DV6TED4 |
| 1.8i 16v. | EW7J4 |
| 2.0i 16v. | EW10A |
| 2.0 HDi | DW10BTED4 |
| 2.0 HDi FAP | DW10CTED4 |
| 2.2i 16v. | EW12J4 |
| 2.2 HDi FAP | DW12BTED4 |
| 2.7 HDi | DT17TED4 |
| 3.0i V6. | ES9A |
| 3.0 HDi | DT20 |



Eléments SUSPENSION
 Suspension parts
 Elementos suspensión
 Elementy zawieszenie
 Элементы подвески

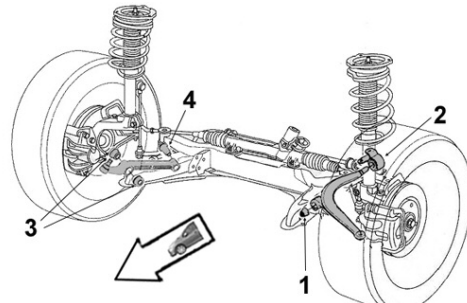

2250019
 OE 3523CA

Art. bras sup.
Upper arm bush



- 1** Ø int.10.3 Ø ext. 32 coll. 39
2 long. tube int. 34 ext. 22 ep. coll.6.2
- TT /all models

2250014
 OE 3523AZ

Art. sup. support pivot
pivot mounting upper bush



- Ø int. 12 Ø ext. 33 coll. 40
 long. tube int. 82 ext. 21.5 ep. coll.6.3
- | | |
|-------------|-----------|
| 1.6 HDi | DV6TED4 |
| 1.8i 16v. | EW7A/J4 |
| 2.0i 16v. | EW10A/J4 |
| 2.0 HDi | DW10BTED4 |
| 2.0 HDi FAP | DW10CTED4 |
| 2.2i 16v. | EW12J4 |
| 2.2 HDi FAP | DW12BTED4 |
| 2.7 HDi | DT17TED4 |
| 3.0i V6 | ES9A |
| 3.0 HDi | DT20C |

2250002
 OE 3523AQ

Articulation AV triangle inf.
Lower front track control arm front bush



- 1** Ø int.14 Ø ext.56 long. tube int.32 ext 50
- | | |
|-------------|-----------|
| 1.6 HDi | DV6TED4 |
| 1.8i 16v. | EW7A/J4 |
| 2.0i 16v. | EW10A /J4 |
| 2.0 HDi | DW10BTED4 |
| 2.0 HDi FAP | DW10CTED4 |
| 2.2i 16v. | EW12J4 |
| 2.2 HDi FAP | DW12BTED4 |
| 2.7 HDi | DT17TED4 |
| 3.0i V6. | ES9A |
| 3.0 HDi | DT20 |

2250008

Articulation AR triangle inf.

Part/oe 3520Q1

Track control arm rear bush



2 Ø int. 20 Sans susp. variable

1.6 HDi		DV6TED4	-01/03/09
1.6 HDi	Berceau alu avec cadre	DV6TED4	02/03/09-
1.8i 16v.		EW7A/J4	-01/03/09
1.8i 16v.	Berceau alu avec cadre	EW7A/J4	02/03/09-
2.0i 16v.		EW10A /J4	-01/03/09
2.0i 16v.	Berceau alu avec cadre	EW10A/J4	02/03/09-
2.0 HDi		DW10BTED4	-01/03/09
2.0 HDi	Berceau alu avec cadre	DW10BTED4	02/03/09-
2.0 HDi FAP		DW10CTED4	-01/03/09
2.0 HDi FAP	Berceau alu avec cadre	DW10CTED4	02/03/09-
2.2i 16v.		EW12J4	-01/03/09
2.2i 16v.	Berceau alu avec cadre	EW12J4	02/03/09-
2.2 HDi FAP		DW12BTED4	-01/03/09
2.2 HDi FAP	Berceau alu avec cadre	DW12BTED4	02/03/09-
2.7 HDi		DT17TED4	-01/03/09
2.7 HDi	Berceau alu avec cadre	DT17TED4	02/03/09-
3.0i V6.		ES9A	-01/03/09
3.0i V6.	Berceau alu avec cadre	ES9A	02/03/09-
3.0 HDi		DT20	-01/03/09
3.0 HDi	Berceau alu avec cadre	DT20	02/03/09-

2250013

Art. inf. support pivot

Part/oe 365604

lower bush pivot mounting



Ø int. 12 Ø ext. 40 coll. 45.4 long. tube int. 38 ext. 27 ep. coll.2.3

1.6 HDi	DV6TED4
1.8i 16v.	EW7A/J4
2.0i 16v.	EW10A/J4
2.0 HDi	DW10BTED4
2.0 HDi FAP	DW10CTED4
2.2i 16v.	EW12J4
2.2 HDi FAP	DW12BTED4
2.7 HDi	DT17TED4
3.0i V6	ES9A
3.0 HDi	DT20C

Bras & Triangle de suspension

Control arm
Brazo y triángulo
Wahacz
Рычаг подвески

G/L D/R

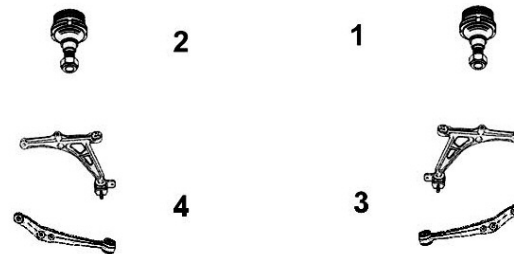

5203N63

Triangle de susp. inf. G

OE 3520S8

Lower left track control arm



4 Sans rotule Without ball joint Sans susp. variable

1.6 HDi		DV6TED4	-01/03/09
1.6 HDi	Berceau alu avec cadre	DV6TED4	02/03/09-
1.8i 16v.		EW7A/J4	-01/03/09
1.8i 16v.	Berceau alu avec cadre	EW7A/J4	02/03/09-
2.0i 16v.		EW10A/J4	-01/03/09
2.0i 16v.	Berceau alu avec cadre	EW10A/J4	02/03/09-
2.0 HDi		DW10BTED4	-01/03/09
2.0 HDi	Berceau alu avec cadre	DW10BTED4	02/03/09-
2.0 HDi FAP		DW10CTED4	-01/03/09
2.0 HDi FAP	Berceau alu avec cadre	DW10CTED4	02/03/09-
2.2i 16v.		EW12J4	-01/03/09
2.2i 16v.	Berceau alu avec cadre	EW12J4	02/03/09-
2.2 HDi FAP		DW12BTED4	-01/03/09
2.2 HDi FAP	Berceau alu avec cadre	DW12BTED4	02/03/09-
2.7 HDi		DT17TED4	-01/03/09
2.7 HDi	Berceau alu avec cadre	DT17TED4	02/03/09-
3.0i V6		ES9A	-01/03/09
3.0i V6	Berceau alu avec cadre	ES9A	02/03/09-
3.0 HDi		DT20C	-01/03/09
3.0 HDi	Berceau alu avec cadre	DT20C	02/03/09-

Bras & Triangle de suspension

Control arm
Brazo y triángulo
Wahacz
Рычаг подвески

G/L  D/R

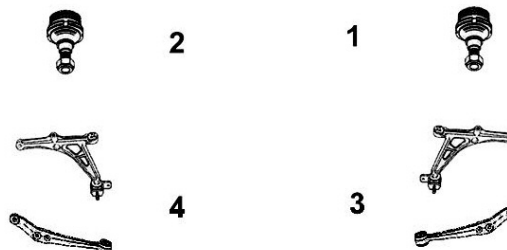

5213J63

OE 3521P9

Triangle de susp. inf. D

Lower right track control arm



3 Sans rotule Without ball joint Sans susp. variable

1.6 HDi		DV6TED4	-01/03/09
1.6 HDi	Berceau alu avec cadre	DV6TED4	02/03/09-
1.8i 16v.		EW7A/J4	-01/03/09
1.8i 16v.	Berceau alu avec cadre	EW7A/J4	02/03/09-
2.0i 16v.		EW10A/J4	-01/03/09
2.0i 16v.	Berceau alu avec cadre	EW10A/J4	02/03/09-
2.0 HDi		DW10BTED4	-01/03/09
2.0 HDi	Berceau alu avec cadre	DW10BTED4	02/03/09-
2.0 HDi FAP		DW10CTED4	-01/03/09
2.0 HDi FAP	Berceau alu avec cadre	DW10CTED4	02/03/09-
2.2i 16v.		EW12J4	-01/03/09
2.2i 16v.	Berceau alu avec cadre	EW12J4	02/03/09-
2.2 HDi FAP		DW12BTED4	-01/03/09
2.2 HDi FAP	Berceau alu avec cadre	DW12BTED4	02/03/09-
2.7 HDi		DT17TED4	-01/03/09
2.7 HDi	Berceau alu avec cadre	DT17TED4	02/03/09-
3.0i V6		ES9A	-01/03/09
3.0i V6	Berceau alu avec cadre	ES9A	02/03/09-
3.0 HDi		DT20C	-01/03/09
3.0 HDi	Berceau alu avec cadre	DT20C	02/03/09-

7470033

OE 3520X7

Triangle de susp. inf. G

Lower left track control arm



4 Sans rotule Without tie rod end Sans susp. variable Berceau acier avec cadre

1.6 HDi FAP /SW	02/03/09-
1.8i 16v. /GNV /SW	02/03/09-
2.0i 16v. /ETH /SW	02/03/09-
2.0 HDi /FAP /SW /Coupé	02/03/09-
2.2i 16v. /SW /Coupé	02/03/09-
2.2 HDi FAP /SW	02/03/09-
2.7 HDi FAP /SW /Coupé	02/03/09-
3.0i V6 24v. /SW /Coupé	02/03/09-
3.0 HDi FAP Coupé	02/03/09-

7470032

OE 3521T8

Triangle de susp. inf. D

Lower right track control arm



3 Sans rotule Without tie rod end Sans susp. variable Berceau acier avec cadre

1.6 HDi FAP /SW	02/03/09-
1.8i 16v. /GNV /SW	02/03/09-
2.0i 16v. /ETH /SW	02/03/09-
2.0 HDi /FAP /SW /Coupé	02/03/09-
2.2i 16v. /SW /Coupé	02/03/09-
2.2 HDi FAP /SW	02/03/09-
2.7 HDi FAP /SW /Coupé	02/03/09-
3.0i V6 24v. /SW /Coupé	02/03/09-
3.0 HDi FAP Coupé	02/03/09-

5203N63

OE 3520N6

Triangle de susp. inf. G

Lower left track control arm



4 Sans rotule Without ball joint Susp. variable

1.6 HDi	DV6TED4
1.8i 16v.	EW7A/J4
2.0i 16v.	EW10A/J4
2.0 HDi FAP	DW10CTED4
2.0 HDi	DW10BTED4
2.2i 16v.	EW12J4
2.2 HDi FAP	DW12BTED4
2.7 HDi	DT17TED4
3.0i V6	ES9A
3.0 HDi	DT20C

5213J63

OE 3521J6







Triangle de susp. inf. D

Lower right track control arm

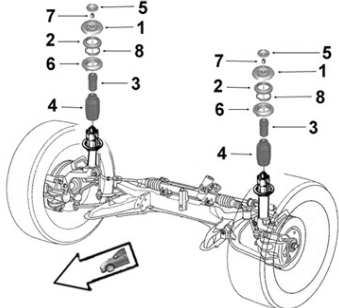

3 Sans rotule Without ball joint Susp. variable

1.6 HDi	DV6TED4
1.8i 16v.	EW7A/J4
2.0i 16v.	EW10A/J4
2.0 HDi FAP	DW10CTED4
2.0 HDi	DW10BTED4
2.2i 16v.	EW12J4
2.2 HDi FAP	DW12BTED4
2.7 HDi	DT17TED4
3.0i V6	ES9A
3.0 HDi	DT20C

6403573 Rotule de susp. sup. G/D					
OE 364074 <i>L/R upper susp. ball joint</i>					
	1 2	1.6 HDi DV6TED4	2.7 HDi DT17TED4		
		1.8i 16v. EW7A/J4	3.0i V6 ES9A		
		2.0i 16v. EW10A/J4	3.0 HDi DT20C		
		2.0 HDi DW10BTED4			
		2.0 HDi FAP DW10CTED4			
		2.2i 16v. EW12J4			
		2.2 HDi FAP DW12BTED4			
6403723 Rotule de susp. inf. G/D					
OE 364072 <i>L/R lower suspension ball joint</i>					
	1 2	1.6 HDi DV6TED4	-03/12/06		
		1.8i 16v. EW7A/J4	-03/12/06		
		2.0i 16v. EW10A/J4	-03/12/06		
		2.0 HDi DW10BTED4	-03/12/06		
		2.0 HDi FAP DW10CTED4	-03/12/06		
		2.2i 16v. EW12J4	-03/12/06		
		2.2 HDi FAP DW12BTED4	-03/12/06		
		2.7 HDi DT17TED4	-03/12/06		
		3.0i V6 ES9A	-03/12/06		
		3.0 HDi DT20C	-03/12/06		
7570003 Rotule de susp. inf. G/D					
OE 364069 <i>L/R lower suspension ball joint</i>					
	1 2	1.6 HDi DV6TED4	04/12/06		
		1.8i 16v. EW7A/J4	04/12/06-		
		2.0i 16v. EW10A	04/12/06-		
		2.0 HDi DW10BTED4	04/12/06-		
		2.0 HDi FAP DW10CTED4	04/12/06-		
		2.2i 16v. EW12J4	04/12/06-		
		2.2 HDi FAP DW12BTED4	04/12/06-		
		2.7 HDi DT17TED4	04/12/06-		
		3.0i V6 ES9A	04/12/06-		
		3.0 HDi DT20C	04/12/06-		
		Support d'amortisseur <i>Suspension mounting</i> <i>Soporte amortiguador</i> <i>Poduszka amortyzatora</i> <i>Опора амортизатора</i>			
2650002 Support suspension G/D					
OE 5038E5 <i>L/R suspension mounting</i>					
	1	1.6 HDi Berline Break	Sans susp. variable	Pneu 205x60x16 V/H	DV6TED4
		1.8i 16v. Berline Break	Sans susp. variable	Pneu 205x60x16 V/H	EW7A/J4
		2.0i 16v. Berline Break	Sans susp. variable	Pneu 205x60x16 V/H	EW10A/J4
		2.0 HDi Berline Break	Sans susp. variable	Pneu 205x60x16 V/H	DW10BTED4
		2.0 HDi FAP		Jante Ø 16 pouces	DW10CTED4
		2.2i HDi Berline Break	Sans susp. variable	Pneu 205x60x16 V/H	EW12J4
		2.2 HDi FAP Berline Break	Sans susp. variable	Pneu 205x60x16 V/H	DW12BTED4
2650003 Support suspension G/D					
OE 5038E6 <i>L/R suspension mounting</i>					
	1	1.6 HDi Berline Break	Sans susp. variable	Pneu 215x55x17 W	DV6TED4
		1.8i 16v. Berline Break	Sans susp. variable	Pneu 215x55x17 W	EW7A/J4
		2.0i 16v. Berline Break	Sans susp. variable	Pneu 215x55x17 W	EW10A/J4
		2.0 HDi Berline Break	Sans susp. variable	Pneu 215x55x17 W	DW10BTED4
		2.0 HDi Coupé	Susp. normale	Sans susp. variable	DW10BTED4
		2.0 HDi FAP Berline Break	sauf monte pneu 16 pouces		DW10CTED4
		2.0 HDi FAP Coupé			DW10CTED4
		2.2i 16v. Berline Break	Sans susp. variable	Pneu 215x55x17 W	EW12J4
		2.2i 16v. Coupé	Susp. normale	Sans susp. variable	EW12J4
		2.2 HDi FAP Berline Break	Susp. normale	Sans susp. variable	DW12BTED4
				Pneu 215x55x17 W	DW12BTED4



Barre stabilisatrice
 Stabilizer bar
 Barra estabilizadora
 Drażek stabilizatora
 стабилизатор поперечной устойчивости

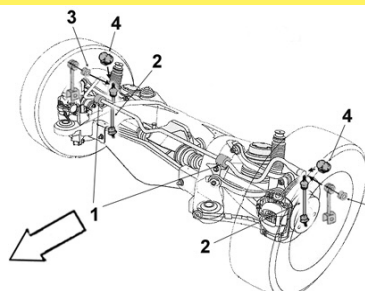

2300017
 OE 517852

Biellette barre stab. AR
 Rear stabilizer bar stub axle



2	1.6 HDi	DV6TED4
	1.8i 16v.	EW7A/J4
	2.0i 16v.	EW10A/J4
	2.0 HDi	DW10BTED4
	2.0 HDi FAP	DW10CTED4
	2.2i 16v.	EW12J4
	2.2 HDi FAP	DW12BTED4
	2.7 HDi	DT17TED4
	3.0i V6	ES9A
	3.0 HDi	DT20C

2300033
 OE 517115

Palier de barre milieu
 Middle bar main bearing



1	1.6 HDi	DV6TED4	-22/10/06
	1.8i 16v.	EW7J4	
	1.8i 16v.	EW7A	-22/10/06
	2.0i 16v.	EW10A	-22/10/06
	2.0i 16v.	EW10J4	
	2.0 HDi	DW10BTED4	-22/10/06
	2.2i 16v.	EW12J4	-22/10/06
	2.2 HDi FAP	DW12BTED4	-22/10/06
	2.7 HDi	DT17TED4	-22/10/06
	3.0i V6	ES9A	-22/10/06



Eléments SUSPENSION
 Suspension parts
 Elementos suspensión
 Elementy zawieszenie
 Элементы подвески

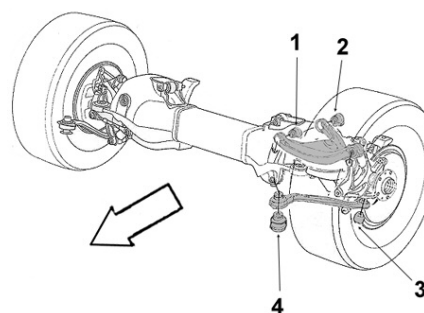

2250011
 OE 5131E0

Articulation triangle
 Track control arm bush



1 2	Ø int. 12 Ø ext. 34 coll. 45 long. tube int. 45 ext. 27 ep. coll.8	
	1.6 HDi	DV6TED4
	1.8i 16v.	EW7A/J4
	2.0i 16v.	EW10A /J4
	2.0 HDi	DW10BTED4
	2.0 HDi FAP	DW10CTED4
	2.2i 16v.	EW12J4
	2.2 HDi FAP	DW12BTED4
	2.7 HDi	DT17TED4
	3.0i V6. 3.0 HDi	ES9A DT20

Bras & Triangle de suspension

Control arm
 Brazo y triángulo
 Wahacz
 Рычаг подвески

G/L D/R

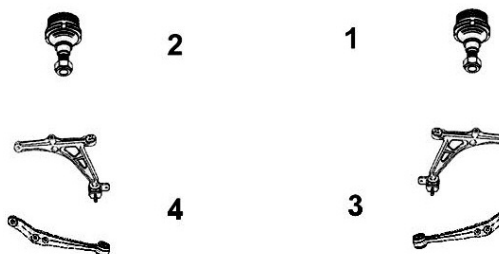

1755CF5
 OE 5175CF

Bras de susp. inf. G/D
 L/R lower track control arm



3 4	1.6 HDi	DV6TED4
	1.8i 16v.	EW7A/J4
	2.0i 16v.	EW10A/J4
	2.0 HDi	DW10BTED4
	2.0 HDi FAP	DW10CTED4
	2.2i 16v.	EW12J4
	2.2 HDi FAP	DW12BTED4
	2.7 HDi	DT17TED4
	3.0i V6	ES9A
	3.0 HDi	DT20C

... 407



Support d'amortisseur
Suspension mounting
Soporte amortiguador
Poduszka amortyzatora
Опора амортизатора

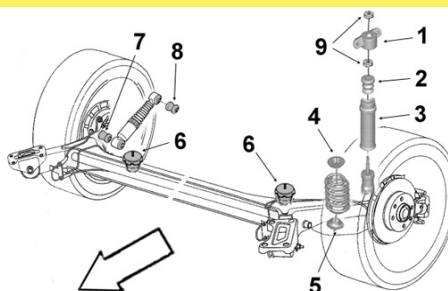

2650039

OE 516533

Coupelle sup. ressort AR

Rear spring upper cup



4

1.6 HDi
 1.8i 16v.
 2.0i 16v.
 2.0 HDi
 2.0 HDi FAP
 2.2i 16v.
 2.2 HDi FAP

DV6TED4
 EW7A/J4
 EW10A/J4
 DW10BTED4
 DW10CTED4
 EW12J4
 DW12BTED4

PEUGEOT



Eléments TRAIN ARRIERE

Rear axle parts

Tren TRAS

Elementy zawieszenia tylnego

элементы задней оси.



2600015

OE 517847

Biellette de suspension

Suspension link rod



TT /all models

4007 ...

Eléments DIRECTION

Steering parts

Elementos Direcciones

Elementy uklad kierowniczy

Элементы рулевой системы

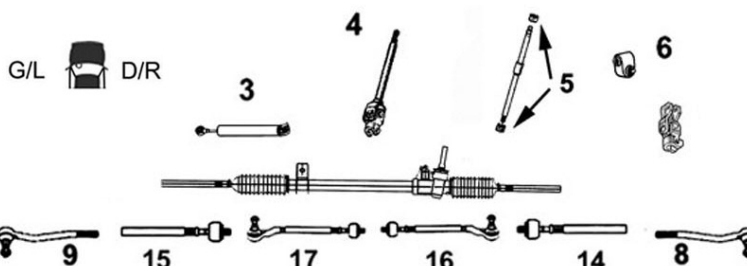

7770021

OE 3812F1

Axe de bielle G/D

L/R axial joint

NEW



14 Côté dir. M14x1.5 Côté rot. M14x1.5
 15 long 342 mm

2.0i
 2.2 HDi FAP
 2.4i

7670007

Part/oe 381774

Rotule de direction G/D

L/R tie rod end



8
 9 M14 x 1.5

2.0i
 2.2 HDi FAP
 2.4i



Barre stabilisatrice
 Stabilizer bar
 Barra estabilizadora
 Drążek stabilizatora
 стабилизатор поперечной устойчивости

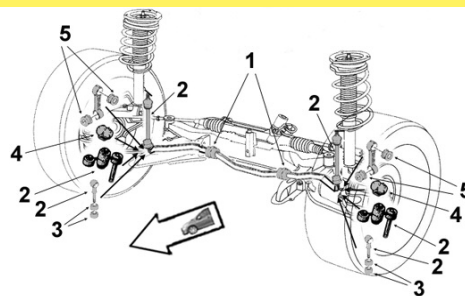

2300018

OE 508758

Biellette barre stab.

Stabilizer bar stub axle

2



2.2 HDi FAP
 2.4i



Eléments SUSPENSION

Suspension parts
Elementos suspensión
Elementy zawieszenie
Элементы подвески

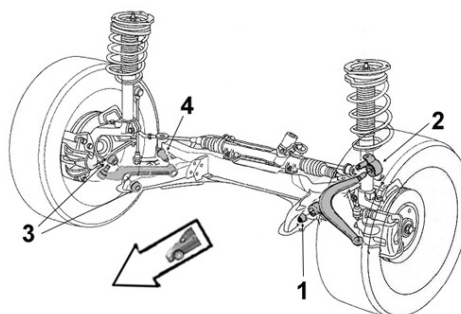

2250021

OE 3523CS

Articulation AR

Rear bush

NEW

2

Ø int.14.3 Ø ext.60 long. tube int.54 ext.27



2.0
 2.2 HDi
 2.4



Support d'amortisseur

Suspension mounting
Soporte amortiguador
Poduszka amortyzatora
Опора амортизатора

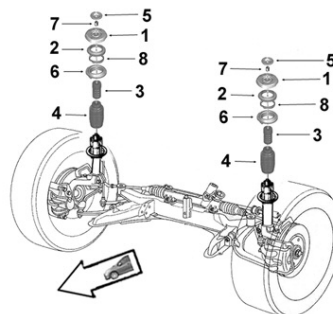

2650036

OE 5038F8

Support suspension

Suspension mounting

1

Sans roulement *Without bearing*



2.0i
 2.2 HDi FAP
 2.4i

... 4007



Barre stabilisatrice
 Stabilizer bar
 Barra estabilizadora
 Drażek stabilizatora
 стабилизатор поперечной устойчивости

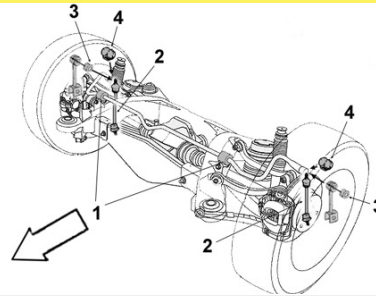

PEUGEOT



2300021
 OE 517848

Biellette barre stab. G
 Left stabilizer bar stub axle



2

2.2 HDi FAP
 2.4i

2300022
 OE 517849

Biellette barre stab. D
 Right stabilizer bar stub axle



2

2.2 HDi FAP
 2.4i

2300046
 OE 517258

Palier de barre milieu
 Middle bar main bearing

NEW



1 Ø 19

2.2 HDi /FAP /4WD
 2.4i 4WD

07/07-
 10/07-

4008 ...

Eléments DIRECTION
 Steering parts
 Elementos Direcciones
 Elementy układ kierowniczy
 Элементы рулевой системы

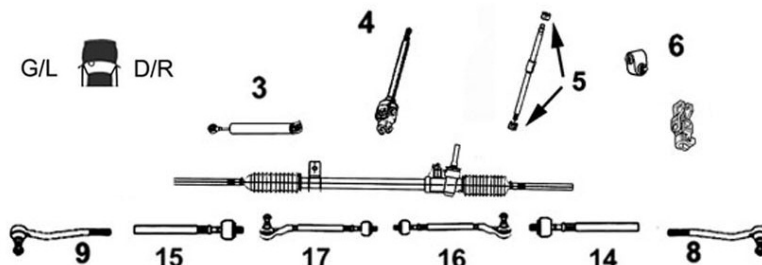

7770014
 Part/oe 1608532180

Axe de bielle G/D
 L/R axial joint

NEW



14 Côté dir. M14x1.5 Côté rot. M14x1.5 long 341 mm
 15

1.6i 4A92
 1.6 HDi DV6C
 1.8 HDi 4N13
 2.0i MMC

7670018
 OE 1607502480

Rotule de direction G/D
 L/R tie rod end

NEW



8
 9 M14 x 1.5

1.6i 4A92
 1.6 HDi DV6C
 1.8 HDi 4N13
 2.0i MMC

... 4008 ...



Barre stabilisatrice
 Stabilizer bar
 Barra estabilizadora
 Drażek stabilizatora
 стабилизатор поперечной устойчивости

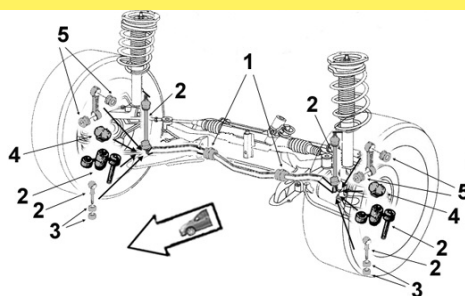

2300018

Biellette barre stab.

OE 508758

Stabilizer bar stub axle

2



1.6i 4WD	4A92
1.8 HDi 4WD	4N13



Eléments SUSPENSION

Suspension parts
 Elementos suspensión
 Elementy zawieszenie
 Элементы подвески

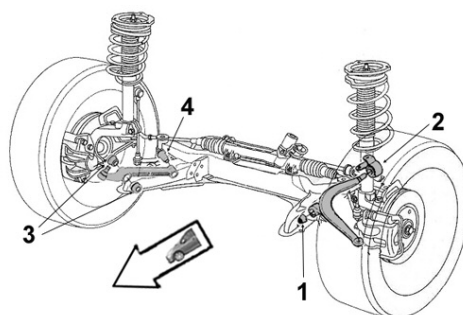

2250021

Articulation AR

OE 3523CS

Rear bush

NEW

2 Ø int.14.3 Ø ext.60 long. tube int.54 ext.27



1.6i	-24/09/12
1.6 HDi	-24/09/12
1.8 HDi	-24/09/12
2.0i	-24/09/12



Support d'amortisseur

Suspension mounting
 Soporte amortiguador
 Poduszka amortyzatora
 Опора амортизатора

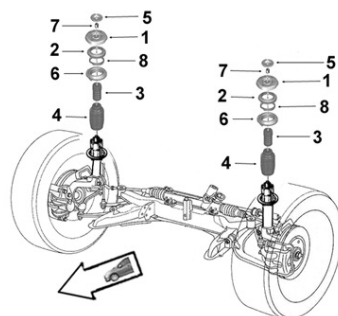

2650036

Support suspension

OE 5038F8

Suspension mounting

1 **Sans roulement** *Without bearing*



1.6i	4A92
1.6 HDi	DV6C
1.8 HDi	4N13
2.0i	MMC

... 4008



Barre stabilisatrice
 Stabilizer bar
 Barra estabilizadora
 Drażek stabilizatora
 стабилизатор поперечной устойчивости

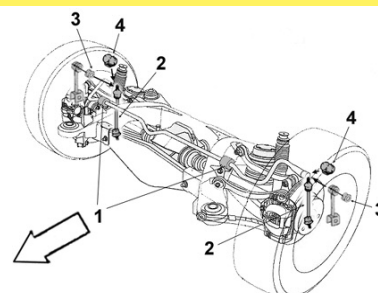

2300022 **Biellette barre stab. G/D**
 OE 517849 *L/R stabilizer bar stub axle*



2

1.6i 4WD	4A92
1.8 HDi 4WD	4N13

504 ...

Eléments DIRECTION
 Steering parts
 Elementos Direcciones
 Elementy układ kierowniczy
 Элементы рулевой системы

G/L D/R

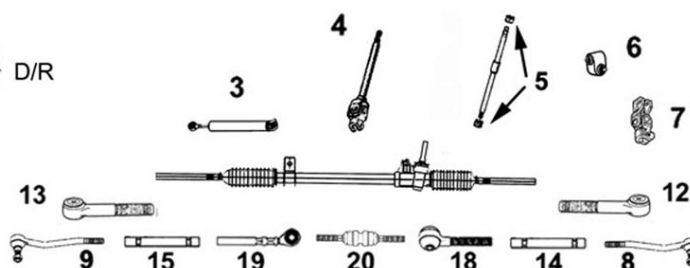

3008173 **Axe de bielle G/D**
 OE - *L/R axial joint*

14 Taraudé *Tapped* Côté dir. M12x1.0
15 Côté rot. M14x1.5 long 242 mm

TT /all models Ch- 3221371 01/80-



3008153 **Axe de bielle G/D**
 OE - *L/R axial joint*

14 Côté dir. M12x1.0 Côté rot. M14x1.5
15 long 262 mm

TT /all models Coupé Cab. 01/80-



8123153B1 **Bielle de direction G/D**
 OE 381215 *L/R steering rod*

8
9
14
15

TT /all models Coupé Cab. 01/80-



8173093 **Rotule de direction G/D**
 OE 381709 *L/R tie rod end*

8
9

TT /all models Pièce réparable -12/79



8173183 **Rotule de direction G/D**
 OE 381750 *L/R tie rod end*

8
9 M14x1.5

TT /all models 01/80-



0574054 **Oeil de crémaillère D**
 OE 405705 *Right steering gear eye*

12 M16x1.5

TT /all models
 dir. 0024434 0024474 0024484 -12/79



... 504 ...

SASIC

PEUGEOT

Eléments DIRECTION
Steering parts
Elementos Direcciones
Elementy układ kierowniczy
Элементы рулевой системы

G/L  D/R

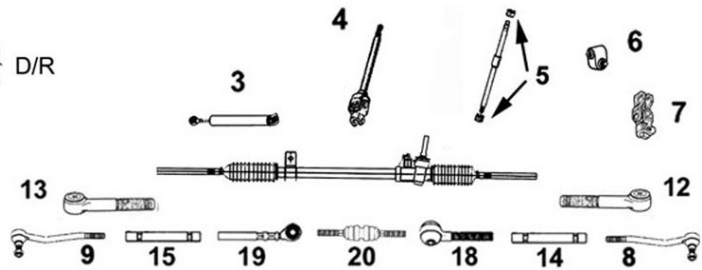

8993123
 OE 389912

Kit rép. rotule direction G ou D
L/R tie rod end repair kit

8993183
 OE 389918

Kit rép. rotule direction G ou D
L/R tie rod end repair kit



Rondelle ep. 6.5 Washers thickness 6.5

TT /all models -12/79

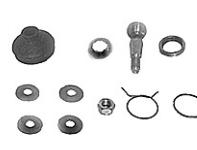

Rondelle ep. 8 Washers thickness 8

TT /all models -12/79



Barre stabilisatrice
Stabilizer bar
Barra estabilizadora
Drażek stabilizatora
стабилизатор поперечной устойчивости

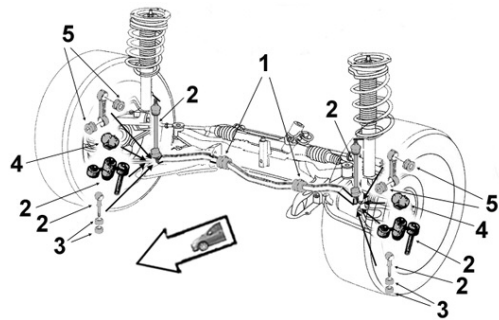

0875055
 OE 508705

Biellette barre stab.
Stabilizer bar stub axle

0875095
 OE 508709

Biellette barre stab.
Stabilizer bar stub axle



2
 -ch 170247

TT /all models Essence & Diesel



2
 Ø int.12 Ø ext.26 long. tube int.30 ext.18
 Ch- 1702474

TT /all models Diesel Sauf DA

0875155
 OE 508715

Biellette barre stab. G/D
L/R stabilizer bar stub axle

1815065
 OE 518106

Liaison élastique
Elastic link



2
 DA Ch- 3552115

TT /all models Essence & Diesel
 Camionnette



3
 Ø int.10 Ø ext.30 long. tube int.20 ext.20

TT /all models Essence & Diesel

0945095
 OE 509409

Palier de barre
Bar main bearing



1 Barre Ø 24

TT /all models Essence & Diesel



Eléments SUSPENSION
Suspension parts
Elementos suspensión
Elementy zawieszenie
Элементы подвески

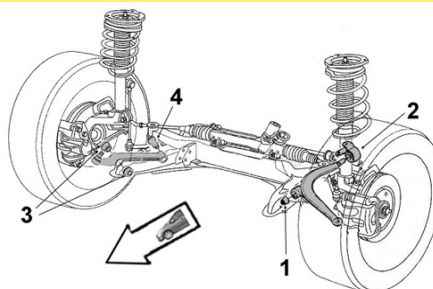

Bras & Triangle de suspension

Control arm
Brazo y triángulo
Wahacz
Рычаг подвески

G/L  D/R

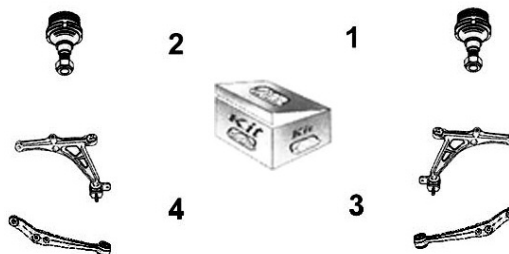

1003552

Kit rép. bras susp. G ou D

OE -

L or R track control arm bearing repair kit



TT /all models 07/85-

6403133

Kit rép. rotule pivot fusée G ou D

OE 364013

L/R suspension ball joint repair kit



Montage avec bouchon fileté
Assembly with threaded cap

TT /all models -12/79



Support d'amortisseur

Suspension mounting
Soporte amortiguador
Poduszka amortyzatora
Опора амортизатора

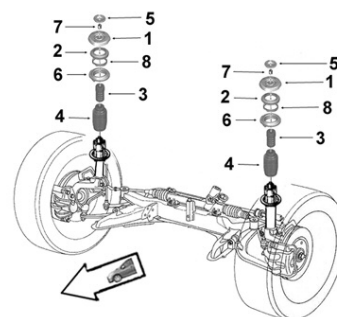

2105235

Support suspension G/D

OE 521023

L/R suspension mounting



1 Ø 12 Ø 14

TT /all models Essence Ch- 2348367

2105225

Support suspension G/D

OE 521036

L/R suspension mounting



1 Ø 14

Ch- 3972016

TT /all models Essence & Diesel

2105175

Support suspension G/D

OE 521017

L/R suspension mounting



1 Ø 12 Ø 14

TT /all models Diesel Ch- 2348367

0325235

Butée de suspension G/D

OE 503223

L/R suspension bush



3

TT /all models Essence & Diesel

2545075

Protecteur amortisseur G/D

OE 525407

L/R shock absorber protector



4 Ø 50

TT /all models Essence -ch 2085065
TT /all models Diesel



Barre stabilisatrice
 Stabilizer bar
 Barra estabilizadora
 Drążek stabilizatora
 стабилизатор поперечной устойчивости

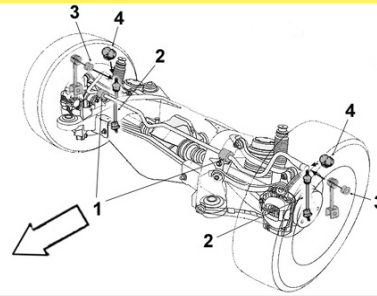

1795025
 OE 517902

Art. barre anti-devers
 Anti-banking bar bush
 Ø int.10 Ø ext.27 long. tube int.22 ext.17



TT /all models Essence & Diesel
 Berline L et break

1715025
 OE 517102

Art. barre stab. AR
 Rear stabilizer bar bush
 Ø int.12 Ø ext.30 long. tube int.42 ext.36



TT /all models Essence & Diesel VU



Eléments SUSPENSION
 Suspension parts
 Elementos suspensión
 Elementy zawieszenie
 Элементы подвески

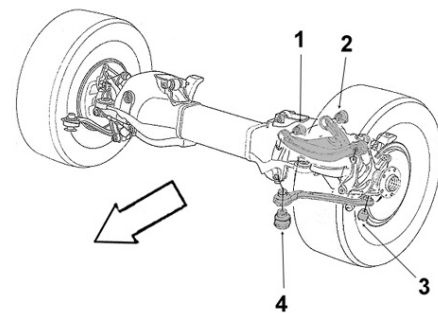

1315175
 OE 513117

Jeu de 2 Art. de bras
 Set of 2 arm bushes
 Ø int.16 Ø ext.32 coll.47.5 long. tube int.89 ext.52 ep. coll.5



-ch 2241256
 TT /all models Essence & Diesel

1315275
 OE 513127

Jeu de 2 Art. de bras
 Set of 2 arm bushes
 Ø int.14 Ø ext.32 coll.47 long. tube int.89 ext.48 ep. coll.5



Ch- 2241256
 TT /all models Essence & Diesel

1315275S
 OE 513127

Jeu de 2 Art. de bras
 Set of 2 arm bushes
 Ø int.14 Ø ext.32 coll.47 long. tube int.89 ext.48 ep. coll.5



Ch- 2241256
 TT /all models Essence & Diesel



Support d'amortisseur
Suspension mounting
Soporte amortiguador
Poduszka amortyzatora
Опора амортизатора

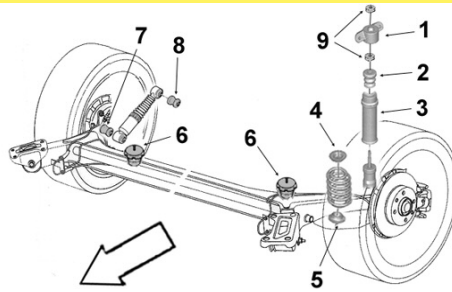

2205205
 OE 522020

Tampon susp. amort. AR
Rear suspension rebound stop

5143123
 OE 351412

Butée de talonnage G/D
L/R bushing



Ø 9.5 x Ø 36 x 20

TT /all models Essence & Diesel
 Berline L et VU



6 Ø 53 H 55

TT /all models Essence & Diesel

Eléments TRAIN ARRIERE

Rear axle parts
Tren TRAS
Elementy zawieszenia tylnego
элементы задней оси.



1315395
 OE 513139

Art. balancier pont
Beam bush



Ø int.16 Ø ext.32 long. tube int.69 ext.60

TT /all models Essence & Diesel

1525165
 OE 515240

Support traverse AR G
Rear left cross bar mounting

1525175
 OE 515241

Support traverse AR D
Rear right cross bar mounting



TT /all models Essence & Diesel
 sauf pont AR



TT /all models Essence & Diesel
 sauf pont AR

1525185
 OE 515253

Support train AR
Rear axle mounting



TT /all models Essence & Diesel sauf pont AR

505 ...

Eléments DIRECTION
Steering parts
Elementos Direcciones
Elementy układ kierowniczy
Элементы рулевой системы

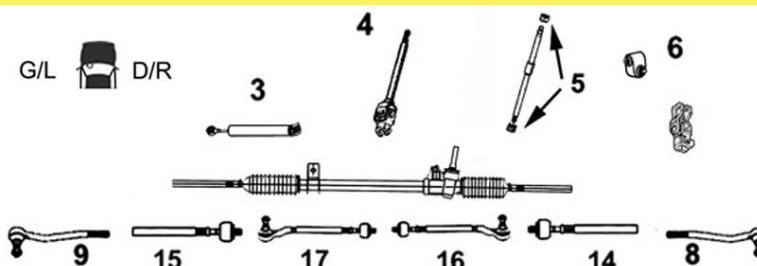

PEUGEOT





Barre stabilisatrice
 Stabilizer bar
 Barra estabilizadora
 Drażek stabilizatora
 стабилизатор поперечной устойчивости

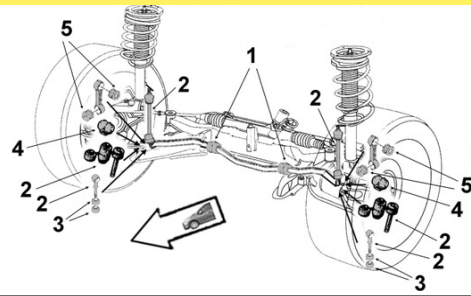

0875185
 OE 508718

Biellette barre stab. G
 Left stabilizer bar stub axle



2
 TT /all models Remplace 5087.17

0875205
 OE 508720

Biellette barre stab. D
 Right stabilizer bar stub axle



2
 TT /all models Remplace 5087.17

1815065
 OE 518106

Liaison élastique
 Elastic link
 3 Ø int.10 Ø ext.30 long. tube int.20 ext.20



TT /all models Sauf N9T ZN3J

0945325
 OE 509432

Palier de barre
 Bar main bearing
 1 Barre Ø 26



TT /all models



Eléments SUSPENSION
 Suspension parts
 Elementos suspensión
 Elementy zawieszenie
 Элементы подвески

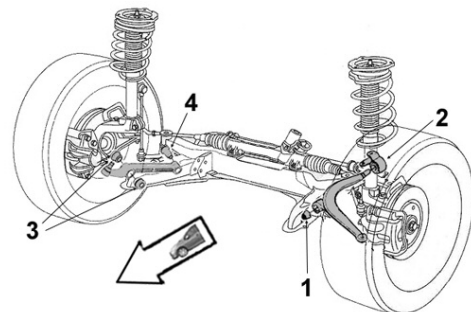

5233103
 OE 352310

Articulation ext. AR
 Rear outer bush



3 Ø int.16 Ø ext.25 coll.30
 long. tube int.17 ext.12 ep. coll.5
 TT /all models

5233163
 OE 352316

Articulation int. AR
 Rear inner bush



4 Ø int.14 Ø ext.33 long. tube int.44 ext.32
 TT /all models Côté berceau

5613093
 OE 356109

Articulation AV
 Front bush
 4 Ø int.16 Ø ext.37.5 coll.50 long. tube int.41.5 ext.22 ep. coll.10



TT /all models

Bras & Triangle de suspension

Control arm
Brazo y triángulo
Wahacz
Рычаг подвески

G/L  D/R



6403253
OE 364027

Rotule de susp. inf. G/D
L/R lower suspension ball joint



1
2

TT /all models Sauf 4WD

1003549
OE -

Kit rép. bras susp. G ou D
L or R track control arm bearing repair kit



TT /all models Sauf 4WD -10/85

1003556
OE -

Kit rép. bras susp. G ou D
L or R track control arm bearing repair kit



TT /all models Sauf 4WD 11/85-

6403133
OE 364013

Kit rép. rotule pivot fusée G ou D
L/R suspension ball joint repair kit



Montage avec bouchon fileté
Assembly with threaded cap

TT /all models Sauf Dangel



Support d'amortisseur

Suspension mounting
Soporte amortiguador
Poduszka amortyzatora
Опора амортизатора

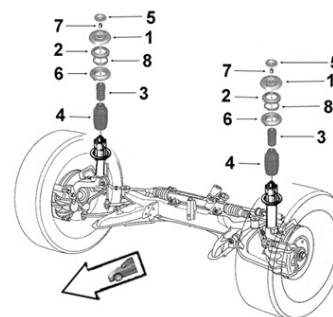

2105235
OE 521023

Support suspension G/D
L/R suspension mounting



1 Ø 12 Ø 14

TT /all models -10/85

2105225
OE 521036

Support suspension G/D
L/R suspension mounting



1 Ø 14

TT /all models 11/85-

0325235
OE 503223

Butée de suspension G/D
L/R suspension bush



3

TT /all models

2545075
OE 525407

Protecteur amortisseur G/D
L/R shock absorber protector



4 Ø 50

TT /all models

... 505

SASIC

PEUGEOT

Eléments TRAIN ARRIERE

Rear axle parts

Tren TRAS

Elementy zawieszenia tylnego

элементы задней оси.



1315275 OE 513127	Jeu de 2 Art. de bras <i>Set of 2 arm bushes</i>	1315395 OE 513139	Art. balancier pont <i>Beam bush</i>
	Ø int.14 Ø ext.32 coll.47 long. tube int.89 ext.48 ep. coll.5 TT /all models		Ø int.16 Ø ext.32 long. tube int.69 ext.60 TT /all models
1315275S (en/in skinpack)			
1525165 OE 515240	Support traverse AR G <i>Rear left cross bar mounting</i>	1525175 OE 515241	Support traverse AR D <i>Rear right cross bar mounting</i>
	TT /all models		TT /all models
1525185 OE 515253	Support train AR <i>Rear axle mounting</i>		
	TT /all models		

508 ...

Eléments DIRECTION

Steering parts







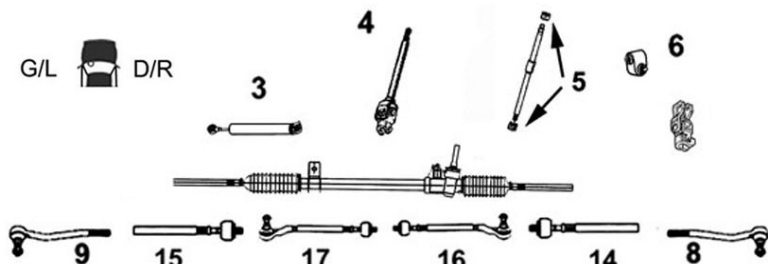



Elementos Direcciones

Elementy układ kierowniczy

Элементы рулевой системы

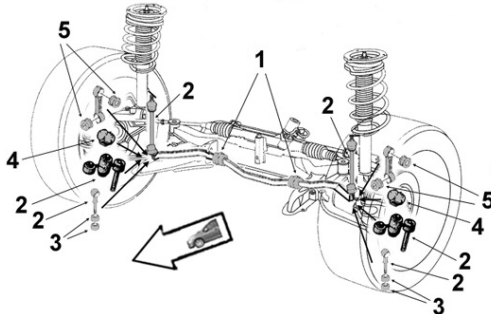

7770016 Part/oe 3812G3	Axe de bielle G/D <i>L/R axial joint</i>	
	14 Côté dir. M16x1.5 Côté rot. M14x1.5 long 209 mm 15 Train avant type Pseudo Mac Pherson	1.6i 16v. THP 1.6 VTi 1.6 HDi 2.0 HDi 2.0 HDi FAP 2.0 HDi FAP Sauf break Allroad
		EP6CDT /M EP6C DV6C DW10BTED4 DW10FD DW10CTED4

... 508 ...			
7770006 Part/oe 3812F3		Axe de bielle G/D <i>L/R axial joint</i>	
		14 Côté dir. M16x1.5 Côté rot. M14x1.5 long 129 mm 15 Train avant type VH10 2.0 HDi FAP DW10FC 2.2 HDi FAP DW12C	
7670024 OE 3817A1		7670023 OE 3817A2	
Rotule de direction G <i>Left tie rod end</i>		Rotule de direction D <i>Right tie rod end</i>	
			
9 M14 x 1.5 Train avant type Pseudo Mac Pherson 1.6i 1.6i 16v. THP 1.6 VTi 1.6 HDi FAP 2.0 HDi FAP /4WD 2.2 HDi FAP		8 M14 x 1.5 Train avant type Pseudo Mac Pherson 1.6i 1.6i 16v. THP 1.6 VTi 1.6 HDi FAP 2.0 HDi FAP /4WD 2.2 HDi FAP	
7670015 OE 1609948280		7670014 OE 1609948380	
Rotule de direction G <i>Left tie rod end</i>		Rotule de direction D <i>Right tie rod end</i>	
			
9 M14 x 1.5 Train avant type VH10 2.0 HDi FAP DW10FC 2.2 HDi FAP DW12C		8 M14 x 1.5 Train avant type VH10 2.0 HDi FAP DW10FC 2.2 HDi FAP DW12C	
			
Barre stabilisatrice <i>Stabilizer bar</i> <i>Barra estabilizadora</i> <i>Drażek stabilizatora</i> стабилизатор поперечной устойчивости			
2300011 OE 508752		2300009 OE 508753	
Biellette barre stab. G <i>Left stabilizer bar stub axle</i>		Biellette barre stab. D <i>Right stabilizer bar stub axle</i>	
			
2 Train AV type VH10 2.2 HDi FAP DW12C		2 Train AV type VH10 2.2 HDi FAP DW12C	
2300023 OE 509498		Palier de barre milieu <i>Middle bar main bearing</i>	
		1 Barre Ø 23.5 Train AV pseudo mac pherson sans chaine traction hybride 1.6i /16v./Turbo Berline EP6/C/CDT/DT 1.6 VTi Berline EP6C 1.6 HDi FAP Berline DV6C 2.0 HDi FAP Berline DW10B /CTED4	



Barre stabilisatrice
 Stabilizer bar
 Barra estabilizadora
 Drążek stabilizatora
 стабилизатор поперечной устойчивости

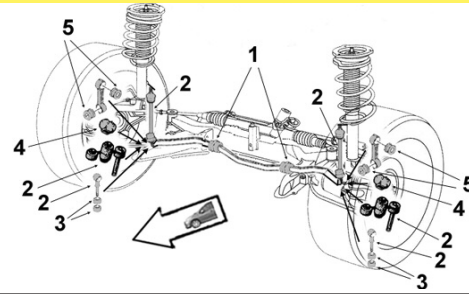

2300004
 OE 509499

Palier de barre milieu
 Middle bar main bearing



1 Barre Ø 24

1.6i /16v. /Turbo SW	Train AV pseudo mac pherson sans chaine	traction hybride	EP6 /CDT /DT
1.6 VTi SW	Train AV pseudo mac pherson sans chaine	traction hybride	EP6C
1.6 HDi FAP SW	Train AV pseudo mac pherson sans chaine	traction hybride	DV6C
2.0 HDi FAP SW	Train AV pseudo mac pherson sans chaine	traction hybride	DW10B /CTED4
2.2 HDi FAP Berline	Train AV type VH10		DW12C
2.2 HDi FAP SW	Train AV pseudo mac pherson sans chaine	traction hybride	DW12C

2300024
 OE 5094A0

Palier de barre milieu
 Middle bar main bearing



1 Barre Ø 24.5

2.0 HDi 4WD FAP Berline	Train AV pseudo mac pherson et chaine	traction hybride	DW10CTED4
2.2 HDi FAP SW	Train AV type VH10		DW12C



Eléments SUSPENSION
 Suspension parts
 Elementos suspensión
 Elementy zawieszenie
 Элементы подвески

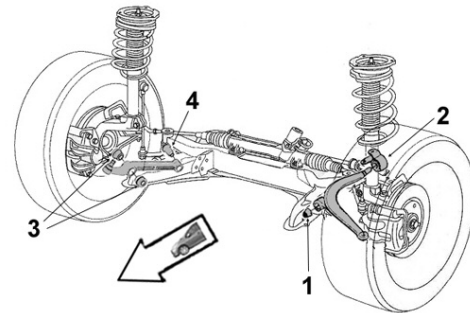

2250019
 OE 3523CA

Art. bras sup.
 Upper arm bush



1 Ø int.10.3 Ø ext. 32 coll. 39
2 long. tube int. 34 ext. 22 ep. coll.6.2

Train avant type VH10
 1.6i 16v. THP EP6CDT/ M
 1.6i VTi 16v. EP6C
 1.6 HDi DV6C
 2.0 HDi FAP DW10BTED4/CTED4
 2.2 HDi FAP DW12C

2250014
 OE 3523AZ

Art. sup. support pivot
 pivot mounting upper bush



Ø int. 12 Ø ext. 33 coll. 40
 long. tube int. 82 ext. 21.5 ep. coll.6.3

Train avant type VH10
 1.6i 16v. THP EP6CDT/M
 1.6i VTi 16v. EP6C
 1.6 HDi DV6C
 2.0 HDi DW10BTED4
 2.0 HDi FAP DW10CTED4
 2.2 HDi FAP DW12C

2250002
 OE 3523AQ

Articulation AV triangle inf.
 Lower front track control arm front bush



1 Ø int.14 Ø ext.56 long. tube int.32 ext 50

1.6i 16v. /Turbo EP6 /CDT /DT
 1.6 VTi EP6C
 1.6 HDi FAP DV6C
 2.0 HDi FAP DW10B /CTED4
 2.2 HDi FAP DW12C

2250013
 Part/oe 365604

Art. inf. support pivot
 lower bush pivot mounting



Ø int. 12 Ø ext. 40 coll. 45.4
 long. tube int. 38 ext. 27 ep. coll.2.3

Train avant type VH10
 1.6i 16v. THP EP6CDT/M
 1.6i VTi 16v. EP6C
 1.6 HDi DV6C
 2.0 HDi DW10BTED4
 2.0 HDi FAP DW10CTED4
 2.2 HDi FAP DW12C

Bras & Triangle de suspension

Control arm
Brazo y triángulo
Wahacz
Рычаг подвески

G/L  D/R





Barre stabilisatrice
 Stabilizer bar
 Barra estabilizadora
 Drążek stabilizatora
 стабилизатор поперечной устойчивости

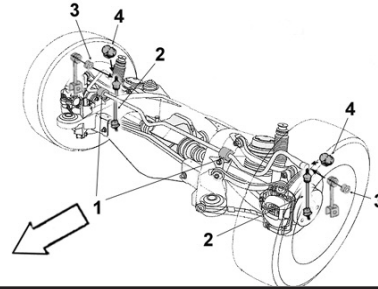

2300017 **Biellette barre stab. AR**
 OE 517852 *Rear stabilizer bar stub axle*



2

1.6i /16v. /Turbo
 1.6 VTi
 1.6 HDi FAP
 2.0 HDi /FAP
 2.0 HDi FAP Sans chaîne traction hybride
 2.2 HDi FAP

EP6 /CDT /DT
 EP6C
 DV6C
 DW10BTED4
 DW10CTED4
 DW12C



Eléments SUSPENSION
 Suspension parts
 Elementos suspensión
 Elementy zawieszenie
 Элементы подвески

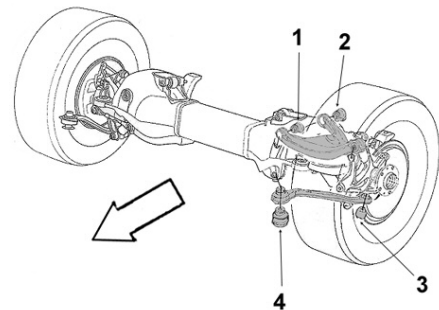

2250011 **Articulation triangle**
 OE 5131E0 *Track control arm bush*



1
2

Ø int. 12 Ø ext. 34 coll. 45 long. tube int. 45 ext. 27 ep. coll.8
 1.6i /16v. /Turbo
 1.6 VTi
 1.6 HDi FAP
 2.0 HDi FAP
 2.2 HDi FAP

EP6 /CDT /DT
 EP6C
 DV6C
 DW10B /CTED4
 DW12C

Bras & Triangle de suspension

Control arm
 Brazo y triángulo
 Wahacz
 Рычаг подвески

G/L D/R

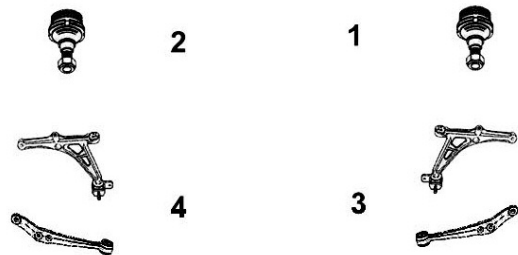

1755CF5 **Bras de susp. inf. G/D**
 OE 5175CF *L/R lower track control arm*



3
4

1.6i 16v. THP
 1.6i VTi 16v.
 1.6 HDi
 2.0 HDi FAP
 2.0 HDi FAP Sauf hybride
 2.2 HDi FAP

EP6CDT/M
 EP6C
 DV6C
 DW10BTED4 DW10FC DW10FD
 DW10CTED4
 DW12C



Support d'amortisseur

Suspension mounting
Soporte amortiguador
Poduszka amortyzatora
Опора амортизатора

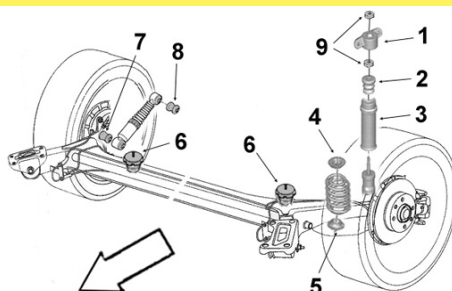

2650039

Coupelle sup. ressort AR

OE 516533

Rear spring upper cup



4

1.6i 16v. THP
1.6i VTi 16v.
1.6 HDi
2.0 HDi
2.0 HDi FAP Sauf hybride
2.2 HDi FAP

EP6CDT/ M
EP6C
DV6C
DW10BTED4
DW10CTED4
DW12C

Eléments TRAIN ARRIERE

Rear axle parts

Tren TRAS

Elementy zawieszenia tylnego

элементы задней оси.



2600015

OE 517847

Biellette de suspension

Suspension link rod



1.6i 16v. THP EP6CDT/ M
1.6i VTi 16v. EP6C
1.6 HDi DV6C
2.0 HDi FAP DW10BTED4
2.0 HDi FAP Sauf hybride DW10CTED4
2.2 HDi FAP DW12C

Eléments DIRECTION

Steering parts

Elementos Direcciones

Elementy uklad kierowniczy

Элементы рулевой системы

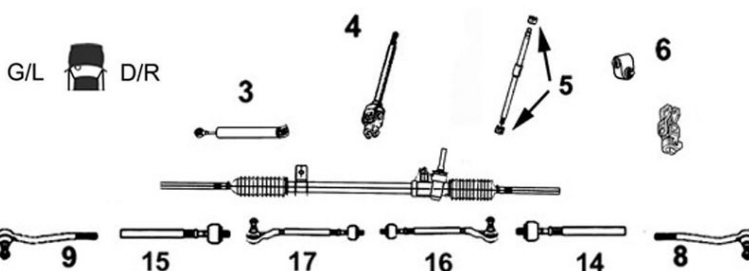

7770002

Axe de bielle G/D

OE 3812F2

L/R axial joint



14
15

Côté dir. M14x1.5 Côté rot. M14x1.5 long 278 mm

1.6i 16v. THP EP6CDT /M/MD EP6FDT
1.6i 16v. EP6/C
1.6 HDi DV6C
1.6 HDi FAP DV6TED4
2.0 HDi FAP DW10CB DTR DW10CTED4

7670017

Rotule de direction G

OE 381789

Left tie rod end

NEW



9

M14 x 1.5

1.6i 16v. EP6/C
1.6i 16v. THP EP6CDT/ M/MD
1.6i 16v. THP EP6FDT
1.6 HDi DV6C
1.6 HDi FAP DV6TED4
2.0 HDi FAP DW10CB DTR
2.0 HDi FAP DW10CTED4

7670016

Rotule de direction D

OE 381788

Right tie rod end

NEW



8

M14 x 1.5

1.6i 16v. EP6/C
1.6i 16v. THP EP6CDT /M/MD
1.6i 16v. THP EP6FDT
1.6 HDi DV6C
1.6 HDi FAP DV6TED4
2.0 HDi FAP DW10CTED4
2.0 HDi FAP DW10CB DTR



Barre stabilisatrice
 Stabilizer bar
 Barra estabilizadora
 Drążek stabilizatora
 стабилизатор поперечной устойчивости

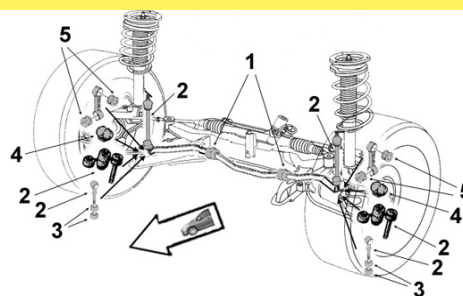

2300019

OE 508764

Biellette barre stab.

Stabilizer bar stub axle



2

1.6i 16v. EP6 BVM BE4R -30/09/12
 1.6i 16v. EP6C -30/09/12
 1.6i 16v. EP6CDT BVM MC -30/09/12
 1.6 HDi FAP DV6TED4 -30/09/12
 2.0 HDi FAP Sauf hybride DW10CTED4 18/10/10-30/09/12

2300030

OE 508757

Biellette barre stab.

Stabilizer bar stub axle



2

2.0 HDi FAP Hybride DW10CTED4 18/10/10-30/09/12

0945895

OE 5094E3

Palier de barre milieu

Middle bar main bearing



1 Barre Ø 23

1.6i 16v. /THP	EP6	BVM BE4R
1.6i 16v.	EP6C/DT	
1.6 HDi FAP	DV6TED4/C	
2.0 HDi FAP	DW10CTED4	



Eléments SUSPENSION

Suspension parts
Elementos suspensión
Elementy zawieszenie
Элементы подвески

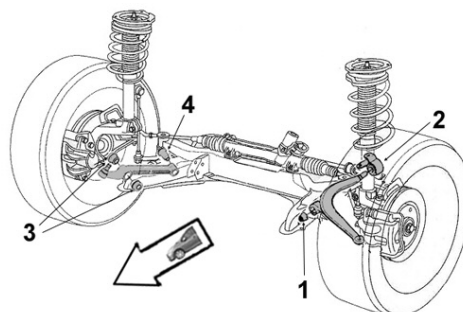

5233913

OE 352391

Articulation AV

Front bush



1 Ø int.14 Ø ext.55 long. tube int.56 ext.32

1.6i 16v.	EP6	BVM BE4R
1.6i 16v.	EP6C	
1.6i 16v.	EP6CDT BVM MC	
1.6 HDi FAP	DV6TED4/C	
2.0 HDi FAP	DW10CTED4	

5233923

OE 352392

Articulation AR

Rear bush



2 Ø int.14 Ø ext.55 coll.62 long. tube int.49 ext.25 ep. coll.3

1.6i 16v. /THP	EP6	BVM BE4R
1.6i 16v.	EP6C/DT	
1.6 HDi FAP	DV6TED4/C	
2.0 HDi FAP	DW10CTED4	

Bras & Triangle de suspension

Control arm
Brazo y triángulo
Wahacz
Рычаг подвески

G/L  D/R



7470003

OE 3520V2

Triangle de susp. inf. G

Lower left track control arm



4 **Sans rotule** Without tie rod end
1.6i 16v. THP EP6CDT/ M/MD -02/12/12
1.6i 16v. THP EP6FDT -02/12/12
1.6i 16v. EP6/C -02/12/12
1.6 HDi DV6C -02/12/12
1.6 HDi FAP DV6TED4 -02/12/12
2.0 HDi FAP DW10CB DTR -02/12/12
2.0 HDi FAP DW10CTED4 -02/12/12

7470004

OE 3521R3

Triangle de susp. inf. D

Lower right track control arm



3 **Sans rotule** Without tie rod end
1.6i 16v. THP EP6CDT/ M/MD -02/12/12
1.6i 16v. THP EP6FDT -02/12/12
1.6i 16v. EP6/C -02/12/12
1.6 HDi DV6C -02/12/12
1.6 HDi FAP DV6TED4 -02/12/12
2.0 HDi FAP DW10CB DTR -02/12/12
2.0 HDi FAP DW10CTED4 -02/12/12

6403533

OE 364073

Rotule de susp. inf. G/D

L/R lower suspension ball joint



1
2
1.6i 16v. THP EP6CDT/ M/MD EP6FDT
1.6i 16v. EP6/C
1.6 HDi DV6C
1.6 HDi FAP DV6TED4
2.0 HDi FAP DW10CB DTR DW10CTED4



Support d'amortisseur

Suspension mounting
Soporte amortiguador
Poduszka amortyzatora
Опора амортизатора

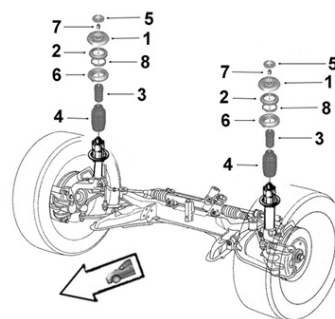

2650016

OE 5038H3

Support suspension G/D

L/R suspension mounting



1 **Susp. normale**
1.6i 16v. EP6/C
1.6i 16v. THP EP6CDT
1.6 HDi DV6C
1.6 HDi FAP DV6TED4
2.0 HDi FAP DW10CTED4

0355275

OE 503527

Butée à billes G/D

L/R ball bearing



2
1.6i 16v. EP6/C
1.6i 16v. THP EP6CDT
1.6 HDi DV6C
1.6 HDi FAP DV6TED4
2.0 HDi FAP DW10CTED4

2650035

OE 503151

Coupelle amortisseur G/D

L/R shock absorber cup



6
1.6i 16v. EP6/C
1.6i 16v. THP EP6CDT
1.6 HDi DV6C
1.6 HDi FAP DV6TED4
2.0 HDi FAP DW10CB DTR
2.0 HDi FAP DW10CTED4

2650001

OE 503370

Butée de suspension G/D

L/R suspension bush



3 **H96**
Susp. normale
1.6i 16v. EP6/C
1.6 HDi FAP DV6TED4/C

... 5008



Support d'amortisseur
 Suspension mounting
 Soporte amortiguador
 Poduszka amortyzatora
 Опора амортизатора

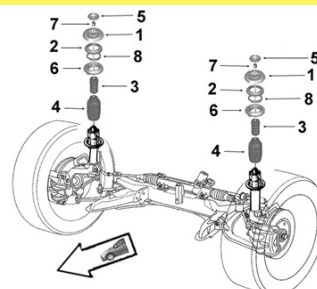

2650017
 OE 5033E4

Butée de suspension G/D
 L/R suspension bush



3 H96

Susp. normale

1.6i 16v. THP EP6CDT
 2.0 HDi FAP DW10CTED4

Eléments TRAIN ARRIERE

Rear axle parts

Tren TRAS

Elementy zawieszenia tylnego

элементы задней оси.



2600004
 OE 5131F2

Articulation essieu
 Axle bush



Ø int. 14 Ø ext. 80 coll. 87
 long. tube int. 79 ext. 59 ep. coll.7

1.6i 16v. /THP EP6
 1.6i 16v. EP6C
 1.6 HDi FAP DV6TED4
 2.0 HDi FAP DW10CTED4

2600005
 OE 5131K0

Articulation essieu
 Axle bush



Ø int. 14 Ø ext. 81 coll. 97
 long. tube int. 79 ext. 54 ep. coll.8

1.6i 16v. Turbo EP6CDT M/MD

604 ...

Eléments DIRECTION

Steering parts

Elementos Direcciones

Elementy uklad kierowniczy

Элементы рулевой системы

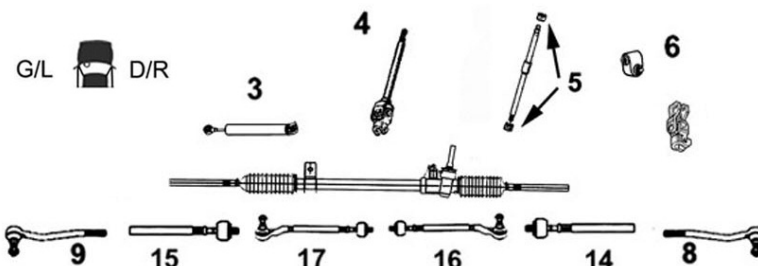

0114414
 OE 401141

Vérin dir. assistée
 Power steering jack



3

TT /all models

3008153
 OE -

Axe de bielle G/D
 L/R axial joint





14 Côté dir. M12x1.0 Côté rot. M14x1.5
15 long 262 mm

TT /all models

... 604 ...

PEUGEOT



8123153B1 OE 381215	Bielle de direction G/D <i>L/R steering rod</i>	8173183 OE 381750	Rotule de direction G/D <i>L/R tie rod end</i>
	16 17 TT /all models Essence 01/80- TT /all models Diesel		8 9 M14 x 1.5 TT /all models Essence 01/80- TT /all models Diesel



Barre stabilisatrice
Stabilizer bar
Barra estabilizadora
Drażek stabilizatora
 стабилизатор поперечной устойчивости

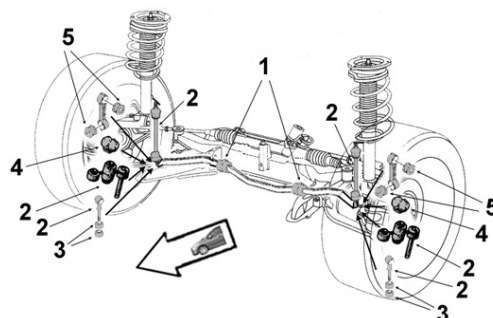

1815065 OE 518106	Liaison élastique <i>Elastic link</i>
	Ø int.10 Ø ext.30 long. tube int.20 ext.20 TT /all models



Eléments SUSPENSION
Suspension parts
Elementos suspensión
Elementy zawieszenie
 Элементы подвески

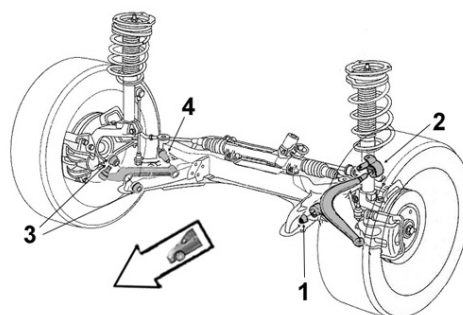

5233163 OE 352316	Articulation <i>Bush</i>
	4 Ø int.14 Ø ext.33 long. tube int.44 ext.32 TT /all models Côté berceau

... 604 ...



PEUGEOT

Bras & Triangle de suspension

Control arm
Brazo y triángulo
Wahacz
Рычаг подвески

G/L D/R



6403253
OE 364027

Rotule de susp. inf. G/D
L/R lower suspension ball joint



1
2

TT /all models Ch- 6648441 (82)

1003549
OE -

Kit rép. bras susp. G ou D
L or R track control arm bearing repair kit



TT /all models

6403133
OE 364013

Kit rép. rotule pivot fusée G ou D
L/R suspension ball joint repair kit



Montage avec bouchon fileté
Assembly with threaded cap

TT /all models



Support d'amortisseur

Suspension mounting
Soporte amortiguador
Poduszka amortyzatora
Опора амортизатора

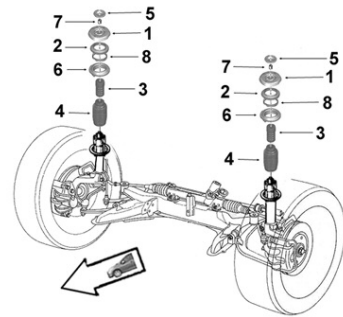

2105175
OE 521017

Support suspension G/D
L/R suspension mounting



1 Ø 12 Ø 14

TT /all models

2545075
OE 525407

Protecteur amortisseur G/D
L/R shock absorber protector



4 Ø 50

TT /all models



Support d'amortisseur
Suspension mounting
Soporte amortiguador
Poduszka amortyzatora
Опора амортизатора

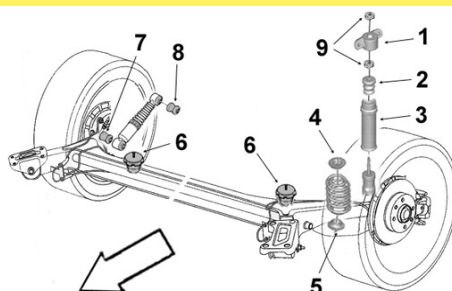

5143123

OE 351412

Butée de talonnage G/D

L/R bushing



6 Ø53 H55

TT /all models

Eléments TRAIN ARRIERE

Rear axle parts
Tren TRAS
Elementy zawieszenia tylnego
элементы задней оси.



1525165

OE 515240

Support traverse AR G

Rear left cross bar mounting



TT /all models sauf pont AR

1525175

OE 515241

Support traverse AR D

Rear right cross bar mounting



TT /all models sauf pont AR

1525185

OE 515253

Support train AR

Rear axle mounting



TT /all models sauf pont AR

605 ...

Eléments DIRECTION

Steering parts

Elementos Direcciones

Elementy układ kierowniczy

Элементы рулевой системы

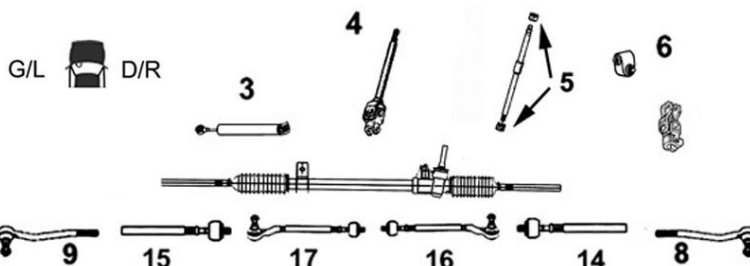

8123993

Axe de bielle G/D

Part/oe 381299

L/R axial joint



14 Côté dir. M12x1.0 Côté rot. M14x1.5
15 long 295 mm

TT /all models

3008156

Axe de bielle G/D

Part/oe 3812A6

L/R axial joint



14 Côté dir. M12x1.0 Côté rot. M16x1.5
15 long 293 mm

TT /all models

8173303

Rotule de direction G

OE 381741

Left tie rod end



9 M14 x 1.5

TT /all models

8173313

Rotule de direction D

OE 381742

Right tie rod end



8 M14 x 1.5

TT /all models

8173433

Rotule de direction G

OE 381743

Left tie rod end



9 M16 x 1.5

TT /all models

8173443

Rotule de direction D

OE 381744

Right tie rod end



8 M16 x 1.5

TT /all models



Barre stabilisatrice

Stabilizer bar

Barra estabilizadora

Drażek stabilizatora

стабилизатор поперечной устойчивости

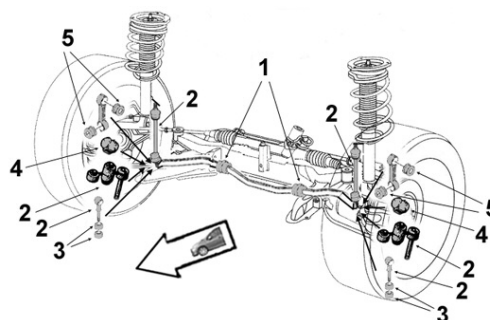

0875415

Biellette barre stab.

OE 508749

Stabilizer bar stub axle



2

TT /all models

0945705

Palier de barre

OE 509470

Bar main bearing



1 Barre Ø 22

TT /all models



Eléments SUSPENSION
Suspension parts
Elementos suspensión
Elementy zawieszenie
Элементы подвески

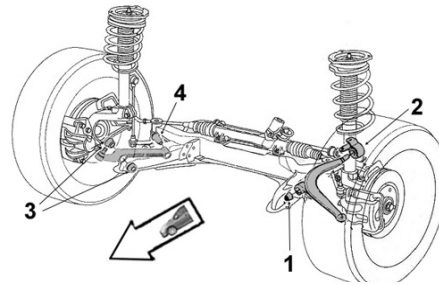



5233433 OE 352343	Articulation AV <i>Front bush</i>	5233573 OE 352357	Articulation AR <i>Rear bush</i>
	1 Ø int.14 Ø ext.40 coll.54.5 long. tube int.27.5 ext.27 ep. coll.9 TT /all models		2 Ø int.20.2 Ø ext.50 long. tube int.45 ext.40 TT /all models Essence sauf turbo et V6 -06/94

5233453 OE 352396	Articulation AR <i>Rear bush</i>		
	2 Ø int.20.2 Ø ext.50 long. tube int.45 ext.45 TT /all models Turbo /V6/ Diesel TT /all models		
		-06/94	07/94-

Bras & Triangle de suspension
Control arm
Brazo y triángulo
Wahacz
Рычаг подвески

G/L  D/R



7470013 OE 3520K6	Triangle de susp. inf. G <i>Lower left track control arm</i>	7470012 OE 3521G6	Triangle de susp. inf. D <i>Lower right track control arm</i>
	4 Sans rotule <i>Without tie rod end</i> 2.0 XU10J2C 07/94- 2.0 Turbo XU10J2TE 2.0i XU10J2 07/94- 2.0i 16v. XU10J4R 07/94- 2.1 D XUD11A -06/94 2.1 TD XUD11 2.5 TD DK5ATE 07/94- 3.0i V6/ 24v. ZPJ/4 3.0i V6 24v. ES9J4 07/94-		3 Sans rotule <i>Without tie rod end</i> 2.0 XU10J2C 07/94- 2.0 Turbo XU10J2TE 2.0i XU10J2 07/94- 2.0i 16v. XU10J4R 07/94- 2.1 D XUD11A -06/94 2.1 TD XUD11 2.5 TD DK5ATE 07/94- 3.0i V6/ 24v. ZPJ/4 3.0i V6 24v. ES9J4 07/94-

6403343 OE 364071	Rotule de susp. inf. G/D <i>L/R lower suspension ball joint</i>	105A566S OE -	Kit rép. train AV <i>Front axle repair kit</i>
	1 2 M14 x 1.5 TT /all models		Sans visserie <i>Without screws and bolts</i> Barre Ø 22 TT /all models

... 605 ...

SASIC

PEUGEOT

Bras & Triangle de suspension

Control arm
Brazo y triángulo
Wahacz
Рычаг подвески

G/L  D/R



1053566B

OE -

Kit rép. train AV complet
Front axle complete repair kit

Avec visserie With screws and bolts
Barre Ø 22

TT /all models

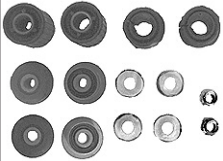

1003566

OE -

Kit rép. triangle susp. G ou D
L or R track control arm bearing repair kit

Avec visserie With screws and bolts

TT /all models



Support d'amortisseur

Suspension mounting
Soporte amortiguador
Poduszka amortyzatora
Опора амортизатора

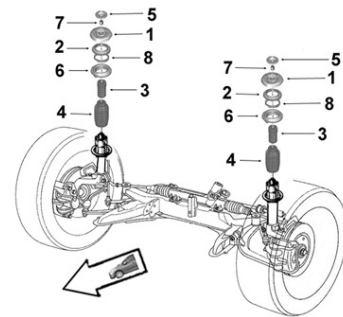

0385205

OE 503820

Support suspension G/D
L/R suspension mounting

1

TT /all models -06/94
Sauf anti-hachi

TT /all models 07/94-



0355325

OE 503554

Butée à billes G/D
L/R ball bearing

2

TT /all models



0335405

OE 503340

Butée de suspension G/D
L/R suspension bush

3

Ø 56 H 109

TT /all models





Barre stabilisatrice
 Stabilizer bar
 Barra estabilizadora
 Drażek stabilizatora
 стабилизатор поперечной устойчивости

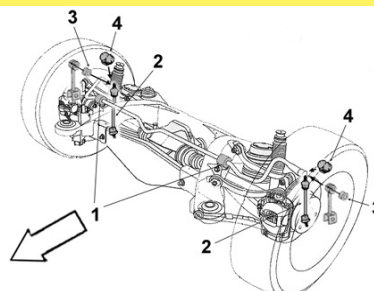

1785435 OE 517843	Biellette G barre stab. AR Rear stabilizer bar stub axle left	1785315 OE 517844	Biellette D barre stab. AR Rear stabilizer bar stub axle right
	2 TT /all models		2 TT /all models
1725295 OE 517247	Palier de barre milieu Middle bar main bearing	1725305 OE 517230	Palier de barre milieu Middle bar main bearing
	1 Ø 25 TT /all models Sauf ZPJ4 -ch 90803857 -06/94 TT /all models 07/94-		1 Ø 26 3.0i V6 -ch 90803857 ZPJ4 -06/94



Éléments SUSPENSION
 Suspension parts
 Elementos suspensión
 Elementy zawieszenie
 Элементы подвески

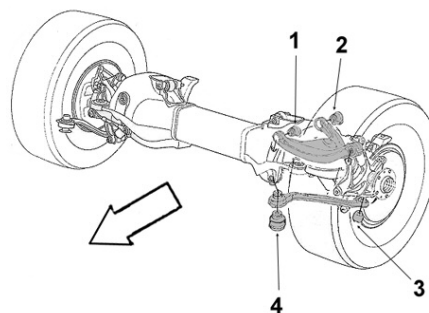

1315535 OE 513153	Art. AV triangle sup. Upper track control arm front bush	1315545 OE 513154	Art. AR triangle sup. Upper track control arm rear bush
	1 Ø int.12 Ø ext.40 long. tube int.60 ext.40 TT /all models		2 Ø int.12 Ø ext.36 long. tube int.45 ext.35 TT /all models
1315535 OE 513153	Art. AV triangle inf. Lower track control arm front bush	1315765 OE 513176	Art. AV triangle inf. Lower track control arm front bush
	1 Ø int.12 Ø ext.40 long. tube int.60 ext.40 TT /all models -06/94		1 Ø int.12 Ø ext.40 long. tube int.60 ext.40 TT /all models 07/94-

... 605 ...

SASIC

PEUGEOT



Eléments SUSPENSION

Suspension parts
Elementos suspensión
Elementy zawieszenie
Элементы подвески

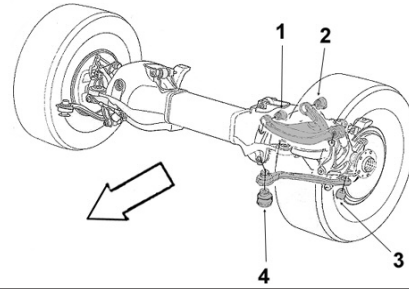

1315565

OE 513156

Art. AR triangle inf.

Lower track control arm rear bush

2 Ø int.12 Ø ext.32 long. tube int.60 ext.48

TT /all models



3323073

OE 333207

Articulation AR

Rear bush

Ø int.12 Ø ext.32 coll.44
 long. tube int.25 ext.18 ep. coll.5

TT /all models
 Fixation triangle sup. côté pivot



1315555

OE 513155

Articulation AR

Rear bush

Ø int.14 Ø ext.34 coll.43 long. tube int.30 ext.23 ep. coll.5

TT /all models Fixation triangle inf. côté pivot



Support d'amortisseur

Suspension mounting
Soporte amortiguador
Poduszka amortyzatora
Опора амортизатора

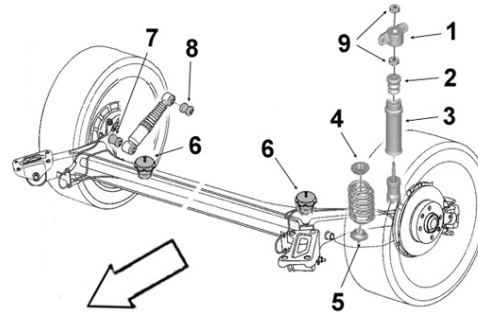

1645345

OE 516434

Coupelle sup. ressort AR

Rear spring upper cup

4

TT /all models 29/09/97-



... 605

Eléments TRAIN ARRIERE

Rear axle parts

Tren TRAS

Elementy zawieszenia tylnego

элементы задней оси.



PEUGEOT



1315525 OE 513152	Art. traverse sup. AV sup. <i>Upper front Upper cross bar bush</i> Ø int.12 Ø ext.57 coll.62,3 long. tube int.52 ext.45 ep. coll.5,4 TT /all models	1315625 OE 5131E1	Coupelle traverse susp. AR <i>Rear susp. cross bar cup</i> Ø int. 12.5 Ø ext. 71.5 TT /all models

607 ...

Eléments DIRECTION

Steering parts

Elementos Direcciones

Elementy układ kierowniczy

Элементы рулевой системы

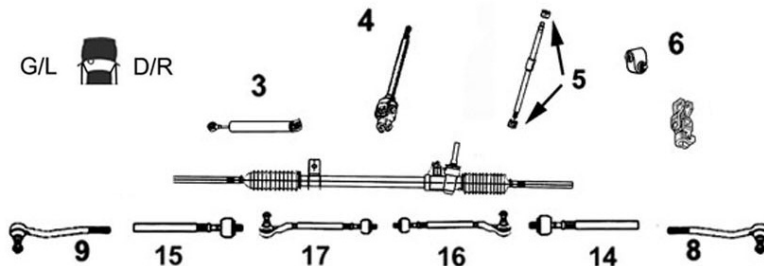

3008161 Part/oe 3812C7	Axe de bielle G/D <i>L/R axial joint</i> 14 Côté dir. M16x1.5 Côté rot. M16x1.5 long 296 mm 15 <table style="width: 100%; border-collapse: collapse;"> <tr><td>2.0i 16v.</td><td>EW10J4</td><td>-08/04</td></tr> <tr><td>2.0 HDi</td><td>DW10ATED</td><td>-08/04</td></tr> <tr><td>2.0 HDi FAP</td><td>DW10ATED/BTED4</td><td>09/04-</td></tr> <tr><td>2.2i 16v.</td><td>EW12J4</td><td></td></tr> <tr><td>2.2 HDi</td><td>DW12TED4</td><td></td></tr> <tr><td>2.2 HDi FAP</td><td>DW12BTED4</td><td>09/04-</td></tr> <tr><td>2.7 HDi</td><td>DT17TED4</td><td>09/04-</td></tr> <tr><td>3.0i V6</td><td>ES9J4S</td><td>-08/04</td></tr> <tr><td>3.0i V6</td><td>ES9A</td><td>09/04-</td></tr> </table>	2.0i 16v.	EW10J4	-08/04	2.0 HDi	DW10ATED	-08/04	2.0 HDi FAP	DW10ATED/BTED4	09/04-	2.2i 16v.	EW12J4		2.2 HDi	DW12TED4		2.2 HDi FAP	DW12BTED4	09/04-	2.7 HDi	DT17TED4	09/04-	3.0i V6	ES9J4S	-08/04	3.0i V6	ES9A	09/04-
2.0i 16v.	EW10J4	-08/04																										
2.0 HDi	DW10ATED	-08/04																										
2.0 HDi FAP	DW10ATED/BTED4	09/04-																										
2.2i 16v.	EW12J4																											
2.2 HDi	DW12TED4																											
2.2 HDi FAP	DW12BTED4	09/04-																										
2.7 HDi	DT17TED4	09/04-																										
3.0i V6	ES9J4S	-08/04																										
3.0i V6	ES9A	09/04-																										

8173433 OE 381743	Rotule de direction G <i>Left tie rod end</i> 9 M16 x 1.5 <table style="width: 100%; border-collapse: collapse;"> <tr><td>2.0i 16v.</td><td>EW10J4</td><td>-08/04</td></tr> <tr><td>2.0 HDi</td><td>DW10ATED</td><td>-08/04</td></tr> <tr><td>2.0 HDi FAP</td><td>DW10ATED/BTED4</td><td>09/04-</td></tr> <tr><td>2.2i 16v.</td><td>EW12J4</td><td></td></tr> <tr><td>2.2 HDi</td><td>DW12TED4</td><td></td></tr> <tr><td>2.2 HDi FAP</td><td>DW12BTED4</td><td>09/04-</td></tr> <tr><td>2.7 HDi</td><td>DT17TED4</td><td>09/04-</td></tr> <tr><td>3.0i V6</td><td>ES9J4S</td><td>-08/04</td></tr> <tr><td>3.0i V6</td><td>ES9A</td><td>09/04-</td></tr> </table>	2.0i 16v.	EW10J4	-08/04	2.0 HDi	DW10ATED	-08/04	2.0 HDi FAP	DW10ATED/BTED4	09/04-	2.2i 16v.	EW12J4		2.2 HDi	DW12TED4		2.2 HDi FAP	DW12BTED4	09/04-	2.7 HDi	DT17TED4	09/04-	3.0i V6	ES9J4S	-08/04	3.0i V6	ES9A	09/04-
2.0i 16v.	EW10J4	-08/04																										
2.0 HDi	DW10ATED	-08/04																										
2.0 HDi FAP	DW10ATED/BTED4	09/04-																										
2.2i 16v.	EW12J4																											
2.2 HDi	DW12TED4																											
2.2 HDi FAP	DW12BTED4	09/04-																										
2.7 HDi	DT17TED4	09/04-																										
3.0i V6	ES9J4S	-08/04																										
3.0i V6	ES9A	09/04-																										
8173443 OE 381744	Rotule de direction D <i>Right tie rod end</i> 8 M16 x 1.5 <table style="width: 100%; border-collapse: collapse;"> <tr><td>2.0i 16v.</td><td>EW10J4</td><td>-08/04</td></tr> <tr><td>2.0 HDi</td><td>DW10ATED</td><td>-08/04</td></tr> <tr><td>2.0 HDi FAP</td><td>DW10ATED/BTED4</td><td>09/04-</td></tr> <tr><td>2.2i 16v.</td><td>EW12J4</td><td></td></tr> <tr><td>2.2 HDi</td><td>DW12TED4</td><td></td></tr> <tr><td>2.2 HDi FAP</td><td>DW12BTED4</td><td>09/04-</td></tr> <tr><td>2.7 HDi</td><td>DT17TED4</td><td>09/04-</td></tr> <tr><td>3.0i V6</td><td>ES9J4S</td><td>-08/04</td></tr> <tr><td>3.0i V6</td><td>ES9A</td><td>09/04-</td></tr> </table>	2.0i 16v.	EW10J4	-08/04	2.0 HDi	DW10ATED	-08/04	2.0 HDi FAP	DW10ATED/BTED4	09/04-	2.2i 16v.	EW12J4		2.2 HDi	DW12TED4		2.2 HDi FAP	DW12BTED4	09/04-	2.7 HDi	DT17TED4	09/04-	3.0i V6	ES9J4S	-08/04	3.0i V6	ES9A	09/04-
2.0i 16v.	EW10J4	-08/04																										
2.0 HDi	DW10ATED	-08/04																										
2.0 HDi FAP	DW10ATED/BTED4	09/04-																										
2.2i 16v.	EW12J4																											
2.2 HDi	DW12TED4																											
2.2 HDi FAP	DW12BTED4	09/04-																										
2.7 HDi	DT17TED4	09/04-																										
3.0i V6	ES9J4S	-08/04																										
3.0i V6	ES9A	09/04-																										



Barre stabilisatrice
 Stabilizer bar
 Barra estabilizadora
 Drażek stabilizatora
 стабилизатор поперечной устойчивости

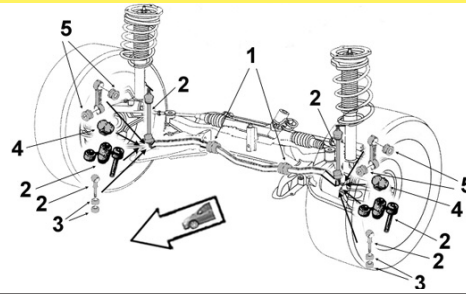

0875485
 OE 508760

Biellette barre stab.
 Stabilizer bar stub axle



2	M12 x 175		
	2.0i 16v.	EW10J4	-08/04
	2.0 HDi Sans FAP	DW10ATED	-08/04
	2.0 HDi FAP	DW10ATED	
	2.0 HDi FAP	DW10BTED4	09/04-
	2.2i 16v.	EW12J4	
	2.2 HDi	DW12TED4	
	2.2 HDi FAP	DW12BTED4	09/04-
	2.7 HDi	DT17TED4	09/04-
	3.0i V6	ES9J4S	-08/04
	3.0i V6	ES9A	09/04-



Eléments SUSPENSION
 Suspension parts
 Elementos suspensión
 Elementy zawieszenie
 Элементы подвески

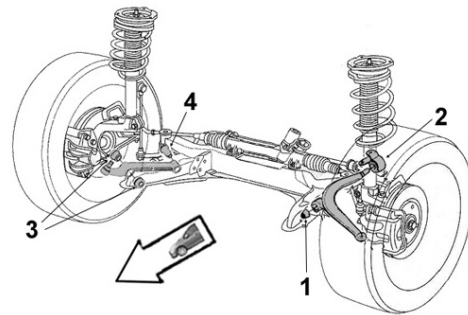

5233433
 OE 352343

Articulation AV
 Front bush



1	Ø int.14 Ø ext.40 coll.54.5 long. tube int.27.5 ext.27 ep. coll.9		
	2.0i 16v.	EW10J4	-08/04
	2.0 HDi Sans FAP	DW10ATED	-08/04
	2.0 HDi FAP	DW10ATED	
	2.0 HDi FAP	DW10BTED4	09/04-
	2.2i 16v.	EW12J4	
	2.2 HDi	DW12TED4	
	2.2 HDi FAP	DW12BTED4	09/04-
	2.7 HDi	DT17TED4	09/04-
	3.0i V6	ES9J4S	-08/04
	3.0i V6	ES9A	09/04-

5233453
 OE 352396

Articulation AR
 Rear bush



2	Ø int.20.2 Ø ext.50 long. tube int.45 ext.45		
	2.0i 16v.	EW10J4	-08/06/03
	2.0 HDi Sans FAP	DW10ATED	-08/04
	2.0 HDi FAP	DW10ATED	-08/06/03
	2.2i 16v.	EW12J4	-08/06/03
	2.2 HDi	DW12TED4	-08/04
	3.0i V6	ES9J4S	-29/04/02

Bras & Triangle de suspension

Control arm
Brazo y triángulo
Wahacz
Рычаг подвески

G/L  D/R

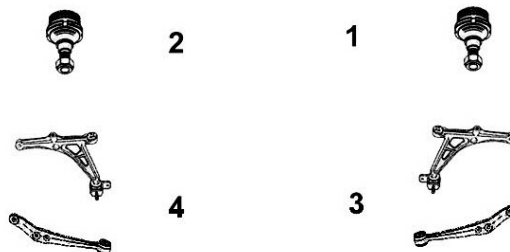

7470013
OE 3520K6

Triangle de susp. inf. G
Lower left track control arm



4	Sans rotule Without tie rod end
2.0i 16v.	EW10J4 -08/06/03
2.0 HDi FAP	DW10ATED -08/06/03
2.0 HDi sans FAP	DW10ATED -09/04
2.2i 16v.	EW12J4 -08/06/03
2.2 HDi	DW12TED4 -09/04
3.0i V6	ES9J4S -29/04/02

7470012
OE 3521G6

Triangle de susp. inf. D
Lower right track control arm



3	Sans rotule Without tie rod end
2.0i 16v.	EW10J4 -08/06/03
2.0 HDi FAP	DW10ATED -08/06/03
2.0 HDi sans FAP	DW10ATED -09/04
2.2i 16v.	EW12J4 -08/06/03
2.2 HDi	DW12TED4 -09/04
3.0i V6	ES9J4S -29/04/02

6403343
OE 364071

Rotule de susp. inf. G/D
L/R lower suspension ball joint



1	M14 x 1.5
2	2.0i 16v. EW10J4 -08/04
	2.0 HDi DW10ATED -08/04
	2.0 HDi FAP DW10ATED /BTED4 09/04-
	2.2i 16v. EW12J4
	2.2 HDi DW12TED4
	2.2 HDi FAP DW12BTED4 09/04-
	2.7 HDi DT17TED4 09/04-
	3.0i V6 ES9J4S -08/04
	3.0i V6 ES9A 09/04-



Support d'amortisseur
Suspension mounting
Soporte amortiguador
Poduszka amortyzatora
Опора амортизатора

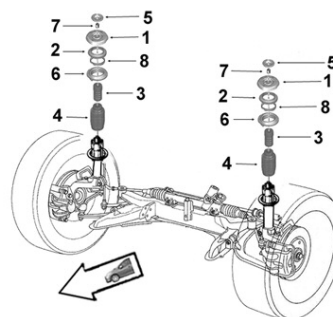

0385205
OE 503820

Support suspension G/D
L/R suspension mounting



1	2.0i 16v. EW10J4 -08/06/03
	2.0 HDi FAP DW10ATED -08/06/03
	2.0 HDi sans FAP DW10ATED -08/06/03
	2.2i 16v. EW12J4 -08/06/03
	2.2 HDi Susp. normale DW12TED4 -08/04
	3.0i V6 Sauf susp. variable ES9J4S -08/06/03

0355325
OE 503554

Butée à billes G/D
L/R ball bearing



2	2.0i 16v. EW10J4 -08/04
	2.0 HDi FAP DW10ATED
	2.0 HDi FAP DW10BTED4 09/04-
	2.0 HDi DW10ATED -08/04
	2.2i 16v. EW12J4
	2.2 HDi DW12TED4
	2.2 HDi FAP DW12BTED4 09/04-
	2.7 HDi DT17TED4 09/04-
	3.0i V6 ES9J4S -08/04
	3.0i V6 ES9A 09/04-

2545265
OE 525426

Protecteur amortisseur G/D
L/R shock absorber protector



4	2.0 HDi FAP DW10BTED4 09/04-
	2.0 HDi FAP DW10ATED 09/04-
	2.2i 16v. EW12J4 09/04-
	2.2 HDi DW12TED4 09/04-
	2.2 HDi FAP DW12BTED4 09/04-
	2.7 HDi DT17TED4 09/04-
	3.0i V6 ES9A 09/04-



Barre stabilisatrice
 Stabilizer bar
 Barra estabilizadora
 Drażek stabilizatora
 стабилизатор поперечной устойчивости

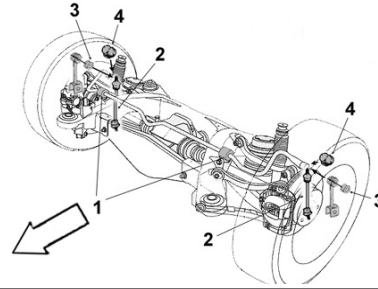

1785435
 OE 517843

Biellette G barre stab. AR
 Rear stabilizer bar stub axle left



2	2.0i 16v.	EW10J4	-08/04
	2.0 HDi	DW10ATED	
	2.0 HDi FAP	DW10BTED4	09/04-
	2.2i 16v.	EW12J4	
	2.2 HDi	DW12TED4	
	2.2 HDi FAP	DW12BTED4	09/04-
	2.7 HDi	DT17TED4	09/04-
	3.0i V6	ES9J4S	-08/04
	3.0i V6	ES9A	09/04-

1785315
 OE 517844

Biellette D barre stab. AR
 Rear stabilizer bar stub axle right



2	2.0i 16v.	EW10J4	-08/04
	2.0 HDi	DW10ATED	
	2.0 HDi FAP	DW10BTED4	09/04-
	2.2i 16v.	EW12J4	
	2.2 HDi	DW12TED4	
	2.2 HDi FAP	DW12BTED4	09/04-
	2.7 HDi	DT17TED4	09/04-
	3.0i V6	ES9J4S	-08/04
	3.0i V6	ES9A	09/04-

1725295
 OE 517247

Palier de barre milieu
 Middle bar main bearing



1	Ø 25		
	TT /all models		-08/04
	2.7 HDi	DT17TED4	09/04-
	3.0i V6	ES9A	09/04-



Eléments SUSPENSION
 Suspension parts
 Elementos suspensión
 Elementy zawieszenie
 Элементы подвески

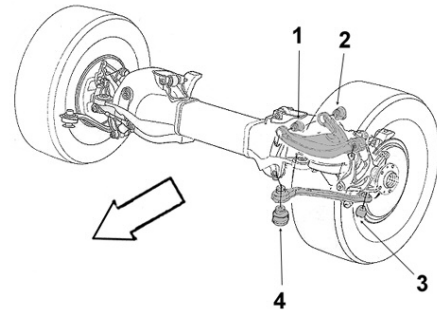

1315535
 OE 513153

Art. AV triangle sup.
 Upper track control arm front bush



1	Ø int.12 Ø ext.40 long. tube int.60 ext.40		
	2.0i 16v.	EW10J4	-08/04
	2.0 HDi	DW10ATED	-08/04
	2.2i 16v.	EW12J4	-08/04
	2.2 HDi	DW12TED4	-08/04
	3.0i V6	ES9J4S	-08/04

1315545
 OE 513154

Art. AR triangle sup.
 Upper track control arm rear bush



2	Ø int.12 Ø ext.36 long. tube int.45 ext.35		
	2.0i 16v.	EW10J4	-08/04
	2.0 HDi	DW10ATED	-08/04
	2.2i 16v.	EW12J4	-08/04
	2.2 HDi	DW12TED4	-08/04
	3.0i V6	ES9J4S	-08/04

1315765
 OE 513176

Art. AV triangle inf.
 Lower track control arm front bush



1	Ø int.12 Ø ext.40 long. tube int.60 ext.40		
	2.0i 16v.	EW10J4	-08/04
	2.0 HDi Sans FAP	DW10ATED	-08/04
	2.0 HDi FAP	DW10BTED4	09/04-
	2.0 HDi FAP	DW10ATED	
	2.2i 16v.	EW12J4	
	2.2 HDi	DW12TED4	
	2.2 HDi FAP	DW12BTED4	09/04-
	2.7 HDi	DT17TED4	09/04-
	3.0i V6	ES9J4S	-08/04
	3.0i V6	ES9A	09/04-

1315565
 OE 513156

Art. AR triangle inf.
 Lower track control arm rear bush



2	Ø int.12 Ø ext.32 long. tube int.60 ext.48		
	2.0i 16v.	EW10J4	-08/04
	2.0 HDi Sans FAP	DW10ATED	-08/04
	2.0 HDi FAP	DW10BTED4	09/04-
	2.0 HDi FAP	DW10ATED	
	2.2i 16v.	EW12J4	
	2.2 HDi	DW12TED4	
	2.2 HDi FAP	DW12BTED4	09/04-
	2.7 HDi	DT17TED4	09/04-
	3.0i V6	ES9J4S	-08/04
	3.0i V6	ES9A	09/04-

3323073
OE 333207

Articulation AR
Rear bush



Ø int.12 Ø ext.32 coll.44 long. tube int.25 ext.18 ep. coll.5
Fixation triangle sup. côté pivot
2.0i 16v. EW10J4 -08/04
2.0 HDi DW10ATED -08/04
2.2i 16v. EW12J4 -08/04
2.2 HDi DW12TED4 -08/04
3.0i V6 S9J4S -08/04

1315555
OE 513155

Articulation AR
Rear bush



Ø int.14 Ø ext.34 coll.43 long. tube int.30 ext.23 ep. coll.5
Fixation triangle inf. côté pivot
2.0i 16v. EW10J4 -08/04
2.0 HDi /FAP DW10ATED -08/04
2.0 HDi FAP DW10ATED/BTED4
2.2i 16v. EW12J4
2.2 HDi DW12TED4
2.2 HDi FAP DW12BTED4 09/04-
2.7 HDi DT17TED4 09/04-
3.0i V6 ES9J4S -08/04
3.0i V6 ES9A 09/04-



Support d'amortisseur
Suspension mounting
Soporte amortiguador
Poduszka amortyzatora
Опора амортизатора

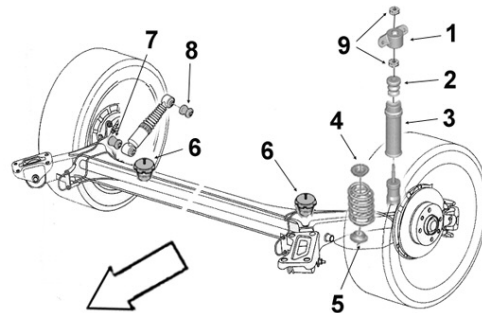

1645345
OE 516434

Coupelle sup. ressort AR
Rear spring upper cup



4 2.0i 16v. EW10J4 -08/04
2.0 HDi FAP DW10BTED4 09/04-
2.0 HDi FAP DW10ATED
2.0 HDi sans FAP DW10ATED -08/04
2.2i 16v. EW12J4
2.2 HDi DW12TED4
2.2 HDi FAP DW12BTED4 09/04-
2.7 HDi DT17TED4 09/04-
3.0i V6 ES9J4S -08/04
3.0i V6 ES9A 09/04-

Eléments TRAIN ARRIERE
Rear axle parts
Tren TRAS
Elementy zawieszenia tylnego
элементы задней оси.



1315525
OE 513152

Art. traverse sup. AV sup.
Upper front Upper cross bar bush



Ø int.12 Ø ext.57 coll.62,3 long. tube int.52 ext.45 ep. coll.5,4
2.0i 16v. EW10J4 -08/04
2.0 HDi DW10ATED -08/04
2.2i 16v. EW12J4 -08/04
2.2 HDi DW12TED4 -08/04
3.0i V6 ES9J4S -08/04

Eléments TRAIN ARRIERE

Rear axle parts

Tren TRAS

Elementy zawieszenia tylnego

элементы задней оси.



1315625

Coupelle traverse susp. AR AV inf.

OE 5131E1

Lower rear/front susp. cross bar cup



Ø int. 12.5 Ø ext. 71.5

2.0i 16v.	EW10J4	-08/04
2.0 HDi sans FAP	DW10ATED	-08/04
2.0 HDi FAP	DW10ATED	
2.0 HDi FAP	DW10BTED4	09/04-
2.2i 16v.	EW12J4	
2.2 HDi FAP	DW12BTED4	09/04-
2.7 HDi	DT17TED4	09/04-
3.0i V6	ES9J4S	-08/04
3.0i V6	ES9A	09/04-

806 ...

Eléments DIRECTION

Steering parts

Elementos Direcciones

Elementy układ kierowniczy

Элементы рулевой системы

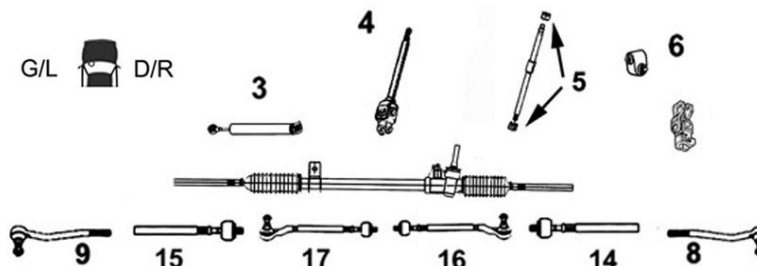

3008069

Axe de bielle G/D

OE 3812A4

L/R axial joint



14	Côté dir. M14x1.5	Côté rot. M14x1.5
15	long 306 mm	DA
	1.8	XU7JP
	1.9 TD	XUD9BTF/ TE
	2.0	XU10J2
	2.0 Turbo	XU10J2TE
	2.0i 16v.	EW10J4 XU10J4R
	2.0 HDi	DW10ATED/4
	2.1 TD	XUD11BTE

0594094

Rotule de direction G/D

OE 405909

L/R tie rod end



8	M14 x 1.5	DA
9		
	1.8	XU7JP
	1.9 TD	XUD9TE
	2.0	XU10J2
	2.0 Turbo	XU10J2TE
	2.0i 16v.	EW10J4 XU10J4R
	2.0 HDi	DW10ATED/4
	2.1 TD	XUD11BTE

1034F64

Axe de volant

OE 4103F6

Steering wheel shaft



4	Conduite à G	
	1.8	XU7JP
	1.9 TD	XUD9TE
	2.0	XU10J2
	2.0 Turbo	XU10J2TE
	2.0i 16v.	XU10J4R
	2.0i 16v.	EW10J4
	2.0 HDi	DW10ATED/4
	2.1 TD	XUD11BTE

1034F74

Axe de volant

OE 4103F7

Steering wheel shaft



4	Conduite à D	
	1.8	XU7JP
	1.9 TD	XUD9TE
	2.0	XU10J2
	2.0 Turbo	XU10J2TE
	2.0i 16v.	EW10J4 XU10J4R
	2.0 HDi	DW10ATED/4
	2.1 TD	XUD11BTE



Barre stabilisatrice
 Stabilizer bar
 Barra estabilizadora
 Drażek stabilizatora
 стабилизатор поперечной устойчивости

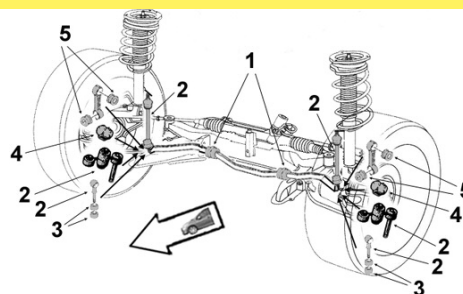

0875355 OE 508735	Biellette barre stab. <i>Stabilizer bar stub axle</i>	0935155 OE 509315	Liaison élastique <i>Elastic link</i>
	2 TT /all models		3 Ø int.12.5 Ø ext.37.5 long. tube int.20 ext.22 TT /all models

0945695 OE 509469	Palier de barre milieu <i>Middle bar main bearing</i>		
	1 Barre Ø 24 TT /all models		







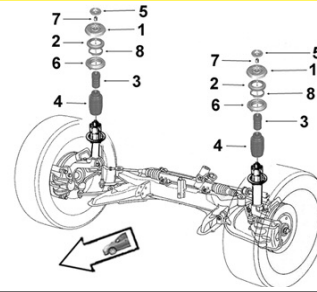

Bras & Triangle de suspension <i>Control arm</i> <i>Brazo y triángulo</i> <i>Wahacz</i> <i>Рычаг подвески</i>	G/L	D/R		2	1	
				4	3	

5203943 OE 3520P4	Triangle de susp. G <i>Left track control arm</i>	5213643 OE 3521K4	Triangle de susp. D <i>Right track control arm</i>
	4 Avec rotule <i>With ball joint</i> 1.8 XU7JP 1.9 TD XUD9TE 2.0 XU10J2 2.0 Turbo XU10J2TE 2.0i 16v. EW10J4 XU10J4R 2.0 HDi DW10ATED/4 2.1 TD XUD11BTE		3 Avec rotule <i>With ball joint</i> 1.8 XU7JP 1.9 TD XUD9TE 2.0 XU10J2 2.0 Turbo XU10J2TE 2.0i 16v. EW10J4 XU10J4R 2.0 HDi DW10ATED/4 2.1 TD XUD11BTE



Support d'amortisseur
 Suspension mounting
 Soporte amortiguador
 Poduszka amortyzatora
 Опора амортизатора



0385165 OE 503868 		Support suspension G Left suspension mounting 1 TT /all models		0385175 OE 503870 		Support suspension D Right suspension mounting 1 TT /all models	
0355385 OE 503555 		Butée à billes G/D L/R ball bearing 2 TT /all models		0315395 OE 503139 		Coupelle amortisseur G/D L/R shock absorber cup 6 TT /all models Sauf 2.0 HDi Mot. DW10 08/09/00- Sauf 2.0i 16v. Mot. EW10J4 08/09/00-	
0315505 OE 503150 		Coupelle amortisseur G/D L/R shock absorber cup 6 2.0i 16v. EW10J4 08/09/00- 2.0 HDi DW10 08/09/00-		0335395 OE 503339 		Butée de suspension G/D L/R suspension bush 3 H105 TT /all models	
2545195 OE 525446 		Protecteur amortisseur G/D L/R shock absorber protector 4 TT /all models					
1005263 OE - 		Kit rép. suspension G Left susp. mounting repair kit DA 1.8 XU7JP 1.9 TD XUD9TE 2.0 XU10J2 2.0 Turbo XU10J2TE 2.0i 16v. EW10J4 XU10J4R 2.0 HDi DW10ATED/4 2.1 TD XUD11BTE		1005264 OE - 		Kit rép. suspension D Right susp. mounting repair kit DA 1.8 XU7JP 1.9 TD XUD9TE 2.0 XU10J2 2.0 Turbo XU10J2TE 2.0i 16v. EW10J4 XU10J4R 2.0 HDi DW10ATED/4 2.1 TD XUD11BTE	

... 806



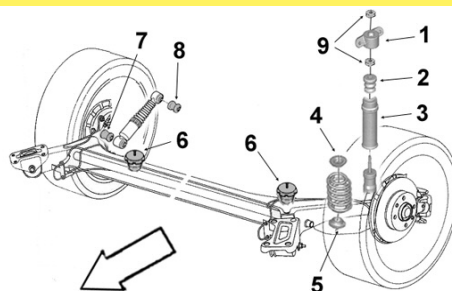

Support d'amortisseur
 Suspension mounting
 Soporte amortiguador
 Poduszka amortyzatora
 Опора амортизатора





PEUGEOT

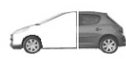

1645345 OE 516434	Coupelle sup. ressort AR <i>Rear spring upper cup</i>	1665475 OE 516647	Butée de talonnage <i>Bushing</i>
	4 TT /all models 10/05/95-		6 Ø 55 H102 TT /all models Anti devers AR standard

1665565 OE 516656	Butée de talonnage <i>Bushing</i>
	6 Ø 55 H 113 TT /all models Anti devers AR supérieur

Eléments TRAIN ARRIERE <i>Rear axle parts</i> <i>Tren TRAS</i> <i>Elementy zawieszenia tylnego</i> <i>элементы задней оси.</i>		1525615 OE 515261	Articulation essieu AR <i>Rear axle bush</i> Ø int.12 Ø ext.46 long. tube int.60 ext.48
			TT /all models

807 ...

Eléments DIRECTION
 Steering parts
 Elementos Direcciones
 Elementy uklad kierowniczy
 Элементы рулевой системы

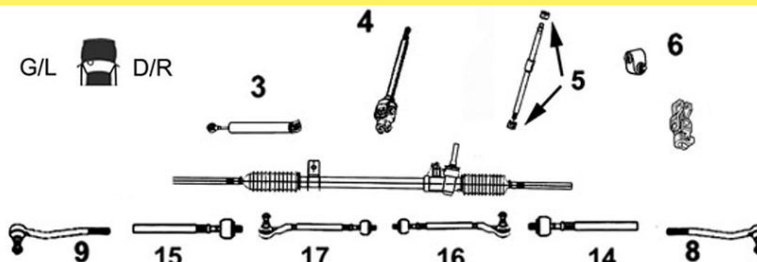

8123E23 OE 3812E2	Axe de bielle G/D <i>L/R axial joint</i>
	14 Côté dir. M14x1.5 Côté rot. M14x1.5 long 309 mm 15 2.0i 16v. EW10A/J4 2.0 HDi DW10ATED4 2.0 HDi FAP DW10BTED4 2.0 HDi FAP 136hp 100kw DW10CBDTR 2.0 HDi FAP DA mécanique DW10CTED4 26/09/05- 2.0 HDi FAP DA Electro hydraulique DW10CTED4 26/09/05-30/05/10 2.0 HDi DW10UTED4 2.2i 16v. EW12J4 2.2 HDi FAP DA mécanique DW12BTED4 26/09/05- 2.2 HDi DW12TED4 3.0i V6 ES9J4S

Eléments DIRECTION

Steering parts
Elementos Direcciones
Elementy układ kierowniczy
Элементы рулевой системы

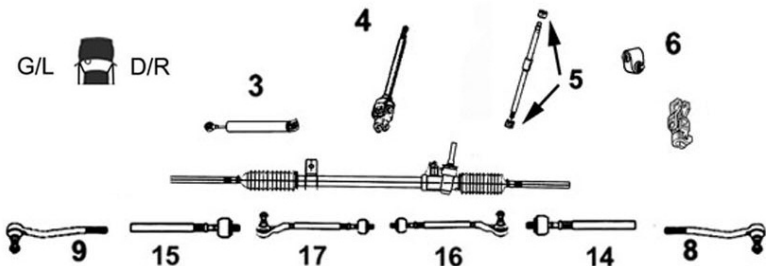

7770003

Axe de bielle G/D

Part/oe 3812F0

L/R axial joint



14 Côté dir. M16x1.5 Côté rot. M14x1.5 long 304 mm

15 DA Electro hydraulique

2.0 HDi FAP
2.2 HDi FAP

DW10CTED4
DW12BTED4

31/05/10-
-30/05/10

0594124

Rotule de direction G/D

OE 405912

L/R tie rod end



8 M14 x 1.5

9 2.0i 16v.
2.0 HDi
2.0 HDi FAP
2.0 HDi FAP 136hp 100kw
2.0 HDi FAP DA mécanique
2.0 HDi FAP DA Electro hydraulique
2.0 HDi
2.2i 16v.
2.2 HDi FAP DA mécanique
2.2 HDi
3.0i V6

EW10A/J4
DW10ATED4
DW10BTED4
DW10CBDTR
DW10CTED4
DW10CTED4
DW10UTED4
EW12J4
DW12BTED4
DW12TED4
ES9J4S

26/09/05-
26/09/05-30/05/10

26/09/05-

7670011

Rotule de direction G/D

OE 381773

L/R tie rod end



8 M14 x 1.5 DA Electro hydraulique

9 2.0 HDi FAP
2.2 HDi FAP

DW10CTED4
DW12BTED4

31/05/10-
-30/05/10



Barre stabilisatrice

Stabilizer bar
Barra estabilizadora
Drażek stabilizatora
стабилизатор поперечной устойчивости

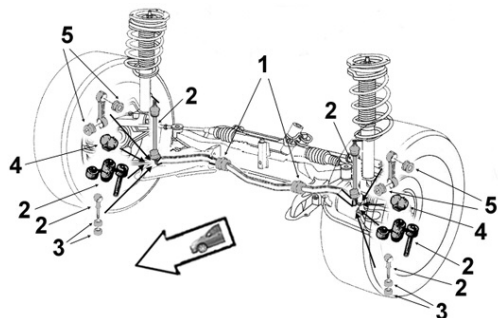

0875515

Biellette barre stab.

OE 508751

Stabilizer bar stub axle



2

2.0i 16v.
2.0 HDi
2.0 HDi FAP
2.2i 16v.
2.2 HDi
2.2 HDi FAP
3.0i V6





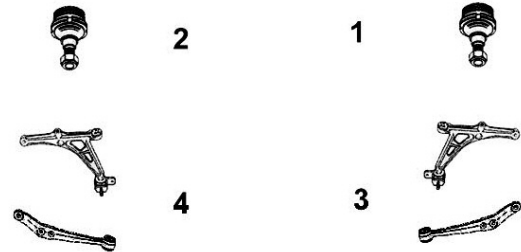

EW10A/ J4
DW10ATED4/UTED4
DW10BTED4/CTED4
EW12J4
DW12TED4/BTED4
DW12BTED4
ES9J4S

Bras & Triangle de suspension

Control arm
Brazo y triángulo
Wahacz
Рычаг подвески

G/L  D/R





<p>5203P63 OE 3520P6</p>	<p>Triangle de susp. G <i>Left track control arm</i></p>	<p>5213K63 OE 3521K6</p>	<p>Triangle de susp. D <i>Right track control arm</i></p>																																																
	<p>4 Avec rotule <i>With ball joint</i></p> <table border="0"> <tr><td>2.0i 16v.</td><td>EW10J4</td><td></td></tr> <tr><td>2.0i 16v.</td><td>EW10A</td><td>-27/06/06</td></tr> <tr><td>2.0 HDi</td><td>DW10ATED4</td><td>-27/06/06</td></tr> <tr><td>2.0 HDi</td><td>DW10UTED4</td><td>-27/06/06</td></tr> <tr><td>2.0 HDi FAP</td><td>DW10BTED4</td><td>-27/06/06</td></tr> <tr><td>2.2i 16v.</td><td>EW12J4</td><td></td></tr> <tr><td>2.2 HDi</td><td>DW12TED4</td><td>-27/06/06</td></tr> <tr><td>3.0i V6</td><td>ES9J4S</td><td></td></tr> </table>	2.0i 16v.	EW10J4		2.0i 16v.	EW10A	-27/06/06	2.0 HDi	DW10ATED4	-27/06/06	2.0 HDi	DW10UTED4	-27/06/06	2.0 HDi FAP	DW10BTED4	-27/06/06	2.2i 16v.	EW12J4		2.2 HDi	DW12TED4	-27/06/06	3.0i V6	ES9J4S			<p>3 Avec rotule <i>With ball joint</i></p> <table border="0"> <tr><td>2.0i 16v.</td><td>EW10J4</td><td></td></tr> <tr><td>2.0i 16v.</td><td>EW10A</td><td>-27/06/06</td></tr> <tr><td>2.0 HDi</td><td>DW10ATED4</td><td>-27/06/06</td></tr> <tr><td>2.0 HDi</td><td>DW10UTED4</td><td>-27/06/06</td></tr> <tr><td>2.0 HDi FAP</td><td>DW10BTED4</td><td>-27/06/06</td></tr> <tr><td>2.2i 16v.</td><td>EW12J4</td><td></td></tr> <tr><td>2.2 HDi</td><td>DW12TED4</td><td>-27/06/06</td></tr> <tr><td>3.0i V6</td><td>ES9J4S</td><td></td></tr> </table>	2.0i 16v.	EW10J4		2.0i 16v.	EW10A	-27/06/06	2.0 HDi	DW10ATED4	-27/06/06	2.0 HDi	DW10UTED4	-27/06/06	2.0 HDi FAP	DW10BTED4	-27/06/06	2.2i 16v.	EW12J4		2.2 HDi	DW12TED4	-27/06/06	3.0i V6	ES9J4S	
2.0i 16v.	EW10J4																																																		
2.0i 16v.	EW10A	-27/06/06																																																	
2.0 HDi	DW10ATED4	-27/06/06																																																	
2.0 HDi	DW10UTED4	-27/06/06																																																	
2.0 HDi FAP	DW10BTED4	-27/06/06																																																	
2.2i 16v.	EW12J4																																																		
2.2 HDi	DW12TED4	-27/06/06																																																	
3.0i V6	ES9J4S																																																		
2.0i 16v.	EW10J4																																																		
2.0i 16v.	EW10A	-27/06/06																																																	
2.0 HDi	DW10ATED4	-27/06/06																																																	
2.0 HDi	DW10UTED4	-27/06/06																																																	
2.0 HDi FAP	DW10BTED4	-27/06/06																																																	
2.2i 16v.	EW12J4																																																		
2.2 HDi	DW12TED4	-27/06/06																																																	
3.0i V6	ES9J4S																																																		
<p>7470015 OE 1607510680</p>	<p>Triangle de susp. G <i>Left track control arm</i></p>	<p>7470014 OE 1607510780</p>	<p>Triangle de susp. D <i>Right track control arm</i></p>																																																
	<p>4 Avec rotule <i>With ball joint Ø 17</i></p> <table border="0"> <tr><td>2.0i 16v.</td><td>EW10A</td><td>28/06/06-</td></tr> <tr><td>2.0 HDi</td><td>DW10ATED4</td><td>28/06/06-</td></tr> <tr><td>2.0 HDi</td><td>DW10UTED4</td><td>28/06/06-</td></tr> <tr><td>2.0 HDi FAP</td><td>DW10BTED4</td><td>28/06/06-</td></tr> <tr><td>2.0 HDi FAP</td><td>136hp 100kw</td><td></td></tr> <tr><td></td><td>DW10CBDTR</td><td></td></tr> <tr><td>2.2 HDi</td><td>DW12TED4</td><td>28/06/06-</td></tr> </table>	2.0i 16v.	EW10A	28/06/06-	2.0 HDi	DW10ATED4	28/06/06-	2.0 HDi	DW10UTED4	28/06/06-	2.0 HDi FAP	DW10BTED4	28/06/06-	2.0 HDi FAP	136hp 100kw			DW10CBDTR		2.2 HDi	DW12TED4	28/06/06-		<p>3 Avec rotule <i>With ball joint Ø 17</i></p> <table border="0"> <tr><td>2.0i 16v.</td><td>EW10A</td><td>28/06/06-</td></tr> <tr><td>2.0 HDi</td><td>DW10ATED4</td><td>28/06/06-</td></tr> <tr><td>2.0 HDi</td><td>DW10UTED4</td><td>28/06/06-</td></tr> <tr><td>2.0 HDi FAP</td><td>DW10BTED4</td><td>28/06/06-</td></tr> <tr><td>2.0 HDi FAP</td><td>136hp 100kw</td><td></td></tr> <tr><td></td><td>DW10CBDTR</td><td></td></tr> <tr><td>2.2 HDi</td><td>DW12TED4</td><td>28/06/06-</td></tr> </table>	2.0i 16v.	EW10A	28/06/06-	2.0 HDi	DW10ATED4	28/06/06-	2.0 HDi	DW10UTED4	28/06/06-	2.0 HDi FAP	DW10BTED4	28/06/06-	2.0 HDi FAP	136hp 100kw			DW10CBDTR		2.2 HDi	DW12TED4	28/06/06-						
2.0i 16v.	EW10A	28/06/06-																																																	
2.0 HDi	DW10ATED4	28/06/06-																																																	
2.0 HDi	DW10UTED4	28/06/06-																																																	
2.0 HDi FAP	DW10BTED4	28/06/06-																																																	
2.0 HDi FAP	136hp 100kw																																																		
	DW10CBDTR																																																		
2.2 HDi	DW12TED4	28/06/06-																																																	
2.0i 16v.	EW10A	28/06/06-																																																	
2.0 HDi	DW10ATED4	28/06/06-																																																	
2.0 HDi	DW10UTED4	28/06/06-																																																	
2.0 HDi FAP	DW10BTED4	28/06/06-																																																	
2.0 HDi FAP	136hp 100kw																																																		
	DW10CBDTR																																																		
2.2 HDi	DW12TED4	28/06/06-																																																	
<p>7470001 OE 3520V8</p>	<p>Triangle de susp. G <i>Left track control arm</i></p>	<p>7470002 OE 3521S0</p>	<p>Triangle de susp. D <i>Right track control arm</i></p>																																																
	<p>4 Avec rotule <i>With ball joint</i></p> <table border="0"> <tr><td>2.0 HDi FAP</td><td>DW10CTED4</td><td></td></tr> <tr><td>2.2 HDi FAP</td><td>DW12BTED4</td><td></td></tr> </table>	2.0 HDi FAP	DW10CTED4		2.2 HDi FAP	DW12BTED4			<p>3 Avec rotule <i>With ball joint</i></p> <table border="0"> <tr><td>2.0 HDi FAP</td><td>DW10CTED4</td><td></td></tr> <tr><td>2.2 HDi FAP</td><td>DW12BTED4</td><td></td></tr> </table>	2.0 HDi FAP	DW10CTED4		2.2 HDi FAP	DW12BTED4																																					
2.0 HDi FAP	DW10CTED4																																																		
2.2 HDi FAP	DW12BTED4																																																		
2.0 HDi FAP	DW10CTED4																																																		
2.2 HDi FAP	DW12BTED4																																																		

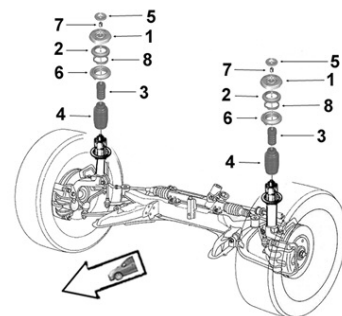

Support d'amortisseur

Suspension mounting
Soporte amortiguador
Poduszka amortyzatora
Опора амортизатора



<p>0385165 OE 503868</p>	<p>Support suspension G <i>Left suspension mounting</i></p>	<p>0385175 OE 503870</p>	<p>Support suspension D <i>Right suspension mounting</i></p>																																										
	<p>1</p> <table border="0"> <tr><td>2.0i 16v.</td><td>EW10A/J4</td><td></td></tr> <tr><td>2.0 HDi</td><td>DW10ATED4/UTED4</td><td></td></tr> <tr><td>2.0 HDi FAP</td><td>DW10BTED4/CTED4</td><td></td></tr> <tr><td>2.2i 16v.</td><td>EW12J4</td><td></td></tr> <tr><td>2.2 HDi</td><td>DW12TED4</td><td></td></tr> <tr><td>2.2 HDi FAP</td><td>DW12BTED4</td><td></td></tr> <tr><td>3.0i V6</td><td>ES9J4S</td><td></td></tr> </table>	2.0i 16v.	EW10A/J4		2.0 HDi	DW10ATED4/UTED4		2.0 HDi FAP	DW10BTED4/CTED4		2.2i 16v.	EW12J4		2.2 HDi	DW12TED4		2.2 HDi FAP	DW12BTED4		3.0i V6	ES9J4S			<p>1</p> <table border="0"> <tr><td>2.0i 16v.</td><td>EW10A/J4</td><td></td></tr> <tr><td>2.0 HDi</td><td>DW10ATED4/UTED4</td><td></td></tr> <tr><td>2.0 HDi FAP</td><td>DW10BTED4/CTED4</td><td></td></tr> <tr><td>2.2i 16v.</td><td>EW12J4</td><td></td></tr> <tr><td>2.2 HDi</td><td>DW12TED4</td><td></td></tr> <tr><td>2.2 HDi FAP</td><td>DW12BTED4</td><td></td></tr> <tr><td>3.0i V6</td><td>ES9J4S</td><td></td></tr> </table>	2.0i 16v.	EW10A/J4		2.0 HDi	DW10ATED4/UTED4		2.0 HDi FAP	DW10BTED4/CTED4		2.2i 16v.	EW12J4		2.2 HDi	DW12TED4		2.2 HDi FAP	DW12BTED4		3.0i V6	ES9J4S	
2.0i 16v.	EW10A/J4																																												
2.0 HDi	DW10ATED4/UTED4																																												
2.0 HDi FAP	DW10BTED4/CTED4																																												
2.2i 16v.	EW12J4																																												
2.2 HDi	DW12TED4																																												
2.2 HDi FAP	DW12BTED4																																												
3.0i V6	ES9J4S																																												
2.0i 16v.	EW10A/J4																																												
2.0 HDi	DW10ATED4/UTED4																																												
2.0 HDi FAP	DW10BTED4/CTED4																																												
2.2i 16v.	EW12J4																																												
2.2 HDi	DW12TED4																																												
2.2 HDi FAP	DW12BTED4																																												
3.0i V6	ES9J4S																																												



Support d'amortisseur
 Suspension mounting
 Soporte amortiguador
 Poduszka amortyzatora
 Опора амортизатора

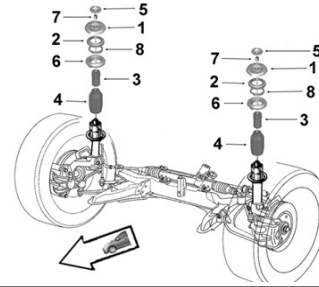

0355385
 OE 503555

Butée à billes G/D
 L/R ball bearing



2

2.0i 16v. EW10A/J4
 2.0 HDi DW10ATED4/UTED4
 2.0 HDi FAP DW10BTED4/CTED4
 2.2i 16v. EW12J4
 2.2 HDi DW12TED4
 2.2 HDi FAP DW12BTED4
 3.0i V6 ES9J4S

0315505
 OE 503150

Coupelle amortisseur G/D
 L/R shock absorber cup



6

2.0i 16v. EW10A/J4
 2.0 HDi DW10UTED4 /ATED4
 2.0 HDi FAP DW10BTED4 /CTED4
 2.2i 16v. EW12J4
 2.2 HDi DW12TED4
 2.2 HDi FAP DW12BTED4
 3.0i V6 ES9J4S

2650012
 OE 5033A5

Butée de suspension G/D
 L/R suspension bush



3

H 111
 2.0i 16v. EW10J4 25/05/04-
 2.0i 16v. EW10A
 2.0 HDi DW10ATED4 /UTED4
 2.0 HDi FAP DW10BTED4/CTED4
 2.2i 16v. EW12J4 25/05/04-
 2.2 HDi DW12TED4
 2.2 HDi FAP DW12BTED4
 3.0i V6 ES9J4S

2545195
 OE 525446

Protecteur amortisseur G/D
 L/R shock absorber protector



4

2.0i 16v. EW10A/J4
 2.0 HDi DW10ATED4/UTED4
 2.0 HDi FAP DW10BTED4/CTED4
 2.2i 16v. EW12J4
 2.2 HDi DW12TED4
 2.2 HDi FAP DW12BTED4
 3.0i V6 ES9J4S



Support d'amortisseur
 Suspension mounting
 Soporte amortiguador
 Poduszka amortyzatora
 Опора амортизатора

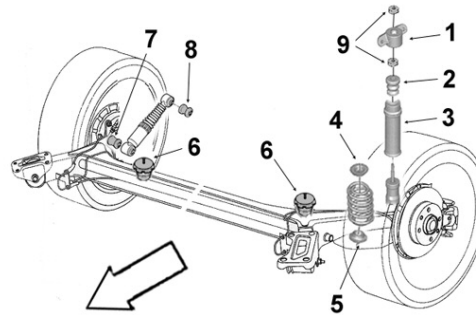

1645345
 OE 516434

Coupelle sup. ressort AR
 Rear spring upper cup



4

2.0i 16v. EW10A/J4
 2.0 HDi DW10ATED4/UTED4
 2.0 HDi FAP DW10BTED4/CTED4
 2.2i 16v. EW12J4
 2.2 HDi DW12TED4
 2.2 HDi FAP DW12BTED4
 3.0i V6 ES9J4S

1665475
 OE 516647

Butée de talonnage
 Bushing



6

Ø 55 H102
 2.0i 16v. EW10A/J4
 2.0 HDi DW10ATED4/UTED4
 2.0 HDi FAP DW10BTED4/CTED4
 2.2i 16v. EW12J4
 2.2 HDi DW12TED4
 2.2 HDi FAP DW12BTED4

1665695
 OE 516669

Butée de talonnage
 Bushing



6

H102
 3.0i V6 ES9J4S

Bipper VL ...

Eléments DIRECTION
 Steering parts
 Elementos Direcciones
 Elementy układ kierowniczy
 Элементы рулевой системы

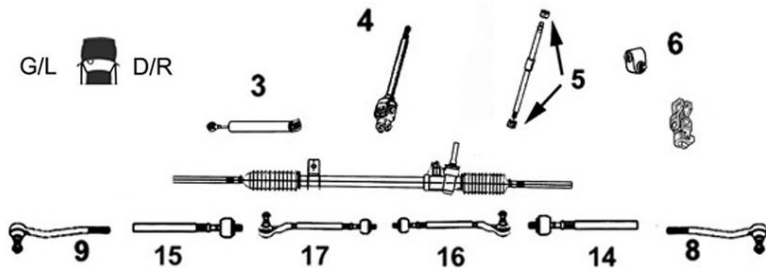

7770013 **Axe de bielle G/D**
 Part/oe 400177 L/R axial joint

NEW



14 Côté dir. M14x1.5 Côté rot. M14x1.5 long 276 mm
15

1.3 HDi FAP	F13DTE5	BVM
1.4i	TU3A/E5	
1.4 HDi	DV4TED	

7670008 **Rotule de direction G**
 OE 381786 Left tie rod end



9 M14 x 1.5

1.3 HDi FAP	F13DTE5
1.4i	TU3A/E5
1.4 HDi	DV4TED

7670009 **Rotule de direction D**
 OE 381787 Right tie rod end



8 M14 x 1.5

1.3 HDi FAP	F13DTE5
1.4i	TU3A/E5
1.4 HDi	DV4TED



Barre stabilisatrice
 Stabilizer bar
 Barra estabilizadora
 Drażek stabilizatora
 стабилизатор поперечной устойчивости

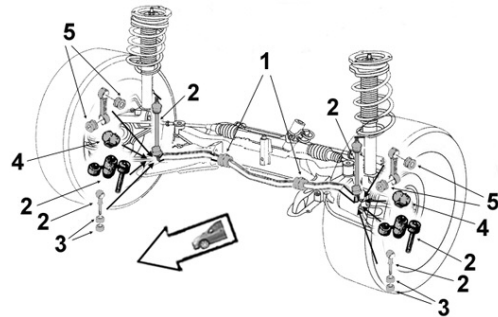

2300029 **Biellette barre stab.**
 OE 508779 Stabilizer bar stub axle



2

1.3 HDi FAP	F13DTE5
1.4i	TU3A/E5
1.4 HDi	DV4TED

2300043 **Palier de barre milieu**
 OE 5094C8 Middle bar main bearing



1 Barre Ø 20

1.3 HDi FAP	F13DTE5	-17/12/07
1.4i	TU3A/E5	-17/12/07
1.4 HDi	DV4TED	-17/12/07

2300041 **Palier de barre milieu**
 OE 5094E5 Middle bar main bearing



1 Barre Ø 21

1.3 HDi FAP	F13DTE5	18/12/07-
1.4i	TU3A/E5	18/12/07-
1.4 HDi	DV4TED	18/12/07-

... Bipper VL ...



Eléments SUSPENSION
 Suspension parts
 Elementos suspensión
 Elementy zawieszenie
 Элементы подвески

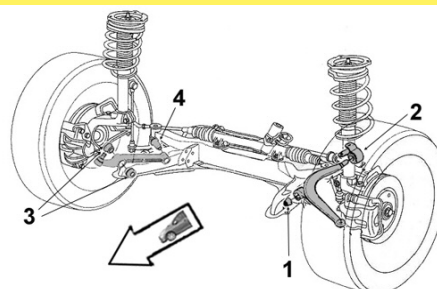

PEUGEOT



2256032

Articulation AV

Part/oe 3520Y4

Front bush



1 Ø int. 12.5 Ø ext. 42 coll. 43 coll. 50.5
 long.tube int. 67.5 ext. 41

1.3 HDi FAP
 1.4i
 1.4 HDi

F13DTE5
 TU3A/E5
 DV4TED

2256009

Articulation AR

Part/oe 3520Y4

Rear bush



2 Ø int. 12.5 Ø ext. 73
 long. tube int. 66 ext. 27.5

1.3 HDi FAP
 1.4i
 1.4 HDi

F13DTE5
 TU3A/E5
 DV4TED

Bras & Triangle de suspension

Control arm
 Brazo y triángulo
 Wahacz
 Рычаг подвески

G/L D/R



7470005

Triangle de susp. G

OE 3520Y4

Left track control arm



4 Avec rotule With ball joint

1.3 HDi FAP
 1.4i
 1.4 HDi

F13DTE5
 TU3A/E5
 DV4TED

7470006

Triangle de susp. D

OE 3521V5

Right track control arm



3 Avec rotule With ball joint

1.3 HDi FAP
 1.4i
 1.4 HDi

F13DTE5
 TU3A/E5
 DV4TED

7570004

Rotule de susp. inf. G/D

Part/oe 3520Y4

L/R lower suspension ball joint



1
2

1.3 HDi FAP
 1.4i
 1.4 HDi

F13DTE5
 TU3A/E5
 DV4TED

... Bipper VL



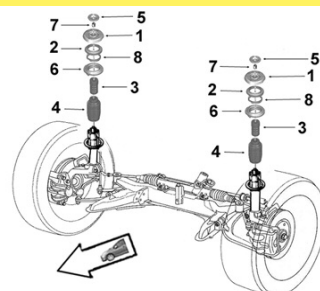

Support d'amortisseur
Suspension mounting
Soporte amortiguador
Poduszka amortyzatora
Опора амортизатора



PEUGEOT



2650031 OE 1609274780	Support suspension G <i>Left suspension mounting</i>	2650032 OE 1609274680	Support suspension D <i>Right suspension mounting</i>
1		1	
	1.3 HDi FAP F13DTE5 1.4i TU3A/E5 1.4 HDi DV4TED		1.3 HDi FAP F13DTE5 1.4i TU3A/E5 1.4 HDi DV4TED

2650025 OE 5033F2	Butée de suspension G/D <i>L/R suspension bush</i>
3	
	1.3 HDi FAP F13DTE5 1.4i TU3A/E5 1.4 HDi DV4TED

Eléments TRAIN ARRIERE <i>Rear axle parts</i> <i>Tren TRAS</i> <i>Elementy zawieszenia tylnego</i> <i>элементы задней оси.</i>	
	2600012 OE 5131G8 Articulation essieu <i>Axle bush</i>
	
	Ø int. 13 Ø ext. 69 coll. 80 long. tube int.94 ext. 100 ep. coll. 2.5 1.3 HDi FAP F13DTE5 1.4i TU3A/E5 1.4 HDi DV4TED

Expert VL ...

Eléments DIRECTION
Steering parts
Elementos Direcciones
Elementy uklad kierowniczy
Элементы рулевой системы

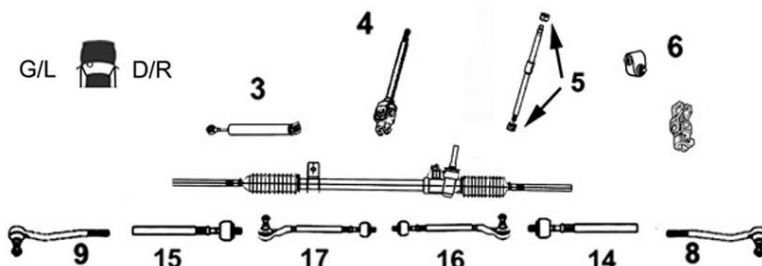

3008069 OE 3812A4	Axe de bielle G/D <i>L/R axial joint</i>
14 15	
	Côté dir. M14x1.5 Côté rot. M14x1.5 long 306 mm 1.6i -12/06 1.9 D -12/06 1.9 TD -12/06 2.0i 16v. -12/06 2.0 HDi -12/06





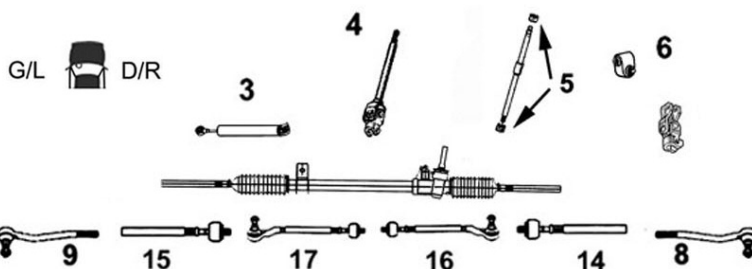

... Expert VL ...

Eléments DIRECTION
Steering parts
Elementos Direcciones
Elementy układ kierowniczy
Элементы рулевой системы



PEUGEOT

SASIC

<p>7770003 Part/oe 3812F0</p> 	<p>Axe de bielle G/D <i>L/R axial joint</i></p> <p>14 Côté dir. M16x1.5 Côté rot. M14x1.5 15 long 304 mm</p> <table border="0"> <tr><td>1.6 HDi</td><td>DV6DU M/UC</td><td>01/07-</td></tr> <tr><td>1.6 HDi</td><td>DV6UTED4</td><td>01/07-</td></tr> <tr><td>2.0i 16v.</td><td>EW10A</td><td>01/07-</td></tr> <tr><td>2.0 HDi FAP</td><td>DW10CD/CE DTR</td><td>01/07-</td></tr> <tr><td>2.0 HDi</td><td>DW10UTED4</td><td>01/07-</td></tr> <tr><td>2.0 HDi FAP</td><td>DW10BTED4/CTED4</td><td>01/07-</td></tr> </table>	1.6 HDi	DV6DU M/UC	01/07-	1.6 HDi	DV6UTED4	01/07-	2.0i 16v.	EW10A	01/07-	2.0 HDi FAP	DW10CD/CE DTR	01/07-	2.0 HDi	DW10UTED4	01/07-	2.0 HDi FAP	DW10BTED4/CTED4	01/07-	<p>0594094 OE 405909</p> 	<p>Rotule de direction G/D <i>L/R tie rod end</i></p> <p>8 9 M14 x 1.5</p> <table border="0"> <tr><td>1.6i</td><td>-08/03</td></tr> <tr><td>1.9 D</td><td>-08/03</td></tr> <tr><td>1.9 TD</td><td>-08/03</td></tr> <tr><td>2.0i 16v.</td><td>-08/03</td></tr> <tr><td>2.0 HDi</td><td>-08/03</td></tr> </table>	1.6i	-08/03	1.9 D	-08/03	1.9 TD	-08/03	2.0i 16v.	-08/03	2.0 HDi	-08/03
1.6 HDi	DV6DU M/UC	01/07-																													
1.6 HDi	DV6UTED4	01/07-																													
2.0i 16v.	EW10A	01/07-																													
2.0 HDi FAP	DW10CD/CE DTR	01/07-																													
2.0 HDi	DW10UTED4	01/07-																													
2.0 HDi FAP	DW10BTED4/CTED4	01/07-																													
1.6i	-08/03																														
1.9 D	-08/03																														
1.9 TD	-08/03																														
2.0i 16v.	-08/03																														
2.0 HDi	-08/03																														
<p>0594124 OE 405912</p> 	<p>Rotule de direction G/D <i>L/R tie rod end</i></p> <p>8 9 M14 x 1.5</p> <table border="0"> <tr><td>1.9 D</td><td>09/03-12/03</td></tr> <tr><td>1.9 TD</td><td>09/03-12/03</td></tr> <tr><td>2.0i 16v.</td><td>09/03-12/06</td></tr> <tr><td>2.0 HDi</td><td>09/03-12/06</td></tr> </table>			1.9 D	09/03-12/03	1.9 TD	09/03-12/03	2.0i 16v.	09/03-12/06	2.0 HDi	09/03-12/06																				
1.9 D	09/03-12/03																														
1.9 TD	09/03-12/03																														
2.0i 16v.	09/03-12/06																														
2.0 HDi	09/03-12/06																														
<p>7670011 OE 381773</p> 	<p>Rotule de direction G/D <i>L/R tie rod end</i></p> <p>8 9 M14 x 1.5</p> <table border="0"> <tr><td>1.6 HDi</td><td>DV6DU M</td><td>DV6UC</td><td>DV6UTED4</td><td>01/07-</td></tr> <tr><td>2.0i 16v.</td><td>EW10A</td><td></td><td></td><td>01/07-</td></tr> <tr><td>2.0 HDi</td><td>DW10UTED4</td><td></td><td></td><td>01/07-</td></tr> <tr><td>2.0 HDi FAP</td><td>DW10CE/CD DTR</td><td>DW10BTED4/CTED4</td><td></td><td>01/07-</td></tr> </table>			1.6 HDi	DV6DU M	DV6UC	DV6UTED4	01/07-	2.0i 16v.	EW10A			01/07-	2.0 HDi	DW10UTED4			01/07-	2.0 HDi FAP	DW10CE/CD DTR	DW10BTED4/CTED4		01/07-								
1.6 HDi	DV6DU M	DV6UC	DV6UTED4	01/07-																											
2.0i 16v.	EW10A			01/07-																											
2.0 HDi	DW10UTED4			01/07-																											
2.0 HDi FAP	DW10CE/CD DTR	DW10BTED4/CTED4		01/07-																											
<p>1234A74 OE 4123A7</p> 	<p>Axe de volant <i>Steering wheel shaft</i></p> <p>4 Conduite à G DNA</p> <table border="0"> <tr><td>1.6i</td><td>-12/06</td></tr> <tr><td>1.9 D</td><td>-12/06</td></tr> <tr><td>1.9 TD</td><td>-12/06</td></tr> <tr><td>2.0i 16v.</td><td>-12/06</td></tr> <tr><td>2.0 HDi</td><td>-12/06</td></tr> </table>	1.6i	-12/06	1.9 D	-12/06	1.9 TD	-12/06	2.0i 16v.	-12/06	2.0 HDi	-12/06	<p>1034F64 OE 4103F6</p> 	<p>Axe de volant <i>Steering wheel shaft</i></p> <p>4 Conduite à G DA</p> <table border="0"> <tr><td>1.6i</td><td>-12/06</td></tr> <tr><td>1.9 D</td><td>-12/06</td></tr> <tr><td>1.9 TD</td><td>-12/06</td></tr> <tr><td>2.0i 16v.</td><td>-12/06</td></tr> <tr><td>2.0 HDi</td><td>-12/06</td></tr> </table>	1.6i	-12/06	1.9 D	-12/06	1.9 TD	-12/06	2.0i 16v.	-12/06	2.0 HDi	-12/06								
1.6i	-12/06																														
1.9 D	-12/06																														
1.9 TD	-12/06																														
2.0i 16v.	-12/06																														
2.0 HDi	-12/06																														
1.6i	-12/06																														
1.9 D	-12/06																														
1.9 TD	-12/06																														
2.0i 16v.	-12/06																														
2.0 HDi	-12/06																														
<p>1034F74 OE 4103F7</p> 	<p>Axe de volant <i>Steering wheel shaft</i></p> <p>4 Conduite à D DA</p> <table border="0"> <tr><td>1.6i</td><td>-12/06</td></tr> <tr><td>1.8i</td><td>-12/06</td></tr> <tr><td>1.9 D</td><td>-12/06</td></tr> <tr><td>1.9 TD</td><td>-12/06</td></tr> <tr><td>2.0i 16v.</td><td>-12/06</td></tr> <tr><td>2.0 HDi</td><td>-12/06</td></tr> </table>			1.6i	-12/06	1.8i	-12/06	1.9 D	-12/06	1.9 TD	-12/06	2.0i 16v.	-12/06	2.0 HDi	-12/06																
1.6i	-12/06																														
1.8i	-12/06																														
1.9 D	-12/06																														
1.9 TD	-12/06																														
2.0i 16v.	-12/06																														
2.0 HDi	-12/06																														

... Expert VL ...





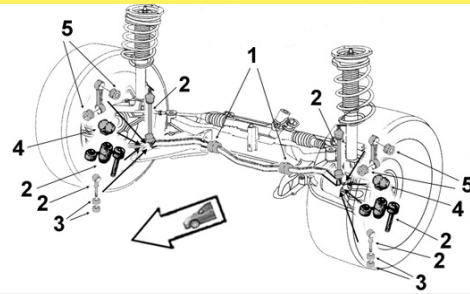





Barre stabilisatrice
 Stabilizer bar
 Barra estabilizadora
 Drażek stabilizatora
 стабилизатор поперечной устойчивости



PEUGEOT



<p>0875355 OE 508735</p> 	<p>Biellette barre stab. <i>Stabilizer bar stub axle</i></p> <p>2</p> <p>TT /all models -12/06</p>	<p>2300028 OE 508756</p> 	<p>Biellette barre stab. <i>Stabilizer bar stub axle</i></p> <p>2 Tepe BVM</p> <p>1.6 HDi DV6UTED4 01/07- 2.0i 16v. EW10ABE4 06/07- 2.0 HDi FAP DW10BTED4 01/07- 2.0 HDi DW10UTED4 01/07-</p>
<p>0935155 OE 509315</p> 	<p>Liaison élastique <i>Elastic link</i></p> <p>3 Ø int.12.5 Ø ext.37.5 long. tube int.20 ext.22</p> <p>TT /all models -12/06</p>	<p>0945695 OE 509469</p> 	<p>Palier de barre milieu <i>Middle bar main bearing</i></p> <p>1 Barre Ø 24</p> <p>TT /all models -12/06</p>
<p>2300045 Palier de barre milieu Part/oe 1440177280 <i>Middle bar main bearing</i></p> <p>1 Barre Ø 25 2ème montage 01/07-</p> <p>1.6 HDi DV6UC/TED4 12/11- 1.6 HDi DV6DU M 12/11- 2.0i 16v. EW10A 12/11- 2.0 HDi FAP DW10BTED4/CTED4 12/11- 2.0 HDi FAP DW10UTED4 12/11- 2.0 HDi FAP DW10CD/CE DTR 12/11-</p>			
<p>Bras & Triangle de suspension <i>Control arm</i> Brazo y triángulo Wahacz Рычаг подвески</p> <p style="text-align: center;">G/L  D/R</p> <div style="display: flex; justify-content: space-around;"> <div style="text-align: center;">  <p>2</p> <p>4</p> </div> <div style="text-align: center;">  <p>1</p> <p>3</p> </div> </div>			
<p>5203943 OE 3520P4</p> 	<p>Triangle de susp. G <i>Left track control arm</i></p> <p>4 Avec rotule With ball joint</p> <p>1.6i 1580 SPi -01/05/00 1.9 D DW8/B 13/11/95-28/03/06 1.9 D XUD9 -01/07/98 1.9 TD XUD9TE -12/10/03 2.0i 16v. EW10J4 13/11/95-28/03/06 2.0 HDi DW10ATED/4 13/11/95-28/03/06 2.0 HDi DW10BTED/+ W3/W4 13/11/95-28/03/06</p>	<p>5213643 OE 3521K4</p> 	<p>Triangle de susp. D <i>Right track control arm</i></p> <p>3 Avec rotule With ball joint</p> <p>1.6i 1580 SPi -01/05/00 1.9 D DW8/B 13/11/95-28/03/06 1.9 D XUD9 -01/07/98 1.9 TD XUD9TE -12/10/03 2.0i 16v. EW10J4 13/11/95-28/03/06 2.0 HDi DW10ATED/4 13/11/95-28/03/06 2.0 HDi DW10BTED/+ W3/W4 13/11/95-28/03/06</p>

... Expert VL ...

SASIC

PEUGEOT

Bras & Triangle de suspension

Control arm
Brazo y triángulo
Wahacz
Рычаг подвески

G/L  D/R

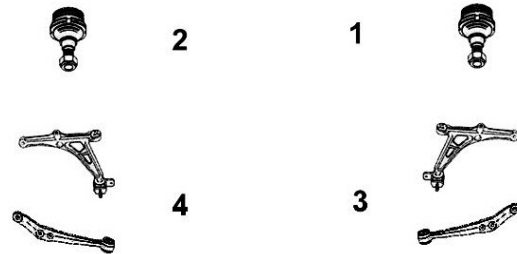

7470021
OE 3520S6

Triangle de susp. G
Left track control arm

NEW



4 Avec rotule With ball joint
Animation gamme U65
2.0 HDi DW10BTED + 04/07/06-12/06
2.0 HDi DW10BTED W4 04/07/06-12/06

7470022
OE 3521P7

Triangle de susp. D
Right track control arm

NEW



3 Avec rotule With ball joint
Animation gamme U65
2.0 HDi DW10BTED + 04/07/06-12/06
2.0 HDi DW10BTED W4 04/07/06-12/06

7470001
OE 3520R8

Triangle de susp. G
Left track control arm



4 Avec rotule With ball joint
1.6 HDi DV6DU M 01/07-
1.6 HDi DV6UC/UTED4 01/07-
2.0i 16v. EW10A 01/07-
2.0 HDi FAP DW10CD/CE DTR 01/07-
2.0 HDi FAP DW10BTED4/CTED4 01/07-
2.0 HDi DW10UTED4 01/07-

7470002
OE 3521N9

Triangle de susp. D
Right track control arm



3 Avec rotule With ball joint
1.6 HDi DV6DU M 01/07-
1.6 HDi DV6UC/UTED4 01/07-
2.0i 16v. EW10A 01/07-
2.0 HDi FAP DW10CD/CE DTR 01/07-
2.0 HDi FAP DW10BTED4/CTED4 01/07-
2.0 HDi DW10UTED4 01/07-



Support d'amortisseur
Suspension mounting
Soporte amortiguador
Poduszka amortyzatora
Опора амортизатора

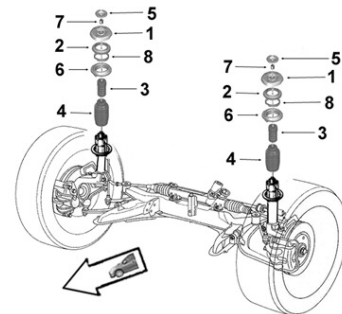

0385175
OE 503870

Support suspension G
Left suspension mounting



1
TT /all models DNA -12/06

0385165
OE 503868

Support suspension D
Right suspension mounting



1
TT /all models DNA -12/06

0385165
OE 503868

Support suspension G
Left suspension mounting



1
TT /all models DA -12/06

0385175
OE 503870

Support suspension D
Right suspension mounting









1
TT /all models DA -12/06

... Expert VL ...

PEUGEOT



0355385		Butée à billes G/D		0315395		Coupelle amortisseur G/D		
OE 503555		<i>L/R ball bearing</i>		OE 503139		<i>L/R shock absorber cup</i>		
	2	TT /all models -12/06			6	TT /all models		
		1.6 HDi	DV6UTED4			01/07-	Bonne route & Route inégale -07/09/00	
		2.0i 16v.	EW10A			01/07-		
		2.0 HDi	DW10UTED4			01/07-		
		2.0 HDi	DW10BTED4			01/07-		
		2.0 HDi	DW10CTED4			01/07-		
0315505		Coupelle amortisseur G/D						
OE 503150		<i>L/R shock absorber cup</i>						
	6	1.6 HDi	DV6UTED4	01/07-				
		1.9 D	Bonne route	DW8	08/09/00-12/06			
		1.9 D	Bonne route Gamme U64	DW8B	-01/05/04			
		1.9 D	Route inégale	DW8/B	08/09/00-12/06			
		2.0i 16v.	Bonne route Gamme U64	EW10J4	08/09/00-12/06			
		2.0i 16v.	Bonne route Gamme U65	EW10J4	09/03-12/06			
		2.0i 16v.	Route inégale	EW10J4	08/09/00-12/06			
		2.0i 16v.		EW10A	01/07-			
		2.0 HDi	Bonne route	DW10BTED W3	08/09/00-12/06			
		2.0 HDi	Bonne route Gamme U64	DW10BTEDW4/+	-01/05/04			
		2.0 HDi	Bonne route Gamme U65	DW10BTEDW4/+	09/03-12/06			
		2.0 HDi	Route inégale	DW10	08/09/00-12/06			
		2.0 HDi		DW10UTED4	01/07-			
		2.0 HDi		DW10BTED4	01/07-			
2.0 HDi		DW10CTED4	01/07-					
2.0 HDi sans FAP	Bonne route Gamme U65	DW10ATED4	-12/06					
0335395		Butée de suspension G/D						
OE 503339		<i>L/R suspension bush</i>						
	3	H105						
		TT /all models -12/06						
2650012		Butée de suspension G/D						
OE 5033A5		<i>L/R suspension bush</i>						
	3	H 111 Susp. normale /Susp. renforcée AV AR						
		1.6 HDi	DV6UTED4 BVM BE4R	01/07-				
		2.0i 16v.	EW10A BVM BE4R	01/07-				
		2.0 HDi	DW10UTED4 ML6C	01/07-				
		2.0 HDi FAP	DW10BTED4	01/07-				
2545195		Protecteur amortisseur G/D						
OE 525446		<i>L/R shock absorber protector</i>						
	4	TT /all models -12/06						
		1.6 HDi	DV6UTED4	01/07-				
		2.0i 16v.	EW10A	01/07-				
		2.0 HDi	DW10UTED4	01/07-				
		2.0 HDi	DW10CTED4	01/07-				
		2.0 HDi FAP	DW10BTED4 /UTED4	01/07-				

... Expert VL ...

SASIC

PEUGEOT



Support d'amortisseur
Suspension mounting
Soporte amortiguador
Poduszka amortyzatora
Опора амортизатора

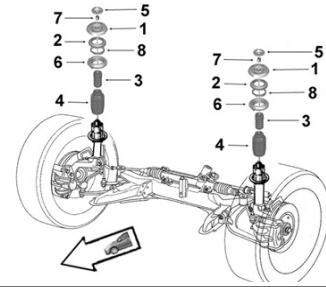

1005264 OE -	Kit rép. suspension G <i>Left susp. mounting repair kit</i>	1005263 OE -	Kit rép. suspension D <i>Right susp. mounting repair kit</i>
	DNA 1.6i -12/06 1.9 D -12/06 1.9 TD -12/06 2.0i 16v. -12/06 2.0 HDi -12/06		DNA 1.6i -12/06 1.9 D -12/06 1.9 TD -12/06 2.0i 16v. -12/06 2.0 HDi -12/06

1005263 OE -	Kit rép. suspension G <i>Left susp. mounting repair kit</i>	1005264 OE -	Kit rép. suspension D <i>Right susp. mounting repair kit</i>
	DA 1.6i -12/06 1.9 D -12/06 1.9 TD -12/06 2.0i 16v. -12/06 2.0 HDi -12/06		DA 1.6i -12/06 1.9 D -12/06 1.9 TD -12/06 2.0i 16v. -12/06 2.0 HDi -12/06



Support d'amortisseur
Suspension mounting
Soporte amortiguador
Poduszka amortyzatora
Опора амортизатора

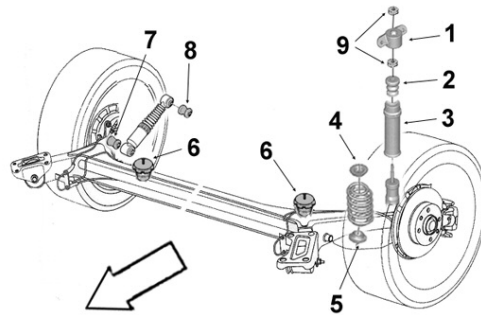

1645345 OE 516434	Coupelle sup. ressort AR <i>Rear spring upper cup</i>		
	4	TT /all models U65 sans barre anti devers AV 09/03-12/06 1.6i Sans barre anti devers AV 1580 SPi -12/06 1.6 HDi Susp. métallique DV6UTED4 01/07- 1.9 D sans barre anti devers AV DW8/B XUD9 -12/06 1.9 TD sans barre anti devers AV XUD9TE -12/06 2.0i 16v. Susp. métallique EW10A 01/07- 2.0 HDi FAP Susp. métallique DW10BTED4/UTED4 01/07-	

1665475 OE 516647	Butée de talonnage <i>Bushing</i>	1665565 OE 516656	Butée de talonnage <i>Bushing</i>
	6 Ø55 H102 Sans barre anti devers AV		6 Ø55 H113 sans barre anti devers AV
	1.6i 1580 SPi -17/02/98 1.9 D XUD9 -17/02/98 1.9 TD XUD9TE -17/02/98		TT /all models Sauf 1.6i 1580 SPI -17/02/98 Sauf 1.8i Mot. XU7JP -17/02/98 Sauf 1.9D Mot. XUD9 -17/02/98 Sauf 1.9TD Mot. XUD9TE -17/02/98

... Expert VL

Eléments TRAIN ARRIERE

Rear axle parts

Tren TRAS

Elementy zawieszenia tylnego

элементы задней оси.



1525615

OE 515261

Articulation essieu AR

Rear axle bush

Ø int.12 Ø ext.46 long. tube int.60 ext.48

TT /all models -12/06



RCZ ...

Eléments DIRECTION

Steering parts

Elementos Direcciones

Elementy układ kierowniczy

Элементы рулевой системы

G/L D/R

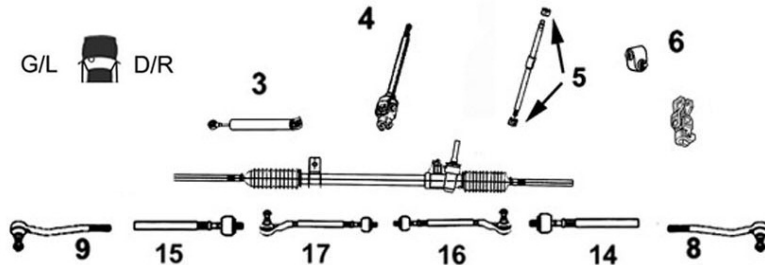

7770012

OE 3812F7

Axe de bielle G/D

L/R axial joint

NEW



14 Côté dir. M14x1.5 Côté rot. M14x1.5
15 Long 387 mm

1.6i 16v. THP	EP6CDTX
1.6i 16v. THP	EP6CDT M/MD/R
1.6i 16v. THP	EP6CDT
2.0 HDi FAP	DW10CTED4

7670022

OE 381794

Rotule de direction G/D

L/R tie rod end

NEW



8 M14 x 1.5 Pivot roue Ø82
9

1.6i 16v. THP	EP6CDT/X
1.6i 16v. THP	EP6CDT M/MD/R
2.0 HDi FAP	DW10CTED4



Barre stabilisatrice

Stabilizer bar

Barra estabilizadora

Drażek stabilizatora

стабилизатор поперечной устойчивости

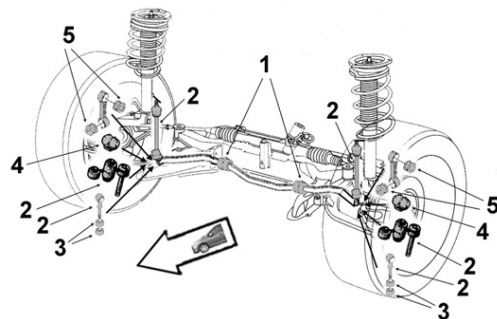

2300030

OE 508757

Biellette barre stab.

Stabilizer bar stub axle



2

1.6i 16v. THP	EP6CDT M
1.6i 16v. THP	EP6CDT/X
2.0 HDi FAP	DW10CTED4

2300027

OE 5094E2

Palier de barre milieu

Middle bar main bearing



1 Barre Ø 22.5

1.6i 16v. THP	EP6CDT
1.6i 16v. THP	EP6CDTX
2.0 HDi FAP	DW10CTED4

0945895

OE 5094E3

Palier de barre milieu

Middle bar main bearing



1 Barre Ø 23

1.6i 16v. /THP	EP6CDT /X
2.0 HDi FAP	DW10CTED4

... RCZ ...



Eléments SUSPENSION
Suspension parts
Elementos suspensión
Elementy zawieszenia
Элементы подвески

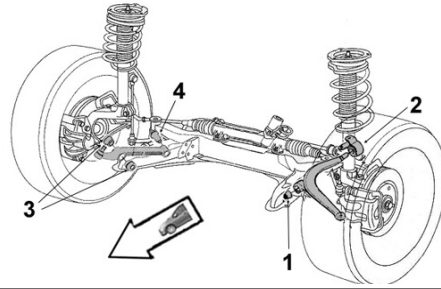

PEUGEOT



2250018

OE 3523CW

Articulation AV

Front bush

1 Ø int.14 Ø ext.55.3 long. tube int.56 ext.32



1.6i 16v. THP	EP6CDT M
1.6i 16v. THP	EP6CDT/X
1.6i 16v. THP	EP6CDT MD
2.0 HDi FAP	DW10CTED4

5233923

OE 352392

Articulation AR

Rear bush

2 Ø int.14 Ø ext.55 coll.62
 long. tube int.49 ext.25 ep. coll.3



1.6i 16v. THP	EP6CDT M
1.6i 16v. THP	EP6CDT/X
1.6i 16v. THP	EP6CDT MD
2.0 HDi FAP	DW10CTED4

Bras & Triangle de suspension

Control arm
Brazo y triángulo
Wahacz
Рычаг подвески

G/L  D/R

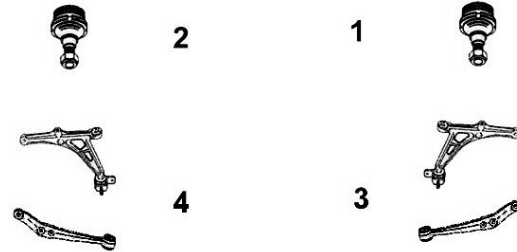

6403533

OE 364073

Rotule de susp. inf. G/D

L/R lower suspension ball joint

1
2



1.6i 16v. THP	EP6CDT/X
1.6i 16v. THP	EP6CDT M/MD/R
2.0 HDi FAP	DW10CTED4



Support d'amortisseur

Suspension mounting
Soporte amortiguador
Poduszka amortyzatora
Опора амортизатора

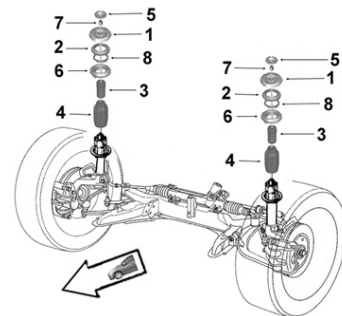

2650038

OE 503375

Coupelle rebond.

Spring cup

5



1.6i 16v. THP	EP6CDT/ M/ MD
1.6i 16v. THP	EP6CDTX
2.0 HDi FAP	DW10CTED4

0355275

OE 503527

Butée à billes G/D

L/R ball bearing

2



1.6i 16v. THP	EP6CDT/ M
1.6i 16v. THP	EP6CDTX
1.6i 16v. THP	EP6CDT MD
2.0 HDi FAP	DW10CTED4

... RCZ

PEUGEOT



2650035

Coupelle amortisseur G/D

OE 503151

L/R shock absorber cup



6

1.6i 16v. THP EP6CDT/ M / MD
1.6i 16v. THP EP6CDTX
2.0 HDi FAP DW10CTED4



Support d'amortisseur

Suspension mounting

Soporte amortiguador

Poduszka amortyzatora

Опора амортизатора

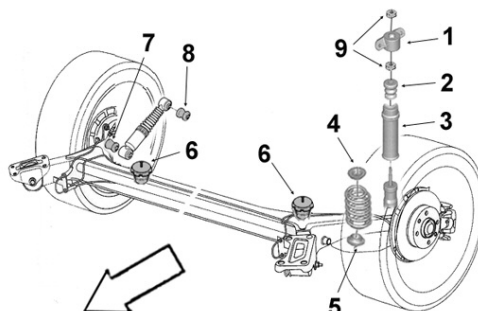

2650041

Protecteur amortisseur G/D

OE 525442

L/R shock absorber protector



2
3

1.6i 16v. THP EP6CDT/ M / MD
1.6i 16v. THP EP6CDTX
2.0 HDi FAP DW10CTED4

Eléments TRAIN ARRIERE

Rear axle parts

Tren TRAS

Elementy zawieszenia tylnego

элементы задней оси.



2600011

Articulation essieu

OE 5131G4

Axle bush

Ø ext. 72 coll. 81
long. tube int.83 ext.60 ep. coll.8.4



1.6i 16v. THP EP6CDT/ M / MD
1.6i 16v. THP EP6CDTX

2.0 HDi FAP DW10CTED4

Bipper VU ...

Eléments DIRECTION

Steering parts

Elementos Direcciones

Elementy uklad kierowniczy

Элементы рулевой системы

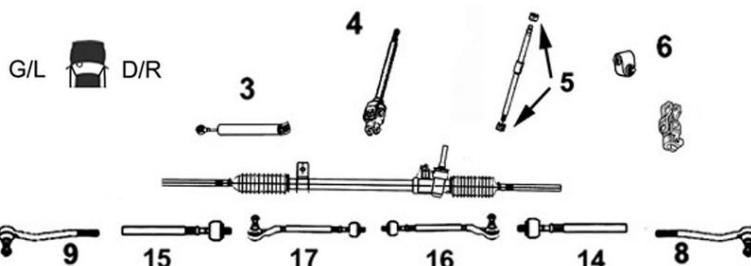

7770013

Axe de bielle G/D

Part/oe 400177

L/R axial joint

NEW



14 15 Côté dir. M14x1.5 Côté rot. M14x1.5 long 276 mm

1.3 HDi FAP F13DTE5 BVM
1.4i TU3A
1.4i TU3AE5
1.4 HDi DV4TED

... Bipper VU ...

Eléments DIRECTION

Steering parts

Elementos Direcciones

Elementy układ kierowniczy

Элементы рулевой системы

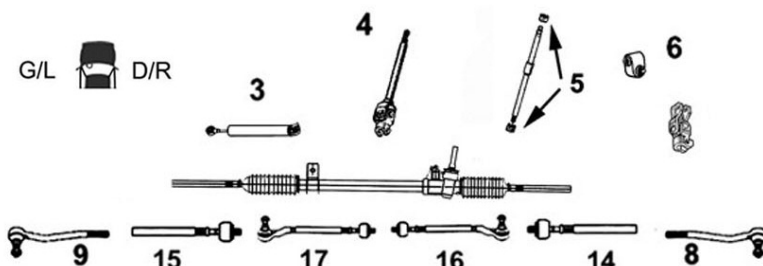

7670008

OE 381786

Rotule de direction G

Left tie rod end

9 M14 x 1.5

1.3 HDi FAP
1.4i
1.4 HDi

F13DTE5
TU3A/E5
DV4TED



7670009

OE 381787

Rotule de direction D

Right tie rod end

8 M14 x 1.5

1.3 HDi FAP
1.4i
1.4 HDi

F13DTE5
TU3A/E5
DV4TED



Barre stabilisatrice

Stabilizer bar

Barra estabilizadora

Drażek stabilizatora

стабилизатор поперечной устойчивости

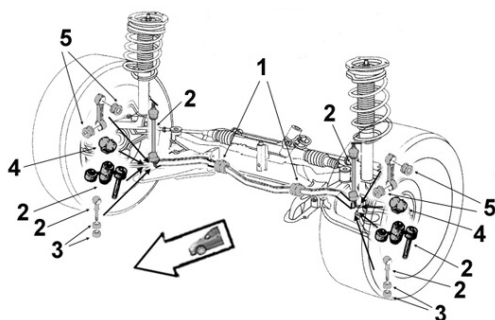

2300029

OE 508779

Biellette barre stab.

Stabilizer bar stub axle

2

1.4i
1.4 HDi

TU3A/E5
DV4TED



2300043

OE 5094C8

Palier de barre milieu

Middle bar main bearing

1 Barre Ø 20

1.3 HDi FAP
1.4i
1.4 HDi

F13DTE5 -17/12/07
TU3A/E5 -17/12/07
DV4TED -17/12/07



2300041

OE 5094E5

Palier de barre milieu

Middle bar main bearing

1 Barre Ø 21

1.3 HDi FAP
1.4i
1.4 HDi

F13DTE5
TU3A/E5
DV4TED

18/12/07-
18/12/07-
18/12/07-



... Bipper VU ...



Eléments SUSPENSION
Suspension parts
Elementos suspensión
Elementy zawieszenie
Элементы подвески

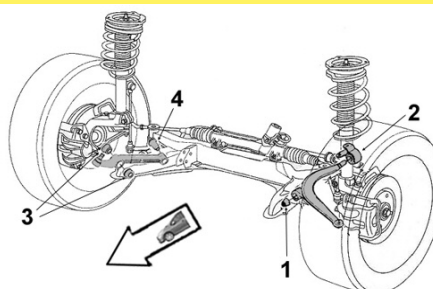

PEUGEOT



2256032	Articulation AV	2256009	Articulation AR
Part/oe 3520Y4	<i>Front bush</i>	Part/oe 3520Y4	<i>Rear bush</i>
1	<p>Ø int. 12.5 Ø ext. 42 coll. 43 coll. 50.5 long.tube int. 67.5 ext. 41</p> <p>1.3 HDi FAP F13DTE5 1.4i TU3A/E5 1.4 HDi DV4TED</p>	2	<p>Ø int. 12.5 Ø ext. 73 long. tube int. 66 ext. 27.5</p> <p>1.3 HDi FAP F13DTE5 1.4i TU3A/E5 1.4 HDi DV4TED</p>

Bras & Triangle de suspension	G/L		D/R				
<i>Control arm</i> <i>Brazo y triángulo</i> <i>Wahacz</i> <i>Рычаг подвески</i>				 2	 1	 4	 3

7470005	Triangle de susp. G	7470006	Triangle de susp. D
OE 3520Y4	<i>Left track control arm</i>	OE 3521V5	<i>Right track control arm</i>
4	<p><i>Avec rotule With ball joint</i></p> <p>1.3 HDi FAP F13DTE5 1.4i TU3A/E5 1.4 HDi DV4TED</p>	3	<p><i>Avec rotule With ball joint</i></p> <p>1.3 HDi FAP F13DTE5 1.4i TU3A/E5 1.4 HDi DV4TED</p>

7570004	Rotule de susp. inf. G/D
Part/oe 3520Y4	<i>L/R lower suspension ball joint</i>
1	<p>1.3 HDi FAP F13DTE5 1.4i TU3A/E5 1.4 HDi DV4TED</p>

... Bipper VU

SASIC



Support d'amortisseur
Suspension mounting
Soporte amortiguador
Poduszka amortyzatora
Опора амортизатора

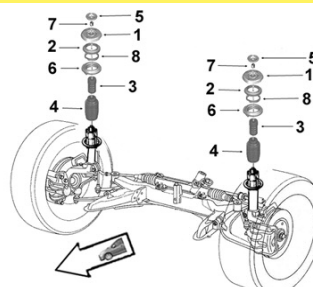

PEUGEOT

2650031

Support suspension G

OE 1609274780

Left suspension mounting

1



1.3 HDi FAP
1.4i
1.4 HDi

F13DTE5
TU3A /E5
DV4TED

2650032

Support suspension D

OE 1609274680

Right suspension mounting

1



1.3 HDi FAP
1.4i
1.4 HDi

F13DTE5
TU3A /E5
DV4TED

2650025

Butée de suspension G/D

OE 5033F2

L/R suspension bush

3



1.3 HDi FAP
1.4i
1.4 HDi

F13DTE5
TU3A/E5
DV4TED

Eléments TRAIN ARRIERE

Rear axle parts

Tren TRAS

Elementy zawieszenia tylnego

элементы задней оси.



2600012

Articulation essieu

OE 5131G8

Axle bush



Ø int. 13 Ø ext. 69 coll. 80
long. tube int.94 ext. 100 ep. coll. 2.5

1.3 HDi FAP
1.4i
1.4 HDi

F13DTE5
TU3A/E5
DV4TED

Boxer I -01/02 ...

Eléments DIRECTION

Steering parts

Elementos Direcciones

Elementy uklad kierowniczy

Элементы рулевой системы

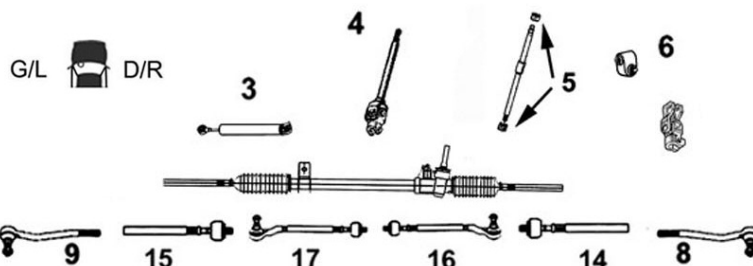

3008070

Axe de bielle G/D

OE 4018A4

L/R axial joint



14 Côté dir. M16x1.5 Côté rot. M16x1.5 long 319 mm

15	1.9 D	XUD9A	-01/02
	1.9 TD	XUD9TEF /UTF	-01/02
	2.0	XU10J2U	-01/02
	2.0 HDi	DW10TD	-01/02
	2.5 D/ TD	DJ5/T	-01/02
	2.5 TDi	DJ5TED	-01/02
	2.8 D/ TD	8140.63/ 43	-01/02
	2.8 HDi	8140.43S	-01/02



... Boxer I -01/02 ...

PEUGEOT



0184H44		Rotule de direction G/D	
OE 4018A3		<i>L/R tie rod end</i>	
	8 9	M16x1.5	
		1.9 D /TD	XUD9A/ TEF/ UTF -01/02
		2.0 HDi	DW10TD -01/02
		2.5 D/ TD	DJ5/ T -01/02
		2.5 TDi	DJ5TED -01/02
		2.8 D /TD	8140.63 /43 -01/02
		2.8 HDi	8140.43S -01/02



1264104		Bague de guidage colonne	
OE 412610		<i>Ring</i>	
	5	1.9 D	XUD9A -01/02
		1.9 TD	XUD9TEF/UTF -01/02
		2.0	XU10J2U -01/02
		2.0 HDi	DW10TD -01/02
		2.5 D	DJ5 -01/02
		2.5 TD/ i	DJ5T/ED -01/02
		2.8 D	8140.63 -01/02
		2.8 TD	8140.43 -01/02
		2.8 HDi	8140.43S -01/02

1034E64		Axe de volant		1034E44		Axe de volant	
OE 4103E6		<i>Steering wheel shaft</i>		OE 4103E4		<i>Steering wheel shaft</i>	
	4	DNA			4	DA	
		1.9 D	XUD9A -01/02			1.9 D	XUD9A -01/02
		1.9 TD	XUD9TEF /UTF -01/02			1.9 TD	XUD9TEF /UTF -01/02
		2.0	XU10J2U -01/02			2.0	XU10J2U -01/02
		2.0 HDi	DW10TD -01/02			2.0 HDi	DW10TD -01/02
		2.5 D	DJ5 -01/02			2.5 D	DJ5 -01/02
		2.5 TD/i	DJ5T/ED -01/02			2.5 TD/i	DJ5T/ED -01/02
		2.8 D	8140.63 -01/02			2.8 D	8140.63 -01/02
		2.8 TD	8140.43 -01/02			2.8 TD	8140.43 -01/02
2.8 HDi	8140.43S -01/02	2.8 HDi	8140.43S -01/02				

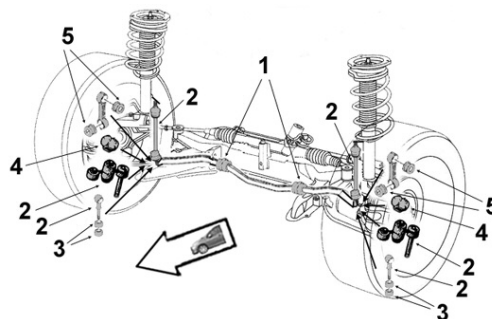

Barre stabilisatrice
Stabilizer bar
Barra estabilizadora
Drażek stabilizatora
 стабилизатор поперечной устойчивости



0875375		Biellette barre stab.		0935155		Liaison élastique	
OE 508737		<i>Stabilizer bar stub axle</i>		OE 509315		<i>Elastic link</i>	
	2	Ø 12 x 125 long. 134			3	Ø int.12.5 Ø ext.37.5 long. tube int.20 ext.22	
		TT /all models	02/94-01/02			TT /all models	02/94-01/02
		Sauf 4WD				Sauf 4WD	

8003210		Palier de barre	
Part/oe 508183		<i>Bar main bearing</i>	
	1	Barre Ø 24	
		TT /all models	02/94-01/02
Sauf 4WD			

... Boxer I -01/02 ...



Eléments SUSPENSION
Suspension parts
Elementos suspensión
Elementy zawieszenie
Элементы подвески

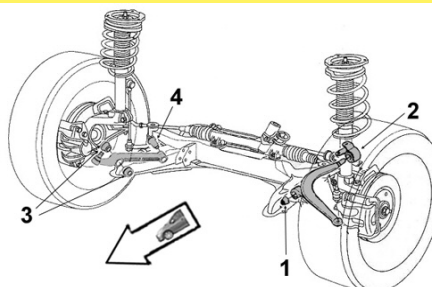

PEUGEOT



8003202

Articulation AV

OE -

Front bush



1 Ø int.18 Ø ext.45 coll.57.5 x2
 long. tube int.65 ext.49 ep. coll.7x2

TT /all models 02/94-01/02

8003204

Articulation AR

OE 352394

Rear bush



2 Ø int.34

TT /all models 02/94-01/02

Bras & Triangle de suspension

Control arm
Brazo y triángulo
Wahacz
Рычаг подвески

G/L D/R

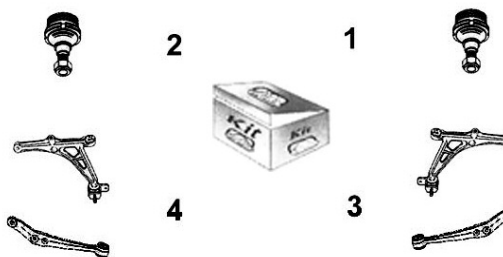

5203953

Triangle de susp. G

OE 352095

Left track control arm



4 Sans rotule Without tie rod end

1000kg 1400kg

1.9 D/ TD	XUD9A /TEF/ UTF
2.0	XU10J2U
2.0 HDi	DW10TD
2.5 D	DJ5
2.5 TD/i	DJ5T/ED
2.8 D/ TD	8140.63/ 43
2.8 HDi	8140.43S

5213653

Triangle de susp. D

OE 3521H2

Right track control arm



3 Sans rotule Without tie rod end

1000kg 1400kg

1.9 D/ TD	XUD9A /TEF/ UTF
2.0	XU10J2U
2.0 HDi	DW10TD
2.5 D	DJ5
2.5 TD/i	DJ5T/ED
2.8 D/ TD	8140.63/ 43
2.8 HDi	8140.43S

5203963

Triangle de susp. G

OE 352096

Left track control arm



4 Sans rotule Without tie rod end **1800kg**

1.9 D	XUD9A	-01/01
1.9 TD	XUD9TEF/UTF	-01/01
2.0	XU10J2U	-01/01
2.0 HDi	DW10TD	-01/01
2.5 D	DJ5	-01/01
2.5 TD/i	DJ5T/ED	-01/01
2.8 D/ TD	8140.63/ 43	-01/01
2.8 HDi	8140.43S	-01/01

5213663

Triangle de susp. D

OE 352166

Right track control arm



3 Sans rotule Without tie rod end **1800kg**

1.9 D	XUD9A	-01/01
1.9 TD	XUD9TEF/UTF	-01/01
2.0	XU10J2U	-01/01
2.0 HDi	DW10TD	-01/01
2.5 D	DJ5	-01/01
2.5 TD/i	DJ5T/ED	-01/01
2.8 D/ TD	8140.63/ 43	-01/01
2.8 HDi	8140.43S	-01/01

5203N43

Triangle de susp. G

OE 3520N4

Left track control arm



4 Sans rotule Without tie rod end **1800kg**

1.9 D	XUD9A	02/01-01/02
1.9 TD	XUD9TEF/ UTF	02/01-01/02
2.0	XU10J2U	02/01-01/02
2.0 HDi	DW10TD	02/01-01/02
2.5 D	DJ5	02/01-01/02
2.5 TD	DJ5T/ ED	02/01-01/02
2.8 D	8140.63	02/01-01/02
2.8 HDi	8140.43S	02/01-01/02

5213J43

Triangle de susp. D

OE 3521J4

Right track control arm







3 Sans rotule Without tie rod end **1800kg**

1.9 D	XUD9A	02/01-01/02
1.9 TD	XUD9TEF/ UTF	02/01-01/02
2.0	XU10J2U	02/01-01/02
2.0 HDi	DW10TD	02/01-01/02
2.5 D	DJ5	02/01-01/02
2.5 TD	DJ5T/ ED	02/01-01/02
2.8 D	8140.63	02/01-01/02
2.8 HDi	8140.43S	02/01-01/02

... Boxer I -01/02 ...

PEUGEOT



... Boxer I -01/02 ...			
6403323		Rotule de susp. inf. G/D	
OE 364032		<i>L/R lower suspension ball joint</i>	
	1	M16 x 1.5 1000kg 1400kg	
	2	1.9 D/ TD	XUD9A/ TEF/ UTF -01/01
		2.0	XU10J2U -01/01
		2.0 HDi	DW10TD -01/01
		2.5 D/ TD/ TDi	DJ5/ T/ TED -01/01
		2.8 D/ TD	8140.63 /43 -01/01
		2.8 HDi	8140.43S -01/01
6403333		Rotule de susp. inf. G/D	
OE 364033		<i>L/R lower suspension ball joint</i>	
	1	M18 x 1.5 1800kg	
	2	1.9 D/ TD	XUD9A/ TEF/ UTF -01/01
		2.0	XU10J2U -01/01
		2.0 HDi	DW10TD -01/01
		2.5 D/ TD/ TDi	DJ5/ T/ TED -01/01
		2.8 D/ TD	8140.63 /43 -01/01
		2.8 HDi	8140.43S -01/01
6403553		Rotule de susp. inf. G/D	
OE 364055		<i>L/R lower suspension ball joint</i>	
	1	1000kg 1400kg	
	2	1.9 D	XUD9A 02/01-01/02
		1.9 TD	XUD9TEF/ UTF 02/01-01/02
		2.0	XU10J2U 02/01-01/02
		2.0 HDi	DW10TD 02/01-01/02
		2.5 D/ TD/ TDi	DJ5/ T/ TED 02/01-01/02
		2.8 D/ TD	8140.63/ 43 02/01-01/02
	2.8 HDi	8140.43S 02/01-01/02	
6403543		Rotule de susp. inf. G/D	
OE 364054		<i>L/R lower suspension ball joint</i>	
	1	M18 x 1.5 1800kg	
	2	1.9 D	XUD9A 02/01-01/02
		1.9 TD	XUD9TEF/ UTF 02/01-01/02
		2.0	XU10J2U 02/01-01/02
		2.0 HDi	DW10TD 02/01-01/02
		2.5 D/ TD/ TDi	DJ5/ T/ TED 02/01-01/02
		2.8 D/ TD	8140.63/ 43 02/01-01/02
	2.8 HDi	8140.43S 02/01-01/02	
1003570		Kit rép. triangle susp. G ou D	
OE -		<i>L or R track control arm bearing repair kit</i>	
	Sans visserie <i>Without screws and bolts</i>		
		1.9 D	XUD9A -01/02
		1.9 TD	XUD9TEF/ UTF -01/02
		2.0	XU10J2U -01/02
		2.0 HDi	DW10TD -01/02
		2.5 D/ TD/ TDi	DJ5/ T/ TED -01/02
		2.8 D/ TD	8140.63/ 43 -01/02
	2.8 HDi	8140.43S -01/02	

... Boxer I -01/02 ...









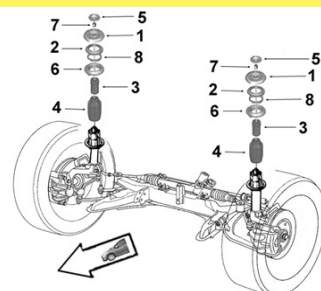

PEUGEOT



Support d'amortisseur
 Suspension mounting
 Soporte amortiguador
 Poduszka amortyzatora
 Опора амортизатора

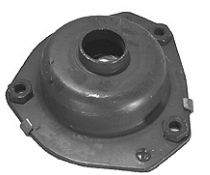











<p>0385185 OE 503818</p> 	<p>Support suspension G <i>Left suspension mounting</i></p> <p>1</p> <p>TT /all models sauf Sofim diesel /piste -ch 15616153 02/94-01/02</p>	<p>0385195 OE 503819</p> 	<p>Support suspension D <i>Right suspension mounting</i></p> <p>1</p> <p>TT /all models sauf Sofim diesel /piste -ch 15616153 02/94-01/02</p>
<p>0385285 OE 503828</p> 	<p>Support suspension G <i>Left suspension mounting</i></p> <p>1</p> <p>TT /all models Sofim Diesel /piste -ch 15616153 02/94-01/02</p>	<p>0385295 OE 503829</p> 	<p>Support suspension D <i>Right suspension mounting</i></p> <p>1</p> <p>TT /all models Sofim Diesel /piste -ch 15616153 02/94-01/02</p>
<p>0385195 OE 503874</p> 	<p>Support suspension G <i>Left suspension mounting</i></p> <p>1</p> <p>TT /all models sauf Sofim diesel /piste Ch- 15616154 02/94-01/02</p>	<p>0385185 OE 503872</p> 	<p>Support suspension D <i>Right suspension mounting</i></p> <p>1</p> <p>TT /all models sauf Sofim diesel /piste Ch- 15616154 02/94-01/02</p>
<p>0385295 OE 503829</p> 	<p>Support suspension G <i>Left suspension mounting</i></p> <p>1</p> <p>TT /all models Sofim Diesel /piste Ch- 15616154 02/94-01/02</p>	<p>0385285 OE 503828</p> 	<p>Support suspension D <i>Right suspension mounting</i></p> <p>1</p> <p>TT /all models Sofim Diesel /piste Ch- 15616154 02/94-01/02</p>
<p>0355395 OE 503539</p> 	<p>Butée à billes G/D <i>L/R ball bearing</i></p> <p>2</p> <p>TT /all models Sauf 4WD 02/94-01/02</p>	<p>0355505 OE 503550</p> 	<p>Joint amortisseur G/D <i>L/R shock absorber gasket</i></p> <p>8</p> <p>TT /all models Sauf 4WD 02/94-01/02</p>

... Boxer I -01/02 ...

PEUGEOT



0335415		Butée de suspension G/D		
OE 503341		<i>L/R suspension bush</i>		
	3	1.9 D/ TD	1000kg 1400kg sauf 4WD sauf piste	
	4	2.0 /4WD	1000kg 1400kg Carbu. sauf piste	
		2.0i	1000 1400kg sauf 4WD sauf piste	
		2.5 D/ TD	1000 1400kg sauf 4WD sauf piste	
		2.5 TDi	1000kg 1400kg sauf 4WD sauf piste	
		2.8 HDi	1000kg 1400kg sauf 4WD	
		XUD9/T	02/94-01/02	
XU102C	02/94-01/02			
XU10J2	02/94-01/02			
DJ5	02/94-01/02			
DJ5TED	02/94-01/02			
Sofim	02/94-01/02			
2650009		Butée de suspension		
OE 503342		<i>Shock bush</i>		
	3	H85 1800kg		
	4	1.9 D	XUD9 02/94-01/02	
		1.9 TD	XUD9TE 02/94-01/02	
		2.0 Carbu.	XU102C 02/94-01/02	
		2.0i /4WD	XU10J2 02/94-01/02	
		2.5 D /4WD	DJ5 02/94-01/02	
		2.5 TD /4WD	DJ5T 02/94-01/02	
		2.5 TDi /4WD	DJ5TED 15/12/94-01/02	
		2.8 HDi /4WD	Sofim 02/94-01/02	
		0335575		Butée de suspension G/D
OE 503357		<i>L/R suspension bush</i>		
	3	Sauf 4WD		
	4	2.5 D	Sofim 02/94-01/02	
		2.8 D	Sofim 02/94-01/02	
		2.8 TD	Sofim 02/94-01/02	
2545285		Protecteur amortisseur G/D		
OE 525428		<i>L/R shock absorber protector</i>		
	4	2.5 D	Sofim 02/94-01/02	
	4	2.8 D	Sofim 02/94-01/02	
		2.8 TD	Sofim 02/94-01/02	
		TT /all models Piste	02/94-01/02	
	1005266		Kit rép. suspension G	
OE -		<i>Left susp. mounting repair kit</i>		
	Sauf 4WD Sauf piste -ch 15616153			
	2.5 D	DJ5		
	2.5 TD/i	DJ5T /ED		
	2.0 HDi	DW10TD		
	2.0	XU10J2U		
	1.9 D	XUD9A		
	1.9 TD	XUD9TEF /UTF		
	1005267		Kit rép. suspension D	
OE -		<i>Right susp. mounting repair kit</i>		
	Sauf 4WD Sauf piste -ch 15616153			
	2.5 D	DJ5		
	2.5 TD/i	DJ5T /ED		
	2.0 HDi	DW10TD		
	2.0	XU10J2U		
	1.9 D	XUD9A		
	1.9 TD	XUD9TEF /UTF		
	1005267		Kit rép. suspension G	
OE -		<i>Left susp. mounting repair kit</i>		
	Sauf 4WD Sauf piste Ch- 15616154			
	2.5 D	DJ5	-01/02	
	2.5 TD	DJ5T	-01/02	
	2.5 TDi	DJ5TED	-01/02	
	2.0 HDi	DW10TD	-01/02	
	2.0	XU10J2U	-01/02	
	1.9 D	XUD9A	-01/02	
	1.9 TD	XUD9TEF/ UTF	-01/02	
	1005266		Kit rép. suspension D	
	OE -		<i>Right susp. mounting repair kit</i>	
	Sauf 4WD Sauf piste Ch- 15616154			
	2.5 D	DJ5	-01/02	
	2.5 TD	DJ5T	-01/02	
	2.5 TDi	DJ5TED	-01/02	
	2.0 HDi	DW10TD	-01/02	
	2.0	XU10J2U	-01/02	
	1.9 D	XUD9A	-01/02	
	1.9 TD	XUD9TEF/ UTF	-01/02	
	1005272		Kit rép. suspension G	
OE -		<i>Left susp. mounting repair kit</i>		
	sauf 4WD Piste -ch 15616153			
	2.8 TD	8140.43		
	2.8 HDi	8140.43S		
	2.8 D	8140.63		
1005273		Kit rép. suspension D		
OE -		<i>Right susp. mounting repair kit</i>		
	sauf 4WD Piste -ch 15616153			
	2.8 TD	8140.43		
	2.8 HDi	8140.43S		
	2.8 D	8140.63		

... Boxer I -01/02 ...



Support d'amortisseur
 Suspension mounting
 Soporte amortiguador
 Poduszka amortyzatora
 Опора амортизатора

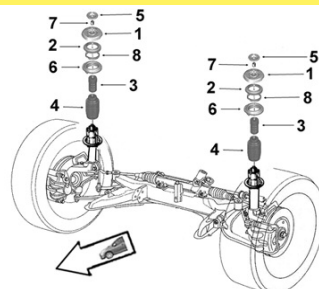

PEUGEOT

SASIC

1005273

Kit rép. suspension G

OE -

Left susp. mounting repair kit

sauf 4WD Piste Ch- 15616154



2.8 TD	8140.43	-01/02
2.8 HDi	8140.43S	-01/02
2.8 D	8140.63	-01/02

1005272

Kit rép. suspension D

OE -

Right susp. mounting repair kit

sauf 4WD Piste Ch- 15616154



2.8 TD	8140.43	-01/02
2.8 HDi	8140.43S	-01/02
2.8 D	8140.63	-01/02

Eléments TRAIN ARRIERE

Rear axle parts

Tren TRAS

Elementy zawieszenia tylnego

элементы задней оси.



1315735

Articulation AV lame

OE 513173

Front leaf bush



Ø int.16.5 Ø ext.49 coll. 53 x2
 long. tube int. 87 ext.70 coll.3

TT /all models
 Sauf 4WD 02/94-01/02

1315725

Articulation AR lame

OE 513172

Rear leaf bush



Ø int.16 Ø ext.41 coll.57
 long. tube int.46.5 ext.40 coll.5

TT /all models
 Sauf 4WD 02/94-01/02

Boxer II 01/02-07/06 ...

Eléments DIRECTION

Steering parts

Elementos Direcciones

Elementy uklad kierowniczy

Элементы рулевой системы

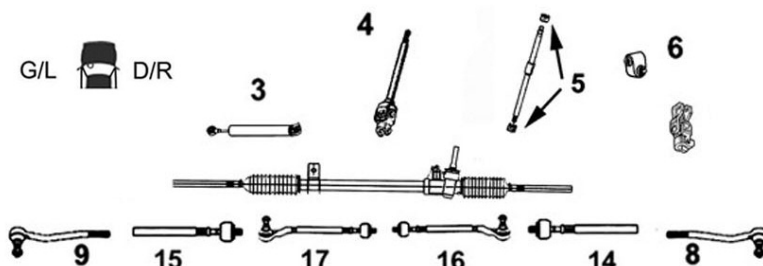

3008070

Axe de bielle G/D

OE 4018A4

L/R axial joint



14 Côté dir. M16x1.5 Côté rot. M16x1.5
15 long 319 mm

2.0i /GNV / GPL	XU10J2
2.0 HDi	DW10TD /UTD
2.2 HDi	DW12UTED
2.8 HDi /4WD	F28DT / 8140.43S
2.8 HDi	8140.43N

0184H44

Rotule de direction G/D

OE 4018A3

L/R tie rod end



8 M16 x 1.5 -ch 17175290
9

2.0i /GNV / GPL	XU10J2
2.0 HDi	DW10TD /UTD
2.2 HDi /Bus	DW12UTED
2.8 HDi /4WD /Bus	

... Boxer II 01/02-07/06 ...

PEUGEOT



0184E04

OE 4018E0

Rotule de direction G/D

L/R tie rod end



8
9

M16x1.5 Ch- 17175291

2.0i /GNV / GPL
2.0 HDi
2.2 HDi /Bus
2.8 HDi /4WD /Bus

XU10J2
DW10TD /UTD
DW12UTED



Barre stabilisatrice

Stabilizer bar

Barra estabilizadora

Drażek stabilizatora

стабилизатор поперечной устойчивости

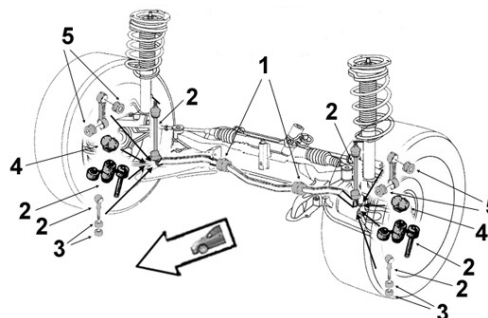

0875375

OE 508737

Biellette barre stab.

Stabilizer bar stub axle



2

Ø 12 x 125 long. 134

TT /all models Sauf 4WD

0935155

OE 509316

Liaison élastique

Elastic link



3

**Ø int.12.5 Ø ext.37.5
long. tube int.20 ext.22**

2.0i
2.0 HDi
2.2 HDi
2.8 HDi

XU10J2
DW10TD
DW12UTED



Eléments SUSPENSION

Suspension parts

Elementos suspensión

Elementy zawieszenie

Элементы подвески

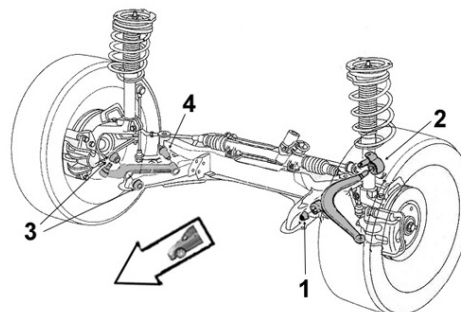

5233933

OE 352393

Articulation AV

Front bush



1

Ø int.26 Ø ext.48 coll.57 long. tube int.55 ext.38 ep. coll.6X2

2.0i
2.0 HDi
2.2 HDi
2.8 HDi
2.8 HDi 146hp 108kw
Géométrie variable
2.8 TD

XU10J2
DW10TD
DW12UTED
Sofim BV5 MLGU BVA 4HP20
Sofim
Sofim BV5 MLGU

8003204

OE 3523AP

Articulation AR

Rear bush



2

Ø int.34

TT /all models

... Boxer II 01/02-07/06 ...

SASIC







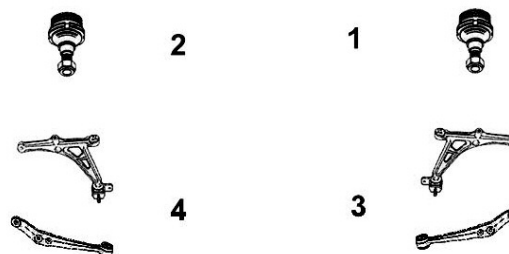

PEUGEOT

Bras & Triangle de suspension

Control arm
Brazo y triángulo
Wahacz
Рычаг подвески

G/L  D/R



5203953 OE 352095	Triangle de susp. G <i>Left track control arm</i>	5213653 OE 3521H2	Triangle de susp. D <i>Right track control arm</i>
	4 Sans rotule <i>Without tie rod end</i> 800 1000 1400kg sauf VIN 936... -ch 17226522 2.0 XU10J2 01/02-07/06 2.0 HDi DW10TD /UTD 01/02-07/06 2.2 HDi DW12UTED 01/02-07/06 2.8 HDi 01/02-07/06		3 Sans rotule <i>Without tie rod end</i> 800 1000 1400kg sauf VIN 936... -ch 17226522 2.0 XU10J2 01/02-07/06 2.0 HDi DW10TD /UTD 01/02-07/06 2.2 HDi DW12UTED 01/02-07/06 2.8 HDi 01/02-07/06
5203N33 OE 3520N3	Triangle de susp. G <i>Left track control arm</i>	5213J33 OE 3521J3	Triangle de susp. D <i>Right track control arm</i>
	4 Sans rotule <i>Without tie rod end</i> 800 1000 1400kg sauf VIN 936... Ch- 17226523 2.0i /GNV / GPL XU10J2 2.0 HDi DW10TD /UTD 2.2 HDi /Bus DW12UTED 2.8 HDi /4WD /Bus 1400kg VIN : 936... 2.0 XU10J2 2.0 HDi DW10TD /UTD 2.2 HDi DW12UTED 2.8 HDi		3 Sans rotule <i>Without tie rod end</i> 800 1000 1400kg sauf VIN 936... Ch- 17226523 2.0i /GNV / GPL XU10J2 2.0 HDi DW10TD /UTD 2.2 HDi /Bus DW12UTED 2.8 HDi /4WD /Bus 1400kg VIN : 936... 2.0 XU10J2 2.0 HDi DW10TD /UTD 2.2 HDi DW12UTED 2.8 HDi
5203N43 OE 3520N4	Triangle de susp. G <i>Left track control arm</i>	5213J43 OE 3521J4	Triangle de susp. D <i>Right track control arm</i>
	4 Sans rotule <i>Without tie rod end</i> 1800kg 2.0 XU10J2 01/02- 2.0 HDi DW10TD /UTD 01/02- 2.2 HDi DW12UTED 01/02- 2.8 HDi 01/02-		3 Sans rotule <i>Without tie rod end</i> 1800kg 2.0 XU10J2 01/02- 2.0 HDi DW10TD /UTD 01/02- 2.2 HDi DW12UTED 01/02- 2.8 HDi 01/02-
6403553 OE 364055	Rotule de susp. inf. G/D <i>L/R lower suspension ball joint</i>	6403543 OE 364054	Rotule de susp. inf. G/D <i>L/R lower suspension ball joint</i>
	1 2 800 1000 1400kg 2.0i /GNV / GPL XU10J2 2.0 HDi DW10TD /UTD 2.2 HDi /Bus DW12UTED 2.8 HDi /4WD /Bus		1 2 M18 x 1.5 1800kg 2.0 XU10J2 2.0 HDi DW10TD /UTD 2.2 HDi DW12UTED 2.8 HDi

... Boxer II 01/02-07/06 ...



Support d'amortisseur
 Suspension mounting
 Soporte amortiguador
 Poduszka amortyzatora
 Опора амортизатора

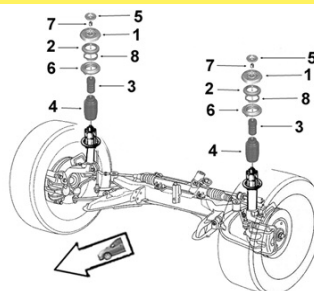

PEUGEOT



0385875 OE 5038E3	Support suspension G <i>Left suspension mounting</i>	0385895 OE 5038E2	Support suspension D <i>Right suspension mounting</i>
	1 800 1000 1400 1800kg sauf VIN 936... Sauf piste 2.0i XU10J2 2.0 HDi DW10TD 2.2 HDi DW12UTED 2.8 HDi Sofim 2.8 TD Sofim		1 800 1000 1400 1800kg sauf VIN 936... Sauf piste 2.0i XU10J2 2.0 HDi DW10TD 2.2 HDi DW12UTED 2.8 HDi Sofim 2.8 TD Sofim
0385295 OE 503829	Support suspension G <i>Left suspension mounting</i>	0385285 OE 503828	Support suspension D <i>Right suspension mounting</i>
	1 800 1000 1400 1800kg sauf 4WD Piste 2.0 XU10J2 2.0 HDi DW10TD 2.2 HDi DW12UTED 2.8 HDi Sofim 2.8 TD Sofim		1 800 1000 1400 1800kg sauf 4WD Piste 2.0 XU10J2 2.0 HDi DW10TD 2.2 HDi DW12UTED 2.8 HDi Sofim 2.8 TD Sofim
0355395 OE 503547	Butée à billes G/D <i>L/R ball bearing</i>	0355505 OE 503550	Joint amortisseur G/D <i>L/R shock absorber gasket</i>
	2 800 1000 1400 1800kg GPL Sauf 4WD Dangel 2.0i /Bus /GNV XU10J2 2.0 HDi DW10TD 2.2 HDi /Bus DW12UTED 2.8 HDi /4WD Sofim 2.8 TD Sofim		8 800 1000 1400 1800kg 2.0i XU10J2 2.0 HDi DW10TD 2.2 HDi DW12UTED 2.8 HDi Sofim 2.8 TD Sofim
0335415 OE 503341	Butée de suspension G/D <i>L/R suspension bush</i>	2650009 OE 503342	Butée de suspension <i>Shock bush</i>
	3 4 TT /all models 800 1000 1400kg sauf VIN 936... sauf piste		3 4 H85 TT /all models 1800kg Sauf VIN 936... Sauf piste -ch 17287232
0335285 OE 503328	Butée de suspension G/D <i>L/R suspension bush</i>	0335575 OE 503357	Butée de suspension G/D <i>L/R suspension bush</i>
	3 4 TT /all models sauf VIN 936... Piste 800/1000/1400/1800kg		3 TT /all models 1400kg VIN 936...

... Boxer II 01/02-07/06

SASIC

PEUGEOT



Support d'amortisseur
Suspension mounting
Soporte amortiguador
Poduszka amortyzatora
Опора амортизатора

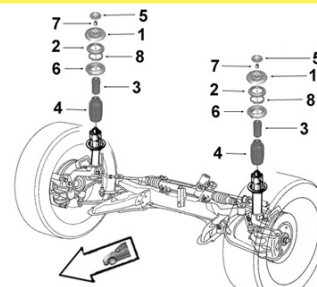

2545285

OE 525428

Protecteur amortisseur G/D

L/R shock absorber protector



4

2.0i	XU10J2
2.0 HDi	DW10TD /UTD
2.2 HDi	DW12UTED
2.8 HDi	
2.8 TD	

1005273

OE -

Kit rép. suspension G

Left susp. mounting repair kit



2.0 800 1000kg Sauf 4WD Route inégale	XU10J2	01/02-07/06
2.0 1400 1800kg sauf VIN 936... sauf 4WD Route inégale	XU10J2	01/02-07/06
2.0 1400kg 1800kg VIN 935... Sauf 4WD	XU10J2	01/02-07/06
2.0 HDi 800 1000kg Sauf 4WD Route inégale	DW10TD /UTD	01/02-07/06
2.0 HDi 1400/1800kg sauf VIN 936... sauf 4WD Route inégale	DW10TD /UTD	01/02-07/06
2.0 HDi 1400kg 1800kg VIN 935... Sauf 4WD	DW10TD /UTD	01/02-07/06
2.2 HDi 800 1000kg Sauf 4WD Route inégale	DW12UTED	01/02-07/06
2.2 HDi 1400/1800kg sauf VIN 936... sauf 4WD Route inégale	DW12UTED	01/02-07/06
2.2 HDi 1400kg 1800kg VIN 935... Sauf 4WD	DW12UTED	01/02-07/06
2.8 HDi 800 1000kg Sauf 4WD Route inégale		01/02-07/06
2.8 HDi 1400/1800kg sauf VIN 936... sauf 4WD Route inégale		01/02-07/06
2.8 HDi 1400kg 1800kg VIN 935... Sauf 4WD		01/02-07/06

1005272

OE -

Kit rép. suspension D

Right susp. mounting repair kit



2.0 800 1000kg Sauf 4WD Route inégale	XU10J2	01/02-07/06
2.0 1400 1800kg sauf VIN 936... sauf 4WD Route inégale	XU10J2	01/02-07/06
2.0 1400kg 1800kg Sauf 4WD	XU10J2	01/02-07/06
2.0 HDi 800 1000kg Sauf 4WD Route inégale	DW10TD /UTD	01/02-07/06
2.0 HDi 1400/1800kg sauf VIN 936... sauf 4WD Route inégale	DW10TD /UTD	01/02-07/06
2.0 HDi 1400kg 1800kg VIN 936... Sauf 4WD	DW10TD /UTD	01/02-07/06
2.2 HDi 800 1000kg Sauf 4WD Route inégale	DW12UTED	01/02-07/06
2.2 HDi 1400/1800kg sauf VIN 936... sauf 4WD Route inégale	DW12UTED	01/02-07/06
2.2 HDi 1400kg 1800kg VIN 936... Sauf 4WD	DW12UTED	01/02-07/06
2.8 HDi 800 1000kg Sauf 4WD Route inégale		01/02-07/06
2.8 HDi 1400/1800kg sauf VIN 936... sauf 4WD Route inégale		01/02-07/06
2.8 HDi 1400kg 1800kg VIN 935... Sauf 4WD		01/02-07/06

Boxer III 07/06- ...

Eléments DIRECTION
 Steering parts
 Elementos Direcciones
 Elementy układ kierowniczy
 Элементы рулевой системы

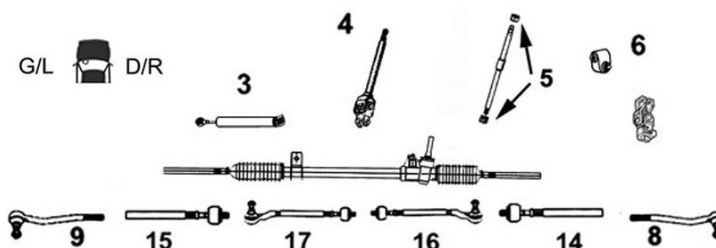

PEUGEOT



7770008 **Axe de bielle G/D**
 Part/oe 1611075080 L/R axial joint

NEW



14 Conduite à gauche Left hand drive Côté dir. M16x1.5 Côté rot. M16x1.5 long 261 mm
15

2.2 HDi 100hp 74kw
 2.2 HDi 110hp 81kw
 2.2 HDi 120hp 88kw
 2.2 HDi 130hp 95kw/ 96kw
 2.2 HDi 150hp 110kw
 3.0 HDi FAP 145hp 107kw
 3.0 HDi 155hp 114kw 175hp 129kw
 3.0 HDi 157hp 116kw

PUMA 22DT
 PUMA C81 Euro 5
 PUMA 22DT
 PUMA 22DT /C96 Euro 5
 PUMA C110 Euro 5
 F30DT Euro 5
 F30DT Euro 5
 F30DT

7670001 **Rotule de direction G**
 OE 1610976480 Left tie rod end



9

2.2 HDi
 3.0 HDi

7670002 **Rotule de direction D**
 OE 1610976380 Right tie rod end



8

2.2 HDi
 3.0 HDi



Barre stabilisatrice
 Stabilizer bar
 Barra estabilizadora
 Drażek stabilizatora
 стабилизатор поперечной устойчивости

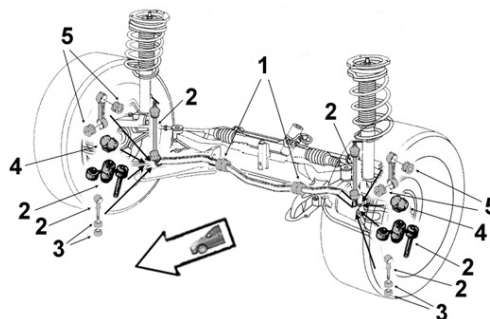

2300037 **Biellette barre stab.**
 Part/oe 5081N9 Stabilizer bar stub axle



2

2.2 HDi
 3.0 HDi

0935155 **Liaison élastique**
 OE 509316 Elastic link



3

Ø int.12.5 Ø ext.37.5 long. tube int.20 ext.22

2.2 HDi
 3.0 HDi

2300038 **Palier de barre**
 Part/oe 5081N9 Bar main bearing



1

Barre Ø 26

2.2 HDi
 3.0 HDi

... Boxer III 07/06- ...



Eléments SUSPENSION

Suspension parts
Elementos suspensión
Elementy zawieszenie
Элементы подвески

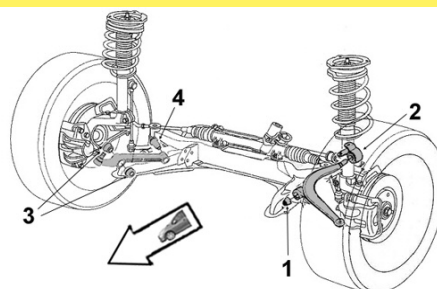

PEUGEOT



2250004

Articulation AV

Part/oe 3520S0

Front bush



1 Ø int. 18 Ø ext. 56 coll. 59
long. tube int. 64 ext. 42 ep. coll. 3X2

12Q 14Q 16Q Charge utile légère

2.2 HDi 100hp 74kw
2.2 HDi 120hp 88kw
2.2 HDi 130hp 96kw
3.0 HDi

2250005

Articulation AR

Part/oe 3520S0

Rear bush



2 Ø int. 19 Ø ext. 74
long. tube int. 76 ext. 44

12Q 14Q 16Q Charge utile légère

2.2 HDi 100hp 74kw
2.2 HDi 120hp 88kw
2.2 HDi 130hp 96kw
3.0 HDi

Bras & Triangle de suspension

Control arm
Brazo y triángulo
Wahacz
Рычаг подвески

G/L  D/R

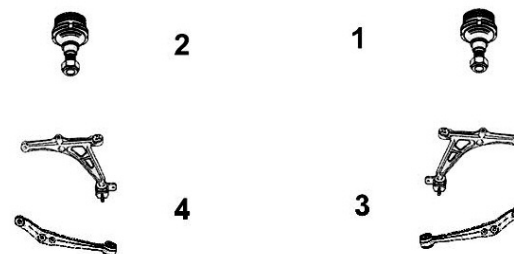

7470008

Triangle de susp. G

OE 3520S0

Left track control arm



4 Sans rotule Without tie rod end

2.2 HDi
3.0 HDi

7470007

Triangle de susp. D

OE 3521P1

Right track control arm



3 Sans rotule Without tie rod end

2.2 HDi
3.0 HDi

7570001

Rotule de susp. inf. G/D

OE 364076

L/R lower suspension ball joint



1
2 M16 x 1.5

2.2 HDi
3.0 HDi

... Boxer III 07/06- ...



Support d'amortisseur
Suspension mounting
Soporte amortiguador
Poduszka amortyzatora
Опора амортизатора

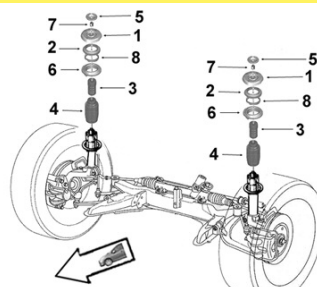

PEUGEOT



... Boxer III 07/06-



Support d'amortisseur
 Suspension mounting
 Soporte amortiguador
 Poduszka amortyzatora
 Опора амортизатора

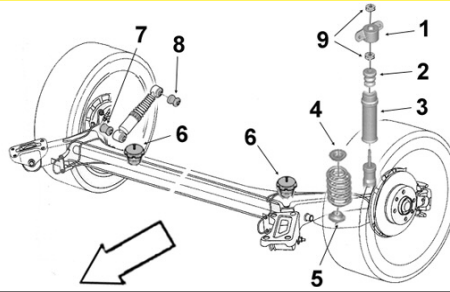

PEUGEOT

2650026
 OE 516688

Butée de talonnage
 Bushing



6 Susp. métallique
 2.2 HDi Sauf susp. AR renforcée
 Charge utile 12/14/16Q
 2.2 HDi Susp. AR renforcée
 Charge utile lourde 20Q
 3.0 HDi Sauf susp. AR renforcée
 Charge utile 12/14/16Q
 3.0 HDi Susp. AR renforcée
 Charge utile lourde 20Q

2650027
 OE 5166A3

Butée de talonnage
 Bushing



6 Susp. métallique Susp. AR renforcée
 Charge utile 12/14/16Q
 2.2 HDi
 3.0 HDi

2650029
 OE 516697

Butée de talonnage
 Bushing



6 Susp. métallique Sauf susp. AR renforcée Charge utile lourde 20Q Sauf Fourgon semi vitré et motrice nue
 2.2 HDi
 3.0 HDi

Expert VU ...

Eléments DIRECTION

Steering parts
 Elementos Direcciones
 Elementy układ kierowniczy
 Элементы рулевой системы

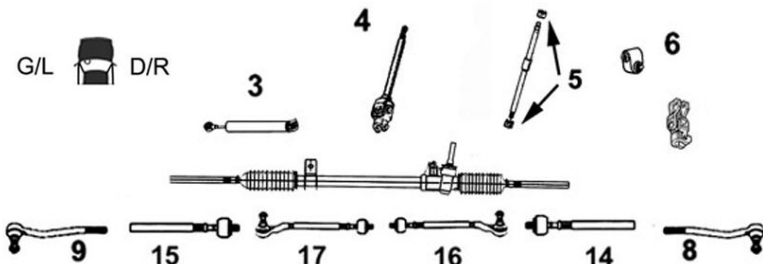

3008069
 OE 3812A4

Axe de bielle G/D
 L/R axial joint



14 Côté dir. M14x1.5 Côté rot. M14x1.5
15 long 306 mm
 1.6i -12/06
 1.8i -12/06
 1.9 D -12/06
 1.9 TD -12/06
 2.0i 16v. -12/06
 2.0 HDi -12/06

7770003
 Part/oe 3812F0

Axe de bielle G/D
 L/R axial joint



14 Côté dir. M16x1.5 Côté rot. M14x1.5
15 long 304 mm
 1.6 HDi DV6DU M/ UC 01/07-
 1.6 HDi DV6UTED4 01/07-
 2.0i 16v. EW10A 01/07-
 2.0 HDi FAP DW10CTED4 01/07-
 2.0 HDi FAP DW10CD/CE DTR 01/07-
 2.0 HDi DW10UTED4 01/07-
 2.0 HDi FAP DW10BTED4 01/07-

0594094
 OE 405909

Rotule de direction G/D
 L/R tie rod end



8 M14 x 1.5
9
 1.6i -08/03
 1.8i -08/03
 1.9 D -08/03
 1.9 TD -08/03
 2.0i 16v. -08/03
 2.0 HDi -08/03

0594124
 OE 405912

Rotule de direction G/D
 L/R tie rod end











8 M14 x 1.5 DNA DA
9
 1.6i 09/03-12/03
 1.8i 09/03-12/03
 1.9 D 09/03-12/03
 1.9 TD 09/03-12/03
 2.0i 16v. 09/03-12/06
 2.0 HDi 09/03-12/06

... Expert VU ...

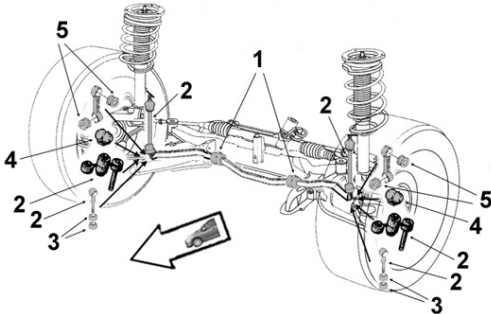
PEUGEOT



7670011		Rotule de direction G/D	
OE 381773		<i>L/R tie rod end</i>	
	8 9	M14 x 1.5	
		1.6 HDi	DV6DU M 01/07-
		1.6 HDi	DV6UC/UTED4 01/07-
		2.0i 16v.	EW10A 01/07-
		2.0 HDi FAP	DW10CD/CE DTR 01/07-
		2.0 HDi FAP	DW10CTED4/UTED4 01/07-
		2.0 HDi FAP	DW10BTED4 01/07-
1234A74		Axe de volant	
OE 4123A7		<i>Steering wheel shaft</i>	
	4 Conduite à G DNA		
	1.6i	-12/06	
	1.8i	-12/06	
	1.9 D	-12/06	
	1.9 TD	-12/06	
	2.0i 16v.	-12/06	
	2.0 HDi	-12/06	
1034F64		Axe de volant	
OE 4103F6		<i>Steering wheel shaft</i>	
	4 Conduite à G DA		
	1.6i	-12/06	
	1.8i	-12/06	
	1.9 D	-12/06	
	1.9 TD	-12/06	
	2.0i 16v.	-12/06	
	2.0 HDi	-12/06	
1034F74		Axe de volant	
OE 4103F7		<i>Steering wheel shaft</i>	
	4 Conduite à D DA		
	1.6i	-12/06	
	1.8i	-12/06	
	1.9 D	-12/06	
	1.9 TD	-12/06	
	2.0i 16v.	-12/06	
	2.0 HDi	-12/06	
			
Barre stabilisatrice <i>Stabilizer bar</i> <i>Barra estabilizadora</i> <i>Drążek stabilizatora</i> стабилизатор поперечной устойчивости			
0875355		Biellette barre stab.	
OE 508735		<i>Stabilizer bar stub axle</i>	
	2		
	TT /all models	-12/06	
2300028		Biellette barre stab.	
OE 508756		<i>Stabilizer bar stub axle</i>	
	2		
	BVM		
	1.6 HDi	DV6UTED4	01/07-
	2.0i 16v.	EW10ABE4	01/07-
	2.0 HDi	DW10UTED4	01/07-
	2.0 HDi FAP	DW10BTED4	01/07-
	0935155		Liaison élastique
OE 509315		<i>Elastic link</i>	
	3		
	Ø int.12.5 Ø ext.37.5 long. tube int.20 ext.22		
TT /all models	-12/06		
0945695		Palier de barre milieu	
OE 509469		<i>Middle bar main bearing</i>	
	1		
	Barre Ø 24		
TT /all models	-12/06		

... Expert VU ...

SASIC

PEUGEOT



Barre stabilisatrice
 Stabilizer bar
 Barra estabilizadora
 Drażek stabilizatora
 стабилизатор поперечной устойчивости

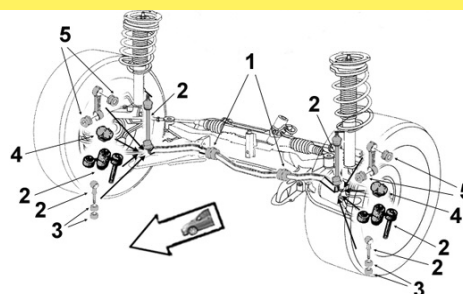

2300045 **Palier de barre milieu**
 Part/oe 1440177280 *Middle bar main bearing*



1	Barre Ø 25 2ème montage 01/07-		
	1.6 HDi	DV6UTED4	12/11-
	1.6 HDi	DV6DU M	12/11-
	1.6 HDi	DV6UC	12/11-
	2.0i 16v.	EW10A	12/11-
	2.0 HDi FAP	DW10BTED4/ CTED4	12/11-
	2.0 HDi FAP	DW10UTED4	12/11-
	2.0 HDi FAP	DW10CD/ CE DTR	12/11-

Bras & Triangle de suspension

Control arm
 Brazo y triángulo
 Wahacz
 Рычаг подвески

G/L D/R

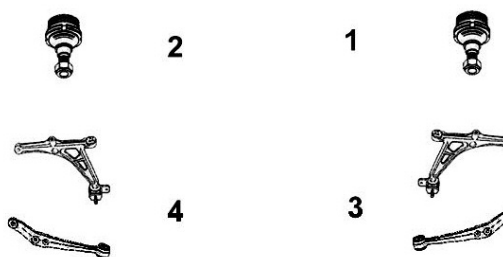

5203943 **Triangle de susp. G**
 OE 3520P4 *Left track control arm*



4	Avec rotule With ball joint		
	1.6i	1580 SPi	-01/05/00
	1.8i	XU7JP	13/11/95-12/10/03
	1.9 D	DW8/B	13/11/95-28/03/06
	1.9 D	XUD9	-01/07/98
	1.9 TD	XUD9TE	-12/10/03
	2.0i 16v.	EW10J4	13/11/95-28/03/06
	2.0 HDi	DW10ATED/ 4/+	13/11/95-28/03/06
	2.0 HDi	DW10BTED W3/W4	13/11/95-28/03/06

5213643 **Triangle de susp. D**
 OE 3521K4 *Right track control arm*



3	Avec rotule With ball joint		
	1.6i	1580 SPi	-01/05/00
	1.8i	XU7JP	13/11/95-12/10/03
	1.9 D	DW8/B	13/11/95-28/03/06
	1.9 D	XUD9	-01/07/98
	1.9 TD	XUD9TE	-12/10/03
	2.0i 16v.	EW10J4	13/11/95-28/03/06
	2.0 HDi	DW10ATED/ 4/+	13/11/95-28/03/06
	2.0 HDi	DW10BTED W3/W4	13/11/95-28/03/06

7470021 **Triangle de susp. G**
 OE 3520S6 *Left track control arm*



4	Avec rotule With ball joint		
	Animation gamme U65		
	2.0 HDi	DW10BTED +	04/07/06-12/06
	2.0 HDi	DW10BTED W4	04/07/06-12/06

7470022 **Triangle de susp. D**
 OE 3521P7 *Right track control arm*



3	Avec rotule With ball joint		
	Animation gamme U65		
	2.0 HDi	DW10BTED +	04/07/06-12/06
	2.0 HDi	DW10BTED W4	04/07/06-12/06

7470001 **Triangle de susp. G**
 OE 3520R8 *Left track control arm*



4	Avec rotule With ball joint		
	1.6 HDi	DV6DU M	01/07-
	1.6 HDi	DV6UC/TED4	01/07-
	2.0i 16v.	EW10A	01/07-
	2.0 HDi FAP	DW10CD DTR	01/07-
	2.0 HDi FAP	DW10CE DTR	01/07-
	2.0 HDi FAP	DW10CTED4	01/07-
	2.0 HDi	DW10UTED4	01/07-
	2.0 HDi FAP	DW10BTED4	01/07-

7470002 **Triangle de susp. D**
 OE 3521N9 *Right track control arm*



3	Avec rotule With ball joint		
	1.6 HDi	DV6DU M	01/07-
	1.6 HDi	DV6UC/TED4	01/07-
	2.0i 16v.	EW10A	01/07-
	2.0 HDi FAP	DW10CD DTR	01/07-
	2.0 HDi FAP	DW10CE DTR	01/07-
	2.0 HDi FAP	DW10CTED4	01/07-
	2.0 HDi	DW10UTED4	01/07-
	2.0 HDi FAP	DW10BTED4	01/07-

... Expert VU ...





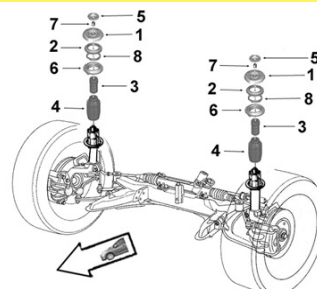



Support d'amortisseur
 Suspension mounting
 Soporte amortiguador
 Poduszka amortyzatora
 Опора амортизатора



PEUGEOT



<p>0385175 OE 503870</p> 	<p>Support suspension G <i>Left suspension mounting</i></p> <p>1</p> <p>TT /all models DNA -12/06</p>	<p>0385165 OE 503868</p> 	<p>Support suspension D <i>Right suspension mounting</i></p> <p>1</p> <p>TT /all models DNA -12/06</p>																																																																				
<p>0385165 OE 503868</p> 	<p>Support suspension G <i>Left suspension mounting</i></p> <p>1</p> <p>TT /all models DA -12/06</p>	<p>0385175 OE 503870</p> 	<p>Support suspension D <i>Right suspension mounting</i></p> <p>1</p> <p>TT /all models DA -12/06</p>																																																																				
<p>0355385 OE 503555</p> 	<p>Butée à billes G/D <i>L/R ball bearing</i></p> <p>2</p> <p>TT /all models -12/06</p> <table style="width: 100%; border: none;"> <tr> <td style="width: 15%;">1.6 HDi</td> <td style="width: 25%;">DV6UTED4</td> <td style="width: 15%;">01/07-</td> <td style="width: 45%;"></td> </tr> <tr> <td>2.0i 16v.</td> <td>EW10A</td> <td>01/07-</td> <td></td> </tr> <tr> <td>2.0 HDi</td> <td>DW10UTED4</td> <td>01/07-</td> <td></td> </tr> <tr> <td>2.0 HDi</td> <td>DW10BTED4</td> <td>01/07-</td> <td></td> </tr> <tr> <td>2.0 HDi</td> <td>DW10CTED4</td> <td>01/07-</td> <td></td> </tr> </table>	1.6 HDi	DV6UTED4	01/07-		2.0i 16v.	EW10A	01/07-		2.0 HDi	DW10UTED4	01/07-		2.0 HDi	DW10BTED4	01/07-		2.0 HDi	DW10CTED4	01/07-		<p>0315395 OE 503139</p> 	<p>Coupelle amortisseur G/D <i>L/R shock absorber cup</i></p> <p>6</p> <p>TT /all models Bonne route & Route inégale -07/09/00</p>																																																
1.6 HDi	DV6UTED4	01/07-																																																																					
2.0i 16v.	EW10A	01/07-																																																																					
2.0 HDi	DW10UTED4	01/07-																																																																					
2.0 HDi	DW10BTED4	01/07-																																																																					
2.0 HDi	DW10CTED4	01/07-																																																																					
<p>0315505 OE 503150</p> 	<p>Coupelle amortisseur G/D <i>L/R shock absorber cup</i></p> <p>6</p> <table style="width: 100%; border: none;"> <tr> <td style="width: 15%;">1.6 HDi</td> <td style="width: 25%;"></td> <td style="width: 25%;">DV6UTED4</td> <td style="width: 35%;">01/07-</td> </tr> <tr> <td>1.9 D</td> <td>Bonne route Gamme U65</td> <td>DW8B</td> <td>09/03-12/06</td> </tr> <tr> <td>1.9 D</td> <td>Bonne route</td> <td>DW8</td> <td>08/09/00-12/06</td> </tr> <tr> <td>1.9 D</td> <td>Bonne route Gamme U64</td> <td>DW8B</td> <td>-01/05/04</td> </tr> <tr> <td>1.9 D</td> <td>Route inégale</td> <td>DW8/B</td> <td>08/09/00-12/06</td> </tr> <tr> <td>2.0i 16v.</td> <td>Bonne route Gamme U64</td> <td>EW10J4</td> <td>08/09/00-12/06</td> </tr> <tr> <td>2.0i 16v.</td> <td>Bonne route Gamme U65</td> <td>EW10J4</td> <td>09/03-12/06</td> </tr> <tr> <td>2.0i 16v.</td> <td>Route inégale</td> <td>EW10J4</td> <td>08/09/00-12/06</td> </tr> <tr> <td>2.0i 16v.</td> <td></td> <td>EW10A</td> <td>01/07-</td> </tr> <tr> <td>2.0 HDi</td> <td>Bonne route</td> <td>DW10BTED W3</td> <td>08/09/00-12/06</td> </tr> <tr> <td>2.0 HDi</td> <td>Bonne route Gamme U64</td> <td>DW10BTED W4/+</td> <td>-01/05/04</td> </tr> <tr> <td>2.0 HDi</td> <td>Bonne route Gamme U65</td> <td>DW10BTED W4/+</td> <td>09/03-12/06</td> </tr> <tr> <td>2.0 HDi</td> <td>Route inégale</td> <td>DW10</td> <td>08/09/00-12/06</td> </tr> <tr> <td>2.0 HDi</td> <td></td> <td>DW10UTED4</td> <td>01/07-</td> </tr> <tr> <td>2.0 HDi</td> <td></td> <td>DW10BTED4</td> <td>01/07-</td> </tr> <tr> <td>2.0 HDi</td> <td></td> <td>DW10CTED4</td> <td>01/07-</td> </tr> <tr> <td>2.0 HDi sans FAP</td> <td>Bonne route Gamme U65</td> <td>DW10ATED4</td> <td>-12/06</td> </tr> </table>			1.6 HDi		DV6UTED4	01/07-	1.9 D	Bonne route Gamme U65	DW8B	09/03-12/06	1.9 D	Bonne route	DW8	08/09/00-12/06	1.9 D	Bonne route Gamme U64	DW8B	-01/05/04	1.9 D	Route inégale	DW8/B	08/09/00-12/06	2.0i 16v.	Bonne route Gamme U64	EW10J4	08/09/00-12/06	2.0i 16v.	Bonne route Gamme U65	EW10J4	09/03-12/06	2.0i 16v.	Route inégale	EW10J4	08/09/00-12/06	2.0i 16v.		EW10A	01/07-	2.0 HDi	Bonne route	DW10BTED W3	08/09/00-12/06	2.0 HDi	Bonne route Gamme U64	DW10BTED W4/+	-01/05/04	2.0 HDi	Bonne route Gamme U65	DW10BTED W4/+	09/03-12/06	2.0 HDi	Route inégale	DW10	08/09/00-12/06	2.0 HDi		DW10UTED4	01/07-	2.0 HDi		DW10BTED4	01/07-	2.0 HDi		DW10CTED4	01/07-	2.0 HDi sans FAP	Bonne route Gamme U65	DW10ATED4	-12/06
1.6 HDi		DV6UTED4	01/07-																																																																				
1.9 D	Bonne route Gamme U65	DW8B	09/03-12/06																																																																				
1.9 D	Bonne route	DW8	08/09/00-12/06																																																																				
1.9 D	Bonne route Gamme U64	DW8B	-01/05/04																																																																				
1.9 D	Route inégale	DW8/B	08/09/00-12/06																																																																				
2.0i 16v.	Bonne route Gamme U64	EW10J4	08/09/00-12/06																																																																				
2.0i 16v.	Bonne route Gamme U65	EW10J4	09/03-12/06																																																																				
2.0i 16v.	Route inégale	EW10J4	08/09/00-12/06																																																																				
2.0i 16v.		EW10A	01/07-																																																																				
2.0 HDi	Bonne route	DW10BTED W3	08/09/00-12/06																																																																				
2.0 HDi	Bonne route Gamme U64	DW10BTED W4/+	-01/05/04																																																																				
2.0 HDi	Bonne route Gamme U65	DW10BTED W4/+	09/03-12/06																																																																				
2.0 HDi	Route inégale	DW10	08/09/00-12/06																																																																				
2.0 HDi		DW10UTED4	01/07-																																																																				
2.0 HDi		DW10BTED4	01/07-																																																																				
2.0 HDi		DW10CTED4	01/07-																																																																				
2.0 HDi sans FAP	Bonne route Gamme U65	DW10ATED4	-12/06																																																																				

... Expert VU ...

SASIC

PEUGEOT



Support d'amortisseur
Suspension mounting
Soporte amortiguador
Poduszka amortyzatora
Опора амортизатора

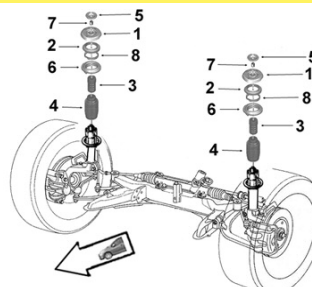

0335395

OE 503339

Butée de suspension G/D

L/R suspension bush



3 H105

TT /all models -12/06

2650012

OE 5033A5

Butée de suspension G/D

L/R suspension bush



3 H 111

1.6 HDi	Susp. normale & Susp. renforcée AV AR	DV6UTED4 BVM BE4R	01/07-
1.6 HDi	Plancher cabine	DV6UTED4	01/07-
2.0i 16v.	Susp. normale & Susp. renforcée AV AR	EW10A BVM BE4R	01/07-
2.0i 16v.	Plancher cabine	EW10A	01/07-
2.0 HDi	Susp. normale & Susp. renforcée AV AR	DW10UTED4 ML6C	01/07-
2.0 HDi FAP	Susp. normale & Susp. renforcée AV AR	DW10BTED4	01/07-
2.0 HDi FAP	Plancher cabine	DW10BTED4	01/07-
2.0 HDi	Plancher cabine	DW10UTED4	01/07-

2545195

OE 525446

Protecteur amortisseur G/D

L/R shock absorber protector



4

TT /all models		-12/06
1.6 HDi	DV6UTED4	01/07-
2.0i 16v.	EW10A	01/07-
2.0 HDi	DW10UTED4	01/07-
2.0 HDi	DW10CTED4	01/07-
2.0 HDi FAP	DW10BTED4 /UTED4	01/07-

1005264

OE -

Kit rép. suspension G

Left susp. mounting repair kit



DNA

1.6i	-12/06
1.8i	-12/06
1.9 D	-12/06
1.9 TD	-12/06
2.0i 16v.	-12/06
2.0 HDi	-12/06

1005263

OE -

Kit rép. suspension D

Right susp. mounting repair kit



DNA

1.6i	-12/06
1.8i	-12/06
1.9 D	-12/06
1.9 TD	-12/06
2.0i 16v.	-12/06
2.0 HDi	-12/06

1005263

OE -

Kit rép. suspension G

Left susp. mounting repair kit



DA

1.6i	-12/06
1.8i	-12/06
1.9 D	-12/06
1.9 TD	-12/06
2.0i 16v.	-12/06
2.0 HDi	-12/06

1005264

OE -

Kit rép. suspension D

Right susp. mounting repair kit



DA

1.6i	-12/06
1.8i	-12/06
1.9 D	-12/06
1.9 TD	-12/06
2.0i 16v.	-12/06
2.0 HDi	-12/06

... Expert VU



Support d'amortisseur
Suspension mounting
Soporte amortiguador
Poduszka amortyzatora
Опора амортизатора

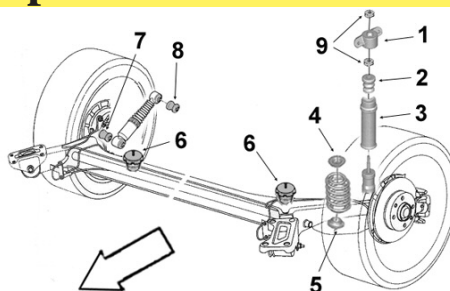

PEUGEOT



1645345

OE 516434

Coupelle sup. ressort AR

Rear spring upper cup



4	TT /all models U65 sans barre anti devers AV		09/03-12/06
	1.6i Sans barre anti devers AV	1580 SPi	-12/06
	1.6 HDi Susp. métallique	DV6UTED4	01/07-
	1.8i sans barre anti devers AV	XU7JP	-12/06
	1.9 D sans barre anti devers AV	DW8/B XUD9	-12/06
	1.9 TD sans barre anti devers AV	XUD9TE	-12/06
	2.0i 16v. Susp. métallique	EW10A	01/07-
2.0 HDi FAP Susp. métallique	DW10BTED4	01/07-	
2.0 HDi Susp. métallique	DW10UTED4	01/07-	

1665475

OE 516647

Butée de talonnage

Bushing



6	Ø 55 H102 Sans barre anti devers AV		
	1.6i	1580 SPi	-17/02/98
	1.8i	XU7JP	-17/02/98
	1.9 D	XUD9	-17/02/98
	1.9 TD	XUD9TE	-17/02/98

1665565

OE 516656

Butée de talonnage

Bushing



6	Ø 55 H 113 sans barre anti devers AV	
	TT /all models	-17/02/98
	Sauf 1.6i 1580 SPI	-17/02/98
	Sauf 1.8i Mot. XU7JP	-17/02/98
	Sauf 1.9D Mot. XUD9	-17/02/98
Sauf 1.9TD Mot. XUD9TE	-17/02/98	

Eléments TRAIN ARRIERE

Rear axle parts

Tren TRAS

Elementy zawieszenia tylnego

элементы задней оси.



1525615

OE 515261

Articulation essieu AR

Rear axle bush

Ø int.12 Ø ext.46 long. tube int.60 ext.48



TT /all models -12/06

J5 ...

Eléments DIRECTION

Steering parts

Elementos Direcciones

Elementy uklad kierowniczy

Элементы рулевой системы

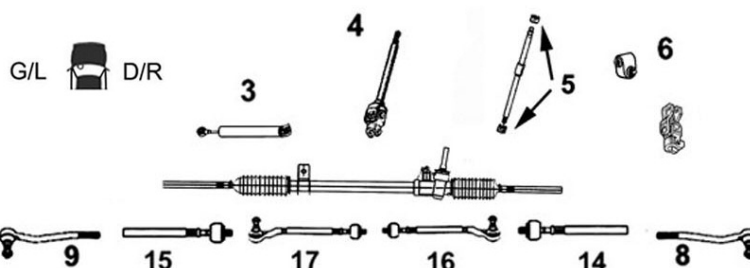

8123273

Part/oe 381227

Axe de bielle G/D

L/R axial joint



14 Côté dir. M16x1.5 Côté rot. M16x1.5
15 long 292 mm

TT /all models DNA

3008071

Part/oe 381283

Axe de bielle G/D

L/R axial joint



14 Côté dir. M14x1.5 Côté rot. M16x1.5
15 long 280 mm

TT /all models DA

... J5 ...

Eléments DIRECTION
Steering parts
Elementos Direcciones
Elementy układ kierowniczy
Элементы рулевой системы

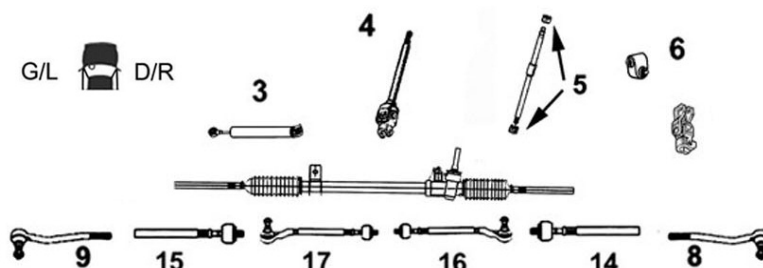

PEUGEOT

SASIC

8173113

OE 381711

Rotule de direction G/D

L/R tie rod end

8
9 $\varnothing 12 \varnothing 16$ M16x1.5

TT /all models

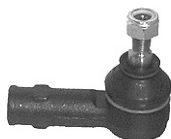

1034534

OE 410353

Axe de volant

Steering wheel shaft

4

TT /all models DNA



1034A74

OE 4103A7

Axe de volant

Steering wheel shaft

4

TT /all models DA



1264104

OE 412610

Bague de guidage colonne

Ring

5

TT /all models



Barre stabilisatrice

Stabilizer bar

Barra estabilizadora

Drażek stabilizatora

стабилизатор поперечной устойчивости

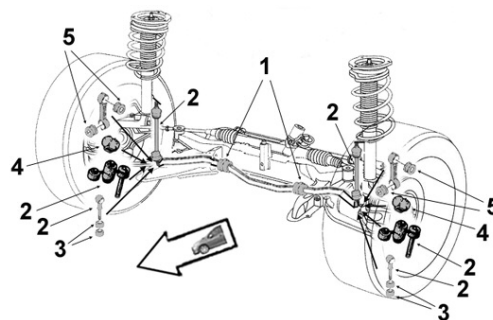

5613083

OE 356108

Palier de barre

Bar main bearing

1 \varnothing int.22 \varnothing ext. 48 ep. 24.5

TT /all models



... J5 ...



Eléments SUSPENSION
Suspension parts
Elementos suspensión
Elementy zawieszenie
Элементы подвески

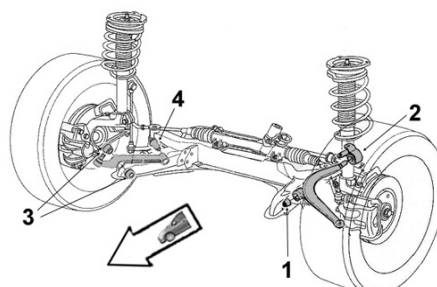

PEUGEOT



... J5 ...

SASIC

PEUGEOT

Bras & Triangle de suspension

Control arm
Brazo y triángulo
Wahacz
Рычаг подвески

G/L  D/R



6403183

OE 364017

Rotule de susp. inf. G/D

L/R lower suspension ball joint

1
2

M 14 x 1.5 cône Ø 18

TT /all models -12/85



6403263

OE 364026

Rotule de susp. inf. G/D

L/R lower suspension ball joint

1
2

M 16 x 1.5 cône Ø 19

TT /all models 01/86-



1003564

OE -

Kit rép. bras susp. G ou D

L or R track control arm bearing repair kit

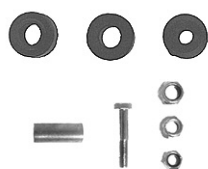

TT /all models Sauf 1800kg

1003567

OE -

Kit rép. bras susp. G ou D

L or R track control arm bearing repair kit

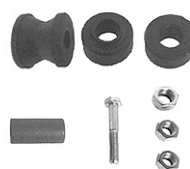

TT /all models 1800kg

105A564S

OE -

Kit rép. train AV

Front axle repair kit

Sans visserie *Without screws and bolts*

TT /all models Sauf 1800kg



105A567S

OE -

Kit rép. train AV

Front axle repair kit

Sans visserie *Without screws and bolts*

TT /all models 1800kg



1053564B

OE -

Kit rép. train AV complet

Front axle complete repair kit

Avec visserie *With screws and bolts*

TT /all models Sauf 1800kg



... J5



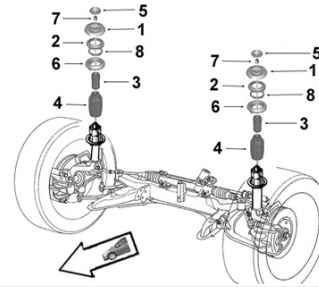

Support d'amortisseur
Suspension mounting
Soporte amortiguador
Poduszka amortyzatora
Опора амортизатора





PEUGEOT



2105205 OE 521020	Support suspension G/D <i>L/R suspension mounting</i>	0355175 OE 503517	Butée à billes G/D <i>L/R ball bearing</i>
	1 TT /all models		2 TT /all models



0335285 OE 503328	Butée de suspension G/D <i>L/R suspension bush</i>
	3 4 TT /all models Sauf 800kg 1800kg Sauf Turbo

Eléments TRAIN ARRIERE <i>Rear axle parts</i> <i>Tren TRAS</i> <i>Elementy zawieszenia tylnego</i> <i>элементы задней оси.</i>		1315465 OE 513146	Art. lame de ressort <i>Spring leaf bush</i> 16x38-72
			TT /all models

J7 ...

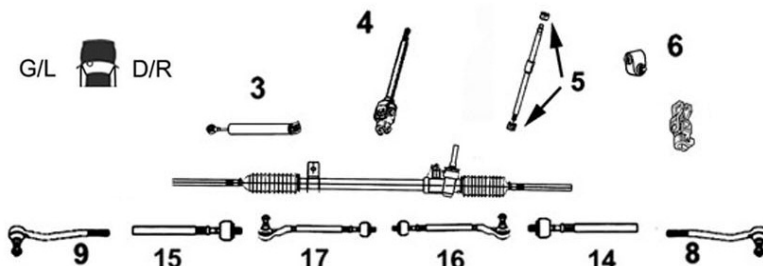
Eléments DIRECTION
Steering parts
Elementos Direcciones
Elementy uklad kierowniczy
Элементы рулевой системы



8133303 OE 381330	Bielle de direction G/D <i>L/R steering rod</i>	8993223 OE 389922	Kit rép. de timonerie dir. <i>Steering repair kit</i> <i>Avec visserie With screws and bolts</i>
	16 17 TT /all models 01/65-12/80		TT /all models 01/65-12/80

... J7



Eléments SUSPENSION

Suspension parts

Elementos suspensión

Elementy zawieszenia

Элементы подвески

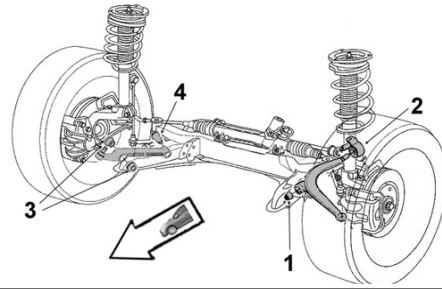

SASIC

PEUGEOT

5613053

OE 356105

Articulation

Bush

4 Ø int.16 Ø ext.36 coll.45 long. tube int.46.5 ext.35 ep. coll.6



TT /all models

Bras & Triangle de suspension

Control arm

Brazo y triángulo

Wahacz

Рычаг подвески

G/L D/R



105A537S

OE -

Kit rép. train AV

Front axle repair kit

Sans visserie Without screws and bolts



TT /all models 01/65-12/80

J9 ...

Eléments DIRECTION

Steering parts

Elementos Direcciones

Elementy układu kierowniczy

Элементы рулевой системы

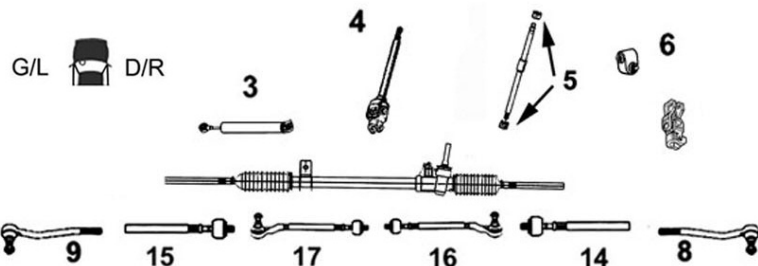

8133303

OE 381330

Bielle de direction G/D

L/R steering rod

16
17



TT /all models 01/80-

8993223

OE 389922

Kit rép. de timonerie dir.

Steering repair kit

Avec visserie With screws and bolts

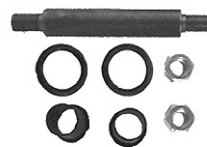

TT /all models 01/80-

... J9



Eléments SUSPENSION
Suspension parts
Elementos suspensión
Elementy zawieszenia
Элементы подвески

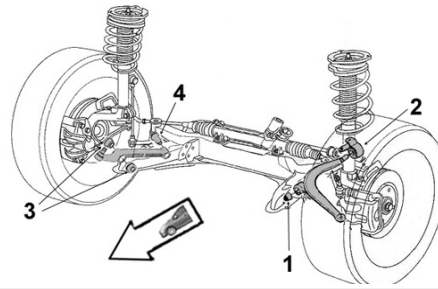

5613053
 OE 356105

Articulation
Bush



4 Ø int.16 Ø ext.36 coll.45 long. tube int.46.5 ext.35 ep. coll.6

TT /all models

Bras & Triangle de suspension

Control arm
Brazo y triángulo
Wahacz
Рычаг подвески

G/L D/R



105A537S
 OE -

Kit rép. train AV
Front axle repair kit



Sans visserie *Without screws and bolts*

TT /all models 01/80-

Partner ...

Eléments DIRECTION

Steering parts
Elementos Direcciones
Elementy układ kierowniczy
Элементы рулевой системы

G/L D/R

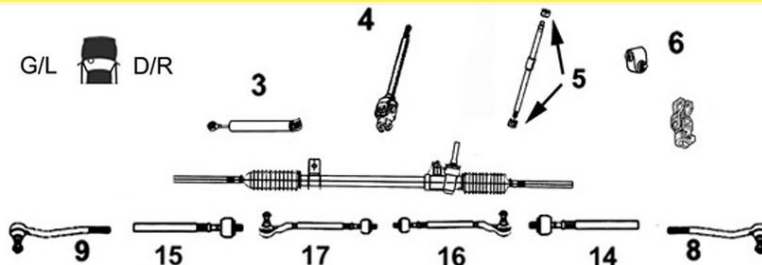

0114444
 OE 401144

Vérin dir. assistée
Power steering jack



3	1.1i	TU1M+	-09/02
	1.1i	TU1JP	-05/08
	1.4i	TU3JP	-05/08
	1.4i	TU3A	10/02-05/08
	1.6i 16v.	TU5JP4	-05/08
	1.8i	XU7JB	-09/02
	1.8 D	XUD7	-09/02
	1.9 D	DW8/B XUD9	-09/02
	1.9 D	DW8B	10/02-05/08
	TT Elec. /All models Electric	SA18	-09/02
	TT Elec. /All models Electric VU	SA18	10/02-05/08

... Partner ...

Eléments DIRECTION

Steering parts

Elementos Direcciones

Elementy układ kierowniczy

Элементы рулевой системы

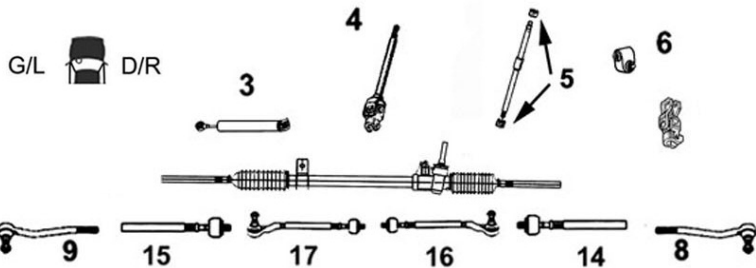

PEUGEOT

SASIC

0114654

OE 401165

Vérin dir. assistée

Power steering jack



3

1.6 HDi	DV6ATED4	10/02-05/08
1.6 HDi	DV6BTED4	10/02-05/08
2.0 HDi	DW10TD	-05/08

2006021

Part/oe 3812C0

Axe de bielle G/D

L/R axial joint



14

15

côté dir. M12x1.0 côté rot. M14x1.5 long 340 mm

1.1i	TU1M+	-09/02	1.9 D	DNA DA	DW8/B	XUD9	-09/02
1.1i	TU1JP	-05/08	1.9 D		DW8B		10/02-05/08
1.4i	TU3.2	-09/02	2.0 HDi	DNA	DW10TD		-09/02
1.4i	TU3JP	-05/08					
1.4i	TU3A	10/02-05/08					
1.6i 16v.	TU5JP4	-05/08					
1.8i	DNA DA	XU7JB	-09/02	TT Elec. /All models	Electric	SA18	-09/02
1.8D	DNA DA	XUD7	-09/02	TT Elec. /All models	Electric VU	SA18	10/02-05/08

3008155

Part/oe 3812C6

Axe de bielle G/D

L/R axial joint



14

15

côté dir. M12x1.0 côté rot. M14x1.5 long 330 mm

2.0 HDi	DA	DW10TD	-09/02
2.0 HDi		DW10TD	10/02-11/04/04

7770009

OE 3812E4

Axe de bielle G/D

L/R axial joint



14

15

côté dir. M12x1.0 côté rot. M14x1.5 long 336 mm

1.6 HDi	DV6ATED4	10/02-05/08
1.6 HDi	DV6BTED4	10/02-05/08
2.0 HDi	DW10TD	12/04/04-05/08

TT Elec. /All models	Electric VU	
	Venturi	10/02-05/08

7770004

Part/oe 3812F4

Axe de bielle G/D

L/R axial joint



14

15

côté dir. M14x1.5 côté rot. M14x1.5 long 262 mm

1.6i 16v.	VP	EP6C		05/08-
1.6i 16v.		EP6C B	TU5JP4/B	05/08-
1.6 HDi		DV6DTE	M/ETED M	05/08-
1.6 HDi	FAP VU	DV6TE	D4BU	05/08-
1.6 HDi	VP	DV6ATE	D4/BTE	D4 DV6C DV6DTE
1.6 HDi	FAP VP	DV6TE	D4/B	05/08-
1.6 HDi	VU	DV6AUTE	D4 /BUTE	D4 05/08-
TT Elec. /All models	Electric VU			05/08-

2006105

OE -

Bielle de direction G/D

L/R steering rod



16

17













côté pignon

1.1	DA	TU1M+/1JP	-09/02	1.9 D	DA	XUD9	-09/02
1.1i		TU1JP	10/02-05/08	1.9 D	DA	DW8/B	-09/02
1.4	DA	TU3JP	-09/02	1.9 D		DW8B	10/02-05/08
1.4i		TU3JP	10/02-05/08				
1.6i 16v.	DA	TU5JP4	-09/02	TT Elec. /All models	Electric DA	SA18	-09/02
1.6i 16v.		TU5JP4	10/02-05/08	TT Elec. /All models	Electric VU	SA18	10/02-05/08
1.8	DA	XU7JB	-09/02				
1.8 D	DA	XUD7	-09/02				

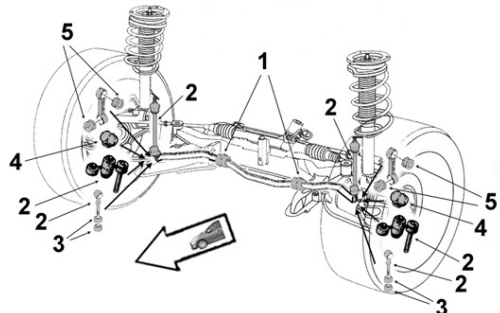
... Partner ...

PEUGEOT

SASIC

... Partner ...				
8173183 OE 381750	Rotule de direction G/D <i>L/R tie rod end</i>			
	8	M14x1.5		
	9	1.1i TU1M+ -09/02	1.8i XU7JB -09/02	
		1.1i TU1JP -05/08	1.8 D XUD7 -09/02	
		1.4i TU3A 10/02-05/08	1.9 D DW8/B XUD9 -09/02	
		1.4i TU3JP -05/08	1.9 D DW8B 10/02-05/08	
		1.6i 16v. TU5JP4 -05/08	2.0 HDi DW10TD -05/08	
		1.6 HDi DV6ATED4 10/02-05/08	TT Elec. /All models Electric SA18 -09/02	
		1.6 HDi DV6BTED4 10/02-05/08	TT Elec. /All models Electric VU SA18 10/02-05/08	
	<hr/>			
	7670017 OE 381789	Rotule de direction G <i>Left tie rod end</i>		
	9	M14x1.5		
		1.6i 16v. TU5JP4/B 05/08-		
		1.6i 16v. EP6C B 05/08-		
		1.6i 16v. VP EP6C 05/08-		
		1.6 HDi DV6C/DTED 05/08-		
		1.6 HDi DV6ETED4 05/08-		
		1.6 HDi DV6DTED M 05/08-		
		1.6 HDi DV6ETED M 05/08-		
		1.6 HDi FAP VP DV6TED4/B 05/08-		
		1.6 HDi FAP VU DV6TED4BU 05/08-		
	1.6 HDi VP DV6ATED4 05/08-			
	1.6 HDi VP DV6BTED4 05/08-			
	1.6 HDi VU DV6AUTED4 05/08-			
	1.6 HDi VU DV6BUTED4 05/08-			
	TT Elec. /All models Electric VU 05/08-			
<hr/>				
7670016 OE 381788	Rotule de direction D <i>Right tie rod end</i>			
	8	M14x1.5		
		1.6i 16v. TU5JP4/B 05/08-		
		1.6i 16v. EP6C B 05/08-		
		1.6i 16v. VP EP6C 05/08-		
		1.6 HDi DV6C/DTED 05/08-		
		1.6 HDi DV6ETED4 05/08-		
		1.6 HDi DV6DTED M 05/08-		
		1.6 HDi DV6ETED M 05/08-		
		1.6 HDi FAP VP DV6TED4/B 05/08-		
		1.6 HDi FAP VU DV6TED4BU 05/08-		
	1.6 HDi VP DV6ATED4 05/08-			
	1.6 HDi VP DV6BTED4 05/08-			
	1.6 HDi VU DV6AUTED4 05/08-			
	1.6 HDi VU DV6BUTED4 05/08-			
	TT Elec. /All models Electric VU 05/08-			
<hr/>				
	Barre stabilisatrice <i>Stabilizer bar</i> <i>Barra estabilizadora</i> <i>Drażek stabilizatora</i> <i>стабилизатор поперечной устойчивости</i>			
				
<hr/>				
0875395 OE 508761	Biellette barre stab. <i>Stabilizer bar stub axle</i>			
	2	TT /all models -09/02		
		1.1i TU1JP 10/02-05/08		
		1.4i TU3A/JP 10/02-05/08		
		1.6i 16v. TU5JP4 10/02-05/08		
		1.6 HDi DV6ATED4 10/02-05/08		
		1.6 HDi DV6BTED4 10/02-05/08		
		1.9 D DW8B 10/02-05/08		
		2.0 HDi DW10TD 10/02-05/08		
		TT Elec. /All models Electric SA18 10/02-05/08		
	<hr/>			
2300030 OE 508757	Biellette barre stab. <i>Stabilizer bar stub axle</i>			
	2	1.6i 16v. VP VU TU5JP4/B 05/08-		
		1.6i 16v. VP EP6C 05/08-		
		1.6i 16v. VP VU EP6C DTR 05/08-		
		1.6 HDi FAP VU DV6TED4BU 05/08-		
		1.6 HDi VP DV6ATED4 05/08-		
		1.6 HDi VP DV6BTED4 05/08-		
		1.6 HDi VP DV6C 05/08-		
		1.6 HDi VP VU DV6DTED 05/08-		
		1.6 HDi VP VU DV6ETED4 05/08-		
		1.6 HDi FAP VP DV6TED4 05/08-		
	1.6 HDi FAP VP DV6TED4B 05/08-			
	1.6 HDi VU DV6AUTED4 05/08-			
	1.6 HDi VU DV6BUTED4 05/08-			
<hr/>				
0945655 OE 509465	Palier de barre milieu <i>Middle bar main bearing</i>			
	1	Barre Ø 21		
		TT /all models Susp. réhaussée & Susp. renforcée AV AR -09/02		
		TT /all models Véhicule tout chemin -09/02		
		TT /all models 475kg 600kg fourgon court Susp. normale -09/02		
		TT /all models fourgonnette familiale Susp. normale -09/02		
		TT Elec. /All models Electric 500kg Fourgon court SA18 10/02-05/08		
		1.4i 600kg Fourgon court TU3A/JP 10/02-05/08		
		1.6 HDi 600kg Fourgon court DV6ATED4/BTED4 10/02-05/08		
		1.9 D 600kg Fourgon court DW8B 10/02-05/08		
		2.0 HDi 600kg Fourgon court DW10TD 10/02-05/08		
<hr/>				

... Partner ...



Barre stabilisatrice
 Stabilizer bar
 Barra estabilizadora
 Drażek stabilizatora
 стабилизатор поперечной устойчивости

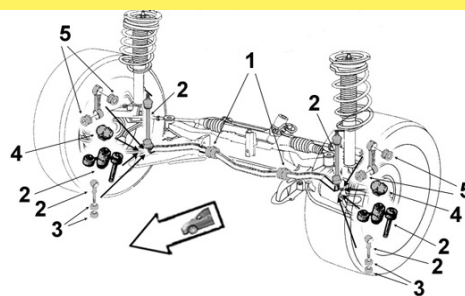

0945775

Palier de barre milieu

OE 509477

Middle bar main bearing



1 Barre Ø 22

TT /all models 765kg plancher cabine court Susp. normale -09/02
 TT /all models 800kg fourgon court susp. normale -09/02

1.4i 800kg Fourgon court
 1.6i 16v. 800kg Fourgon court
 1.6 HDi 800kg Fourgon court
 1.9 D 800kg Fourgon court
 2.0 HDi 800kg Fourgon court

TU3A/JP 10/02-05/08
 TU5JP4 10/02-05/08
 DV6ATED4 /BTED4 10/02-05/08
 DW8B 10/02-05/08
 DW10TD 10/02-05/08

0945895

Palier de barre milieu

OE 5094E3

Middle bar main bearing



1 Barre Ø 23

1.6i 16v. VP
 1.6i 16v. VP VU
 1.6 HDi FAP VU
 1.6 HDi FAP 90hp 66kw VP
 1.6 HDi FAP VP
 1.6 HDi VP
 1.6 HDi VU

EP6C 05/08-
 TU5JP4/B 05/08-
 DV6TED4BU 05/08-
 DV6TED4B 05/08-
 DV6TED4 05/08-
 DV6BTED4/ATED4 05/08-
 DV6BUTED4/AUTED4 05/08-

2300035

Palier de barre milieu

OE 5094E4

Middle bar main bearing



1 Barre Ø 24

1.6i 16v.
 1.6i 16v. VP
 1.6 HDi
 1.6 HDi 90hp 66kw
 1.6 HDi FAP VP
 1.6 HDi FAP VU
 1.6 HDi VP
 1.6 HDi VU

EP6C DTR TU5JP4/B 05/08-
 EP6C 05/08-
 DV6DTED/M DV6ETED4 05/08-
 DV6ETED M 05/08-
 DV6TED4/B 05/08-
 DV6TED4BU 05/08-
 DV6ATED4/BTED4 DV6C 05/08-
 DV6AUTED4/BUTED4 05/08-

2300034

Palier de barre milieu

OE 5094E6

Middle bar main bearing



1 Barre Ø 24.5 VU

1.6i 16v.
 1.6 HDi 90hp 66kw
 1.6 HDi FAP
 1.6 HDi
 1.6 HDi
 1.6 HDi

EP6C DTR TU5JP4/B 05/08-
 DV6ETED M 05/08-
 DV6TED4BU 05/08-
 DV6AUTED4/BUTED4 05/08-
 DV6DTED/M 05/08-
 DV6ETED4 05/08-

2300036

Palier de barre milieu

OE 5094E7

Middle bar main bearing



1 Barre Ø 25

1.6i 16v.
 1.6i 16v. VP
 1.6 HDi
 1.6 HDi 90hp 66kw
 1.6 HDi FAP VP
 1.6 HDi FAP VU
 1.6 HDi VP
 1.6 HDi VP
 1.6 HDi VU

EP6C DTR TU5JP4/B 05/08-
 EP6C 05/08-
 DV6DTED/M /ETED4 05/08-
 DV6ETED M 05/08-
 DV6TED4/B 05/08-
 DV6TED4BU 05/08-
 DV6ATED4/BTED4 05/08-
 DV6C 05/08-
 DV6AUTED4/BUTED4 05/08-

... Partner ...





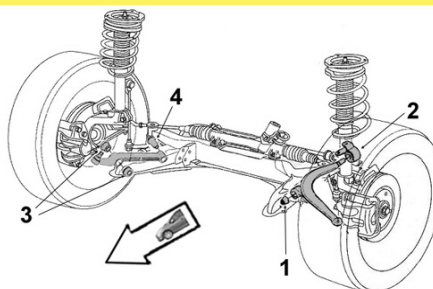

Eléments SUSPENSION
Suspension parts
Elementos suspensión
Elementy zawieszenie
Элементы подвески



PEUGEOT



2005250 OE -	Articulation AV <i>Front bush</i>	5233913 OE 352391	Articulation AV <i>Front bush</i>
	1 Ø int.12 Ø ext.33 coll.44 long. tube int.31 ext.27 ep. coll.4.5 TT /all models -09/02		1 Ø int.14 Ø ext.55 long. tube int.56 ext.32 1.6i 16v. VP EP6C 05/08- 1.6i 16v. VP VU TU5JP4/B 05/08- 1.6 HDi FAP 90hp 66kw VP DV6TED4B 05/08- 1.6 HDi FAP VP DV6TED4 05/08- 1.6 HDi FAP VU DV6TED4BU 05/08- 1.6 HDi VP DV6ATED4/BTED4 05/08- 1.6 HDi VU DV6AUTED4/BUTED4 05/08-
5233623 OE 352375	Articulation AR <i>Rear bush</i>		
	2 Ø int.19 TT /all models Sauf 1.9D Mot. DW8/B 2.0HDi Mot. DW10TD Mot. élect. SA18 -09/02 TT /all models Sauf susp. renforcée AV AR & sauf tout chemin -09/02		
5233833 OE 352383	Articulation AR <i>Rear bush</i>		
	2 Ø int.18 TT Elec. /All models Electric Susp. normale SA18 04/10/99-09/02 TT /all models Véhicule tout chemin -09/02 1.1i Susp. renforcée AV AR /normale réhaussée TU1JP 10/02-05/08 1.4i susp. renforcée AV AR ou réhaussée TU3A 10/02-05/08 1.4i 800kg Fourgon court susp. normale TU3JP 10/02-05/08 1.4i susp. renforcée AV AR ou réhaussée TU3JP 10/02-05/08 1.6i 16v. 800kg fourgon court Susp. normale TU5JP4 10/02-05/08 1.6i 16v. susp. renforcée AV AR ou réhaussée TU5JP4 10/02-05/08 1.6 HDi Susp. normale DV6ATED4 10/02-05/08 1.6 HDi Susp. renforcée AV AR ou réhaussée DV6ATED4 10/02-05/08 1.6 HDi Susp. normale DV6BTED4 10/02-05/08 1.6 HDi Susp. renforcée AV AR ou réhaussée DV6BTED4 10/02-05/08 1.9 D Avec pavillon multifonction susp. normale DW8/B -09/02 1.9 D Susp. renforcée AV AR /normale réhaussée DW8B 10/02-05/08 2.0 HDi Susp. normale DW10TD 10/02-05/08 2.0 HDi Susp. renforcée AV AR ou réhaussée DW10TD 10/02-05/08		
5233923 OE 352392	Articulation AR <i>Rear bush</i>		
	2 Ø int.14 Ø ext.55 coll.62 long. tube int.49 ext.25 ep. coll.3 1.6i 16v. VP EP6C 05/08- 1.6i 16v. VP VU TU5JP4/B 05/08- 1.6 HDi FAP 90hp 66kw VP DV6TED4B 05/08- 1.6 HDi FAP VP DV6TED4 05/08- 1.6 HDi FAP VU DV6TED4BU 05/08- 1.6 HDi VP DV6ATED4/ BTED4 05/08- 1.6 HDi VU DV6AUTED4/ BUTED4 05/08-		

... Partner ...

Bras & Triangle de suspension

Control arm
Brazo y triángulo
Wahacz
Рычаг подвески

G/L  D/R



PEUGEOT

5203F73
OE 3520H5

Triangle de susp. G Left track control arm



4 Sans rotule Without tie rod end

1.1 Susp. normale et réhaussée	TU1JP/ M+	-09/02
1.1i Susp. normale /réhaussée	TU1JP	-06/09/98
1.1i Susp. renforcée AV AR	TU1JP/ M+	-19/10/98
1.1i VP VU Susp. normale	TU1JP	10/02-05/08
1.4i VP Susp. normale	TU3A	10/02-05/08
1.4i 500 600kg VU Fourgon court Susp. normale	TU3A	10/02-05/08
1.4 Susp. normale /réhaussée	TU3JP	-09/02
1.4 Susp. renforcée AV AR	TU3JP	-19/10/98
1.4i VP Susp. normale	TU3JP	10/02-05/08
1.4i 500 600kg VU Fourgon court Susp. normale	TU3JP	10/02-05/08
1.6i 16v. Susp. normale /réhaussée	TU5JP4	-09/02
1.6i 16v. Susp. renforcée AV AR	TU5JP4	-19/10/98
1.6i 16v. VP Susp. normale	TU5JP4	10/02-05/08
1.8 Susp. normale /réhaussée	XU7JB	-09/02
1.8 Susp. renforcée AV AR	XU7JB	-19/10/98
1.8 D Susp. normale /réhaussée	XUD7	-09/02
1.8 D Susp. renforcée AV AR	XUD7	-19/10/98
1.9 D Châssis cabine Susp. normale		
Sans pavillon multifonction Susp. réhaussée	DW8	-06/09/98
1.9 D susp. normale Sans pavillon multifonction	DW8/B	-09/02
1.9 D Susp. réhaussée	DW8/B	-09/02
1.9 D VP Susp. normale Sans pavillon multifonction	DW8B	10/02-05/08
1.9 D 500 600kg VU Fourgon court Susp. normale	DW8B	10/02-05/08
1.9 D Susp. normale /réhaussée	XUD9	-09/02
1.9 D Susp. renforcée AV AR	XUD9	-19/10/98
TT Elec. /All models Electric Susp. normale	SA18	-19/10/98
TT Elec. /All models Electric 500kg VU Fourgon court	SA18	10/02-05/08

5213A73
OE 3521E5

Triangle de susp. D Right track control arm



3 Sans rotule Without tie rod end

1.1 Susp. normale et réhaussée	TU1JP/ M+	-09/02
1.1i Susp. normale /réhaussée	TU1JP	-06/09/98
1.1i Susp. renforcée AV AR	TU1JP/ M+	-19/10/98
1.1i VP VU Susp. normale	TU1JP	10/02-05/08
1.4i VP Susp. normale	TU3A	10/02-05/08
1.4i 500 600kg VU Fourgon court Susp. normale	TU3A	10/02-05/08
1.4 Susp. normale /réhaussée	TU3JP	-09/02
1.4 Susp. renforcée AV AR	TU3JP	-19/10/98
1.4i VP Susp. normale	TU3JP	10/02-05/08
1.4i 500 600kg VU Fourgon court Susp. normale	TU3JP	10/02-05/08
1.6i 16v. Susp. normale /réhaussée	TU5JP4	-09/02
1.6i 16v. Susp. renforcée AV AR	TU5JP4	-19/10/98
1.6i 16v. VP Susp. normale	TU5JP4	10/02-05/08
1.8 Susp. normale /réhaussée	XU7JB	-09/02
1.8 Susp. renforcée AV AR	XU7JB	-19/10/98
1.8 D Susp. normale /réhaussée	XUD7	-09/02
1.8 D Susp. renforcée AV AR	XUD7	-19/10/98
1.9 D Châssis cabine Susp. normale		
Sans pavillon multifonction Susp. réhaussée	DW8	-06/09/98
1.9 D susp. normale Sans pavillon multifonction	DW8/B	-09/02
1.9 D Susp. réhaussée	DW8/B	-09/02
1.9 D VP Susp. normale Sans pavillon multifonction	DW8B	10/02-05/08
1.9 D 500 600kg VU Fourgon court Susp. normale	DW8B	10/02-05/08
1.9 D Susp. normale /réhaussée	XUD9	-09/02
1.9 D Susp. renforcée AV AR	XUD9	-19/10/98
TT Elec. /All models Electric Susp. normale	SA18	-19/10/98
TT Elec. /All models Electric 500kg VU Fourgon court	SA18	10/02-05/08

... Partner ...

PEUGEOT



7470017 Triangle de susp. G			
OE 3520H5+364043 <i>Left track control arm</i>			
NEW	4 Avec rotule With ball joint Ø 16		
	1.1i Susp. normale /réhaussée	TU1JP	-06/09/98
	1.1 Susp. normale et réhaussée	TU1M+	-06/09/98
	1.4 Susp. normale /réhaussée	TU3JP	-06/09/98
	1.6i 16v. Susp. normale /réhaussée	TU5JP4	-06/09/98
	1.8 Susp. normale /réhaussée	XU7JB	-06/09/98
	1.8 D Susp. normale /réhaussée	XUD7	-06/09/98
	1.9 D Châssis cabine Susp. normale		
	1.9 D Susp. normale /réhaussée	DW8 XUD9	-06/09/98 -06/09/98
7470016 Triangle de susp. D			
OE 3521E5+364043 <i>Right track control arm</i>			
NEW	3 Avec rotule With ball joint Ø 16		
	1.1i Susp. normale /réhaussée	TU1JP	-06/09/98
	1.1 Susp. normale et réhaussée	TU1M+	-06/09/98
	1.4 Susp. normale /réhaussée	TU3JP	-06/09/98
	1.6i 16v. Susp. normale /réhaussée	TU5JP4	-06/09/98
	1.8 Susp. normale /réhaussée	XU7JB	-06/09/98
	1.8 D Susp. normale /réhaussée	XUD7	-06/09/98
	1.9 D Châssis cabine Susp. normale		
1.9 D Susp. normale /réhaussée	DW8 XUD9	-06/09/98 -06/09/98	
7470019 Triangle de susp. G			
OE 3520H5+364051 <i>Left track control arm</i>			
NEW	4 Avec rotule With ball joint Ø 18		
	1.1 Susp. normale et réhaussée	TU1JP	07/09/98-09/02
	1.1i Susp. normale	TU1JP	10/02-05/08
	1.1 Susp. normale et réhaussée	TU1M+	07/09/98-09/02
	1.4i VP Susp. normale	TU3A	10/02-05/08
	1.4i 500 600kg VU Fourgon court Susp. normale	TU3A	10/02-05/08
	1.4 Susp. normale /réhaussée	TU3JP	07/09/98-09/02
	1.4i VP Susp. normale	TU3JP	10/02-05/08
	1.4i 500 600kg VU Fourgon court Susp. normale	TU3JP	10/02-05/08
	1.6i 16v. Susp. normale /réhaussée	TU5JP4	07/09/98-09/02
	1.6i 16v. VP Susp. normale	TU5JP4	10/02-05/08
	1.8 Susp. normale /réhaussée	XU7JB	07/09/98-09/02
	1.8 D Susp. normale /réhaussée	XUD7	07/09/98-09/02
	1.9 D Susp. normale Sans pavillon multifonction Susp. réhaussée	DW8/B	-09/02
	1.9 D 500 600kg VU Fourgon court Susp. normale	DW8B	10/02-05/08
1.9 D Susp. normale /réhaussée	XUD9	07/09/98-09/02	
TT Elec. /All models Electric 500kg VU Fourgon court	SA18	10/02-05/08	
7470018 Triangle de susp. D			
OE 3521E5+364051 <i>Right track control arm</i>			
NEW	3 Avec rotule With ball joint Ø 18		
	1.1 Susp. normale et réhaussée	TU1JP	07/09/98-09/02
	1.1i Susp. normale	TU1JP	10/02-05/08
	1.1 Susp. normale et réhaussée	TU1M+	07/09/98-09/02
	1.4i VP Susp. normale	TU3A	10/02-05/08
	1.4i 500 600kg VU Fourgon court Susp. normale	TU3A	10/02-05/08
	1.4 Susp. normale /réhaussée	TU3JP	07/09/98-09/02
	1.4i VP Susp. normale	TU3JP	10/02-05/08
	1.4i 500 600kg VU Fourgon court Susp. normale	TU3JP	10/02-05/08
	1.6i 16v. Susp. normale /réhaussée	TU5JP4	07/09/98-09/02
	1.6i 16v. VP Susp. normale	TU5JP4	10/02-05/08
	1.8 Susp. normale /réhaussée	XU7JB	07/09/98-09/02
	1.8 D Susp. normale /réhaussée	XUD7	07/09/98-09/02
	1.9 D Susp. normale Sans pavillon multifonction Susp. réhaussée	DW8/B	-09/02
	1.9 D 500 600kg VU Fourgon court Susp. normale	DW8B	10/02-05/08
1.9 D Susp. normale /réhaussée	XUD9	07/09/98-09/02	
TT Elec. /All models Electric 500kg VU Fourgon court	SA18	10/02-05/08	

... Partner ...

Bras & Triangle de suspension

Control arm
Brazo y triángulo
Wahacz
Рычаг подвески

G/L  D/R



PEUGEOT



5203J33

OE 3520Q5

Triangle de susp. G

Left track control arm

4 Avec rotule *With ball joint*



1.1i Susp. renforcée AV AR	TU1JP/1M+	20/10/98-09/02
1.1 Véhicule tout chemin	TU1JP/1M+	-09/02
1.1i VP VU Susp. renforcée AV AR & Susp. normale réhaussée	TU1JP	10/02-05/08
1.4i VP VU Susp. renforcée AV AR & Susp. normale réhaussée	TU3A	10/02-05/08
1.4i 800kg VU Fourgon court susp. normale	TU3A	10/02-05/08
1.4 Susp. renforcée AV AR	TU3JP	20/10/98-09/02
1.4 Véhicule tout chemin	TU3JP	-09/02
1.4i VP VU Susp. renforcée AV AR & Susp. normale réhaussée	TU3JP	10/02-05/08
1.4i 800kg VU Fourgon court susp. normale	TU3JP	10/02-05/08
1.6i 16v. Susp. renforcée AV AR	TU5JP4	20/10/98-09/02
1.6i 16v. Véhicule tout chemin	TU5JP4	-09/02
1.6i 16v. VP VU Susp. renforcée AV AR & Susp. normale réhaussée	TU5JP4	10/02-05/08
1.6i 16v. 800kg VU Fourgon court Susp. normale	TU5JP4	10/02-05/08
1.6 HDi VP VU Susp. normale & Susp. renforcée AV AR	DV6ATED4	10/02-05/08
1.6 HDi VP VU Susp. normale réhaussée	DV6ATED4	10/02-05/08
1.6 HDi VP VU	DV6BTED4	10/02-05/08
1.8 Susp. renforcée AV AR	XU7JB	20/10/98-09/02
1.8 Véhicule tout chemin	XU7JB	-09/02
1.8 D Susp. renforcée AV AR	XUD7	20/10/98-09/02
1.8 D Véhicule tout chemin	XUD7	-09/02
1.9 D Susp. normale Avec pavillon multifonction	DW8/B	-09/02
1.9 D VP Susp. normale Avec pavillon multifonction Porte latérale G/D coulissante vitrée	DW8B	10/02-05/08
1.9 D VP VU Susp. renforcée AV AR	DW8B	10/02-05/08
1.9 D VP VU Susp. normale réhaussée	DW8B	10/02-05/08
1.9 D 800kg VU Fourgon court susp. normale	DW8B	10/02-05/08
1.9 D VU Plancher cabine court type 8 Susp. normale	DW8B	10/02-05/08
1.9 D Susp. renforcée AV AR	XUD9	20/10/98-09/02
1.9 D Véhicule tout chemin	XUD9	-09/02
2.0 HDi	DW10TD	-09/02
2.0 HDi VP VU susp. normale & susp. renforcée AV AR	DW10TD	10/02-05/08
2.0 HDi VP VU Susp. normale réhaussée	DW10TD	10/02-05/08
TT Elec. /All models Electric Susp. normale	SA18	20/10/98-09/02
TT Elec. /All models Electric DNA Susp. renforcée AV AR	SA18	04/10/99-09/02
TT Elec. /All models Electric VP VU Susp. renforcée AV AR	SA18	10/02-05/08
TT Elec. /All models Electric VP VU Susp. normale réhaussée	SA18	10/02-05/08

... Partner ...

PEUGEOT



5213F33
OE 3521L6

Triangle de susp. D
Right track control arm



3 Avec rotule *With ball joint*

1.1i Susp. renforcée AV AR	TU1JP/1M+	20/10/98-09/02
1.1 Véhicule tout chemin	TU1JP/1M+	-09/02
1.1i VP VU Susp. renforcée AV AR & Susp. normale réhaussée	TU1JP	10/02-05/08
1.4i VP VU Susp. renforcée AV AR & Susp. normale réhaussée	TU3A	10/02-05/08
1.4i 800kg VU Fourgon court susp. normale	TU3A	10/02-05/08
1.4 Susp. renforcée AV AR	TU3JP	20/10/98-09/02
1.4 Véhicule tout chemin	TU3JP	-09/02
1.4i VP VU Susp. renforcée AV AR & Susp. normale réhaussée	TU3JP	10/02-05/08
1.4i 800kg VU Fourgon court susp. normale	TU3JP	10/02-05/08
1.6i 16v. Susp. renforcée AV AR	TU5JP4	20/10/98-09/02
1.6i 16v. Véhicule tout chemin	TU5JP4	-09/02
1.6i 16v. VP VU Susp. renforcée AV AR & Susp. normale réhaussée	TU5JP4	10/02-05/08
1.6i 16v. 800kg VU Fourgon court Susp. normale	TU5JP4	10/02-05/08
1.6 HDi VP VU Susp. normale & Susp. renforcée AV AR	DV6ATED4	10/02-05/08
1.6 HDi VP VU Susp. normale réhaussée	DV6ATED4	10/02-05/08
1.6 HDi VP VU	DV6BTED4	10/02-05/08
1.8 Susp. renforcée AV AR	XU7JB	20/10/98-09/02
1.8 Véhicule tout chemin	XU7JB	-09/02
1.8 D Susp. renforcée AV AR	XUD7	20/10/98-09/02
1.8 D Véhicule tout chemin	XUD7	-09/02
1.9 D Susp. normale Avec pavillon multifonction	DW8/B	-09/02
1.9 D VP Susp. normale Avec pavillon multifonction Porte latérale G/D coulissante vitrée	DW8B	10/02-05/08
1.9 D VP VU Susp. renforcée AV AR	DW8B	10/02-05/08
1.9 D VP VU Susp. normale réhaussée	DW8B	10/02-05/08
1.9 D 800kg VU Fourgon court susp. normale	DW8B	10/02-05/08
1.9 D VU Plancher cabine court type 8 Susp. normale	DW8B	10/02-05/08
1.9 D Susp. renforcée AV AR	XUD9	20/10/98-09/02
1.9 D Véhicule tout chemin	XUD9	-09/02
2.0 HDi	DW10TD	-09/02
2.0 HDi VP VU susp. normale & susp. renforcée AV AR	DW10TD	10/02-05/08
2.0 HDi VP VU Susp. normale réhaussée	DW10TD	10/02-05/08
TT Elec. /All models Electric Susp. normale	SA18	20/10/98-09/02
TT Elec. /All models Electric DNA Susp. renforcée AV AR	SA18	04/10/99-09/02
TT Elec. /All models Electric VP VU Susp. renforcée AV AR	SA18	10/02-05/08
TT Elec. /All models Electric VP VU Susp. normale réhaussée	SA18	10/02-05/08

5203K83
OE 3520S2

Triangle de susp. inf. G
Lower left track control arm



4 Sans rotule *Without tie rod end*

1.6i 16v. VP	EP6C	05/08-
1.6i 16v.	EP6C B TU5JP4/B	05/08-
1.6 HDi VP	DV6ATED4/ BTED4	05/08-
1.6 HDi VU	DV6AUTED4/ BUTED4	05/08-
1.6 HDi	DV6C DV6DTED/ M	05/08-
1.6 HDi	DV6ETED M DV6ETED4	05/08-
1.6 HDi FAP VP	DV6TED4/B	05/08-
1.6 HDi FAP VU	DV6TED4BU	05/08-
TT Elec. /All models Electric VU		05/08-

... Partner ...

SASIC

PEUGEOT

Bras & Triangle de suspension

Control arm
Brazo y triángulo
Wahacz
Рычаг подвески

G/L  D/R



5213G83

OE 3521P3

Triangle de susp. inf. D

Lower right track control arm



3 Sans rotule Without tie rod end

1.6i 16v. VP	EP6C	05/08-
1.6i 16v.	EP6C B TU5JP4/B	05/08-
1.6 HDi VP	DV6ATED4/ BTED4	05/08-
1.6 HDi VU	DV6AUTED4/ BUTED4	05/08-
1.6 HDi	DV6C DV6DTED/M	05/08-
1.6 HDi	DV6ETED M DV6ETED4	05/08-
1.6 HDi FAP VP	DV6TED4/B	05/08-
1.6 HDi FAP VU	DV6TED4BU	05/08-
TT Elec. /All models Electric VU		05/08-

2005113

OE 364043

Rotule de susp. inf. G/D

L/R lower suspension ball joint



1
2

Ø 16		
1.1 Susp. normale et réhaussée	TU1M+	-06/09/98
1.1i Susp. normale /réhaussée	TU1JP	-06/09/98
1.4 Susp. normale /réhaussée	TU3JP	-06/09/98
1.6i 16v. Susp. normale /réhaussée	TU5JP4	-06/09/98
1.8 Susp. normale /réhaussée	XU7JB	-06/09/98
1.8 D Susp. normale /réhaussée	XUD7	-06/09/98
1.9 D Susp. normale /réhaussée	XUD9	-06/09/98
1.9 D Châssis cabine Susp. normale		
Sans pavillon multifonction Susp. réhaussée	DW8	-06/09/98

6403513

OE 364051

Rotule de susp. inf. G/D

L/R lower suspension ball joint



1
2

Ø 18		
1.1 Susp. normale et réhaussée	TU1M+ /JP	07/09/98-09/02
1.1i VP VU Susp. normale	TU1JP	10/02-05/08
1.4 Susp. normale /réhaussée	TU3JP	07/09/98-09/02
1.4i VP Susp. normale	TU3JP	10/02-05/08
1.4i 500 600kg VU Fourgon court Susp. normale	TU3JP	10/02-05/08
1.4i VP Susp. normale	TU3A	10/02-05/08
1.4i 500 600kg VU Fourgon court Susp. normale	TU3A	10/02-05/08
1.6i 16v. Susp. normale /réhaussée	TU5JP4	07/09/98-09/02
1.6i 16v. VP Susp. normale	TU5JP4	10/02-05/08
1.8 Susp. normale /réhaussée	XU7JB	07/09/98-09/02
1.8 D Susp. normale /réhaussée	XUD7	07/09/98-09/02
1.9 D Susp. normale /réhaussée	XUD9	07/09/98-09/02
1.9 D susp. normale Sans pavillon multifonction & Susp. réhaussée	DW8/B	-09/02
1.9 D VP Susp. normale Sans pavillon multifonction	DW8B	10/02-05/08
1.9 D 500 600kg VU Fourgon court Susp. normale	DW8B	10/02-05/08
TT Elec. /All models Electric 500kg VU Fourgon court	SA18	10/02-05/08

6403533

OE 364068

Rotule de susp. inf. G/D

L/R lower suspension ball joint



1
2

1.6i 16v. VP	EP6C	05/08-
1.6i 16v.	EP6C B TU5JP4/B	05/08-
1.6 HDi	DV6C/ETED M/ETED4/DTED/ M	05/08-
1.6 HDi FAP VP	DV6TED4/B	05/08-
1.6 HDi FAP VU	DV6TED4BU	05/08-
1.6 HDi VP	DV6ATED4/BTED4	05/08-
1.6 HDi VU	DV6AUTED4/BUTED4	05/08-
TT Elec. /All models Electric VU		05/08-

... Partner ...

1003562

Kit rép. triangle susp. G ou D

OE -

L or R track control arm bearing repair kit



Avec visserie *With screws and bolts* **Articulation AR Ø 19**

1.1	Susp. normale /réhaussée	TU1JP/ M+	-09/02
1.4	Susp. normale /réhaussée	TU3JP	-09/02
1.6i	16v. Susp. normale /réhaussée	TU5JP4	-09/02
1.8	Susp. normale /réhaussée	XU7JB	-09/02
1.8 D	Susp. normale /réhaussée	XUD7	-09/02
1.9 D	Susp. normale /réhaussée	XUD9	-09/02

1073562B

Kit rép. train AV complet

OE -

Front axle complete repair kit



Avec visserie *With screws and bolts* **Barre Ø 21 Art. AR Ø 19**

1.1	fourgonnette familiale Susp. normale	TU1JP	-09/02
1.1	475kg 600kg Fourgon court Susp. normale	TU1JP	-09/02
1.1	Susp. réhaussée	TU1JP	-09/02
1.1	fourgonnette familiale Susp. normale	TU1M+	-09/02
1.1	475kg 600kg Fourgon court Susp. normale	TU1M+	-09/02
1.1	Susp. réhaussée	TU1M+	-09/02
1.4	fourgonnette familiale Susp. normale	TU3JP	-09/02
1.4	475kg 600kg fourgon court Susp. normale	TU3JP	-09/02
1.4	Susp. réhaussée	TU3JP	-09/02
1.6i	16v. fourgonnette familiale Susp. normale	TU5JP4	-09/02
1.6i	16v. 475kg 600kg Fourgon court Susp. normale	TU5JP4	-09/02
1.6i	16v. Susp. réhaussée	TU5JP4	-09/02
1.8i	fourgonnette familiale Susp. normale	XU7JB	-09/02
1.8i	475kg 600kg Fourgon court Susp. normale	XU7JB	-09/02
1.8	Susp. réhaussée	XU7JB	-09/02
1.8 D	fourgonnette familiale Susp. normale	XUD7	-09/02
1.8 D	475kg 600kg Fourgon court Susp. normale	XUD7	-09/02
1.8 D	Susp. réhaussée	XUD7	-09/02
1.9 D	fourgonnette familiale Susp. normale	XUD9	-09/02
1.9 D	475kg 600kg Fourgon court Susp. normale	XUD9	-09/02
1.9 D	Susp. réhaussée	XUD9	-09/02

107A562S

Kit rép. train AV

OE -

Front axle repair kit



Sans visserie *Without screws and bolts* **Barre Ø 21 Art. AR Ø 19**

1.1	fourgonnette familiale Susp. normale	TU1JP	-09/02
1.1	475kg 600kg Fourgon court Susp. normale	TU1JP	-09/02
1.1	Susp. réhaussée	TU1JP	-09/02
1.1	fourgonnette familiale Susp. normale	TU1M+	-09/02
1.1	475kg 600kg Fourgon court Susp. normale	TU1M+	-09/02
1.1	Susp. réhaussée	TU1M+	-09/02
1.4	fourgonnette familiale Susp. normale	TU3JP	-09/02
1.4	475kg 600kg fourgon court Susp. normale	TU3JP	-09/02
1.4	Susp. réhaussée	TU3JP	-09/02
1.6i	16v. fourgonnette familiale Susp. normale	TU5JP4	-09/02
1.6i	16v. 475kg 600kg Fourgon court susp. normale	TU5JP4	-09/02
1.6i	16v. Susp. réhaussée	TU5JP4	-09/02
1.8i	fourgonnette familiale Susp. normale	XU7JB	-09/02
1.8i	475kg 600kg Fourgon court Susp. normale	XU7JB	-09/02
1.8	Susp. réhaussée	XU7JB	-09/02
1.8 D	fourgonnette familiale Susp. normale	XUD7	-09/02
1.8 D	475kg 600kg Fourgon court Susp. normale	XUD7	-09/02
1.8 D	Susp. réhaussée	XUD7	-09/02
1.9 D	fourgonnette familiale Susp. normale	XUD9	-09/02
1.9 D	475kg 600kg Fourgon court Susp. normale	XUD9	-09/02
1.9 D	Susp. réhaussée	XUD9	-09/02

... Partner ...

SASIC

PEUGEOT



Support d'amortisseur
Suspension mounting
Soporte amortiguador
Poduszka amortyzatora
Опора амортизатора

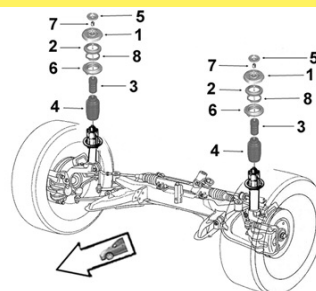

0385235

OE 503876

Support suspension G/D

L/R suspension mounting



1 Sauf 2.0 HDi Mot. DW10TD 09/09/02-

TT /all models 475kg Fourgon court	susp. normale /réhaussée	-09/02
TT /all models 600kg Fourgon court	DNA	-09/02
TT /all models 800kg Fourgon court	DNA Susp. renforcée AV AR	-09/02
TT /all models Fourgonnette familiale	DNA susp. normale	-09/02
TT /all models Fourgonnette familiale	DNA susp. réhaussée Susp. renfor. AV AR	-09/02

0385245

OE 503878

Support suspension G/D

L/R suspension mounting



1
TT /all models sauf 2.0 HDi Mot. DW10TD 09/09/02-

Plancher cabine court 765	-09/02
Véhicule tout chemin	-09/02
600kg Fourgon court DA	-09/02
800kg Fourgon court DA susp. renforcée AV AR & susp. normale	-09/02
Fourgonnette familiale DA susp. normale & susp. réhaussée Susp. renfor. AV AR	-09/02

TT /all models Pavillon multifonction Sauf 2.0 HDi Mot. DW10TD 15/10/00-09/02

1.1i	TU1JP	10/02-05/08
1.4i	TU3A/JP	10/02-05/08
1.4i GNV /essence sans plomb	TU3JP	-09/02
1.6 HDi	DV6ATED4 /BTED4	10/02-05/08
1.9 D	DW8B	10/02-05/08
2.0 HDi	DW10TD	10/02-05/08

TT Elec. /All models Electric SA18 -05/08

0385935

OE 503893

Support suspension G/D

L/R suspension mounting



1 2.0 HDi Pavillon multifonction	DW10TD	15/10/00-09/02
2.0 HDi Véhicule tout chemin	DW10TD	09/09/02-10/02
2.0 HDi 475kg Fourgon court susp. normale /réhaussée	DW10TD	09/09/02-10/02
2.0 HDi 600kg Fourgon court susp. normale réhaussée	DW10TD	09/09/02-10/02
2.0 HDi 600kg Fourgon court susp. renforcée AV AR	DW10TD	09/09/02-10/02
2.0 HDi 765kg Plancher cabine court	DW10TD	09/09/02-10/02
2.0 HDi 800kg Fourgon court susp. renforcée AV AR & susp. normale	DW10TD	09/09/02-10/02
2.0 HDi Fourgonnette familiale susp. normale & susp. réhaussée	DW10TD	09/09/02-10/02
2.0 HDi Fourgonnette familiale susp. renforcée AV AR	DW10TD	09/09/02-10/02

0385855

OE 5038G0

Support suspension G/D

L/R suspension mounting







1 1.6i 16v. VP	EP6C	05/08-
1.6i 16v. VP VU	TU5JP4/B	05/08-
1.6 HDi 90hp 66kw Tepee FAP	DV6TED4B	05/08-
1.6 HDi FAP VU	DV6TED4BU	05/08-
1.6 HDi VP	DV6ATED4/ BTED4	05/08-
1.6 HDi FAP VP	DV6TED4	05/08-
1.6 HDi VU	DV6AATED4/ BUTED4	05/08-

... Partner ...

PEUGEOT



0355275			
Butée à billes G/D			
OE 503563		<i>L/R ball bearing</i>	
	2	TT /all models	-09/02
		1.1i	TU1JP 10/02-05/08
		1.4i	TU3A/JP 10/02-05/08
		1.6i 16v. VP	EP6C /DTR TU5JP4/B 05/08-
		1.6 HDi	DV6ATED4/ BTED4 10/02-05/08
		1.6 HDi VP	DV6ATED4/ BTED4 05/08-
		1.6 HDi VU	DV6AUTED4/ BUTED4 05/08-
		1.6 HDi VP	DV6C/6DTED/ETED4 05/08-
		1.6 HDi FAP VP	DV6TED4/B 05/08-
		1.6 HDi FAP VU	DV6TED4BU 05/08-
	1.9 D	DW8B 10/02-05/08	
	2.0 HDi	DW10TD 10/02-05/08	
	TT Elec. /All models Electric	SA18 10/02-05/08	
2650035			
Coupelle amortisseur G/D			
OE 503151		<i>L/R shock absorber cup</i>	
	6	1.6i 16v. VP	EP6C 05/08-
		1.6i 16v. VP VU	EP6C DTR TU5JP4 05/08-
		1.6i VP VU	TU5JP4B 05/08-
		1.6 HDi FAP VP	DV6TED4/B 05/08-
		1.6 HDi FAP VU	DV6TED4BU 05/08-
		1.6 HDi VP	DV6ATED4/ BTED4/ C 05/08-
		1.6 HDi VU	DV6AUTED4/ BUTED4 05/08-
		1.6 HDi VP VU	DV6DTED/ M 05/08-
		1.6 HDi VP VU	DV6ETED M/D4 05/08-
0335275			
Butée de suspension G/D			
OE 503327		<i>L/R suspension bush</i>	
	3	H97	
		TT /all models 765kg Sauf plancher cabine court 765kg	-09/02
		TT /all models 800kg Sauf fourgon court susp. normale	-09/02
		TT /all models Sauf Mot. électrique SA18	-09/02
		1.1i VP Susp. renforcée AV AR	TU1JP 10/02-05/08
		1.4i VU Susp. renforcée AV AR ou réhaussée	TU3JP 10/02-05/08
		1.6i 16v. VP Susp. renforcée AV AR	TU5JP4 10/02-05/08
		1.6 HDi VP Susp. renforcée AV AR	DV6ATED4 10/02-05/08
		1.9 D VP susp. renforcée AV AR	DW8B 10/02-05/08
		1.9 D VU Susp. renforcée AV AR ou réhaussée	DW8B 10/02-05/08
	2.0 HDi VP Susp. renforcée AV AR ou réhaussée	DW10TD 10/02-05/08	
	TT Elec. /All models Electric VU	SA18 10/02-05/08	
0335405		0335515	
Butée de suspension G/D		Butée de suspension G/D	
OE 503340		OE 503351	
<i>L/R suspension bush</i>		<i>L/R suspension bush</i>	
	3	Ø 56 H 109	3
		TT /all models	4
	765kg Plancher cabine court	-09/02	TT /all models 800kg Fourgon court susp. normale
	800kg Fourgon court susp. normale	TT Elec. /All models Electric SA18	-09/02
	07/01/97-09/02		
0335595		0335655	
Butée de suspension G/D		Butée de suspension G/D	
OE 503359		OE 503365	
<i>L/R suspension bush</i>		<i>L/R suspension bush</i>	
	3	Ø 56 H 105	3
		1.1i VU TU1JP 10/02-05/08	H109
		1.4i /GNV / GPL VU Susp. normale	1.1i VP TU1JP 10/02-05/08
		TU3A 10/02-05/08	1.4i VP susp. normale
		1.4i VU TU3JP 10/02-05/08	TU3A /JP 10/02-05/08
		1.6 HDi VU DV6ATED4/ BTED4	1.6i 16v. VP Susp. normale
		10/02-05/08	TU5JP4 10/02-05/08
		1.9 D VU Susp. normale	1.6 HDi VP Susp. normale réhaussée
	DW8B 10/02-05/08	DV6ATED4/BTED4 10/02-05/08	
	2.0 HDi VU DW10TD 10/02-05/08	1.9 D VP susp. normale	
		DW8B 10/02-05/08	
		2.0 HDi VP susp. normale	
		DW10TD 10/02-05/08	

... Partner ...



Support d'amortisseur
 Suspension mounting
 Soporte amortiguador
 Poduszka amortyzatora
 Опора амортизатора

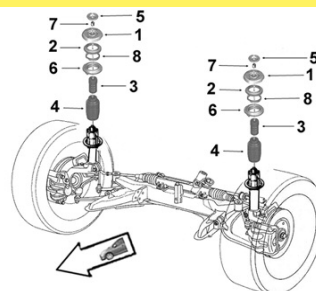

PEUGEOT

2650001

OE 503370

Butée de suspension G/D

L/R suspension bush



3 H96

1.6i 16v. VP EP6C
 1.6i 16v. VU
 1.6 HDi 90hp 66kw Tepee FAP
 1.6 HDi FAP VU
 1.6 HDi VP
 1.6 HDi FAP VP
 1.6 HDi VU

TU5JP4/B	05/08-
TU5JP4/B	05/08-
DV6TED4B	05/08-
DV6TED4BU	05/08-
DV6BTED4/ATED4	05/08-
DV6TED4	05/08-
DV6BUTED4/AUTED4	05/08-

2545135

OE 525413

Protecteur amortisseur G/D

L/R shock absorber protector



4

TT /all models -09/02

2545335

OE 525433

Protecteur amortisseur G/D

L/R shock absorber protector



4

TT Elec. /All models Electric		
	SA18	10/02-05/08
1.1i	TU1JP	10/02-05/08
1.4i	TU3A/JP	10/02-05/08
1.6 HDi	DV6ATED4/BTED4	10/02-05/08
1.9 D	DW8B	10/02-05/08
2.0 HDi	DW10TD	10/02-05/08

1005250

OE -

Kit rép. protection amort. G et D

L/R susp. mounting repair kit



Butée H 97

1.1 765kg	Sauf plancher cabine court
1.1 800kg	Sauf fourgon court susp. normale
1.4 765kg	Sauf plancher cabine court
1.4 800kg	Sauf fourgon court susp. normale
1.6i 16v. 765kg	Sauf plancher cabine court
1.6i 16v. 800kg	Sauf fourgon court susp. normale
1.8 765kg	Sauf plancher cabine court
1.8 800kg	Sauf fourgon court susp. normale
1.8 D 765kg	Sauf plancher cabine court
1.8 D 800kg	Sauf fourgon court susp. normale
1.9 D 765kg	Sauf plancher cabine court
1.9 D 800kg	Sauf fourgon court susp. normale
2.0 HDi 765kg	Sauf plancher cabine court
2.0 HDi 800kg	Sauf fourgon court susp. normale

TU1JP	TU1M+	-09/02
TU1JP	TU1M+	-09/02
TU3JP		-09/02
TU3JP		-09/02
TU5JP4		-09/02
TU5JP4		-09/02
XU7JB		-09/02
XU7JB		-09/02
XUD7		-09/02
XUD7		-09/02
DW8/B	XUD9	-09/02
DW8/B	XUD9	-09/02
DW10TD		-09/02
DW10TD		-09/02

1005251

OE -

Kit rép. protection amort. G et D

L/R susp. mounting repair kit



Butée H 109

1.1i 765kg	Plancher cabine court
1.1i 800kg	Fourgon court susp. normale
1.4 765kg	Plancher cabine court
1.4 800kg	Fourgon court susp. normale
1.6i 16v. 765kg	Plancher cabine court
1.6i 16v. 800kg	Fourgon court susp. normale
1.8i 765kg	Plancher cabine court
1.8i 800kg	Fourgon court susp. normale
1.8 D 765kg	Plancher cabine court
1.8 D 800kg	Fourgon court susp. normale
1.9 D 765kg	Plancher cabine court
1.9 D 800kg	Fourgon court susp. normale
2.0 HDi 765kg	Plancher cabine court
2.0 HDi 800kg	Fourgon court susp. normale
TT Elec. /All models Electric 765kg	Plancher cabine court
TT Elec. /All models Electric 800kg	Fourgon court susp. normale

TU1JP	TU1M+	-09/02
TU1JP	TU1M+	07/01/97-09/02
TU3JP		-09/02
TU3JP		07/01/97-09/02
TU5JP4		-09/02
TU5JP4		07/01/97-09/02
XU7JB		-09/02
XU7JB		07/01/97-09/02
XUD7		-09/02
XUD7		07/01/97-09/02
DW8/B	XUD9	-09/02
DW8/B	XUD9	07/01/97-09/02
DW10TD		-09/02
DW10TD		07/01/97-09/02
SA18		-09/02
SA18		07/01/97-09/02

... Partner ...

PEUGEOT



1005270

Kit rép. suspension

OE -

Susp. mounting repair kit



sauf 2.0 HDi Mot. DW10TD 09/09/02-

TT /all models Plancher cabine court 765 & Véhicule tout chemin	-09/02
TT /all models 600kg Fourgon court DA	-09/02
TT /all models 800kg Fourgon court DA susp. renforcée AV AR & susp. normale	-09/02
TT /all models Fourgonnette familiale DA susp. normale & susp. réhaussée Susp. renfor. AV AR	-09/02

TT /all models Pavillon multifonction Sauf 2.0 HDi Mot. DW10TD	15/10/00-09/02
TT Elec. /All models Electric SA18	-05/08

1.1i	TU1JP	10/02-05/08
1.4i	TU3A/ JP	10/02-05/08
1.4i GNV /essence sans plomb	TU3JP	-09/02
1.6 HDi	DV6ATED4/ BTED4	10/02-05/08
1.9 D	DW8B	10/02-05/08
2.0 HDi	DW10TD	10/02-05/08

1005269

Kit rép. suspension G ou D

OE -

L/R stabilizing bar repair kit



sauf 2.0 HDi Mot. DW10TD 09/09/02-

TT /all models		
475kg Fourgon court susp. normale /réhaussée		-09/02
600kg Fourgon court DNA		-09/02
800kg Fourgon court DNA Susp. renforcée AV AR		-09/02
Fourgonnette familiale DNA susp. normale & susp. réhaussée Susp. renfor. AV AR		-09/02



Support d'amortisseur

Suspension mounting
Soporte amortiguador
Poduszka amortyzatora
Опора амортизатора

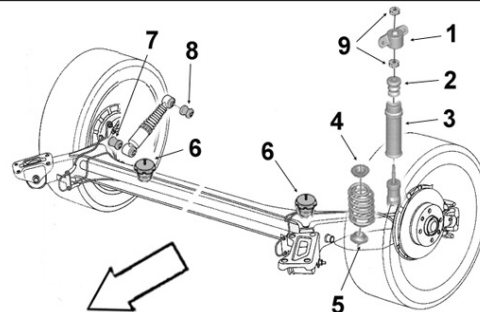

1715125

Articulation amort. sup.

OE 517112

Upper shock absorber bush



8 Ø int.16 Ø ext.33 coll.37 x2 long. tube int.45 ext.21 ep. coll.4x2		
TT /all models		-09/02
1.1i	TU1JP	10/02-05/08
1.4i	TU3JP	10/02-05/08
1.4i /GNV / GPL	TU3A	10/02-05/08
1.6i 16v.	TU5JP4	10/02-05/08
1.6 HDi	DV6ATED4/ BTED4	10/02-05/08
1.9 D	DW8B	10/02-05/08
2.0 HDi	DW10TD	10/02-05/08
TT Elec. /All models Electric	SA18	10/02-05/08

1715115

Articulation amort. inf.

OE 517111

Lower shock absorber bush



7 Ø int.16 Ø ext.34 coll.37 x2 long. tube int.45 ext.21 ep. coll.4x2		
TT /all models		-09/02
1.1i	TU1JP	10/02-05/08
1.4i	TU3JP	10/02-05/08
1.4i /GNV / GPL	TU3A	10/02-05/08
1.6i 16v.	TU5JP4	10/02-05/08
1.6 HDi	DV6ATED4/ BTED4	10/02-05/08
1.9 D	DW8B	10/02-05/08
2.0 HDi	DW10TD	10/02-05/08
TT Elec. /All models Electric	SA18	10/02-05/08

... Partner ...

SASIC

PEUGEOT



Support d'amortisseur
Suspension mounting
Soporte amortiguador
Poduszka amortyzatora
Опора амортизатора

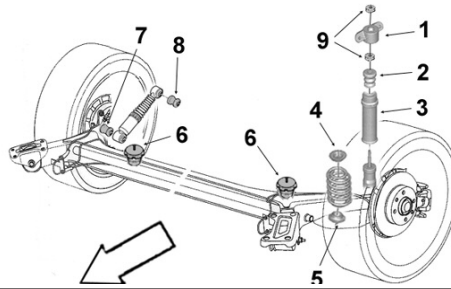

1665635

OE 516663

Butée de talonnage

Bushing



6

Ø 55 H82

TT /all models			-09/02
1.1i VP		TU1JP	10/02-07/09/03
1.4i VP		TU3JP	10/02-07/09/03
1.4i VU Susp. normale / renforcée AV AR ou réhaussée		TU3A/ JP	10/02-07/09/03
1.6i 16v. VP		TU5JP4	10/02-05/08
1.6i 16v. VU Susp. normale / renforcée AV AR /normale réhaussée		TU5JP4	10/02-07/09/03
1.6 HDi VU Susp. normale / renforcée AV AR ou réhaussée		DV6ATED4	10/02-07/09/03
1.6 HDi VU Susp. normale/ renforcée AV AR ou réhaussée		DV6BTED4	10/02-07/09/03
1.9 D VP		DW8B	10/02-07/09/03
1.9 D VU Susp. normale & Susp. renforcée AV AR ou réhaussée		DW8B	10/02-07/09/03
2.0 HDi VP		DW10TD	10/02-07/09/03
2.0 HDi VU Susp. normale & Susp. renforcée AV AR ou réhaussée		DW10TD	10/02-07/09/03
TT Elec. /All models Electric 500kg VU Fourgon court		SA18	10/02-07/09/03

2001025

Part/oe 516673

Butée de talonnage

Bushing



6

Ø 55 H93

1.1i VP	Sauf 1000kg	TU1JP	08/09/03-05/08
1.4i VP	Sauf 1000kg	TU3JP/A	08/09/03-05/08
1.6i 16v. VP	Sauf 1000kg	TU5JP4	08/09/03-05/08
1.6 HDi VP	Sauf 1000kg	DV6ATED4	08/09/03-05/08
1.6 HDi VP	Sauf 1000kg	DV6BTED4	08/09/03-05/08
1.9 D VP	Sauf 1000kg	DW8B	08/09/03-05/08
2.0 HDi VP	Sauf 1000kg	DW10TD	08/09/03-05/08
TT Elec. /All models Electric 500kg VU Fourgon court		SA18	08/09/03-05/08

2001026

Part/oe 516672

Butée de talonnage

Bushing



6

Ø 55 H74

1.1i VU	Susp. renforcée AV AR /normale réhaussée	TU1JP	08/09/03-05/08
1.1i VU	Susp. normale	TU1JP	08/09/03-05/08
1.4i /GNV/ GPL	Susp. renforcée AV AR ou réhaussée	TU3A	08/09/03-05/08
1.4i VU	Susp. normale	TU3A	08/09/03-05/08
1.4i VU	Susp. renforcée AV AR ou réhaussée	TU3JP	08/09/03-05/08
1.4i VU	Susp. normale	TU3JP	08/09/03-05/08
1.6i 16v.	Susp. renforcée AV AR /normale réhaussée	TU5JP4	08/09/03-05/08
1.6i 16v. VU	Susp. normale	TU5JP4	08/09/03-05/08
1.6 HDi VU	Susp. renforcée AV AR ou réhaussée	DV6ATED4	08/09/03-05/08
1.6 HDi VU	Susp. normale	DV6ATED4	08/09/03-05/08
1.6 HDi VU	Susp. renforcée AV AR ou réhaussée	DV6BTED4	08/09/03-05/08
1.6 HDi VU	Susp. normale	DV6BTED4	08/09/03-05/08
1.9 D	Susp. renforcée AV AR ou réhaussée	DW8B	08/09/03-05/08
1.9 D VU	Susp. normale	DW8B	08/09/03-05/08
2.0 HDi	Susp. renforcée AV AR ou réhaussée	DW10TD	08/09/03-05/08
2.0 HDi VU	Susp. normale	DW10TD	08/09/03-05/08

... Partner ...

Eléments TRAIN ARRIERE

Rear axle parts

Tren TRAS

Elementy zawieszenia tylnego

элементы задней оси.



PEUGEOT



1315475

OE 513147

Articulation AV Bras

Arm front bush



Ø int.12.2 Ø ext. 46.9 coll. 54.5 long. tube int.27.5 ext.17 ep. coll.10

TT /all models 475kg 600kg Fourgon court & 765kg Plancher cabine court		-09/02
TT /all models Fourgon court sauf susp. renforcée AV AR & Fourgonnette familiale		-09/02
TT Elec. /All models Electric	SA18	-09/02
1.1i 500 600kg Fourgon court Susp. normale	TU1JP	10/02-05/08
1.1i 800kg Fourgon court Susp. normale	TU1JP	10/02-05/08
1.1i plancher cabine court type 8 Susp. normale	TU1JP	10/02-05/08
1.4i 500 600kg Fourgon court Susp. normale	TU3A/JP	10/02-05/08
1.4i 800kg Fourgon court Susp. normale	TU3A/JP	10/02-05/08
1.4i 800kg Sauf plancher cabine court type 8 / fourgon court susp. renforcée AV et AR ou réhaussée	TU3A/JP	10/02-05/08
1.4i plancher cabine court type 8 Susp. normale	TU3A/JP	10/02-05/08
1.6i 16v. 500 600kg fourgon court Susp. normale	TU5JP4	10/02-05/08
1.6i 16v. 800kg fourgon court Susp. normale	TU5JP4	10/02-05/08
1.6i 16v. plancher cabine court type 8 Susp. normale	TU5JP4	10/02-05/08
1.6i 16v. Sauf plancher cabine court type 8 / fourgon court 800 / fourgon tôle long H1 type 12 susp. renforcée AV AR ou réhaussée	TU5JP4	10/02-05/08
1.6 HDi 500 600kg Fourgon court Susp. normale	DV6ATED4/BTED4	10/02-05/08
1.6 HDi 800kg Fourgon court Susp. normale	DV6ATED4/BTED4	10/02-05/08
1.6 HDi plancher cabine court type 8 Susp. normale	DV6ATED4/BTED4	10/02-05/08
1.6 HDi Sauf fourgon tôle long H1 type 12 susp. renforcée AV AR ou réhaussée	DV6ATED4/BTED4	10/02-05/08
1.9 D 500 600kg Fourgon court Susp. normale	DW8B	10/02-05/08
1.9 D 800kg Fourgon court susp. normale	DW8B	10/02-05/08
1.9 D plancher cabine court type 8 Susp. normale	DW8B	10/02-05/08
1.9 D Sauf plancher cabine court type 8 / fourgon court 800 / fourgon tôle long H1 type 12 susp. renf. AV AR ou réhaussée	DW8B	10/02-05/08
2.0 HDi 500 600kg Fourgon court Susp. normale	DW10TD	10/02-05/08
2.0 HDi 800kg Fourgon court susp. normale	DW10TD	10/02-05/08
2.0 HDi plancher cabine court type 8 Susp. normale	DW10TD	10/02-05/08
2.0 HDi Sauf plancher cabine court type 8 / fourgon court 800 susp. renforcée AV AR ou réhaussée	DW10TD	10/02-05/08
TT Elec. /All models		
Electric 500kg Fourgon court 1 500 600kg Fourgon court Susp. normale	SA18	10/02-05/08
Electric 800kg Fourgon court Susp. normale	SA18	10/02-05/08
Electric plancher cabine court type 8 Susp. normale	SA18	10/02-05/08

1315985

OE 513198

Articulation AV Bras

Arm front bush



Ø int.12 Ø ext.53 coll.66 long. tube int.57 ext.48,5 ep. coll.12

TT /all models Véhicule tout chemin & 800kg Fourgon court susp. renforcée AV AR		-09/02
1.1i susp. renforcée AV AR ou réhaussée	TU1JP	10/02-05/08
1.4i 800kg Plancher cabine court type 8 / fourgon court susp. renforcée AV AR ou réhaussée	TU3A/JP	10/02-05/08
1.6i 16v. 800kg Plancher cabine court type 8 / fourgon court susp. renforcée AV AR ou réhaussée	TU5JP4	10/02-05/08
1.6 HDi 800kg Plancher cabine court type 8 / fourgon court susp. renforcée AV AR ou réhaussée	DV6BTED4	10/02-05/08
1.6 HDi Plancher cabine court type 8 / fourgon court 800 susp. renforcée AV AR ou réhaussée	DV6ATED4	10/02-05/08
1.9 D 800kg Plancher cabine court type 8 / fourgon court susp. renforcée AV AR ou réhaussée	DW8B	10/02-05/08
2.0 HDi Plancher cabine court type 8 / fourgon court 800 susp. renforcée AV AR ou réhaussée	DW10TD	10/02-05/08

... Partner ...



Eléments TRAIN ARRIERE

Rear axle parts

Tren TRAS

Elementy zawieszenia tylnego

элементы задней оси.



PEUGEOT

1525625

OE 515262

Support train AR

Rear axle mounting



TT /all models

-09/02

1.1i

TU1JP

10/02-05/08

1.4i

TU3A / JP

10/02-05/08

1.6i 16v.

TU5JP4

10/02-05/08

1.6 HDi

DV6ATED4/BTED4

10/02-05/08

1.9 D

DW8B

10/02-05/08

2.0 HDi

DW10TD

10/02-05/08

TT Elec. /All models Electric

SA18

10/02-05/08

2600004

OE 5131F2

Articulation essieu

Axle bush



Ø int. 14 Ø ext. 80 coll. 87 long. tube int. 79 ext. 59 ep. coll.7

1.6i 16v. Tepee VP Susp. normale Haute moyenne
Sans assise supplémentaire

EP6C TU5JP4/B

05/08-04/04/10

1.6i 16v. Tepee VP Susp. normale Moyenne basse
Sans assise supplémentaire

EP6C TU5JP4/B

05/08-04/04/10

1.6i 16v. Tepee VP Susp. normale Sup. basse plus
Sans assise supplémentaire

EP6C TU5JP4/B

05/08-04/04/10

1.6 HDi Tepee VP Susp. normale Haute moyenne
Sans assise supplémentaire

DV6ATED4/BTED4

DV6TED4B/TED4

05/08-04/04/10

1.6 HDi Tepee VP Susp. normale Moyenne basse
Sans assise supplémentaire

DV6ATED4/BTED4

DV6TED4B/TED4

05/08-04/04/10

1.6 HDi Tepee VP Susp. normale Sup. basse plus
Sans assise supplémentaire

DV6ATED4/BTED4

DV6TED4B/TED4

05/08-04/04/10

1.6 HDi Tepee VP Susp. normale
Sauf basse moyenne

DV6DTED M

DV6ETED M

06/10/08-

2600007

OE 5131H1

Articulation essieu

Axle bush



Ø int. 14 Ø ext. 82 coll. 90 long. tube int.79 ext.54 ep. Coll.7

1.6i 16v. VP Susp. renforcée AV AR

EP6C TU5JP4/B

05/08-04/04/10

1.6i 16v. VP Susp. normale Basse basse/moyenne sans assise supplémentaire

EP6C TU5JP4/B

05/08-04/04/10

1.6i 16v. VP Susp. normale 2 sièges séparés supplémentaires

EP6C TU5JP4/B

05/08-04/04/10

1.6i 16v. VP

EP6C TU5JP4/B

05/04/10-

1.6i 16v. VU

TU5JP4/B

05/08-

1.6i 16v. VU

EP6C DTR

05/08-

1.6i 16v. VP

EP6C DTR

06/10/08-

1.6 HDi 90hp 66kw VU

DV6ETED M

05/08-

1.6 HDi FAP VP Susp. renforcée AV AR

DV6TED4

05/08-04/04/10

1.6 HDi FAP VP Susp. normale Basse basse

DV6TED4

05/08-04/04/10

/moyenne sans assise supplémentaire

...

... Partner



... 2600007

Articulation essieu

OE 5131H1

Axle bush

Ø int. 14 Ø ext. 82 coll. 90 long. tube int.79 ext.54 ep. Coll.7



1.6 HDi FAP VP Susp. normale 2 sièges séparés supplémentaires	DV6TED4	05/08-04/04/10
1.6 HDi FAP VP	DV6TED4/B	05/04/10-
1.6 HDi FAP VP Susp. renforcée AV AR	DV6TED4B	05/08-04/04/10
1.6 HDi FAP VP Susp. normale Basse basse /moyenne sans assise supplémentaire	DV6TED4B	05/08-04/04/10
1.6 HDi FAP VP Susp. normale 2 sièges séparés supplémentaires	DV6TED4B	05/08-04/04/10
1.6 HDi FAP VU	DV6TED4BU	05/08-
1.6 HDi VP Susp. renforcée AV AR	DV6ATED4	05/08-04/04/10
1.6 HDi VP Susp. normale Basse basse /moyenne sans assise supplémentaire	DV6ATED4	05/08-04/04/10
1.6 HDi VP Susp. normale 2 sièges séparés supplémentaires	DV6ATED4	05/08-04/04/10
1.6 HDi VP	DV6ATED4	05/04/10-
1.6 HDi VP Susp. renforcée AV AR	DV6BTED4	05/08-04/04/10
1.6 HDi VP Susp. normale Basse basse /moyenne sans assise supplémentaire	DV6BTED4	05/08-04/04/10
1.6 HDi VP Susp. normale 2 sièges séparés supplémentaires	DV6BTED4	05/08-04/04/10
1.6 HDi VP	DV6BTED4	05/04/10-
1.6 HDi VP	DV6C	06/10/08-
1.6 HDi VP Susp. renforcée AV AR	DV6DTED M/ETED M	06/10/08-
1.6 HDi VP Susp. normale Basse moyenne	DV6ETED M/DTED M	06/10/08-
1.6 HDi VP	DV6DTED/ETED4	06/10/08-
1.6 HDi VU	DV6AUTED4/BUTED4	05/08-
1.6 HDi VU	DV6DTED/M/ETED4	05/08-

1005127

Kit rép. train AR G ou D

OE -

L/R rear axle repair kit



1.1	TU1JP/ M+	-09/02
1.4	TU3JP	-09/02
1.6i 16v.	TU5JP4	-09/02
1.8	XU7JB	-09/02
1.8 D	XUD7	-09/02
1.9 D	DW8/B XUD9	-09/02
2.0 HDi	DW10TD	-09/02
TT Elec. /All models Electric	SA18	-09/02

R4 ...

Eléments DIRECTION
Steering parts
Elementos Direcciones
Elementy układ kierowniczy
Элементы рулевой системы

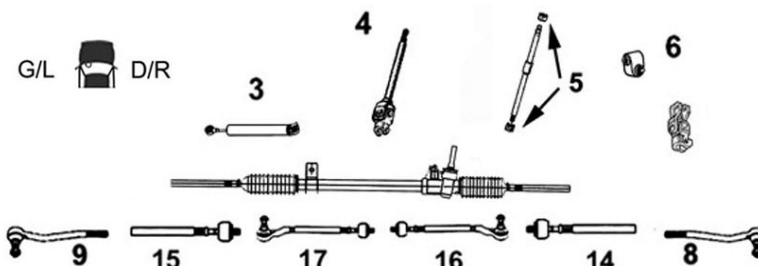

8123963

Axe de bielle G/D

OE -

L/R axial joint



14
15

Côté dir. M12x1.0 Côté rot. M14x1.5
long 176 mm

TT /all models VP/ VU F4 F6 01/79-

4006111

Rotule de direction G/D

OE 7701460955

L/R tie rod end



8
9

TT /all models VP/ VU F4 F6
Dir. 4006002

4001469

Noix cardan de direction

OE 7704001919

U joint



6

TT /all models



Barre stabilisatrice

Stabilizer bar
Barra estabilizadora
Drażek stabilizatora
стабилизатор поперечной устойчивости

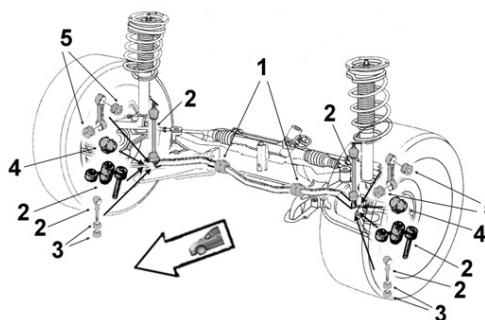

4001304

Support barre stab.

OE 7700500113

Stabilizer bar mounting



TT /all models 01/62-

4001555

Palier de barre

OE 0608268700

Bar main bearing



1

Barre Ø 16

TT /all models

... R4 ...



Eléments SUSPENSION
Suspension parts
Elementos suspensión
Elementy zawieszenie
Элементы подвески

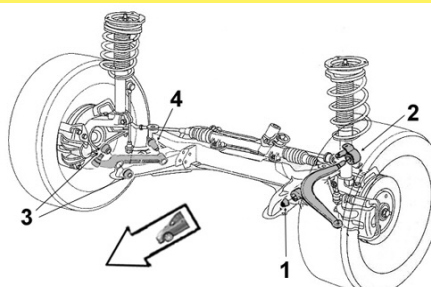

RENAULT



... R4

Bras & Triangle de suspension

Control arm
Brazo y triángulo
Wahacz
Рычаг подвески

G/L  D/R



405A402S

OE -



Kit rép. train AV G ou D

L/R front axle repair kit

Sans visserie Without screws and bolts
Barre Ø 16

TT /all models VP/ VU F4 F6

4005400

OE -



Kit rép. triangle susp. G ou D

L or R track control arm bearing repair kit

Avec visserie With screws and bolts

TT /all models VP/ VU F4 F6

Eléments TRAIN ARRIERE

Rear axle parts

Tren TRAS

Elementy zawieszenia tylnego

элементы задней оси.



4003394

OE 7700626057



Articulation

Bush

Ø int.27 Ø ext.45 long. tube int.65 ext.27

TT /all models

4003399J

OE 0855599000



Jeu de 2 articulations

Set of 2 bushes

Ø int. 34 Ø ext. 50 long. tube int.45 ext.39.5

TT /all models

4003397

OE 7700531796



Art. support pont

Axle mounting bush

Ø int. 37.5 Ø ext. 55 long. tube int. 59 ext.28

TT /all models

4005338

OE -



Kit rép. train AR G ou D

L/R rear axle repair kit

TT /all models VP/ VU F4 F6

R5 ...

Eléments DIRECTION

Steering parts

Elementos Direcciones

Elementy układ kierowniczy

Элементы рулевой системы

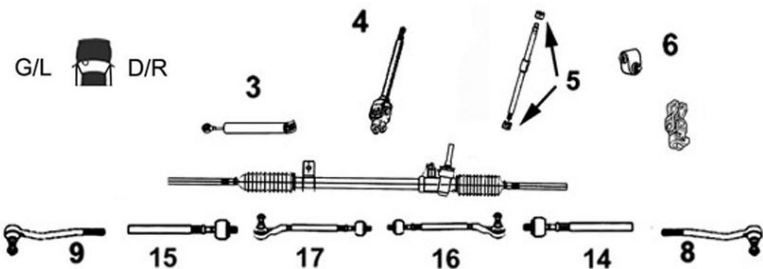

8123963

Axe de bielle G/D

OE -

L/R axial joint



14 Côté dir. M12x1.0 Côté rot. M14x1.5
15 long 176 mm

TT /all models 01/79-

4006111

Rotule de direction G/D

OE 7701460955

L/R tie rod end



8
9

TT /all models Dir. 4006005

4006138

Douille à aiguilles colonne

OE 7703090293

Needle bearing



5

TT /all models

4001469

Noix cardan de direction

OE 7704001919

U joint



6

TT /all models



Eléments SUSPENSION

Suspension parts

Elementos suspensión

Elementy zawieszenie

Элементы подвески

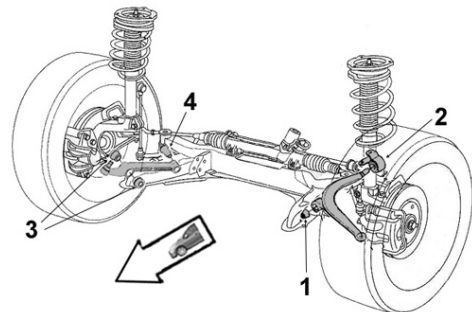

4001484

Articulation sup.

OE 7701348037

Upper bush



4

Ø int.12 Ø ext.26 long. tube int.36.2 ext.23

TT /all models

4001415

Articulation inf.

OE 7701348454

Lower bush



1
2

Ø int.14 Ø ext.27 long. tube int.45 ext.40

TT /all models

4001416

Articulation inf.

OE 7701349773

Lower bush



1
2

Alvéolé alveolate Ø int.14 Ø ext.34 long. tube int.45 ext.40

TT /all models

... R5

Bras & Triangle de suspension

Control arm
Brazo y triángulo
Wahacz
Рычаг подвески

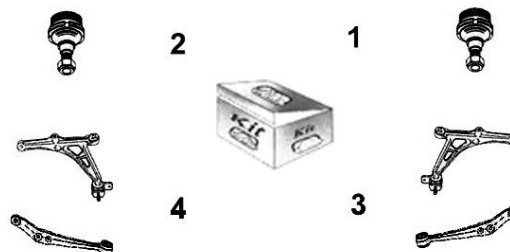
G/L  D/R**4005252****Rotule de susp. sup. G/D**

OE 7701451904

L/R upper susp. ball joint1
2

TT /all models 01/69-

4005250**Rotule de susp. inf. G**

OE 7701463686

Left lower suspension ball joint

2

TT /all models 01/69-

4005251**Rotule de susp. inf. D**

OE 7701463687

Right lower suspension ball joint

1

TT /all models 01/69-

405A401S**Kit rép. train AV**

OE -

Front axle repair kit**Sans visserie** *Without screws and bolts*TT /all models Sauf 122B
(Alpine turbo)**4005401****Kit rép. triangle susp. G ou D**

OE -

L or R track control arm bearing repair kit**Avec visserie** *With screws and bolts*TT /all models Sauf 122B
(Alpine turbo)**Eléments TRAIN ARRIERE***Rear axle parts**Tren TRAS**Elementy zawieszenia tylnego**элементы задней оси.***4003399J****Jeu de 2 articulations**

OE 0855599000

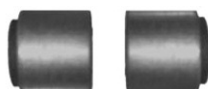
Set of 2 bushes

Ø int. 34 Ø ext. 50 long. tube int.45 ext.39.5

TT /all models

Super 5 ...

Eléments DIRECTION
Steering parts
Elementos Direcciones
Elementy układ kierowniczy
Элементы рулевой системы

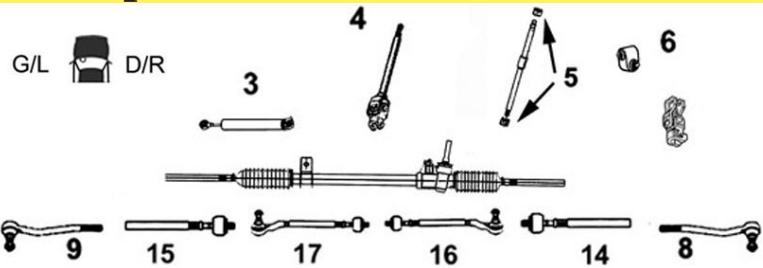

RENAULT



... Super 5 ...

SASIC

RENAULT



Barre stabilisatrice
 Stabilizer bar
 Barra estabilizadora
 Drażek stabilizatora
 стабилизатор поперечной устойчивости

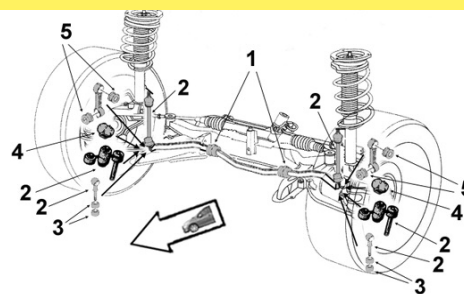

<p>4001445 OE 7700798052</p>	<p>Palier de barre milieu <i>Middle bar main bearing</i></p> <p>1 Barre Ø 21</p> <p>TT /all models Sauf diesel</p>	<p>4001472 OE 7700763934</p>	<p>Palier de barre milieu <i>Middle bar main bearing</i></p> <p>1 Barre Ø 22 H 29</p> <p>TT /all models</p>
<p>4001446 OE 7702144561</p>	<p>Palier de barre milieu <i>Middle bar main bearing</i></p> <p>1 Barre Ø 22 H 39</p> <p>TT /all models</p>	<p>4001539 OE 7700798053</p>	<p>Palier de barre milieu <i>Middle bar main bearing</i></p> <p>1 Barre Ø 22 H 45</p> <p>TT /all models</p>
<p>4005073 OE -</p>	<p>Kit rép. barre stab. G et D <i>L R Stabilizing bar repair kit</i></p> <p>Barre Ø 22 H 29</p> <p>TT /all models</p>	<p>4005077 OE -</p>	<p>Kit rép. barre stab. G et D <i>L R Stabilizing bar repair kit</i></p> <p>Barre Ø 22 H 39</p> <p>TT /all models</p>



Eléments SUSPENSION
 Suspension parts
 Elementos suspensión
 Elementy zawieszenie
 Элементы подвески

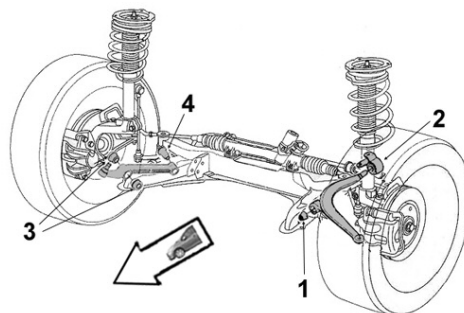















<p>4001406 OE 7700762574</p>	<p>Articulation AV <i>Front bush</i></p> <p>1 Ø int.12 Ø ext.32 long. tube int.46 ext.35</p> <p>TT /all models Sauf C405 C409</p>	<p>4001417 OE 7704000681</p>	<p>Articulation AR <i>Rear bush</i></p> <p>2 Ø int.12 Ø ext.32 long. tube int.46 ext.35</p> <p>TT /all models Sauf C405 C409</p>
---	---	---	--

... Super 5 ...

RENAULT

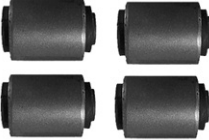

4001433		Articulation AV/AR	
OE 6001006724		Front rear bush	
	1	Ø int.12 Ø ext.32 long. tube int.46 ext.35	
	2	1.4 GT Turbo	C405
		1.7	C409
<p>Bras & Triangle de suspension</p> <p>Control arm Brazo y triángulo Wahacz Рычаг подвески</p> <p style="text-align: center;">G/L  D/R</p> <div style="display: flex; justify-content: space-around; align-items: center;"> <div style="text-align: center;">  2 </div> <div style="text-align: center;">  4 </div> <div style="text-align: center;">  3 </div> <div style="text-align: center;">  1 </div> <div style="text-align: center;">  3 </div> </div>			
4003352 OE 7700783463		Triangle de susp. G Left track control arm	
	4	Avec rotule With ball joint	
		TT /all models	
4003354 OE 7700783464		Triangle de susp. D Right track control arm	
	3	Avec rotule With ball joint	
		TT /all models	
4005257 OE 7701472038		Rotule de susp. inf. G/D L/R lower suspension ball joint	
	1	Trous fixation Ø10	
	2	TT /all models	
4005409 OE -		Kit rép. triangle susp. G ou D L or R track control arm bearing repair kit	
	Avec visserie With screws and bolts		
	TT /all models		
405A409S OE -		Kit rép. train AV Front axle repair kit	
	Sans visserie Barre Ø 21 Without screws and bolts		
	TT /all models		
406A409S OE -		Kit rép. train AV Front axle repair kit	
	Sans visserie Barre Ø 22 palier H39 Without screws and bolts		
	TT /all models		
407A409S OE -		Kit rép. train AV Front axle repair kit	
	Sans visserie Barre Ø 22 palier H45 Without screws and bolts		
	TT /all models		
4005424S OE -		Kit rép. triangle susp. G et D L or R Track control arm bearing repair kit	
	Sans visserie Without screws and bolts		
	TT /all models		

... Super 5





SASIC

RENAULT

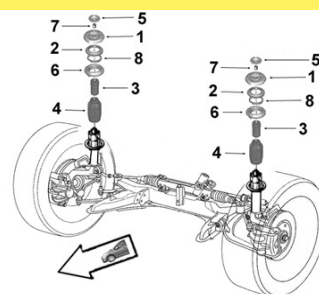



Support d'amortisseur
 Suspension mounting
 Soporte amortiguador
 Poduszka amortyzatora
 Опора амортизатора



4001603 OE 7700757324 	Tampon suspension G/D L/R susp. rebound stop 1 TT /all models	4005301 OE 7700777654 	Butée à billes G/D L/R ball bearing 2 TT /all models
4005371 OE 7700757323 	Butée protecteur susp. G/D L/R suspension bush 3 4 TT /all models	4005220 OE - 	Kit rép. suspension G ou D L/R stabilizing bar repair kit TT /all models

Eléments TRAIN ARRIERE
 Rear axle parts
 Tren TRAS
 Elementy zawieszenia tylnego
 элементы задней оси.



4001414 OE 7700807180 	Articulation AR Rear bush Ø int.34.5 Ø ext.40 coll.72 long. tube int.75.5 ext.27.5 TT /all models
4001428 OE 7704003844 	Articulation AR Rear bush Ø int.43 Ø ext.72.5 long. tube int.28 ext.28 TT /all models

R6 ...

Eléments DIRECTION
Steering parts
Elementos Direcciones
Elementy układ kierowniczy
Элементы рулевой системы

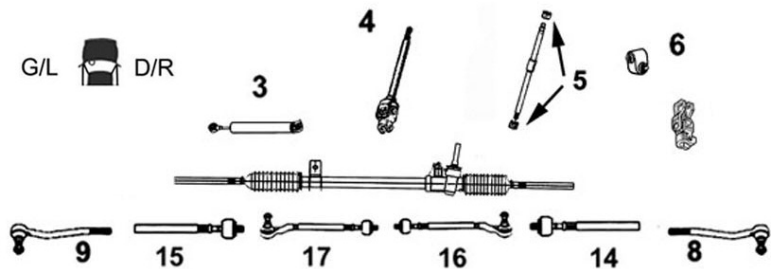

8123963

Axe de bielle G/D

OE -

L/R axial joint



14 Côté dir. M12x1.0 Côté rot. M14x1.5
 15 long 176 mm

0.8 R1180 01/79-

4006111

Rotule de direction G/D

OE 7701460955

L/R tie rod end



8
9

TT /all models Dir. 4006002

4001469

Noix cardan de direction

OE 7704001919

U joint



6

TT /all models



Barre stabilisatrice

Stabilizer bar
Barra estabilizadora
Drażek stabilizatora
стабилизатор поперечной устойчивости

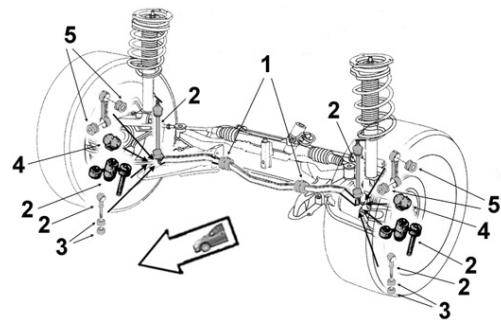

4001304

Support barre stab.

OE 7700500113

Stabilizer bar mounting



TT /all models 01/62-

... R6 ...



Eléments SUSPENSION
Suspension parts
Elementos suspensión
Elementy zawieszenie
Элементы подвески

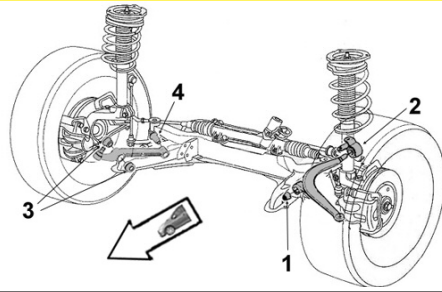

RENAULT



4001402

Articulation sup.

OE 7700518856

Upper bush



4 Ø int.12 Ø ext.26 long. tube int.27 ext.23

TT /all models

4001484

Articulation sup.

OE 7701348037

Upper bush



4 Ø int.12 Ø ext.26 long. tube int.36.2 ext.23

TT /all models

4001415

Articulation inf.

OE 7701348454

Lower bush



1
2 Ø int.14 Ø ext.27 long. tube int.45 ext.40

TT /all models

Bras & Triangle de suspension

Control arm
Brazo y triángulo
Wahacz
Рычаг подвески

G/L D/R



4005252

Rotule de susp. sup. G/D

OE 7701451904

L/R upper susp. ball joint



1
2

TT /all models

4005250

Rotule de susp. inf. G

OE 7701463686

Left lower suspension ball joint



2

TT /all models

4005251

Rotule de susp. inf. D

OE 7701463687

Right lower suspension ball joint



1

TT /all models

405A400S

Kit rép. train AV

OE -

Front axle repair kit



Sans visserie *Without screws and bolts*

TT /all models

... R6

4005400

Kit rép. triangle susp. G ou D

OE -

L or R track control arm bearing repair kit



Avec visserie With screws and bolts

TT /all models

Eléments TRAIN ARRIERE

Rear axle parts

Tren TRAS

Elementy zawieszenia tylnego

элементы задней оси.

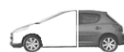

4003399J

Jeu de 2 articulations

OE 0855599000

Set of 2 bushes

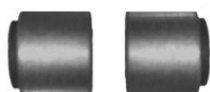

Ø int. 34 Ø ext. 50 long. tube int.45 ext.39.5

TT /all models

R9 R11 ...

Eléments DIRECTION

Steering parts

Elementos Direcciones

Elementy uklad kierowniczy

Элементы рулевой системы

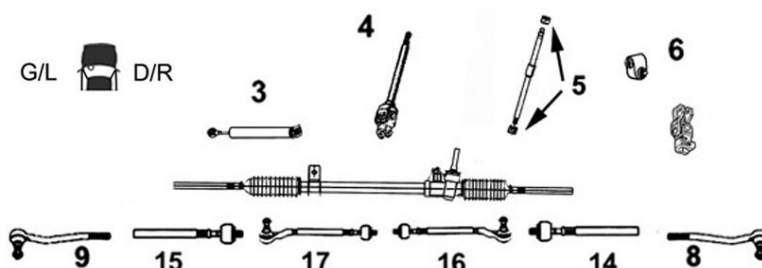

3008041

Axe de bielle G/D

OE -

L/R axial joint



14 Côté dir. M12x1.0 Côté rot. M14x1.5
15 long 280 mm

TT /all models

4006112

Rotule de direction G/D

OE 7701469231

L/R tie rod end



8
9 M14 x 1.5

TT /all models

4006138

Douille à aiguilles colonne

OE 7703090293

Needle bearing



5

TT /all models

4001460

Noix cardan de direction

OE 7700687433

U joint



6

TT /all models

... R9 R11 ...

SASIC

RENAULT



Barre stabilisatrice
 Stabilizer bar
 Barra estabilizadora
 Drażek stabilizatora
 стабилизатор поперечной устойчивости

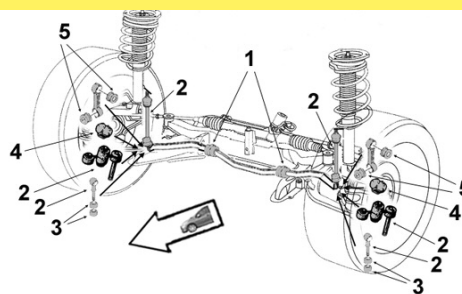

<p>4001515 OE 7700693154</p>	<p>Palier de barre bout <i>End bar main bearing</i></p> <p>4 Barre Ø 23</p> <p>TT /all models</p>	<p>4001495 OE 7700760264</p>	<p>Palier de barre bout <i>End bar main bearing</i></p> <p>4 Barre Ø 23</p> <p>TT /all models</p>
<p>4001516 OE 7700706135</p>	<p>Palier de barre bout <i>End bar main bearing</i></p> <p>4 Barre Ø 24</p> <p>TT /all models</p>	<p>4001496 OE 7700760263</p>	<p>Palier de barre bout <i>End bar main bearing</i></p> <p>4 Barre Ø 24</p> <p>TT /all models</p>
<p>4001473 OE 7700789815</p>	<p>Palier de barre milieu <i>Middle bar main bearing</i></p> <p>1 Barre Ø 23</p> <p>TT /all models</p>	<p>4001447 OE 7700789816</p>	<p>Palier de barre milieu <i>Middle bar main bearing</i></p> <p>1 Barre Ø 24</p> <p>TT /all models</p>



Eléments SUSPENSION
 Suspension parts
 Elementos suspensión
 Elementy zawieszenie
 Элементы подвески

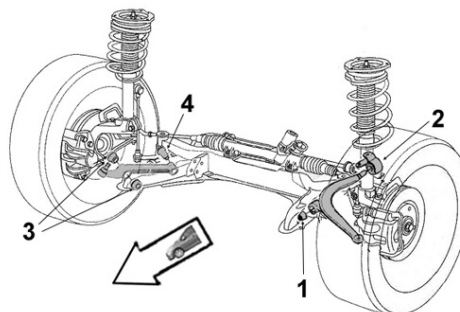

<p>4001417 OE 7704000681</p>	<p>Articulation AV <i>Front bush</i></p> <p>1 Ø int.12 Ø ext.32 long. tube int.46 ext.35</p> <p>TT /all models</p>	<p>4001417 OE 7704000681</p>	<p>Articulation AR <i>Rear bush</i></p> <p>2 Ø int.12 Ø ext.32 long. tube int.46 ext.35</p> <p>TT /all models sauf L424 C374 S374</p>
---	--	---	---

... R9 R11 ...

RENAULT



4001406

Articulation AR

OE 7700762574

Rear bush



2 Ø int.12 Ø ext.32 long. tube int.46 ext.35

1.6 D L424 C374 S374

Bras & Triangle de suspension

Control arm
Brazo y triángulo
Wahacz
Рычаг подвески

G/L D/R



4003362

Triangle de susp. G

OE 7700783449

Left track control arm



4 Avec rotule With ball joint

TT /all models

4003361

Triangle de susp. D

OE 7700783450

Right track control arm



3 Avec rotule With ball joint

TT /all models

4005257

Rotule de susp. inf. G/D

OE 7701472038

L/R lower suspension ball joint



1
2 Trous fixation Ø10

TT /all models

4005424S

Kit rép. triangle susp. G et D

OE -

L or R Track control arm bearing repair kit



Sans visserie Without screws and bolts

TT /all models

4005409

Kit rép. triangle susp. G ou D

OE -

L or R track control arm bearing repair kit



Avec visserie With screws and bolts

TT /all models

... R9 R11

SASIC

RENAULT



Support d'amortisseur
Suspension mounting
Soporte amortiguador
Poduszka amortyzatora
Опора амортизатора

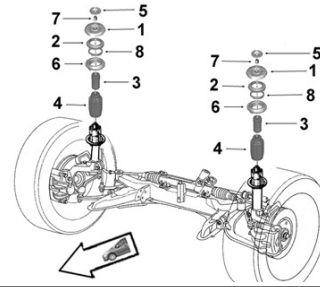

4001329

OE 7700760571

Support suspension G/D

L/R suspension mounting



1

TT /all models

4005301

OE 7700777654

Butée à billes G/D

L/R ball bearing



2

TT /all models

Eléments TRAIN ARRIERE

Rear axle parts

Tren TRAS

Elementy zawieszenia tylnego

элементы задней оси.



4001414

OE 7700807180

Articulation AR

Rear bush



Ø int.34.5 Ø ext.40 coll.72 long. tube int.75.5 ext.27.5

TT /all models

4001428

OE 7704003844

Articulation AR

Rear bush



Ø int.43 Ø ext.72.5 long. tube int.28 ext.28

TT /all models

4005350B

OE -

Kit rép. train AR G ou D

L/R rear axle repair kit



TT /all models R9 Train à tube
 TT /all models R11 2 ptes Comm. Train à tube

R12 ...

Eléments DIRECTION

Steering parts

Elementos Direcciones

Elementy układ kierowniczy

Элементы рулевой системы

G/L  D/R

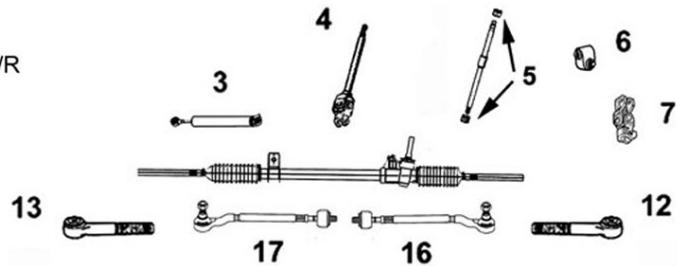

4001469

Noix cardan de direction

OE 7704001919

U joint



6

TT /all models

4006107

Oeil de crémaillère G/D

OE 7700504987

L/R steering gear eye



12
13

M12 x 1

TT /all models



Barre stabilisatrice

Stabilizer bar

Barra estabilizadora

Drażek stabilizatora

стабилизатор поперечной устойчивости

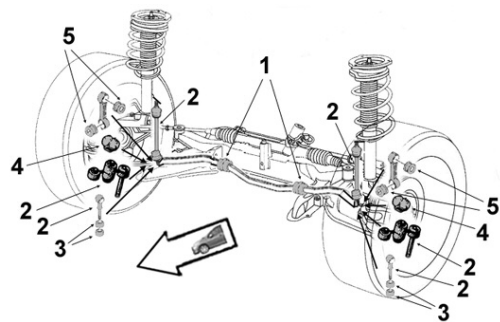

4005120

Biellette barre stab.

OE 7701453465

Stabilizer bar stub axle



2

TT /all models

4001452

Articulation barre stab.

OE 7700547187

Stabilizer bar bush



3

Ø int.14.5 Ø ext.33.5 coll.39
long. tube int.14 ext.7 ep. coll.5

TT /all models



Eléments SUSPENSION

Suspension parts

Elementos suspensión

Elementy zawieszenie

Элементы подвески

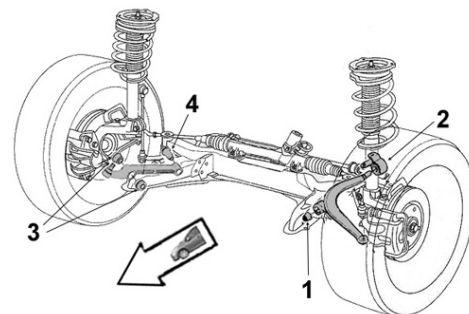

4001429

Articulation sup.

OE 7705040000

Upper bush



4

Ø int.14 Ø ext.27 long. tube int.51 ext.43.5

TT /all models 2ème montage

4001424

Articulation inf.

OE 7704001601

Lower bush



1
2

Ø int.14 Ø ext.32 long. tube int.46 ext.38

TT /all models 2ème montage

... R12

Bras & Triangle de suspension

Control arm
Brazo y triángulo
Wahacz
Рычаг подвески

G/L  D/R**4005254****Rotule de susp. sup. G/D**

OE 7701468820

L/R upper susp. ball joint1
2

TT /all models

4005256**Rotule de susp. inf. G/D**

OE 7701468821

L/R lower suspension ball joint1
2

TT /all models

405A404S**Kit rép. train AV**

OE -

Front axle repair kit

Sans visserie *Without screws and bolts*
Barre Ø 16

TT /all models

R14 ...

Eléments DIRECTION

Steering parts
Elementos Direcciones
Elementy układ kierowniczy
Элементы рулевой системы

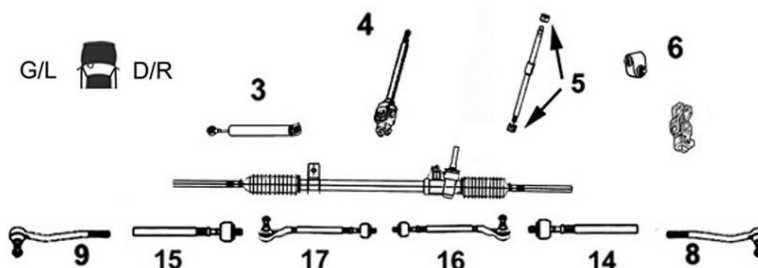
G/L  D/R**3008153****Axe de bielle G/D**

OE -

L/R axial joint

14 Côté dir. M12x1.0 Côté rot. M14x1.5
15 long 262 mm

TT /all models 01/80-12/83

4006042B1**Bielle de direction G/D**

OE 7701461140

L/R steering rod

16 M14 x 1.5
17

TT /all models 01/80-12/83

4006112**Rotule de direction G/D**

OE 7701469231

L/R tie rod end

8
9 M14 x 1.5

TT /all models 01/80-12/83

... R14

Bras & Triangle de suspension

Control arm
Brazo y triángulo
Wahacz
Рычаг подвески

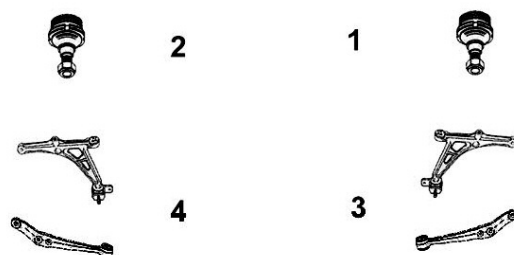

5203343 Bras de suspension G
OE 7700586241 Left track control arm

4 Avec rotule With ball joint



TT /all models

5213233 Bras de suspension D
OE 7700586466 Right track control arm

3 Avec rotule With ball joint



TT /all models

R18 ...

Eléments DIRECTION

Steering parts
Elementos Direcciones
Elementy układ kierowniczy
Элементы рулевой системы

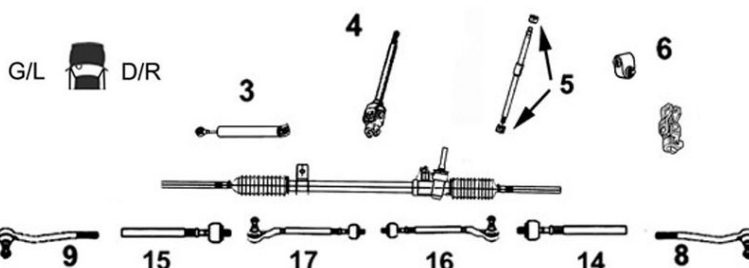

3008044 Axe de bielle G/D
OE - L/R axial joint



14 Côté dir. M12x1.0 Côté rot. M14x1.5 long 220 mm
15

1.4	R1340	Ch- 534401		
1.4 Break	R1350	Ch- 114801	R2350	Ch- 1201
1.6	R1341	Ch- 504401	R1342	
1.6 Break	R1351	Ch- 107201	R1352	
1.6 Turbo /Break	R1345 R1355			
2.0 /Break	R1343 R1353			
2.1 D /Break	R1344 R1354			
2.1 TD /Break	R1346 R1356			

4006044B1 Bielle de direction G/D
OE 7701463025 L/R steering rod



16 M14 x 1.5
17

1.4	R1340	Ch- 534401		
1.4 Break	R1350	Ch- 114801	R2350	Ch- 1201
1.6	R1341	Ch- 504401	R1342	
1.6 Break	R1351	Ch- 107201	R1352	
1.6 Turbo /Break	R1345 R1355			
2.0 /Break	R1343 R1353			
2.1 D /Break	R1344 R1354			
2.1 TD /Break	R1346 R1356			

4006111 Rotule de direction G/D
OE 7701460955 L/R tie rod end



8
9

1.4	R1340	-ch 534400		
1.4 Break	R1350	-ch 114800	R2350	-ch 1200
1.6	R1341	-ch 504400		
1.6 Break	R1351	-ch 107200		

... R18 ...

Eléments DIRECTION
Steering parts
Elementos Direcciones
Elementy układ kierowniczy
Элементы рулевой системы

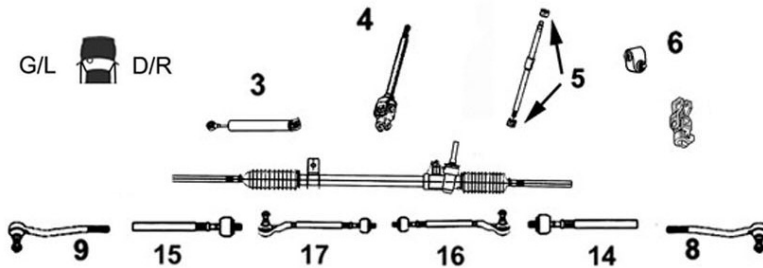

4006112 Rotule de direction G/D

OE 7701469231 *L/R tie rod end*



8	M14x1.5				
9	1.4	R1340	Ch- 534401		
	1.4 Break	R1350	Ch- 114801	R2350	Ch- 1201
	1.6	R1341	Ch- 504401	R1342	
	1.6 Break	R1351	Ch- 107201	R1352	
	1.6 Turbo /Break	R1345 R1355			
	2.0 /Break	R1343 R1353			
	2.1 D /Break	R1344 R1354			
	2.1 TD /Break	R1346 R1356			

4006138 Douille à aiguilles colonne

OE 7703090293 *Needle bearing*



5	1.4	R1340	
	1.4 Break	R1350 R2350	
	1.6	R1341 R1342	
	1.6 Break	R1351 R1352	
	1.6 Turbo /Break	R1345 R1355	
	2.0 /Break	R1343 R1353	
	2.1 D /Break	R1344 R1354	
	2.1 TD /Break	R1346 R1356	

4001469 Noix cardan de direction

OE 7704001919 *U joint*



6	1.4	R1340
	1.6	R1341/2
	1.6 Turbo	R1345
	2.0	R1343
	2.1 D	R1344
	2.1 TD	R1346



Barre stabilisatrice
Stabilizer bar
Barra estabilizadora
Drażek stabilizatora
стабилизатор поперечной устойчивости

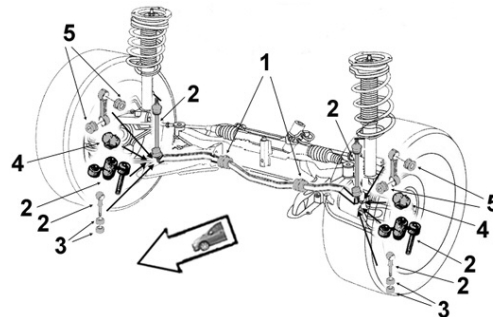

4001485 Bielle barre stab.

OE 7700710718 *Stabilizer bar stub axle*



2	Ø int.17		
	TT /all models	R1340/41/42/45	
	TT /all models	R1343/44/46	01/83-

4005120 Bielle barre stab.

OE 7701453465 *Stabilizer bar stub axle*



2			
	TT /all models	R1340/41/42/45	

... R18





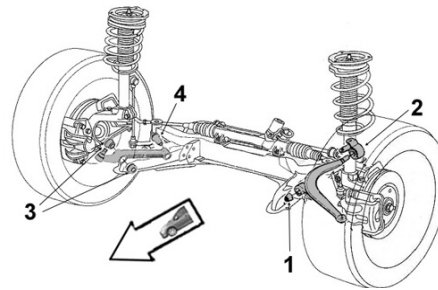

Eléments SUSPENSION
Suspension parts
Elementos suspensión
Elementy zawieszenie
Элементы подвески





RENAULT





<p>4001429 OE 7705040000</p> 	<p>Articulation sup. <i>Upper bush</i></p> <p>4 Ø int.14 Ø ext.27 long. tube int.51 ext.43.5</p> <p>TT /all models 1er montage R1340/41/42/43/44/45/46</p>	<p>4001430 OE 7705040002</p> 	<p>Articulation sup. <i>Upper bush</i></p> <p>4 Ø int.14 Ø ext.31 long. tube int.50.7 ext.39</p> <p>TT /all models 2ème montage R1340/41/42/43/44/45/46</p>
<p>4001424 OE 7704001601</p> 	<p>Articulation inf. <i>Lower bush</i></p> <p>1 2 Ø int.14 Ø ext.32 long. tube int.46 ext.38</p> <p>TT /all models 1er montage R1340/41/42/43/44/45/346</p>	<p>4001420 OE 7704001281</p> 	<p>Articulation inf. <i>Lower bush</i></p> <p>1 2 Ø int.14 Ø ext.36 long. tube int.52.8 ext.39</p> <p>TT /all models 2ème montage R1340/41/42/43/44/45/46</p>





Bras & Triangle de suspension
Control arm
Brazo y triángulo
Wahacz
Рычаг подвески

G/L  D/R

2

4

3

1

3

<p>4005254 OE 7701468820</p> 	<p>Rotule de susp. sup. G/D <i>L/R upper susp. ball joint</i></p> <p>1 2</p> <table border="0"> <tr><td>1.4</td><td>R1340</td><td>-12/82</td></tr> <tr><td>1.4 Break</td><td>R1350</td><td>-12/82</td></tr> <tr><td>1.4 Break</td><td>R2350</td><td>-12/82</td></tr> <tr><td>1.6</td><td>R1341</td><td>-12/82</td></tr> <tr><td>1.6 Break</td><td>R1351</td><td>-12/82</td></tr> </table>	1.4	R1340	-12/82	1.4 Break	R1350	-12/82	1.4 Break	R2350	-12/82	1.6	R1341	-12/82	1.6 Break	R1351	-12/82	<p>4005258 OE 7701461332</p> 	<p>Rotule de susp. sup. G/D <i>L/R upper susp. ball joint</i></p> <p>1 1.4 R1340 01/83- 2 1.4 Break R1350/2350 01/83- 1.6 R1341 01/83- 1.6 R1342 1.6 Break R1351 01/83- 1.6 Break R1352 1.6 Turbo /Break R1345/55 2.0 /Break R1343/53 2.1 D /Break R1344/54 2.1 TD /Break R1346/56</p>
1.4	R1340	-12/82																
1.4 Break	R1350	-12/82																
1.4 Break	R2350	-12/82																
1.6	R1341	-12/82																
1.6 Break	R1351	-12/82																
<p>4005256 OE 7701468821</p> 	<p>Rotule de susp. inf. G/D <i>L/R lower suspension ball joint</i></p> <p>1 2</p> <table border="0"> <tr><td>1.4</td><td>R1340</td><td>-12/82</td></tr> <tr><td>1.4 Break</td><td>R1350</td><td>-12/82</td></tr> <tr><td>1.4 Break</td><td>R2350</td><td>-12/82</td></tr> <tr><td>1.6</td><td>R1341</td><td>-12/82</td></tr> <tr><td>1.6 Break</td><td>R1351</td><td>-12/82</td></tr> </table>	1.4	R1340	-12/82	1.4 Break	R1350	-12/82	1.4 Break	R2350	-12/82	1.6	R1341	-12/82	1.6 Break	R1351	-12/82	<p>4005259 OE 7701461331</p> 	<p>Rotule de susp. inf. G/D <i>L/R lower suspension ball joint</i></p> <p>1 1.4 R1340 01/83- 2 1.4 Break R1350/2350 01/83- 1.6 R1341 01/83- 1.6 R1342 1.6 Break R1351 01/83- 1.6 Break R1352 1.6 Turbo /Break R1345/55 2.0 /Break R1343/53 2.1 D /Break R1344/54 2.1 TD /Break R1346/56</p>
1.4	R1340	-12/82																
1.4 Break	R1350	-12/82																
1.4 Break	R2350	-12/82																
1.6	R1341	-12/82																
1.6 Break	R1351	-12/82																

... R18

Bras & Triangle de suspension

Control arm
Brazo y triángulo
Wahacz
Рычаг подвески

G/L  D/R



405A419S

Kit rép. train AV

OE -

Front axle repair kit

Sans visserie Without screws and bolts



1.4	R1340	01/83-
1.4 Break	R1350	01/83-
1.4 Break	R1359 R2350	
1.6	R1341R1342	01/83-
1.6 Break	R1351	01/83-
1.6 Break	R1352	
2.1 D /Break	R1344 R1354	

R19 ...

Éléments DIRECTION

Steering parts
Elementos Direcciones
Elementy układ kierowniczy
Элементы рулевой системы

G/L  D/R

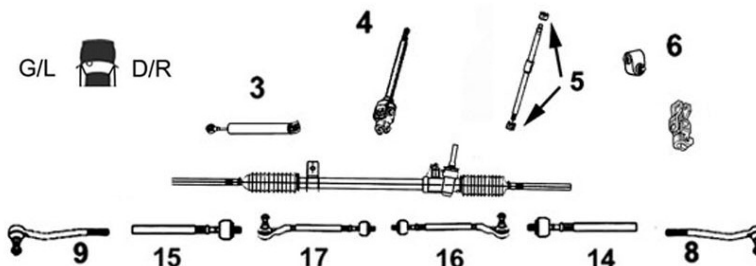

3008153

Axe de bielle G/D

OE -

L/R axial joint



14 Côté dir. M12x1.0 Côté rot. M14x1.5
15 long 262 mm

TT /all models
Sauf B/C/L539 B/C/D/L53D 853C

3008045

Axe de bielle G/D

OE 6000022815

L/R axial joint



14 Côté dir. M12x1.0 Côté rot. M14x1.5
15 long 272 mm

1.8 RSi 853C
1.8i 16v. B/C/D/L 53D
1.8i 16v. B/C/L539

4006240

Bielle de direction G

OE 7701467235

Left steering rod



17

TT /all models
Sauf B/C/L539 B/C/D/L53D 853C

4006241

Bielle de direction D

OE 7701467237

Right steering rod



16

TT /all models
Sauf B/C/L539 B/C/D/L53D 853C

4006114

Rotule de direction G

OE 6000030047

Left tie rod end



9

TT /all models

4006115

Rotule de direction D

OE 6000030048

Right tie rod end



8

TT /all models

... R19 ...



Barre stabilisatrice
 Stabilizer bar
 Barra estabilizadora
 Drażek stabilizatora
 стабилизатор поперечной устойчивости

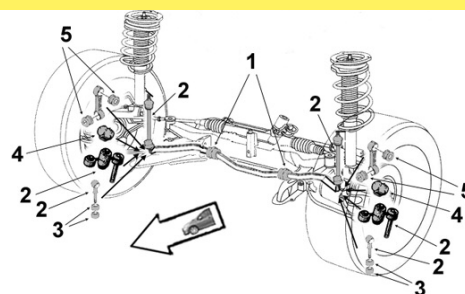

RENAULT



4001475 **Palier de barre bout**
 OE 7700784170 *End bar main bearing*



4 Barre Ø 23

 TT /all models Essence

 1.9 D
 1.9 TD

4001476 **Palier de barre milieu**
 OE 7700785788 *Middle bar main bearing*



1 Barre Ø 23

 TT /all models Essence

 1.9 D
 1.9 TD

4155410 **Kit rép. barre stab. G et D**
 OE - *L R Stabilizing bar repair kit*

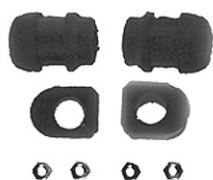

Barre Ø 23

 TT /all models



Eléments SUSPENSION
 Suspension parts
 Elementos suspensión
 Elementy zawieszenie
 Элементы подвески

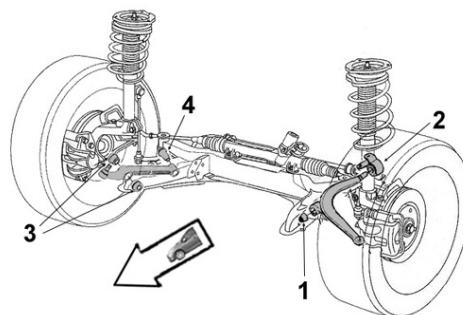

4001413 **Articulation AV/AR**
 OE 7700840741 *Front rear bush*



1
2 Ø int.12 Ø ext.45 long. tube int.46 ext.34.5
 TT /all models Essence Sauf B/C/D/L 53D 539 et 853C

 1.9 D
 1.9 TD

4001529 **Articulation AV/AR**
 OE 8200651169 *Front rear bush*



1
2 Ø int.12 Ø ext.45 long. tube int.46 ext.35

 1.8i B/C/D/L 853C
 1.8i 16v. B/C/D/L 53D
 1.8i 16v. B/C/D/L 539

... R19 ...

SASIC

RENAULT

Bras & Triangle de suspension

Control arm
Brazo y triángulo
Wahacz
Рычаг подвески

G/L  D/R



... R19 ...





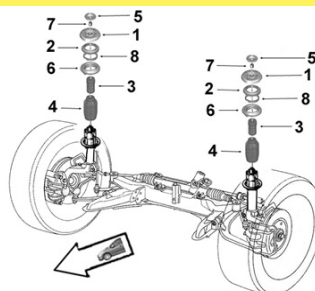



Support d'amortisseur
 Suspension mounting
 Soporte amortiguador
 Poduszka amortyzatora
 Опора амортизатора



RENAULT



4001604 OE 7700835254	Support suspension G/D <i>L/R suspension mounting</i>	4005301 OE 7700777654	Butée à billes G/D <i>L/R ball bearing</i>
	1 TT /all models Essence sauf 16v. 1.9 D 1.9 TD		2 1.4 B53A/G/H B/C532 L531/532/537/53A 1.7 B533/536 B53F L533/53F 1.8i 553H B/C 539/53D L539/53D/53Y 1.9 D 1.9 TD
4001609 OE 7704000661	Butée de suspension G/D <i>L/R suspension bush</i>	4005372 OE 7700776743	Protecteur amortisseur G/D <i>L/R shock absorber protector</i>
	3 TT /all models Essence sauf B53G B53H B533 B536 553H 1.9 D 1.9 TD		4 TT /all models Essence 1.9 D 1.9 TD
4005210 Kit rép. protection amort. G et D OE - <i>L/R susp. mounting repair kit</i>			
	1.4 B53G B53H 1.7 B533 B536 1.8 553H		
4005223 Kit rép. suspension G ou D OE - <i>L/R stabilizing bar repair kit</i>			
	(4001604+4005301) 1.4 B53G B53H 1.7 B533 B536		
4005223 Kit rép. suspension G ou D OE - <i>L/R stabilizing bar repair kit</i>			
	(4001604+4005301) 1.8 553H 1.9 D 1.9 TD		

... R19

Eléments TRAIN ARRIERE

Rear axle parts

Tren TRAS

Elementy zawieszenia tylnego

элементы задней оси.



4003398

Articulation AR

OE 7700776733

Rear bush

Ø int.43 Ø ext.77 long. tube int.36 ext.36

Train à tube

TT /all models Essence

1.9 D

1.9 TD



4005350B

Kit rép. train AR G ou D

OE -

L/R rear axle repair kit



TT /all models Train à tube

... R20

Eléments DIRECTION

Steering parts

Elementos Direcciones

Elementy układ kierowniczy

Элементы рулевой системы

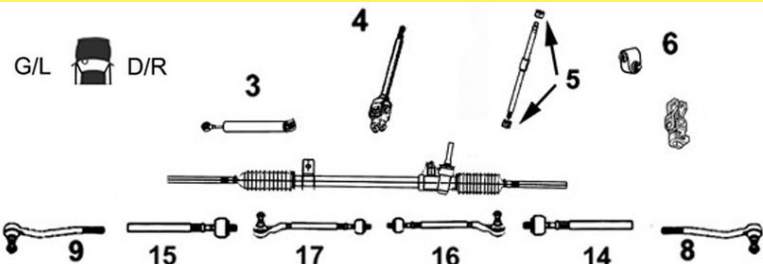

3008044

Axe de bielle G/D

OE -

L/R axial joint

14 Côté dir. M12x1.0 Côté rot. M14x1.5
15 long 220 mm

1.6 R1271 Ch- 187001 843

2.0 R1277 829

2.1 D R1276

2.1 TD R1270 J8S702



4006044B1

Bielle de direction G/D

OE 7701463025

L/R steering rod

16 M14 x 1.5
17

1.6 R1271 Ch- 187001 843

2.0 R1277 829

2.1 D R1276

2.1 TD R1270 J8S702



4006111

Rotule de direction G/D

OE 7701460955

L/R tie rod end

8
9
1.6 R1271 Ch 160601-187000 843



4006112

Rotule de direction G/D

OE 7701469231

L/R tie rod end

8
9
M14 x 1.5

1.6 R1271 Ch- 187001 843

2.0 R1277 829

2.1 D R1276

2.1 TD R1270 J8S702



4006138

Douille à aiguilles colonne

OE 7703090293

Needle bearing

5
1.6 R1271 843
2.0 R1277 829
2.1 D R1276
2.1 TD R1270 J8S702
2.2 R1279 851



4001469

Noix cardan de direction

OE 7704001919

U joint

6
TT /all models



... R20

Bras & Triangle de suspension

Control arm
Brazo y triángulo
Wahacz
Рычаг подвески

G/L  D/R

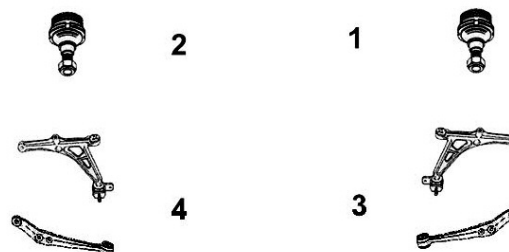

4005258

Rotule de susp. sup. G/D

OE 7701461332

L/R upper susp. ball joint



1
2

1.6 R1271 Ch- 187001 843
2.0 R1277 829
2.1 D R1276
2.1 TD R1270 J8S702

4005256

Rotule de susp. inf. G/D

OE 7701468821

L/R lower suspension ball joint



1
2

1.6 R1271 Ch 1-ch 187000 843

4005259

Rotule de susp. inf. G/D

OE 7701461331

L/R lower suspension ball joint



1
2

1.6 R1271 Ch- 187001 843
2.0 R1277 829
2.1 D R1276
2.1 TD R1270 J8S702

R21 ...

Eléments DIRECTION

Steering parts
Elementos Direcciones
Elementy układ kierowniczy
Элементы рулевой системы

G/L  D/R

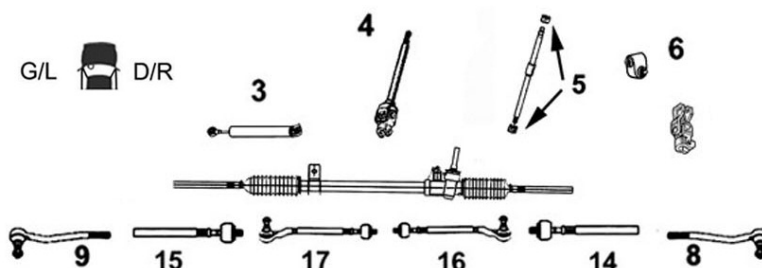

3008045

Axe de bielle G/D

OE 6000022815

L/R axial joint



14 Côté dir. M12x1.0 Côté rot. M14x1.5
15 long 272 mm

Mot. transversal

TT /all models
Sauf B48H B48I L48H L48I

4006045B1

Bielle de direction G/D

OE 7701466236

L/R steering rod



16
17

Mot. transversal

TT /all models
sauf B/L48H B/L48I DNA

TT /all models DA

4006113

Rotule de direction G/D

OE 7701469230

L/R tie rod end

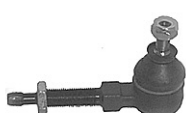

8
9

Mot. longitudinal

TT /all models
Sauf L48L L485

4006112

Rotule de direction G/D

OE 7701469231

L/R tie rod end



8
9

M14 x 1.5

Mot. transversal

TT /all models





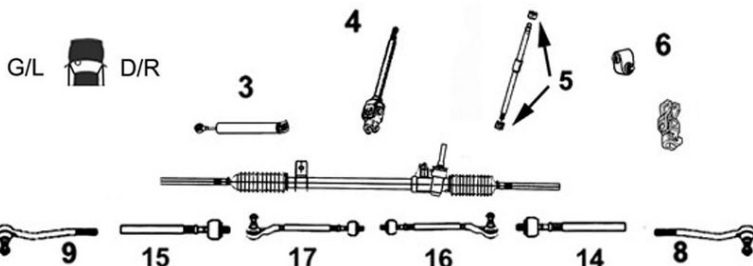



... R21 ...

Eléments DIRECTION
 Steering parts
 Elementos Direcciones
 Elementy układ kierowniczy
 Элементы рулевой системы

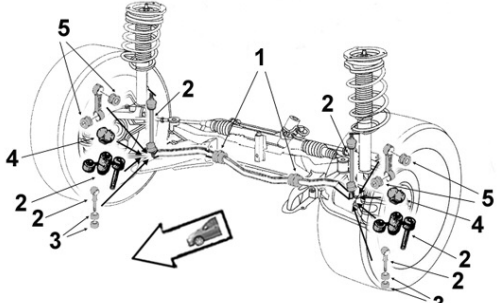

RENAULT











SASIC

<p>4004000 OE 7700765658</p> 	<p>Axe de volant <i>Steering wheel shaft</i></p> <p>4</p> <p>TT /all models Mot. longitudinal</p>	<p>4004001 OE 7700759787</p> 	<p>Axe de volant <i>Steering wheel shaft</i></p> <p>4</p> <p>TT /all models DNA Mot. transversal -09/90</p>
<p>4004002 OE 7700763621</p> 	<p>Axe de volant <i>Steering wheel shaft</i></p> <p>4</p> <p>TT /all models DA Mot. transversal - 09/90</p>	<p>4006138 OE 7703090293</p> 	<p>Douille à aiguilles colonne <i>Needle bearing</i></p> <p>5</p> <p>TT /all models Mot. longitudinal & transversal</p>
<p></p> <p>Barre stabilisatrice <i>Stabilizer bar</i> <i>Barra estabilizadora</i> <i>Drażek stabilizatora</i> стабилизатор поперечной устойчивости</p>			
<p>4001478 OE 7700789412</p> 	<p>Palier de barre bout <i>End bar main bearing</i></p> <p>4 Barre Ø 16</p> <p>TT /all models Moteur transversal B L</p>	<p>4001477 OE 7700762130</p> 	<p>Palier de barre bout <i>End bar main bearing</i></p> <p>4 Barre Ø 25</p> <p>TT /all models Moteur transversal B L</p>
<p>4001482 OE 7700817328</p> 	<p>Palier de barre bout <i>End bar main bearing</i></p> <p>4 Barre Ø 20</p> <p>TT /all models Moteur longitudinal</p>	<p>4001480 OE 7700771562</p> 	<p>Palier de barre bout <i>End bar main bearing</i></p> <p>4 Barre Ø 23</p> <p>TT /all models Moteur longitudinal</p>

... R21 ...

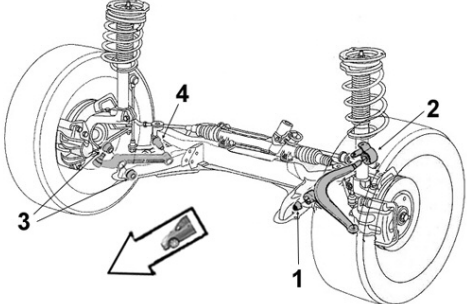
RENAULT



4001479 OE 7700773245	Palier de barre milieu <i>Middle bar main bearing</i>	4001500 OE 7700769226	Palier de barre milieu <i>Middle bar main bearing</i>
	1 Barre Ø 25 TT /all models Moteur transversal B L		1 Barre Ø 24 TT /all models Moteur longitudinal
4001483 OE 7700774026	Palier de barre milieu <i>Middle bar main bearing</i>	4155411 OE -	Kit rép. barre stab. G et D <i>L / R Stabilizing bar repair kit</i>
	1 Barre Ø 24 TT /all models Moteur longitudinal		Barre Ø 25.4 bout Ø 21 L palier milieu 69 TT /all models Mot. longitudinal
4175411 OE -	Kit rép. barre stab. G et D <i>L / R Stabilizing bar repair kit</i>		
	Barre Ø 25.4 bout Ø 23 L palier milieu 69 TT /all models Moteur longitudinal		
<div style="display: flex; justify-content: space-between;"> <div data-bbox="234 1227 350 1273">  </div> <div data-bbox="234 1296 531 1468"> <p>Eléments SUSPENSION <i>Suspension parts</i> <i>Elementos suspensión</i> <i>Elementy zawieszenie</i> <i>Элементы подвески</i></p> </div> <div data-bbox="921 1189 1384 1492">  </div> </div>			
4001405 OE 7700754515	Articulation AV <i>Front bush</i>	4001549 OE 7700785937	Articulation AV <i>Front bush</i>
	1 Ø int.12 Ø ext.36 long. tube int.51 ext.39 Moteur longitudinal 2.0i L48C/Q/R/S L483/9 2.0i 2WD L48Y 2.0i Turbo L48L 2.0i Turbo L485 -04/89 2.1 D B/L48V L480/6 2.2 2WD L48K		1 Ø int.12 Ø ext.36 long. tube int.51 ext.40 Moteur longitudinal 2.0i 4WD L48Y 2.0i Turbo L48L 2.0i Turbo L485 -05/89 2.1 TD L48A/P/7/8
4001417 OE 7704000681	Articulation AV/AR <i>Front rear bush</i>	4001409 OE 7700777276	Articulation AR <i>Rear bush</i>
	1 2 Ø int.12 Ø ext.32 long. tube int.46 ext.35 Moteur transversal TT /all models B K L 1.7 B481 L481		2 Ø int.12 Ø ext.36 coll.46.5 long. tube int.48.5 ext.37 ep. coll.6 Moteur longitudinal 2.0i L48C/Q/R/S/3/9 2.0i 2WD L48Y 2.0i Turbo L48L 2.0i Turbo L485 -04/89 2.2 2WD L48K

... R21 ...



Eléments SUSPENSION
Suspension parts
Elementos suspensión
Elementy zawieszenie
Элементы подвески

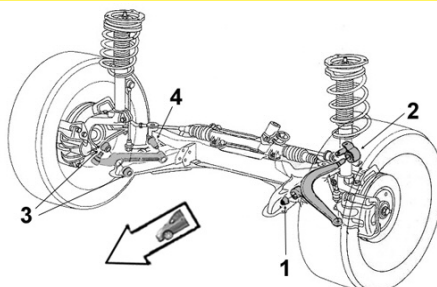

RENAULT

SASIC

4001487

Articulation AR

OE 7700772687

Rear bush



2 Ø int.12 Ø ext.37 long. tube int.48.5 ext.37

Moteur longitudinal

2.0i	B48Y/3	
2.1 D	B48V	
2.1 D	B486	J8S704
2.1 TD	B488	
2.2i	B48K	

4001547

Articulation AR

OE 7700805329

Rear bush



2 Ø int. 12 Ø ext.36 coll.46
 long. tube int.48.5 ext.37 ep. coll.3

Moteur longitudinal

2.0i 4WD	L48Y	
2.0i Turbo	L48L	
2.0i Turbo	L485	-05/89
2.1 TD	L48A/P/7/8	

Bras & Triangle de suspension

Control arm
Brazo y triángulo
Wahacz
Рычаг подвески

G/L D/R



4003365

Triangle de susp. G

OE 7701641726

Left track control arm



4 Acier steel Avec rotule With ball joint

TT /all models Mot. longitudinal

4003364

Triangle de susp. D

OE 7701641727

Right track control arm



3 Acier steel Avec rotule With ball joint

TT /all models Mot. longitudinal

4003362

Triangle de susp. G

OE 7700783449

Left track control arm



4 Avec rotule With ball joint

TT /all models Mot. transversal

4003361

Triangle de susp. D

OE 7700783450

Right track control arm



3 Avec rotule With ball joint

TT /all models Mot. transversal

4005261

Rotule de susp. inf. G/D

OE 7701464037

L/R lower suspension ball joint



1
2

TT /all models Mot. longitudinal

4005257

Rotule de susp. inf. G/D

OE 7701472038

L/R lower suspension ball joint











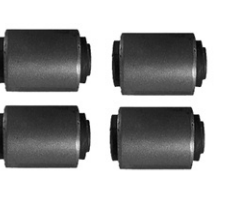

1
2

Trous fixation Ø10

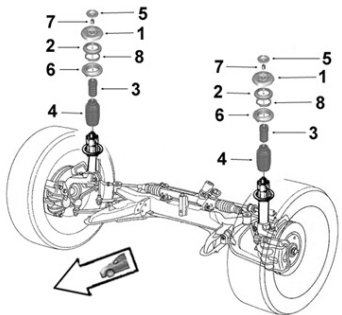
TT /all models Mot. transversal

... R21 ...

<p>405A411S OE -</p>	<p>Kit rép. train AV <i>Front axle repair kit</i></p>	<p>406A411S OE -</p>	<p>Kit rép. train AV <i>Front axle repair kit</i></p>
	<p>Sans visserie <i>Without screws and bolts</i> Barre Ø 25.4 bout Ø 21 L palier milieu 39</p> <p>TT /all models Mot. longitudinal</p>		<p>Sans visserie <i>Without screws and bolts</i> Barre Ø 25.4 bout Ø 23 L palier milieu 39</p> <p>TT /all models Mot. longitudinal</p>
<p>405A412S OE -</p>	<p>Kit rép. train AV <i>Front axle repair kit</i></p>	<p>4005426S OE -</p>	<p>Kit rép. triangle susp. G et D <i>L or R Track control arm bearing repair kit</i></p>
	<p>Sans visserie <i>Without screws and bolts</i> Barre Ø 16</p> <p>TT /all models Mot. transversal</p>		<p>Sans visserie <i>Without screws and bolts</i></p> <p>TT /all models Mot. transversal</p>
<p>4005411 OE -</p>	<p>Kit rép. triangle susp. G ou D <i>L or R track control arm bearing repair kit</i></p>	<p>4005412 OE -</p>	<p>Kit rép. triangle susp. G ou D <i>L or R track control arm bearing repair kit</i></p>
	<p>Avec visserie <i>With screws and bolts</i></p> <p>TT /all models Mot. longitudinal</p>		<p>Avec visserie <i>With screws and bolts</i></p> <p>TT /all models Mot. transversal</p>
<div style="display: flex; justify-content: space-between;"> <div data-bbox="247 1243 536 1452">  <p>Support d'amortisseur <i>Suspension mounting</i> <i>Soporte amortiguador</i> <i>Poduszka amortyzatora</i> <i>Опора амортизатора</i></p> </div> <div data-bbox="1065 1180 1404 1494">  </div> </div>			
<p>4001325 OE 7700757691</p>	<p>Support suspension G/D <i>L/R suspension mounting</i></p>	<p>4001377 OE 7700795187</p>	<p>Support suspension G/D <i>L/R suspension mounting</i></p>
	<p>1</p> <p>TT /all models Mot. transversal B L 1.7 Mot. transversal B481 L481 2.1 D DNA Mot. longitudinal B480/6/R/V</p>		<p>1</p> <p>TT /all models DA Mot. longitudinal</p>
<p>0355275 OE 7700803635</p>	<p>Butée à billes G/D <i>L/R ball bearing</i></p>	<p>4001616 OE 7700767936</p>	<p>Butée de suspension G/D <i>L/R suspension bush</i></p>
	<p>2</p> <p>TT /all models Mot. transversal B L & longitudinal</p>		<p>3</p> <p>TT /all models Mot. transversal B L TT /all models sauf B/L489 4WD Mot. longitudinal</p>

... R21



RENAULT



Support d'amortisseur
Suspension mounting
Soporte amortiguador
Poduszka amortyzatora
Опора амортизатора

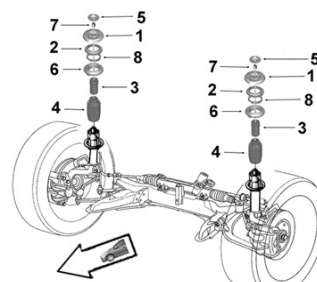

4005370

OE 7700757132

Protecteur amortisseur

Shock absorber protector



4

Mot. transversal

1.4	B48D
1.7	B481/2/M/N
1.7i	B48E/F
1.9 D	B48H

4005222

OE -

Kit rép. suspension G ou D

L/R stabilizing bar repair kit



TT /all models DA Mot. longitudinal

Eléments TRAIN ARRIERE

Rear axle parts

Tren TRAS

Elementy zawieszenia tylnego

элементы задней оси.



4003384

OE 7700762843

Articulation

Bush



Ø int.32 Ø ext.72 long. tube int.73 ext.37

TT /all models Mot. longitudinal

Mot. transversal B L

TT /all models sauf B48J 510 /520 L484 510 /51Y L48J 510 /51Y /566 /567 L48U 578 /610

1.7 B481 L481

4003385

OE 7700762844

Articulation

Bush



Ø int.32 Ø ext.72 long. tube int.73 ext.37

1.4 Moteur transversal L48U 578 /610

1.7 Moteur transversal B481 L481 L484 510 /51Y

TT /all models Moteur longitudinal

2.0i Moteur longitudinal B48J 510 /520 L48J 510 /51Y /566 /567

R21 Nevada ...

Eléments DIRECTION

Steering parts

Elementos Direcciones

Elementy układ kierowniczy

Элементы рулевой системы

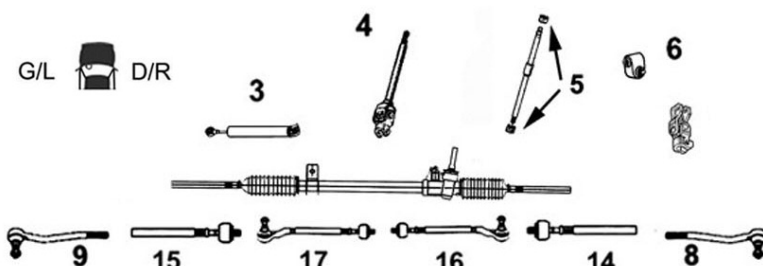

3008045 OE 6000022815	Axe de bielle G/D <i>L/R axial joint</i>	4006045B1 OE 7701466236	Bielle de direction G/D <i>L/R steering rod</i>
	14 15 Côté dir. M12x1.0 Côté rot. M14x1.5 long 272 mm TT /all models Mot. transversal		16 17 Mot. transversal TT /all models DNA sauf K/S48H TT /all models DA
4006113 OE 7701469230	Rotule de direction G/D <i>L/R tie rod end</i>	4006112 OE 7701469231	Rotule de direction G/D <i>L/R tie rod end</i>
	8 9 TT /all models Mot. longitudinal		8 9 M14 x 1.5 TT /all models Mot. transversal
4004000 OE 7700765658	Axe de volant <i>Steering wheel shaft</i>	4004001 OE 7700759787	Axe de volant <i>Steering wheel shaft</i>
	4 TT /all models Mot. longitudinal		4 TT /all models DNA Mot. transversal -09/90
4004002 OE 7700763621	Axe de volant <i>Steering wheel shaft</i>		
	4 TT /all models DA Mot. transversal -09/90		
4006138 OE 7703090293	Douille à aiguilles colonne <i>Needle bearing</i>		
	5 TT /all models Mot. longitudinal & transversal		

RENAULT



... R21 Nevada ...



Barre stabilisatrice
 Stabilizer bar
 Barra estabilizadora
 Drażek stabilizatora
 стабилизатор поперечной устойчивости

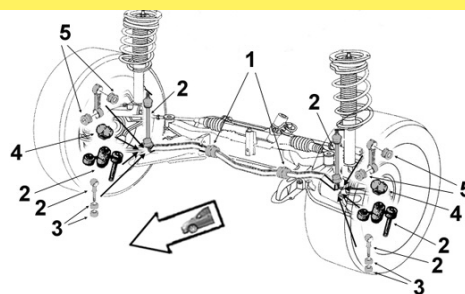

RENAULT

SASIC

4001478 OE 7700789412	Palier de barre bout <i>End bar main bearing</i>	4001477 OE 7700762130	Palier de barre bout <i>End bar main bearing</i>
	4 Barre Ø 16 TT /all models Moteur transversal		4 Barre Ø 25 TT /all models Moteur transversal
4001482 OE 7700817328	Palier de barre bout <i>End bar main bearing</i>	4001480 OE 7700771562	Palier de barre bout <i>End bar main bearing</i>
	4 Barre Ø 20 TT /all models Moteur longitudinal		4 Barre Ø 23 TT /all models Moteur longitudinal
4001479 OE 7700773245	Palier de barre milieu <i>Middle bar main bearing</i>	4001500 OE 7700769226	Palier de barre milieu <i>Middle bar main bearing</i>
	1 Barre Ø 25 TT /all models Moteur transversal		1 Barre Ø 24 TT /all models Moteur longitudinal
4001483 OE 7700774026	Palier de barre milieu <i>Middle bar main bearing</i>	4155411 OE -	Kit rép. barre stab. G et D <i>L R Stabilizing bar repair kit</i>
	1 Barre Ø 24 TT /all models Moteur longitudinal		Barre Ø 25.4 bout Ø 21 L palier milieu 69 TT /all models Mot. longitudinal
4175411 OE -	Kit rép. barre stab. G et D <i>L R Stabilizing bar repair kit</i>		
	Barre Ø 25.4 bout Ø 23 L palier milieu 69 TT /all models Moteur longitudinal		

... R21 Nevada ...





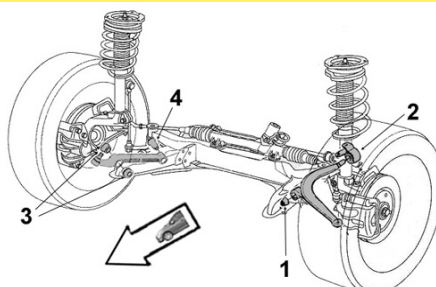



Eléments SUSPENSION
Suspension parts
Elementos suspensión
Elementy zawieszenie
Элементы подвески



RENAULT





4001405 OE 7700754515	Articulation AV <i>Front bush</i>	4001549 OE 7700785937	Articulation AV <i>Front bush</i>
	1 Ø int.12 Ø ext.36 long. tube int.51 ext.39 Moteur longitudinal 2.0i K48B/C/R/S 2.1 D K480/V 2.2 K48K		1 Ø int.12 Ø ext.36 long. tube int.51 ext.40 Moteur longitudinal 2.1 TD K48A/P/W/7/8 2.2 4WD K48K
	TT /all models Moteur transversal		Moteur longitudinal 2.0 TXE K48S J6T790 /91 2.0i K48C/R 2.1 D K480 J8S784 2.2 K48K
4001417 OE 7704000681	Articulation AV/AR <i>Front rear bush</i>	4001409 OE 7700777276	Articulation AR <i>Rear bush</i>
	1 2 Ø int.12 Ø ext.32 long. tube int.46 ext.35 TT /all models Moteur transversal		2 Ø int.12 Ø ext.36 coll.46.5 long. tube int.48.5 ext.37 ep. coll.6 Moteur longitudinal 2.0 TXE K48S J6T790 /91 2.0i K48C/R 2.1 D K480 J8S784 2.2 K48K
	TT /all models Moteur transversal		Moteur longitudinal 2.0 TXE K48S J6T790 /91 2.0i K48C/R 2.1 D K480 J8S784 2.2 K48K
4001547 OE 7700805329	Articulation AR <i>Rear bush</i>	4001487 OE 7700772687	Articulation AR <i>Rear bush</i>
	2 Ø int. 12 Ø ext.36 coll.46 long. tube int.48.5 ext.37 ep. coll.3 Moteur longitudinal 2.1 TD K48P /W J8S746 /88 2.1 TD 1 K487/88 2.2i 4WD K48K		2 Ø int.12 Ø ext.37 long. tube int.48.5 ext.37 Moteur longitudinal 2.0 K483 K489 J6R792/93 09/89- 2.0 K48R J7R740 2.0 GTX TXE K48S J6T790/91 09/89- 2.1 D K48V S48V J8S600 09/89- 2.1 D K486 S486 J8S704 09/89- 2.1 D K488 09/89- 2.1 TD K488 -05/89
	TT /all models Moteur transversal		Moteur longitudinal 2.0 TXE K48S J6T790 /91 2.0i K48C/R 2.1 D K480 J8S784 2.2 K48K

Bras & Triangle de suspension

Control arm
Brazo y triángulo
Wahacz
Рычаг подвески

G/L  D/R



4003365 OE 7701641726	Triangle de susp. G <i>Left track control arm</i>	4003364 OE 7701641727	Triangle de susp. D <i>Right track control arm</i>
	4 Acier avec rotule steel with ball joint TT /all models Mot. longitudinal		3 Acier avec rotule steel with ball joint TT /all models Mot. longitudinal

... R21 Nevada ...

SASIC

RENAULT

Bras & Triangle de suspension

Control arm
Brazo y triángulo
Wahacz
Рычаг подвески

G/L  D/R



... R21 Nevada





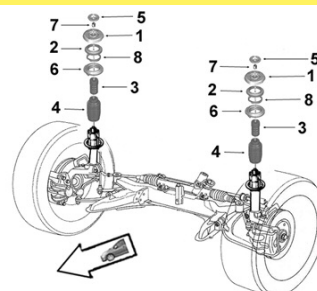



Support d'amortisseur
Suspension mounting
Soporte amortiguador
Poduszka amortyzatora
Опора амортизатора



RENAULT



4001325 OE 7700757691	Support suspension G/D <i>L/R suspension mounting</i>	4001377 OE 7700795187	Support suspension G/D <i>L/R suspension mounting</i>
	1 1.7 Mot. transversal K481 2.1 D DNA Mot. longitudinal K480		1 TT /all models DA Mot. longitudinal
0355275 OE 7700803635	Butée à billes G/D <i>L/R ball bearing</i>	4001616 OE 7700767936	Butée de suspension G/D <i>L/R suspension bush</i>
	2 TT /all models Moteur transversal & longitudinal		3 TT /all models Moteur transversal TT /all models Moteur longitudinal sauf K489 4WD
4005370 OE 7700757132	Protecteur amortisseur <i>Shock absorber protector</i>	4005222 OE -	Kit rép. suspension G ou D <i>L/R stabilizing bar repair kit</i>
	4 Mot. transversal 1.7 K48M/N/1/2 S481/2 1.7i K48E/F 1.9 D K48H S48H		TT /all models DA Mot. longitudinal

Eléments TRAIN ARRIERE

Rear axle parts

Tren TRAS

Elementy zawieszenia tylnego

элементы задней оси.









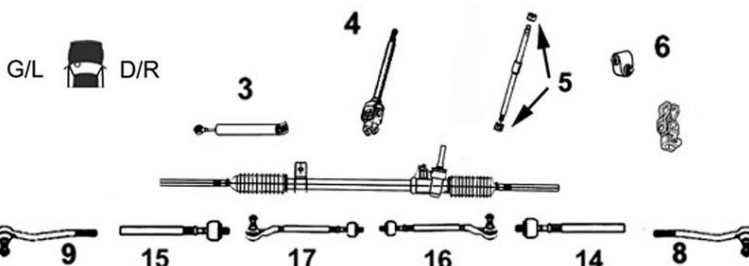

4003384 OE 7700762843	Articulation <i>Bush</i>	4003385 OE 7700762844	Articulation <i>Bush</i>
	Ø int.32 Ø ext.72 long. tube int.73 ext.37 TT /all models Moteur longitudinal TT /all models Moteur transversal sauf K48J/U 1.7 Moteur transversal K481		Ø int.32 Ø ext.72 long. tube int.73 ext.37 TT /all models Moteur longitudinal 1.4 Moteur transversal K48U 1.7 Moteur transversal K481

R25 ...

Eléments DIRECTION
 Steering parts
 Elementos Direcciones
 Elementy układ kierowniczy
 Элементы рулевой системы

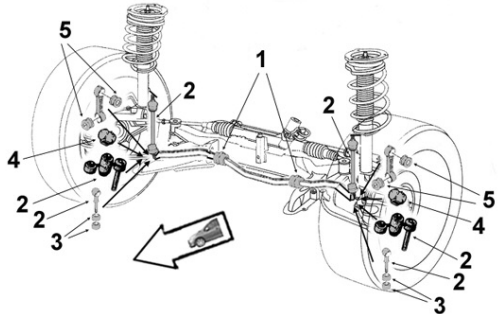









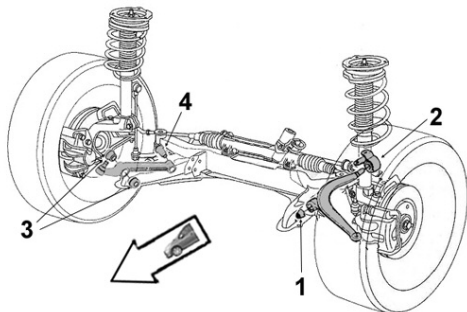

<p>3008048 OE -</p> 	<p>Axe de bielle G/D <i>L/R axial joint</i></p> <p>14 15 Côté dir. M12x1.0 Côté rot. M14x1.5 long 190 mm</p> <p>TT /all models</p>	<p>4006048B1 OE 7701469229</p> 	<p>Bielle de direction G/D <i>L/R steering rod</i></p> <p>16 17</p> <p>TT /all models</p>
<p>4006112 OE 7701469231</p> 	<p>Rotule de direction G/D <i>L/R tie rod end</i></p> <p>8 9 M14x1.5</p> <p>TT /all models</p>	<p>4006138 OE 7703090293</p> 	<p>Douille à aiguilles colonne <i>Needle bearing</i></p> <p>5</p> <p>TT /all models</p>
<p>4001460 OE 7700687433</p>  <p>Noix cardan de direction <i>U joint</i></p> <p>6</p> <p>TT /all models</p>			
<p></p> <p>Barre stabilisatrice <i>Stabilizer bar</i> <i>Barra estabilizadora</i> <i>Drażek stabilizatora</i> <i>стабилизатор поперечной устойчивости</i></p> 			
<p>4005121 OE 7700766870</p> 	<p>Biellette barre stab. <i>Stabilizer bar stub axle</i></p> <p>2 Barre Ø 22 Entraxe 131mm</p> <p>2.0 B297 -02/88 2.1 D B296 -02/88 2.1 TD B290 -02/88</p>	<p>4005124 OE 7700781500</p> 	<p>Biellette barre stab. <i>Stabilizer bar stub axle</i></p> <p>2 Barre Ø 22 Entraxe 152mm</p> <p>2.0 B297 03/88- 2.1 D B296 03/88- 2.1 TD B290 03/88-</p>

... R25 ...

RENAULT



4005123 OE 7700766869	Biellette barre stab. <i>Stabilizer bar stub axle</i>	4005122 OE 7700781498	Biellette barre stab. <i>Stabilizer bar stub axle</i>
	2 Barre Ø 24 Entraxe 131mm TT /all models Sauf B290 B296 B297 -02/88		2 Barre Ø 24 Entraxe 152mm TT /all models sauf B29W B290 B296 B297 03/88-
4001503 OE 7700797821	Palier de barre milieu <i>Middle bar main bearing</i>	4001504 OE 7700797822	Palier de barre milieu <i>Middle bar main bearing</i>
	1 Barre Ø 22 2.0 B297 2.1 D B296 2.1 TD B290		1 Barre Ø 24 TT /all models
 <p>Eléments SUSPENSION <i>Suspension parts</i> <i>Elementos suspensión</i> <i>Elementy zawieszenie</i> <i>Элементы подвески</i></p>			
4001502 OE 7704001734	Articulation sup. <i>Upper bush</i>	4001427 OE 7704002466	Articulation AV inf. <i>Front lower bush</i>
	4 Ø int.14 Ø ext.35 long. tube int.58.5 ext.43 TT /all models sauf B296 -02/88 TT /all models 03/88-		1 Ø int.16 Ø ext.40 coll.51 long. tube int.83 ext.49 ep. coll.6.4 TT /all models -02/88
4001410 OE 7700781463	Articulation AV inf. <i>Front lower bush</i>	4001490 OE 7700777540	Articulation AR inf. <i>Rear lower bush</i>
	1 Ø int.14 Ø ext.36 long. tube int.31.5 ext.23.4 TT /all models 03/88-		2 Ø int.16 Ø ext.40 coll.51 long. tube int.84 ext.56 ep. coll.5 TT /all models -02/88
4001489 OE 7700781441	Articulation AR inf. <i>Rear lower bush</i>	4003347 OE 7700781442	Art. tirant de chasse <i>Rod bushing</i>
	2 Ø int.22.5 TT /all models 03/88-		Ø int.12 Ø ext.30 coll.41.5 long. tube int.58 ext.45 ep. coll.4.5 TT /all models

... R25

SASIC

RENAULT

Bras & Triangle de suspension

Control arm
Brazo y triángulo
Wahacz
Рычаг подвески

G/L  D/R



4005262 Rotule de susp. sup. G/D
OE 7701469228 L/R upper susp. ball joint



1
2

TT /all models

4005263 Rotule de susp. inf. G/D
OE 7701465689 L/R lower suspension ball joint



1
2

TT /all models

4055414B Kit rép. train AV complet
OE - Front axle complete repair kit



Avec visserie With screws and bolts
Barre Ø 22

TT /all models 03/88-

4005414 Kit rép. triangle susp. G ou D
OE - L or R track control arm bearing repair kit



Avec visserie With screws and bolts

TT /all models 03/88-



Barre stabilisatrice
Stabilizer bar
Barra estabilizadora
Drażek stabilizatora
стабилизатор поперечной устойчивости

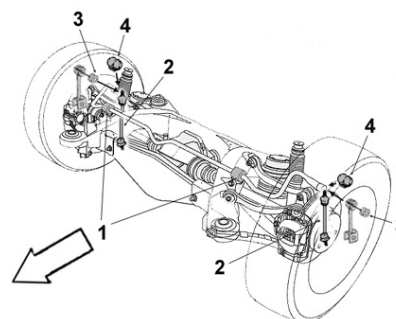

4001564 Palier de barre
OE 7700798187 Bar main bearing



1 Ø 21

TT /all models Sauf B290 B296 B297



R30

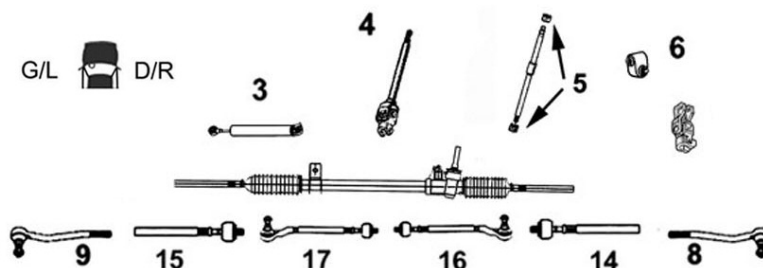

Eléments DIRECTION
Steering parts
Elementos Direcciones
Elementy uklad kierowniczy
Элементы рулевой системы



RENAULT





3008044 OE -	Axe de bielle G/D <i>L/R axial joint</i>	4006044B1 OE 7701463025	Bielle de direction G/D <i>L/R steering rod</i>
	14 15 Côté dir. M12x1.0 Côté rot. M14x1.5 long 220 mm		16 17 M14 x 1.5
	2.1 TD R1270		2.1 TD R1270

4006112 OE 7701469231	Rotule de direction G/D <i>L/R tie rod end</i>	4006138 OE 7703090293	Douille à aiguilles colonne <i>Needle bearing</i>
	8 9 M14 x 1.5		5
	2.1 TD R1270		TT /all models

4001469 OE 7704001919	Noix cardan de direction <i>U joint</i>		
	6		
	TT /all models		

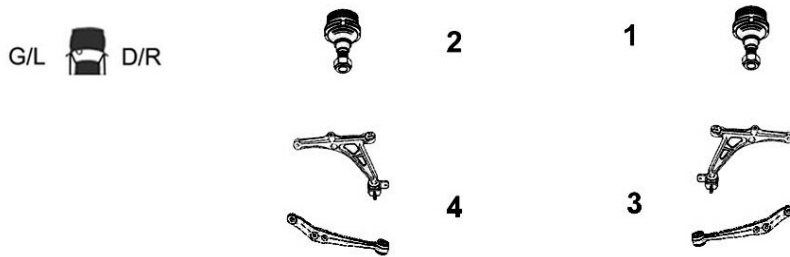
Bras & Triangle de suspension
Control arm
Brazo y triángulo
Wahacz
Рычаг подвески



4005258 OE 7701461332	Rotule de susp. sup. G/D <i>L/R upper susp. ball joint</i>	4005259 OE 7701461331	Rotule de susp. inf. G/D <i>L/R lower suspension ball joint</i>
	1 2		1 2
	2.1 TD R1270		2.1 TD R1270

Avantime ...

Eléments DIRECTION
 Steering parts
 Elementos Direcciones
 Elementy układ kierowniczy
 Элементы рулевой системы

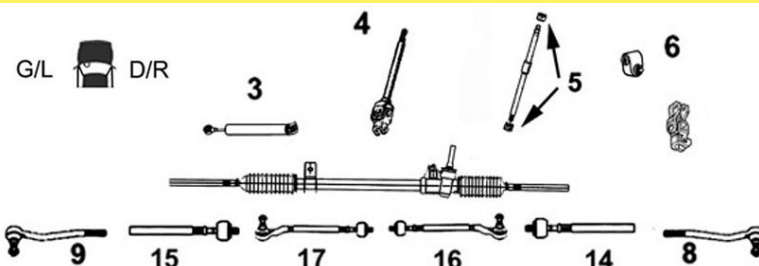

RENAULT

3008049 **Axe de bielle G/D**

Part/oe 6025370493 *L/R axial joint*



14 Côté dir. M12x1.0 Côté rot. M14x1.5 long 260 mm
15

2.0i 16v.
 2.2 DCi
 3.0 V6

7674002 **Rotule de direction G**

OE 6025370229 *Left tie rod end*



9

2.0i 16v.
 2.2 DCi
 3.0 V6

7674001 **Rotule de direction D**

OE 6025370230 *Right tie rod end*



8

2.0i 16v.
 2.2 DCi
 3.0 V6



Barre stabilisatrice
 Stabilizer bar
 Barra estabilizadora
 Drażek stabilizatora
 стабилизатор поперечной устойчивости

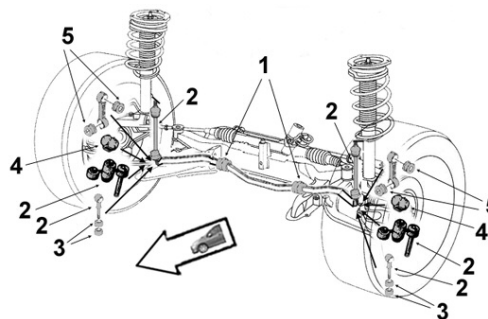

4005132 **Biellette barre stab.**

OE 7700805494 *Stabilizer bar stub axle*



2

2.0i 16v.
 2.2 DCi
 3.0 V6

... Avantime ...





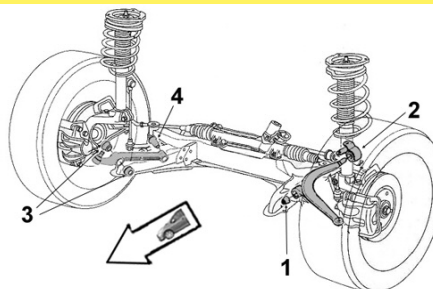



Eléments SUSPENSION
Suspension parts
Elementos suspensión
Elementy zawieszenie
Элементы подвески





RENAULT



4001535 OE 7700822503	Articulation AV <i>Front bush</i>	4001544 OE 6025311529	Articulation AR <i>Rear bush</i>
	1 Ø int.18 Ø ext.55 long. tube int.55 ext.29.5 2.0i 16v. 2.2 DCi 3.0 V6		2 Ø int.12 Ø ext.58 long. tube int.55 ext.29 2.0i 16v. 2.2 DCi 3.0 V6

Bras & Triangle de suspension <i>Control arm</i> <i>Brazo y triángulo</i> <i>Wahacz</i> <i>Рычаг подвески</i>	G/L  D/R	 2	 1
		 4	 3

4003217 OE 6025307649	Triangle de susp. G <i>Left track control arm</i>	4003218 OE 6025307650	Triangle de susp. D <i>Right track control arm</i>
	4 Avec rotule <i>With ball joint</i> 2.0i 16v. 2.2 DCi 3.0 V6		3 Avec rotule <i>With ball joint</i> 2.0i 16v. 2.2 DCi 3.0 V6

4005274 OE 6025308155	Rotule de susp. inf. G/D <i>L/R lower suspension ball joint</i>
	1 2 2.0i 16v. 2.2 DCi 3.0 V6

... Avantime ...



RENAULT



Support d'amortisseur
Suspension mounting
Soporte amortiguador
Poduszka amortyzatora
Опора амортизатора

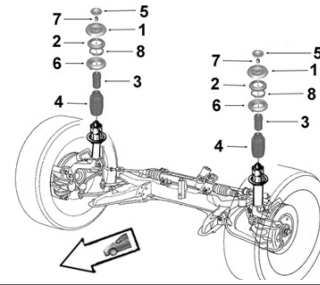

... Avantime

Eléments TRAIN ARRIERE

Rear axle parts

Tren TRAS

Elementy zawieszenia tylnego

элементы задней оси.



RENAULT



4003382

Articulation

OE 6025315757

Bush



Ø int.12 Ø ext.53 long. tube int.50 ext.34

Sans correcteur d'assiette

2.0i 16v.
2.2 DCi
3.0 V6

Captur ...

Eléments DIRECTION

Steering parts

Elementos Direcciones

Elementy układ kierowniczy

Элементы рулевой системы

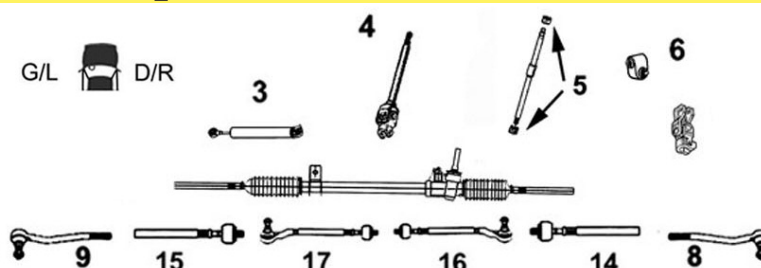

7674020

Rotule de direction G

OE 485200368R

Left tie rod end

NEW

9 M14 x 1.5



0.9i J5MA/H
1.2i J5M0
1.5 DCi J5AL J5M5/6/W

7674021

Rotule de direction D

OE 485208355R

Right tie rod end

NEW

8 M14 x 1.5



0.9i J5MA/H
1.2i J5M0
1.5 DCi J5AL J5M5/6/W



Support d'amortisseur

Suspension mounting

Soporte amortiguador

Poduszka amortyzatora

Опора амортизатора

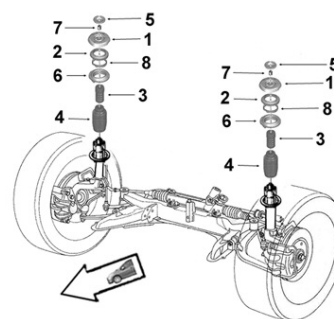

2654035

Support suspension

OE 543024644R

Suspension mounting

NEW

1



0.9i J5MA/MH 04/13-
1.2i J5M0 04/13-
1.5. DCi J5AL/MW/M5/M6 04/13-

2654030

Butée à billes G/D

OE 543259539R

L/R ball bearing

NEW

2



0.9i J5MA/MH
1.2i J5M0
1.5. DCi J5AL/M5/M6/MW

... Captur



Support d'amortisseur

Suspension mounting
Soporte amortiguador
Poduszka amortyzatora
Опора амортизатора

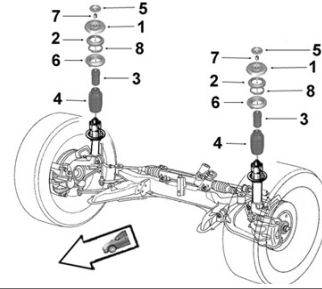

2654032

Protecteur amortisseur G/D

OE 543884315R

L/R shock absorber protector

NEW

4



0.9i J5MA/MH
1.2i J5M0
1.5. DCi J5AL/M5/M6/MW

Clio I -02/98 ...

Eléments DIRECTION

Steering parts
Elementos Direcciones
Elementy układ kierowniczy
Элементы рулевой системы

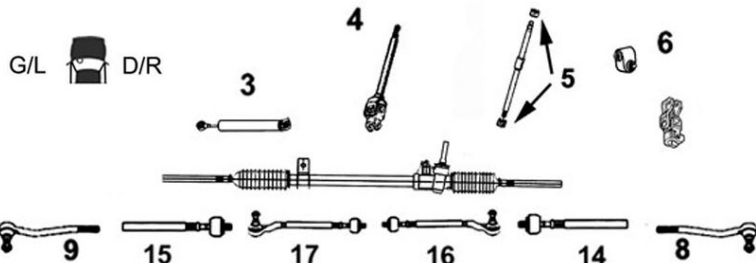

3008173

Axe de bielle G/D

OE -

L/R axial joint



14 Taraudé Tapped Côté dir. M12x1.0
15 Côté rot. M14x1.5 long 242 mm

TT /all models

3008238

Axe de bielle G/D

OE -

L/R axial joint



14 Fileté threaded Côté dir. M12x1.0
15 Côté rot. M14x1.5 long 245 mm

TT /all models

4006242

Bielle de direction G

OE 7701467271

Left steering rod



17 Axe de bielle taraudé Tapped axial joint

TT /all models sauf C57M

4006243

Bielle de direction D

OE 7701467272

Right steering rod



16 Axe de bielle taraudé Tapped axial joint

TT /all models sauf C57M

4006238

Bielle de direction G

OE 7701469777

Left steering rod



17 Axe de bielle fileté threaded axial joint (male)

TT /all models

4006239

Bielle de direction D

OE 7701469778

Right steering rod









16 Axe de bielle fileté threaded axial joint (male)

TT /all models

... Clio I -02/98 ...

RENAULT

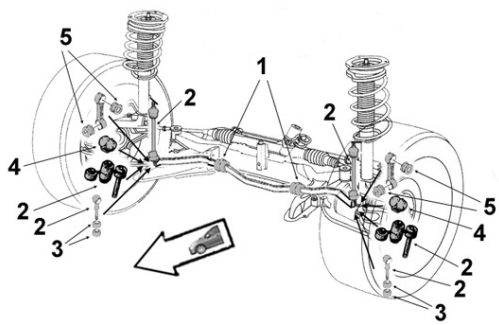

4006117 OE 6000030065	Rotule de direction G <i>Left tie rod end</i>	4006118 OE 6000030064	Rotule de direction D <i>Right tie rod end</i>
9	 TT /all models Pour axes de bielles taraudés	8	 TT /all models Pour axes de bielles taraudés
4006108 OE 7701472087	Rotule de direction G <i>Left tie rod end</i>	4006109 OE 6000022721	Rotule de direction D <i>Right tie rod end</i>
9	 TT /all models Pour axes de bielles filetés	8	 TT /all models Pour axes de bielles filetés
 Barre stabilisatrice <i>Stabilizer bar</i> <i>Barra estabilizadora</i> <i>Drażek stabilizatora</i> стабилизатор поперечной устойчивости			
4001505 OE (2oe) 7700799404+7703034237	Palier de barre bout <i>End bar main bearing</i>	4001495 OE 7700760264	Palier de barre bout <i>End bar main bearing</i>
2	 TT /all models Sauf C57M B57N/P Sauf B57B/J equipt 51-	4	Barre Ø 23 1.2i B57N 1.4i B57P 1.4i Équip. 51- B57B/J
4001475 OE 7700784170	Palier de barre bout <i>End bar main bearing</i>	4001539 OE 7700798053	Palier de barre milieu <i>Middle bar main bearing</i>
4	Barre Ø 23 2.0i Williams C57M	1	Barre Ø 22 H 45 TT /all models Sauf C57M B57N/P Sauf B57B/J equipt 51-
4001476 OE 7700785788	Palier de barre milieu <i>Middle bar main bearing</i>	4155416 OE -	Kit rép. barre stab. G et D <i>L R Stabilizing bar repair kit</i>
1	Barre Ø 23 1.2i B57N 1.4i B57P 1.4i Équip. 51- B57B/J 2.0i Williams C57M		Barre Ø 22 H palier 45 TT /all models Sauf 16v. RTi RSi S Williams

... Clio I -02/98 ...

SASIC

RENAULT



Barre stabilisatrice
 Stabilizer bar
 Barra estabilizadora
 Drażek stabilizatora
 стабилизатор поперечной устойчивости

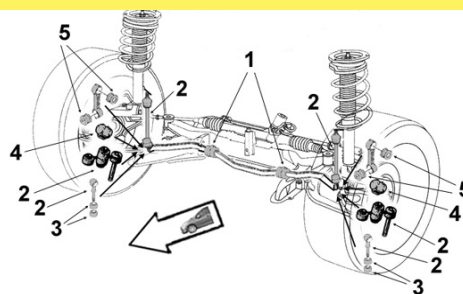

4005078

Kit rép. barre stab. G et D

OE -

L R Stabilizing bar repair kit

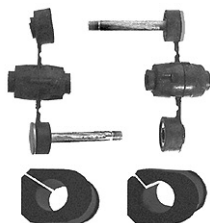

Barre percée Ø 23

TT /all models



Eléments SUSPENSION

Suspension parts
Elementos suspensión
Elementy zawieszenie
Элементы подвески

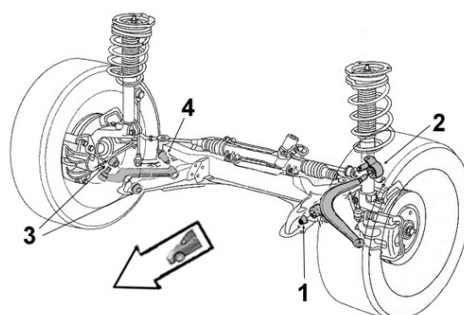

4001493

Articulation AV

OE 7700799065

Front bush



1 Ø int.12 Ø ext.40 long. tube int.46 ext.35

1.1 /Comm. B571 C571 S571
 1.2 /Comm. B577 C577 S577
 1.9 D
 TT Elec. /All models Electric
 /Comm. 557W 657W

4001412

Articulation AV

OE 7700799066

Front bush



1 Ø int.12 Ø ext.40 long. tube int.46 ext.33

1.4 C57B/T/Y
 1.8i C57C/H/9
 1.8i 16v. C57D/5

4001492

Articulation AR

OE 7700799064

Rear bush



2 Ø int.12 Ø ext.40 coll.42
 long. tube int.46 ext.28 ep. coll.6

1.1 /Comm. B571 C571 S571
 1.2 /Comm. B577 C577 S577
 1.9 D
 TT Elec. /All models Electric
 /Comm. 557W 657W

4001412

Articulation AR

OE 7700799066

Rear bush



2 Ø int.12 Ø ext.40 long. tube int.46 ext.33

1.4 C57B/T/Y
 1.8i C57C/H/9
 1.8i 16v. C57D/5

... Clio I -02/98 ...

Bras & Triangle de suspension

Control arm
Brazo y triángulo
Wahacz
Рычаг подвески

G/L  D/R

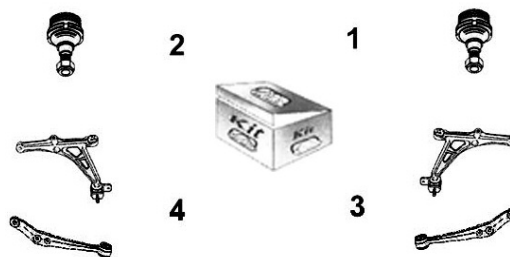

RENAULT



... Clio I -02/98







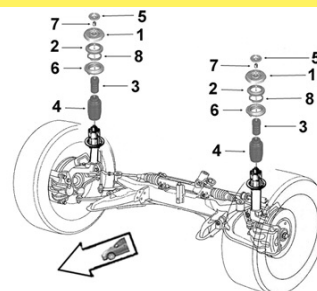

SASIC

RENAULT



Support d'amortisseur
 Suspension mounting
 Soporte amortiguador
 Poduszka amortyzatora
 Опора амортизатора



<p>4001620 OE 7700426450</p> 	<p>Coupelle rebond. <i>Spring cup</i></p> <p>5</p> <p>1.1 /Comm. B571 C571 S571 1.2 /Comm. B577 C577 S577 1.4i B57B/J/Y C57A/B/J/Y 1.8i 557D/U B57C/578 357D/U C57C/578 1.8i 16v. C57D/H C575/579 1.9 D 2.0i Williams C57M TT Elec. /All models Electric /Comm. 557W 657W</p>	<p>4001600 OE 7700827435</p> 	<p>Tampon suspension G/D <i>L/R susp. rebound stop</i></p> <p>1 H35.5mm</p> <p>1.1 /Comm. B571 C571 S571 1.2 /Comm. B577 C577 S577 1.4i B57B/J/Y C57A/B/J/Y</p> <p>TT Elec. /All models Electric /Comm. 557W 657W</p>
<p>4001602 OE 7700827436</p> 	<p>Tampon suspension G/D <i>L/R susp. rebound stop</i></p> <p>1 H41</p> <p>TT /all models Sauf S/B/C 571 577 - 557W 657W</p>	<p>4005300 OE 8200651172</p> 	<p>Butée à billes G/D <i>L/R ball bearing</i></p> <p>2</p> <p>1.1 /Comm. B571 C571 S571 1.2 /Comm. B577 C577 S577 1.4 B573 C573 1.4i B57B/J/Y C57A/B/J/Y 1.7 B574 C574 1.8i 557D/U B57C/578 357D/U/V C57C/578 1.8i 16v. C57D/H C575/579 1.9 D 2.0i Williams C57M TT Elec. /All models Electric /Comm. 557W 657W</p>
<p>4005373 OE 7700802667</p> 	<p>Butée protecteur susp. G/D <i>L/R suspension bush</i></p> <p>3 4</p> <p>1.1 /Comm. B571 C571 S571 1.2 /Comm. B577 C577 S577 1.4i B57B/J/Y C57A/B/J/Y 1.8i 557D B57C/578 357D C57C/578 1.8i 16v. C579 1.9 D TT Elec. /All models Electric /Comm. 557W 657W</p>	<p>4005227 OE -</p> 	<p>Kit rép. suspension G ou D <i>L/R stabilizing bar repair kit</i></p> <p>H 35.5</p> <p>TT /all models</p>
<p>4005228 OE -</p> 	<p>Kit rép. suspension G ou D <i>L/R stabilizing bar repair kit</i></p> <p>H 41</p> <p>TT /all models Sauf S/B/C 571 577 - 557W 657W</p>		
<p>Éléments TRAIN ARRIERE Rear axle parts Tren TRAS Elementy zawieszania tylnego элементы задней оси.</p> 		<p>4005340B OE -</p> 	<p>Kit rép. train AR G ou D <i>L/R rear axle repair kit</i></p> <p>1.9 D /Comm. 557N 657N</p>

Clio II 03/98- ...

Eléments DIRECTION

Steering parts

Elementos Direcciones



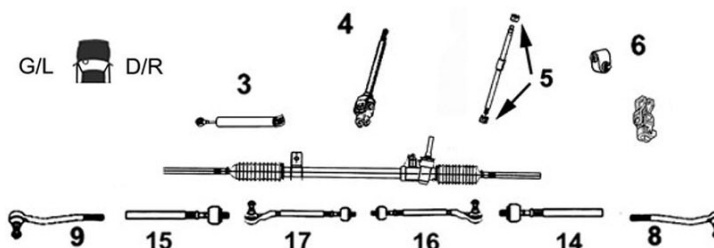

Elementy układ kierowniczy

Элементы рулевой системы



RENAULT



3008035 Part/oe 7701472113	Axe de bielle G/D L/R axial joint	3008036 Part/oe 7701471124	Axe de bielle G/D L/R axial joint
	14 Côté dir. M12x1.0 Côté rot. M14x1.5 15 long 303 mm DNA 1.2i /Comm. B/CB0A/0F SB0A 15/12/99- 1.2i B/CB10/1K/2D/2H BB28 1.2i Comm. SB10/1K/2D/2H 1.2i 16v. B/CB19/2V/27 1.6 BB00 1.9 D BB02 1.9 D /Comm. B/CB0E/0J SB0E/0R 15/12/99-		14 Côté dir. M12x1.0 Côté rot. M14x1.5 15 long 240 mm DNA 1.2 /Comm. B/CB0A/0F SB0A -15/12/99 1.9 D /Comm. B/CB0E/0J SB0E/0R -15/12/99
3008037 Axe de bielle G/D Part/oe 7701471125 L/R axial joint			
	14 Côté dir. M12x1.0 Côté rot. M14x1.5 15 long 240 mm DA SMI 1.2 B/CB0A/0F C/SB0A -15/12/99 1.4 B/CB0C/0S -15/12/99 1.4i 16v. B/CB0L -15/12/99 1.6 BB0D CB0D/0T -15/12/99 1.9 D /Comm. B/CB0E/0J SB0E/0R -15/12/99 1.9 DTi B/CB0U -15/12/99		
3008039 Axe de bielle G/D Part/oe 7701471144 L/R axial joint			
	14 Côté dir. M14x1.5 Côté rot. M14x1.5 long 240 mm DA TRW 15 1.2 /Comm. B/C/SB 0A/0F/1K/2D/2H C/SB 10 -15/12/99 1.2i 16v. B/CB05/0W/11/19/2T/2U B/CB2V/27 -15/12/99 1.4 B/CB0B/0C/17 BB0S -15/12/99 1.4i 16v. B/CB0L/0P/13/1L -15/12/99 1.5 DCi B/CB07/1W/2G BB24 CB08/2J -15/12/99 1.5 DCi Comm. SB07/08/09/2J/3A -15/12/99 1.6 B/CB0D BB00 -15/12/99 1.6i 16v. B/CB01/0H/0T/14/1D/26 B/CB3E/3G/3H -15/12/99 1.6i 16v. /Comm. BB1J/1R/2K SB0H -15/12/99 1.9 D /Comm. B/C/SB 0E/0J BB02 SB0R -15/12/99 1.9 DTi /Comm. B/CB0U/0V/2C SB0U -15/12/99		
3008040 Axe de bielle G/D Part/oe 7701472120 L/R axial joint			
	14 Côté dir. M12x1.0 Côté rot. M14x1.5 long 305 mm 15 1.2 /Comm. DA SMI B/C/SB 2D/2H SB1K 1.2 DA SMI TRW BB10/28 -15/12/99 1.2 DA SMI B/CB0A 15/12/99- 1.2 /Comm. DA SMI B/CB0F/10/1K SB0F/10 15/12/99-06/01 1.2 DA TRW BB10 15/12/99-06/01 1.2 DA SMI TRW BB28 15/12/99- 1.2 /Comm. DA SMI B/CB0F/1K CB10 SB0F 06/01- 1.2 /Comm. DA SMI TRW B/SB 10 06/01- 1.2i 16v. DA SMI B/CB19 CB11 B/CB2T/2V/27 1.2i 16v. DA SMI B/CB05/0W BB11 15/12/99- 1.4 DA SMI B/CB17 1.4 DA SMI B/CB0B/0C/0S 15/12/99- 1.4i 16v. DA SMI B/CB13 B/CB1L 1.4i 16v. DA SMI B/CB0L B/CB0P 15/12/99- 1.5 DCi DA SMI B/CB1W/2G BB24 CB07/08/2J 1.5 DCi DA SMI TRW BB08/2J 1.5 DCi Comm. DA SMI SB08/09 SB 2J/3A 1.5 DCi /Comm. DA SMI B/SB 07 15/12/99- ...		

... Clio II 03/98- ...

Eléments DIRECTION

Steering parts

Elementos Direcciones

Elementy układ kierowniczy

Элементы рулевой системы

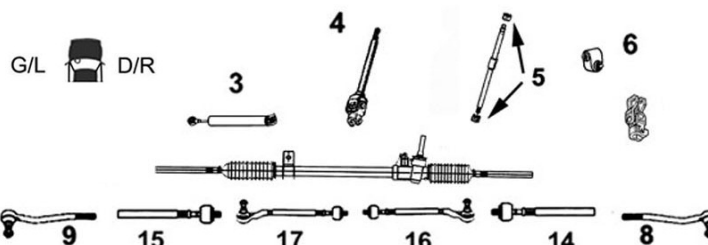

... 3008040 Axe de bielle G/D Part/oe 7701472120 L/R axial joint



14	Côté dir. M12x1.0 Côté rot. M14x1.5 long 305 mm	DA SMI	
15	1.6	B/CB0D BB00	15/12/99-
	1.6i 16v.	B/CB26/3E/3G/3H	
	1.6i 16v. /Comm.	B/CB14/1D SB0H	
	1.6i 16v.	B/CB01/0H/0T BB1J	15/12/99-
	1.9 D /Comm.	B/C/SB 0E/0J BB02 SB0R	15/12/99-
	1.9 DTi	B/CB2C	
	1.9 DTi Comm.	SB0U	
	1.9 DTi	B/CB0U/0V	15/12/99-
	2.0i 16v.	CB1S	
	2.0i 16v.	CB0M/1C	15/12/99-
	2.0i 16v.	CB15	-06/01

3008055 Axe de bielle G/D Part/oe 7701472735 L/R axial joint



14	Côté dir. M14x1.5 Côté rot. M14x1.5 long 294 mm	DA TRW	
15	1.2 /Comm.	B/C/SB 0A/0F/1K/2D/2H C/SB 10	15/12/99-
	1.2i 16v.	B/CB05/0W/11/19/2T/2U/2V/27	15/12/99-
	1.4	B/CB0B/0C/0S/17	15/12/99-
	1.4i 16v.	B/CB0L/0P/13/1L	15/12/99-
	1.5 DCi	B/CB07/1W/2G BB24 CB08/2J	15/12/99-
	1.5 DCi Comm.	SB07/08/09/2J/3A	15/12/99-
	1.6	B/CB0D BB00	15/12/99-
	1.6i 16v.	B/CB01/0H/0T/14/1D/26/3E/3G/3H	15/12/99-
	1.6i 16v. /Comm.	BB1J/1R/2K SB0H	15/12/99-
	1.9 D /Comm.	B/C/SB 0E/0J BB02 SB0R	15/12/99-
	1.9 DTi /Comm.	B/CB0U/0V/2C SB0U	15/12/99-
	2.0i 16v.	CB0M/15/1C/1G/1N/1S/1T/20/21/22/2P	15/12/99-

3008243 Axe de bielle G/D Part/oe 7701473656 L/R axial joint



14	Côté dir. M12x1.0 Côté rot. M14x1.5 long 314 mm	DA SMI	
15	2.0i 16v.	CB15	06/01-
	2.0i 16v.	CB1G/1N/20/21/22/2P	

4006144 Rotule de direction G OE 7701476762 Left tie rod end



9	Dir. SMI TRW -15/12/99	
	1.2 /Comm. B/C/SB0A/0F/10/1K/2D/2H	BB28
	1.2i 16v. B/CB05/0W/11/19/2T/2U/2V/27	
	1.4 B/CB0B/0C/0S/17	
	1.4i 16v. B/CB0L/0P/13/1L	
	1.5 DCi B/CB07/08/1W/2G/2J	
	1.5 DCi /Comm. BB24 SB 07/08/09/2J/3A	
	1.6 BB00/0D CB0D	
	1.6i 16v. B/CB01/0H/0T/14/1D/26/3E/3G/3H	
	1.6i 16v. /Comm. BB1J/1R/2K SB0H	
	1.9 D /Comm. B/C/SB0E/0J BB02	
	1.9 D Comm. SB0R	
	1.9 DTi /Comm. B/C/SB0U B/CB0V/2C	

4006145 Rotule de direction D OE 7701476763 Right tie rod end



8	Dir. SMI TRW -15/12/99	
	1.2 /Comm. B/C/SB0A/0F/10/1K/2D/2H	BB28
	1.2i 16v. B/CB05/0W/11/19/2T/2U/2V/27	
	1.4 B/CB0B/0C/0S/17	
	1.4i 16v. B/CB0L/0P/13/1L	
	1.5 DCi B/CB07/08/1W/2G/2J	
	1.5 DCi /Comm. BB24 SB 07/08/09/2J/3A	
	1.6 BB00/0D CB0D	
	1.6i 16v. B/CB01/0H/0T/14/1D/26/3E/3G/3H	
	1.6i 16v. /Comm. BB1J/1R/2K SB0H	
	1.9 D /Comm. B/C/SB0E/0J BB02	
	1.9 D Comm. SB0R	
	1.9 DTi /Comm. B/C/SB0U B/CB0V/2C	

... Clio II 03/98- ...

RENAULT



4006134

Rotule de direction G

OE 7701474641

Left tie rod end

9



1.2/ GPL /Comm.	Dir. SMI TRW	B/C/SB 0A/0F/10/1K/2D	15/12/99-
1.2 /Comm.	Dir. SMI TRW	B/C/SB 2H BB28	15/12/99-
1.2i 16v.	DA SMI TRW	B/CB05/0W/11/19/2T/2U	15/12/99-
1.2i 16v.	Dir. SMI TRW	B/CB2V/27	15/12/99-
1.4	Dir. SMI TRW	B/CB0B/0C/0S/17	15/12/99-
1.4i 16v.	Dir. SMI TRW	B/CB0L/0P/13/1L	15/12/99-
1.5 DCi	Dir. SMI TRW	B/CB07/08/1W/2G/2J	15/12/99-
1.5 DCi /Comm.	Dir. SMI TRW	BB24 SB 07/08/09/2J/3A	15/12/99-
1.6	Dir. SMI TRW	BB00/0D CB0D	15/12/99-
1.6i 16v.	Dir. SMI TRW	B/CB01/0H/0T/14/1D/26	15/12/99-
1.6i 16v.	Dir. SMI TRW	B/CB3E/3G/3H	15/12/99-
1.6i 16v. /Comm.	Dir. SMI TRW	BB1J/1R/2K SB0H	15/12/99-
1.9 D /Comm.	Dir. SMI TRW	B/C/SB 0E/0J BB02 SB0R	15/12/99-
1.9 DTi /Comm.	Dir. SMI TRW	B/C/SB 0U B/CB 0V/2C	15/12/99-
2.0i 16v.	Dir. SMI TRW	CB0M/15/1C/1G/1N/1S	15/12/99-
2.0i 16v.	Dir. SMI TRW	CB1T/20/21/22/2P	15/12/99-
3.0 RS V6	Dir. SMI	CB1A/H/U CB2S	

4006135

Rotule de direction D

OE 7701047813

Right tie rod end

8



1.2/ GPL /Comm.	Dir. SMI TRW	B/C/SB 0A/0F/10/1K/2D	15/12/99-
1.2 /Comm.	Dir. SMI TRW	B/C/SB 2H BB28	15/12/99-
1.2i 16v.	DA SMI TRW	B/CB05/0W/11/19/2T/2U	15/12/99-
1.2i 16v.	Dir. SMI TRW	B/CB2V/27	15/12/99-
1.4	Dir. SMI TRW	B/CB0B/0C/0S/17	15/12/99-
1.4i 16v.	Dir. SMI TRW	B/CB0L/0P/13/1L	15/12/99-
1.5 DCi	Dir. SMI TRW	B/CB07/08/1W/2G/2J	15/12/99-
1.5 DCi /Comm.	Dir. SMI TRW	BB24 SB 07/08/09/2J/3A	15/12/99-
1.6	Dir. SMI TRW	BB00/0D CB0D	15/12/99-
1.6i 16v.	Dir. SMI TRW	B/CB01/0H/0T/14/1D/26	15/12/99-
1.6i 16v.	Dir. SMI TRW	B/CB3E/3G/3H	15/12/99-
1.6i 16v. /Comm.	Dir. SMI TRW	BB1J/1R/2K SB0H	15/12/99-
1.9 D /Comm.	Dir. SMI TRW	B/C/SB 0E/0J BB02 SB0R	15/12/99-
1.9 DTi /Comm.	Dir. SMI TRW	B/C/SB 0U B/CB 0V/2C	15/12/99-
2.0i 16v.	Dir. SMI TRW	CB0M/15/1C/1G/1N/1S	15/12/99-
2.0i 16v.	Dir. SMI TRW	CB1T/20/21/22/2P	15/12/99-
3.0 RS V6	Dir. SMI	CB1A/H/U CB2S	



Barre stabilisatrice

Stabilizer bar

Barra estabilizadora

Drażek stabilizatora

стабилизатор поперечной устойчивости

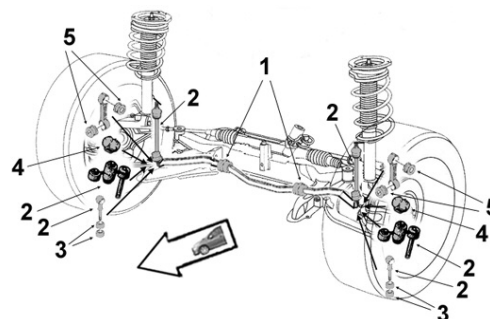

4001505

Palier de barre bout

OE 7700799404+7703034237 *End bar main bearing*

2



TT /all models
Sauf Clio RS V6 -24/09/08

2304021

Palier de barre bout

OE 8200891487+7703034237 *End bar main bearing*

2



1.2i C/B/SB 0A/0F/10/1K/2D/2H BB28
24/09/08-
1.2i 16v. C/BB 05/0W/11/19
C/BB2T/2U/2V/27/2L/2M BB30/31
24/09/08-
1.4i 16v. C/BB 0L/0P/13/1L
24/09/08-
1.5 DCi C/BB07/08/1W/2G/2J/3M/3N
BB24 SB07/08/09/2J/3A/3M 24/09/08-

... Clio II 03/98- ...

SASIC

RENAULT



Barre stabilisatrice
 Stabilizer bar
 Barra estabilizadora
 Drażek stabilizatora
 стабилизатор поперечной устойчивости

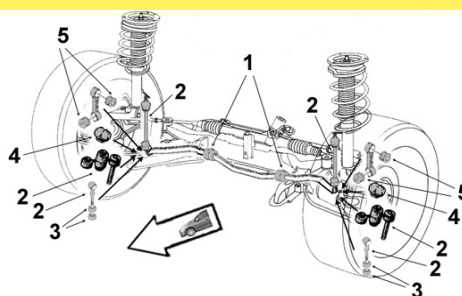

<p>4001522 OE 7700784171</p> 	<p>Palier de barre bout <i>End bar main bearing</i></p> <p>4 Barre Ø 24</p> <p>2.0i 16v. CB0M/15/1C/1G/1N/1S 2.0i 16v. CB1T/20/21/22/2P</p>	<p>2304005 OE 8200150768</p> 	<p>Palier de barre bout <i>End bar main bearing</i></p> <p>4</p> <p>3.0 RS V6 (Mot. AR Veh.) CB1A</p>
<p>4001539 OE 7700798053</p> 	<p>Palier de barre milieu <i>Middle bar main bearing</i></p> <p>1 Barre Ø 22 H 45</p> <p>1.2i /Comm. C/B/SB 0A/0F/10/1K 1.2i /Comm. C/B/SB 2D/2H 1.4i C/BB 17 BB0B 1.4i BB0S BVM 09/99- 1.4i CB0S BVM 09/99- 1.4i équip. E2/ E3 CB0B</p>	<p>4001476 OE 7700785788</p> 	<p>Palier de barre milieu <i>Middle bar main bearing</i></p> <p>1 Barre Ø 23</p> <p>1.2i 16v. C/BB 05/0W/11/2T/2U/2V CB19 1.4i sauf équip. ES2 CB0S 1.5 DCi /Comm. C/B/SB 07 -06/01 1.5 DCi /Comm. B/CB3N CB1W SB3M 1.6i BB00 1.6i équip. E2/ E3/ E5 C/BB 0D 1.9 D /Comm. C/B/SB 0E/0J 1.9 D /Comm. BB02 SB0R</p>
<p>4001517 OE 7700835929</p> 	<p>Palier de barre milieu <i>Middle bar main bearing</i></p> <p>1 Barre Ø 24</p> <p>1.4i équip. ES2 CB0S 1.4i 16v. C/BB 0L/0P/13/1L 1.5 DCi /Comm. C/B/SB 07 06/01- 1.5 DCi /Comm. C/B/SB08 C/BB 2G 1.5 DCi Comm. SB09 1.6i équip. ES2 C/BB0D 1.6i 16v. C/BB01/0H/0T/14/1D 1.6i 16v. BB1J/1R/2K 1.9 DTi /Comm. C/B/SB0U C/BB0V/2C</p>	<p>4001518 OE 7700847383</p> 	<p>Palier de barre milieu <i>Middle bar main bearing</i></p> <p>1 Barre Ø 25</p> <p>1.5 DCi CB2G 2.0i 16v. CB0M/15/1C/1G/1N/1S 2.0i 16v. CB1T/20/21/22/2P</p>
<p>4005078 OE -</p> 	<p>Kit rép. barre stab. G et D <i>L R Stabilizing bar repair kit</i></p> <p>Barre percée Ø 23</p> <p>1.2i 16v. C/BB05/0W/11/2T/2U/2V CB19</p> <p>1.4 C/BB0C 1.4 BB0S BVA 1.4 Equip. E2/E3 CB0S BVA 09/99- 1.4 Sauf équip. ES2 CB0S</p> <p>1.5 DCi /Comm. C/B/SB07 -06/01 1.5 DCi CB1W</p> <p>1.6 BB00 1.6 Equip. E2/E3/E5 C/BB0D</p> <p>1.9 D /Comm. C/B/SB0E/0J BB02 1.9 D Comm. SB0R</p>		

... Clio II 03/98- ...



Eléments SUSPENSION

Suspension parts

Elementos suspensión

Elementy zawieszenie

Элементы подвески

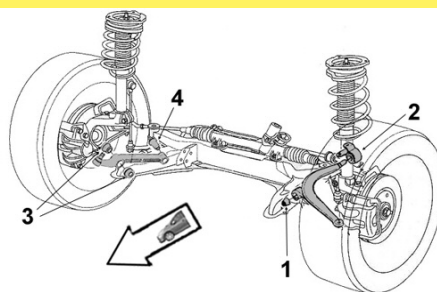

RENAULT



4001540

Articulation AV/AR

OE 8200651161

Front rear bush



1
2

Ø int.12 Ø ext.45.5 coll.59 long. tube int.46 ext.29.5 ep. coll.4

1.2i	C/BB 0A/0F/10/1K/2D/2H
1.2i Comm.	SB0A/0F/10/1K
1.2i 16v.	C/BB 05/0W/11/19/2T/2U
1.4i	C/BB 0B/0C/17 BB0S
1.4i équip. E2/ E3	CB0S
1.4i 16v. équip. E2/ E3/ E5	C/BB0L/0P/1L
1.4i 16v. équip. E2/ E3	C/BB13
1.5 DCi	C/BB 07/08/1W/2G
1.5 DCi Comm.	SB07/08/09
1.6i	BB00
1.6i équip. E2/ E3/ E5	C/BB0D
1.6i 16v. équip. E3/ E5	C/BB 1D CB0H/0T
1.6i 16v.	BB0H/0T/1J/1R/2K C/BB/01/14
1.6i 16v. Comm.	SB0H
1.9 D /Comm.	C/B/SB 0E/0J BB02 SB0R
1.9 DTi /Comm.	C/B/SB 0U C/BB 0V/2C

4001588

Articulation AV/AR

OE 8200651162

Front rear bush



1
2

Ø int. 12 Ø ext.46 coll.59 long. tube int.46 ext.30 ep. coll.4

1.4i équip. ES2	CB0S
1.4i 16v. équip. ES2	C/BB0L
1.4i 16v. équip. ES/ES2	C/BB0P
1.4i 16v. équip. ES	C/BB13/1L
1.6i équip. ES2	C/BB0D
1.6i 16v. équip. ES	C/BB1D
1.6i 16v. équip. ES3	CB0H/0T

4001529

Articulation AV/AR

OE 8200651169

Front rear bush



1
2

Ø int.12 Ø ext.45 long. tube int.46 ext.35

2.0i 16v.	CB0M/15/1C/1G/1N/1S/1T/20/21/22/2P
-----------	------------------------------------

... Clio II 03/98- ...

SASIC

RENAULT

Bras & Triangle de suspension

Control arm
Brazo y triángulo
Wahacz
Рычаг подвески

G/L  D/R



4003367

Triangle de susp. G

OE 8200197179

Left track control arm



4 Avec rotule With ball joint

1.2	B/CB0A/0F/10/1K/2D/2H	-24/09/08
1.2 /Comm.	BB28 SB0A/0F/2D/2H	-24/09/08
1.2i 16v.	B/CB05/0W/11/19/2T/2U/27	-24/09/08
1.4	BB0B/0C/0S/17 CB0C/17	-24/09/08
1.4 Équip. E2/E3	CB0B/0S	-24/09/08
1.4 Équip. ES2	CB0S	-24/09/08
1.4i 16v. Équip. E2/E3/E5	B/CB0L	-24/09/08
1.4i 16v. Équip. E1/E2/E3/E5	B/CB0P/1L	-24/09/08
1.4i 16v. Équip. E2/E3	B/CB13	-24/09/08
1.4i 16v. Équip. ES	B/CB13/1L	-24/09/08
1.4i 16v. Équip. ES2	B/CB0L	-24/09/08
1.4i 16v. Équip. ES/ES2	B/CB0P	-24/09/08
1.5 DCi	B/CB07/08/1W2G/2J	-24/09/08
1.5 DCi /Comm.	BB24 SB 07/09	-24/09/08
1.6 Équip. E2/E3/E5	B/CB0D BB00	-24/09/08
1.6 Équip. ES2	B/CB0D	-24/09/08
1.6i 16v.	B/CB01/14/26/3E/3G/3H	-24/09/08
1.6i 16v. /Comm.	BB0H/0T/1J/1R/2K SB0H	-24/09/08
1.6i 16v. Équip. E3/ E5	BB1D CB0H/0T/1D	-24/09/08
1.6i 16v. Équip. ES	B/CB1D	-24/09/08
1.6i 16v. Équip. ES3	CB0H/0T	-24/09/08
1.9 D /Comm.	B/C/SB 0E/0J BB02 SB0R	-24/09/08
1.9 DTi /Comm.	B/CB0U/0V/2C SB0U	-24/09/08
2.0i 16v.	CB0M/1C/1S	-24/09/08
2.0i 16v. Équip. SAN513	CB15/1N/1T	-13/09/02
2.0i 16v.	CB1G	-13/09/02

4003366

Triangle de susp. D

OE 8200197187

Right track control arm



3 Avec rotule With ball joint

1.2	B/CB0A/0F/10/1K/2D/2H	-24/09/08
1.2 /Comm.	BB28 SB0A/0F/2D/2H	-24/09/08
1.2i 16v.	B/CB05/0W/11/19/2T/2U/27	-24/09/08
1.4	BB0B/0C/0S/17 CB0C/17	-24/09/08
1.4 Équip. E2/E3	CB0B/0S	-24/09/08
1.4 Équip. ES2	CB0S	-24/09/08
1.4i 16v. Équip. E2/E3/E5	B/CB0L	-24/09/08
1.4i 16v. Équip. E1/E2/E3/E5	B/CB0P/1L	-24/09/08
1.4i 16v. Équip. E2/E3	B/CB13	-24/09/08
1.4i 16v. Équip. ES	B/CB13/1L	-24/09/08
1.4i 16v. Équip. ES2	B/CB0L	-24/09/08
1.4i 16v. Équip. ES/ES2	B/CB0P	-24/09/08
1.5 DCi	B/CB07/08/1W2G/2J	-24/09/08
1.5 DCi /Comm.	BB24 SB 07/09	-24/09/08
1.6 Équip. E2/E3/E5	B/CB0D BB00	-24/09/08
1.6 Équip. ES2	B/CB0D	-24/09/08
1.6i 16v.	B/CB01/14/26/3E/3G/3H	-24/09/08
1.6i 16v. /Comm.	BB0H/0T/1J/1R/2K SB0H	-24/09/08
1.6i 16v. Équip. E3/ E5	BB1D CB0H/0T/1D	-24/09/08
1.6i 16v. Équip. ES	B/CB1D	-24/09/08
1.6i 16v. Équip. ES3	CB0H/0T	-24/09/08
1.9 D /Comm.	B/C/SB 0E/0J BB02 SB0R	-24/09/08
1.9 DTi /Comm.	B/CB0U/0V/2C SB0U	-24/09/08
2.0i 16v.	CB0M/1C/1S	-24/09/08
2.0i 16v. Équip. SAN513	CB15/1N/1T	-13/09/02
2.0i 16v.	CB1G	-13/09/02

... Clio II 03/98- ...

7474030 OE 8200942407 	Triangle de susp. G <i>Left track control arm</i> 4 Avec rotule With ball joint Ø 16 TT /all models Sauf Clio RS V6 24/09/08-	7474029 OE 8200942408 	Triangle de susp. D <i>Right track control arm</i> 3 Avec rotule With ball joint Ø 16 TT /all models Sauf Clio RS V6 24/09/08-
4003360 OE 8200737112 	Triangle de susp. G <i>Left track control arm</i> 4 Avec rotule With ball joint 3.0 RS V6 CB1A/H/U CB2S	4003359 OE 8200737114 	Triangle de susp. D <i>Right track control arm</i> 3 Avec rotule With ball joint 3.0 RS V6 CB1A/H/U CB2S
4005257 Rotule de susp. inf. G/D OE 7701468883 <i>L/R lower suspension ball joint</i>			
	1 2 Trous fixation Ø10 1.0i BB0Y -18/09/02 1.0i 16v. BB06 -18/09/02 1.2 /Comm. B/C/SB0A SB10 1.2 /Comm. B/CB 0F/10/1K/2D SB0F -18/09/02 1.2i 16v. B/CB 05/0W/11 BB19/2T -18/09/02 1.4 B/CB 0B/0C/0S/17 1.4i 16v. B/CB0L 1.4i 16v. B/CB 0P/13/1L -18/09/02 1.5 DCi Comm. SB08 1.5 DCi /Comm. B/CB07/08 SB07/09 -18/09/02 1.6 B/CB0D BB00 1.6i 16v. B/CB 0H/0T BB1J 1.6i 16v. B/CB 14/1D BB01/1R -18/09/02 1.9 D /Comm. B/C/SB 0E/0J BB02 SB0R 1.9 DTi /Comm. B/CB 0U/0V SB0U 1.9 DTi B/CB2C -18/09/02		
4005277 Rotule de susp. inf. G/D Part/oe 7700430765 <i>L/R lower suspension ball joint</i>			
	1 2 Trous fixation Ø12 1.0i B/CB2Y CB0Y 1.0i BB0Y 19/09/02- 1.0i 16v. B/CB 2R/3B/3V/3W CB06 1.0i 16v. BB06 19/09/02- 1.2 /Comm. B/C/SB2H BB28 SB1K/2D 1.2/ GPL /Comm. B/CB 0F/10/1K/2D SB0F 19/09/02- 1.2i 16v. B/CB 2U/27/2M BB30/31 CB19/2T 19/09/02- 1.2i 16v. B/CB 05/0W/11 BB19/2T 19/09/02- 1.4i 16v. B/CB 0P/13/1L 19/09/02- 1.5 DCi /Comm. B/C/SB 2J/3M B/CB 1W/2G/3N BB24 SB3A 1.5 DCi /Comm. B/CB07/08 SB07/09 19/09/02- 1.6i 16v. /Comm. B/CB 26/3E/3G/3H BB2K CB01 SB0H 1.6i 16v. B/CB 14/1D BB01/1R 19/09/02- 1.9 DTi B/CB2C 19/09/02-		

RENAULT



... Clio II 03/98- ...

Bras & Triangle de suspension

Control arm
Brazo y triángulo
Wahacz
Рычаг подвески

G/L  D/R



RENAULT

SASIC

1003576

Kit rép. triangle susp. G ou D

OE - *L or R track control arm bearing repair kit*

Avec visserie With screws and bolts



1.2	C/BB0A/0F/10/1K/2D/2H
1.2 Comm.	SB0A/0F/10/1K
1.2i 16v.	C/BB05/0W/11/19/2T/2U
1.4	C/BB0B/0C/17 BB0S
1.4 Équip. E2/E3	CB0S
1.4i 16v. Équip. E2/E3/E5	C/BB0L/0P/1L
1.5 DCi	C/BB07/08/1W/2G
1.5 DCi Comm.	SB07/08/09
1.6	BB00
1.6 Equipements E2/E3/E5	C/BB0D
1.6i 16v.	BB0H/0T/1J/1R/2K C/BB01/14
1.6i 16v. Comm.	SB0H
1.6i 16v. Equipement E3/ E5	C/BB1D CB0H/0T
1.9 D /Comm. C/B/SB0E/OJ	BB02
1.9 D Comm.	SB0R
1.9 DTi /Comm.	C/B/SB0U C/BB0V/2C

7964003

Kit rép. train AV

OE - *Front axle repair kit*

Sans visserie Without screws and bolts



1.2i 16v.	C/BB 05/0W/11/19/2T
1.4i	C/BB0B/0C/17 BB0S
1.5 DCi	C/BB 07/08/1W/2G
1.5 DCi Comm.	SB07/08/09
1.6i 16v. Comm.	SB0H
1.9 D /Comm.	C/B/SB0E/OJ
1.9 D /Comm.	BB02 SB0R
1.9 DTi /Comm.	C/B/SB 0U C/BB 0V/2C

105A576S

Kit rép. train AV

OE - *Front axle repair kit*

Sans visserie Without screws and bolts



1.2i 16v.	C/BB05/0W/11/2T/2U/2V	CB19
1.4	C/BB0C	BB0S BVA
1.4 Equipement E2/E3	CB0S	BVA
1.4 Sauf équipement ES2	CB0S	09/99-
1.5 DCi /Comm.	C/B/SB07	-06/01
1.5 DCi	CB1W	
1.6	BB00	
1.6 Equipements E2/E3/E5	C/BB0D	
1.9 D /Comm.	C/B/SB0E/OJ	BB02
1.9 D Comm.	SB0R	

... Clio II 03/98- ...





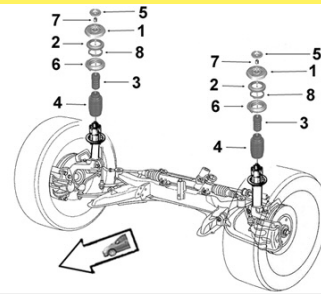

Support d'amortisseur
 Suspension mounting
 Soporte amortiguador
 Poduszka amortyzatora
 Опора амортизатора



RENAULT



4001620 Coupelle rebond.	
OE 7700426450 <i>Spring cup</i>	
	<p>5 1.2i /Comm. C/B/SB0A/0F/10/1K/2D/2H 1.2i 16v. C/BB05/0W/11/19/2T/2U/2V 1.4i /16v. C/BB0B/0C/0S/17 C/BB0L/0P/13/1L 1.5 DCi /Comm. C/BB07/08/1W/2G SB07/08/09 1.6i C/BB0D BB00 1.6i 16v./ Comm. BB1J/1R/2K C/BB01/0H/0T/14/1D SB0H 1.9 D /Comm. C/B/SB0E/0J BB02 SB0R 1.9 DTi /Comm. C/B/SB0U C/BB 0V/2C 2.0i 16v. CB0M/15/1C/1G/1N/1S/1T/20/21/22/2P</p>
4001615 Tampon suspension G/D	
OE 7700829529 <i>L/R susp. rebound stop</i>	
	<p>1 1.2i /Comm. C/B/SB0A/0F/10/1K/2D/2H 1.2i 16v. C/BB05/0W/11/19/2T/2U/2V 1.4i /16v. C/BB0B/0C/0S/17 C/BB0L/0P/13/1L 1.5 DCi /Comm. C/BB07/08/1W/2G SB07/08/09 1.6i C/BB0D BB00 1.6i 16v. /Comm. BB1J/1R/2K C/BB01/0H/0T/14/1D SB0H 1.9 D /Comm. C/B/SB0E/0J BB02 SB0R 1.9 DTi /Comm. C/B/SB0U C/BB 0V/2C</p>
4001647 Tampon suspension G/D	
OE 6000073600 <i>L/R susp. rebound stop</i>	
	<p>1 2.0i 16v. CB0M/15/1C/1G/1N/1S/1T/20/21/22/2P</p>
4005300 Butée à billes G/D	
OE 8200651172 <i>L/R ball bearing</i>	
	<p>2 1.2i /Comm. C/B/SB0A/0F/10/1K/2D/2H 1.2i 16v. C/BB05/0W/11/19/2T/2U/2V 1.4i /16v. C/BB0B/0C/0S/17 C/BB0L/0P/13/1L 1.5 DCi /Comm. C/BB07/08/1W/2G SB07/08/09 1.6i C/BB0D BB00 1.6i 16v. /Comm. BB1J/1R/2K C/BB01/0H/0T/14/1D SB0H 1.9 D /Comm. C/B/SB0E/0J BB02 SB0R 1.9 DTi /Comm. C/B/SB0U C/BB 0V/2C 2.0i 16v. CB0M/15/1C/1G/1N/1S/1T/20/21/22/2P</p>
4001614 Protecteur amortisseur G/D	
OE 7700428440 <i>L/R shock absorber protector</i>	
	<p>3 1.2i sauf types SB2D/2H 4 1.2i 16v. sauf types BB19 C/BB2V LB11/19/2V 1.4i sauf types CB0S équipement ES2 & LB03/0B/17 1.4i 16v. sauf types C/BB0L équipements ES2 & C/BB13/1L équipements ES 1.4i 16v. sauf types BB0P & LB0K/0L/13/2A/2B 1.4i 16v. sauf types CB0P équipements ES/ ES2 1.5 DCi sauf types C/BB1W LB07/1W/23/24/2E 1.6i sauf types B/LB 00 C/BB 0D équipement ES2 1.6i 16v. sauf types BB01/1J/1R/2K & CB01 LB01/18/1B/1J/1V 1.6i 16v. sauf types BB1D CB1D équipement ES & CB0H/0T équipement ES3 1.9 D sauf types B/LB 02 1.9 DTi sauf types C/BB 0U/0V équipement ES2</p>

... Clio II 03/98-



Support d'amortisseur
 Suspension mounting
 Soporte amortiguador
 Poduszka amortyzatora
 Опора амортизатора

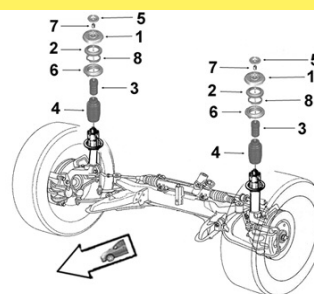

RENAULT

SASIC

4005379 Protecteur amortisseur G/D

OE 7700434126 L/R shock absorber protector



3
4

1.4i	Equipement ES2	CB0S
1.4i 16v.	Equipement ES	C/BB13/ 1L
1.4i 16v.	Equipement ES/ES2	C/BB0P
1.6i	Equipement ES2	C/BB0D
1.6i 16v.	Equipement ES	C/BB1D
1.6i 16v.	Equipement ES3	CB0H/0T
1.9 DTi	Equipement ES2	C/BB0U/0V
2.0i 16v.		CB0M/15/1C/1G/1N/1S CB1T/20/21/22/2P

4005229 Kit rép. suspension G ou D

OE - L/R stabilizing bar repair kit



1.2 /Comm.	C/B/SB0A/0F/10/1K/2D/2H
1.2i 16v.	C/BB05/0W/11/19/2T/2U/2V
1.4i /16v.	C/BB0B/0C/0S/17 C/BB0L/0P/13/1L
1.5 DCi /Comm.	C/BB07/08/1W/2G SB07/08/09
1.6	C/BB0D BB00
1.6i 16v. /Comm.	C/BB01/0H/0T/14/1D BB1J/1R/2K SB0H
1.9 D /Comm.	C/B/SB0E/0J BB02
1.9 D Comm.	SB0R
1.9 DTi /Comm.	C/B/SB0U C/BB 0V/2C

Eléments TRAIN ARRIERE

Rear axle parts
 Tren TRAS
 Elementy zawieszenia tylnego
 элементы задней оси.



4003324 Articulation AR

OE 8200042594 Rear bush



Ø int.10.3 Ø ext.45.2 coll.65.5 long. tube int.73 ext.51.3 ep. coll.14.6

1.2i /Comm.	C/B/SB0A/0F/10/1K/2D/2H
1.2i 16v.	C/BB05/0W/19/2T/2U/2V
1.2i 16v.	C/BB11 06/01-
1.4i	C/BB 0B/0C/0S/17
1.4i 16v.	C/BB 0L/0P/13/1L
1.5 DCi /Comm.	C/BB07/08/1W/2G SB07/08/09
1.6i	BB00/0D CB0D
1.6i 16v. /Comm.	BB01/0H/0T/14/1D/1J/1R/2K CB01/0H/0T/14/1D SB0H
1.9 D /Comm.	BB02/0E/0J CB0E/0J SB0E/0J/0R
1.9 DTi /Comm.	C/BB 0U/0V/2C SB0U

4005527 Articulation AR

OE 6000073602 Rear bush



Ø int.10 Ø ext.45 coll.65 long. tube int.73 ext.50 ep. coll.15

2.0i 16v.	CB0M/15/1C/1G/1N/1S/1T/20/21/22/2P
-----------	------------------------------------

Clio III 09/05- ...

Eléments DIRECTION
Steering parts
Elementos Direcciones
Elementy układ kierowniczy
Элементы рулевой системы

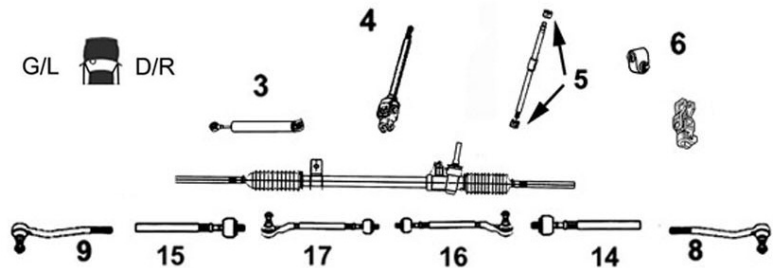

3008241

Axe de bielle G/D

Part/oe 7701475841

L/R axial joint



14 Côté dir. M14x1.5 Côté rot. M14x1.5 long 304 mm
 15

1.2i 16v.	BR01/2/3/4/E/J/P/R/S BR1D/L/U/1/9 BR21
1.2i 16v.	CR02/3/4/E/J/P/R/S CR11/L/U CR21
1.2i 16v.	KR02/4/E/J/P/S KR1U KR21 SR0J/P/S SR1U SR21
1.4i 16v.	BR00/A BR1E/W CR00/A CR1E KR00/A
1.5 DCi	BR0F/G/H/V/W BR17/A/B/C/F/G/H/N/S/T/V
1.5 DCi	CR0F/G/H/V/W CR17/A/B/C/F/G/H/N/S/T/V
1.5 DCi	KR0F/G/H KR17/A/B/C/H/N/S/T/V SR0F/G/H SR17/H/N/S/T/V
1.6i 16v.	BR05/9/B/T/Y BR10/5/6/J/M/Y BR20
1.6i 16v.	CR05/9/B/T/Y CR1M/J/Y/0/5/6 CR20 KR09/B KR10/6
2.0i 16v.	BR0C/K CR0C/K

4006134

Rotule de direction G

OE 7701475842

Left tie rod end



9

1.2i 16v.	BR01/2/3/4/E/J/P/R/S BR1D/L/U/1/9 BR21
1.2i 16v.	CR02/3/4/E/J/P/R/S CR11/L/U CR21
1.2i 16v.	KR02/4/E/J/P/S KR1U KR21 SR0J/P/S SR1U SR21
1.4i 16v.	BR00/A BR1E/W CR00/A CR1E KR00/A
1.5 DCi	BR0F/G/H/V/W BR17/A/B/C/F/G/H/N/S/T/V
1.5 DCi	CR0F/G/H/V/W CR17/A/B/C/F/G/H/N/S/T/V
1.5 DCi	KR0F/G/H KR17/A/B/C/H/N/S/T/V SR0F/G/H SR17/H/N/S/T/V
1.6i 16v.	BR05/9/B/T/Y BR10/5/6/J/M/Y BR20
1.6i 16v.	CR05/9/B/T/Y CR1M/J/Y/0/5/6 CR20 KR09/B KR10/6
2.0i 16v.	BR0C/K CR0C/K

4006135

Rotule de direction D

OE 7701475843

Right tie rod end



8

1.2i 16v.	BR01/2/3/4/E/J/P/R/S BR1D/L/U/1/9 BR21
1.2i 16v.	CR02/3/4/E/J/P/R/S CR11/L/U CR21
1.2i 16v.	KR02/4/E/J/P/S KR1U KR21 SR0J/P/S SR1U SR21
1.4i 16v.	BR00/A BR1E/W CR00/A CR1E KR00/A
1.5 DCi	BR0F/G/H/V/W BR17/A/B/C/F/G/H/N/S/T/V
1.5 DCi	CR0F/G/H/V/W CR17/A/B/C/F/G/H/N/S/T/V
1.5 DCi	KR0F/G/H KR17/A/B/C/H/N/S/T/V SR0F/G/H SR17/H/N/S/T/V
1.6i 16v.	BR05/9/B/T/Y BR10/5/6/J/M/Y BR20
1.6i 16v.	CR05/9/B/T/Y CR1M/J/Y/0/5/6 CR20 KR09/B KR10/6
2.0i 16v.	BR0C/K CR0C/K

4006161

Rotule de direction G

OE 7701474795

Left tie rod end



9

2.0i 16v. RS CR0N CR1P/18

4006159

Rotule de direction D

OE 7701474796

Right tie rod end



8

2.0i 16v. RS CR0N CR1P/18

... Clio III 09/05- ...



Barre stabilisatrice
 Stabilizer bar
 Barra estabilizadora
 Drążek stabilizatora
 стабилизатор поперечной устойчивости

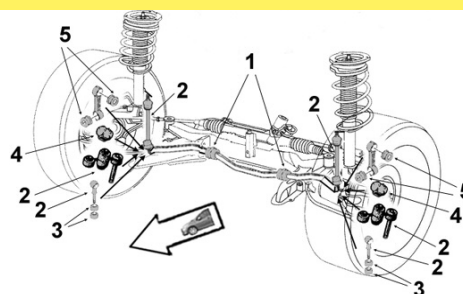

RENAULT



4005147

Biellette barre stab.

OE 8200605381

Stabilizer bar stub axle



2 Entraxe : 250 mm M10x150 X2

1.2i 16v.	BR01/2/3/4/E/J/P/R/S BR1D/L/U/1/9 BR21 CR02/4/E/J/P/R/S CR11	-28/04/10
1.2i 16v.	KR02/4/E/J/P/S KR1U KR21 SR0J/P/S SR1U SR21	-28/04/10
1.4i 16v.	BR00/A BR1E/1W CR00/A CR1E KR00/A	-28/04/10
1.5 DCi	BR0F/G/H/V/W BR17/A/B/C/F/G/H/N/S/T/V CR0F/G/H/V/W CR17/A/C/F/G/NT	-28/04/10
1.5 DCi	KR0F/G/H KR17/A/B/C/H/N/S/T/V SR0F/G/H SR17/H/N/S/T/V	-28/04/10
1.6i 16v.	BR05/9/B/T/Y BR10/5/6/J/M/Y BR20 CR09/B/Y CR1M/Y/0/5	-28/04/10
1.6i 16v.	KR09/B KR10/6	-28/04/10
2.0i 16v.	BR0C/K CR0C/K M4R	-28/04/10

4005141

Biellette barre stab.

OE 8200661217

Stabilizer bar stub axle



2

2.0i 16v. RS CR0N/1P CR18

4005150

Palier de barre milieu

OE 7701056678

Middle bar main bearing



1

Ø 19.5

2.0i 16v. RS CR1P

2304028

Palier de barre milieu

OE 7701062549

Middle bar main bearing



1

Ø 20.5

1.2i 16v.	BR01/02/03/0E/0J/0R/0S/1D/1L/0P/11/1U/04/19	
1.2i 16v.	CR02/0E/0J/0R/0S/0P/11/1U/04/21 SR0J/0P/1U/0S/21	
1.4i 16v.	BR00/0A/1E/1W CR00/0A/1E	
1.5 DCi	Sauf équipement EAG B/CR0H BR1S	05/09-
1.5 DCi	Sauf équipement EAG CR1S	
1.5 DCi	BR0F/0G/0V/0W/1A/1B/1C/1F/1G/1N/1T/17/1H/1V	
1.5 DCi	CR0F/0G/0V/0W/1G/1N/1A/1B/1F/1T/17/1H/1V CR1C	
1.5 DCi	SR0F/0G/0H/1N/17/1H/1V/1S/1T	
1.6i 16v.	Sauf équipement EAG BR10/20	05/09-
1.6i 16v.	Sauf équipement EAG CR10	
1.6i 16v.	BR05/09/0B/0Y/1J/1M/15/0T/16/1Y	
1.6i 16v.	CR09/0B/0Y/1M/15/16/1J/1Y CR20	
2.0i 16v.	Sauf équipement EAG B/CR0C	05/09-
2.0i 16v.	B/CR0K	

2304015

Palier de barre milieu

OE 7701059672

Middle bar main bearing



1

Ø 21

1.2i 16v. Estate	KR02/0E/0J/0P/1U/04/0S/21	
1.4i 16v. Estate	KR00/0A	
1.5 DCi Estate	KR0F/0G/0H/1A/1B/1C/1N/17/1H/1S/1T/1V	
1.6i 16v. Estate	KR09/0B/10/16	
2.0i 16v. RS	CR0N	05/09-

... Clio III 09/05- ...

2304016
Palier de barre milieu

OE 7701059966

Middle bar main bearing

1	Ø21			
	1.5 DCi	Equipement EAG	B/CR0H BR1S	05/09-
	1.5 DCi		CR1C	
	1.5 DCi	Equipement EAG	CR1S	
	1.6i 16v.	Equipement EAG	BR10/20	05/09-
	1.6i 16v.	Equipement EAG	CR10	
	1.6i 16v.		CR20	
2.0i 16v.	Equipement EAG	B/CR0C	05/09-	

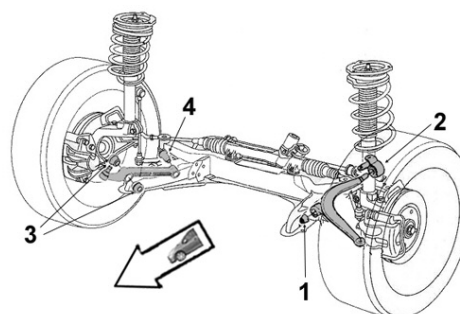
Eléments SUSPENSION
Suspension parts
Elementos suspensión
Elementy zawieszenia
Элементы подвески

4001585
Articulation AV

Part/oe 8200744091

Front bush

1	Ø int.12 Ø ext.36 coll.40 long. tube int.55 ext.39 ep. coll.5X2		
	1.2i 16v. 3ptes	CR02/0E/0J/0R/0S/0P/11/1U/04	
	1.2i 16v. 5ptes	BR01/02/03/0E/0J/0R/0S/1D/1L/0P/11/1U/04/19	
	1.2i 16v. Comm.	SR0J/0P/1U	
	1.2i 16v. Estate	KR02/0E/0J/0P/1U/04/0S	
	1.4i 16v. 3ptes	CR00/0A/1E	
	1.4i 16v. 5ptes	BR00/0A/1E/1W	
	1.4i 16v. Estate	KR00/0A	
	1.5 DCi 3ptes	CR0F/0G/0H/0V/0W/1C/1G/1N/1A/1B/1F/1T/17/1H/1S/1V	
	1.5 DCi 5ptes	BR0F/0G/0H/0V/0W/1A/1B/1C/1F/1G/1N/1T/17/1H/1S/1V	
	1.5 DCi Comm.	SR0F/0G/0H/1N/17/1H/1V	
	1.5 DCi Estate	KR0F/0G/0H/1A/1B/1C/1N/17/1H/1S/1T/1V	
	1.6i 16v. 3ptes	CR09/0B/0Y/1M/10/15/16/1J/1Y/20	
	1.6i 16v. 5ptes	BR05/09/0B/0Y/1J/1M/10/15/0T/16/1Y/20	
	1.6i 16v. Estate	KR09/0B/10/16	
	2.0i 16v. 3ptes	CR0C/0K	
2.0i 16v. 5ptes	BR0C/0K		

4001584
Articulation AR

Part/oe 8200744091

Rear bush

2	Ø int.12 Ø ext.58 long. tube int.53 ext.27		
	1.2i 16v. 3ptes	CR02/0E/0J/0R/0S/0P/11/1U/04	
	1.2i 16v. 5ptes	BR01/02/03/0E/0J/0R/0S/1D/1L/0P/11/1U/04/19	
	1.2i 16v. Comm.	SR0J/0P/1U	
	1.2i 16v. Estate	KR02/0E/0J/0P/1U/04/0S	
	1.4i 16v. 3ptes	CR00/0A/1E	
	1.4i 16v. 5ptes	BR00/0A/1E/1W	
	1.4i 16v. Estate	KR00/0A	
	1.5 DCi 3ptes	CR0F/0G/0H/0V/0W/1C/1G/1N/1A/1B/1F/1T/17/1H/1S/1V	
	1.5 DCi 5ptes	BR0F/0G/0H/0V/0W/1A/1B/1C/1F/1G/1N/1T/17/1H/1S/1V	
	1.5 DCi Comm.	SR0F/0G/0H/1N/17/1H/1V	
	1.5 DCi Estate	KR0F/0G/0H/1A/1B/1C/1N/17/1H/1S/1T/1V	
	1.6i 16v. 3ptes	CR09/0B/0Y/1M/10/15/16/1J/1Y/20	
	1.6i 16v. 5ptes	BR05/09/0B/0Y/1J/1M/10/15/0T/16/1Y/20	
	1.6i 16v. Estate	KR09/0B/10/16	
	2.0i 16v. 3ptes	CR0C/0K	
2.0i 16v. 5ptes	BR0C/0K		

... Clio III 09/05- ...

SASIC

RENAULT

Bras & Triangle de suspension

Control arm
Brazo y triángulo
Wahacz
Рычаг подвески

G/L  D/R



4003215

Triangle de susp. G

Part/oe 8200744091

Left track control arm



4 Sans rotule Without ball joint

1.2i 16v.	BR01/2/3/4/E/J/P/R/S BR1D/L/U/1/9 BR21
1.2i 16v.	CR02/4/E/J/P/R/S CR11/U CR21
1.2i 16v.	KR02/4/E/J/P/S KR1U KR21 SR0J/P/S SR1U SR21
1.4i 16v.	BR00/A BR1E/W CR00/A CR1E KR00/A
1.5 DCi	BR0F/G/H/V/W BR17/A/B/C/F/G/H/N/S/T/V
1.5 DCi	CR0F/G/H/V/W CR17/A/B/C/F/G/H/N/S/T/V
1.5 DCi	KR0F/G/H KR17/A/B/C/H/N/S/T/V SR0F/G/H SR17/H/N/S/T/V
1.6i 16v.	BR05/9/B/T/Y BR10/5/6/J/M/Y BR20
1.6i 16v.	CR09/B/Y CR1M/Y/0/5/6 CR20
1.6i 16v.	KR09/B KR10/6
2.0i 16v.	BR0C/K CR0C/K

4003216

Triangle de susp. D

Part/oe 8200744092

Right track control arm



3 Sans rotule Without ball joint

1.2i 16v.	BR01/2/3/4/E/J/P/R/S BR1D/L/U/1/9 BR21
1.2i 16v.	CR02/4/E/J/P/R/S CR11/U CR21
1.2i 16v.	KR02/4/E/J/P/S KR1U KR21 SR0J/P/S SR1U SR21
1.4i 16v.	BR00/A BR1E/W CR00/A CR1E KR00/A
1.5 DCi	BR0F/G/H/V/W BR17/A/B/C/F/G/H/N/S/T/V
1.5 DCi	CR0F/G/H/V/W CR17/A/B/C/F/G/H/N/S/T/V
1.5 DCi	KR0F/G/H KR17/A/B/C/H/N/S/T/V SR0F/G/H SR17/H/N/S/T/V
1.6i 16v.	BR05/9/B/T/Y BR10/5/6/J/M/Y BR20
1.6i 16v.	CR09/B/Y CR1M/Y/0/5/6 CR20 KR09/B KR10/6
2.0i 16v.	BR0C/K CR0C/K

7474016

Triangle de susp. G

OE 8200744091

Left track control arm

NEW



4 Avec rotule With ball joint Ø 18

1.2i 16v.	BR01/2/3/4/E/J/P/R/S BR1D/L/U/1/9 BR21
1.2i 16v.	CR02/4/E/J/P/R/S CR11/U CR21
1.2i 16v.	KR02/4/E/J/P/S KR1U KR21 SR0J/P/S SR1U SR21
1.4i 16v.	BR00/A BR1E/W CR00/A CR1E KR00/A
1.5 DCi	BR0F/G/H/V/W BR17/A/B/C/F/G/H/N/S/T/V
1.5 DCi	CR0F/G/H/V/W CR17/A/B/C/F/G/H/N/S/T/V
1.5 DCi	KR0F/G/H KR17/A/B/C/H/N/S/T/V SR0F/G/H SR17/H/N/S/T/V
1.6i 16v.	BR05/9/B/T/Y BR10/5/6/J/M/Y BR20
1.6i 16v.	CR09/B/Y CR1M/Y/0/5/6 CR20 KR09/B KR10/6
2.0i 16v.	BR0C/K CR0C/K

7474015

Triangle de susp. D

OE 8200744092

Right track control arm

NEW



3 Avec rotule With ball joint Ø 18

1.2i 16v.	BR01/2/3/4/E/J/P/R/S BR1D/L/U/1/9 BR21
1.2i 16v.	CR02/4/E/J/P/R/S CR11/U CR21
1.2i 16v.	KR02/4/E/J/P/S KR1U KR21 SR0J/P/S SR1U SR21
1.4i 16v.	BR00/A BR1E/W CR00/A CR1E KR00/A
1.5 DCi	BR0F/G/H/V/W BR17/A/B/C/F/G/H/N/S/T/V
1.5 DCi	CR0F/G/H/V/W CR17/A/B/C/F/G/H/N/S/T/V
1.5 DCi	KR0F/G/H KR17/A/B/C/H/N/S/T/V SR0F/G/H SR17/H/N/S/T/V
1.6i 16v.	BR05/9/B/T/Y BR10/5/6/J/M/Y BR20
1.6i 16v.	CR09/B/Y CR1M/Y/0/5/6 CR20 KR09/B KR10/6
2.0i 16v.	BR0C/K CR0C/K

... Clio III 09/05- ...

7574003

Rotule de susp. inf. G/D

OE 401604793R

L/R lower suspension ball joint



1
2 Ø 18

1.2i 16v.	BR01/2/3/4/E/J/P/R/S BR1D/L/U/1/9 BR21
1.2i 16v.	CR02/4/E/J/P/R/S CR11/U CR21
1.2i 16v.	KR02/4/E/J/P/S KR1U KR21 SR0J/P/S SR1U SR21
1.4i 16v.	BR00/A BR1E/W CR00/A CR1E KR00/A
1.5 DCi	BR0F/G/H/V/W BR17/A/B/C/F/G/H/N/S/T/V
1.5 DCi	CR0F/G/H/V/W CR17/A/B/C/F/G/H/N/S/T/V
1.5 DCi	KR0F/G/H KR17/A/B/C/H/N/S/T/V SR0F/G/H SR17/H/N/S/T/V
1.6i 16v.	BR05/9/B/T/Y BR10/5/6/J/M/Y BR20
1.6i 16v.	CR09/B/Y CR1M/Y/0/5/6 CR20 KR09/B KR10/6
2.0i 16v.	BR0C/K CR0C/K



Support d'amortisseur

Suspension mounting

Soporte amortiguador

Poduszka amortyzatora

Опора амортизатора

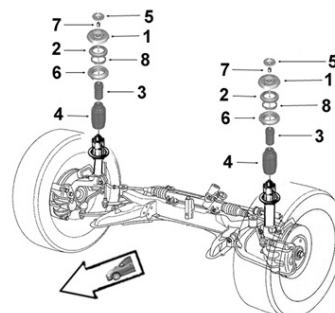

4001634

Support suspension G

OE 8200504291

Left suspension mounting



1

1.2i 16v. 3/5ptes	BR1S/CS B/CR 1R/CR	D4F740	BVM	03/09-
1.2i 16v. 3/5ptes	B/CR 1J/CJ	D4F740	BVM	09/05-
1.2i 16v. 3/5ptes	B/CR 1E/CE	D4F764	BV robotisée	09/06-03/09
1.2i 16v. Estate	KR1J/1S/CJ/CS	D4F740	BVM	
1.2i 16v. Estate	KR1E/CE	D4F764	BV robotisée	01/08-03/09
1.2i 16v. ETH 3/5ptes	B/CR EU/FU	D4F742	BVM	01/08-
1.2i 16v. Turbo 3/5ptes	B/CR 14/1P/C4/CP	D4F784	BVM	03/09-
1.2i 16v. Turbo 3/5ptes	B/CR 1P/CP	D4F784	BVM	04/07-03/09
1.2i 16v. Turbo Estate	KR14/1P/C4/CP	D4F784	BVM	
1.4i 16v. 3/5ptes	B/CR 1A/CA	K4J780	BVM	09/05-09/07
1.5 DCi 3/5ptes	B/CR 1H/CH	K9K764	BVM	09/05-
1.5 DCi 3/5ptes	B/CR 1F/CF	K9K766		09/06-
1.5 DCi 3/5ptes	B/CR1 G/CG	K9K768	BVM	09/05-
1.5 DCi FAP 3/5ptes	B/CR 2C/AC	K9K772	BVM	07/06-
1.5 DCi Estate	KR1H/CH	K9K764	BVM	01/08-
1.5 DCi Estate	KR1F/CF	K9K766		01/08-
1.5 DCi Estate	KR1G/CG	K9K768	BVM	01/08-
1.5 DCi FAP Estate	KR2C/AC	K9K772	BVM	01/08-
1.6i 16v.		K4M804	BVM	09/05-03/09
1.6i 16v. 3/5ptes	B/CR 1B/CB	K4M800	BVM	09/05-03/09
1.6i 16v. 3/5ptes	B/CR 1B/26/A6/CB	K4M801	BVA	09/05-
1.6i 16v. 3/5ptes	B/CR 20/A0/R0	K4M862	BVM	03/09-
1.6i 16v. Estate	KR1B/CB	K4M800	BVM	01/08-03/09
1.6i 16v. Estate	KR1B/CB	K4M801	BVA	03/09-
1.6i 16v. Estate	KR20/A0	K4M801	BVA	01/08-03/09
1.6i 16v. Estate	KRCC/CK	K4M862	BVM	03/09-
2.0i 16v. 3/5ptes	B/CR 0C/0K	M4R700/01		09/06-03/09
2.0i 16v. RS	CRJN/K8	F4R832	BVM	06/09-
2.0i 16v. RS	CR1N	F4R830	BVM	03/06-03/09

... Clio III 09/05- ...



Support d'amortisseur
 Suspension mounting
 Soporte amortiguador
 Poduszka amortyzatora
 Опора амортизатора

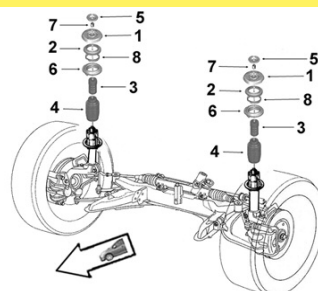

RENAULT

4001635

Support suspension D

OE 8200504295

Right suspension mounting



1

1.2i 16v. 3/5ptes	BR1S/CS B/CR 1R/CR	D4F740 BVM	03/09-
1.2i 16v. 3/5ptes	B/CR 1J/CJ	D4F740 BVM	09/05-
1.2i 16v. 3/5ptes	B/CR 1E/CE	D4F764 BV robotisée	09/06-03/09
1.2i 16v. Estate	KR1J/1S/CJ/CS	D4F740 BVM	
1.2i 16v. Estate	KR1E/CE	D4F764 BV robotisée	01/08-03/09
1.2i 16v. ETH 3/5ptes	B/CR EU/FU	D4F742 BVM	01/08-
1.2i 16v. Turbo 3/5ptes	B/CR 14/1P/C4/CP	D4F784 BVM	03/09-
1.2i 16v. Turbo 3/5ptes	B/CR 1P/CP	D4F784 BVM	04/07-03/09
1.2i 16v. Turbo Estate	KR14/1P/C4/CP	D4F784 BVM	
1.4i 16v. 3/5ptes	B/CR 1A/CA	K4J780 BVM	09/05-09/07
1.5 DCi 3/5ptes	B/CR 1H/CH	K9K764 BVM	09/05-
1.5 DCi 3/5ptes	B/CR 1F/CF	K9K766	09/06-
1.5 DCi 3/5ptes	B/CR 1G/CG	K9K768 BVM	09/05-
1.5 DCi FAP 3/5ptes	B/CR 2C/AC	K9K772 BVM	07/06-
1.5 DCi Estate	KR1H/CH	K9K764 BVM	01/08-
1.5 DCi Estate	KR1F/CF	K9K766	01/08-
1.5 DCi Estate	KR1G/CG	K9K768 BVM	01/08-
1.5 DCi FAP Estate	KR2C/AC	K9K772 BVM	01/08-
1.6i 16v.		K4M804 BVM	09/05-03/09
1.6i 16v. 3/5ptes	B/CR 1B/CB	K4M800 BVM	09/05-03/09
1.6i 16v. 3/5ptes	B/CR 1B/26/A6/CB	K4M801 BVA	09/05-
1.6i 16v. 3/5ptes	B/CR 20/A0/R0	K4M862 BVM	03/09-
1.6i 16v. Estate	KR1B/CB	K4M800 BVM	01/08-03/09
1.6i 16v. Estate	KR1B/CB	K4M801 BVA	03/09-
1.6i 16v. Estate	KR20/A0	K4M801 BVA	01/08-03/09
1.6i 16v. Estate	KRCC/CK	K4M862 BVM	03/09-
2.0i 16v. 3/5ptes	B/CR 0C/0K	M4R700/01	09/06-03/09
2.0i 16v. RS	CRJN/K8	F4R832 BVM	06/09-
2.0i 16v. RS	CR1N	F4R830 BVM	03/06-03/09

2654035

Support suspension

OE 543024644R

Suspension mounting

NEW



1

1.2i 16v.	BR0R/0S/02/1D/1U/1L/11/19/21/23	D4F740/42/44	06/10-
1.2i 16v.	BR0E/0P01/03/04	D4F764/84/86	06/10-
1.2i 16v.	CR0J/0R/0S/02/1U/11/21/23	D4F740/42/44	06/10-
1.2i 16v.	CR0E/0P/04	D4F764/84/86	06/10-
1.2i 16v.	SR0J/0P/0S/1U/21/23	D4F740/42/84	06/10-
1.2i 16v.	KR0E/0J/0P/0S/02/04/1U/21	D4F740/42/44/84/88	16/03/10-
1.4i 16v.	BR0A/00/1E/1W CR0A/1E/00	K4J780	06/10-
1.4i 16v.	KR0A/00	K4J780	16/03/10-
1.5 DCi	KR0F/0G/0H/1A/1B/1T/17	K9K750/52/764/66/68	16/03/10-
1.5 DCi	KR1C/1H/1N/1S/1V	K9K770/72/74	16/03/10-
1.5 DCi	BR0V/0W/1A/1B/1F/1G	K9K750/52	06/10-
1.5 DCi	BR0F/0G/0H/1T/17	K9K764/66/68	06/10-
1.5 DCi	BR1C/1H/1N/1S/1V	K9K770/72/74	06/10-
1.5 DCi	CR0V/0W/1A/1B/1F/1G	K9K50/52	06/10-
1.5 DCi	C/SR0F/0G/0H/1T/17	K9K764/66/68	06/10-
1.5 DCi	CR1C C/SR1H/1N/1S/1V	K9K770/72/74	06/10-
1.6i 16v.	BR0B/0Y/05/15/16/1J/1M/1Y	K4M800/01	06/10-
1.6i 16v.	BR0T/09/10/20	K4M804/62	06/10-
1.6i 16v.	CR0B/0Y/1M/1Y/15/16	K4M800/01	06/10-
1.6i 16v.	CR0T/09/10/20	K4M804/62	06/10-
1.6i 16v.	KR0B/09/10/16	K4M800/01/04/62	16/03/10-
2.0i 16v.	BR0C CR0C/0K	M4R700/01	06/10-
2.0i 16v.	CR0N/1P/18	F4R830/32	06/10-

... Clio III 09/05-

RENAULT



... Clio III 09/05-					
2654030	Butée à billes G/D				
OE 543259539R	<i>L/R ball bearing</i>				
<div style="background-color: yellow; border-radius: 50%; padding: 2px; display: inline-block;">NEW</div> 	2	1.2i 16v. B/CR02/J/R/S/11/U/21/23 BR19/D/L 1.2i 16v. B/CR04/0E/0P BR01/03 1.2i 16v. SR0J/0P/0S/1U/21/23 1.2i 16v. KR02/0J/0S/1U/21 1.2i 16v. KR04/0E/0P 1.4i 16v. B/CR00/0A/1E BR1W 1.4i 16v. KR00/0A 1.5 DCi B/CR0F/0H/0V/0W/17/1A/1B/1F/1G 1.5 DCi B/CR0G/1C/1H/1N/1S/1T/1V 1.5 DCi SR0F/0G/0H/17/1T 1.5 DCi SR1H/1N/1S/1V 1.5 DCi KR0F/0H/17/1A/1B 1.5 DCi KR0G/1C/1H/1N/1S/1T/1V 1.6i 16v. B/CR0B/0Y/15/16/1M/1Y BR05/1J 1.6i 16v. B/CR09/0T/10/20 1.6i 16v. KR09/0B/10/16 2.0i 16v. B/CROC/OK 2.0i 16v. RS CR0N/18/1P	D4F740/42/44 24/06/10- D4F764/84/86 24/06/10- D4F740/42/84 06/10- D4F740/42/44 16/03/10- D4F764/84/86/88 16/03/10- K4J780 24/06/10- K4J780 16/03/10- K9K750/52/64/66 24/06/10- K9K768/70/72/74 24/06/10- K9K764/66/68 06/10- K9K770/72/74 06/10- K9K750/52/64/66 16/03/10- K9K768/70/72/74 16/03/10- K4M800/01 24/06/10- K4M804/62 24/06/10- K4M800/01/04/62 16/03/10- M4R700/01 24/06/10- F4R830/32 24/06/10-		
2654007	Butée protecteur susp.				
OE 8200127285	<i>Suspension bush</i>				
	3 4	1.2i 16v. 1.4i 16v. 3/5ptes C/BR1A/CA 1.5 DCi Berline 1.5 DCi Break 1.6i 16v. Berline 1.6i 16v. Break 2.0i 16v. 3/5ptes B/CR 0C/OK 2.0i 16v. 3/5ptes B/CR 0C/OK	D4F 09/05-05/10 K4J780 BVM 09/05-09/07 K9K 09/05-24/06/10 K9K 09/05-09/03/11 K4M 09/05-24/06/10 K4M 09/05-09/03/11 M4R700/02 BVM 09/06-03/09 M4R701/03 BVA 09/06-03/09		
2654016	Butée protecteur susp.		2654017	Butée protecteur susp.	
OE 8200463368	<i>Suspension bush</i>		OE 8200747691	<i>Suspension bush</i>	
	3 4	Sauf Pack Extrême 2.0i 16v. RS CR0N 2.0i 16v. RS CR1P -05/09		3 4	2.0i 16v. RS Pack Extrême CR0N 2.0i 16v. RS Pack Extrême CR1P -05/09 2.0i 16v. RS CR1P 05/09-02/07/10 2.0i 16v. RS CR18
2654032	Protecteur amortisseur G/D				
OE 543884315R	<i>L/R shock absorber protector</i>				
<div style="background-color: yellow; border-radius: 50%; padding: 2px; display: inline-block;">NEW</div> 	4	1.2i 16v. B/CR02/J/R/S/11/U/21/23 BR19/D/L 1.2i 16v. B/CR04/0E/0P BR01/03 1.2i 16v. SR0J/0P/0S/1U/21/23 1.2i 16v. KR02/0J/0S/1U/21 1.2i 16v. KR04/0E/0P 1.4i 16v. B/CR00/0A/1E BR1W 1.4i 16v. KR00/0A 1.5 DCi B/CR0F/0H/0V/0W/17/1A/1B/1F/1G 1.5 DCi B/CR0G/1C/1H/1N/1S/1T/1V 1.5 DCi SR0F/0G/0H/17/1T 1.5 DCi SR1H/1N/1S/1V 1.5 DCi KR0F/0H/17/1A/1B 1.5 DCi KR0G/1C/1H/1N/1S/1T/1V 1.6i 16v. B/CR0B/0Y/15/16/1M/1Y BR05/1J 1.6i 16v. B/CR09/0T/10/20 1.6i 16v. KR09/0B/10/16 2.0i 16v. B/CROC/OK 2.0i 16v. RS CR0N/18/1P	D4F740/42/44 24/06/10- D4F764/84/86 24/06/10- D4F740/42/84 06/10- D4F740/42/44 16/03/10- D4F764/84/86/88 16/03/10- K4J780 24/06/10- K4J780 16/03/10- K9K750/52/64/66 24/06/10- K9K768/70/72/74 24/06/10- K9K764/66/68 06/10- K9K770/72/74 06/10- K9K750/52/64/66 16/03/10- K9K768/70/72/74 16/03/10- K4M800/01 24/06/10- K4M804/62 24/06/10- K4M800/01/04/62 16/03/10- M4R700/01 24/06/10- F4R830/32 24/06/10-		

Clio IV 09/12- ...

Eléments DIRECTION

Steering parts

Elementos Direcciones

Elementy układ kierowniczy

Элементы рулевой системы

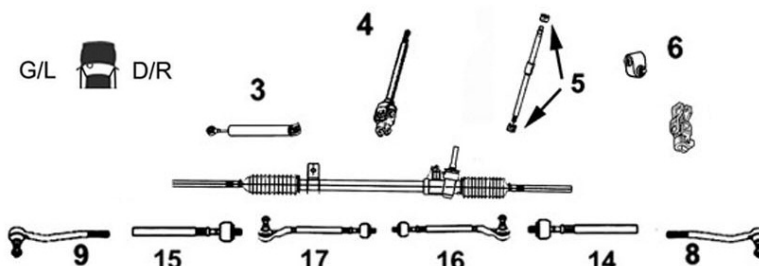

7674020

Rotule de direction G

OE 485200368R

Left tie rod end

NEW



9

M14 x 1.5

0.9i Turbo	Equipements E3T/EA1/EA2/EA4	BHMA
0.9i Turbo	Equipements E3T/EA1/EA2	BHMH KHMA
1.2 TCE	Equipements E3T/EA2/EA4/EAG	BHM0
1.2 TCE	Equipements E3T/EA2/EAG	KHM0
1.2i 16v.	Equipements E3T/EA1/EA2	BHMG/K KHMG
1.5 DCi	Equipements E3T/EA1/EA2/EA4	BHAL
1.5 DCi	Equipements E3T/EA1/EA2	BHM4/6/W KHAL/M4
1.5 DCi	Equipements E3T/EA2	BHML
1.5 DCi	Equipements E3T/EA2/EA4	KHML

7674021

Rotule de direction D

OE 485208355R

Right tie rod end

NEW



8

M14 x 1.5

0.9i Turbo	Equipements E3T/EA1/EA2/EA4	BHMA
0.9i Turbo	Equipements E3T/EA1/EA2	BHMH KHMA
1.2 TCE	Equipements E3T/EA2/EA4/EAG	BHM0
1.2 TCE	Equipements E3T/EA2/EAG	KHM0
1.2i 16v.	Equipements E3T/EA1/EA2	BHMG/K KHMG
1.5 DCi	Equipements E3T/EA1/EA2/EA4	BHAL
1.5 DCi	Equipements E3T/EA1/EA2	BHM4/6/W KHAL/M4
1.5 DCi	Equipements E3T/EA2	BHML
1.5 DCi	Equipements E3T/EA2/EA4	KHML

Bras & Triangle de suspension

Control arm

Brazo y triángulo

Wahacz

Рычаг подвески

G/L D/R

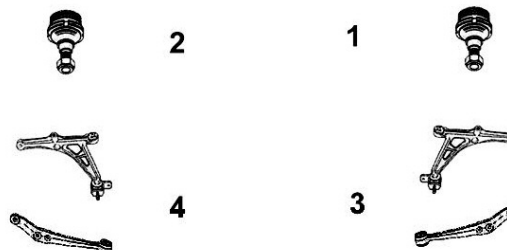

7474028

Triangle de susp. G

OE 545055711R

Left track control arm

NEW



4

Avec rotule With ball joint Ø 18

0.9i Turbo	BHMA/MH KHMA	10/12-
1.2 TCE	BHM0 KHM0	10/12-
1.2i	BHMG/MK KHMG	10/12-
1.5 DCi	BHAL/M4/ML	10/12-
1.5 DCi	BHM6/MW	10/12-
1.5 DCi	KHAL/M4/ML	10/12-
1.6i équipement ESG	BHMM	
Ch- F050284	Ch- R139430	05/13-

7474027

Triangle de susp. D

OE 545046817R

Right track control arm

NEW



3

Avec rotule With ball joint Ø 18

0.9i Turbo	BHMA/MH KHMA	10/12-
1.2 TCE	BHM0 KHM0	10/12-
1.2i	BHMG/MK KHMG	10/12-
1.5 DCi	BHAL/M4/ML	10/12-
1.5 DCi	BHM6/MW	10/12-
1.5 DCi	KHAL/M4/ML	10/12-
1.6i équipement ESG	BHMM	
Ch- F050284	Ch- R139430	05/13-

... Clio IV 09/12- ...



Support d'amortisseur
Suspension mounting
Soporte amortiguador
Poduszka amortyzatora
Опора амортизатора

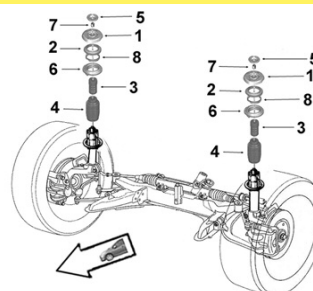

RENAULT



2654035

Support suspension

OE 543024644R

Suspension mounting

NEW



1	0.9i Turbo	BHMA/MH KHMA	07/12-
	1.2i	BHMG/MK KHMG	07/12-
	1.2i Turbo	BHM0 KHM0	07/12-
	1.5 DCi	KHAL/ML/M4	07/12-
	1.5 DCi	BHAL/ML/MW/M4/M6	07/12-
	1.6i	BHMM	07/12-

2654030

Butée à billes G/D

OE 543259539R

L/R ball bearing

NEW



2	0.9i Turbo	BHMA/MH KHMA	
	1.2i	BHMG/MK KHMG	
	1.2i Turbo	BHM0 KHM0	
	1.5 DCi	BHAL/M4/M6/ML/MW	
	1.5 DCi	KHAL/M4/ML	
	1.6i	BHMM	

2654033

Butée de suspension G/D

OE 540500558R

L/R suspension bush

NEW



3	Bague bleue Châssis sport 1		
	0.9i Turbo	BHMA/MH KHMA	07/12-
	1.2i	BHMG/MK	07/12-
	1.2i	KHMG	07/12-
	1.2i Turbo	BHM0 KHM0	07/12-
	1.5 DCi	BHAL/M4/M6/ML/MW	07/12-
	1.5 DCi	KHAL/M4/ML	07/12-
	1.6i	BHMM	07/12-

2654032

Protecteur amortisseur G/D

OE 543884315R

L/R shock absorber protector

NEW



4	0.9i Turbo	Châssis standard sauf susp. renforcée	BHMA/MH KHMA	09/12-
	0.9i Turbo	Châssis sport 1	BHMA/MH KHMA ch- R006404	09/12-
	1.2i	Châssis standard sauf susp. renforcée	BHMG/MK KHMG	09/12-
	1.2i	Châssis sport 1	BHMG/MK KHMG ch- R006404	09/12-
	1.2i Turbo	Châssis standard sauf susp. renforcée	BHM0 KHM0	09/12-
	1.2i Turbo	Châssis sport 1	BHM0 KHM0 ch- R006404	09/12-
	1.5 DCi	Châssis standard sauf susp. renforcée	BHAL/M4/M6/ML/MW KHAL/M4/ML	09/12-
	1.5 DCi	Châssis sport 1	BHAL/M4/M6/ML/MW KHAL/M4/ML ch-R006404	09/12-
	1.6i	Châssis standard sauf susp. renforcée	BHMM	09/12-
	1.6i	Châssis sport 1	BHMM ch- R006404	09/12-

... Clio IV 09/12-



Support d'amortisseur
 Suspension mounting
 Soporte amortiguador
 Poduszka amortyzatora
 Опора амортизатора

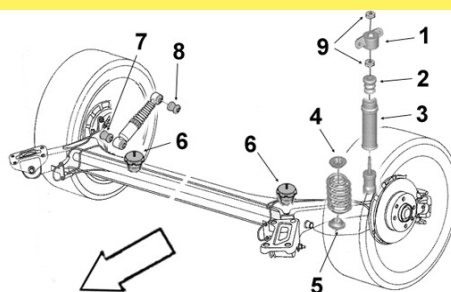

2654031 Butée protecteur susp. AR

OE 552402790R *Rear susp. bush*

NEW

3



1.6i équipement EAS BHMM

Espace J11/S11 ...

Eléments DIRECTION
 Steering parts
 Elementos Direcciones
 Elementy uklad kierowniczy
 Элементы рулевой системы

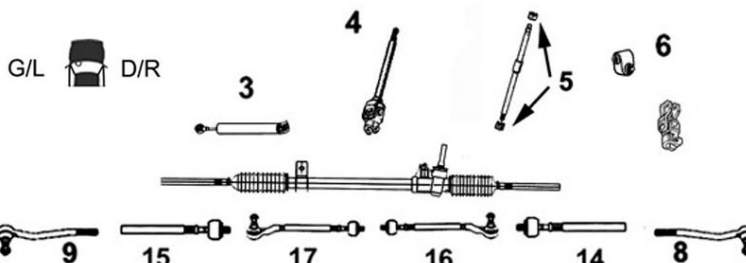

3008044 Axe de bielle G/D

OE - *L/R axial joint*



14 Côté dir. M12x1.0 Côté rot. M14x1.5
 15 long 220 mm

2.0	J/S112 J116
2.1 TD	J115 S115
2.2	J117

4006044B1 Bielle de direction G/D

OE 7701463025 *L/R steering rod*



16 M14 x 1.5
 17

2.0	J/S112 J116
2.1 TD	J115 S115
2.2	J117

4006112 Rotule de direction G/D

OE 7701469231 *L/R tie rod end*



8
 9 M14 x 1.5

2.0	J/S112 J116
2.1 TD	J115 S115
2.2	J117

4004009 Cardan colonne de direction

OE 6025107253 *Cardan joint*



7

2.0	J/S112 J116
2.1 TD	J115 S115
2.2	J117

4006138 Douille à aiguilles colonne

OE 7703090293 *Needle bearing*



5

2.0	J/S112 J116
2.1 TD	J115 S115
2.2	J117

... Espace J11/S11 ...



Barre stabilisatrice
 Stabilizer bar
 Barra estabilizadora
 Drążek stabilizatora
 стабилизатор поперечной устойчивости

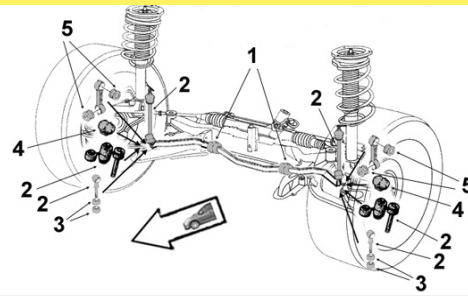

4005126

OE 7700710716

Biellette barre stab.

Stabilizer bar stub axle

2 Barre Ø 22 Dim. entraxe 149mm

TT /all models sauf J114 -12/87



4005127

OE 6025004756

Biellette barre stab.

Stabilizer bar stub axle

2 Barre Ø 21 Dim. Entraxe 131mm

TT /all models sauf J114 01/88-



Eléments SUSPENSION

Suspension parts
 Elementos suspensión
 Elementy zawieszenie
 Элементы подвески

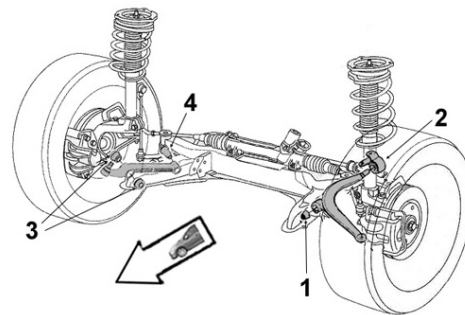

4001430

OE 7705040002

Articulation sup.

Upper bush

4 Ø int.14 Ø ext.31 long. tube int.50.7 ext.39

TT /all models sauf J114 -12/87



4001542

OE 7704002623

Articulation sup.

Upper bush

4 Ø int.14 Ø ext.35 long. tube int.50.7 ext.39.5

TT /all models sauf J114 01/88-



4001434

OE 7704001283

Articulation AV inf.

Front lower bush

1 Ø int.14 Ø ext.36 long. tube int.51 ext.34

TT /all models sauf J114 -12/87



4001427

OE 7704002466

Articulation AV inf.

Front lower bush

1 Ø int.16 Ø ext.40 coll.51 long. tube int.83 ext.49 ep. coll.6.4

TT /all models sauf J114 01/88-



4001435

OE 7704001280

Articulation AR inf.

Rear lower bush

2 Ø int.14 Ø ext.36 coll.44 long. tube int.54.5 ext.43 ep. coll.7.5

TT /all models sauf J114 -12/87



4001490

OE 7700777540

Articulation AR inf.

Rear lower bush

2 Ø int.16 Ø ext.40 coll.51 long. tube int.84 ext.56 ep. coll.5

TT /all models sauf J114 01/88-



... Espace J11/S11 ...



Eléments SUSPENSION
Suspension parts
Elementos suspensión
Elementy zawieszenie
Элементы подвески

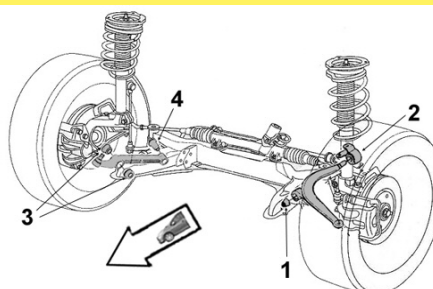

4003347

Art. tirant de chasse

OE 7700781442

Rod bushing

Ø int.12 Ø ext.30 coll.41.5 long. tube int.58 ext.45 ep. coll.4.5



TT /all models sauf J114

Bras & Triangle de suspension

Control arm
Brazo y triángulo
Wahacz
Рычаг подвески

G/L  D/R



4005258

Rotule de susp. sup. G/D

OE 7701461332

L/R upper susp. ball joint



1
2

2.0	J/S112 J116	-12/87
2.1 TD	J115 S115	-12/87
2.2	J117	-12/87

4005262

Rotule de susp. sup. G/D

OE 7701469228

L/R upper susp. ball joint



1
2

2.0	J/S112 J116	01/88-01/91
2.1 TD	J115 S115	01/88-01/91
2.2	J117	01/88-01/91

4005259

Rotule de susp. inf. G/D

OE 7701461331

L/R lower suspension ball joint



1
2

2.0	J/S112 J116	-12/87
2.1 TD	J115 S115	-12/87
2.2	J117	-12/87

4005263

Rotule de susp. inf. G/D

OE 7701465689

L/R lower suspension ball joint



1
2

2.0	J/S112 J116	01/88-01/91
2.1 TD	J115 S115	01/88-01/91
2.2	J117	01/88-01/91

... Espace J11/S11

Eléments TRAIN ARRIERE

Rear axle parts

Tren TRAS



Elementy zawieszenia tylnego

элементы задней оси.



RENAULT



4003378 OE 6025000249	Art. barre Panhard <i>Rod bush Panhard</i> Ø int.10 Ø ext.34 long. tube int.41 ext.31	4003382 OE 6025315757	Articulation <i>Bush</i> Ø int.12 Ø ext.53 long. tube int.50 ext.34
	TT /all models sauf J114		TT /all models sauf J114

Espace J63/S63 ...

Eléments DIRECTION





Steering parts

Elementos Direcciones

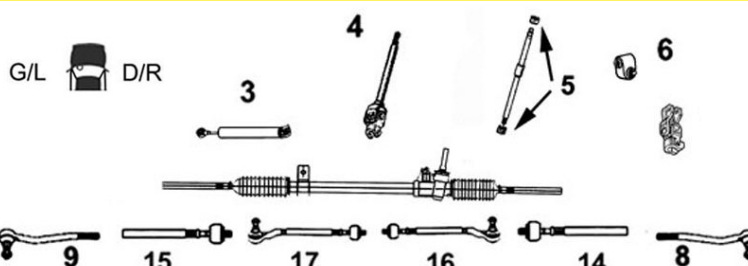
Elementy uklad kierowniczy

Элементы рулевой системы



3008048 OE -	Axe de bielle G/D <i>L/R axial joint</i> 14 Côté dir. M12x1.0 Côté rot. M14x1.5 15 long 190 mm	4006048B1 OE 7701469229	Bielle de direction G/D <i>L/R steering rod</i> 16 17
	TT /all models 01/91-		TT /all models 01/91-
4006112 OE 7701469231	Rotule de direction G/D <i>L/R tie rod end</i> 8 9 M14x1.5	4004009 OE 6025107253	Cardan colonne de direction <i>Cardan joint</i> 7
	TT /all models 01/91-		TT /all models 01/91-12/96
4006137 OE 6025103689	Douille à aiguilles colonne <i>Needle bearing</i> 5		
	TT /all models 01/91-		

... Espace J63/S63 ...



SASIC

RENAULT

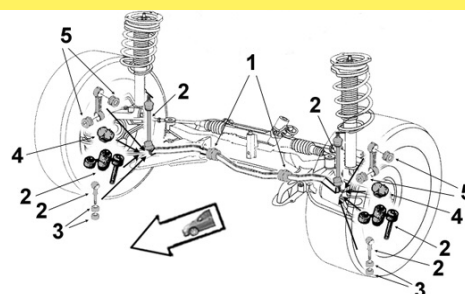

Barre stabilisatrice
 Stabilizer bar
 Barra estabilizadora
 Drążek stabilizatora
 стабилизатор поперечной устойчивости





4005124 OE 7700781500	Biellette barre stab. <i>Stabilizer bar stub axle</i>	4005128 OE 6025102672	Biellette barre stab. <i>Stabilizer bar stub axle</i>
	2 Barre Ø 22 Entraxe 152mm TT /all models J63D J63E J63G J634 TT /all models J635 J636 J637 S63-		2 Barre Ø 23 Entraxe 151mm 2.8 V6 J63J J638



4001503 OE 7700797821	Palier de barre <i>Bar main bearing</i>	4001520 OE 6025105409	Palier de barre <i>Bar main bearing</i>
	1 Barre Ø 22 TT /all models J63D J63E J63G J634 TT /all models J635 J636 J637 S63-		1 Barre Ø 23 2.8 V6 J63J J638

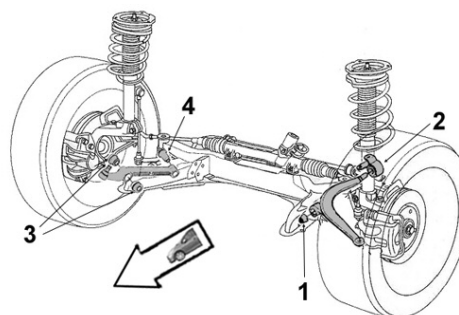

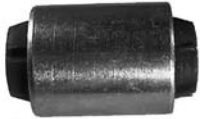
Eléments SUSPENSION
 Suspension parts
 Elementos suspensión
 Elementy zawieszenie
 Элементы подвески



4001502 OE 7704001734	Articulation sup. <i>Upper bush</i>	4001410 OE 7700781463	Articulation AV inf. <i>Front lower bush</i>
	4 Ø int.14 Ø ext.35 long. tube int.58.5 ext.43 TT /all models J63D J63E J63G J634 TT /all models J635 J636 J637 S63-		1 Ø int.14 Ø ext.36 long. tube int.31.5 ext.23.4 TT /all models J63D J63E J63G J634 TT /all models J635 J636 J637 S63-

4001489 OE 7700781441	Articulation AR inf. <i>Rear lower bush</i>	4003347 OE 7700781442	Art. tirant de chasse <i>Rod bushing</i>
	2 Ø int.22.5 TT /all models J63D J63E J63G J634 TT /all models J635 J636 J637 S63-		Ø int.12 Ø ext.30 coll.41.5 long. tube int.58 ext.45 ep. coll.4.5 TT /all models J63D J63E J63G J634 TT /all models J635 J636 J637 S63-

... Espace J63/S63

Bras & Triangle de suspension

Control arm
Brazo y triángulo
Wahacz
Рычаг подвески

G/L  D/R



RENAULT



Espace JEO ...

Eléments DIRECTION

Steering parts

Elementos Direcciones

Elementy układ kierowniczy

Элементы рулевой системы

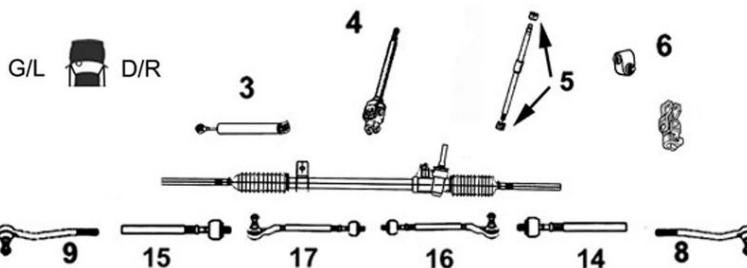

3008049

Axe de bielle G/D

Part/oe 6025370493

L/R axial joint



14 Côté dir. M12x1.0 Côté rot. M14x1.5 long 260 mm

15

1.9 DTi
2.0
2.0i 16v.
2.2 DCi
2.2 DT
3.0 V6

7674002

Rotule de direction G

OE 6025370229

Left tie rod end



9

1.9 DTi
2.0
2.0i 16v.
2.2 DCi
2.2 DT
3.0 V6

7674001

Rotule de direction D

OE 6025370230

Right tie rod end



8

1.9 DTi
2.0
2.0i 16v.
2.2 DCi
2.2 DT
3.0 V6



Barre stabilisatrice

Stabilizer bar

Barra estabilizadora

Drażek stabilizatora

стабилизатор поперечной устойчивости

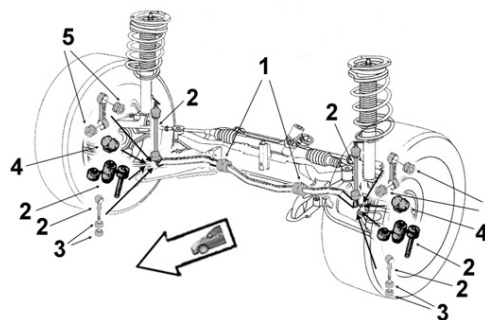

4005132

Biellette barre stab.

OE 7700805494

Stabilizer bar stub axle



2

1.9 DTi
2.0i
2.0i 16v.
2.2 DCi
2.2 TD
3.0 V6

... Espace JEO ...



Eléments SUSPENSION

Suspension parts

Elementos suspensión

Elementy zawieszenie

Элементы подвески

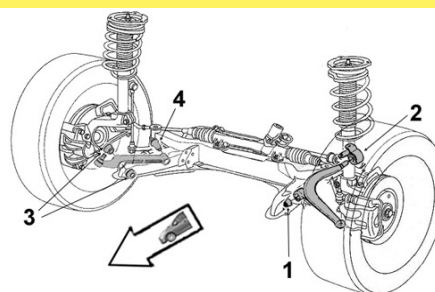

RENAULT



4001535

Articulation AV

OE 7700822503

Front bush



1 Ø int.18 Ø ext.55 long. tube int.55 ext.29.5

1.9 DTi
2.0i
2.0i 16v.
2.2 DCi
2.2 TD
3.0 V6

4001544

Articulation AR

OE 6025311529

Rear bush



2 Ø int.12 Ø ext.58 long. tube int.55 ext.29

1.9 DTi
2.0i
2.0i 16v.
2.2 DCi
2.2 TD
3.0 V6

Bras & Triangle de suspension

Control arm

Brazo y triángulo

Wahacz

Рычаг подвески

G/L D/R

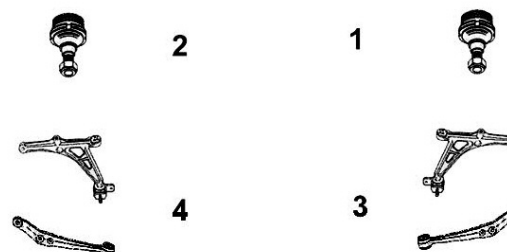

4003217

Triangle de susp. G

OE 6025307649

Left track control arm



4 Avec rotule With ball joint

1.9 DTi
2.0
2.0i 16v.
2.2 DCi
2.2 DT
3.0 V6

4003218

Triangle de susp. D

OE 6025307650

Right track control arm



3 Avec rotule With ball joint

1.9 DTi
2.0
2.0i 16v.
2.2 DCi
2.2 DT
3.0 V6

4005274

Rotule de susp. inf. G/D

OE 6025308155

L/R lower suspension ball joint



1
2

1.9 DTi
2.0
2.0i 16v.
2.2 DCi
2.2 DT
3.0 V6

... Espace JEO ...







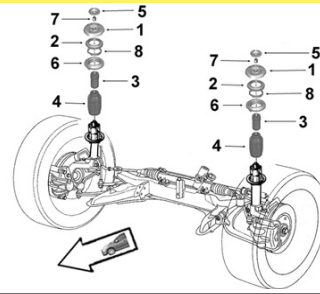



Support d'amortisseur

Suspension mounting
Soporte amortiguador
Poduszka amortyzatora
Опора амортизатора



RENAULT



4001623 OE 6025305979	Support suspension G <i>Left suspension mounting</i>	4001622 OE 6025305980	Support suspension D <i>Right suspension mounting</i>
1	1	1	1
	1.9 DTi 2.0i 2.0i 16v. 2.2 DCi 2.2 TD 3.0 V6		1.9 DTi 2.0i 2.0i 16v. 2.2 DCi 2.2 TD 3.0 V6
0355275 OE 7700824022	Butée à billes G/D <i>L/R ball bearing</i>	4001618 OE 7700826619	Butée de suspension G/D <i>L/R suspension bush</i>
2	2	3	3
	1.9 DTi 2.0i 2.0i 16v. 2.2 DCi 2.2 TD 3.0 V6		1.9 DTi 2.0i 2.0i 16v. 2.2 DCi 2.2 TD 3.0 V6
4005231 OE -	Kit rép. suspension G <i>Left susp. mounting repair kit</i>	4005230 OE -	Kit rép. suspension D <i>Right susp. mounting repair kit</i>
			
1.9 DTi 2.0 2.0i 16v. 2.2 DCi 2.2 DT 3.0 V6	1.9 DTi 2.0 2.0i 16v. 2.2 DCi 2.2 DT 3.0 V6	1.9 DTi 2.0 2.0i 16v. 2.2 DCi 2.2 DT 3.0 V6	1.9 DTi 2.0 2.0i 16v. 2.2 DCi 2.2 DT 3.0 V6
4005213 OE -	Kit rép. protection amort. G et D <i>L/R susp. mounting repair kit</i>		
			
1.9 DTi 2.0 2.0i 16v. 2.2 DCi 2.2 DT 3.0 V6			

... Espace JEO

Eléments TRAIN ARRIERE

Rear axle parts

Tren TRAS



Elementy zawieszenia tylnego

элементы задней оси.



RENAULT



4005503 OE 6025302815	Art. barre Panhard <i>Rod bush Panhard</i>	4003382 OE 6025315757	Articulation <i>Bush</i>
	Ø int.10 Ø ext.38 long. tube int.46 ext.33 avec correcteur d'assiette 1.9 DTi 2.0i 2.0i 16v. 2.2 DCi 2.2 TD 3.0 V6		Ø int.12 Ø ext.53 long. tube int.50 ext.34 1.9 DTi 2.0i 2.0i 16v. 2.2 DCi 2.2 TD 3.0 V6

Espace JKO ...

Eléments DIRECTION

Steering parts



Elementos Direcciones

Elementy układ kierowniczy

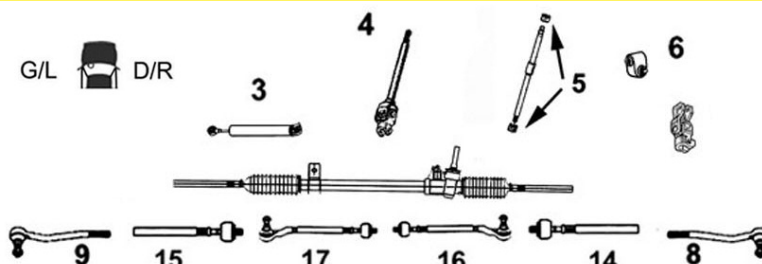
Элементы рулевой системы



7774011 Part/oe 7701478552	Axe de bielle G/D <i>L/R axial joint</i>
	14 Côté dir. M12x1.0 Côté rot. M14x1.5 long 247 mm 15 1.9 DCi /Long JK0G/U JK1B 2.0i 16v. Turbo /Long JK0A/B/D/N/8 JK1D/L 2.0i 16v. JK09/K/L 2.0 DCi /FAP /Long JK01/2/3/4 JK1C/G/H/J/K 2.2 DCi /FAP /Long JK0H/7 3.0 DCi /Long JK0E/J/V/Y 3.5i V6 24v. /Grand Espace JK0F/P/S/W/0

4006147 OE 485202714R	Rotule de direction G <i>Left tie rod end</i>	4006148 OE 485209446R	Rotule de direction D <i>Right tie rod end</i>
	9 1.9 DCi /Long JK0G/U JK1B 2.0i 16v. JK09/K/L 2.0i 16v. Turbo /Long JK0A/B/D/N/8 JK1D/L 2.0 DCi /FAP /Long JK01/2/3/4 JK1C/G/H/J/K 2.2 DCi /FAP /Long JK0H/7 3.0 DCi /Long JK0E/J/V/Y 3.5i V6 24v./Grand Espace JK0F/P/S/W/0		8 1.9 DCi /Long JK0G/U JK1B 2.0i 16v. JK09/K/L 2.0i 16v. Turbo /Long JK0A/B/D/N/8 JK1D/L 2.0 DCi /FAP /Long JK01/2/3/4 JK1C/G/H/J/K 2.2 DCi /FAP /Long JK0H/7 3.0 DCi /Long JK0E/J/V/Y 3.5i V6 24v./Grand Espace JK0F/P/S/W/0

... Espace JKO ...

SASIC

RENAULT



Barre stabilisatrice
 Stabilizer bar
 Barra estabilizadora
 Drażek stabilizatora
 стабилизатор поперечной устойчивости

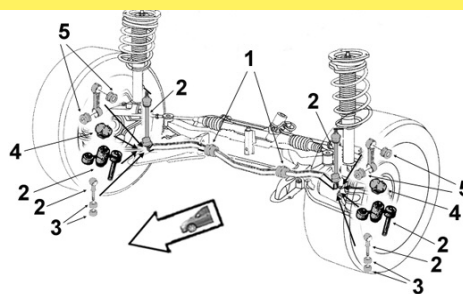

4005141 **Biellette barre stab.**
 OE 8200661217 *Stabilizer bar stub axle*



2

1.9 DCi /Long	JK0G/0U/1B
2.0i 16v.	JK09/0K/0L
2.0i 16v. Turbo /Long	JK0A/0B/0D/0N
2.0 DCi /FAP /Long	JK01/02/03/04/1C/1G/1H/1J/1K
2.2 DCi /FAP /Long	JK0H
3.0 DCi /Long	JK0J/0V
3.5i V6 24v. /Grand Espace	JK0F/0P/0S/0W



Eléments SUSPENSION
 Suspension parts
 Elementos suspensión
 Elementy zawieszenie
 Элементы подвески

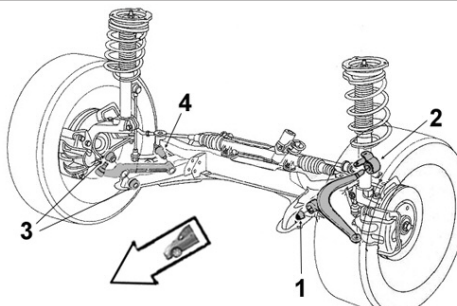

2254007 **Articulation AV**
 Part/oe 8200602617 *Front bush*



1 Ø int.18 Ø ext.55 long. tube int. 50 ext. 31

1.9 DCi /Long	JK0G/0U/1B
2.0i 16v.	JK09/0K/0L
2.0i 16v. Turbo /Long	JK0A/0B/0D/0N/1D
2.0 DCi /Long	JK01/02/03/04
	JK1C/1G/1H/1J/1K
2.2 DCi /FAP /Long	JK0H/07
3.0 DCi /Long	JK0J/0V/0E/0Y
3.5i V6 24v. /Grand Espace	JK0F/0P/0S/0W/00

2254008 **Articulation AR**
 Part/oe 8200602617 *Rear bush*



2 Ø int. 14 Ø ext. 58 long. tube int. 54 ext. 29

1.9 DCi /Long	JK0G/0U/1B
2.0i 16v.	JK09/0K/0L
2.0i 16v. Turbo /Long	JK0A/0B/0D/0N/1D
2.0 DCi /Long	JK01/02/03/04
	JK1C/1G/1H/1J/1K
2.2 DCi /FAP /Long	JK0H/07
3.0 DCi /Long	JK0J/0V/0E/0Y
3.5i V6 24v. /Grand Espace	JK0F/0P/0S/0W/00

Bras & Triangle de suspension

Control arm
 Brazo y triángulo
 Wahacz
 Рычаг подвески

G/L D/R

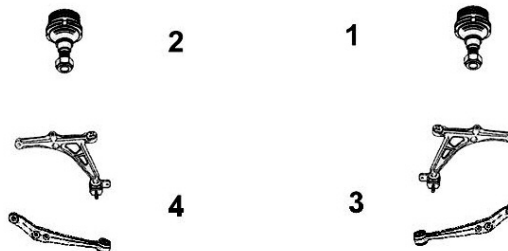

7474001 **Triangle de susp. G**
 OE 545050804R *Left track control arm*



4 Avec rotule With ball joint

1.9 DCi	JK0G/U	JK1B
2.0i 16v.	JK09/K/L	
2.0i 16v. Turbo	JK0A/B/D/N	JK1D/L
2.0 DCi	JK01/2/3/4	JK1C/G/H/J/K
2.2 DCi	JK0H/7	
3.0 DCi	JK0E/J/V/Y	
3.5i V6 24v.	JK0F/P/S/W/0	

7474002 **Triangle de susp. D**
 OE 545048101R *Right track control arm*



3 Avec rotule With ball joint

1.9 DCi	JK0G/U	JK1B
2.0i 16v.	JK09/K/L	
2.0i 16v. Turbo	JK0A/B/D/N	JK1D/L
2.0 DCi	JK01/2/3/4	JK1C/G/H/J/K
2.2 DCi	JK0H/7	
3.0 DCi	JK0E/J/V/Y	
3.5i V6 24v.	JK0F/P/S/W/0	

... Espace JKO ...

RENAULT



4005278

Rotule de susp. inf. G/D

OE 401606676R

L/R lower suspension ball joint



1
2

1.9 DCi /Long	JK0G/U	JK1B
2.0i 16v.	JK09/K/L	
2.0i 16v. Turbo /Long	JK0A/B/D/N/8	JK1D/L
2.0 DCi /FAP /Long	JK01/2/3/4	JK1C/G/H/J/K
2.2 DCi /FAP /Long	JK0H/7	
3.0 DCi /Long	JK0E/J/V/Y	
3.5i V6 24v. /Grand Espace	JK0F/P/S/W/0	



Support d'amortisseur

Suspension mounting

Soporte amortiguador

Poduszka amortyzatora

Опора амортизатора

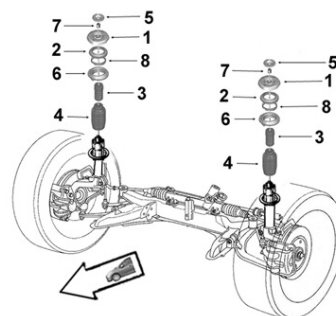

4001628

Coupelle rebond. G/D

OE 8200002877

L/R spring cup



5

1.9 DCi /Long	JK0G/0U/1B
2.0i 16v.	JK09/0K/0L
2.0i 16v. Turbo /Long	JK0A/0B/0D/0N
2.0 DCi /Long	JK01/02/03/04
2.2 DCi /Long	JK0H/07
3.0 DCi /Long	JK0J/0V
3.5i V6 24v. /Grand Espace	JK0F/0P/0S/0W

4001644

Support suspension G/D

OE 8200201714

L/R suspension mounting



1

1.9 DCi /Long	JK0G/0U/1B	-16/11/05
2.0i 16v.	JK09/0K/0L	-16/11/05
2.0i 16v. Turbo /Long	JK0A/0B/0D/0N	-16/11/05
2.2 DCi /Long	JK0H/07	-16/11/05
3.0 DCi /Long	JK0J/0V	-16/11/05
3.5i V6 24v. /Grand Espace	JK0F/0P/0S/0W	-16/11/05

2654010

Support suspension

OE 8200322166

Suspension mounting



1

1.9 DCi /Long	JK0G/0U/1B	16/11/05-
2.0i 16v.	JK09/0K/0L	16/11/05-
2.0i 16v. Turbo /Long	JK0A/0B/0D/0N	16/11/05-
2.0 DCi /Long	JK01/02/03/04	16/11/05-
2.2 DCi /Long	JK0H/07	16/11/05-
3.0 DCi /Long	JK0J/0V	16/11/05-
3.5i V6 24v. /Grand Espace	JK0F/0P/0S/0W	16/11/05-

2654025

Butée à billes G/D

OE 7700424481

L/R ball bearing



2

1.9 DCi /Long	JK0G/0U/1B	
2.0i 16v.	JK09/0K/0L	
2.0i 16v. Turbo /Long	JK0A/0B/0D/0N/08/1D/1L	
2.0 DCi /Long	JK01/02/03/04/1C/1G/1H/1J/1K	
2.2 DCi /FAP /Long	JK0H/07	
3.0 DCi /Long	JK0J/0V/0E/0Y	
3.5i V6 24v. /Grand Espace	JK0F/0P/0S/0W/00	

4001626

Coupelle sup. ressort G/D

OE 7700424482

L R upper cup spring



6

1.9 DCi	JK0G/0U/1B
2.0i 16v.	JK09/0K/0L
2.0i 16v. Turbo	JK0A/0B/0D/0N
2.2 DCi	JK0H
3.0 DCi	JK0J/0V
3.5i V6 24v.	JK0F/0P/0S/0W

4001642

Butée de suspension G/D

OE 8200180137

L/R suspension bush



3
4

1.9 DCi /Long	JK0G/0U/1B
2.0i 16v.	JK09/0K/0L
2.0i 16v. Turbo /Long	JK0A/0B/0D/0N
2.0 DCi /FAP /Long	JK01/02/03/04/1C/1G/1H/1J/1K
2.2 DCi /FAP /Long	JK0H/07
3.0 DCi /Long	JK0J/0V/0E
3.5i V6 24v. /Grand Espace	JK0F/0P/0S/0W

... Espace JKO



Support d'amortisseur
 Suspension mounting
 Soporte amortiguador
 Poduszka amortyzatora
 Опора амортизатора

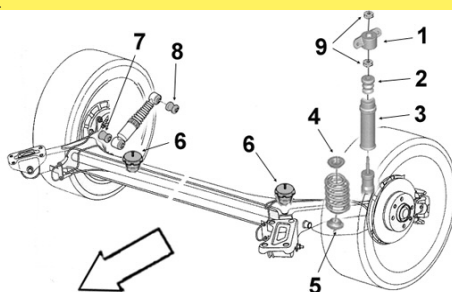

4005501

Appui sup. ressort G/D

OE 8200012476

L/R upper support spring



4

1.9 DCi	JK0G/0U/1B
2.0i 16v.	JK09/0K/0L
2.0i 16v. Turbo	JK0A/0B/0D/0N
2.2 DCi	JK0H
3.0 DCi	JK0J/0V
3.5i V6 24v.	JK0F/0P/0S/0W

4005500

Appui inf. ressort G/D

OE 8200012475

Lower support L/R spring

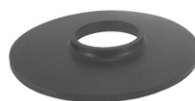

5

1.9 DCi	JK0G/0U/1B
2.0i 16v.	JK09/0K/0L
2.0i 16v. Turbo	JK0A/0B/0D/0N
2.2 DCi	JK0H
3.0 DCi	JK0J/0V
3.5i V6 24v.	JK0F/0P/0S/0W

4005512

Butée de talonnage G/D

OE 8200016214

L/R bushing



6

1.9 DCi /Long	JK0G/0U/1B
2.0i 16v.	JK09/0K/0L
2.0i 16v. Turbo /Long	JK0A/0B/0D/0N
2.0 DCi /FAP /Long	JK01/02/03/04/1C/1G/1H/1J/1K
2.2 DCi /Long	JK0H/07
3.0 DCi /Long	JK0J/0V/0E
3.5i V6 24v. /Grand Espace	JK0F/0P/0S/0W

Eléments TRAIN ARRIERE

Rear axle parts

Tren TRAS

Elementy zawieszenia tylnego

элементы задней оси.



4005506

Articulation AR G/D

OE 8200715229

L/R rear bush



Ø int.13 Ø ext.71 coll.89.6 long. tube int.80 ext.48 ep. Coll.7.2

1.9 DCi /Long	JK0G/0U/1B
2.0i 16v.	JK09/0K/0L
2.0i 16v. Turbo /Long	JK0A/0B/0D/0N
2.0 DCi /FAP /Long	JK01/02/03/04/1C/1G/1H/1J/1K
2.2 DCi /FAP /Long	JK0H
3.0 DCi /Long	JK0J/0V
3.5i V6 24v. /Grand Espace	JK0F/0P/0S/0W

Fluence ...

Eléments DIRECTION

Steering parts

Elementos Direcciones

Elementy układ kierowniczy

Элементы рулевой системы

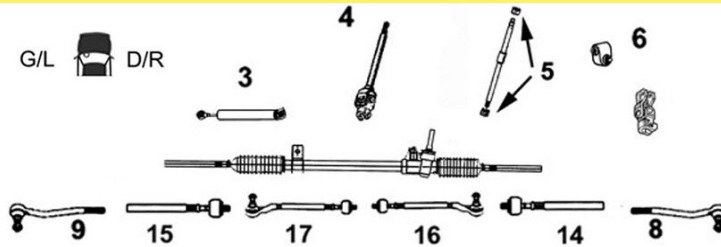

7774013

Axe de bielle G/D

Part/oe 485215612R

L/R axial joint



14 Côté dir. M14x1.5 Côté rot. M14x1.5 long 215 mm

15

1.5 DCi	B30A/B/D/E/J/K/L/M/S	B33/3E/3F
1.5 DCi Série EQPARG EQPEXP EQPRUS	L30A/B/D/J/K/L/M/S/6	L333/E/F
1.6i	B332/4/7	
1.6i Série EQPARG EQPEXP EQPRUS	L304/5/H L331/2/4/7	
1.6i 16v.	B30F/P/R/1/3	B33C
1.6i 16v. Série EQPARG EQPEXP EQPRUS	L30F/P/R/0/1	L33C/G
1.6 DCi Série EQPARG EQPEXP EQPRUS	L339	
2.0i 16v.	B30C/G/T/V	B330/B
2.0i 16v. Série EQPARG EQPEXP EQPRUS	L302/7/C/G/T/V/W	L330/B
2.0i 16v. Série EQPARG EQPEXP EQPRUS	L308/9	M4R
TT Elec. /All models Electric Série EQPARG EQPEXP EQPRUS	L30Z	L336
		F4R

7674006

Rotule de direction G

OE 485202710R

Left tie rod end



9 M14 x 1.5

1.5 DCi	B30A/B/D/E/J/K/L/M/S	B33/3E/3F
1.5 DCi Série EQPARG EQPEXP EQPRUS	L30A/B/D/J/K/L/M/S/6	L333/E/F
1.6i	B332/4/7	
1.6i Série EQPARG EQPEXP EQPRUS	L304/5/H L331/2/4/7	
1.6i 16v.	B30F/P/R/1/3	B33C
1.6i 16v. Série EQPARG EQPEXP EQPRUS	L30F/P/R/0/1	L33C/G
1.6 DCi Série EQPARG EQPEXP EQPRUS	L339	
2.0i 16v.	B30C/G/T/V	B330/B
2.0i 16v. Série EQPARG EQPEXP EQPRUS	L302/7/C/G/T/V/W	L330/B
2.0i 16v. Série EQPARG EQPEXP EQPRUS	L308/9	M4R
TT Elec. /All models Electric Série EQPARG EQPEXP EQPRUS	L30Z	L336
		F4R

7674007

Rotule de direction D

OE 485204680R

Right tie rod end



8 M14 x 1.5

1.5 DCi	B30A/B/D/E/J/K/L/M/S	B33/3E/3F
1.5 DCi Série EQPARG EQPEXP EQPRUS	L30A/B/D/J/K/L/M/S/6	L333/E/F
1.6i	B332/4/7	
1.6i Série EQPARG EQPEXP EQPRUS	L304/5/H L331/2/4/7	
1.6i 16v.	B30F/P/R/1/3	B33C
1.6i 16v. Série EQPARG EQPEXP EQPRUS	L30F/P/R/0/1	L33C/G
1.6 DCi Série EQPARG EQPEXP EQPRUS	L339	
2.0i 16v.	B30C/G/T/V	B330/B
2.0i 16v. Série EQPARG EQPEXP EQPRUS	L302/7/C/G/T/V/W	L330/B
2.0i 16v. Série EQPARG EQPEXP EQPRUS	L308/9	M4R
TT Elec. /All models Electric Série EQPARG EQPEXP EQPRUS	L30Z	L336
		F4R

... Fluence ...



Eléments SUSPENSION
Suspension parts
Elementos suspensión
Elementy zawieszenie
Элементы подвески

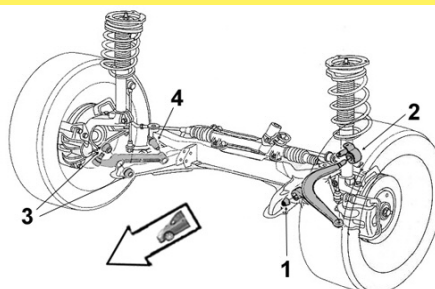

RENAULT



2254010

Articulation AV

Part/oe 545006560R

Front bush



1 Ø int. 18.5 Ø ext. 55
 long. tube int. 50.5 ext. 31

1.5 DCi	12/09/12-
1.6i	12/09/12-
1.6 DCi	12/09/12-
2.0i 16v.	12/09/12-
Electric	12/09/12-

2254011

Articulation AR

Part/oe 545008682R

Rear bush

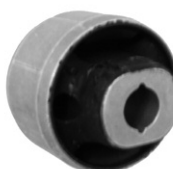

2 Ø int. 14.5 Ø ext. 58
 long. tube int. 65 ext. 35.5

1.5 DCi	12/09/12-
1.6i	12/09/12-
1.6 DCi	12/09/12-
2.0i 16v.	12/09/12-
Electric	12/09/12-

Bras & Triangle de suspension

Control arm
Brazo y triángulo
Wahacz
Рычаг подвески

G/L D/R



7474010

Triangle de susp. inf. G

OE 545018194R

Lower left track control arm

NEW



4 Avec rotule With ball joint

1.5 DCi	B30A/B/D/E/J/K/L/M/S B33/3E/3F
1.5 DCi Série EQPARG EQPEXP EQPRUS	L30A/B/D/J/K/L/M/S/6 L333/E/F
1.5 DCi Série EQPCOR	L30A/B/D/J/K/L/M/S/6 L333/E/F -15/02/10
1.6i	B332/4/7
1.6i Série EQPARG EQPEXP EQPRUS	L304/5/H L331/2/4/7
1.6i Série EQPCOR	L304/5/H L331/2/4/7 -15/02/10
1.6i 16v.	B30F/P/R/1/3 B33C
1.6i 16v. Série EQPARG EQPEXP EQPRUS	L30F/P/R/0/1 L33C/G
1.6i 16v. Série EQPCOR	L30F/P/R/0/1 L33C/G -15/02/10
1.6 DCi Série EQPARG EQPEXP EQPRUS	L339
1.6 DCi Série EQPCOR	L339 -15/02/10
2.0i 16v.	B30C/G/T/V B330/B
2.0i 16v. Série EQPARG EQPEXP EQPRUS	L302/7/C/G/T/V/W L330/B M4R
2.0i 16v. Série EQPARG EQPEXP EQPRUS	L308/9 F4R
2.0i 16v. Série EQPCOR	L308/9 F4R -15/02/10
TT Elec. /All models Electric Série EQPARG EQPEXP EQPRUS	L30Z L336
TT Elec. /All models Electric Série EQPCOR	L30Z L336 -15/02/10

7474011

Triangle de susp. inf. D

OE 545008682R

Lower right track control arm

NEW



3 Avec rotule With ball joint

1.5 DCi	B30A/B/D/E/J/K/L/M/S B33/3E/3F
1.5 DCi Série EQPARG EQPEXP EQPRUS	L30A/B/D/J/K/L/M/S/6 L333/E/F
1.5 DCi Série EQPCOR	L30A/B/D/J/K/L/M/S/6 L333/E/F -15/02/10
1.6i	B332/4/7
1.6i Série EQPARG EQPEXP EQPRUS	L304/5/H L331/2/4/7
1.6i Série EQPCOR	L304/5/H L331/2/4/7 -15/02/10
1.6i 16v.	B30F/P/R/1/3 B33C
1.6i 16v. Série EQPARG EQPEXP EQPRUS	L30F/P/R/0/1 L33C/G
1.6i 16v. Série EQPCOR	L30F/P/R/0/1 L33C/G -15/02/10
1.6 DCi Série EQPARG EQPEXP EQPRUS	L339
1.6 DCi Série EQPCOR	L339 -15/02/10
2.0i 16v.	B30C/G/T/V B330/B
2.0i 16v. Série EQPARG EQPEXP EQPRUS	L302/7/C/G/T/V/W L330/B M4R
2.0i 16v. Série EQPARG EQPEXP EQPRUS	L308/9 F4R
2.0i 16v. Série EQPCOR	L308/9 F4R -15/02/10
TT Elec. /All models Electric Série EQPARG EQPEXP EQPRUS	L30Z L336
TT Elec. /All models Electric Série EQPCOR	L30Z L336 -15/02/10

... Fluence

7574002
Rotule de susp. inf. G/D

Part/oe 545018194R

L/R lower suspension ball joint

1
2

1.5 DCi	Série EQPARG EQPEXP EQPRUS	L30A/B/D/J/K/L/M/S/6	L333/E/F
1.5 DCi	Série EQPCOR	L30A/B/D/J/K/L/M/S/6	L333/E/F -15/02/10
1.5 DCi		B30A/B/D/E/J/K/L/M/S	B33/3E/3F
1.6i		B332/4/7	
1.6i	Série EQPARG EQPEXP EQPRUS	L304/5/H	L331/2/4/7
1.6i	Série EQPCOR	L304/5/H	L331/2/4/7 -15/02/10
1.6i 16v.	Série EQPARG EQPEXP EQPRUS	L30F/P/R/0/1	L33C/G
1.6i 16v.	Série EQPCOR	L30F/P/R/0/1	L33C/G -15/02/10
1.6i 16v.		B30F/P/R/1/3	B33C
1.6 DCi	Série EQPARG EQPEXP EQPRUS	L339	
1.6 DCi	Série EQPCOR	L339	-15/02/10
2.0i 16v.	Série EQPARG EQPEXP EQPRUS	L302/7/C/G/T/V/W	L330/B M4R
2.0i 16v.	Série EQPARG EQPEXP EQPRUS	L308/9	F4R
2.0i 16v.	Série EQPCOR	L308/9	F4R -15/02/10
2.0i 16v.		B30C/G/T/V	B330/B
TT Elec. /All models Electric	Série EQPARG EQPEXP EQPRUS	L30Z	L336
TT Elec. /All models Electric	Série EQPCOR	L30Z	L336 -15/02/10

Support d'amortisseur

Suspension mounting
Soporte amortiguador
Poduszka amortyzatora
Опора амортизатора

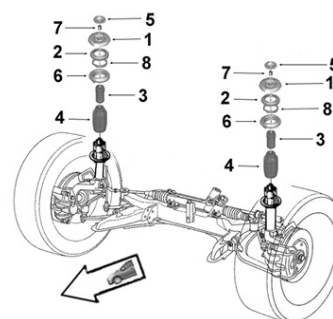
2654023
Butée à billes G/D

OE 543256557R

L/R ball bearing

2

1.5 DCi	B30A/0B/0E/0J/0K/0M/0D/0L/0S	L30A/0B/0J/0K/0M/06/0D/0L/0S/33
1.6i	L304/05/0H/31/32/34/37	
1.6i 16v.	B30F/0P/0R/01/03	L30F/0P/0R/01/00
1.6 DCi	L339	
2.0i 16v.	B30C/0G/0T/0V/30	L302/07/0C/0G/0T/0V/0W/30/3B M4R
2.0i 16v.	L308/09	F4R
TT Elec. /All models Electric	L30Z	

Fuego ...

Eléments DIRECTION

Steering parts
Elementos Direcciones
Elementy uklad kierowniczy
Элементы рулевой системы

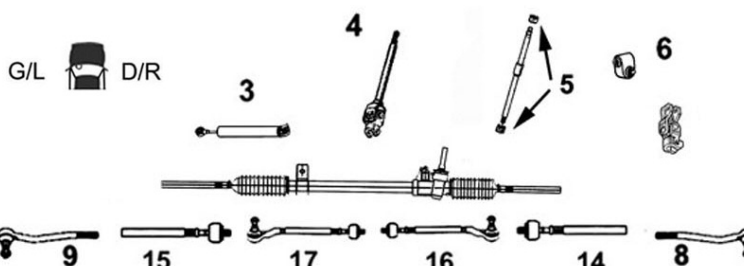
3008044
Axe de bielle G/D

OE -

L/R axial joint

14 Côté dir. M12x1.0 Côté rot. M14x1.5
15 long 220 mm

TT /all models

4006044B1
Bielle de direction G/D

OE 7701463025

L/R steering rod

16 M14 x 1.5
17

TT /all models

... Fuego

Eléments DIRECTION

Steering parts

Elementos Direcciones

Elementy układ kierowniczy

Элементы рулевой системы

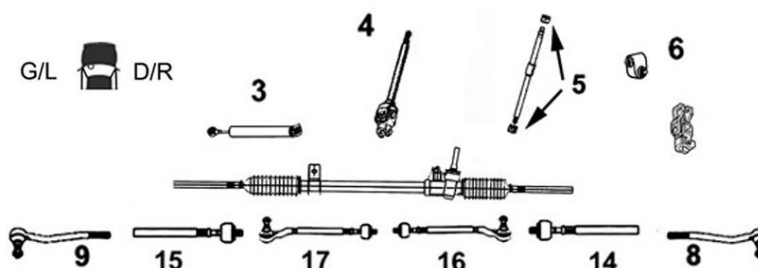
4006112
Rotule de direction G/D

OE 7701469231

L/R tie rod end

 8
9

M14x1.5

TT /all models

4006138
Douille à aiguilles colonne

OE 7703090293

Needle bearing

5

TT /all models

Bras & Triangle de suspension

Control arm

Brazo y triángulo

Wahacz

Рычаг подвески

G/L D/R

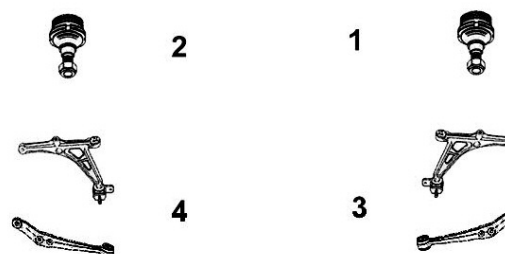
4005258
Rotule de susp. sup. G/D

OE 7701461332

L/R upper susp. ball joint

 1
2

TT /all models

4005259
Rotule de susp. inf. G/D

OE 7701461331

L/R lower suspension ball joint

 1
2

TT /all models

Kangoo I -02/03 VL ...

Eléments DIRECTION

Steering parts

Elementos Direcciones

Elementy układ kierowniczy

Элементы рулевой системы

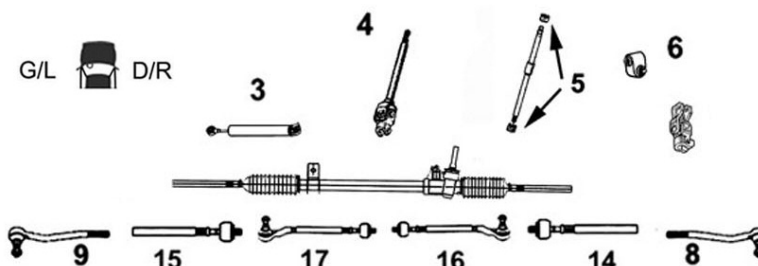
3008034
Axe de bielle G/D

Part/oe 7701470764

L/R axial joint

 14
15

Côté dir. M12x1.0 Côté rot. M14x1.5 long 265 mm

1.2	DNA Véhicule tout chemin	KC0A	-03/02/99
1.2	DA Sauf tout chemin	KC0A	-03/02/99
1.4	DNA Véhicule tout chemin	KC0C/0H	-03/02/99
1.4	DA	KC0C/0H	-03/02/99
1.6	DNA Susp. renforcée	KC00	-01/09/99
1.9 D	DNA Véhicule tout chemin	KC0D/0E	-03/02/99
1.9 D	DA	KC0D/0E	-03/02/99

... Kangoo I -02/03 VL ...

RENAULT



3008035

Axe de bielle G/D

Part/oe 7701472113

L/R axial joint



14	Côté dir. M12x1.0 Côté rot. M14x1.5 long 303 mm DNA		
15	1.2	KC0A	03/02/99-
	1.2	KC01/0F/0K/1A	
	1.4	KC0C/0H	03/02/99-
	1.4	KC0B/0M	
	1.5 DCi	KC07/08/09/1F	
	1.9 D	KC0D/0E	03/02/99-
	1.9 D	KC02/0J	
	1.9 DTi	KC0U	

3008040

Axe de bielle G/D

Part/oe 7701472120

L/R axial joint



14	Côté dir. M12x1.0 Côté rot. M14x1.5 long 305 mm		
15	1.2	DA	KC01/0A/0F/1A
	1.2i 16v.	DA	KC0T/0W/1D/1P/1K
	1.4	DA	KC0C/0H
	1.4	DA	KC0B/0M
	1.5 DCi	DA	KC07/08/09/1F
	1.6	DA	KC00
	1.6i 16v. 2WD		KC0L/0P/0S/1N
	1.9 D	DA	KC0D/0E
	1.9 D	DA	KC02/0J
	1.9 DCi 2WD		KC0V
	1.9 DTi	DA	KC0U
	TT Elec. /All models Electric		KC0Z

3008181

Axe de bielle G/D

Part/oe 7701470763

L/R axial joint



14	Côté dir. M12x1.0 Côté rot. M14x1.5 long 264 mm		
15	DNA Sauf tout chemin		
	1.2	KC0A	-03/02/99
	1.4	KC0C/0H	-03/02/99
	1.9 D	KC0D/0E	-03/02/99

3008243

Axe de bielle G/D

Part/oe 7701473656

L/R axial joint



14	Côté dir. M12x1.0 Côté rot. M14x1.5 long 314 mm		
15	1.9 DCi 4WD	KC0V	

4006134

Rotule de direction G

OE 7701474641

Left tie rod end



9	1.0		
	1.2		
	1.2i 16v.		
	1.4		
	1.5 DCi		
	1.6i /16v.		
	1.9 D		
	1.9 DCi		
	1.9 DTi		
	TT Elec. /All models Electric		

4006135

Rotule de direction D

OE 7701047813

Right tie rod end



8	1.0		
	1.2		
	1.2i 16v.		
	1.4		
	1.5 DCi		
	1.6i /16v.		
	1.9 D		
	1.9 DCi		
	1.9 DTi		
	TT Elec. /All models Electric		

... Kangoo I -02/03 VL ...

SASIC

RENAULT



Barre stabilisatrice
 Stabilizer bar
 Barra estabilizadora
 Drażek stabilizatora
 стабилизатор поперечной устойчивости

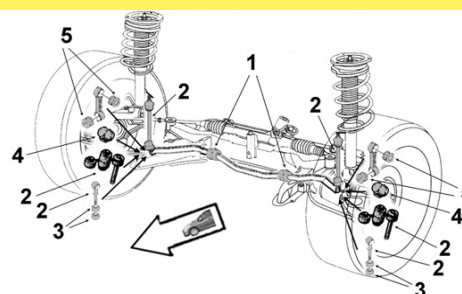

4005148 **Biellette barre stab.**
 OE 7700437136 *Stabilizer bar stub axle*



2
 1.6i 16v. 4WD KC0P/0S

4001505 **Palier de barre bout**
 OE (2oe) 7700799404+7703034237 *End bar main bearing*



2	1.2i /GPL 1.2i /GPL tout chemin Sans protection spéciale 1.2i 16v. 1.2i 16v. tout chemin Sans protection spéciale 1.4i tout chemin Sans protection spéciale 1.5 DCi 1.5 DCi tout chemin Sans protection spéciale 1.6i 16v. 2WD 1.9 D tout chemin Sans protection spéciale 1.9 DCi 2WD tout chemin Sans protection spéciale 1.9 DTi tout chemin Sans protection spéciale	KC1A/1H KC01/0A/0F KC0T/1K KC05/0W/1D/1P KC0B/0C/0H/0M KC1F/1R/1S KC07/08/09/1V KC0L/0P/0S/1N KC0D/0E/0J/0N KC0U/0V KC0U/0V
----------	--	---

4005134 **Palier de barre bout**
 OE 7700314855 *End bar main bearing*



4 **Barre Ø 23**

1.2	KC0K
1.2 tout chemin	KC01/0A
1.2i 16v.	KC03
1.4 tout chemin	KC0C/0H
1.6i	KC00
1.6i 16v.	KC0R/1B
1.9 D	KC02
1.9 D tout chemin	KC0D/0E
1.9 DTi tout chemin	KC0U

4001476 **Palier de barre milieu**
 OE 7700785788 *Middle bar main bearing*



1 **Barre Ø 23**

1.2i 16v.	KC03/1D/1P
1.4	KC0C/0H
1.5 DCi	KC07/08/09
1.6i	KC00
1.6i 16v.	KC0P/0R/0S/1B
1.9 D	KC02/0D/0E
1.9 DTi	KC0U

4005078 **Kit rép. barre stab. G et D**
 OE - *L R Stabilizing bar repair kit*

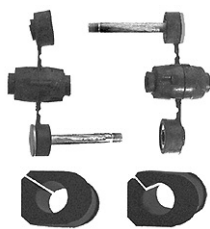

Barre percée Ø 23

1.2		KC05/0T/0W/1D/1P
1.2	Sauf tout chemin	KC1P
1.2i 16v.		KC1A
1.2i 16v.	Sauf tout chemin	KC01/0A/0F
1.4	Sauf tout chemin	KC0C/0H
1.5 DCi	Sauf tout chemin	KC07
1.6i 16v. 2WD		KC0P
1.9 D	Sauf tout chemin	KC0D/0E/0J
1.9 DTi	Sauf tout chemin	KC0U
TT Elec. /All models Electric		KC0Z

4005080 **Kit rép. barre stab. G et D**
 OE - *L R Stabilizing bar repair kit*



Barre Ø 23

1.2		KC03
1.2	Véhicule tout chemin	KC05/0W/1D/1P
1.2i 16v.		KC0K
1.2i 16v.	Véhicule tout chemin	KC01/0A/0F
1.4	Véhicule tout chemin	KC0C/0H
1.5 DCi	Véhicule tout chemin	KC07
1.9 D		KC02
1.9 D	Véhicule tout chemin	KC0D/0E/0J
1.9 DTi	Véhicule tout chemin	KC0U

... Kangoo I -02/03 VL ...



Eléments SUSPENSION
Suspension parts
Elementos suspensión
Elementy zawieszenie
Элементы подвески

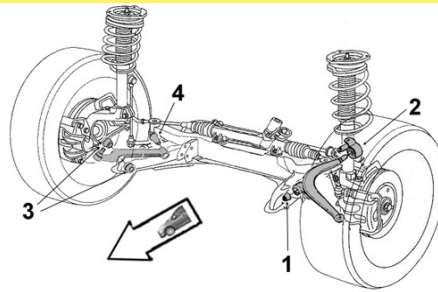

RENAULT



4001546

Articulation AV/AR

OE 8200711554

Front rear bush



1
2

Ø int.12 Ø ext.45 coll.59 long. tube int.46 ext.30 ep. coll.4

1.2	tout chemin	KC0A	-03/03/99
1.2		KC0A	03/03/99-
1.2i 16v.		KC01/1A KC0K	
1.4		KC03/1D/1P	
1.4	tout chemin	KC0H	
1.4		KC0C	-03/03/99
1.4		KC0C	03/03/99-
1.5 DCi 2WD	tout chemin	KC07/08/09	
1.6i		KC00	
1.6i 16v.		KC0R/1B	
1.6i 16v. 2WD		KC0P/0S	
1.9 D	tout chemin	KC0D/0E	
1.9 DCi 2WD	tout chemin	KC0V	
1.9 DTi	tout chemin	KC0U	

4001540

Articulation AV/AR

OE 7700424399

Front rear bush



1
2

Ø int.12 Ø ext.45.5 coll.59
 long. tube int.46 ext.29.5 ep. coll.4
 sauf tout chemin

1.2i	KC0A	-03/03/99
1.4	KC0C	-03/03/99
1.9 D	KC0D/0E	
1.9 DCi 2WD	KC0V	
1.9 DTi	KC0U	

4005502

Articulation AV/AR

OE 8200033379

Front rear bush



1
2

Ø int.12 Ø ext.45 coll.47.8
 long. tube int.46 ext.29 ep. Coll.4.1

1.6i 16v. 4WD	KC0P/0S
1.9 DCi 4WD	KC0V

Bras & Triangle de suspension

Control arm
Brazo y triángulo
Wahacz
Рычаг подвески

G/L D/R



4003210

Triangle de susp. G

OE 7701474869

Left track control arm



4

Sans rotule *Without tie rod end*

1.2		KC0K	
1.2	sauf tout chemin	KC0A	03/03/99-
1.2	Véhicule tout chemin	KC0F/01	
1.2i 16v.		KC03	
1.2i 16v.	sauf tout chemin	KC05	-28/03/01
1.2i 16v.	Véhicule tout chemin	KC05/0W	
1.4	sauf tout chemin	KC0C	03/03/99-
1.4	sauf tout chemin	KC0B/0H/0M	-28/03/01
1.4	Véhicule tout chemin	KC0B/0C/0H/0M	
1.5 DCi	Véhicule tout chemin	KC07	
1.9 D		KC02	
1.9 D	Véhicule tout chemin	KC0D/0E/0J	
1.9 DCi 2WD	Véhicule tout chemin	KC0V	
1.9 DTi	Véhicule tout chemin	KC0U	

... Kangoo I -02/03 VL ...

Bras & Triangle de suspension

Control arm
Brazo y triángulo
Wahacz
Рычаг подвески

G/L  D/R



RENAULT



4003211

Triangle de susp. D

OE 7701474870

Right track control arm



3 Sans rotule Without tie rod end

1.2		KC0K	
1.2	sauf tout chemin	KC0A	03/03/99-
1.2	Véhicule tout chemin	KC0F/01	
1.2i 16v.		KC03	
1.2i 16v.	sauf tout chemin	KC05	-28/03/01
1.2i 16v.	Véhicule tout chemin	KC05/0W	
1.4	sauf tout chemin	KC0C	03/03/99-
1.4	sauf tout chemin	KC0B/0H/0M	-28/03/01
1.4	Véhicule tout chemin	KC0B/0C/0H/0M	
1.5 DCi	Véhicule tout chemin	KC07	
1.9 D		KC02	
1.9 D	Véhicule tout chemin	KC0D/0E/0J	
1.9 DCi 2WD	Véhicule tout chemin	KC0V	
1.9 DTi	Véhicule tout chemin	KC0U	

4003226

Triangle de susp. G

Part/oe 8200254163

Left track control arm



4 Sans rotule Without tie rod end

1.2 2WD	sauf tout chemin	KC0F/01	28/03/01-
1.2 2WD	sauf tout chemin	KC1A	-18/09/02
1.2i 16v. 2WD	sauf tout chemin	KC05/0T/0W/1D/1P/1K	19/09/02-
1.2i 16v. 2WD	sauf tout chemin	KC05	28/03/01-18/09/02
1.2i 16v. 2WD	sauf tout chemin	KC0W	-18/09/02
1.4 2WD	sauf tout chemin	KC0B/0H/0M	28/03/01-
1.5 DCi 2WD	sauf tout chemin	KC07	28/03/01-
1.6i 16v. 2WD		KC0P	28/03/01-
1.9 D 2WD	sauf tout chemin	KC0E/0J	28/03/01-
1.9 DCi 2WD	sauf tout chemin	KC0V	28/03/01-
TT Elec. /All models Electric 2WD		KC0Z	28/03/01-

4003227

Triangle de susp. D

Part/oe 8200254166

Right track control arm



3 Sans rotule Without tie rod end

1.2 2WD	sauf tout chemin	KC0F/01	28/03/01-
1.2 2WD	sauf tout chemin	KC1A	-18/09/02
1.2i 16v. 2WD	sauf tout chemin	KC05/0T/0W/1D/1P/1K	19/09/02-
1.2i 16v. 2WD	sauf tout chemin	KC05	28/03/01-18/09/02
1.2i 16v. 2WD	sauf tout chemin	KC0W	-18/09/02
1.4 2WD	sauf tout chemin	KC0B/0H/0M	28/03/01-
1.5 DCi 2WD	sauf tout chemin	KC07	28/03/01-
1.6i 16v. 2WD		KC0P	28/03/01-
1.9 D 2WD	sauf tout chemin	KC0E/0J	28/03/01-
1.9 DCi 2WD	sauf tout chemin	KC0V	28/03/01-
TT Elec. /All models Electric 2WD		KC0Z	28/03/01-

4003367

Triangle de susp. G

OE 8200197179

Left track control arm









4 Avec rotule With ball joint sauf tout chemin

1.2		KC0A	-03/03/99
1.4		KC0C	-03/03/99
1.5 DCi		KC07	-28/03/01
1.9 D		KC0D	
1.9 D		KC0E/0J	-28/03/01
1.9 DCi 2WD		KC0V	-28/03/01
1.9 DTi		KC0U	

... Kangoo I -02/03 VL ...

RENAULT



4003366 Triangle de susp. D	
OE 8200197187 <i>Right track control arm</i>	
	3 Avec rotule <i>With ball joint</i> sauf tout chemin
	1.2 KC0A -03/03/99
	1.4 KC0C -03/03/99
	1.5 DCi KC07 -28/03/01
	1.9 D KC0D
	1.9 D KC0E/OJ -28/03/01
	1.9 DCi 2WD KC0V -28/03/01
	1.9 DTi KC0U
7474030 Triangle de susp. G	
OE 8200942407 <i>Left track control arm</i>	
	4 Avec rotule <i>With ball joint Ø 16</i> Chemin normal Sans protection spéciale
	1.2i GPL 2WD KC0A -03/03/99
	1.4i 2WD KC0C -03/03/99
	1.9 D 2WD KC0D
	1.9 D 2WD KC0E/OJ/ON -28/03/01
	1.9 DCi 2WD KC0V -28/03/01
	1.9 DTi 2WD KC0U
	1.9 DTi 2WD KC0V -28/03/01
7474029 Triangle de susp. D	
OE 8200942408 <i>Right track control arm</i>	
	3 Avec rotule <i>With ball joint Ø 16</i> Chemin normal Sans protection spéciale
	1.2i GPL 2WD KC0A -03/03/99
	1.4i 2WD KC0C -03/03/99
	1.9 D 2WD KC0D
	1.9 D 2WD KC0E/OJ/ON -28/03/01
	1.9 DCi 2WD KC0V -28/03/01
	1.9 DTi 2WD KC0U
	1.9 DTi 2WD KC0V -28/03/01
7474020 Triangle de susp. G	
OE 8200254108 <i>Left track control arm</i>	
	4 Avec rotule <i>With ball joint</i> Fixation rotule Ø12
	1.2 2WD <i>sauf tout chemin</i> KC1A -18/09/02
	1.2 2WD <i>sauf tout chemin</i> KC0F/01 19/09/02-
	1.2i 16v. 2WD <i>sauf tout chemin</i> KC05/0W 19/09/02-
	1.4 2WD <i>sauf tout chemin</i> KC0B/0M 19/09/02-
	1.5 DCi 2WD <i>sauf tout chemin</i> KC07 19/09/02-
	1.6i 16v. 2WD KC0P 19/09/02-
	1.9 D 2WD <i>sauf tout chemin</i> KC0E/OJ 19/09/02-
	1.9 DCi 2WD <i>sauf tout chemin</i> KC0V 19/09/02-
	TT Elec. /All models Electric 2WD KC0Z 28/03/01-
	7474019 Triangle de susp. D
OE 8200254109 <i>Right track control arm</i>	
	3 Avec rotule <i>With ball joint</i> Fixation rotule Ø12
	1.2 2WD <i>sauf tout chemin</i> KC1A -18/09/02
	1.2 2WD <i>sauf tout chemin</i> KC0F/01 19/09/02-
	1.2i 16v. 2WD <i>sauf tout chemin</i> KC05/0W 19/09/02-
	1.4 2WD <i>sauf tout chemin</i> KC0B/0M 19/09/02-
	1.5 DCi 2WD <i>sauf tout chemin</i> KC07 19/09/02-
	1.6i 16v. 2WD KC0P 19/09/02-
	1.9 D 2WD <i>sauf tout chemin</i> KC0E/OJ 19/09/02-
	1.9 DCi 2WD <i>sauf tout chemin</i> KC0V 19/09/02-
	TT Elec. /All models Electric 2WD KC0Z
	4005273 Rotule de susp. inf. G/D
OE 7701468411 <i>L/R lower suspension ball joint</i>	
	1 Trous fixation Ø10
	2 1.2/i 16v. Véhicule tout chemin KC0A/0F/01 KC05/0W
	1.2/i 16v. KC0K KC03
	1.4 Véhicule tout chemin KC0B/0C/0H/0M
	1.5 DCi Véhicule tout chemin KC07
	1.6 2WD KC00
	1.9 D /2WD Véhicule tout chemin KC0D/0E/0J KC0N
	1.9 D KC02
	1.9 DCi 2WD Véhicule tout chemin KC0V
1.9 DTi Véhicule tout chemin KC0U	

... Kangoo I -02/03 VL ...

Bras & Triangle de suspension

Control arm
Brazo y triángulo
Wahacz
Рычаг подвески

G/L  D/R



RENAULT

SASIC

4005257

Rotule de susp. inf. G/D

OE 7701472038

L/R lower suspension ball joint



1 Troux fixation Ø10

2	1.2 2WD	sauf tout chemin	KC0F/01	28/03/01-18/09/02
	1.2i 16v. 2WD	sauf tout chemin	KC05	28/03/01-18/09/02
	1.2i 16v. 2WD	sauf tout chemin	KC0W	-18/09/02
	1.4 2WD	sauf tout chemin	KC0H	28/03/01-
	1.4 2WD	sauf tout chemin	KC0B/0M	28/03/01-18/09/02
	1.5 DCi 2WD	sauf tout chemin	KC07	28/03/01-18/09/02
	1.6i 16v. 2WD		KC0P	28/03/01-18/09/02
	1.9 D 2WD	sauf tout chemin	KC0E/0J	28/03/01-18/09/02
	1.9 DCi 2WD	sauf tout chemin	KC0V	28/03/01-18/09/02
	1.9 DTi 2WD	sauf tout chemin	KC0U	-18/09/02

4005277

Rotule de susp. inf. G/D

Part/oe 8200942407

L/R lower suspension ball joint



1 Troux fixation Ø12

2	1.2 2WD	sauf tout chemin	KC0F/01	19/09/02-
	1.2i 16v. 2WD	sauf tout chemin	KC05/0W	19/09/02-
	1.2 2WD	sauf tout chemin	KC1A	-18/09/02
	1.4 2WD	sauf tout chemin	KC0B/0M	19/09/02-
	1.5 DCi 2WD	sauf tout chemin	KC07	19/09/02-
	1.6i 16v. 2WD		KC0P	19/09/02-
	1.9 D 2WD	sauf tout chemin	KC0E/0J	19/09/02-
	1.9 DCi 2WD	sauf tout chemin	KC0V	19/09/02-
	TT Elec. /All models Electric 2WD		KC0Z	28/03/01-

4005423

Kit rép. triangle susp. G ou D

OE -

L or R track control arm bearing repair kit



Sans visserie Without screws and bolts

1.2		KC03/0T/0W/1D/1P
1.2i 16v.		KC0A/0F/01/1A/0K
1.4		KC0C/0H
1.5 DCi		KC07
1.6i 16v. 2WD		KC0P
1.9 D		KC0D/0E/0J
1.9 DCi 2WD		KC0V
1.9 DTi		KC0U
TT Elec. /All models Electric		KC0Z

7964003

Kit rép. train AV

OE -

Front axle repair kit



Sans visserie Without screws and bolts

1.4	sauf tout chemin	KC0C	-03/03/99
1.9 D	sauf tout chemin	KC0D/0E	
1.9 DTi	sauf tout chemin	KC0U	

405A423S

Kit rép. train AV

OE -

Front axle repair kit



Sans visserie Without screws and bolts Barre Ø 23

1.2/i 16v.		KC03	KC0K
1.2/i 16v.	Véhicule tout chemin	KC0W/1D/1P	KC01/0A/0F
1.4	Véhicule tout chemin	KC0C/0H	
1.5 DCi	Véhicule tout chemin	KC07	
1.9 D		FC02	
1.9 D	Véhicule tout chemin	KC0D/0E/0J	
1.9 DCi 2WD	Véhicule tout chemin	FC0V	
1.9 DTi	Véhicule tout chemin	KC0U	

... Kangoo I -02/03 VL ...





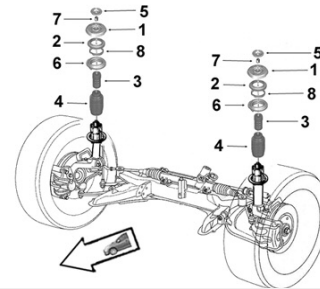





Support d'amortisseur
 Suspension mounting
 Soporte amortiguador
 Poduszka amortyzatora
 Опора амортизатора



RENAULT

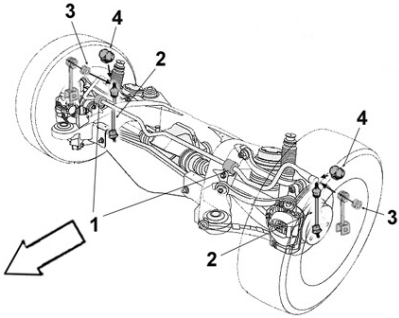

4001620 OE 7700426450	Coupelle rebond. <i>Spring cup</i>	4001615 OE 7700829529	Tampon suspension G/D <i>L/R susp. rebound stop</i>
	5 1.2i 16v. KC03/1D/1P 1.4 KC0C/0H 1.5 DCi KC07/08 1.6i KC00 1.6i 16v. KC0P/0R/0S/1B 1.9 D KC02/0D/0E 1.9 DCi KC0V 1.9 DTi KC0U		1 1.2 KC01/0A/1A/0K 1.2i 16v. KC03/1D/1P 1.4 KC0C/0H 1.5 DCi KC07/08/09 1.6i KC00 1.6i 16v. KC0P/0R/0S/1B 1.9 D KC02/0D/0E 1.9 DCi KC0V 1.9 DTi KC0U
4005300 OE 8200651172	Butée à billes G/D <i>L/R ball bearing</i>	4005373 OE 7700802667	Butée protecteur susp. G/D <i>L/R suspension bush</i>
	2 1.2i / GPL KC01/0A/1A/0K 1.2i 16v. KC03/1D/1P 1.4 KC0C/0H 1.5 DCi KC07/08/09 1.6i KC00 1.6i 16v. KC0P/0R/0S/1B 1.9 D KC02/0D/0E 1.9 DCi KC0V 1.9 DTi KC0U		3 1.2 KC01/0A/1A/0K 4 1.2i 16v. KC03/1D/1P 1.4 KC0C/0H 1.5 DCi KC07/08/09 1.6i KC00 1.6i 16v. KC0L/0P/0R/0S/1B 1.9 D KC02/0D/0E 1.9 DCi KC0V 1.9 DTi KC0U
4005229 OE -	Kit rép. suspension G ou D <i>L/R stabilizing bar repair kit</i>		
	1.2 KC01/0A/0F/1A/0K 1.2i 16v. KC03/05/0T/0W/1D/1P 1.4 KC0C/0H 1.5 DCi KC07 1.6i 16v. KC0P 1.9 D KC02/0D/0E/0J 1.9 DCi KC0V 1.9 DTi KC0U TT Elec. /All models Electric KC0Z		
	Barre stabilisatrice Stabilizer bar Barra estabilizadora Drażek stabilizatora стабилизатор поперечной устойчивости		
			
4005149 OE 7700436706	Biellette barre stab. <i>Stabilizer bar stub axle</i>		
	2 1.6i 16v. 4WD KC0P/0S 1.9 DCi 4WD KC0V		

... Kangoo I -02/03 VL

Eléments TRAIN ARRIERE

Rear axle parts

Tren TRAS

Elementy zawieszenia tylnego

элементы задней оси.



SASIC

RENAULT

4005350B

Kit rép. train AR G ou D

OE -

L/R rear axle repair kit



Train à tube

1.2	KC01/0A/0F/0K
1.2i 16v.	KC03/05/0T/0W/1D/1P/1K
1.4	KC0B/0C/0H/0M
1.5 DCi	KC07
1.6i 16v.	KC0P
1.9 D	KC02/0D/0E/0J
1.9 DCi	KC0V
1.9 DTi	KC0U
TT Elec. /All models Electric	KC0Z

Kangoo I 03/03-12/07 VL ...

Eléments DIRECTION

Steering parts

Elementos Direcciones

Elementy układ kierowniczy

Элементы рулевой системы

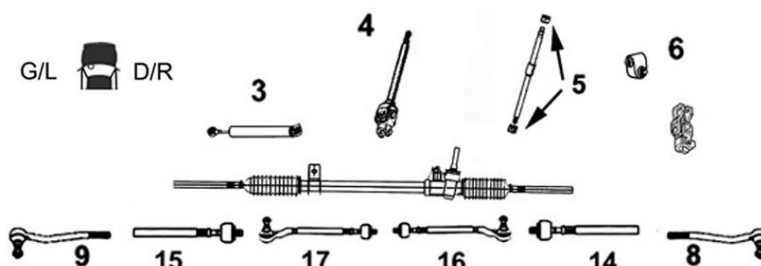

3008035

Axe de bielle G/D

Part/oe 7701472113

L/R axial joint



14 Côté dir. M12x1.0 Côté rot. M14x1.5 long 303 mm

1.0		KC0Y
1.0i 16v.	DNA	KC06
1.2	DNA	KC01/0A/0F/1A
1.2		KC0K
1.2i 16v.	DNA	KC03/05/0T/0W/1D/1P
1.4	DNA	KC0B/0M
1.5 DCi	DNA	KC07/08/09/1F
1.9 D	DNA	KC0D/0E/0J/02/0N

3008040

Axe de bielle G/D

Part/oe 7701472120

L/R axial joint



14 Côté dir. M12x1.0 Côté rot. M14x1.5 long 305 mm

1.0i 16v.	DA	KC06
1.2	DA	KC01/0A/0F/1A
1.2		KC1H
1.2i 16v.	DA	KC03/05/0T/0W/1D/1P
1.2i 16v.		KC1K
1.4	DA	KC0B/0M
1.4		KC1V
1.5 DCi	DA	KC07/08/09/1F
1.5 DCi		KC1E/1G/1R/1S
1.6i 16v. 2WD		KC0L/0P/0S/1N
1.9 D	DA	KC0D/0E/0J/02/0N
1.9 DCi 2WD		KC0V
TT Elec. /All models Electric		KC0Z

3008243

Axe de bielle G/D

Part/oe 7701473656

L/R axial joint





14 Côté dir. M12x1.0 Côté rot. M14x1.5 long 314 mm

1.6i 16v. 4WD		KC0L/0P/0S/1N
1.9 DCi 4WD		KC0V

... Kangoo I 03/03-12/07 VL ...

RENAULT





4006134 OE 7701474641	Rotule de direction G <i>Left tie rod end</i>	4006135 OE 7701474642	Rotule de direction D <i>Right tie rod end</i>
	9 1.0i 16v. 1.2/i 16v. 1.4 1.5 DCi 1.6i 16v. 1.9 D 1.9 DCi TT Elec. /All models Electric		8 1.0i 16v. 1.2/i 16v. 1.4 1.5 DCi 1.6i 16v. 1.9 D 1.9 DCi TT Elec. /All models Electric



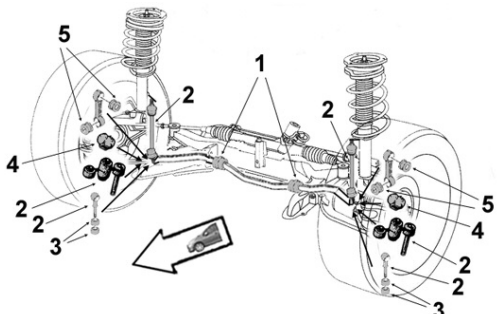

Barre stabilisatrice
Stabilizer bar
Barra estabilizadora
Drażek stabilizatora
 стабилизатор поперечной устойчивости



4005148 OE 7700437136	Biellette barre stab. <i>Stabilizer bar stub axle</i>	
	2 1.6i 16v. 4WD KC0L/0P/0S	

4001505 OE 7700799404+7703034237	Palier de barre bout <i>End bar main bearing</i>	
	2 1.2i /GPL 1.2i /GPL tout chemin Sans protection spéciale 1.2i 16v. 1.2i 16v. tout chemin Sans protection spéciale 1.4i tout chemin Sans protection spéciale 1.5 DCi 1.5 DCi tout chemin Sans protection spéciale 1.6i 16v. 2WD 1.9 D tout chemin Sans protection spéciale 1.9 DCi 2WD tout chemin Sans protection spéciale	KC1A/1H -16/01/07 KC01/0A/0F -16/01/07 KC0T/1K -16/01/07 KC05/0W/1D/1P -16/01/07 KC0B/0M -16/01/07 KC1F/1R/1S -16/01/07 KC07/08/09/1V -16/01/07 KC0L/0P/0S/1N -16/01/07 KC0D/0E/0J/0N -16/01/07 KC0U/0V -16/01/07

4005134 OE 7700314855	Palier de barre bout <i>End bar main bearing</i>	
	4 Barre Ø 23 1.2 tout chemin KC01/0A/0F 1.2i 16v. KC03 1.2i 16v. tout chemin KC05/0W/1D/1P 1.5 DCi tout chemin KC07/08/09 1.9 D KC02 1.9 D tout chemin KC0J	

4001476 OE 7700785788	Palier de barre milieu <i>Middle bar main bearing</i>	
	1 Barre Ø 23 1.2 KC01/0A/1A KC0F/0K 1.2i 16v. KC03/05/0T/0W/1D/1P 1.4i /16v. KC0B/0M/1V 1.5 DCi KC07/08/09 1.6i 16v. KC0L/0P/0R/0S/1B 1.9 D KC02/0J 1.9 DCi KC0V TT Elec. /All models Electric KC0Z	

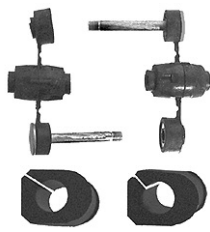
4005078 OE -	Kit rép. barre stab. G et D <i>L R Stabilizing bar repair kit</i>	
	Barre percée Ø 23 1.2 KC05/0T/0W/1D/1P 1.2 sauf tout chemin KC1P 1.2i 16v. KC1A 1.2i 16v. sauf tout chemin KC01/0A/0F 1.5 DCi sauf tout chemin KC07/08/09 1.6i 16v. 2WD KC0L/0P/0S 1.9 D sauf tout chemin KC0D/0E/0J TT Elec. /All models Electric KC0Z	

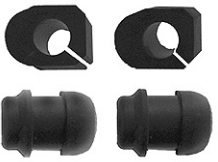
4005080 OE -	Kit rép. barre stab. G et D <i>L R Stabilizing bar repair kit</i>	
	Barre Ø 23 1.2 KC03 1.2 véhicule tout chemin KC05/0W/1D/1P 1.2i 16v. KC0K 1.2i 16v. véhicule tout chemin KC01/0A/0F 1.5 DCi véhicule tout chemin KC07/08/09 1.9 D KC02 1.9 D véhicule tout chemin KC0D/0E/0J	

Les réf. constructeurs (OE) ne servent qu'à identifier les pièces et sont données à titre indicatif.

... Kangoo I 03/03-12/07 VL ...



Eléments SUSPENSION

Suspension parts
Elementos suspensión
Elementy zawieszanie
Элементы подвески

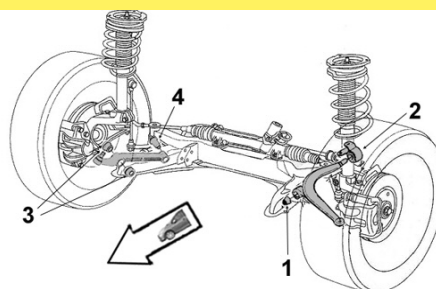

RENAULT

SASIC

4001546

Articulation AV/AR

OE 8200711554

Front rear bush



- 1 Ø int.12 Ø ext.45 coll.59
2 long. tube int.46 ext.30 ep. coll.4

1.2 KC0A/0F/0K/01/1A
1.2i 16v. KC0T/0W/03/1D/1P
1.5 DCi tout chemin KC07/08/09
1.6i 16v. 2WD KC0L/0P/0S
1.9 D tout chemin KC0J
1.9 DCi 2WD tout chemin KC0V

4001540

Articulation AV/AR

OE 8200651161

Front rear bush



- 1 Ø int.12 Ø ext.45.5 coll.59
2 long. tube int.46 ext.29.5 ep. coll.4

1.5 DCi sauf tout chemin KC07/08/09
1.9 D sauf tout chemin KC0J
1.9 DCi 2WD sauf tout chemin KC0V
1.9 DTi sauf tout chemin KC0V
TT Elec. /All models Electric KC0Z

4005502

Articulation AV/AR

OE 8200033379

Front rear bush



- 1 Ø int.12 Ø ext.45 coll.47.8 long. tube int.46 ext.29 ep. Coll.4.1
2

1.6i 16v. 4WD KC0L/0P/0S
1.9 DCi 4WD KC0V

Bras & Triangle de suspension

Control arm
Brazo y triángulo
Wahacz
Рычаг подвески

G/L D/R



4003210

Triangle de susp. G

OE 7701474869

Left track control arm



- 4 **Sans rotule** Without tie rod end

1.0i 16v. 2WD véhicule tout chemin	KC06	-16/09/03
1.0 2WD véhicule tout chemin	KC0Y	-16/09/03
1.2i 16v. 2WD véhicule tout chemin	KC03/05/0T/1D/1P/1K/0W	-16/09/03
1.2 2WD sauf tout chemin	KC0A	03/03/99-
1.2 2WD véhicule tout chemin	KC0F/0K/01/1A/1H	-16/09/03
1.4 2WD véhicule tout chemin	KC0B/0M	-16/09/03
1.5 DCi 2WD Véhicule tout chemin	KC08/09	-16/09/03
1.6i 16v. 2WD Véhicule tout chemin	KC1U/10/14/1W/1Y/0M/0P/0L/0S/1T	-16/09/03
1.9 D 2WD Véhicule tout chemin	KC0D/0J/02	-16/09/03
1.9 DCi 2WD Véhicule tout chemin	KC0V	-16/09/03
TT Elec. /All models Electric 2WD Véhicule tout chemin	KC0Z	-16/09/03

4003211

Triangle de susp. D

OE 7701474870

Right track control arm



- 3 **Sans rotule** Without tie rod end

1.0i 16v. 2WD véhicule tout chemin	KC06	-16/09/03
1.0 2WD véhicule tout chemin	KC0Y	-16/09/03
1.2i 16v. 2WD véhicule tout chemin	KC03/05/0T/1D/1P/1K/0W	-16/09/03
1.2 2WD sauf tout chemin	KC0A	03/03/99-
1.2 2WD véhicule tout chemin	KC0F/0K/01/1A/1H	-16/09/03
1.4 2WD véhicule tout chemin	KC0B/0M	-16/09/03
1.5 DCi 2WD Véhicule tout chemin	KC08/09	-16/09/03
1.6i 16v. 2WD Véhicule tout chemin	KC1U/10/14/1W/1Y/0M/0P/0L/0S/1T	-16/09/03
1.9 D 2WD Véhicule tout chemin	KC0D/0J/02	-16/09/03
1.9 DCi 2WD Véhicule tout chemin	KC0V	-16/09/03
TT Elec. /All models Electric 2WD Véhicule tout chemin	KC0Z	-16/09/03

... Kangoo I 03/03-12/07 VL ...

RENAULT



4003226 Triangle de susp. G			
Part/oe 8200254163		<i>Left track control arm</i>	
	4	Sans rotule Without tie rod end sauf tout chemin	
		1.2i 16v. 2WD	KC0T/1D/1P/1K/0W -17/01/07
		1.2 2WD	KC1A/1H -17/01/07
		1.2 2WD	KC0F/01 28/03/01-17/01/07
		1.4 2WD	KC0B/0M 28/03/01-17/01/07
		1.5 DCi 2WD	KC08/09 -17/01/07
		1.6i 16v. 2WD	KC0P 28/03/01-17/01/07
		1.6i 16v. 2WD	KC0L/0S -17/01/07
		TT Elec. /All models Electric 2WD	KC0Z 28/03/01-18/09/02
4003227 Triangle de susp. D			
Part/oe 8200254166		<i>Right track control arm</i>	
	3	Sans rotule Without tie rod end sauf tout chemin	
		1.2i 16v. 2WD	KC0T/1D/1P/1K/0W -17/01/07
		1.2 2WD	KC1A/1H -17/01/07
		1.2 2WD	KC0F/01 28/03/01-17/01/07
		1.4 2WD	KC0B/0M 28/03/01-17/01/07
		1.5 DCi 2WD	KC08/09 -17/01/07
		1.6i 16v. 2WD	KC0P 28/03/01-17/01/07
		1.6i 16v. 2WD	KC0L/0S -17/01/07
		TT Elec. /All models Electric 2WD	KC0Z 28/03/01-18/09/02
4003367 Triangle de susp. G		4003366 Triangle de susp. D	
OE 8200197179		OE 8200197187	
<i>Left track control arm</i>		<i>Right track control arm</i>	
	4	Avec rotule With ball joint	3
		1.9 D 2WD sauf tout chemin KC0D	1.9 D 2WD sauf tout chemin KC0D
7474030 Triangle de susp. G		7474029 Triangle de susp. D	
OE 8200942407		OE 8200942408	
<i>Left track control arm</i>		<i>Right track control arm</i>	
	4	Avec rotule With ball joint Ø 16	3
		1.9 D 2WD Chemin normal Sans protection spéciale KC0D F8Q662	1.9 D 2WD Chemin normal Sans protection spéciale KC0D F8Q662
4005273 Rotule de susp. inf. G/D			
OE 7701468411 <i>L/R lower suspension ball joint</i>			
	1	Trous fixation Ø10	
	2	1.0i 16v. 2WD	Véhicule tout chemin KC06 -16/09/03
		1.0 2WD	Véhicule tout chemin KC0Y -16/09/03
		1.2 2WD	sauf tout chemin KC0A 03/03/99-
		1.2 2WD	Véhicule tout chemin KC0F/0K/01/1A/1H -16/09/03
		1.2i 16v. 2WD	Véhicule tout chemin KC03/05/0T/1D/1P/1K/0W -16/09/03
		1.4 2WD	Véhicule tout chemin KC0B/0M -16/09/03
		1.5 DCi 2WD	Véhicule tout chemin KC07 -16/09/03
		1.5 DCi 2WD	Véhicule tout chemin KC08/09 -16/09/03
		1.9 D 2WD	Véhicule tout chemin KC0E/0N -16/09/03
		1.9 D 2WD	Véhicule tout chemin KC0D/0J/02 -16/09/03
		1.9 DCi 2WD	Véhicule tout chemin KC0V -16/09/03
	4005277 Rotule de susp. inf. G/D		
Part/oe 8200942407 <i>L/R lower suspension ball joint</i>			
	1	Trous fixation Ø12 sauf tout chemin	
	2	1.2 2WD	KC1A/1H -17/01/07
		1.2 2WD	KC0F/01 28/03/01-17/01/07
		1.2i 16v. 2WD	KC05
		1.2i 16v. 2WD	KC0T/1D/1P/1K/0W -17/01/07
		1.4 2WD	KC0B/0M 28/03/01-17/01/07
		1.5 DCi 2WD	KC07/1E/1F/1G/1R/1S
		1.5 DCi 2WD	KC08/09 -17/01/07
		1.6i 16v. 2WD	KC0P 28/03/01-17/01/07
		1.6i 16v. 2WD	KC0L/0S -17/01/07
		1.9 D 2WD	KC0E/0J/0N
		1.9 DCi 2WD	KC0V
		TT Elec. /All models Electric 2WD	KC0Z 28/03/01-18/09/02

... Kangoo I 03/03-12/07 VL ...

SASIC

RENAULT

Bras & Triangle de suspension

Control arm
Brazo y triángulo
Wahacz
Рычаг подвески

G/L  D/R



4005423

Kit rép. triangle susp. G ou D

OE -

L or R track control arm bearing repair kit



Sans visserie Without screws and bolts

1.2	KC03/0T/0W/1D/1P
1.2i 16v.	KC0A/0F/01/1A/0K
1.5 DCi	KC07/08/09
1.6i 16v. 2WD	KC0L/0P/0S
1.9 D	KC0D/0E/0J
1.9 DCi 2WD	KC0V
TT Elec. /All models Electric	KC0Z

7964003

Kit rép. train AV

OE -

Front axle repair kit



Sans visserie Without screws and bolts

1.5 DCi sauf tout chemin KC07/08/09
TT Elec. /All models Electric KC0Z

405A423S

Kit rép. train AV

OE -

Front axle repair kit



Sans visserie Without screws and bolts
Barre Ø 23

1.2 Véhicule tout chemin
KC0W/1D/1P
1.2/i 16v. KC03 KC0K
1.2i 16v. véhicule tout chemin
KC01/0A/0F
1.5 DCi Véhicule tout chemin
KC07/08/09
1.9 D Véhicule tout chemin
KC0D/0E/0J



Support d'amortisseur

Suspension mounting
Soporte amortiguador
Poduszka amortyzatora
Опора амортизатора

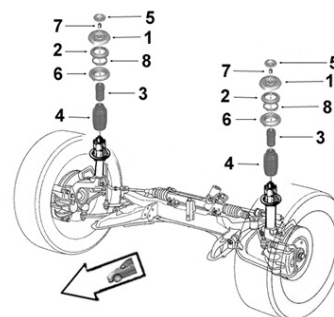

4001620

Coupelle rebond.

OE 7700426450

Spring cup



5

1.2	KC01/0A/1A/0K D4F/7F
1.2i / GPL	KC0F D4F D7F
1.2i 16v.	KC03/05/0T/0W/1D/1P
1.5 DCi	KC07/08/09
1.6i 16v.	KC0L/0P/0R/0S/1B
1.9 D	KC02/0J
1.9 DCi	KC0V
TT Elec. /All models Electric	KC0Z

4001615

Tampon suspension G/D

OE 7700829529

L/R susp. rebound stop



1

1.2	KC01/0A/0F/0K/1A
1.2i 16v.	KC03/05/0T/0W/1D/1P
1.5 DCi	KC07/08/09
1.6i 16v.	KC0L/0P/0R/0S/1B
1.9 D	KC02/0J
1.9 DCi	KC0V
TT Elec. /All models Electric	KC0Z

4005300

Butée à billes G/D

OE 8200651172

L/R ball bearing



2

1.2	KC01/0A/0F/0K/1A
1.2i 16v.	KC03/05/0T/0W/1D/1P
1.4i	KC0B/0M/1V
1.5 DCi	KC07/08/09
1.6i 16v.	KC0L/0P/0R/0S/1B
1.9 D	KC02/0J
1.9 DCi	KC0V
TT Elec. /All models Electric	KC0Z

4005373

Butée protecteur susp. G/D

OE 7700802667

L/R suspension bush



3

1.2	KC01/0A/0F/0K/1A
1.2i 16v.	KC03/05/0T/0W/1D/1P
1.4i	KC0B/0M/1V
1.5 DCi	KC07/08/09
1.6i 16v.	KC0L/0P/0R/0S/1B
1.9 D	KC02/0J
1.9 DCi	KC0V
TT Elec. /All models Electric	KC0Z

... Kangoo I 03/03-12/07 VL

RENAULT



4005229

Kit rép. suspension G ou D

OE -

L/R stabilizing bar repair kit



1.2	KC03/05/0T/0W/1D/1P
1.2i 16v.	KC01/0A/0F/1A/0K
1.5 DCi	KC07/08/09
1.6i 16v.	KC0L/0P/0R/0S/1B
1.9 D	KC02/0D/0E/0J
1.9 DCi	KC0V
TT Elec. /All models Electric	KC0Z



Barre stabilisatrice

Stabilizer bar
Barra estabilizadora
Drażek stabilizatora
стабилизатор поперечной устойчивости

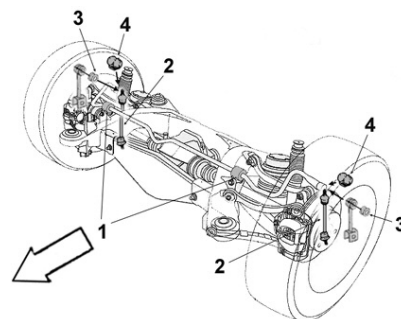

4005149

Biellette barre stab.

OE 7700436706

Stabilizer bar stub axle

2



1.6i 16v. 4WD	KC0P/0S
1.9 DCi 4WD	KC0V



Eléments SUSPENSION

Suspension parts
Elementos suspensión
Elementy zawieszenia
Элементы подвески

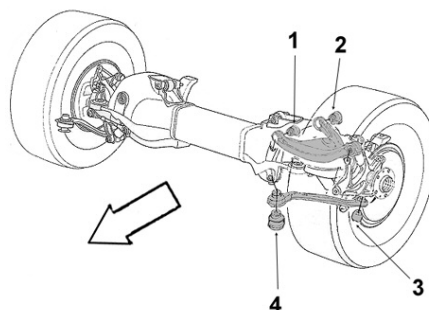

4001587

Articulation

OE 7700436707

Bush

1
2

Ø int.12 Ø ext.40 coll.50 long. tube int.60 ext.43 ep. coll.7



1.6i 16v. 4WD	KC0P/0S
1.9 DCi 4WD	KC0V

Eléments TRAIN ARRIERE

Rear axle parts
Tren TRAS
Elementy zawieszenia tylnego
элементы задней оси.



4005350B

OE -

Kit rép. train AR G ou D

L/R rear axle repair kit

Train à tube



1.2	KC03/05/0T/0W/1D/1P/1K
1.4	KC0B/0M
1.5 DCi	KC07/08/09/1E/1F/1G/1R/1S
1.6i 16v.	KC0L/0P/0R/0S/1B/1N
1.9 D	KC02/0D/0E/0J
1.9 DCi	KC0V
TT Elec. /All models Electric	KC0Z

Kangoo II 01/08- VL ...

Eléments DIRECTION

Steering parts

Elementos Direcciones

Elementy układ kierowniczy

Элементы рулевой системы

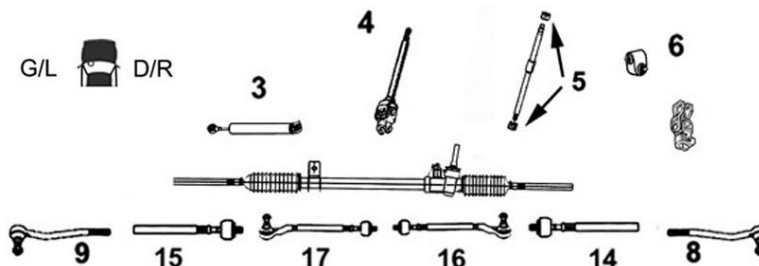

RENAULT

7774013

Axe de bielle G/D

Part/oe 485215961R

L/R axial joint



14 Côté dir. M14x1.5 Côté rot. M14x1.5 long 215 mm

15

1.2 TCE
1.5 DCi
1.6i
1.6i 16v.

KW02
KW0B/C/F/G/H/K/L/V/4/5/6/7/8
KW00/E/N/P/Y
KW0D/U/W/1/3/9 KW13

7674008

Rotule de direction G

OE 7701478407

Left tie rod end



9 M14 x 1.5

1.2 TCE KW02
1.5 DCi KW0B/C/F/G/H/K/L/V/4/5/6/7/8
1.6i KW00/E/N/P/Y
1.6i 16v. KW0D/U/W/1/3/9 KW13

7674009

Rotule de direction D

OE 7701478408

Right tie rod end



8 M14 x 1.5

1.2 TCE KW02
1.5 DCi KW0B/C/F/G/H/K/L/V/4/5/6/7/8
1.6i KW00/E/N/P/Y
1.6i 16v. KW0D/U/W/1/3/9 KW13



Barre stabilisatrice

Stabilizer bar

Barra estabilizadora

Drażek stabilizatora

стабилизатор поперечной устойчивости

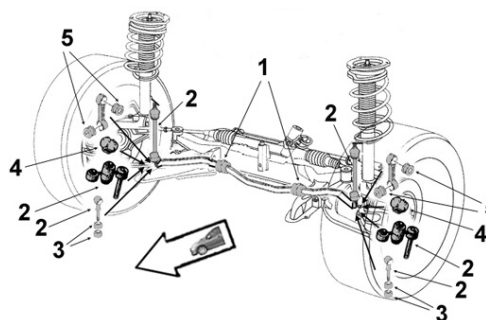

4005146

Biellette barre stab.

OE 8200669065

Stabilizer bar stub axle



2

1.5 DCi KW0B/0C/0F/0G/0K/0L
KW04/05/0H/0V
1.6i KW00/0E/0N/0P/0Y
1.6i 16v. KW0D/0W/01/0U

2304020

Palier de barre milieu

OE 7701070790

Middle bar main bearing



1 Barre Ø 19

1.5 DCi Equipement E0M KW0L
1.5 DCi Equipement EA0 KW04
1.6i Equipements E0M EA0
KW00/0E/0N/0P/0Y
1.6i Equipement EA0 KW00/0E/0P

2304022

Palier de barre milieu

OE 7701069131

Middle bar main bearing



1 Barre Ø 20

1.5 DCi Equipements E1B/E3C/E3P/E3S/EA1/EA2/EA3/EA4/E0E/E1B KW0B/0C/0F/0G/0K/0L/0V
KW04/05/0H/08
1.6i Equipements EA1/EA2/E1B/E3C KW00/0E/0N/0P/0Y
1.6i 16v. Equipements E0E/E1B/E3C/E3P/E3S/EA1/EA2/EA3/EA4 KW01/0D/0W/0U/03

... Kangoo II 01/08- VL

RENAULT



Bras & Triangle de suspension

Control arm
Brazo y triángulo
Wahacz
Рычаг подвески

G/L D/R

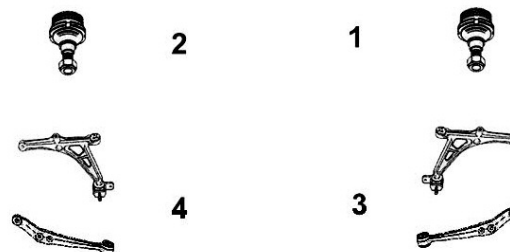

7474003

Triangle de susp. G

OE 8200586561

Left track control arm

4 Avec rotule With ball joint



1.2 TCE KW02
1.5 DCi KW0B/C/F/G/H/K/L/V
KW4/5/6/7/8

1.6i KW00/E/N/P/Y
1.6i 16v. KW0D/U/W/1/3/9 KW13

7474005

Triangle de susp. D

OE 8200586567

Right track control arm

3 Avec rotule With ball joint



1.2 TCE KW02
1.5 DCi KW0B/C/F/G/H/K/L/V
KW4/5/6/7/8

1.6i KW00/E/N/P/Y
1.6i 16v. KW0D/U/W/1/3/9 KW13

7574008

Rotule de susp. G

Part/oe 8200586561

L Susp. ball joint

2



1.2 TCE KW02
1.5 DCi KW0B/C/F/G/H/K/L/V
KW4/5/6/7/8

1.6i KW00/E/N/P/Y
1.6i 16v. KW0D/U/W/1/3/9 KW13

7574009

Rotule de susp. D

Part/oe 8200586567

R Suspension ball joint

1



1.2 TCE KW02
1.5 DCi KW0B/C/F/G/H/K/L/V
KW4/5/6/7/8

1.6i KW00/E/N/P/Y
1.6i 16v. KW0D/U/W/1/3/9 KW13



Support d'amortisseur

Suspension mounting
Soporte amortiguador
Poduszka amortyzatora
Опора амортизатора

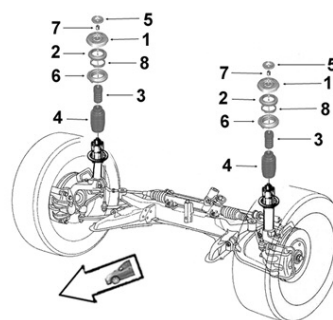

2654011

Support suspension

OE 8200591283

Suspension mounting

1

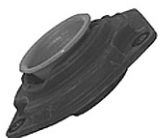

1.5 DCi KW0B/C/F/G/H/K/L/V/4/5
1.6i KW00/E/N/P/Y
1.6i 16v. KW0D/U/W/1

Éléments TRAIN ARRIERE

Rear axle parts
Tren TRAS
Elementy zawieszenia tylnego
элементы задней оси.



2604002

Articulation essieu

OE 8200380965

Axle bush



Ø int. 12 Ø ext. 70 coll. 80
long. tube int. 90 ext. 58 ep. coll.10

1.5 DCi KW0B/0C/0F/0G/0K/0L/0V
KW/04/05/0H

1.6i KW00/0E/0N/0P/0Y
1.6i 16v. KW0D/0W/01/0U

Koléos ...

Eléments DIRECTION

Steering parts

Elementos Direcciones

Elementy układu kierowniczy

Элементы рулевой системы

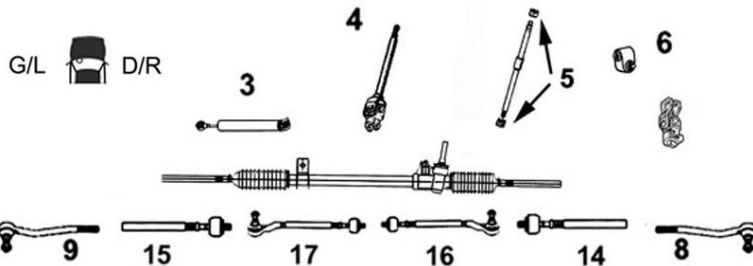

RENAULT

SASIC

7774019

Axe de bielle G/D

Part/oe 485219204R

L/R axial joint

NEW



14 Côté dir. M22x1.5 Côté rot. M14x1.5
15 long 233 mm

2.0i 16v. HY0R/S/T -03/11

2.0 DCi HY0A/B/F/G/H/J/K/L/V/W
-03/11

2.5i HY0C/D/E/N/P/0 -03/11

7774020

Axe de bielle G/D

Part/oe 485213026R

L/R axial joint

NEW



14 Côté dir. M18x1.5 Côté rot. M14x1.5
15 long 239 mm

2.0i 16v. HY0R/S/T 04/11-

2.0 DCi HY0A/B/F/G/H/J/K/L/V/W
04/11-

2.5i HY0C/D/E/N/P/0 04/11-

7676040

Rotule de direction G

OE 485207812R

Left tie rod end



9 M14x1.5

2.0i 16v. HY0R/S/T 04/11-

2.0 DCi HY0A/B/F/G/H/J/K/L/V/W
04/11-

2.5i HY0C/D/E/N/P/0 04/11-

7676039

Rotule de direction D

OE 485200604R

Right tie rod end



8 M14x1.5

2.0i 16v. HY0R/S/T 04/11-

2.0 DCi HY0A/B/F/G/H/J/K/L/V/W
04/11-

2.5i HY0C/D/E/N/P/0 04/11-



Barre stabilisatrice

Stabilizer bar

Barra estabilizadora

Drażek stabilizatora

стабилизатор поперечной устойчивости

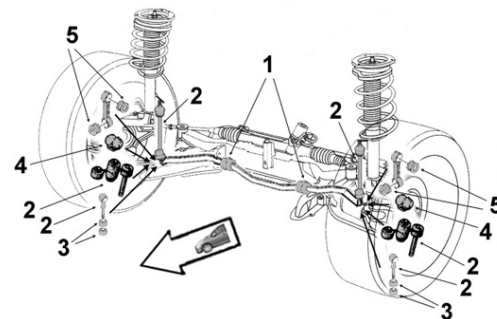

2304010

Biellette barre stab. G

OE 54668JD00A

Left stabilizer bar stub axle



2

2.0 DCi HY0A/0B/0F/0G/0H/0J/0K/0L

2.5i HY0C/0D/0E/0N/0P

2304009

Biellette barre stab. D

OE 54618JD00A

Right stabilizer bar stub axle



2

2.0 DCi HY0A/0B/0F/0G/0H/0J/0K/0L

2.5i HY0C/0D/0E/0N/0P

... Koléos



Support d'amortisseur
Suspension mounting
Soporte amortiguador
Poduszka amortyzatora
Опора амортизатора

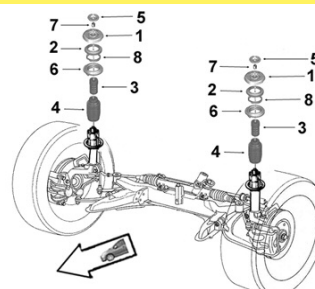

2654022

Support suspension G

OE 543200919R

Left suspension mounting

NEW

1



2.0 DCi HY0A/B/F/G/H/J/K/L
 2.5i HY0C/D/E/N/P

8005213

Butée à billes

OE 54325ED02A

Ball bearing

2



2.0 DCi HY0A/B/F/G/H/J/K/L
 2.5 HY0C/D/E/N/P



Barre stabilisatrice

Stabilizer bar
Barra estabilizadora
Drażek stabilizatora
стабилизатор поперечной устойчивости

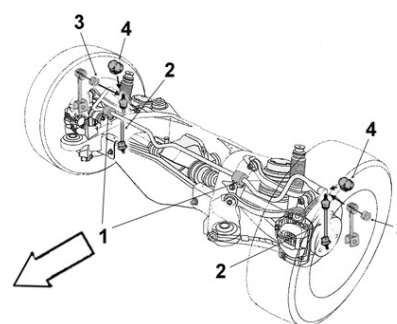

2304013

Biellette barre stab. G

OE 55619JY00B

Left stabilizer bar stub axle

2



2.0 DCi HY0A/0B/0F/0G/0H/0J/0K/0L
 2.5i HY0C/0D/0E/0N/0P

2304012

Biellette barre stab. D

OE 55618JY00B

Right stabilizer bar stub axle

2



2.0 DCi HY0A/0B/0F/0G/0H/0J/0K/0L
 2.5i HY0C/0D/0E/0N/0P



Support d'amortisseur

Suspension mounting
Soporte amortiguador
Poduszka amortyzatora
Опора амортизатора

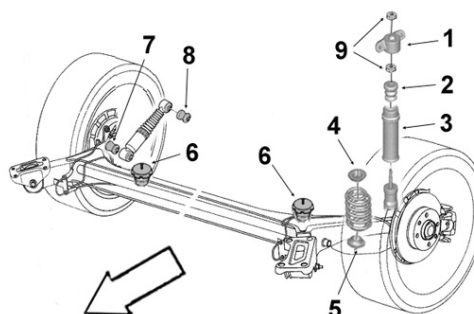

2654029

Coupelle sup. ressort AR

OE 55034JY00A

Rear spring upper cup

4



2.0i 16v. HY0R
 2.0 DCi HY0A/0B/0F/0G/0H/0J/0K/0L
 2.5i HY0C/0D/0E/0N/0P

RENAULT

SASIC

Laguna I ...

Eléments DIRECTION

Steering parts

Elementos Direcciones

Elementy układ kierowniczy

Элементы рулевой системы

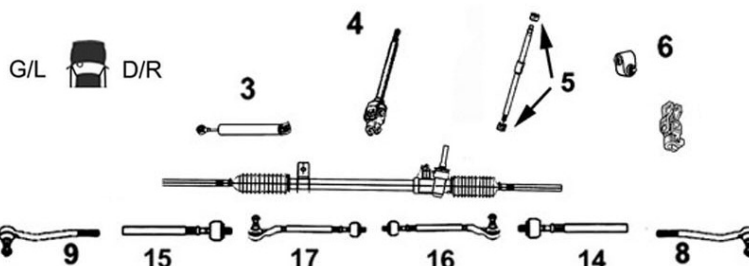
**3008235****Axe de bielle G/D**

Part/oe 7701469665

L/R axial joint



14 Côté dir. M12x1.0 Côté rot. M14x1.5 long 265 mm

15

TT /all models

01/94-12/01

4006235**Bielle de direction G**

OE 7701467501

Left steering rod



17

TT /all models

01/94-12/01

4006237**Bielle de direction D**

OE 7701467502

Right steering rod



16

TT /all models

01/94-12/01

4006128**Rotule de direction G**

OE 6000022737

Left tie rod end

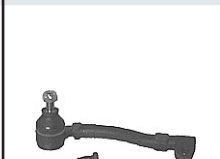

9

TT /all models

01/94-12/01

4006129**Rotule de direction D**

OE 6000022736

Right tie rod end

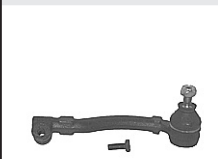

8

TT /all models

01/94-12/01

**Barre stabilisatrice**

Stabilizer bar

Barra estabilizadora

Drażek stabilizatora

стабилизатор поперечной устойчивости

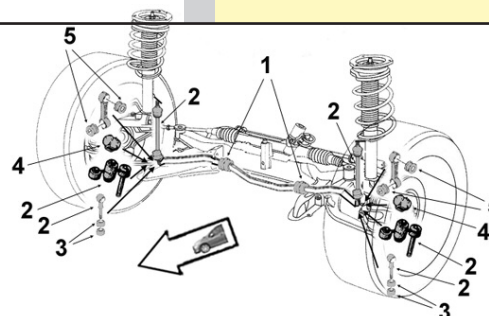
**4005132****Biellette barre stab.**

OE 7700805494

Stabilizer bar stub axle



2

TT /all models Phase 1

B56A/B/C/H/J/L/N/S

B56D/E/F/M/P/R/V/Z/5/6/9

B56T/Z/0/4/8 S56J

TT /all models Phase 2

01/98-

... Laguna I ...



Eléments SUSPENSION
Suspension parts
Elementos suspensión
Elementy zawieszenie
Элементы подвески

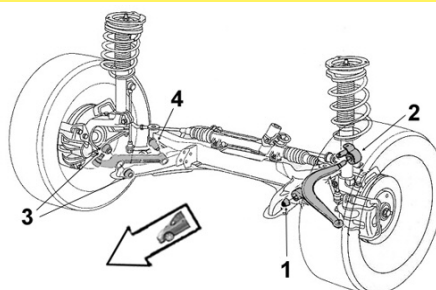

RENAULT



... Laguna I





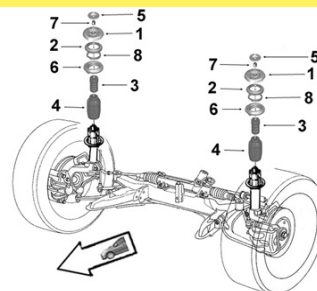

SASIC

RENAULT



Support d'amortisseur
Suspension mounting
Soporte amortiguador
Poduszka amortyzatora
Опора амортизатора



4001606 OE 7700832419	Support suspension G <i>Left suspension mounting</i>	4001607 OE 7700832420	Support suspension D <i>Right suspension mounting</i>
	1 TT /all models Phase 1 B56A/B/C/H/J/L/N/S B56D/E/F/M/P/R/V/Z/5/6/9 B56T/Z/0/4/8 S56J TT /all models Phase 2 01/98-		1 TT /all models Phase 1 B56A/B/C/H/J/L/N/S B56D/E/F/M/P/R/V/Z/5/6/9 B56T/Z/0/4/8 S56J TT /all models Phase 2 01/98-
0355275 OE 7700824022	Butée à billes G/D <i>L/R ball bearing</i>	4001618 OE 7700826619	Butée de suspension G/D <i>L/R suspension bush</i>
	2 TT /all models Phase 1 B56A/B/C/H/J/L/N/S B56D/E/F/M/P/R/V/Z/5/6/9 B56T/Z/0/4/8 S56J TT /all models Phase 2 01/98-		3 TT /all models Phase 1 B56A/B/C/H/J/L/N/S B56D/E/F/M/P/R/V/Z/5/6/9 B56T/Z/0/4/8 S56J TT /all models Phase 2 01/98-
4005224 OE -	Kit rép. suspension G <i>Left susp. mounting repair kit</i>	4005226 OE -	Kit rép. suspension D <i>Right susp. mounting repair kit</i>
	1.6i 16v. B568 01/94-12/01 2.2 D B566 01/94-12/01 2.2 DT B569 01/94-12/01 TT /all models Phase 1 B56A /B/C/D/E/F/H/J/L/M B56N/P/R/S/T/V/Z/0/4/5 TT /all models Phase 2 01/98-		1.6i 16v. B568 01/94-12/01 2.2 D B566 01/94-12/01 2.2 DT B569 01/94-12/01 TT /all models Phase 1 B56A /B/C/D/E/F/H/J/L/M B56N/P/R/S/T/V/Z/0/4/5 TT /all models Phase 2 01/98-

Eléments TRAIN ARRIERE

Rear axle parts
Tren TRAS
Elementy zawieszenia tylnego
элементы задней оси.



4003384 OE 7700762843	Articulation <i>Bush</i>
	Ø int.32 Ø ext.72 long. tube int.73 ext.37 TT /all models Phase 1 B56A/B/C/H/J/L/N B56D/E/F/M/P/R/V/Z/5/6/9 B56S/T/Z/0/4/8 S56J TT /all models Phase 2 01/98-

Laguna I Nevada ...

Eléments DIRECTION
 Steering parts
 Elementos Direcciones
 Elementy układ kierowniczy
 Элементы рулевой системы

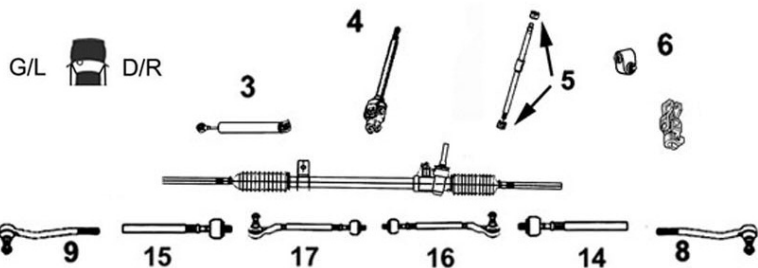

3008235

Axe de bielle G/D

Part/oe 7701469665

L/R axial joint



14 Côté dir. M12x1.0 Côté rot. M14x1.5 long 265 mm

15

TT /all models 01/94-12/01

4006235

Bielle de direction G

OE 7701467501

Left steering rod



17

TT /all models 01/94-12/01

4006237

Bielle de direction D

OE 7701467502

Right steering rod



16

TT /all models 01/94-12/01

4006128

Rotule de direction G

OE 6000022737

Left tie rod end

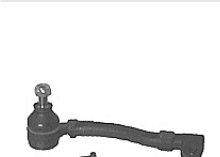

9

TT /all models 01/94-12/01

4006129

Rotule de direction D

OE 6000022736

Right tie rod end

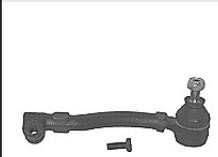

8

TT /all models 01/94-12/01



Barre stabilisatrice

Stabilizer bar

Barra estabilizadora

Drażek stabilizatora

стабилизатор поперечной устойчивости

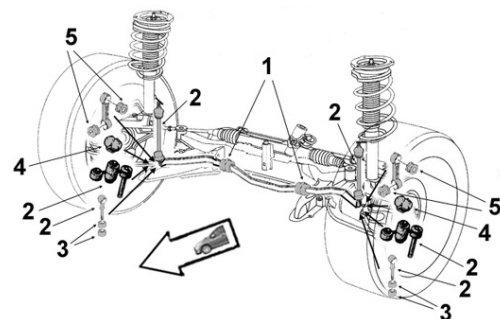

4005132

Biellette barre stab.

OE 7700805494

Stabilizer bar stub axle



2

TT /all models Phase 1

K56C/H/J/L/N/S/T/Z/0/4/8

K56D/F/M/R/V/2/5/6/9

2.2 D Phase 1 Comm.

S56F S566

TT /all models Phase 2

01/98-

... Laguna I Nevada ...



Eléments SUSPENSION

Suspension parts
Elementos suspensión
Elementy zawieszenie
Элементы подвески

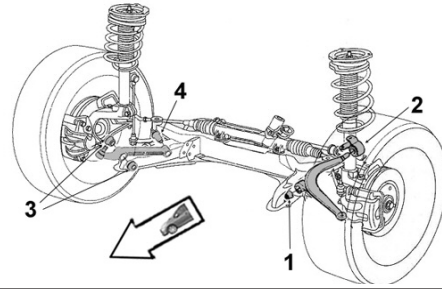

RENAULT

SASIC

4001535

Articulation AV

OE 7700822503

Front bush



1 Ø int.18 Ø ext.55 long. tube int.55 ext.29.5

TT /all models Phase 1
K56C/H/J/L/N/S/T/Z/0/4/8
K56D/F/M/R/V/2/5/6/9
TT /all models Phase 1 Comm.
S56F S566

TT /all models Phase 2 01/98-

4001536

Articulation AR

OE 7700824042

Rear bush



2 Ø int.12 Ø ext.58 long. tube int.55 ext.30

TT /all models Phase 1
K56C/H/J/L/N/S/T/Z/0/4/8
K56D/F/M/R/V/2/5/6/9
TT /all models Phase 1 Comm.
S56F S566

TT /all models Phase 2 01/98-

Bras & Triangle de suspension

Control arm
Brazo y triángulo
Wahacz
Рычаг подвески

G/L  D/R



4003369

Triangle de susp. G

OE 7700413493

Left track control arm



4 Avec rotule With ball joint

TT /all models 01/94-12/01

4003368

Triangle de susp. D

OE 7700413494

Right track control arm



3 Avec rotule With ball joint

TT /all models 01/94-12/01

4005267

Rotule de susp. inf. G/D

OE 7700421804

L/R lower suspension ball joint



1
2

TT /all models 01/94-12/01

1003575

Kit rép. triangle susp. G ou D

OE -

L or R track control arm bearing repair kit



Avec visserie With screws and bolts

TT /all models 01/94-12/01

... Laguna I Nevada



Support d'amortisseur
Suspension mounting
Soporte amortiguador
Poduszka amortyzatora
Опора амортизатора

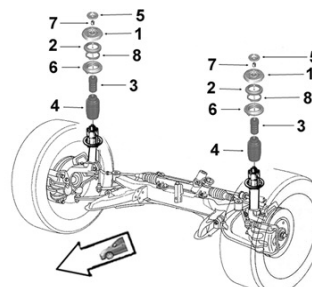

RENAULT



Laguna II ...

Eléments DIRECTION

Steering parts

Elementos Direcciones

Elementy uklad kierowniczy

Элементы рулевой системы

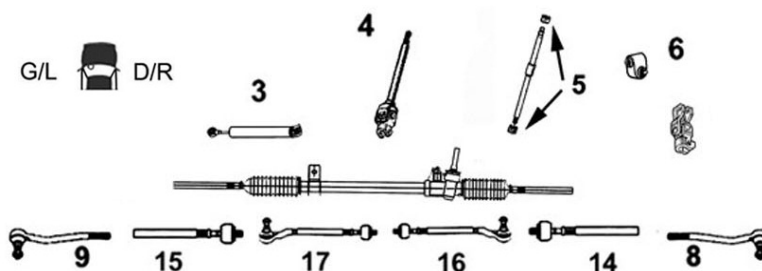

RENAULT

3008042

Axe de bielle G/D

Part/oe 7701478551

L/R axial joint



14 Côté dir. M12x1.0 Côté rot. M14x1.5 long 220 mm

15	1.6i 16v.	BG-
	1.8i 16v.	BG-
	1.9 DCi	BG-
	2.0i 16v.	BG-
	2.0 DCi	BG-
	2.0 IDE	BG-
	2.2 DCi	BG-
	3.0i V6	BG-

4006147

Rotule de direction G

OE 485202714R

Left tie rod end



9	1.6i 16v.	BG-
	1.8i 16v.	BG-
	1.9 DCi	BG-
	2.0i 16v.	BG-
	2.0 DCi	BG-
	2.0 IDE	BG-
	2.2 DCi	BG-
	3.0i V6	BG-

4006148

Rotule de direction D

OE 485209446R

Right tie rod end



8	1.6i 16v.	BG-
	1.8i 16v.	BG-
	1.9 DCi	BG-
	2.0i 16v.	BG-
	2.0 DCi	BG-
	2.0 IDE	BG-
	2.2 DCi	BG-
	3.0i V6	BG-



Barre stabilisatrice

Stabilizer bar

Barra estabilizadora

Drażek stabilizatora

стабилизатор поперечной устойчивости

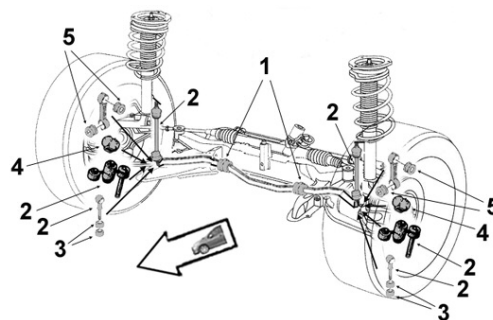

4005141

Biellette barre stab.

OE 8200661217

Stabilizer bar stub axle



2	1.6i 16v.	BG-
	1.8i 16v.	BG-
	1.9 DCi	BG-
	2.0i 16v.	BG-
	2.0 DCi	BG-
	2.0 IDE	BG-
	2.2 DCi	BG-
	3.0i V6	BG-

2304001

Palier de barre milieu

OE 8200272594

Middle bar main bearing



1	Ø19	
	1.6i 16v.	BG0A/0L/0U
	1.8i 16v.	BG0M/04/06/0B/0C/0J/0V
	1.9 DCi	BG0E/08/0R
	1.9 DCi	BG0G/10
	2.0i 16v.	BG00/0W
	2.0i 16v.	BG0K/0S/1L/1M
	2.0 IDE	BG0N
	2.2 DCi	BG0F/09
	3.0i V6 24v.	BG01/02/0D/0Y

2304003

Palier de barre milieu

OE 8200455604

Middle bar main bearing



1	Ø21	
	1.6i 16v.	BG1G/1H
	1.9 DCi	BG05/12/13/1A/1V/1W
	1.9 DCi	BG10
	2.0i 16v.	BG03/0P/0T/0Z/1Y
	2.0i 16v.	BG00/0W
	2.0 DCi	BG14/1S/1T
	2.2 DCi	BG1N
	2.2 DCi	BG09/0F
	3.0i V6 24v.	BG1K
	3.0i V6 24v.	BG01/02/0Y

... Laguna II ...

Bras & Triangle de suspension

Control arm
Brazo y triángulo
Wahacz
Рычаг подвески

G/L  D/R

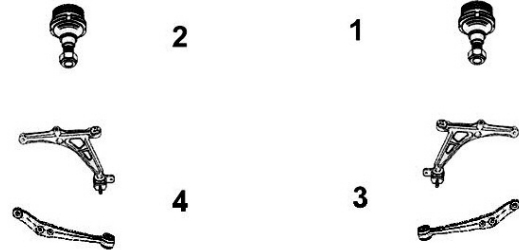

RENAULT



4003319

Triangle de susp. G

Part/oe 8200602612

Left track control arm



4

Sans rotule Without tie rod end

1.6i 16v.	BG0A/0L/0U/1G/1H	
1.8i 16v.	BG04/06/0B/0C/0J/0M/0V	
1.9 DCi	BG08/0E/0G/0R/05/12/13/1A/1V/1W	
1.9 DCi	BG10	-04/05
2.0i 16v.	BG00/0K/0P/0S/0W/0Z/1M/03/0T/1Y	
2.0 DCi	BG1T	
2.0 DCi	Equipements EXC/IMA/SAN913	BG1S
2.0 IDE	BG0N	
2.2 DCi	BG09/0F/1N	
3.0i V6	BG01/02/0D/0Y/1K	

4003320

Triangle de susp. D

Part/oe 8200602613

Right track control arm



3

Sans rotule Without tie rod end

1.6i 16v.	BG0A/0L/0U/1G/1H	
1.8i 16v.	BG04/06/0B/0C/0J/0M/0V	
1.9 DCi	BG08/0E/0G/0R/05/12/13/1A/1V/1W	
1.9 DCi	BG10	-04/05
2.0i 16v.	BG00/0K/0P/0S/0W/0Z/1M/03/0T/1Y	
2.0 DCi	BG1T	
2.0 DCi	Equipements EXC/IMA/SAN913	BG1S
2.0 IDE	BG0N	
2.2 DCi	BG09/0F/1N	
3.0i V6	BG01/02/0D/0Y/1K	

7474023

Triangle de susp. G

OE 8200602630

Left track control arm



NEW

4

Avec rotule With ball joint

1.6i 16v.	BG0A/0L/0U/1G/1H	
1.8i 16v.	BG04/06/0B/0C/0J/0M/0V	
1.9 DCi	BG08/0E/0G/0R/05/12/13/1A/1V/1W	
1.9 DCi	BG10	-04/05
2.0i 16v.	BG00/0K/0P/0S/0W/0Z/1M/03/0T/1Y	
2.0 IDE	BG0N	
2.2 DCi	BG09/0F/1N	
3.0i V6	BG01/02/0D/0Y/1K	

7474024

Triangle de susp. D

OE 8200602631

Right track control arm



NEW

3

Avec rotule With ball joint

1.6i 16v.	BG0A/0L/0U/1G/1H	
1.8i 16v.	BG04/06/0B/0C/0J/0M/0V	
1.9 DCi	BG08/0E/0G/0R/05/12/13/1A/1V/1W	
1.9 DCi	BG10	-04/05
2.0i 16v.	BG00/0K/0P/0S/0W/0Z/1M/03/0T/1Y	
2.0 IDE	BG0N	
2.2 DCi	BG09/0F/1N	
3.0i V6	BG01/02/0D/0Y/1K	

4005278

Rotule de susp. inf. G/D

OE 401606676R

L/R lower suspension ball joint



1/2

1.6i 16v.	BG0A/0L/0U/1G/1H	
1.8i 16v.	BG04/06/0B/0C/0J/0M/0V	
1.9 DCi	BG08/0E/0G/0R/05/12/13/1A/1V/1W	
1.9 DCi	BG10	-04/05
2.0i 16v.	BG00/0K/0P/0S/0W/0Z/1M/03/0T/1Y	
2.0 DCi	BG1S/1T	
2.0 IDE	BG0N	
2.2 DCi	BG09/0F/1N	
3.0i V6	BG01/02/0D/0Y/1K	

... Laguna II









RENAULT

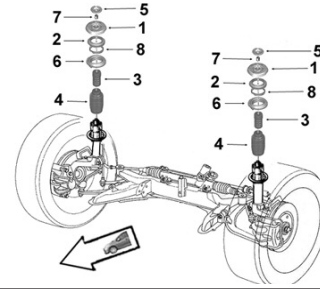

Support d'amortisseur

Suspension mounting
Soporte amortiguador
Poduszka amortyzatora
Опора амортизатора





4001628 OE 8200002877	Coupelle rebond. <i>Spring cup</i>	4001627 OE 8200002876	Support suspension <i>Suspension mounting</i>
	5 1.6i 16v. BG0A/0L/0U 1.8i 16v. BG04/06/0B/0C/0J/0M/0V 1.9 DCi BG08/0E/0G/0R 2.0i 16v. BG1L/1M 2.0i 16v. BG00/0K/0P/0S/0T/0W/0Z 2.0 IDE BG0N 2.2 DCi BG09/0F 3.0i V6 BG01/02/0D/0Y/1K		1 1.6i 16v. BG0A/0L/0U 1.8i 16v. BG04/06/0B/0C/0J/0M/0V 1.9 DCi BG08/0E/0R 1.9 DCi BG0G -04/05 2.0i 16v. BG1L/1M 2.0i 16v. BG00/0K/0S/0W 2.0 IDE BG0N 2.2 DCi BG09/0F -04/05 3.0i V6 BG01/02/0Y
2654010 OE 8200322166	Support suspension <i>Suspension mounting</i>	2654025 OE 7700424481	Butée à billes G/D <i>L/R ball bearing</i>
	1 1.6i 16v. BG1G/1H 1.9 DCi BG05/12/13/1A/1V/1W 1.9 DCi BG0G 04/05- 2.0i 16v. BG0P/0T/0Z/03/1Y 2.0 DCi BG1S/1T 2.2 DCi BG1N 2.2 DCi BG09/0F 04/05- 3.0i V6 BG1K		2 1.6i 16v. BG0A/0L/0U/1G/1H 1.8i 16v. BG04/06/0B/0C/0J/0M/0V 1.9 DCi BG05/08/0E/0G/0R 1.9 DCi BG10/12/13/1A/1V/1W 2.0i 16v. BG00/03/0K/0P/0S/0W/0Z/0T BG1Y/1L/1M 2.0 DCi BG1S/1T 2.0 IDE BG0N 2.2 DCi BG09/0F/1N 3.0i V6 BG01/02/0D/0Y/1K
4001626 OE 7700424482	Coupelle sup. ressort <i>Upper cup spring</i>	4001640 OE 7700833756	Butée protecteur susp. <i>Suspension bush</i>
	6 1.6i 16v. BG0A/0L/0U 1.8i 16v. BG04/06/0B/0C/0J/0M/0V 1.9 DCi BG08/0E/0G/0R 2.0i 16v. BG1L/1M 2.0i 16v. BG00/0K/0P/0S/0W/0Z 2.0 IDE BG0N 2.2 DCi BG09/0F 3.0i V6 BG01/02/0D/0Y/1K		3 4 1.6i 16v. BG0A/0L/0U 1.8i 16v. BG04/06/0B/0C/0J 1.8i 16v. BG0M/0V 1.9 DCi BG08/0E/0G/0R 2.0i 16v. BG1L/1M 2.0i 16v. BG00/0K/0P/0S/0W/0Z 2.0 IDE BG0N 2.2 DCi BG09/0F 3.0i V6 BG01/02/0D/0Y/1K

Eléments TRAIN ARRIERE

Rear axle parts
Tren TRAS
Elementy zawieszenia tylnego
элементы задней оси.



4005529 Part/oe 7701209534	Articulation G <i>Left bush</i>	4005528 Part/oe 7701209534	Articulation D <i>Right bush</i>
	Ø int. 14 Ø ext.78 coll.106 long. tube int. 73 ext.43 ep. coll.15 1.6i 16v. BG0A/0L/0U -01/07/04 1.8i 16v. BG04/06/0B/0C/0J -01/07/04 1.8i 16v. BG0M/0V -01/07/04 1.9 DCi BG08/0E/0G/0R/10 -01/07/04 2.0i 16v. BG1L/1M -01/07/04 2.0i 16v. BG00/0K/0P/0S/0W/0Z -01/07/04 2.0 DCi BG14/1S/1T 2.0 IDE BG0N -01/07/04 2.2 DCi BG09/0F/1N 3.0i V6 BG01/02/0D/0Y/1K		Ø int. 14 Ø ext.78 coll.106 long. tube int. 73 ext.43 ep. coll.15 1.6i 16v. BG0A/0L/0U -01/07/04 1.8i 16v. BG04/06/0B/0C/0J -01/07/04 1.8i 16v. BG0M/0V -01/07/04 1.9 DCi BG08/0E/0G/0R/10 -01/07/04 2.0i 16v. BG1L/1M -01/07/04 2.0i 16v. BG00/0K/0P/0S/0W/0Z -01/07/04 2.0 DCi BG14/1S/1T 2.0 IDE BG0N -01/07/04 2.2 DCi BG09/0F/1N 3.0i V6 BG01/02/0D/0Y/1K

Laguna II Estate ...

Eléments DIRECTION

Steering parts

Elementos Direcciones

Elementy układu kierowniczy

Элементы рулевой системы

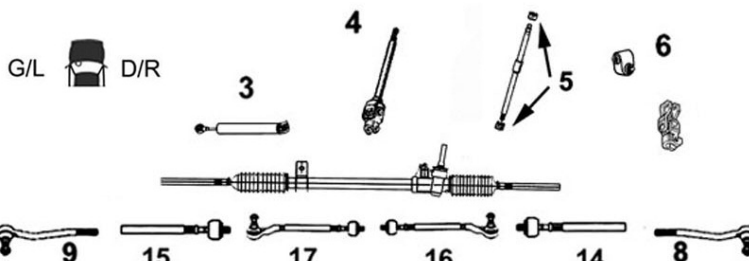

3008042

Axe de bielle G/D

Part/oe 7701478551

L/R axial joint



14 Côté dir. M12x1.0 Côté rot. M14x1.5 long 220 mm

15	1.6i 16v.	KG-
	1.8i 16v.	KG-
	1.9 DCi	KG-
	2.0i 16v.	KG-
	2.0 DCi	KG-
	2.0 IDE	KG-
	2.2 DCi	KG-
	3.0i V6	KG-

4006147

Rotule de direction G

OE 485202714R

Left tie rod end



9	1.6i 16v.	KG-
	1.8i 16v.	KG-
	1.9 DCi	KG-
	2.0i 16v.	KG-
	2.0 DCi	KG-
	2.0 IDE	KG-
	2.2 DCi	KG-
	3.0i V6	KG-

4006148

Rotule de direction D

OE 485209446R

Right tie rod end



8	1.6i 16v.	KG-
	1.8i 16v.	KG-
	1.9 DCi	KG-
	2.0i 16v.	KG-
	2.0 DCi	KG-
	2.0 IDE	KG-
	2.2 DCi	KG-
	3.0i V6	KG-



Barre stabilisatrice

Stabilizer bar

Barra estabilizadora

Drażek stabilizatora

стабилизатор поперечной устойчивости

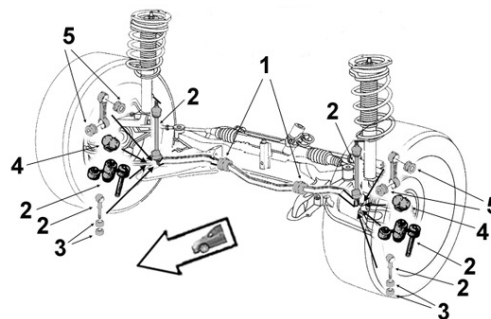

4005141

Biellette barre stab.

OE 8200661217

Stabilizer bar stub axle



2	1.6i 16v.	KG-
	1.8i 16v.	KG-
	1.9 DCi	KG-
	2.0i 16v.	KG-
	2.0 DCi	KG-
	2.0 IDE	KG-
	2.2 DCi	KG-
	3.0i V6	KG-

2304001

Palier de barre milieu

OE 8200272594

Middle bar main bearing



1	Ø 19	
	1.6i 16v.	KG0A/0L/0U
	1.8i 16v.	KG0M/04/06/0B/0C/0J/0V
	1.9 DCi	KG0E/08/0R/10
	1.9 DCi	KG0G -04/05
	2.0i 16v.	KG00/0W -04/05
	2.0i 16v.	KG0K/0S
	2.0 IDE	KG0N
	2.2 DCi	KG0F/09 -04/05
	3.0i V6 24v.	KG01/02/0D/0Y -04/05

2304003

Palier de barre milieu

OE 8200455604

Middle bar main bearing



1	Ø 21	
	1.6i 16v.	KG1G/1H
	1.9 DCi	KG05/12/13/1A/1V/1W
	1.9 DCi	KG0G 04/05-
	2.0i 16v.	KG03/0P/0T/0Z/1Y
	2.0i 16v.	KG00/0W 04/05-
	2.0 DCi	KG14/1S/1T
	2.2 DCi	KG1N
	2.2 DCi	KG09/0F 04/05-
	3.0i V6 24v.	KG1K
	3.0i V6 24v.	KG01/02/0Y 04/05-

... Laguna II Estate ...

Bras & Triangle de suspension

Control arm
Brazo y triángulo
Wahacz
Рычаг подвески

G/L  D/R

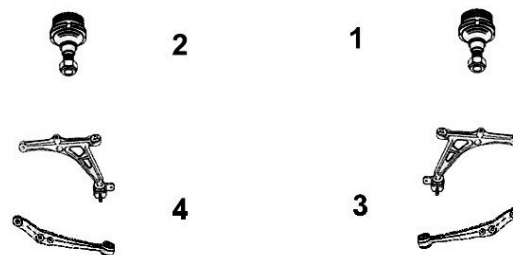

RENAULT

SASIC

4003319 Triangle de susp. G Part/oe 8200602612 Left track control arm



4	Sans rotule Without tie rod end	
	1.6i 16v.	KG0A/0L/1G/1H
	1.8i 16v.	KG04/06/0B/0C/0J/0M/0V
	1.9 DCi	KG08/0E/0G/0R/05/12/13/1A/1V/1W
	2.0i 16v.	KG00/0K/0P/0S/0W/0Z/0T/1Y
	2.0 DCi	KG1T
	2.0 DCi Equip. EXC/IMA/SAN913	KG1S
	2.0 IDE	KG0N
	2.2 DCi	KG09/0F/1N
	3.0i V6	KG01/02/0D/0Y/1K

4003320 Triangle de susp. D Part/oe 8200602613 Right track control arm



3	Sans rotule Without tie rod end	
	1.6i 16v.	KG0A/0L/1G/1H
	1.8i 16v.	KG04/06/0B/0C/0J/0M/0V
	1.9 DCi	KG08/0E/0G/0R/05/12/13/1A/1V/1W
	2.0i 16v.	KG00/0K/0P/0S/0W/0Z/0T/1Y
	2.0 DCi	KG1T
	2.0 DCi Equip. EXC/IMA/SAN913	KG1S
	2.0 IDE	KG0N
	2.2 DCi	KG09/0F/1N
	3.0i V6	KG01/02/0D/0Y/1K

7474023 Triangle de susp. G OE 8200602630 Left track control arm

NEW



4	Avec rotule With ball joint	
	1.6i 16v.	KG0A/0L/1G/1H
	1.8i 16v.	KG04/06/0B/0C/0J/0M/0V
	1.9 DCi	KG08/0E/0G/0R/05/12
	1.9 DCi	KG13/1A/1V/1W
	2.0i 16v.	KG00/0K/0P/0S/0W
	2.0i 16v.	KG0Z/0T/1Y
	2.0 IDE	KG0N
	2.2 DCi	KG09/0F/1N
	3.0i V6	KG01/02/0D/0Y/1K

7474024 Triangle de susp. D OE 8200602631 Right track control arm

NEW



3	Avec rotule With ball joint	
	1.6i 16v.	KG0A/0L/1G/1H
	1.8i 16v.	KG04/06/0B/0C/0J/0M/0V
	1.9 DCi	KG08/0E/0G/0R/05/12
	1.9 DCi	KG13/1A/1V/1W
	2.0i 16v.	KG00/0K/0P/0S/0W
	2.0i 16v.	KG0Z/0T/1Y
	2.0 IDE	KG0N
	2.2 DCi	KG09/0F/1N
	3.0i V6	KG01/02/0D/0Y/1K

4005278 Rotule de susp. inf. G/D OE 401606676R L/R lower suspension ball joint



1		
2	1.6i 16v.	KG0A/0L/1G/1H
	1.8i 16v.	KG04/06/0B/0C/0J/0M/0V
	1.9 DCi	KG08/0E/0G/0R/05/12/10/13/1A/1V/1W
	2.0i 16v.	KG00/0K/0P/0S/0W/0Z/0T/1Y/03
	2.0 DCi	KG1S/1T
	2.0 IDE	KG0N
	2.2 DCi	KG09/0F/1N
	3.0i V6	KG01/02/0D/0Y/1K

... Laguna II Estate





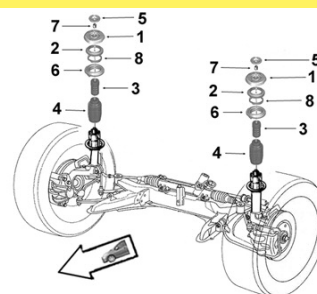



Support d'amortisseur
 Suspension mounting
 Soporte amortiguador
 Poduszka amortyzatora
 Опора амортизатора





RENAULT



4001628 OE 8200002877	Coupelle rebond. <i>Spring cup</i>	4001627 OE 8200002876	Support suspension <i>Suspension mounting</i>
	<p>5</p> <p>1.6i 16v. KG0A/0L/0U 1.8i 16v. KG04/06/0B/0C/0J/0M/0V 1.9 DCi KG08/0E/0G/0R 2.0i 16v. KG00/0K/0P/0S/0W/0Z/03 2.0 IDE KG0N 2.2 DCi KG09/0F 3.0i V6 KG01/02/0D/0Y/1K</p>		<p>1</p> <p>1.6i 16v. KG0A/0L/0U 1.8i 16v. KG04/06/0B/0C/0J/0M/0V 1.9 DCi KG08/0E/0R 1.9 DCi KG0G -04/05 2.0i 16v. KG00/0K/0S/0W 2.0 IDE KG0N 2.2 DCi KG09/0F -04/05 3.0i V6 KG01/02/0Y</p>
2654010 OE 8200322166	Support suspension <i>Suspension mounting</i>	2654025 OE 7700424481	Butée à billes G/D <i>L/R ball bearing</i>
	<p>1</p> <p>1.6i 16v. KG1G/1H 1.9 DCi KG05/12/13/1A/1V/1W 1.9 DCi KG0G 04/05- 2.0i 16v. KG0P/0T/0Z/03/1Y 2.0 DCi KG1S/1T 2.2 DCi KG1N 2.2 DCi KG09/0F 04/05- 3.0i V6 KG1K</p>		<p>2</p> <p>1.6i 16v. KG0A/0L/0U/1G/1H 1.8i 16v. KG04/06/0B/0C/0J/0M/0V 1.9 DCi KG05/08/0E/0G/0R KG1A/1V/1W/10/12/13 2.0i 16v. KG00/03/0K/0P/0S KG0W/0Z/0T/1Y 2.0 DCi KG1S/1T 2.0 IDE KG0N 2.2 DCi KG09/0F/1N 3.0i V6 KG01/02/0D/0Y/1K</p>
4001626 OE 7700424482	Coupelle sup. ressort <i>Upper cup spring</i>	4001640 OE 7700833756	Butée protecteur susp. <i>Suspension bush</i>
	<p>6</p> <p>1.6i 16v. KG0A/0L/0U 1.8i 16v. KG04/06/0B/0C/0J/0M/0V 1.9 DCi KG08/0E/0G/0R 2.0i 16v. KG00/0K/0P/0S/0W/0Z/03 2.0 IDE KG0N 2.2 DCi KG09/0F 3.0i V6 KG01/02/0D/0Y/1K</p>		<p>3 4</p> <p>1.6i 16v. KG0A/0L/0U 1.8i 16v. KG04/06/0B/0C/0J/0M/0V 1.9 DCi KG08/0E/0G/0R 2.0i 16v. KG00/0K/0P/0S/0W/0Z/03 2.0 IDE KG0N 2.2 DCi KG09/0F 3.0i V6 KG01/02/0D/0Y/1K</p>

Eléments TRAIN ARRIERE
 Rear axle parts
 Tren TRAS
 Elementy zawieszenia tylnego
 элементы задней оси.



4005529 Part/oe 7701209534	Articulation G <i>Left bush</i>	4005528 Part/oe 7701209534	Articulation D <i>Right bush</i>
	<p>Ø int. 14 Ø ext.78 coll.106 long. tube int. 73 ext.43 ep. coll.15</p> <p>1.6i 16v. KG0A/0L/0U -01/07/04 1.6i 16v. KG1G/1H 1.8i 16v. KG04/06/0B/0C/0J -01/07/04 1.8i 16v. KG0M/0V -01/07/04 1.9 DCi KG05/0G/12/13/1A/1V/1W 1.9 DCi KG08/0E/0G/0R/10 -01/07/04 2.0i 16v. KG03 -01/07/04 2.0i 16v. KG00/0K/0P/0S/0W/0Z 2.0 DCi KG14/1S/1T 2.0 IDE KG0N -01/07/04 2.2 DCi KG09/0F/1N 3.0i V6 KG01/02/0D/0Y/1K</p>		<p>Ø int. 14 Ø ext.78 coll.106 long. tube int. 73 ext.43 ep. coll.15</p> <p>1.6i 16v. KG0A/0L/0U -01/07/04 1.6i 16v. KG1G/1H 1.8i 16v. KG04/06/0B/0C/0J -01/07/04 1.8i 16v. KG0M/0V -01/07/04 1.9 DCi KG05/0G/12/13/1A/1V/1W 1.9 DCi KG08/0E/0G/0R/10 -01/07/04 2.0i 16v. KG03 -01/07/04 2.0i 16v. KG00/0K/0P/0S/0W/0Z 2.0 DCi KG14/1S/1T 2.0 IDE KG0N -01/07/04 2.2 DCi KG09/0F/1N 3.0i V6 KG01/02/0D/0Y/1K</p>

Laguna III ...

Eléments DIRECTION

Steering parts

Elementos Direcciones

Elementy układ kierowniczy

Элементы рулевой системы

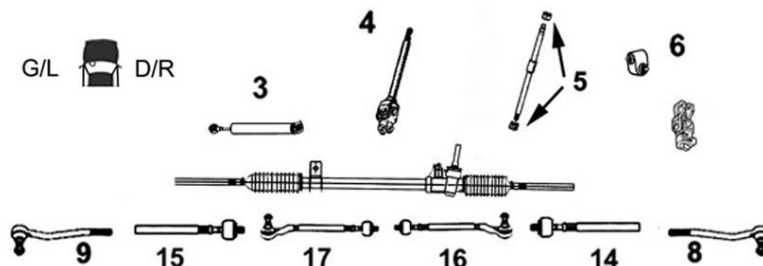

7774015 Axe de bielle G/D

Part/oe 485210001R L/R axial joint



14 Côté dir. M14x1.5 Côté rot. M14x1.5 long 189 mm

15

1.5 DCi	BT00/2/A/R/T BT1J
1.6i 16v.	BT04/D/U
2.0i 16v.	BT05/F/W BT1G/H/K
2.0i 16v. Turbo	BT06/G/H/Y BT15/8
2.0 DCi	BT01/7/8/9/E/J/K/M/N/S BT1A/C/D/E/F/M/N/S/W/1/2/4/9
3.0 DCi	BT03 BT13
3.5i V6 24v.	BT0C/P

7674010 Rotule de direction G

OE 485200001R Left tie rod end



9 M14 x 1.5

1.5 DCi	BT00/2/A/R/T BT1J
1.6i 16v.	BT04/D/U
2.0i 16v.	BT05/F/W BT1G/H/K
2.0i 16v. Turbo	BT06/G/H/Y BT15/8
2.0 DCi	BT01/7/8/9/E/J/K/M/N/S BT1A/C/D/E/F/M/N/S/W/1/2/4/9
3.0 DCi	BT03 BT13
3.5i V6 24v.	BT0C/P

7674011 Rotule de direction D

OE 485200002R Right tie rod end



8 M14 x 1.5

1.5 DCi	BT00/2/A/R/T BT1J
1.6i 16v.	BT04/D/U
2.0i 16v.	BT05/F/W BT1G/H/K
2.0i 16v. Turbo	BT06/G/H/Y BT15/8
2.0 DCi	BT01/7/8/9/E/J/K/M/N/S BT1A/C/D/E/F/M/N/S/W/1/2/4/9
3.0 DCi	BT03 BT13
3.5i V6 24v.	BT0C/P



Barre stabilisatrice

Stabilizer bar

Barra estabilizadora

Drażek stabilizatora

стабилизатор поперечной устойчивости

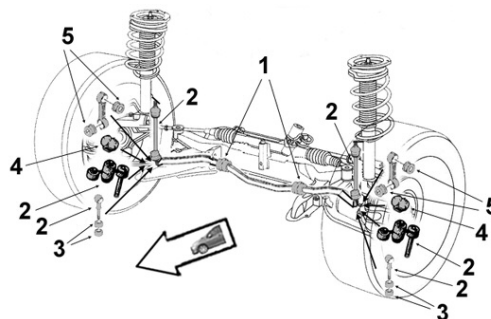

2304011 Biellette barre stab.

OE 546180001R Stabilizer bar stub axle



2

1.5 DCi	BT00/0A/0R/0T/1J
1.6i 16v.	BT04/0D/0U
2.0i 16v.	BT05/0F/0W/1H
2.0i 16v. Turbo	BT06/0G/0H/0Y/15/18
2.0 DCi	BT01/08/09/0J/0K/0M/0N/14/1A/1C/1D/1E/1F/1M/1N/1W/0E/11/12/19/1S
3.0 DCi	BT03/13
3.5i V6 24v.	BT0C/0P

2304025 Palier de barre milieu

OE 546130003R Middle bar main bearing



1

1.5 DCi	BT00/0A/0R/0T/1J
1.6i 16v.	BT04/0D/0U
2.0i 16v.	BT05/0F/0W/1H
2.0i 16v. Turbo	BT06/0G/0H/0Y/15/18
2.0 DCi	BT01/08/09/0J/0K/0M/0N/14/1A/1C/1D/1E/1F/1M/1N/1W/0E/11/12/19/1S
3.0 DCi	BT03/13
3.5i V6 24v.	BT0C/0P

... Laguna III ...



Eléments SUSPENSION
Suspension parts
Elementos suspensión
Elementy zawieszenie
Элементы подвески

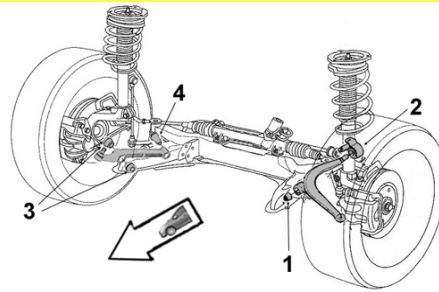

RENAULT



2254012

Articulation AV

Part/oe 545010012R

Front bush



1 Ø int. 18 Ø ext. 55 long. tube int.53 ext.29

1.5 DCi
 1.6i 16v.
 2.0i 16v.
 2.0i 16v. Turbo
 2.0 DCi
 3.0 DCi
 3.5i V6 24v.

BT00/0A/0R/0T/1J
 BT04/0D/0U
 BT05/0F/0W/1H
 BT06/0G/0H/0Y/15/18
 BT01/08/09/0J/0K/0M/0N/14/1A/1C/1D/1E/1F/1M/1N/1W/0E/11/12/19/1S
 BT03/13
 BT0C/0P

2254013

Articulation AR

Part/oe 545010012R

Rear bush



2 Ø int. 14 Ø ext. 72 long. tube int.65 ext.48

2.0i 16v.
 2.0i 16v. Turbo
 2.0 DCi
 3.0 DCi
 3.5i V6 24v.

BT05/0F/0W/1H
 BT06/0G/0H/0Y/15/18
 BT01/08/09/0J/0K/0M/0N/14/1A/1C/1D/1E/1F/1M/1N/1W/0E/11/12/19/1S
 BT03/13
 BT0C/0P

Bras & Triangle de suspension

Control arm
Brazo y triángulo
Wahacz
Рычаг подвески

G/L D/R



2

4

1

3



7574005

Rotule de susp. inf. G/D

OE 401600004R

L/R lower suspension ball joint



1
2

1.5 DCi
 1.6i 16v.
 2.0i 16v.
 2.0i 16v. Turbo
 2.0 DCi
 3.0 DCi
 3.5i V6 24v.

BT00/2/A/R/T BT1J
 BT04/D/U
 BT05/F/W BT1G/H/K
 BT06/G/H/Y BT15/8
 BT01/7/8/9/E/J/K/M/N/S BT1A/C/D/E/F/M/N/S/W/1/2/4/9
 BT03 BT13
 BT0C/P

... Laguna III



Support d'amortisseur

Suspension mounting
Soporte amortiguador
Poduszka amortyzatora
Опора амортизатора

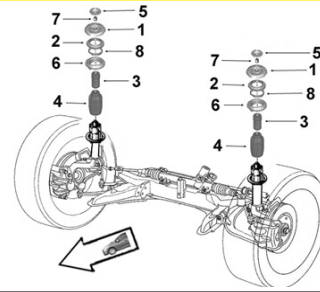

RENAULT

2654009

Support suspension

OE 543200002R

Suspension mounting



1

1.5 DCi BT00/0A/0R/0T/1J/02
1.6i 16v. BT04/0D/0U
2.0i 16v. BT05/0F/0W/1H/1G

2654008

Support suspension

OE 543200001N

Suspension mounting



1

2.0i 16v. Turbo BT06/0G/0H/0Y/18
2.0 DCi BT01/7/8/9/E/J/K/M/N/S
2.0 DCi BT11/4/9
BT1A/C/D/E/F/M/N/S/W

3.0 DCi BT03/13
3.5i V6 24v. BT0C/0P

2654023

Butée à billes G/D

OE 543256557R

L/R ball bearing



2

1.5 DCi BT00/0A/0R/0T/1J/02
1.6i 16v. BT04/0D/0U
2.0i 16v. BT05/0F/0W/1H/1G
2.0i 16v. Turbo BT06/0G/0H/0Y/18
2.0 DCi BT01/7/8/9/E/J/K/M/N/S
2.0 DCi BT11/4/9/A/C/D/E/F/M/N/S/W
3.0 DCi BT03/13
3.5i V6 24v. BT0C/0P

2654005

Butée protecteur susp.

OE 540500001R

Suspension bush



3

Jante tôle 16p. Jante alu 16/17p.
1.5 DCi BT00/0A/0R/0T/1J/02
1.6i 16v. BT04/0D/0U
2.0i 16v. Turbo BT06/0G/0H/0Y/18
2.0i 16v. BT05/0F/0W/1H/1G
2.0 DCi BT01/7/8/9/E/J/K/M/N/S
2.0 DCi BT11/4/9/A/C/D/E/F/M/N/S/W
3.0 DCi BT03/13
3.5i V6 24v. BT0C/0P

2654006

Butée protecteur susp.

OE 540500002R

Suspension bush



3

4

Jante alu 18p.
1.5 DCi BT00/0A/0R/0T/1J/02
1.6i 16v. BT04/0D/0U
2.0i 16v. BT05/0F/0W/1H/1G
2.0i 16v. Turbo BT06/0G/0H/0Y/18
2.0 DCi BT01/7/8/9/E/J/K/M/N/S BT11/4/9/A/C/D/E/F/M/N/S/W
3.0 DCi BT03/13
3.5i V6 24v. BT0C/0P

Eléments TRAIN ARRIERE

Rear axle parts
Tren TRAS
Elementy zawieszenia tylnego
элементы задней оси.



2604007

Kit articulations essieu

OE 550446624R

Axle bushes Kit



1.5 DCi BT00/0A/0R/0T/1J
1.6i 16v. BT04/0D/0U
2.0i 16v. BT05/0F/0W/1H
2.0i 16v. Turbo BT06/0G/0H/0Y/15/18
2.0 DCi BT01/08/09/0J/0K/0M/0N/14/1A/1C/1D/1E/1F/1M/1N/1W/0E/11/12/19/1S
3.0 DCi BT03/13
3.5i V6 24v. BT0C/0P

Laguna III Estate ...

Eléments DIRECTION

Steering parts

Elementos Direcciones

Elementy układ kierowniczy

Элементы рулевой системы

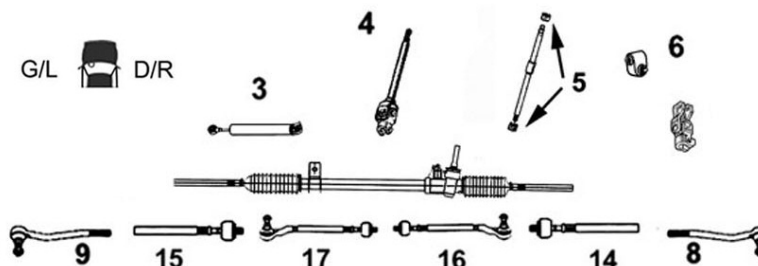

7774015 Axe de bielle G/D

Part/oe 485210001R L/R axial joint



14 Côté dir. M14x1.5 Côté rot. M14x1.5 long 189 mm

15

1.5 DCi	KT0A/R/2
1.6i 16v.	KT0D
2.0i 16v.	KT0F/W KT1G/H/K
2.0i 16v. Turbo	KT0G/H/Y KT15/8
2.0 DCi	KT01/7/8/9/J/K/M/N/S
3.0 DCi	KT1A/D/E/F/N/S/W/1/2/4/9
3.5i V6 24v.	KT03 KT13
	KT0C/P

7674010 Rotule de direction G

OE 485200001R Left tie rod end



9 M14 x 1.5

1.5 DCi	KT0A/R/2
1.6i 16v.	KT0D
2.0i 16v.	KT0F/W KT1G/H/K
2.0i 16v. Turbo	KT0G/H/Y KT15/8
2.0 DCi	KT01/7/8/9/J/K/M/N/S
	KT1A/D/E/F/N/S/W/1/2/4/9
3.0 DCi	KT03 KT13
3.5i V6 24v.	KT0C/P

7674011 Rotule de direction D

OE 485200002R Right tie rod end



8 M14 x 1.5

1.5 DCi	KT0A/R/2
1.6i 16v.	KT0D
2.0i 16v.	KT0F/W KT1G/H/K
2.0i 16v. Turbo	KT0G/H/Y KT15/8
2.0 DCi	KT01/7/8/9/J/K/M/N/S
	KT1A/D/E/F/N/S/W/1/2/4/9
3.0 DCi	KT03 KT13
3.5i V6 24v.	KT0C/P



Barre stabilisatrice

Stabilizer bar

Barra estabilizadora

Drażek stabilizatora

стабилизатор поперечной устойчивости

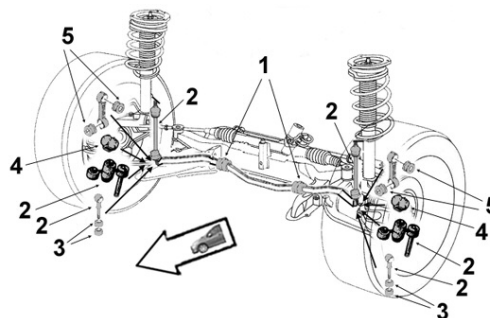

2304011 Bielle barre stab.

OE 546180001R Stabilizer bar stub axle



2

1.5 DCi	KT0A/0R
1.6i 16v.	KT0D
2.0i 16v.	KT0F/0W/1H
2.0i 16v. Turbo	KT0G/0H/0Y/15/18
2.0 DCi	KT01/08/09/0J/0K/0M/0N/14/1A/1D/1E/1F/1N/1W/11/12/19/1S
3.0 DCi	KT03/13
3.5i V6 24v.	KT0C/0P

2304025 Palier de barre milieu

OE 546130003R Middle bar main bearing



1

1.5 DCi	KT0A/0R
1.6i 16v.	KT0D
2.0i 16v.	KT0F/0W/1H
2.0i 16v. Turbo	KT0G/0H/0Y/15/18
2.0 DCi	KT01/08/09/0J/0K/0M/0N/14/1A/1D/1E/1F/1N/1W/11/12/19/1S
3.0 DCi	KT03/13
3.5i V6 24v.	KT0C/0P

... Laguna III Estate ...



Eléments SUSPENSION
Suspension parts
Elementos suspensión
Elementy zawieszenie
Элементы подвески

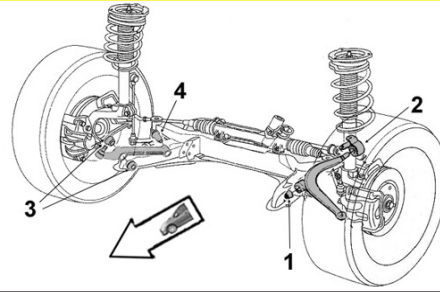

2254012 Articulation AV

Part/oe 545010012R *Front bush*



1 Ø int. 18 Ø ext. 55 long. tube int.53 ext.29

1.5 DCi	KT0A/0R
1.6i 16v.	KT0D
2.0i 16v.	KT0F/0W/1H
2.0i 16v. Turbo	KT0G/0H/0Y/15/18
2.0 DCi	KT01/08/09/0J/0K/0M/0N/14/1A/1D/1E/1F/1N/1W/11/12/19/1S
3.0 DCi	KT03/13
3.5i V6 24v.	KT0C/0P

2254013 Articulation AR

Part/oe 545010012R *Rear bush*



2 Ø int. 14 Ø ext. 72 long. tube int.65 ext.48

2.0i 16v.	KT0F/0W/1H
2.0i 16v. Turbo	KT0G/0H/0Y/15/18
2.0 DCi	KT01/08/09/0J/0K/0M/0N/14/1A/1D/1E/1F/1N/1W/11/12/19/1S
3.0 DCi	KT03/13
3.5i V6 24v.	KT0C/0P

Bras & Triangle de suspension

Control arm
Brazo y triángulo
Wahacz
Рычаг подвески

G/L  D/R

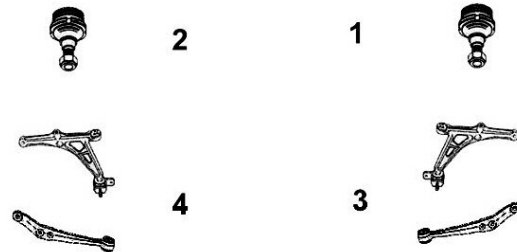

7574005 Rotule de susp. inf. G/D

OE 401600004R *L/R lower suspension ball joint*



1
2

1.5 DCi	KT0A/R/2
1.6i 16v.	KT0D
2.0i 16v.	KT0F/W KT1G/H/K
2.0i 16v. Turbo	KT0G/H/Y KT15/8
2.0 DCi	KT01/7/8/9/J/K/M/N/S KT1A/D/E/F/N/S/W/1/2/4/9
3.0 DCi	KT03 KT13
3.5i V6 24v.	KT0C/P

... Laguna III Estate





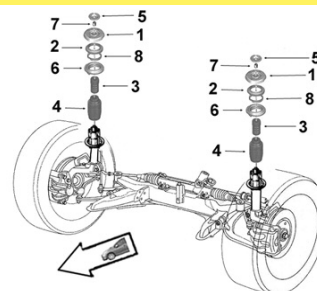

Support d'amortisseur
 Suspension mounting
 Soporte amortiguador
 Poduszka amortyzatora
 Опора амортизатора



RENAULT



2654009 OE 543200002R	Support suspension <i>Suspension mounting</i>	2654008 OE 543200001N	Support suspension <i>Suspension mounting</i>
	1 1.5 DCi KT0A/0R/02 1.6i 16v. KT0D 2.0i 16v. KT0F/0W/1H/1G		1 2.0i 16v. Turbo KT0G/0H/0Y/18 2.0 DCi KT01/7/8/9/J/K/M/N 2.0 DCi KT1A/D/E/F/N/S/W KT12/4/9 3.0 DCi KT03/13 3.5i V6 24v. KT0C/0P
2654023 OE 543256557R	Butée à billes G/D <i>L/R ball bearing</i>	2654005 OE 540500001R	Butée protecteur susp. <i>Suspension bush</i>
	2 1.5 DCi KT0A/0R/02 1.6i 16v. KT0D 2.0i 16v. KT0F/0W/1H/1G 2.0i 16v. Turbo KT0G/0H/0Y/18 2.0 DCi KT01/7/8/9/J/K/M/N 2.0 DCi KT1A/D/E/F/N/S/W/2/4/9 3.0 DCi KT03/13 3.5i V6 24v. KT0C/0P		3 Jante tôle 16p. Jante alu 16/17p. 4 1.5 DCi KT0A/0R/02 1.6i 16v. KT0D 2.0i 16v. KT0F/0W/1H/1G 2.0i 16v. Turbo KT0G/0H/0Y/18 2.0 DCi KT01/7/8/9/J/K/M/N 2.0 DCi KT1A/D/E/F/N/S/W KT12/4/9 3.0 DCi KT03/13 3.5i V6 24v. KT0C/0P
2654006 OE 540500002R	Butée protecteur susp. <i>Suspension bush</i>		
	3 Jante alu 18p. 4 1.5 DCi KT0A/0R/02 1.6i 16v. KT0D 2.0i 16v. Turbo KT0G/0H/0Y/18 2.0i 16v. KT0F/0W/1H/1G 2.0 DCi KT01/7/8/9/J/K/M/N 2.0 DCi KT1A/D/E/F/N/S/W/2/4/9 3.0 DCi KT03/13 3.5i V6 24v. KT0C/0P		

Eléments TRAIN ARRIERE

Rear axle parts
 Tren TRAS
 Elementy zawieszenia tylnego
 элементы задней оси.



2604007 OE 550446624R	Kit articulations essieu <i>Axle bushes Kit</i>		
	1.5 DCi KT0A/0R 1.6i 16v. KT0D 2.0i 16v. KT0F/0W/1H 2.0i 16v. Turbo KT0G/0H/0Y/15/18 2.0 DCi KT01/08/09/0J/0K/0M/0N/14/1A/1D/1E/1F/1N/1W/11/12/19/1S 3.0 DCi KT03/13 3.5i V6 24v. KT0C/0P		

Laguna III Coupé ...

Eléments DIRECTION

Steering parts

Elementos Direcciones

Elementy układ kierowniczy

Элементы рулевой системы

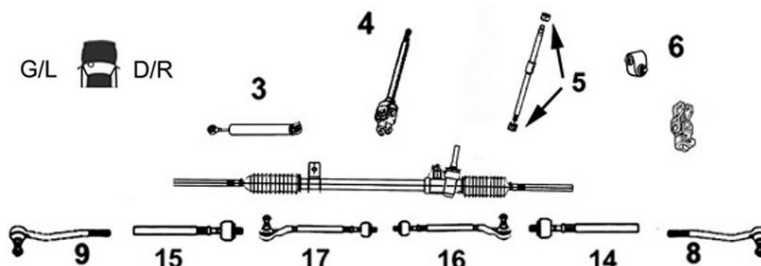

7774015

Axe de bielle G/D

Part/oe 485210001R

L/R axial joint



14 Côté dir. M14x1.5 Côté rot. M14x1.5 long 189 mm

15

1.5 DCi	DT0R/2
2.0i 16v. Turbo	DT06/G/H/Y DT15/8/U
2.0 DCi	DT01/8/9/K/M/N/S DT1C/D/E/F/M/N/W/1/2/9
3.0 DCi	DT03/L DT13
3.5i V6 24v.	DT0B/C/P/V

7674010

Rotule de direction G

OE 485200001R

Left tie rod end



9 M14 x 1.5

1.5 DCi	DT0R/2
2.0i 16v. Turbo	DT06/G/H/Y
	DT15/8/U
2.0 DCi	DT01/8/9/K/M/N/S
	DT1C/D/E/F/M/N/W/1/2/9
3.0 DCi	DT03/L DT13
3.5i V6 24v.	DT0B/C/P/V

7674011

Rotule de direction D

OE 485200002R

Right tie rod end



8 M14 x 1.5

1.5 DCi	DT0R/2
2.0i 16v. Turbo	DT06/G/H/Y
	DT15/8/U
2.0 DCi	DT01/8/9/K/M/N/S
	DT1C/D/E/F/M/N/W/1/2/9
3.0 DCi	DT03/L DT13
3.5i V6 24v.	DT0B/C/P/V



Barre stabilisatrice

Stabilizer bar

Barra estabilizadora

Drażek stabilizatora

стабилизатор поперечной устойчивости

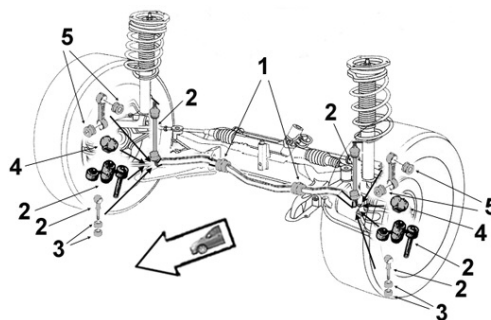

2304011

Biellette barre stab.

OE 546180001R

Stabilizer bar stub axle



2

2.0i 16v. Turbo	DT06/0G/0H/0Y/15/18/1U
2.0 DCi	DT01/09/0K/0M/0N
	DT1C/1D/1E/1F/1M/1N/1W
	DT11/12/19
3.0 DCi	DT03/13/0L
3.5i V6 24v.	DT0C/0P/0V

2304025

Palier de barre milieu

OE 546130003R

Middle bar main bearing



1

2.0i 16v. Turbo	DT06/0G/0H/0Y/15/18/1U
2.0 DCi	DT01/09/0K/0M/0N
	DT1C/1D/1E/1F/1M/1N/1W
	DT11/12/19
3.0 DCi	DT03/13/0L
3.5i V6 24v.	DT0C/0P/0V

... Laguna III Coupé ...



Eléments SUSPENSION
Suspension parts
Elementos suspensión
Elementy zawieszenie
Элементы подвески

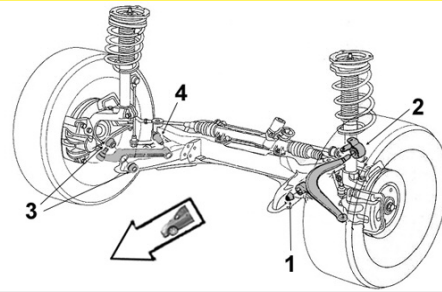

RENAULT



2254012	Articulation AV	2254013	Articulation AR
Part/oe 545010012R	<i>Front bush</i>	Part/oe 545010012R	<i>Rear bush</i>
	1 Ø int. 18 Ø ext. 55 long. tube int.53 ext.29		2 Ø int. 14 Ø ext. 72 long. tube int.65 ext.48
	1.5 DCi DT0R		1.5 DCi DT0R
	2.0i 16v. Turbo DT06/0G/0H/0Y/15/18/1U		2.0i 16v. Turbo DT06/0G/0H/0Y/15/18/1U
	2.0 DCi DT01/09/0K/0M/0N DT1C/1D/1E/1F/1M/1N/1W		2.0 DCi DT01/09/0K/0M/0N DT1C/1D/1E/1F/1M/1N/1W
	3.0 DCi DT11/12/19		3.0 DCi DT11/12/19
3.5i V6 24v. DT03/13/0L	3.5i V6 24v. DT03/13/0L		
	3.5i V6 24v. DT0B/0C/0P/0V		3.5i V6 24v. DT0B/0C/0P/0V

Bras & Triangle de suspension	G/L D/R				
<i>Control arm</i> <i>Brazo y triángulo</i> <i>Wahacz</i> <i>Рычаг подвески</i>			2		1
			4		3

7574005	Rotule de susp. inf. G/D
OE 401600004R	<i>L/R lower suspension ball joint</i>
	1 2
	1.5 DCi DT0R/2
	2.0i 16v. Turbo DT06/G/H/Y DT15/8/U
	2.0 DCi DT01/8/9/K/M/N/S DT1C/D/E/F/M/N/W/1/2/9
	3.0 DCi DT03/L DT13
3.5i V6 24v. DT0B/C/P/V	



Support d'amortisseur
Suspension mounting
Soporte amortiguador
Poduszka amortyzatora
Опора амортизатора

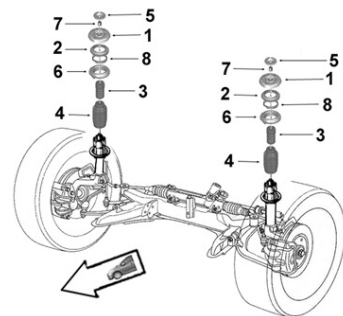

2654008	Support suspension	2654023	Butée à billes G/D
OE 543200001N	<i>Suspension mounting</i>	OE 543256557R	<i>L/R ball bearing</i>
	1		2
	1.5 DCi DT0R		1.5 DCi DT0R
	2.0i 16v. Turbo DT06/0G/0H/0Y/15/18/1U		2.0i 16v. Turbo DT06/0G/0H/0Y/15/18/1U
	2.0 DCi DT01/09/0K/0M/0N/1D		2.0 DCi DT01/09/0K/0M/0N/1D
	2.0 DCi DT1E/1F/1N/1W/11/12/19		2.0 DCi DT1E/1F/1N/1W/11/12/19
3.0 DCi DT03/0L/13	3.0 DCi DT03/0L/13		
3.5i V6 24v. DT0C/0P/0V/0B	3.5i V6 24v. DT0C/0P/0V/0B		

... Laguna III Coupé



Support d'amortisseur
Suspension mounting
Soporte amortiguador
Poduszka amortyzatora
Опора амортизатора

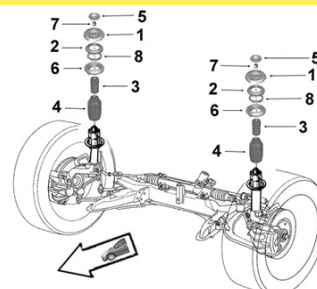

2654005

Butée protecteur susp.

OE 540500001R

Suspension bush



3 Jante tôle 16p. Jante alu 16/17p.
4

1.5 DCi	DT0R/02
2.0i 16v. Turbo	DT06/0G/0H/0Y/15/18/1U
2.0 DCi	DT01/09/0K/0M/0N/1C/1D
2.0 DCi	DT1E/1F/1M/1N/1W/11/12/19
3.0 DCi	DT03/0L/13
3.5i V6 24v.	DT0C/0P/0V/0B

2654006

Butée protecteur susp.

OE 540500002R

Suspension bush



3 Jante alu 18p.
4

1.5 DCi	DT0R/02
2.0i 16v. Turbo	DT06/0G/0H/0Y/15/18/1U
2.0 DCi	DT01/09/0K/0M/0N/1C/1D/1E/1F/1M/1N/1W/11/12/19
3.0 DCi	DT03/0L/13
3.5i V6 24v.	DT0C/0P/0V/0B

Eléments TRAIN ARRIERE

Rear axle parts

Tren TRAS

Elementy zawieszenia tylnego

элементы задней оси.



2604007

Kit articulations essieu

OE 550446624R

Axle bushes Kit



1.5 DCi	DT0R
2.0i 16v. Turbo	DT06/0G/0H/0Y/15/18/1U
2.0 DCi	DT01/09/0K/0M/0N/1C/1D/1E/1F/1M/1N/1W/11/12/19
3.0 DCi	DT03/13/0L
3.5i V6 24v.	DT0B/0C/0P/0V

Latitude



Support d'amortisseur
 Suspension mounting
 Soporte amortiguador
 Poduszka amortyzatora
 Опора амортизатора

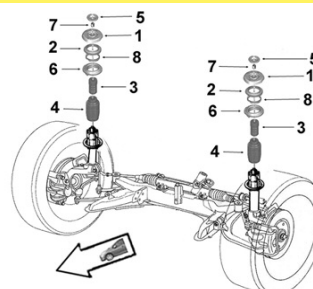

2654023

Butée à billes G/D

OE 543256557R

L/R ball bearing



2

1.5 DCi	L70R
1.6	L705
2.0 16v.	L70B/0D/0L/0P/0S/0A
2.0 DCi	L70C/0E/0H/0V/0Y
2.5 V6	L702/03/04/07/09
3.0 DCi	L70G
3.5 V6	L700/01/06/08

Megane I ...

Eléments DIRECTION

Steering parts

Elementos Direcciones

Elementy układ kierowniczy

Элементы рулевой системы

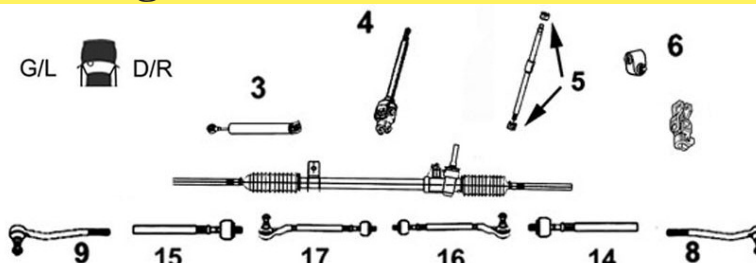

3008110

Axe de bielle G/D

Part/oe 7701469251

L/R axial joint



14 Côté dir. M12x1.0 Côté rot. M14x1.5
 15 long 265 mm

TT /all models DNA SMI BA -11/02

3008049

Axe de bielle G/D

Part/oe 7701469502

L/R axial joint



14 Côté dir. M12x1.0 Côté rot. M14x1.5
 15 long 260 mm

TT /all models DA SMI -18/09/98

3008050

Axe de bielle G/D

Part/oe 7701471885

L/R axial joint



14 Côté dir. M12x1.0 Côté rot. M14x1.5
 15 long 257 mm

TT /all models DA SMI
 18/09/98-17/02/99

3008046

Axe de bielle G/D

Part/oe 7701471844

L/R axial joint



14 Côté dir. M12x1.0 Côté rot. M14x1.5
 15 long 294 mm

TT /all models DA SMI BA
 17/02/99-11/02

3008109

Axe de bielle G/D

Part/oe 7701469280

L/R axial joint



14 Côté dir. M14x1.5 Côté rot. M14x1.5
 15 long 255 mm Dir. TRW

1.4i	BA0E BA0V SA	-17/02/99
1.6i	BA0F/0L	-17/02/99
1.6i	BA0S	-11/02
1.9 D	BA0A/R SA	-17/02/99
1.9 D	BA0U	-11/02
1.9 DCi	BA05 SA	-17/02/99
1.9 DTi	BA08/0N	-11/02
1.9 TD	BA0K/0Y/09	-11/02
2.0i	BA0G	-17/02/99
2.0i	BA07	-11/02

3008047

Axe de bielle G/D

Part/oe 7701472087

L/R axial joint



14 Côté dir. M14x1.5 Côté rot. M14x1.5
 15 long 287 mm Dir. TRW

1.4i	BA0E/V	17/02/99-11/02
1.4i 16v.	BA0W	17/02/99-11/02
1.6i	BA0F/0L	17/02/99-11/02
1.6i 16v.	BA04	17/02/99-11/02
1.8i 16v.	BA1A/1M/1R	17/02/99-11/02
1.9 D	BA0A/R	17/02/99-11/02
1.9 DCi	BA05	17/02/99-11/02
1.9 DTi	BA0N	17/02/99-11/02
2.0i	BA0G	17/02/99-11/02

TT /all models SA 17/02/99-11/02

... Megane I ...

Eléments DIRECTION

Steering parts

Elementos Direcciones

Elementy układ kierowniczy

Элементы рулевой системы

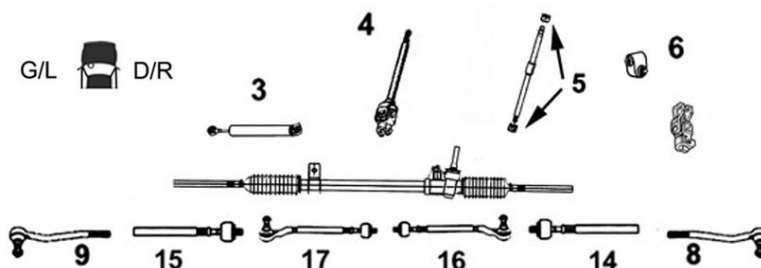
**3008051****Axe de bielle G/D**

Part/oe 7701469283

L/R axial joint

14
15

Côté dir. M14x1.5 Côté rot. M14x1.5 long 263 mm

2.0i 16v. BA0H -11/02

4006108**Rotule de direction G**

OE 7701472087

Left tie rod end

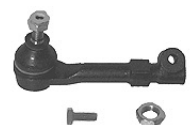

9

TT /all models
Dir. SMI Koyo TRW -17/02/99**4006109****Rotule de direction D**

OE 7701041312

Right tie rod end



8

TT /all models
Dir. SMI Koyo TRW -17/02/99**4006134****Rotule de direction G**

OE 7701047812

Left tie rod end



9

TT /all models
DA SMI TRW 17/02/99-11/02**4006135****Rotule de direction D**

OE 7701047813

Right tie rod end



8

TT /all models
DA SMI TRW 17/02/99-11/02**Barre stabilisatrice**

Stabilizer bar

Barra estabilizadora

Drażek stabilizatora

стабилизатор поперечной устойчивости

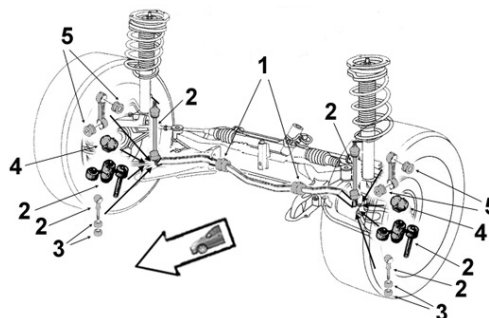
**4001522****Palier de barre bout**

OE 7700784171

End bar main bearing







4

Barre Ø 24

1.4i susp. normale	BA0E	18/06/96-13/05/98
1.6i susp. normale	BA0F	18/06/96-13/05/98
1.6i	BA0L	18/06/96-13/05/98
1.9 D susp. normale	BA0U	18/06/96-13/05/98
1.9 D	BA0A	18/06/96-13/05/98
1.9 D	SA0U	18/06/96-
1.9 D	SA0A	-13/05/98
2.0i 16v.	BA0H	

... Megane I ...

... Megane I ...			
4001475 Palier de barre bout OE 7700784170 <i>End bar main bearing</i>			
	4	Barre Ø 23	
		1.4i susp. renforcée	BA0E -13/05/98
		1.6i susp. renforcée	BA0F -13/05/98
		1.6i	BA0L -18/06/96
		1.6i	BA0S K7M702 -13/05/98
		1.6i	BA1C K7M704 -13/05/98
		1.9 D susp. renforcée	BA0U -13/05/98
		1.9 D	BA0A SA0U -18/06/96
		1.9 DTi	SA0N -13/05/98
		1.9 DTi	BA0N 09/97-13/05/98
		1.9 TD	BA0Y SA0Y/09 09/97-
		2.0i	BA0G -13/05/98
		2.0i	BA07
		4005151 Palier de barre bout OE 8200150759 <i>End bar main bearing</i>	
	4		
		1.4i susp. renforcée	BA0E 13/05/98-
		1.4i 16v. susp. renforcée	BA0W
		1.6i susp. renforcée	BA0F 13/05/98-
		1.6i	BA0S K7M702 13/05/98-
		1.6i 16v.	BA04
		1.8i 16v. Susp. normale	BA1A/1M
		1.8i 16v.	BA1R
		1.9 D susp. renforcée	BA0A/0U 13/05/98-
		1.9 D susp. renforcée	BA0R
		1.9 DCi Susp. normale	BA05
		1.9 DCi	BA1F SA05
		1.9 DTi particularités techniques 0/5/8/24	BA0N 13/05/98-
		1.9 DTi	SA0N 13/05/98-
1.9 DTi Susp. normale	BA1U		
2.0i particularité technique 0	BA0G 13/05/98-		
2304005 Palier de barre bout OE 8200150768 <i>End bar main bearing</i>			
	4		
		1.4i	BA0V
		1.4i Susp. normale	BA0E 13/05/98-
		1.4i 16v. Susp. normale	BA0W
		1.6i Susp. normale	BA0F 13/05/98-
		1.6i	BA0L 13/05/98-
		1.8i 16v. Susp. renforcée	BA1A/1M
		1.9 D Susp. normale	BA0A/0U SA0A 13/05/98-
		1.9 D	BA0R SA0R
		1.9 DCi Susp. renforcée	BA05
1.9 DTi Susp. renforcée	BA1U		
4005129 Palier de barre bout OE 7700847382 <i>End bar main bearing</i>			
	2		
		1.9 DTi	BA08
		1.9 DTi	BA0N -01/09/97
		1.9 TD	BA0K/09
1.9 TD	S/BA 0Y SA09 -01/09/97		
4001476 Palier de barre milieu OE 7700785788 <i>Middle bar main bearing</i>			
	1	Barre Ø 23	
		1.4i susp. renforcée	BA0E -13/05/98
		1.6i	BA0L -18/06/96
		1.6i	BA0S K7M702 -13/05/98
		1.6i susp. renforcée	BA0F -13/05/98
		1.9 D susp. renforcée	BA0U -13/05/98
		1.9 D	BA0A SA0U -18/06/96
		1.9 DTi	SA0N -13/05/98
		1.9 DTi	BA0N 09/97-13/05/98
		1.9 TD	BA0Y SA0Y SA09 09/97-
		2.0i	BA0G -13/05/98
2.0i	BA07		

... Megane I ...



Barre stabilisatrice
 Stabilizer bar
 Barra estabilizadora
 Drażek stabilizatora
 стабилизатор поперечной устойчивости

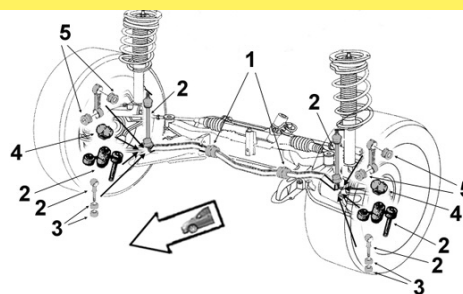

RENAULT



4001553 **Palier de barre milieu**
 OE 7700428665 *Middle bar main bearing*



1	Barre Ø 23.5		
	1.4i susp. renforcée	BA0E	13/05/98-
	1.4i 16v. susp. renforcée	BA0W	
	1.6i susp. renforcée	BA0F	13/05/98-
	1.6i	BA0S K7M702	13/05/98-
	1.6i 16v.	BA04	
	1.8i 16v. susp. normale	BA1A/1M/1R	
	1.9 D susp. renforcée	BA0A/0U	13/05/98-
	1.9 D susp. renforcée	BA0R	
	1.9 DCi	B/SA 05	
	1.9 DTi	B/SA 0N	13/05/98-
	2.0i	BA0G	13/05/98-

4001517 **Palier de barre milieu**
 OE 7700835929 *Middle bar main bearing*



1	Barre Ø 24		
	1.4i susp. normale	BA0E	18/06/96-13/05/98
	1.6i susp. normale	BA0F	18/06/96-13/05/98
	1.6i	BA0L	18/06/96-13/05/98
	1.9 D	BA0A	18/06/96-13/05/98
	1.9 D	SA0A	-13/05/98
	1.9 D susp. normale	BA0U	18/06/96-13/05/98
	1.9 DTi	BA0N	-01/09/97
	1.9 DTi	BA08	
	1.9 TD	BA0Y SA0Y SA09	-01/09/97
	1.9 TD	BA0K/09	
	2.0i 16v.	BA0H	

4001554 **Palier de barre milieu**
 OE 7700428738 *Middle bar main bearing*



1	Barre Ø 24.5		
	1.4i susp. normale	BA0E	13/05/98-
	1.4i	BA0V	
	1.4i 16v. susp. normale	BA0W	
	1.6i susp. normale	BA0F	13/05/98-
	1.6i	BA0L	13/05/98-
	1.8i 16v. susp. renforcée	BA1A/1M	
	1.9 D susp. normale	BA0A/0U	13/05/98-
	1.9 D	SA0A	13/05/98-
	1.9 D susp. normale	BA0R	
	1.9 D	SA0R	
	1.9 DCi susp. renforcée	BA05	
	1.9 DTi susp. renforcée	BA1U	

4155410 **Kit rép. barre stab. G et D**
 OE - *L R Stabilizing bar repair kit*

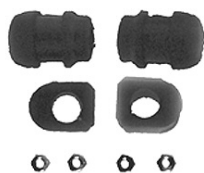

Barre Ø 23
 TT /all models -11/02

4005086 **Kit rép. barre stab. G et D**
 OE - *L R Stabilizing bar repair kit*

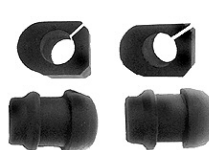

Barre Ø 24
 TT /all models -11/02

4005070 **Kit rép. barre stab. G et D**
 OE - *L R Stabilizing bar repair kit*



Barre Ø 25
 TT /all models -11/02

... Megane I ...



Eléments SUSPENSION

Suspension parts

Elementos suspensión

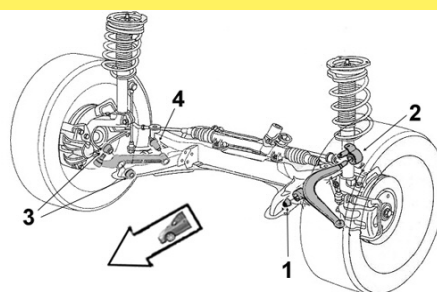

Elementy zawieszenia

Элементы подвески



RENAULT





4001413 OE 8200651163	Articulation AV/AR <i>Front rear bush</i>	4001529 OE 8200651169	Articulation AV/AR <i>Front rear bush</i>																														
	1 Ø int.12 Ø ext.45 long. tube int.46 ext.34.5 2 <table border="0"> <tr><td>1.4i/ 16v.</td><td>BA0E/0T/0V</td><td>BA0W</td></tr> <tr><td>1.6i /16v.</td><td>BA0F/0L/0S</td><td>BA04</td></tr> <tr><td>1.8i 16v.</td><td>BA1A/1M/1R</td><td></td></tr> <tr><td>1.9 D</td><td>B/SA 0A/0R/0U</td><td></td></tr> <tr><td>1.9 DCi</td><td>BA05 SA05</td><td></td></tr> <tr><td>1.9 DTi</td><td>BA0N/08 SA0N</td><td></td></tr> <tr><td>1.9 TD</td><td>BA0K/0Y/09 SA09/0Y</td><td></td></tr> <tr><td>2.0i</td><td>BA0G/07</td><td></td></tr> </table>	1.4i/ 16v.	BA0E/0T/0V	BA0W	1.6i /16v.	BA0F/0L/0S	BA04	1.8i 16v.	BA1A/1M/1R		1.9 D	B/SA 0A/0R/0U		1.9 DCi	BA05 SA05		1.9 DTi	BA0N/08 SA0N		1.9 TD	BA0K/0Y/09 SA09/0Y		2.0i	BA0G/07			1 Ø int.12 Ø ext.45 long. tube int.46 ext.35 2 <table border="0"> <tr><td>1.9 DTi</td><td>BA0N</td><td>BVA</td></tr> <tr><td>2.0i 16v.</td><td>BA0H</td><td></td></tr> </table>	1.9 DTi	BA0N	BVA	2.0i 16v.	BA0H	
1.4i/ 16v.	BA0E/0T/0V	BA0W																															
1.6i /16v.	BA0F/0L/0S	BA04																															
1.8i 16v.	BA1A/1M/1R																																
1.9 D	B/SA 0A/0R/0U																																
1.9 DCi	BA05 SA05																																
1.9 DTi	BA0N/08 SA0N																																
1.9 TD	BA0K/0Y/09 SA09/0Y																																
2.0i	BA0G/07																																
1.9 DTi	BA0N	BVA																															
2.0i 16v.	BA0H																																



Bras & Triangle de suspension



Control arm
Brazo y triángulo
Wahacz
Рычаг подвески

G/L  D/R



4003358 OE 8200737134	Triangle de susp. G <i>Left track control arm</i>	4003357 OE 8200737135	Triangle de susp. D <i>Right track control arm</i>																																										
	4 Avec rotule With ball joint <table border="0"> <tr><td>1.4i</td><td>BA0E/0T/0V</td><td>-11/02</td></tr> <tr><td>1.4i 16v.</td><td>BA0W</td><td>-11/02</td></tr> <tr><td>1.6i</td><td>BA0F/0L/0S</td><td>-11/02</td></tr> <tr><td>1.6i 16v.</td><td>BA04</td><td>-11/02</td></tr> <tr><td>1.8i 16v.</td><td>BA1A/1M/1R</td><td>-11/02</td></tr> <tr><td>1.9 D</td><td>B/SA 0A/R/U</td><td>-11/02</td></tr> <tr><td>2.0i</td><td>BA0G/7</td><td>-11/02</td></tr> </table>	1.4i	BA0E/0T/0V	-11/02	1.4i 16v.	BA0W	-11/02	1.6i	BA0F/0L/0S	-11/02	1.6i 16v.	BA04	-11/02	1.8i 16v.	BA1A/1M/1R	-11/02	1.9 D	B/SA 0A/R/U	-11/02	2.0i	BA0G/7	-11/02		3 Avec rotule With ball joint <table border="0"> <tr><td>1.4i</td><td>BA0E/0T/0V</td><td>-11/02</td></tr> <tr><td>1.4i 16v.</td><td>BA0W</td><td>-11/02</td></tr> <tr><td>1.6i</td><td>BA0F/0L/0S</td><td>-11/02</td></tr> <tr><td>1.6i 16v.</td><td>BA04</td><td>-11/02</td></tr> <tr><td>1.8i 16v.</td><td>BA1A/1M/1R</td><td>-11/02</td></tr> <tr><td>1.9 D</td><td>B/SA 0A/R/U</td><td>-11/02</td></tr> <tr><td>2.0i</td><td>BA0G/7</td><td>-11/02</td></tr> </table>	1.4i	BA0E/0T/0V	-11/02	1.4i 16v.	BA0W	-11/02	1.6i	BA0F/0L/0S	-11/02	1.6i 16v.	BA04	-11/02	1.8i 16v.	BA1A/1M/1R	-11/02	1.9 D	B/SA 0A/R/U	-11/02	2.0i	BA0G/7	-11/02
1.4i	BA0E/0T/0V	-11/02																																											
1.4i 16v.	BA0W	-11/02																																											
1.6i	BA0F/0L/0S	-11/02																																											
1.6i 16v.	BA04	-11/02																																											
1.8i 16v.	BA1A/1M/1R	-11/02																																											
1.9 D	B/SA 0A/R/U	-11/02																																											
2.0i	BA0G/7	-11/02																																											
1.4i	BA0E/0T/0V	-11/02																																											
1.4i 16v.	BA0W	-11/02																																											
1.6i	BA0F/0L/0S	-11/02																																											
1.6i 16v.	BA04	-11/02																																											
1.8i 16v.	BA1A/1M/1R	-11/02																																											
1.9 D	B/SA 0A/R/U	-11/02																																											
2.0i	BA0G/7	-11/02																																											

4003360 OE 8200737112	Triangle de susp. G <i>Left track control arm</i>	4003359 OE 8200737114	Triangle de susp. D <i>Right track control arm</i>																
	4 Avec rotule With ball joint <table border="0"> <tr><td>1.9 DTi</td><td>BA0N</td><td>BVA</td><td>-11/02</td></tr> <tr><td>2.0i 16v.</td><td>BA0H</td><td></td><td>-11/02</td></tr> </table>	1.9 DTi	BA0N	BVA	-11/02	2.0i 16v.	BA0H		-11/02		3 Avec rotule With ball joint <table border="0"> <tr><td>1.9 DTi</td><td>BA0N</td><td>BVA</td><td>-11/02</td></tr> <tr><td>2.0i 16v.</td><td>BA0H</td><td></td><td>-11/02</td></tr> </table>	1.9 DTi	BA0N	BVA	-11/02	2.0i 16v.	BA0H		-11/02
1.9 DTi	BA0N	BVA	-11/02																
2.0i 16v.	BA0H		-11/02																
1.9 DTi	BA0N	BVA	-11/02																
2.0i 16v.	BA0H		-11/02																

4005257 OE 7701472038	Rotule de susp. inf. G/D <i>L/R lower suspension ball joint</i>	4005273 OE 7701468411	Rotule de susp. inf. G/D <i>L/R lower suspension ball joint</i>																																								
	1 Trous fixation Ø10 2 <table border="0"> <tr><td>1.4i</td><td>BA0E/0T/0V</td><td>-11/02</td></tr> <tr><td>1.4i 16v.</td><td>BA0W</td><td>-11/02</td></tr> <tr><td>1.6i</td><td>BA0F BVM</td><td>-11/02</td></tr> <tr><td>1.6i</td><td>BA0L/0S</td><td>-11/02</td></tr> <tr><td>1.6i 16v.</td><td>BA04</td><td>-11/02</td></tr> <tr><td>1.8i 16v.</td><td>BA1A/1M/1R</td><td>-11/02</td></tr> <tr><td>1.9 D</td><td>BA0R SA0R</td><td>-11/02</td></tr> <tr><td>2.0i</td><td>BA0G</td><td>-11/02</td></tr> </table>	1.4i	BA0E/0T/0V	-11/02	1.4i 16v.	BA0W	-11/02	1.6i	BA0F BVM	-11/02	1.6i	BA0L/0S	-11/02	1.6i 16v.	BA04	-11/02	1.8i 16v.	BA1A/1M/1R	-11/02	1.9 D	BA0R SA0R	-11/02	2.0i	BA0G	-11/02		1 Trous fixation Ø10 2 <table border="0"> <tr><td>1.6i</td><td>BA0F</td><td>BVA</td><td>-11/02</td></tr> <tr><td>1.9 D</td><td>BA0A/0U</td><td>SA0A/0U</td><td>-11/02</td></tr> <tr><td>2.0i 16v.</td><td>BA0H</td><td></td><td>-04/07/98</td></tr> <tr><td>2.0i</td><td>BA0G/07</td><td></td><td>-11/02</td></tr> </table>	1.6i	BA0F	BVA	-11/02	1.9 D	BA0A/0U	SA0A/0U	-11/02	2.0i 16v.	BA0H		-04/07/98	2.0i	BA0G/07		-11/02
1.4i	BA0E/0T/0V	-11/02																																									
1.4i 16v.	BA0W	-11/02																																									
1.6i	BA0F BVM	-11/02																																									
1.6i	BA0L/0S	-11/02																																									
1.6i 16v.	BA04	-11/02																																									
1.8i 16v.	BA1A/1M/1R	-11/02																																									
1.9 D	BA0R SA0R	-11/02																																									
2.0i	BA0G	-11/02																																									
1.6i	BA0F	BVA	-11/02																																								
1.9 D	BA0A/0U	SA0A/0U	-11/02																																								
2.0i 16v.	BA0H		-04/07/98																																								
2.0i	BA0G/07		-11/02																																								

... Megane I ...

Bras & Triangle de suspension

Control arm
Brazo y triángulo
Wahacz
Рычаг подвески

G/L  D/R

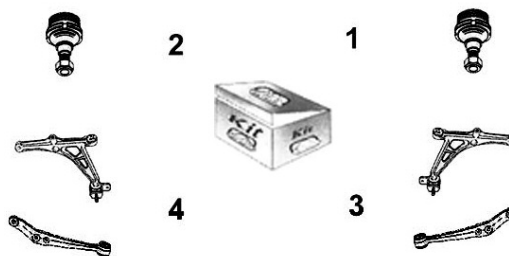

4005277

Rotule de susp. inf. G/D

Part/oe 8200942407 L/R lower suspension ball joint



1
2 Trous fixation Ø12

1.9 DCi BA05 SA05 -11/02
1.9 DTi BA0N 09/97-11/02
1.9 DTi SA0N -11/02
1.9 TD BA0Y SA0Y/09 09/97-11/02

405A410S

OE -



Kit rép. train AV

Front axle repair kit

Sans visserie Without screws and bolts
Barre Ø 23

TT /all models Sauf BA0H -18/06/96

4055410B

Kit rép. train AV complet

OE -

Front axle complete repair kit



Avec visserie With screws and bolts
Barre Ø 23

TT /all models Sauf BA0H -18/06/96

4005410

OE -

Kit rép. triangle susp. G ou D

L or R track control arm bearing repair kit



Avec visserie With screws and bolts

TT /all models Sauf BA0H -11/02



Support d'amortisseur

Suspension mounting
Soporte amortiguador
Poduszka amortyzatora
Опора амортизатора

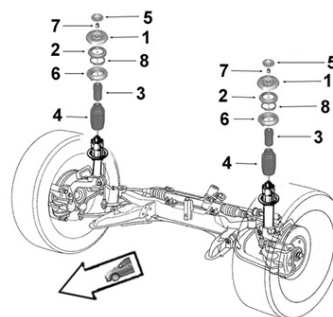

4001604

Support suspension G/D

OE 7700835254 L/R suspension mounting



1
1.4i /16v. BA0E/0T/0V BA0D/0W
1.6i /16v. BA0F/0L/0S/1C
BA00/04/0B/1K
1.8i 16v. BA1A/1M
1.9 D B/SA 0A/0R/0U
1.9 DCi BA01/05 SA05
1.9 DTi BA08/0N SA0N
1.9 TD BA09/0K/0Y SA09/0Y
2.0i BA07/0G

4001639

Support suspension G/D

OE 7700840296 L/R suspension mounting



1
2.0i 16v. BA0H

4005301

Butée à billes G/D

OE 7700777654 L/R ball bearing



2
1.4i /16v. BA0E/0T/0V BA0D/0W
1.6i /16v. BA0F/0L/0S/1C
BA00/04/0B/1K
1.8i 16v. BA1A/1M
1.9 D BA0A/0R/0U
1.9 DCi BA01/05 SA05
1.9 DTi BA08/0N SA0N
1.9 TD BA09/0K/0Y SA09/0Y
2.0i /16v. BA07/0G BA0H

4001609

Butée de suspension G/D

OE 7704000661 L/R suspension bush



3
1.4i /16v. BA0E/0T/0V BA0D/0W
1.6i /16v. BA0F/0L/0S/1C
BA00/04/0B/1K
1.8i 16v. BA1A/1M
1.9 D B/SA 0A/0R/0U
1.9 DCi B/SA 01/05
1.9 DTi BA08/0N SA0N
1.9 TD BA09/0K/0Y SA09/0Y
2.0i BA07/0G

... Megane I

RENAULT



4005372

Protecteur amortisseur G/D

OE 7700776743

L/R shock absorber protector



4

1.4i	BA0T/0V
1.4i susp. normale	BA0E
1.4i 16v. susp. normale	BA0D/0W
1.6i susp. normale	BA0F/0S
1.6i 16v.	BA1K
1.6i	BA0L/1C
1.6i 16v. susp. normale	BA04/0B
1.8i 16v. susp. normale	BA1A/1M
1.9 D	B/SA 0A
1.9 D susp. normale	BA0R/0U
1.9 DCi	B/SA05
1.9 DCi susp. normale	BA01
1.9 DTi	BA08/0N SA0N
1.9 TD	BA09/0K/0Y SA09/0Y
2.0i susp. normale	BA07/0G

4005223

Kit rép. suspension G ou D

OE -

L/R stabilizing bar repair kit



(4001604+4005301)

1.4i	BA0E/0T/0V
1.4i 16v.	BA0D/0W
1.6i	BA0F/0L/0S/1C
1.6i 16v.	BA00/04/0B/1K
1.8i 16v.	BA1A/1M
1.9 D	BA0A/0R/0U
1.9 DCi	BA01/05 SA05
1.9 DTi	BA08/0N SA0N
1.9 TD	BA09/0K/0Y SA09/0Y
2.0i	BA07/0G

Eléments TRAIN ARRIERE

Rear axle parts

Tren TRAS

Elementy zawieszenia tylnego

элементы задней оси.



4003398

Articulation AR

OE 7700776733

Rear bush



Ø int.43 Ø ext.77 long. tube int.36 ext.36

TT /all models Train à tube

4005350B

Kit rép. train AR G ou D

OE -

L/R rear axle repair kit



TT /all models Train à tube -11/02

Megane I Break ...

Eléments DIRECTION

Steering parts

Elementos Direcciones

Elementy układ kierowniczy

Элементы рулевой системы

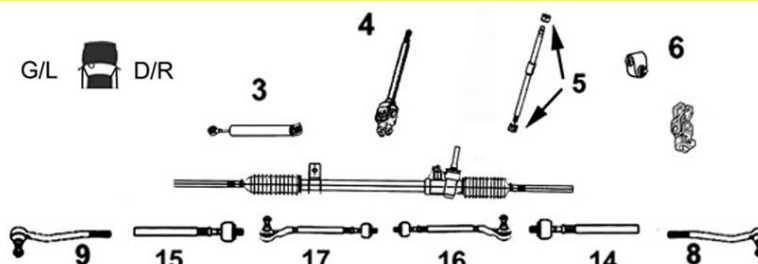

RENAULT

SASIC

3008046

Axe de bielle G/D

Part/oe 7701471844

L/R axial joint



14 Côté dir. M12x1.0 Côté rot. M14x1.5
15 long 294 mm

TT /all models
DA SMI KA 17/02/99-11/02

3008047

Axe de bielle G/D

Part/oe 7701472087

L/R axial joint



14 Côté dir. M14x1.5 Côté rot. M14x1.5
15 long 287 mm

TT /all models
Dir. TRW KA 17/02/99-11/02

4006108

Rotule de direction G

OE 7701472087

Left tie rod end



9
TT /all models
Dir. SMI Koyo TRW -17/02/99

4006109

Rotule de direction D

OE 7701041312

Right tie rod end



8
TT /all models
Dir. SMI Koyo TRW -17/02/99

4006134

Rotule de direction G

OE 7701474492

Left tie rod end



9
TT /all models
DA SMI TRW 17/02/99-11/02

4006135

Rotule de direction D

OE 7701474493

Right tie rod end



8
TT /all models
DA SMI TRW 17/02/99-11/02



Barre stabilisatrice

Stabilizer bar

Barra estabilizadora

Drażek stabilizatora

стабилизатор поперечной устойчивости

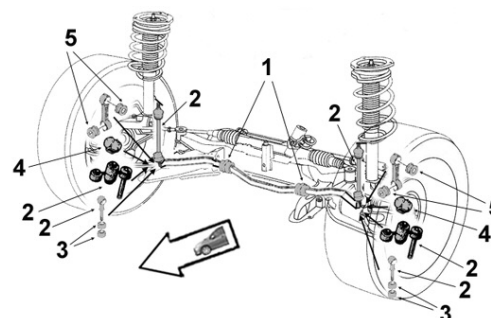

2304005

Palier de barre bout

OE 8200150768

End bar main bearing



4
1.4i KA0V
1.4i 16v. KA0W
1.6 KA0F 09/07/98-
1.6i 16v. KA04
1.8i 16v. KA1A/1M/1R
1.9 D KA0J
1.9 DCi KA05
1.9 DTi KA0N

4001554

Palier de barre milieu

OE 7700428738

Middle bar main bearing



1 Barre Ø 24.5
1.4i KA0V
1.4i 16v. KA0W
1.6 KA0F 09/07/98-
1.6i 16v. KA04
1.8i 16v. KA1A/1M/1R
1.9 D KA0J
1.9 DCi KA05
1.9 DTi KA0N

... Megane I Break ...

RENAULT



4155410 OE -	Kit rép. barre stab. G et D <i>L R Stabilizing bar repair kit</i> Barre Ø 23 TT /all models -11/02	4005086 OE -	Kit rép. barre stab. G et D <i>L R Stabilizing bar repair kit</i> Barre Ø 24 TT /all models -11/02
			

4005070 OE -	Kit rép. barre stab. G et D <i>L R Stabilizing bar repair kit</i> Barre Ø 25 TT /all models -11/02
	



Eléments SUSPENSION

Suspension parts

Elementos suspensión

Elementy zawieszenie

Элементы подвески

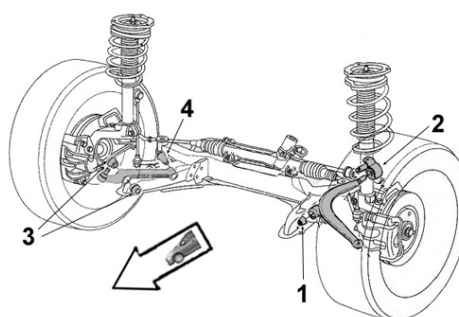

4001413 OE 8200651163	Articulation AV/AR <i>Front rear bush</i> 1 Ø int.12 Ø ext.45 long. tube int.46 ext.34.5 2 <table style="width: 100%; border: none;"> <tr> <td style="width: 50%;">1.4i</td> <td>KA0V</td> </tr> <tr> <td>1.4i 16v.</td> <td>KA0D/0W</td> </tr> <tr> <td>1.6</td> <td>KA0F</td> </tr> <tr> <td>1.6i 16v.</td> <td>KA04/0B</td> </tr> <tr> <td>1.8i 16v.</td> <td>KA1A</td> </tr> <tr> <td>1.9 D</td> <td>KA0J</td> </tr> <tr> <td>1.9 DCi</td> <td>KA01/05</td> </tr> <tr> <td>1.9 DTi</td> <td>KA0N/1U</td> </tr> </table>	1.4i	KA0V	1.4i 16v.	KA0D/0W	1.6	KA0F	1.6i 16v.	KA04/0B	1.8i 16v.	KA1A	1.9 D	KA0J	1.9 DCi	KA01/05	1.9 DTi	KA0N/1U
1.4i	KA0V																
1.4i 16v.	KA0D/0W																
1.6	KA0F																
1.6i 16v.	KA04/0B																
1.8i 16v.	KA1A																
1.9 D	KA0J																
1.9 DCi	KA01/05																
1.9 DTi	KA0N/1U																
																	

Bras & Triangle de suspension

Control arm



Brazo y triángulo

Wahacz

Рычаг подвески

G/L  D/R



4003358 OE 8200737134	Triangle de susp. G <i>Left track control arm</i> 4 Avec rotule With ball joint <table style="width: 100%; border: none;"> <tr> <td style="width: 33%;">1.4i</td> <td style="width: 33%;">KA0V</td> <td style="width: 33%;">-11/02</td> </tr> <tr> <td>1.4i 16v.</td> <td>KA0W</td> <td>-11/02</td> </tr> <tr> <td>1.6</td> <td>KA0F</td> <td>-11/02</td> </tr> <tr> <td>1.6i 16v.</td> <td>KA04</td> <td>-11/02</td> </tr> <tr> <td>1.8i 16v.</td> <td>KA1A/1M/1R</td> <td>-11/02</td> </tr> </table>	1.4i	KA0V	-11/02	1.4i 16v.	KA0W	-11/02	1.6	KA0F	-11/02	1.6i 16v.	KA04	-11/02	1.8i 16v.	KA1A/1M/1R	-11/02
1.4i	KA0V	-11/02														
1.4i 16v.	KA0W	-11/02														
1.6	KA0F	-11/02														
1.6i 16v.	KA04	-11/02														
1.8i 16v.	KA1A/1M/1R	-11/02														
																
4003357 OE 8200737135	Triangle de susp. D <i>Right track control arm</i> 3 Avec rotule With ball joint <table style="width: 100%; border: none;"> <tr> <td style="width: 33%;">1.4i</td> <td style="width: 33%;">KA0V</td> <td style="width: 33%;">-11/02</td> </tr> <tr> <td>1.4i 16v.</td> <td>KA0W</td> <td>-11/02</td> </tr> <tr> <td>1.6</td> <td>KA0F</td> <td>-11/02</td> </tr> <tr> <td>1.6i 16v.</td> <td>KA04</td> <td>-11/02</td> </tr> <tr> <td>1.8i 16v.</td> <td>KA1A/1M/1R</td> <td>-11/02</td> </tr> </table>	1.4i	KA0V	-11/02	1.4i 16v.	KA0W	-11/02	1.6	KA0F	-11/02	1.6i 16v.	KA04	-11/02	1.8i 16v.	KA1A/1M/1R	-11/02
1.4i	KA0V	-11/02														
1.4i 16v.	KA0W	-11/02														
1.6	KA0F	-11/02														
1.6i 16v.	KA04	-11/02														
1.8i 16v.	KA1A/1M/1R	-11/02														
																

... Megane I Break ...

SASIC

RENAULT

Bras & Triangle de suspension

Control arm
Brazo y triángulo
Wahacz
Рычаг подвески

G/L  D/R



4005257

Rotule de susp. inf. G/D

OE 7701472038

L/R lower suspension ball joint



1
2

Trous fixation Ø10

1.4i /16v.	KA0V/0W	-11/02
1.6i	KA0F	-11/02
1.6i 16v.	KA04	-11/02
1.8i 16v.	KA1A/1M/1R	-11/02

4005277

Rotule de susp. inf. G/D

Part/oe 8200942407

L/R lower suspension ball joint



1
2

Trous fixation Ø12

1.9 D	KA0J	-02/01
1.9 DCi	KA0N	-11/02
1.9 DTi	KA05	-11/02

405A410S

Kit rép. train AV

OE -

Front axle repair kit



Sans visserie Without screws and bolts
Barre Ø 23

TT /all models -18/06/96

4055410B

Kit rép. train AV complet

OE -

Front axle complete repair kit



Avec visserie With screws and bolts
Barre Ø 23

TT /all models -18/06/96

4005410

Kit rép. triangle susp. G ou D

OE -

L or R track control arm bearing repair kit



Avec visserie With screws and bolts

TT /all models -11/02



Support d'amortisseur

Suspension mounting
Soporte amortiguador
Poduszka amortyzatora
Опора амортизатора

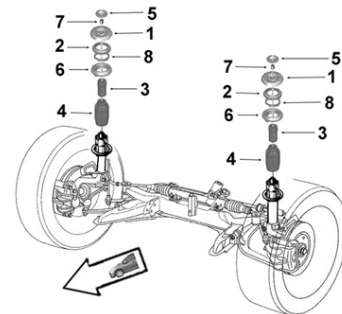

4001604

Support suspension G/D

OE 7700835254

L/R suspension mounting



1

1.4i	KA0V
1.4i 16v.	KA0D/0W
1.6	KA0F
1.6i 16v.	KA04/0B
1.8i 16v.	KA1A/1M
1.9 D	KA0J
1.9 DCi	KA01/05
1.9 DTi	KA0N

4005301

Butée à billes G/D

OE 7700777654

L/R ball bearing





2

1.4i	KA0V
1.4i 16v.	KA0D/0W
1.6	KA0F
1.6i 16v.	KA04/0B
1.8i 16v.	KA1A/1M
1.9 D	KA0J
1.9 DCi	KA01/05
1.9 DTi	KA0N

... Megane I Break

RENAULT



4001609 OE 7704000661	Butée de suspension G/D <i>L/R suspension bush</i>	4005372 OE 7700776743	Protecteur amortisseur G/D <i>L/R shock absorber protector</i>
	3 1.4i KA0V 1.4i 16v. KA0D/0W 1.6 KA0F 1.6i 16v. KA04 1.8i 16v. KA1A/1M 1.9 D KA0J 1.9 DCi KA01/05 1.9 DTi KA0N		4 1.4i KA0V 1.4i 16v. susp. normale KA0D/0W 1.6 susp. normale KA0F 1.6i 16v. KA04/0B 1.8i 16v. KA1A/1M 1.9 D susp. normale KA0J 1.9 DCi susp. normale KA01 1.9 DCi KA05 1.9 DTi susp. normale KA0N

Eléments TRAIN ARRIERE



Rear axle parts

Tren TRAS

Elementy zawieszenia tylnego

элементы задней оси.



4003398 OE 7700776733	Articulation AR <i>Rear bush</i>	4003385 OE 7700762844	Articulation AR <i>Rear bush</i>
	Ø int.43 Ø ext.77 long. tube int.36 ext.36 TT /all models Train à tube		Ø int.32 Ø ext.72 long. tube int.73 ext.37 1.4i KA0V 1.4i 16v. KA0D/0W/10/1H 1.6 KA0F 1.6i 16v. KA04/0B/11/1J 1.8i 16v. KA12/1A/1R 1.9 D KA0J 1.9 DCi KA05 1.9 DTi KA0N KA1U

4005350B OE -	Kit rép. train AR G ou D <i>L/R rear axle repair kit</i>
	TT /all models Train à tube -11/02

Megane I Cabriolet ...

Eléments DIRECTION



Steering parts

Elementos Direcciones

Elementy układ kierowniczy

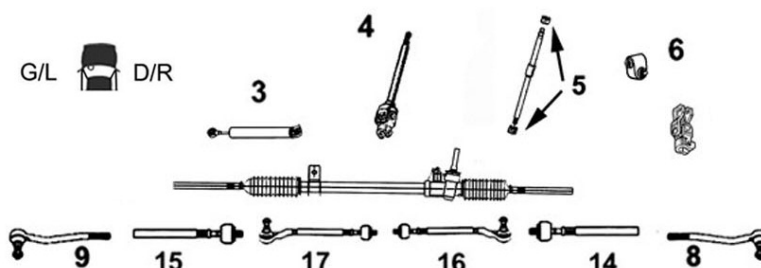
Элементы рулевой системы



3008049 Part/oe 7701469502	Axe de bielle G/D <i>L/R axial joint</i>	3008050 Part/oe 7701471885	Axe de bielle G/D <i>L/R axial joint</i>
	14 Côté dir. M12x1.0 Côté rot. M14x1.5 15 long 260 mm TT /all models DA SMI -18/09/98		14 Côté dir. M12x1.0 Côté rot. M14x1.5 15 long 257 mm TT /all models DA SMI 18/09/98-17/02/99

... Megane I Cabriolet ...

Eléments DIRECTION

Steering parts

Elementos Direcciones





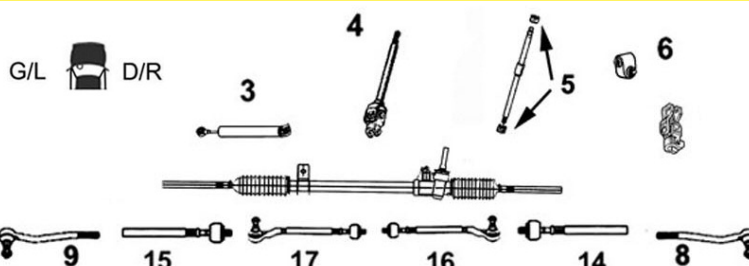

Elementy układ kierowniczy

Элементы рулевой системы

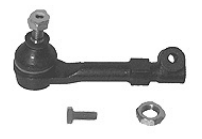
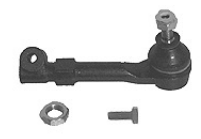

RENAULT

SASIC

<p>3008046 Part/oe 7701471844</p> 	<p>Axe de bielle G/D <i>L/R axial joint</i></p> <p>14 Côté dir. M12x1.0 Côté rot. M14x1.5 15 long 294 mm</p> <p>TT /all models DA SMI EA sauf EA0H EA03 17/02/99-11/02</p>	<p>3008109 Part/oe 7701469280</p> 	<p>Axe de bielle G/D <i>L/R axial joint</i></p> <p>14 Côté dir. M14x1.5 Côté rot. M14x1.5 15 long 255 mm</p> <p>Dir. TRW</p> <p>1.6 EA0F -17/02/99 2.0i EA0G -17/02/99</p>
<p>3008047 Part/oe 7701472087</p> 	<p>Axe de bielle G/D <i>L/R axial joint</i></p> <p>14 Côté dir. M14x1.5 Côté rot. M14x1.5 15 long 287 mm</p> <p>Dir. TRW</p> <p>1.4i 16v. EA0W 17/02/99-11/02 1.6 EA0F 17/02/99-11/02 1.6i 16v. EA04 17/02/99-11/02 2.0i EA0G 17/02/99-11/02 2.0 IDE 16v. EA0P/3 17/02/99-11/02</p>	<p>3008051 Part/oe 7701469283</p> 	<p>Axe de bielle G/D <i>L/R axial joint</i></p> <p>14 Côté dir. M14x1.5 Côté rot. M14x1.5 15 long 263 mm</p> <p>2.0i 16v. EA0H -17/02/99</p>
<p>3008043 Part/oe 7701472089</p> 	<p>Axe de bielle G/D <i>L/R axial joint</i></p> <p>14 Côté dir. M14x1.5 Côté rot. M14x1.5 long 293 mm 15</p> <p>2.0i 16v. EA0H 17/02/99-11/02 2.0 IDE EA03 -11/02</p>		
<p>4006108 OE 7701472087</p> 	<p>Rotule de direction G <i>Left tie rod end</i></p> <p>9</p> <p>TT /all models Dir. SMI Koyo TRW -17/02/99</p>	<p>4006109 OE 7701041312</p> 	<p>Rotule de direction D <i>Right tie rod end</i></p> <p>8</p> <p>TT /all models Dir. SMI Koyo TRW -17/02/99</p>
<p>4006134 OE 7701474492</p> 	<p>Rotule de direction G <i>Left tie rod end</i></p> <p>9</p> <p>TT /all models DA SMI TRW 17/02/99-11/02</p>	<p>4006135 OE 7701474493</p> 	<p>Rotule de direction D <i>Right tie rod end</i></p> <p>8</p> <p>TT /all models DA SMI TRW 17/02/99-11/02</p>

... Megane I Cabriolet ...



Barre stabilisatrice
 Stabilizer bar
 Barra estabilizadora
 Drażek stabilizatora
 стабилизатор поперечной устойчивости

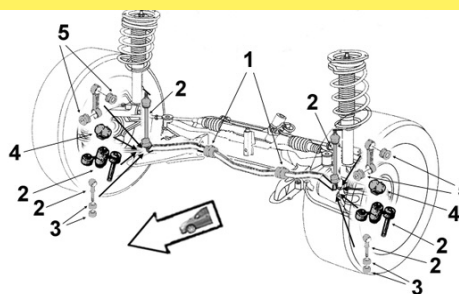

RENAULT



<p>4005151 OE 8200150759</p> 	<p>Palier de barre bout <i>End bar main bearing</i></p> <p>4</p> <p>1.4i 16v. EA0W 1.6i EA0F 09/09/98- 1.6i 16v. EA04 2.0i EA0G 09/09/98-</p>	<p>4001522 OE 7700784171</p> 	<p>Palier de barre bout <i>End bar main bearing</i></p> <p>4 Barre Ø 24</p> <p>1.6i EA0F -09/09/98 2.0i EA0G -09/09/98 2.0i 16v. EA0H</p>
<p>2304005 OE 8200150768</p> 	<p>Palier de barre bout <i>End bar main bearing</i></p> <p>4</p> <p>2.0i 16v. EA0C/1S F4R746 2.0 IDE 16v. EA03</p>	<p>4001553 OE 7700428665</p> 	<p>Palier de barre milieu <i>Middle bar main bearing</i></p> <p>1 Barre Ø 23.5</p> <p>1.4i 16v. EA0W 1.6i EA0F 09/09/98- 1.6i 16v. EA04 2.0i EA0G 09/09/98-</p>
<p>4001517 OE 7700835929</p> 	<p>Palier de barre milieu <i>Middle bar main bearing</i></p> <p>1 Barre Ø 24</p> <p>1.6i EA0F -09/09/98 2.0i 16v. EA0H</p>	<p>4001554 OE 7700428738</p> 	<p>Palier de barre milieu <i>Middle bar main bearing</i></p> <p>1 Barre Ø 24.5</p> <p>2.0i 16v. EA0C/13/1S 2.0 IDE 16v. EA03</p>
<p>4155410 OE -</p> 	<p>Kit rép. barre stab. G et D <i>L R Stabilizing bar repair kit</i></p> <p>Barre Ø 23</p> <p>TT /all models -11/02</p>	<p>4005086 OE -</p> 	<p>Kit rép. barre stab. G et D <i>L R Stabilizing bar repair kit</i></p> <p>Barre Ø 24</p> <p>TT /all models -11/02</p>
<p>4005070 OE -</p> 	<p>Kit rép. barre stab. G et D <i>L R Stabilizing bar repair kit</i></p> <p>Barre Ø 25</p> <p>TT /all models -11/02</p>		

... Megane I Cabriolet ...



Eléments SUSPENSION
Suspension parts
Elementos suspensión
Elementy zawieszenie
Элементы подвески

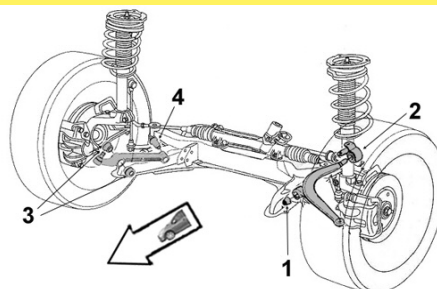

RENAULT

SASIC

4001413

Articulation AV/AR

OE 8200651163

Front rear bush



1
2

Ø int.12 Ø ext.45 long. tube int.46 ext.34.5

1.4i 16v.	EA0W
1.6	EA0F
1.6i 16v.	EA04
2.0i	EA0G

4001529

Articulation AV/AR

OE 8200651169

Front rear bush



1
2

Ø int.12 Ø ext.45 long. tube int.46 ext.35

2.0i 16v.	EA0H
2.0 IDE 16v.	EA03

Bras & Triangle de suspension

Control arm
Brazo y triángulo
Wahacz
Рычаг подвески

G/L D/R



4003358

Triangle de susp. G

OE 8200737134

Left track control arm



4

Avec rotule With ball joint

1.4i 16v.	EA0W	-11/02
1.6	EA0F	-11/02
1.6i 16v.	EA04	-11/02
2.0i	EA0G	-11/02

4003357

Triangle de susp. D

OE 8200737135

Right track control arm



3

Avec rotule With ball joint

1.4i 16v.	EA0W	-11/02
1.6	EA0F	-11/02
1.6i 16v.	EA04	-11/02
2.0i	EA0G	-11/02

4003360

Triangle de susp. G

OE 8200737112

Left track control arm



4

Avec rotule With ball joint

2.0i 16v.	EA0H	-11/02
2.0 IDE 16v.	EA03	-11/02

4003359

Triangle de susp. D

OE 8200737114

Right track control arm



3

Avec rotule With ball joint

2.0i 16v.	EA0H	-11/02
2.0 IDE 16v.	EA03	-11/02

4005257

Rotule de susp. inf. G/D

OE 7701472038

L/R lower suspension ball joint



1
2

Trous fixation Ø10

1.4i	EA0E	-11/02
1.4i 16v.	EA0W	-11/02
1.6	EA0F	-11/02
1.6i 16v.	EA04	-11/02

4005273

Rotule de susp. inf. G/D

OE 7701468411

L/R lower suspension ball joint



1
2











Trous fixation Ø10

2.0i	EA0G	-11/02
2.0i 16v.	EA0H	-11/98

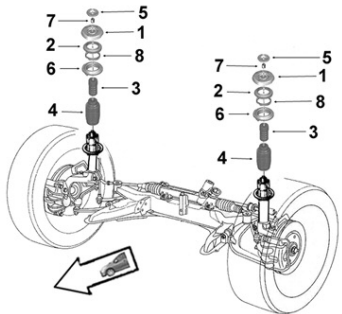
... Megane I Cabriolet ...

RENAULT



405A410S OE -	Kit rép. train AV <i>Front axle repair kit</i>	4055410B OE -	Kit rép. train AV complet <i>Front axle complete repair kit</i>
	Sans visserie <i>Without screws and bolts</i> Barre Ø 23 TT /all models Sauf EA0H -18/06/96		Avec visserie <i>With screws and bolts</i> Barre Ø 23 TT /all models Sauf EA0H -18/06/96
4005410 OE -			
Kit rép. triangle susp. G ou D <i>L or R track control arm bearing repair kit</i>			
	Avec visserie <i>With screws and bolts</i> TT /all models Sauf EA0H -11/02		
<div style="display: flex; justify-content: space-between; align-items: center;"> <div style="width: 45%;">  <p>Support d'amortisseur <i>Suspension mounting</i> Soporte amortiguador Poduszka amortyzatora Опора амортизатора</p> </div> <div style="width: 50%; text-align: center;">  </div> </div>			
4001604 OE 7700835254	Support suspension G/D <i>L/R suspension mounting</i>	4001639 OE 7700840296	Support suspension G/D <i>L/R suspension mounting</i>
	1 1.4i 16v. EA0D/0W 1.6 EA0F 1.6i 16v. EA0B/04 2.0i EA0G		1 2.0i 16v. EA0H 2.0 IDE EA0P/03
4005301 OE 7700777654	Butée à billes G/D <i>L/R ball bearing</i>	4001609 OE 7704000661	Butée de suspension G/D <i>L/R suspension bush</i>
	2 1.4i 16v. EA0D/0W 1.6 EA0F 1.6i 16v. EA0B/04 2.0i EA0G 2.0i 16v. EA0H 2.0 IDE EA0P/03		3 1.4i 16v. EA0D/0W 1.6 EA0F 1.6i 16v. EA0B/04 2.0i EA0G
4005372 OE 7700776743			
Protecteur amortisseur G/D <i>L/R shock absorber protector</i>			
	4 1.4i 16v. EA0D/0W 1.6 EA0F 1.6i 16v. EA04/0B 2.0i EA0G		

... Megane I Cabriolet

Eléments TRAIN ARRIERE

Rear axle parts

Tren TRAS

Elementy zawieszenia tylnego

элементы задней оси.



SASIC

RENAULT

4003398

Articulation AR

OE 7700776733

Rear bush

Ø int.43 Ø ext.77 long. tube int.36 ext.36



TT /all models Train à tube

4005350B

Kit rép. train AR G ou D

OE -

L/R rear axle repair kit



TT /all models Train à tube -11/02

Megane I Classic ...

Eléments DIRECTION

Steering parts

Elementos Direcciones

Elementy układ kierowniczy

Элементы рулевой системы

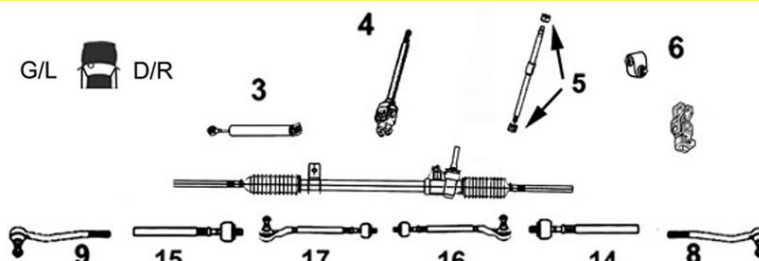

3008049

Axe de bielle G/D

Part/oe 7701469502

L/R axial joint



14 Côté dir. M12x1.0 Côté rot. M14x1.5
15 long 260 mm

TT /all models DA SMI -18/09/98

3008050

Axe de bielle G/D

Part/oe 7701471885

L/R axial joint



14 Côté dir. M12x1.0 Côté rot. M14x1.5
15 long 257 mm

TT /all models
DA SMI 18/09/98-17/02/99

3008046

Axe de bielle G/D

Part/oe 7701471844

L/R axial joint



14 Côté dir. M12x1.0 Côté rot. M14x1.5
15 long 294 mm

TT /all models
DA SMI LA 17/02/99-11/02

3008109

Axe de bielle G/D

Part/oe 7701469280

L/R axial joint



14 Côté dir. M14x1.5 Côté rot. M14x1.5
15 long 255 mm Dir. TRW

1.6	LA0F	-17/02/99
1.9 D	LA0A/0R	-17/02/99
1.9 DTi	LA0N	-17/02/99
1.9 TD	LA0Y/0K	-17/02/99
2.0i	LA0G	-17/02/99

3008047

Axe de bielle G/D

Part/oe 7701472087

L/R axial joint









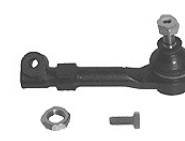

14 Côté dir. M14x1.5 Côté rot. M14x1.5
15 long 287 mm Dir. TRW

1.4i	LA0E	17/02/99-11/02
1.4i 16v.	LA0D/0W/1H	17/02/99-11/02
1.6i 16v.	LA0B/04/1J	17/02/99-11/02
1.9 D	LA0A/0R	17/02/99-11/02
1.9 DTi	LA0N	17/02/99-11/02
1.9 TD	LA0Y/0K	17/02/99-11/02
2.0i	LA0G	17/02/99-11/02

... Megane I Classic ...

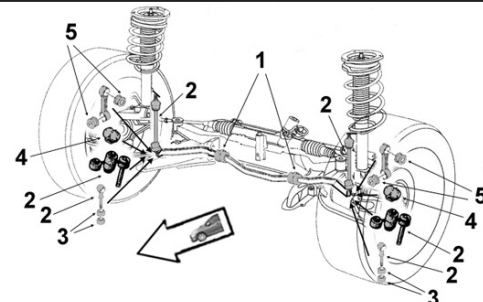
RENAULT



4006108 OE 7701472087	Rotule de direction G <i>Left tie rod end</i>	4006109 OE 7701041312	Rotule de direction D <i>Right tie rod end</i>
	9 TT /all models Dir. SMI Koyo TRW -17/02/99		8 TT /all models Dir. SMI Koyo TRW -17/02/99
4006134 OE 7701474492	Rotule de direction G <i>Left tie rod end</i>	4006135 OE 7701474493	Rotule de direction D <i>Right tie rod end</i>
	9 TT /all models Dir. SMI TRW 17/02/99-11/02		8 TT /all models Dir. SMI TRW 17/02/99-11/02
 <p>Barre stabilisatrice Stabilizer bar Barra estabilizadora Drażek stabilizatora стабилизатор поперечной устойчивости</p>			
4001475 OE 7700784170	Palier de barre bout <i>End bar main bearing</i>	4005151 OE 8200150759	Palier de barre bout <i>End bar main bearing</i>
	4 Barre Ø 23 1.4i LA0E -09/07/98 1.6i LA0F/0L/0S -09/07/98 1.6i susp. normale LA0F 08/99- 1.6i susp. renforcée LA0F 1.6i /16v. LA1C LA00 1.9 D LA0A/0U -09/07/98 1.9 DTi particularités techniques 31/32/37 LA0N 2.0i LA0G -09/07/98 2.0i LA0G 08/99- 2.0i LA07		4 1.4i susp. renforcée LA0V 1.4i susp. renforcée LA0E 09/07/98- 1.4i 16v. susp. renforcée LA0W 1.6i LA0S 09/07/98- 1.6i susp. renforcée LA0F 09/07/98-03/99 1.6i 16v. susp. renforcée LA04 1.9 D susp. renforcée LA0A/0U 09/07/98- 1.9 D susp. renforcée LA0R 1.9 DTi susp. renforcée particularités techniques 0/5/6/8/24/33 LA0N 09/07/98- 2.0i susp. renforcée LA0G 09/07/98-03/99
2304005 OE 8200150768	Palier de barre bout <i>End bar main bearing</i>	4005129 OE 7700847382	Palier de barre bout <i>End bar main bearing</i>
	4 1.4i Susp. normale LA0V 1.4i Susp. normale LA0E 09/07/98- 1.4i 16v. Susp. normale LA0W 1.6 Susp. normale LA0F 09/07/98-03/99 1.6 LA0L 09/07/98- 1.6i 16v. Susp. normale LA04 1.9 D Susp. normale LA0A/0U 09/07/98- 1.9 D Susp. normale LA0R 1.9 DCi LA05 1.9 DTi Susp. normale LA0N 09/07/98- 2.0i Susp. normale LA0G 09/07/98-03/99		2 1.9 DTi LA08 1.9 DTi LA0N -01/09/97 1.9 TD LA0K/0Y

... Megane I Classic ...



Barre stabilisatrice
 Stabilizer bar
 Barra estabilizadora
 Drążek stabilizatora
 стабилизатор поперечной устойчивости

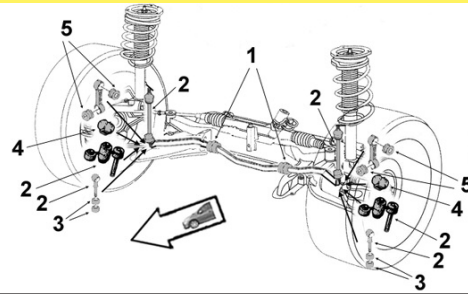

RENAULT



4001476 **Palier de barre milieu**
 OE 7700785788 *Middle bar main bearing*



1	Barre Ø 23			
	1.4i		LA0E	-09/07/98
	1.6i		LA0F/0L/0S	-09/07/98
	1.9 D		LA0A/0U	-09/07/98
	1.9 DTi		LA0N	09/97-09/07/98
	2.0i		LA0G	-09/07/98
	2.0i		LA0G	08/99-
	2.0i		LA07	

4001553 **Palier de barre milieu**
 OE 7700428665 *Middle bar main bearing*



1	Barre Ø 23.5			
	1.4i	susp. renforcée	LA0E	09/07/98-
	1.4i	susp. renforcée	LA0V	
	1.4i 16v.	susp. renforcée	LA0W	
	1.6i	susp. renforcée	LA0F	09/07/98-03/99
	1.6i	susp. renforcée	LA0S	09/07/98-
	1.6i 16v.	susp. renforcée	LA04	
	1.9 D	susp. renforcée	LA0A/0U	09/07/98-
	1.9 D	susp. renforcée	LA0R	
	1.9 DTi	susp. renforcée	LA0N	09/07/98-
	2.0i	susp. renforcée	LA0G	09/07/98-03/99

4001554 **Palier de barre milieu**
 OE 7700428738 *Middle bar main bearing*



1	Barre Ø 24.5			
	1.4i	susp. normale	LA0E	09/07/98-
	1.4i/ 16v.	susp. normale	LA0V LA0W	
	1.6i	susp. normale	LA0F	09/07/98-03/99
	1.6i	susp. normale	LA0L	09/07/98-
	1.6i 16v.	susp. normale	LA04	
	1.9 D	susp. normale	LA0A/0U	09/07/98-
	1.9 D	susp. normale	LA0R	
	1.9 DCi	susp. normale	LA05	
	1.9 DTi	susp. normale	LA0N	09/07/98-
	2.0i	susp. normale	LA0G	09/07/98-03/99

4001517 **Palier de barre milieu**
 OE 7700835929 *Middle bar main bearing*



1	Barre Ø 24			
	1.9 DTi	LA08		
	1.9 DTi	LA0N	-01/09/97	
	1.9 TD	LA0K/0Y		

4155410 **Kit rép. barre stab. G et D**
 OE - *L R Stabilizing bar repair kit*

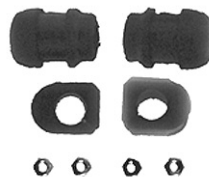

	Barre Ø 23		
TT /all models			-11/02

4005086 **Kit rép. barre stab. G et D**
 OE - *L R Stabilizing bar repair kit*

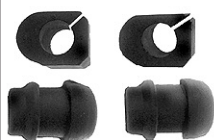

	Barre Ø 24		
TT /all models			-11/02

4005070 **Kit rép. barre stab. G et D**
 OE - *L R Stabilizing bar repair kit*



	Barre Ø 25		
TT /all models			-11/02

... Megane I Classic ...



Eléments SUSPENSION

Suspension parts

Elementos suspensión

Elementy zawieszenie

Элементы подвески

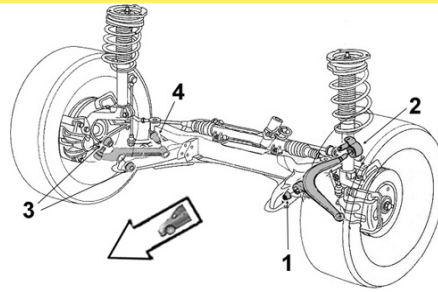

RENAULT



4001413

Articulation AV/AR

OE 8200651163

Front rear bush



1
2

Ø int.12 Ø ext.45 long. tube int.46 ext.34.5

1.4i/ 16v.	LA0E/0V	LA0D/0W
1.6i/ 16v.	LA0F/1C	LA00/04/0B/1K
1.8i 16v.	LA1A/1M	
1.9 D	LA0A/0R/0U	
1.9 DCi	LA01/05	
1.9 DTi	LA08/0N	
1.9 TD	LA0Y	
2.0i	LA0G/07	

Bras & Triangle de suspension

Control arm

Brazo y triángulo

Wahacz

Рычаг подвески

G/L  D/R



4003358

Triangle de susp. G

OE 8200737134

Left track control arm



4

Avec rotule With ball joint

1.4i	LA0E	-02/99
1.4i 16v.	LA0W	-11/02
1.6	LA0F/0L/0S	-02/99
1.6i 16v.	LA04	-11/02
1.9 D	LA0A/0R/0U	-02/99
2.0i	LA07	-11/02
2.0i	LA0G	-02/99

4003357

Triangle de susp. D

OE 8200737135

Right track control arm



3

Avec rotule With ball joint

1.4i	LA0E	-02/99
1.4i 16v.	LA0W	-11/02
1.6	LA0F/0L/0S	-02/99
1.6i 16v.	LA04	-11/02
1.9 D	LA0A/0R/0U	-02/99
2.0i	LA07	-11/02
2.0i	LA0G	-02/99

4005257

Rotule de susp. inf. G/D

OE 7701472038

L/R lower suspension ball joint



1
2

Trous fixation Ø10

1.4i	LA0E	-02/99
1.4i	LA0V	-11/02
1.4i 16v.	LA0W	-08/02
1.6	LA0L/0S	-02/99
1.6	LA0F BVM	-11/02
1.6i 16v.	LA04	-06/01
1.9 D	LA0R	-03/01

4005273

Rotule de susp. inf. G/D

OE 7701468411

L/R lower suspension ball joint



1
2

Trous fixation Ø10

1.6	LA0F BVA	-11/02
1.9 D	LA0A/0U	-07/97
2.0i	LA0A/0G	-02/99

4005277

Rotule de susp. inf. G/D

Part/oe 8200942407

L/R lower suspension ball joint



1
2

Trous fixation Ø12

1.9 DCi	LA05	-08/02
1.9 DTi	LA0N	09/97-11/02

405A410S

Kit rép. train AV

OE -

Front axle repair kit



Sans visserie Without screws and bolts
Barre Ø 23

TT /all models -18/06/96

... Megane I Classic ...

SASIC

RENAULT

Bras & Triangle de suspension

Control arm
Brazo y triángulo
Wahacz
Рычаг подвески

G/L  D/R



4055410B

OE -



Kit rép. train AV complet

Front axle complete repair kit

Avec visserie With screws and bolts
Barre Ø 23

TT /all models -18/06/96

4005410

OE -



Kit rép. triangle susp. G ou D

L or R track control arm bearing repair kit

Avec visserie With screws and bolts

TT /all models -11/02



Support d'amortisseur

Suspension mounting
Soporte amortiguador
Poduszka amortyzatora
Опора амортизатора

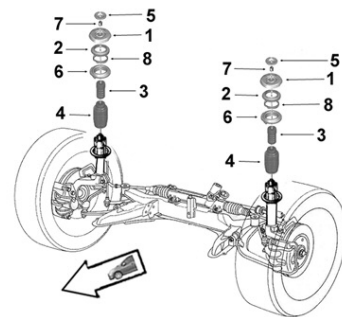

4001604

OE 7700835254



Support suspension G/D

L/R suspension mounting

1	1.4i/ 16v.	LA0E/0V	LA0D/0W
	1.6	LA0F/0L/0S/1C	
	1.6i 16v.	LA00/04/0B/1K	
	1.8i 16v.	LA1A/1M	
	1.9 D	LA0A/0R/0U	
	1.9 DCi	LA01/05	
	1.9 DTi	LA08/0N	
	1.9 TD	LA0K	
	2.0i	LA07/0G	

4005301

OE 7700777654



Butée à billes G/D

L/R ball bearing

2	1.4i/ 16v.	LA0E/0V	LA0D/0W
	1.6	LA0F/0L/0S/1C	
	1.6i 16v.	LA00/04/0B/1K	
	1.8i 16v.	LA1A/1M	
	1.9 D	LA0A/0R/0U	
	1.9 DCi	LA01/05	
	1.9 DTi	LA08/0N	
	1.9 TD	LA0K	
	2.0i	LA07/0G	

4001609

OE 7704000661



Butée de suspension G/D

L/R suspension bush

3	1.4i	LA0E/0V	
	1.4i 16v.	LA0D/0W	
	1.6	LA0F/0L/0S/1C	
	1.6i 16v.	LA00/04/0B/1K	
	1.8i 16v.	LA1A/1M	

1.9 D	LA0A/0R/0U
1.9 DCi	LA01/05
1.9 DTi	LA08/0N
1.9 TD	LA0K/0Y
2.0i	LA07/0G

4005372

OE 7700776743



Protecteur amortisseur G/D

L/R shock absorber protector

4	1.4i		LA0V
	1.4i/ 16v.	susp. normale	LA0E LA0D/0W
	1.6	susp. normale	LA0F/0S
	1.6i 16v.		LA0L/1C LA1K
	1.6i 16v.	susp. normale	LA04/0B
	1.8i 16v.	susp. normale	LA1A/1M
	1.9 D	susp. normale	LA0A/0R/0U
	1.9 DCi	susp. normale	LA01/05
	1.9 DTi		LA08/0N
	1.9 TD		LA0K/0Y
	2.0i	susp. normale	LA07/0G

... Megane I Classic

Eléments TRAIN ARRIERE

Rear axle parts

Tren TRAS



Elementy zawieszenia tylnego

элементы задней оси.



RENAULT



4003398 OE 7700776733	Articulation AR <i>Rear bush</i>	4005350B OE -	Kit rép. train AR G ou D <i>L/R rear axle repair kit</i>
	Ø int.43 Ø ext.77 long. tube int.36 ext.36 TT /all models Train à tube		TT /all models Train à tube -11/02

Megane I Coupé ...

Eléments DIRECTION





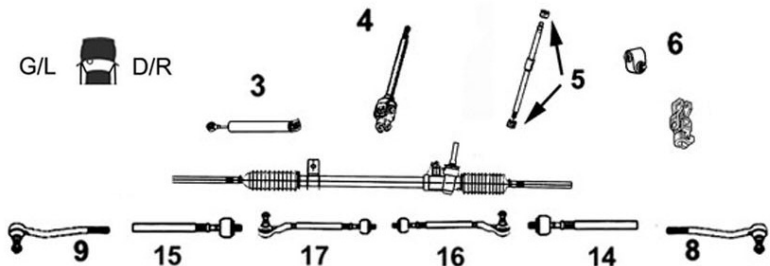

Steering parts

Elementos Direcciones

Elementy układ kierowniczy

Элементы рулевой системы



3008049 Part/oe 7701469502	Axe de bielle G/D <i>L/R axial joint</i>	3008050 Part/oe 7701471885	Axe de bielle G/D <i>L/R axial joint</i>
	14 Côté dir. M12x1.0 Côté rot. M14x1.5 15 long 260 mm TT /all models DA SMI -18/09/98		14 Côté dir. M12x1.0 Côté rot. M14x1.5 15 long 257 mm TT /all models DA SMI 18/09/98-17/02/99
3008046 Part/oe 7701471844	Axe de bielle G/D <i>L/R axial joint</i>	3008109 Part/oe 7701469280	Axe de bielle G/D <i>L/R axial joint</i>
	14 Côté dir. M12x1.0 Côté rot. M14x1.5 15 long 294 mm TT /all models DA SMI 17/02/99-11/02 sauf DA0H		14 Côté dir. M14x1.5 Côté rot. M14x1.5 15 long 255 mm Dir. TRW 1.6 DA0F -17/02/99 1.9 DTi DA0N -17/02/99 2.0i DA0G -17/02/99
3008047 Part/oe 7701472087	Axe de bielle G/D <i>L/R axial joint</i>	3008051 Part/oe 7701469283	Axe de bielle G/D <i>L/R axial joint</i>
	14 Côté dir. M14x1.5 Côté rot. M14x1.5 15 long 287 mm Dir. TRW 1.4i 16v. DA0W 17/02/99-11/02 1.6 DA0F 17/02/99-11/02 1.6i 16v. DA04 17/02/99-11/02 1.9 DCi DA05 17/02/99-11/02 1.9 DTi DA0N 17/02/99-11/02 2.0i DA0G 17/02/99-11/02 2.0 IDE DA03/OP 17/02/99-11/02		14 Côté dir. M14x1.5 Côté rot. M14x1.5 15 long 263 mm 2.0i 16v. DA0H -17/02/99

... Megane I Coupé ...

Eléments DIRECTION

Steering parts

Elementos Direcciones

Elementy układ kierowniczy

Элементы рулевой системы

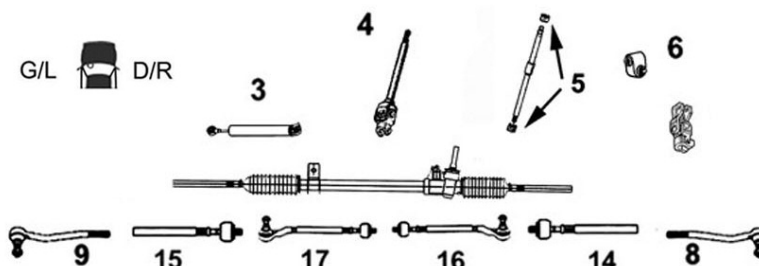

3008043

Axe de bielle G/D

Part/oe 7701472089

L/R axial joint



14
15

Côté dir. M14x1.5 Côté rot. M14x1.5 long 293 mm

2.0i 16v. DA0H 17/02/99-11/02

4006108

Rotule de direction G

OE 7701472087

Left tie rod end

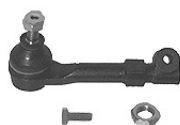

9

TT /all models
Dir. SMI Koyo TRW -17/02/99

4006109

Rotule de direction D

OE 7701041312

Right tie rod end

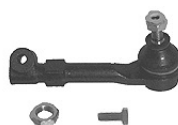

8

TT /all models
Dir. SMI Koyo TRW -17/02/99

4006134

Rotule de direction G

OE 7701474492

Left tie rod end



9

TT /all models
Dir. SMI TRW 17/02/99-11/02

4006135

Rotule de direction D

OE 7701474493

Right tie rod end



8

TT /all models
Dir. SMI TRW 17/02/99-11/02



Barre stabilisatrice

Stabilizer bar

Barra estabilizadora

Drażek stabilizatora

стабилизатор поперечной устойчивости

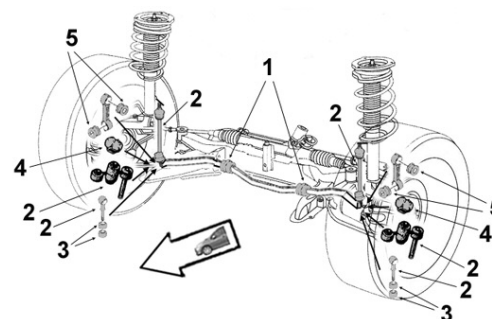

4005151

Palier de barre bout

OE 8200150759

End bar main bearing



4

1.4i 16v. DA0W
1.6i DA0F 09/07/98-

4001475

Palier de barre bout

OE 7700784170

End bar main bearing



4

Barre Ø 23

1.6i DA0F -15/01/96

... Megane I Coupé ...

4001522 OE 7700784171 	Palier de barre bout <i>End bar main bearing</i> 4 Barre Ø 24 1.6i DA0F 15/01/96-09/07/98 1.9 DTi DA0N -09/07/98 2.0i DA0G -09/07/98 2.0i 16v. DA0H	2304005 OE 8200150768 	Palier de barre bout <i>End bar main bearing</i> 4 1.6i 16v. DA04/0B/1J 1.9 DCi DA05 1.9 DTi DA0N 09/07/98- 2.0i DA0G 09/07/98- 2.0 IDE 16v. DA03
4001553 OE 7700428665 	Palier de barre milieu <i>Middle bar main bearing</i> 1 Barre Ø 23.5 1.4i 16v. DA0W 1.6i DA0F 09/07/98-	4001476 OE 7700785788 	Palier de barre milieu <i>Middle bar main bearing</i> 1 Barre Ø 23 1.6i DA0F -15/01/96
4001517 OE 7700835929 	Palier de barre milieu <i>Middle bar main bearing</i> 1 Barre Ø 24 1.6i DA0F 15/01/96-09/07/98 1.9 DTi DA0N -09/07/98 2.0i DA0G -09/07/98	4001554 OE 7700428738 	Palier de barre milieu <i>Middle bar main bearing</i> 1 Barre Ø 24.5 1.6i 16v. DA04 1.9 DCi DA05 1.9 DTi DA0N 09/07/98- 2.0i DA0G 09/07/98- 2.0 IDE 16v. DA03
4001518 OE 7700847383 	Palier de barre milieu <i>Middle bar main bearing</i> 1 Barre Ø 25 2.0i 16v. DA0H	4155410 OE - 	Kit rép. barre stab. G et D <i>L R Stabilizing bar repair kit</i> Barre Ø 23 TT /all models -11/02
4005086 OE - 	Kit rép. barre stab. G et D <i>L R Stabilizing bar repair kit</i> Barre Ø 24 TT /all models -11/02	4005070 OE - 	Kit rép. barre stab. G et D <i>L R Stabilizing bar repair kit</i> Barre Ø 25 TT /all models -11/02

RENAULT



... Megane I Coupé ...



Eléments SUSPENSION

Suspension parts

Elementos suspensión

Elementy zawieszenie

Элементы подвески

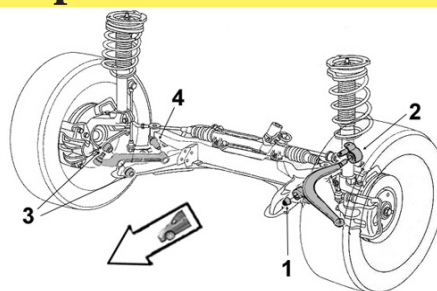

RENAULT



4001413

Articulation AV/AR

OE 8200651163

Front rear bush



1 Ø int.12 Ø ext.45
2 long. tube int.46 ext.34.5

1.4i 16v.	DA0W	
1.6	DA0F	
1.6i 16v.	DA04	
1.9 DCi	DA05	
1.9 DTi	DA0N	BVM
2.0i	DA0G	

4001529

Articulation AV/AR

OE 8200651169

Front rear bush



1 Ø int.12 Ø ext.45 long. tube int.46 ext.35
2

1.9 DTi	DA0N	BVA
2.0i 16v.	DA0C/0H/1S	
2.0 IDE 16v.	DA03	

Bras & Triangle de suspension

Control arm

Brazo y triángulo

Wahacz

Рычаг подвески

G/L  D/R



4003358

Triangle de susp. G

OE 8200737134

Left track control arm



4 Avec rotule With ball joint

1.4i 16v.	DA0W	-11/02
1.6	DA0F	-11/02
1.6i 16v.	DA04	-11/02
1.9 DCi	DA05	-11/02
1.9 DTi	DA0N	-11/02
2.0i	DA0G	-11/02

4003357

Triangle de susp. D

OE 8200737135

Right track control arm



3 Avec rotule With ball joint

1.4i 16v.	DA0W	-11/02
1.6	DA0F	-11/02
1.6i 16v.	DA04	-11/02
1.9 DCi	DA05	-11/02
1.9 DTi	DA0N	-11/02
2.0i	DA0G	-11/02

4003360

Triangle de susp. G

OE 8200737112

Left track control arm



4 Avec rotule With ball joint

1.9 DTi	DA0N	BVA	-11/02
2.0i 16v.	DA0C/0H/1S		-11/02
2.0 IDE 16v.	DA03		-11/02

4003359

Triangle de susp. D

OE 8200737114

Right track control arm



3 Avec rotule With ball joint

1.9 DTi	DA0N	BVA	-11/02
2.0i 16v.	DA0C/0H/1S		-11/02
2.0 IDE 16v.	DA03		-11/02

4005257

Rotule de susp. inf. G/D

OE 7701472038

L/R lower suspension ball joint



1 Trous fixation Ø10
2

1.4i 16v.	DA0W	-11/02
1.6	DA0F	-11/02
1.6i 16v.	DA04	-11/02
1.9 DCi	DA05	-11/02
1.9 DTi	DA0N	03/99-11/02

4005273

Rotule de susp. inf. G/D

OE 7701468411

L/R lower suspension ball joint













1 Trous fixation Ø10
2

1.9 DTi	DA0N	-03/99
2.0i	DA0G	-11/02
2.0i 16v.	DA0H	-04/07/98

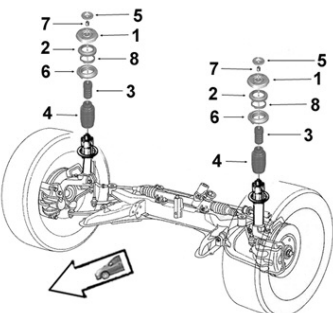
... Megane I Coupé ...

RENAULT



405A410S OE -	Kit rép. train AV <i>Front axle repair kit</i>	4055410B OE -	Kit rép. train AV complet <i>Front axle complete repair kit</i>
	Sans visserie <i>Without screws and bolts</i> Barre Ø 23 TT /all models Sauf DA0H -18/06/96		Avec visserie <i>With screws and bolts</i> Barre Ø 23 TT /all models Sauf DA0H -18/06/96
4005410 Kit rép. triangle susp. G ou D OE - <i>L or R track control arm bearing repair kit</i>			
	Avec visserie <i>With screws and bolts</i> TT /all models Sauf EA0H -11/02		
 <p>Support d'amortisseur <i>Suspension mounting</i> Soporte amortiguador Poduszka amortyzatora Опора амортизатора</p>			
4001604 OE 7700835254	Support suspension G/D <i>L/R suspension mounting</i>	4001639 OE 7700840296	Support suspension G/D <i>L/R suspension mounting</i>
	1 1.4i 16v. DA0D/0W 1.6 DA0F 1.6i 16v. DA0B/04 1.9 DCi DA05 1.9 DTi DA0N 2.0i DA0G		1 2.0i 16v. DA0C/0H/1S 2.0 IDE DA0P/03
4005301 OE 7700777654	Butée à billes G/D <i>L/R ball bearing</i>	4001609 OE 7704000661	Butée de suspension G/D <i>L/R suspension bush</i>
	2 1.4i 16v. DA0D/0W 1.6 DA0F 1.6i 16v. DA0B/04 1.9 DCi DA05 1.9 DTi DA0N 2.0i DA0G 2.0i 16v. DA0H 2.0 IDE DA0P/03		3 1.4i 16v. DA0D/0W 1.6 DA0F 1.6i 16v. DA0B/04 1.9 DCi DA05 1.9 DTi DA0N 2.0i DA0G
4005372 Protecteur amortisseur G/D OE 7700776743 <i>L/R shock absorber protector</i>			
	4 1.4i 16v. DA0D/0W 1.6 DA0F 1.6i 16v. DA04/0B 1.9 DCi DA05 1.9 DTi DA0N 2.0i DA0G		

... Megane I Coupé

Eléments TRAIN ARRIERE

Rear axle parts

Tren TRAS

Elementy zawieszenia tylnego

элементы задней оси.



RENAULT

SASIC

4003398

Articulation AR

OE 7700776733

Rear bush

Ø int.43 Ø ext.77 long. tube int.36 ext.36



TT /all models Train à tube

4005350B

Kit rép. train AR G ou D

OE -

L/R rear axle repair kit



TT /all models Train à tube -11/02

Megane II /Classic ...

Eléments DIRECTION

Steering parts

Elementos Direcciones

Elementy układu kierowniczy

Элементы рулевой системы

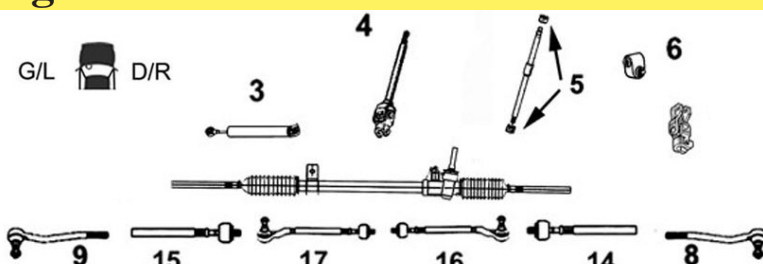

3008242

Axe de bielle G/D

Part/oe 7701474448

L/R axial joint

14 Côté dir. M14x1.5 Côté rot. M14x1.5 long 211 mm

15

1.4i 16v.	BM08/0B/0H/1A/1S/20	LM08/0B/0H	-18/02/08
1.4i 16v.	LM1A/1S/20		
1.5 DCi	BM02/0F/13/0T/16/1E/1F/2B/2A	LM02/0F/16 SM02/0F/1E/1F/16	-18/02/08
1.5 DCi	LM0T/13/1E/1F/2B/2A		
1.6i 16v.	BM0C/0J/0Y/1B/1R/1Y/2Y	LM0C/0J/2E/2F/2S	-18/02/08
1.6i 16v.	LM1B/1R/2Y		
1.9 DCi	BM00/0G/1G/14/17/1D/2C	LM00/0G/1G/17	-18/02/08
1.9 DCi	LM14/1D/2C		
2.0i 16v.	BM05/0U/0W/1M/1N/1T/1U/2P/2V	LM0U/1M/2G/23/2N	-18/02/08
2.0i 16v.	LM05/1N/1U		
2.0 DCi	BM1K		-18/02/08
2.0 DCi	LM1K		



4006161

Rotule de direction G

OE 7701474795

Left tie rod end

9



1.4i 16v.
1.5 DCi
1.6i 16v.
1.9 DCi
2.0i 16v.
2.0 DCi

4006159

Rotule de direction D

OE 7701474796

Right tie rod end

8



1.4i 16v.
1.5 DCi
1.6i 16v.
1.9 DCi
2.0i 16v.
2.0 DCi

... Megane II /Classic ...





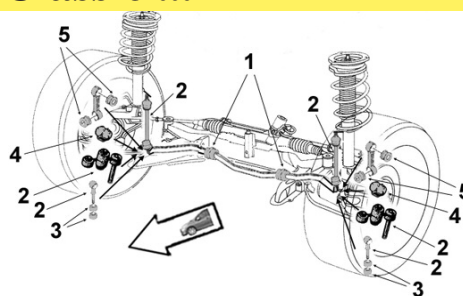

Barre stabilisatrice
 Stabilizer bar
 Barra estabilizadora
 Drażek stabilizatora
 стабилизатор поперечной устойчивости



RENAULT



4005146 OE 8200669065	Biellette barre stab. <i>Stabilizer bar stub axle</i>		
	2	1.4i 16v. 1.4i 16v. susp. normale 1.5 DCi 1.5 DCi susp. normale 1.6i 16v. 1.6i 16v. susp. normale 1.9 DCi 1.9 DCi susp. normale 2.0i 16v. 2.0i 16v. susp. normale 2.0 DCi 2.0 DCi Equip. E3P/EA1/A2/A3/A4	BM08/0B/0H BM1A LM0B/1A/08/0H SM02/0F B/LM 02/0F LM0T BM0J/0Y LM0C/0J/0Y BM0C/1B LM0C B/LM 00/1G B/LM0G BM0M/0W/11/1N LM1N BM05/0U LM05/0U B/LM1W BM1K
2304002 OE 8200669066	Biellette barre stab. <i>Stabilizer bar stub axle</i>		
	2	1.4i 16v. susp. renforcée réhaussée 1.5 DCi susp. renforcée réhaussée 1.6i 16v. susp. renforcée réhaussée 1.9 DCi susp. renforcée réhaussée 2.0i 16v. susp. renforcée réhaussée 2.0i 16v. susp. normale 2.0 DCi Equipement EAG	B/LM0B/1A BM02/0F/13 LM0F/0T/13 B/LM0C BM1B B/LM0G BM05/0U LM1M/2G/2N/2T/2V BM1K
2304006 OE 7701056096	Palier de barre milieu <i>Middle bar main bearing</i>		
	1	Ø 18.5 1.4i 16v. Susp. réhaussée 1.5 DCi Susp. réhaussée 1.5 DCi Susp. réhaussée 1.6i 16v. Susp. réhaussée 1.9 DCi Susp. réhaussée 2.0i 16v. Susp. réhaussée 2.0i 16v. Pack Extrême 2.0i 16v.	B/LM 0B/1A BM 02/0F/13/0T LM 0F/0T/13 B/LM 0C/1B B/LM0G BM 05/0U BM 0M/11 LM1M/0S/2G/23/2N
4005150 OE 7701056678	Palier de barre milieu <i>Middle bar main bearing</i>		
	1	Ø 19.5 1.4i 16v. 1.4i 16v. Susp. normale 1.5 DCi 1.5 DCi 1.5 DCi Susp. normale 1.6i 16v. Susp. normale 1.6i 16v. 1.6i 16v. / GPL 1.9 DCi 1.9 DCi Susp. normale 2.0i 16v. 2.0i 16v. Susp. normale 2.0i 16v. Sans Pack 2.0 DCi 2.0 DCi Equip. E3P EA1/A2/A3/A4	B/LM 08/0H/1S B/LM 0B/1A BM16/1E/1F LM02/16/1E/1F SM02/0F/1E/1F/16 LM 0F/0T/13 BM0C LM0C/1B LMOJ/1R BM0J/0Y/1R/1Y BM00/1G/14/17/1D LM00/1G/14/17/1D BM0G LM0G BM0W/1N/1U LM0U/1N/1U BM05/0U BM0M/11/1V BM1W LM1K BM1K

... Megane II /Classic ...



Barre stabilisatrice
 Stabilizer bar
 Barra estabilizadora
 Drażek stabilizatora
 стабилизатор поперечной устойчивости

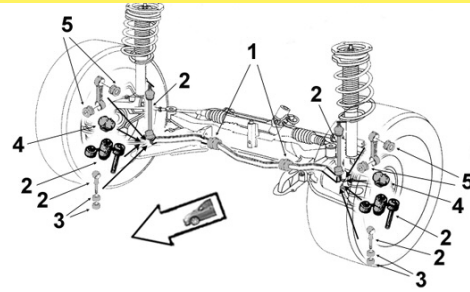

2304015 **Palier de barre milieu**
 OE 7701059672 *Middle bar main bearing*



1 Ø21
 2.0 DCi Equipement EAG BM1K



Eléments SUSPENSION
 Suspension parts
 Elementos suspensión
 Elementy zawieszenie
 Элементы подвески

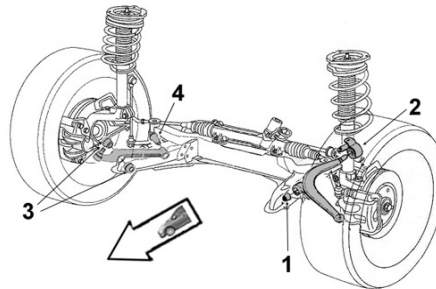

2254002 **Articulation AV**
 Part/oe 8200725673 *Front bush*



1 Ø int. 12 Ø ext. 33 coll. 43
 long. tube int. 48 ext. 33 ep. coll.4
 1.4i 16v.
 1.5 DCi
 1.6i 16v.
 1.9 DCi
 2.0i 16v.
 2.0 DCi

2254003 **Articulation AR**
 Part/oe 8200679067 *Rear bush*



2 Ø int. 12.5 Ø ext. 58
 long. tube int. 53 ext. 29.5
 1.4i 16v.
 1.5 DCi
 1.6i 16v.
 1.9 DCi
 2.0i 16v. BM05/0U/0W/1M/1N/1T/1U/2P/2V
 LM05/0U/1M/1N/0S/1U/2G/23/2N
 2.0i 16v. BM1V 28/09/06-
 2.0 DCi

Bras & Triangle de suspension

Control arm
 Brazo y triángulo
 Wahacz
 Рычаг подвески

G/L D/R



4003221 **Triangle de susp. G**
 Part/oe 8200298454 *Left track control arm*









4 **Sans rotule** *Without ball joint*
 1.4i 16v. BM08/0B/0H/1A/1S/20 08/01/03-
 1.4i 16v. LM08/0B/0H/1A/1S/20
 1.5 DCi
 1.6i 16v. BM0C/0J/0Y/1B/1R/1Y/2Y 08/01/03-
 1.6i 16v. LM0C/0J/0Y/1B/1R/2E/2F/2S/2Y
 1.9 DCi BM00/0G/1G/14/17/1D/2C 08/01/03-
 1.9 DCi LM00/0G/1G/14/17/1D/2C
 2.0i 16v. BM05/0M/0U/0W/11/1M/1N/1T/1U/1V/2P/2V
 2.0i 16v. LM05/0U/1M/1N/0S/1U/2G/23/2N
 2.0 DCi BM1K/1W LM1K

... Megane II /Classic ...

RENAULT

SASIC

4003222 Triangle de susp. D				
Part/oe 8200298455		<i>Right track control arm</i>		
	3	Sans rotule <i>Without ball joint</i>		
		1.4i 16v.	BM08/0B/0H/1A/1S/20	08/01/03-
		1.4i 16v.	LM08/0B/0H/1A/1S/20	
		1.5 DCi		
		1.6i 16v.	BM0C/0J/0Y/1B/1R/1Y/2Y	08/01/03-
		1.6i 16v.	LM0C/0J/0Y/1B/1R/2E/2F/2S/2Y	
		1.9 DCi	BM00/0G/1G/14/17/1D/2C	08/01/03-
		1.9 DCi	LM00/0G/1G/14/17/1D/2C	
		2.0i 16v.	BM05/0M/0U/0W/11/1M/1N/1T/U/1V/2P/2V	
		2.0i 16v.	LM05/0U/1M/1N/0S/1U/2G/23/2N	
	2.0 DCi	BM1K/1W LM1K		
7474021 Triangle de susp. G		7474022 Triangle de susp. D		
OE 8200725672		OE 8200725673		
<i>Left track control arm</i>		<i>Right track control arm</i>		
	4	Avec rotule <i>With ball joint</i> Ø 16		
		1.4i 16v.	BM08/0B/0H -08/01/03	
		1.5 DCi	BM0F SM0F -08/01/03	
		1.6i 16v.	BM0C/0J -08/01/03	
		1.9 DCi	BM0G/1G -08/01/03	
		2.0i 16v.	BM0U -08/01/03	
	3	Avec rotule <i>With ball joint</i> Ø 16		
		1.4i 16v.	BM08/0B/0H -08/01/03	
		1.5 DCi	BM0F SM0F -08/01/03	
		1.6i 16v.	BM0C/0J -08/01/03	
		1.9 DCi	BM0G/1G -08/01/03	
		2.0i 16v.	BM0U -08/01/03	
4005272 Rotule de susp. inf. G/D				
Part/oe 8200255760		<i>L/R lower suspension ball joint</i>		
	1	Ø 16		
	2			
		1.4i 16v.	BM08/0B/0H	-08/01/03
		1.5 DCi	BM0F SM0F	-08/01/03
		1.6i 16v.	BM0C/0J	-08/01/03
		1.9 DCi	BM0G/1G	-08/01/03
	2.0i 16v.	BM0U	-08/01/03	
4005280 Rotule de susp. inf. G/D				
Part/oe 8200346941		<i>L/R lower suspension ball joint</i>		
	1	Ø 18		
	2			
		1.4i 16v.	BM08/0B/0H	08/01/03-
		1.4i 16v.	BM1A/1S/20	
		1.5 DCi	BM0F SM0F	08/01/03-
		1.5 DCi	BM02/13/0T/16/1E/1F/2B/2A SM02/1E/1F/16	
		1.6i 16v.	BM0C/0J	08/01/03-
		1.6i 16v.	BM0Y/1B/1R/1Y/2Y	
		1.9 DCi	BM0G/1G	08/01/03-
		1.9 DCi	BM00/14/17/1D/2C	
		2.0i 16v.	BM0U	08/01/03-
		2.0i 16v.	BM05/0W/1M/1N/1T/1U/2P/2V	
		2.0 DCi	BM1K	
7964001 Kit rép. triangle susp. G et D				
OE -		<i>L or R Track control arm bearing repair kit</i>		
	Sans visserie <i>Without screws and bolts</i>			
		1.4i 16v.		
		1.5 DCi		
		1.6i 16v.		
		1.9 DCi		
		2.0i 16v.	BM05/0U/0W/1M/1N/1T/1U/2P/2V	
		2.0i 16v.	LM05/0U/1M/1N/0S/1U/2G/23/2N	
	2.0 DCi			

... Megane II /Classic ...



Support d'amortisseur
 Suspension mounting
 Soporte amortiguador
 Poduszka amortyzatora
 Опора амортизатора

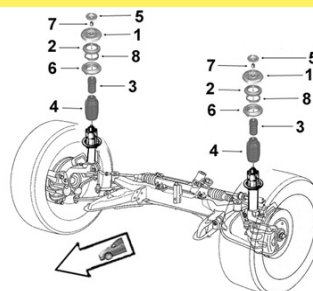

RENAULT



4001645 Support suspension G/D

OE 8200222463 L/R suspension mounting



1

1.4i 16v.	B/LM 08/0B/0H/1A
1.5 DCi	B/LM 02/0F/13 LM0T SM02/0F
1.6i 16v.	B/LM 0C/0J/0Y/1B
1.9 DCi	B/LM 00/0G/1G
2.0i 16v.	BM05/0U/0W/1M/1N
2.0i 16v.	LM05/0U/1M/1N
2.0 DCi Equip. E3P EA1/2/3/4	BM1K
2.0 DCi	LM1K

4001646 Support suspension G/D

OE 8200630328 L/R suspension mounting



1

2.0i 16v. BM0M/11
 2.0 DCi BM1W

2654012 Butée à billes G/D

OE 8200824774 L/R ball bearing



2

1.4i 16v. B/LM 08/0B/0H/1A
 1.5 DCi B/SM 00/02/0F BM13
 1.5 DCi LM02/0F/0T/13
 1.6i 16v. BM0C/0Y/1B LM0C/0J/0Y/1B
 1.9 DCi B/LM 00/0G/1G
 2.0i 16v. BM05/0M/0U/0W/1M/1N/11
 2.0i 16v. LM05/0U/1M/1N
 2.0 DCi B/LM1K BM1W

4001629 Butée protecteur susp.

OE 8200040073 Suspension bush



3

4

1.4i 16v. B/LM 08/0B/0H/1A
 1.5 DCi B/LM 02/0F/13 LM0T SM02/0F
 1.6i 16v. B/LM 0C/0J/0Y/1B
 1.9 DCi B/LM 00/0G/1G
 2.0i 16v. Sauf Pack Extrême BM0M/11
 2.0i 16v. BM05/0U/0W/1M/1N
 2.0i 16v. LM05/0U/1M/1N
 2.0 DCi BM1K/1W LM1K

2654013 Butée protecteur susp. AV

OE 8200432285 Front suspension bush



3

4

2.0i 16v. Pack Extrême BM0M/11/1V

2954002 Kit rép. suspension G ou D

OE 7701208891 L/R stabilizing bar repair kit



1.4i 16v.	B/LM08/0B/0H/1A
1.5 DCi	B/LM 02/0F/13 LM0T SM02/0F
1.6i 16v. /ETH / GPL	B/LM 0C/0J/0Y/1B
1.9 DCi /FAP	B/LM00/0G/1G
2.0i 16v.	B/LM05/0U/0W/1M/1N BM0W
2.0 DCi Equip. E3P EA1/2/3/4	BM1K
2.0 DCi	LM1K

... Megane II /Classic ...



Barre stabilisatrice
 Stabilizer bar
 Barra estabilizadora
 Drażek stabilizatora
 стабилизатор поперечной устойчивости

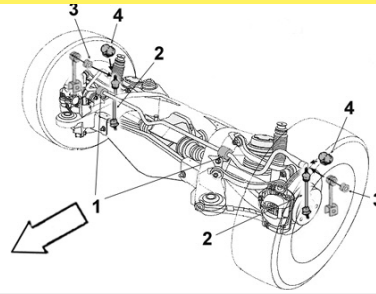

2304023 **Palier de barre milieu**
 OE 7701063888 *Middle bar main bearing*



1

2.0i 16v. Complément Pack Sport Extrême BM1V 09/11/06-
 2.0 DCi BM1W



Support d'amortisseur
 Suspension mounting
 Soporte amortiguador
 Poduszka amortyzatora
 Опора амортизатора

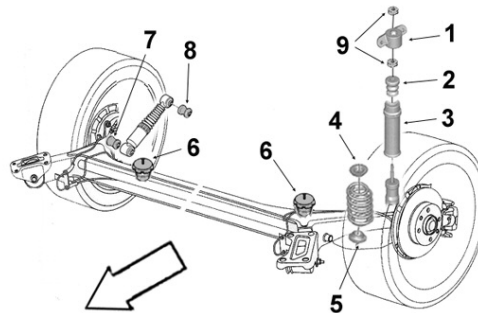

4005518 **Butoir de suspension**
 OE 8200038285 *Bushing*



4

1.4i 16v.		LM08/0B/0H/1A
1.4i 16v.	susp. renforcée réhaussée	BM0B/1A
1.5 DCi	susp. renforcée réhaussée	BM02/0F
1.5 DCi		BM13 LM02/0F/0T/13
1.6i 16v.		BM0Y LM0C/0J/0Y/1B
1.6i 16v.	susp. renforcée réhaussée	BM0C/1B
1.9 DCi		LM00/0G/1G
1.9 DCi	susp. renforcée réhaussée	BM0G
2.0i 16v.		BM0M/11/1M LM05/0U/1M/1N
2.0i 16v.	susp. renforcée réhaussée	BM05/0U

4005508 **Butée de choc AR**
 OE 8200245679 *Rear bumper buffer*



5

1.4i 16v.		B/LM 08/0B/0H/1A
1.5 DCi		B/SM 02/0F BM13
1.5 DCi		LM02/0F/0T/13
1.6i 16v.		B/LM 0C/0J/0Y/1B
1.9 DCi		B/LM 00/0G/1G
2.0i 16v.		BM05/0M/0U/0W/11/1M/1N
2.0i 16v.		LM05/0U/1M/1N

... Megane II /Classic

SASIC

RENAULT

Eléments TRAIN ARRIERE

Rear axle parts

Tren TRAS

Elementy zawieszenia tylnego

элементы задней оси.



2604006

Articulation essieu

OE 7701479190

Axle bush



Ø int.12 Ø ext.69 coll.80 long. tube int.90 ext.58.3 ep. coll. 10.3

1.4i 16v.

1.5 DCi

1.6i 16v.

1.9 DCi

2.0i 16v.

2.0i 16v. Sauf équip. EAG

2.0 DCi Sauf équip. EAG

2.0 DCi

BM05/0U/0W/1M/1N/1U/2V

LM05/0U/1M/1N/0S/1U/2G/23/2N

BM1T

BM1K

BM1W

LM1K

2604005

Articulation essieu

OE 7701479191

Axle bush



Ø int.12 Ø ext.69 coll.80 long. tube int.90 ext.58.5 ep. coll. 10.5

2.0i 16v.

2.0i 16v. Equipement EAG

2.0i 16v.

2.0 DCi Equipement EAG

BM0M/11/2P

BM1T

BM1V

BM1K

-09/11/06

Megane II Break ...

Eléments DIRECTION

Steering parts

Elementos Direcciones

Elementy uklad kierowniczy

Элементы рулевой системы

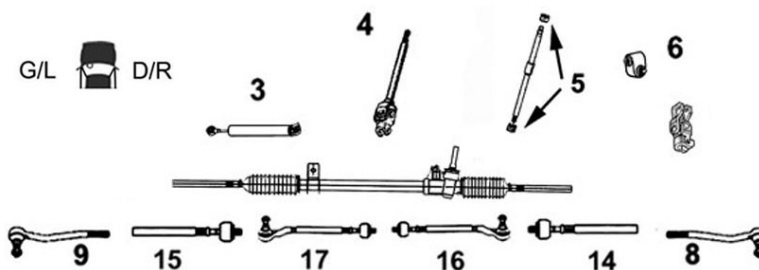

3008242

Axe de bielle G/D

Part/oe 7701474448

L/R axial joint



14 Côté dir. M14x1.5 Côté rot. M14x1.5 long 211 mm

15

1.4i 16v.

1.5 DCi

1.6i 16v.

1.9 DCi

2.0i 16v.

2.0 DCi

KM0C/0J/1B/1R/2E/2F/2K/2Y

KM0U/1N/0S/0S/1U/2G/23/2N/2V

4006161

Rotule de direction G

OE 7701474795

Left tie rod end



9

1.4i 16v.

1.5 DCi

1.6i 16v.

1.9 DCi

2.0i 16v.

2.0i 16v.

2.0 DCi

KM0C/0J/1B/1R/2E/2F/2K/2Y

KM0U/1N/0S/0S

KM1U/2G/23/2N/2V

4006159

Rotule de direction D

OE 7701474796

Right tie rod end



8

1.4i 16v.

1.5 DCi

1.6i 16v.

1.9 DCi

2.0i 16v.

2.0i 16v.

2.0 DCi

KM0C/0J/1B/1R/2E/2F/2K/2Y

KM0U/1N/0S/0S

KM1U/2G/23/2N/2V

... Megane II Break ...



Barre stabilisatrice
 Stabilizer bar
 Barra estabilizadora
 Drażek stabilizatora
 стабилизатор поперечной устойчивости

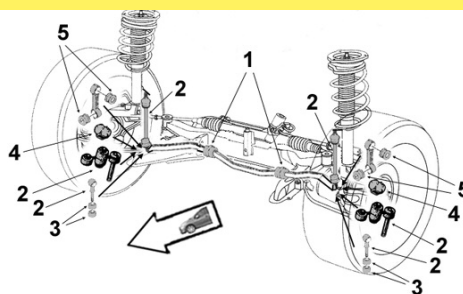

RENAULT



4005146 OE 8200669065	Biellette barre stab. <i>Stabilizer bar stub axle</i>	2304002 OE 8200669066	Biellette barre stab. <i>Stabilizer bar stub axle</i>
	2 1.4i 16v. KM0B/0H/1S 1.5 DCi KM02/13/16/1E/1F 1.5 DCi susp. normale KM0F 1.6i 16v. KM0C/0J/1R/2K 1.6i 16v. susp. normale KM1B 1.9 DCi KM00/0G/1G/14/17/1D 2.0i 16v. KM0U/1N/05/1U 2.0 DCi KM1K		2 1.5 DCi KM0T 1.5 DCi susp. renf. réhaussée KM0F
2304006 OE 7701056096	Palier de barre milieu <i>Middle bar main bearing</i>	4005150 OE 7701056678	Palier de barre milieu <i>Middle bar main bearing</i>
	1 Ø 18.5 1.5 DCi KM0F/0T		1 Ø 19.5 1.4i 16v. KM0B 1.5 DCi KM02/16/1E/1F 1.5 DCi Susp. normale KM0F/13 1.6i 16v. KM0C 1.9 DCi KM0G 2.0i 16v. KM0U 2.0 DCi KM1K



Eléments SUSPENSION
 Suspension parts
 Elementos suspensión
 Elementy zawieszenie
 Элементы подвески

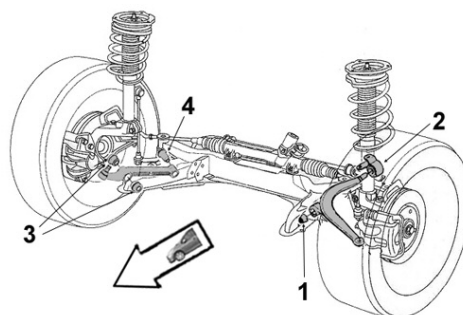

2254002 Part/oe 8200725673	Articulation AV <i>Front bush</i>	2254003 Part/oe 8200679067	Articulation AR <i>Rear bush</i>
	1 Ø int. 12 Ø ext. 33 coll. 43 long. tube int. 48 ext. 33 ep. coll.4 1.4i 16v. 1.5 DCi 1.6i 16v. 1.9 DCi 2.0i 16v. 2.0 DCi		2 Ø int. 12.5 Ø ext. 58 long. tube int. 53 ext. 29.5 1.4i 16v. 1.5 DCi 1.6i 16v. 1.9 DCi 2.0i 16v. 2.0 DCi

... Megane II Break ...

SASIC

RENAULT

Bras & Triangle de suspension

Control arm
Brazo y triángulo
Wahacz
Рычаг подвески

G/L  D/R



4003221

Triangle de susp. G

Part/oe 8200298454

Left track control arm



4 Sans rotule *Without ball joint*

1.4i 16v.
1.5 DCi
1.6i 16v.
1.9 DCi
2.0i 16v.
2.0 DCi

4003222

Triangle de susp. D

Part/oe 8200298455

Right track control arm



3 Sans rotule *Without ball joint*

1.4i 16v.
1.5 DCi
1.6i 16v.
1.9 DCi
2.0i 16v.
2.0 DCi

4005280

Rotule de susp. inf. G/D

Part/oe 8200346941

L/R lower suspension ball joint



1
2 Ø 18

1.4i 16v.
1.5 DCi
1.6i 16v.
1.9 DCi
2.0i 16v.
2.0 DCi

7964001

Kit rép. triangle susp. G et D

OE -

L or R Track control arm bearing repair kit



Sans visserie *Without screws and bolts*

1.4i 16v.
1.5 DCi
1.6i 16v.
1.9 DCi
2.0i 16v.
2.0 DCi



Support d'amortisseur

Suspension mounting
Soporte amortiguador
Poduszka amortyzatora
Опора амортизатора

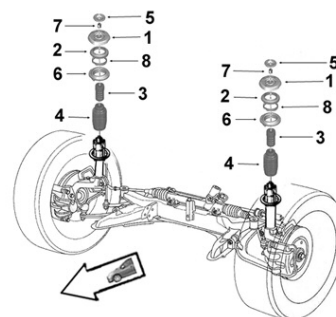

4001645

Support suspension G/D

OE 8200222463

L/R suspension mounting



1

1.4i 16v. KM0B/0H/1A
1.5 DCi KM02/0F
1.6i 16v. KM0C/0J/0Y/1B
1.9 DCi KM00/0G/1G
2.0i 16v. KM0U/1M/1N
2.0 DCi KM1K

2654012

Butée à billes G/D

OE 8200824774

L/R ball bearing



2

1.4i 16v. KM0B
1.5 DCi KM00/02/0F
1.6i 16v. KM0C/0Y/1B
1.9 DCi KM0G
2.0i 16v. KM0U
2.0 DCi KM1K

4001629

Butée protecteur susp.

OE 8200040073

Suspension bush



3
4

1.4i 16v. KM0B/0H/1A
1.5 DCi KM02/0F
1.6i 16v. KM0C/0J/0Y/1B
1.9 DCi KM00/0G/1G
2.0i 16v. KM0U/1M/1N
2.0 DCi KM1K

2954002

Kit rép. suspension G ou D

OE 7701208891

L/R stabilizing bar repair kit



1.4i 16v. KM0B/0H/1A
1.5 DCi KM02/0F
1.6i 16v. KM0C/0J/0Y/1B
1.9 DCi KM00/0G/1G
2.0i 16v. KM0U/1M/1N
2.0 DCi KM1K

... Megane II Break



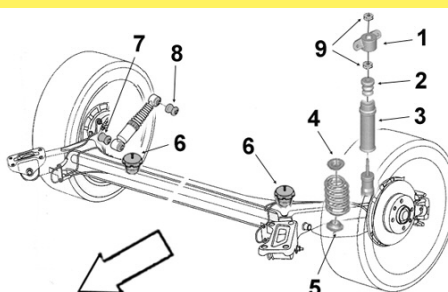

Support d'amortisseur
Suspension mounting
Soporte amortiguador
Poduszka amortyzatora
Опора амортизатора



RENAULT



4005517 OE 8200038284	Butoir de suspension <i>Bushing</i>	4005518 OE 8200038285	Butoir de suspension <i>Bushing</i>
	4 1.4i 16v. KM0B/0H 1.5 DCi susp. normale KM02/0F 1.6i 16v. KM0C/0Y 1.6i 16v. susp. normale KM0J/1B 1.9 DCi KM00/1G 1.9 DCi susp. normale KM0G 2.0i 16v. KM1N 2.0i 16v. susp. normale KM0U		4 1.5 DCi KM02 1.5 DCi susp. renf. réhaussée KM0F 1.6i 16v. susp. renf. réhaussée KM0J/1B 1.6i 16v. KM0C 1.9 DCi susp. renf. réhaussée KM0G 2.0i 16v. susp. renf. réhaussée KM0U 2.0i 16v. KM1M

4005508 OE 8200245679	Butée de choc AR <i>Rear bumper buffer</i>
	5 1.4i 16v. KM0B/0H/1A 1.5 DCi KM02/0F 1.6i 16v. KM0C/0J/0Y/1B 1.9 DCi KM00/0G/1G 2.0i 16v. KM0U/1M/1N

Eléments TRAIN ARRIERE <i>Rear axle parts</i> <i>Tren TRAS</i> <i>Elementy zawieszenia tylnego</i> <i>элементы задней оси.</i>		2604006 OE 7701479190	Articulation essieu <i>Axle bush</i>
			Ø int.12 Ø ext.69 coll.80 long. tube int.90 ext.58.3 ep. coll. 10.3 TT /all models

Megane II Cab. CC ...

Eléments DIRECTION
Steering parts
Elementos Direcciones
Elementy uklad kierowniczy
Элементы рулевой системы

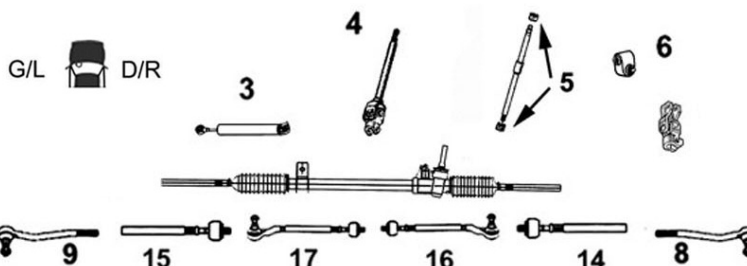

3008242 Part/oe 7701474448	Axe de bielle G/D <i>L/R axial joint</i>
	14 Côté dir. M14x1.5 Côté rot. M14x1.5 long 211 mm 15 1.5 DCi 1.6i 16v. 1.9 DCi 2.0i 16v. 2.0 DCi

... Megane II Cab. CC ...

Eléments DIRECTION
Steering parts
Elementos Direcciones
Elementy układ kierowniczy
Элементы рулевой системы

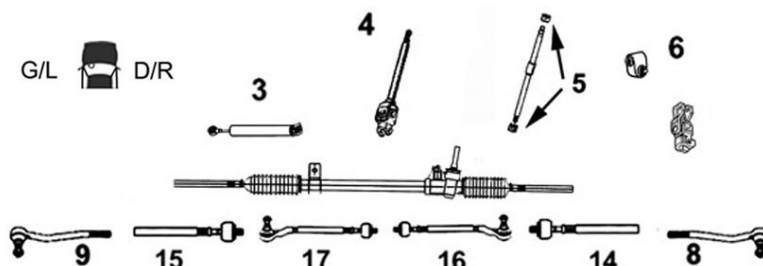

4006161 **Rotule de direction G**
 OE 7701474795 *Left tie rod end*



9
 1.5 DCi
 1.6i 16v.
 1.9 DCi
 2.0i 16v.
 2.0 DCi

4006159 **Rotule de direction D**
 OE 7701474796 *Right tie rod end*



8
 1.5 DCi
 1.6i 16v.
 1.9 DCi
 2.0i 16v.
 2.0 DCi



Barre stabilisatrice
Stabilizer bar
Barra estabilizadora
Drążek stabilizatora
стабилизатор поперечной устойчивости

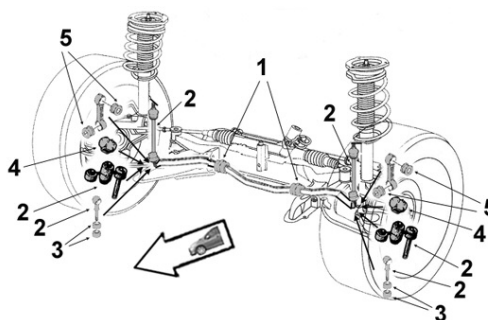

4005146 **Biellette barre stab.**
 OE 8200669065 *Stabilizer bar stub axle*



2
 1.5 DCi
 1.6i 16v.
 1.9 DCi
 2.0i 16v.
 2.0 DCi

4005150 **Palier de barre milieu**
 OE 7701056678 *Middle bar main bearing*



1 Ø 19.5
 1.5 DCi
 1.6i 16v. EM0C/OJ
 1.9 DCi EM0G
 2.0i 16v. EM05/0U/0W/1N
 2.0 DCi



Eléments SUSPENSION
Suspension parts
Elementos suspensión
Elementy zawieszenie
Элементы подвески

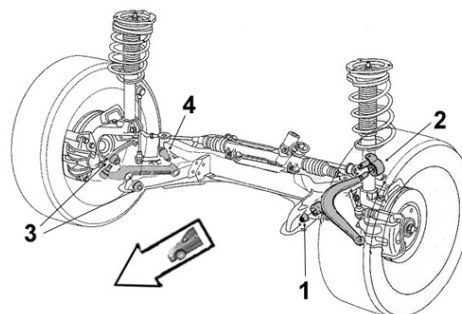

2254002 **Articulation AV**
 Part/oe 8200725673 *Front bush*



1 Ø int. 12 Ø ext. 33 coll. 43
 long. tube int. 48 ext. 33 ep. coll.4
 1.5 DCi
 1.6i 16v.
 1.9 DCi
 2.0i 16v.
 2.0 DCi

2254003 **Articulation AR**
 Part/oe 8200679067 *Rear bush*



2 Ø int. 12.5 Ø ext. 58
 long. tube int. 53 ext. 29.5
 1.6i 16v.
 1.9 DCi
 2.0i 16v.
 2.0 DCi

... Megane II Cab. CC ...

Bras & Triangle de suspension

Control arm
Brazo y triángulo
Wahacz
Рычаг подвески

G/L  D/R



RENAULT



4003221

Triangle de susp. G

Part/oe 8200298454

Left track control arm

4 Sans rotule *Without ball joint*



1.5 DCi
1.6i 16v.
1.9 DCi
2.0i 16v.
2.0 DCi

4003222

Triangle de susp. D

Part/oe 8200298455

Right track control arm

3 Sans rotule *Without ball joint*



1.5 DCi
1.6i 16v.
1.9 DCi
2.0i 16v.
2.0 DCi

4005280

Rotule de susp. inf. G/D

Part/oe 8200346941

L/R lower suspension ball joint

1 Ø 18
2



1.5 DCi
1.6i 16v.
1.9 DCi
2.0i 16v.
2.0 DCi

7964001

Kit rép. triangle susp. G et D

OE -

L or R Track control arm bearing repair kit

Sans visserie *Without screws and bolts*



1.5 DCi
1.6i 16v.
1.9 DCi
2.0i 16v.
2.0 DCi



Support d'amortisseur

Suspension mounting
Soporte amortiguador
Poduszka amortyzatora
Опора амортизатора

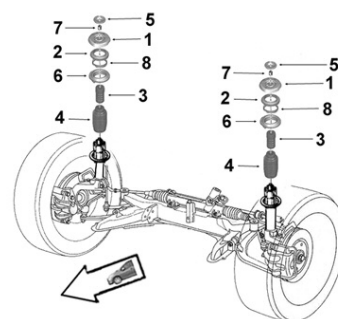

4001645

Support suspension G/D

OE 8200222463

L/R suspension mounting

1



1.5 DCi
1.6i 16v.
1.9 DCi
2.0i 16v.
2.0 DCi

2654012

Butée à billes G/D

OE 8200824774

L/R ball bearing

2



1.6i 16v. EM0C/OJ
1.9 DCi EM0G/1G
2.0i 16v. EM05/0U/0W/1M/1N
2.0 DCi

4001629

Butée protecteur susp.

OE 8200040073

Suspension bush

3
4



1.5 DCi
1.6i 16v.
1.9 DCi
2.0i 16v.
2.0 DCi

2954002

Kit rép. suspension G ou D

OE 7701208891

L/R stabilizing bar repair kit



1.6i 16v. EM0C/OJ
1.9 DCi EM0G/1G
2.0i 16v. EM05/0U/0W/1N
2.0 DCi

... Megane II Cab. CC



Support d'amortisseur
 Suspension mounting
 Soporte amortiguador
 Poduszka amortyzatora
 Опора амортизатора

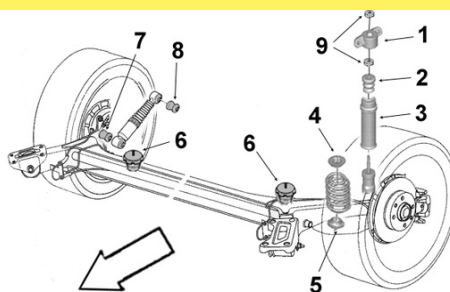

4005508

Butée de choc AR

OE 8200245679

Rear bumper buffer



5

1.6i 16v.
 1.9 DCi
 2.0i 16v.

EM0C/0J
 EM0G/1G
 EM05/0U/0W/1N

Eléments TRAIN ARRIERE

Rear axle parts

Tren TRAS

Elementy zawieszenia tylnego

элементы задней оси.



2604006

Articulation essieu

OE 7701479190

Axle bush



Ø int.12 Ø ext.69 coll.80
 long. tube int.90 ext.58.3 ep. coll. 10.3

TT /all models

Megane II Coupé ...

Eléments DIRECTION

Steering parts

Elementos Direcciones

Elementy układ kierowniczy

Элементы рулевой системы

G/L D/R

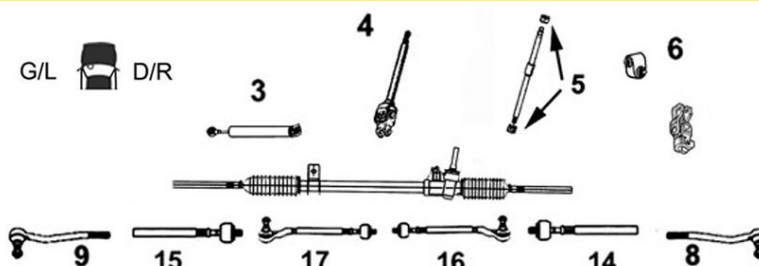

3008242

Axe de bielle G/D

Part/oe 7701474448

L/R axial joint



14 Côté dir. M14x1.5 Côté rot. M14x1.5 long 211 mm

15

1.4i 16v.
 1.5 DCi
 1.6i 16v.
 1.9 DCi
 2.0i 16v.
 2.0 DCi

CM05/0U/0W/1M/1N/1T/1U/2P/2R/2V
 CM1K

4006161

Rotule de direction G

OE 7701474795

Left tie rod end



9

1.4i 16v.
 1.5 DCi
 1.6i 16v.
 1.9 DCi
 2.0i 16v.
 2.0 DCi

4006159

Rotule de direction D

OE 7701474796

Right tie rod end



8

1.4i 16v.
 1.5 DCi
 1.6i 16v.
 1.9 DCi
 2.0i 16v.
 2.0 DCi

... Megane II Coupé ...



Barre stabilisatrice
Stabilizer bar
Barra estabilizadora
Drażek stabilizatora
 стабилизатор поперечной устойчивости

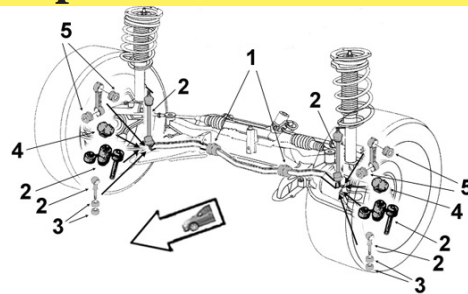

RENAULT



4005146 **Biellette barre stab.**
 OE 8200669065 *Stabilizer bar stub axle*



2 1.4i 16v. CM08/0B/0H/1S
 1.5 DCi C/GM 02/0F/1E/1F/16
 1.6i 16v. CM0C/0J/0Y/1R/1Y
 1.6i 16v. susp. normale CM1B
 1.9 DCi CM00/0G/1G/14/17/1D
 2.0i 16v. CM0M/0U/0W/11/1L/1N/1U/1V/2H/2J
 2.0i 16v. susp. normale CM05
 2.0i 16v. Equip. E3P/EA1/A2/A3/A4 CM1T/1K
 2.0 DCi CM1W

2304002 **Biellette barre stab.**
 OE 8200669066 *Stabilizer bar stub axle*

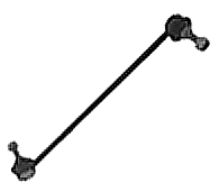

2 1.6i 16v. susp. renf. réhaussée CM1B
 2.0i 16v. susp. renf. réhaussée CM05
 2.0 DCi Equipement EAG CM1K

4005150 **Palier de barre milieu**
 OE 7701056678 *Middle bar main bearing*



1 **Ø 19.5**
 1.4i 16v. CM08/0B/0H
 1.5 DCi CM02/0F/16/1E/1F
 1.6i 16v. / GPL CM0C/0J/0Y/1R/1Y
 1.9 DCi CM00/0G/1G/14/17/1D
 2.0i 16v. /Turbo CM0U/0W/1L/1N/1U
 2.0i 16v. /Turbo Sans Pack Equip.
 SAN 913 SPT TEAM CM0M
 2.0 DCi CM1W
 2.0 DCi Equip. E3P EA1/A2/A3/A4 CM1K

2304006 **Palier de barre milieu**
 OE 7701056096 *Middle bar main bearing*



1 **Ø 18.5**
 2.0i Turbo 16V RS Pack Extrême
 Equip. SAN 913 SPT TEAM CM0M

2304015 **Palier de barre milieu**
 OE 7701059672 *Middle bar main bearing*



1 **Ø 21**
 2.0 DCi Equipement EAG CM1K



Eléments SUSPENSION
Suspension parts
Elementos suspensión
Elementy zawieszenie
 Элементы подвески

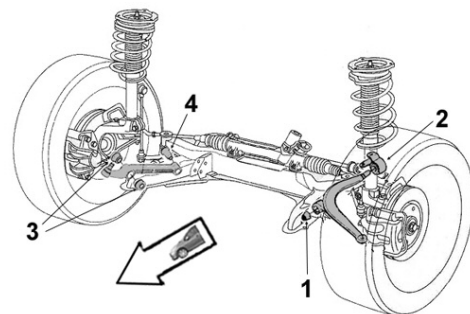

2254002 **Articulation AV**
 Part/oe 8200725673 *Front bush*



1 **Ø int. 12 Ø ext. 33 coll. 43**
long. tube int. 48 ext. 33 ep. coll.4
 1.4i 16v.
 1.5 DCi
 1.6i 16v.
 1.9 DCi
 2.0i 16v.
 2.0 DCi

2254003 **Articulation AR**
 Part/oe 8200679067 *Rear bush*



2 **Ø int. 12.5 Ø ext. 58 long. tube int. 53 ext. 29.5**
 1.4i 16v.
 1.5 DCi
 1.6i 16v.
 1.9 DCi
 2.0i 16v. CM11/1L/1V 28/09/06-
 2.0i 16v. CM05/0U/0W/1M/1N/1T/1U
 CM2H/2J/2P/2R/2V
 2.0 DCi

... Megane II Coupé ...

SASIC

RENAULT

Bras & Triangle de suspension

Control arm
Brazo y triángulo
Wahacz
Рычаг подвески

G/L  D/R



<p>7474021 OE 8200725672</p> <p>NEW</p> 	<p>Triangle de susp. G <i>Left track control arm</i></p> <p>4 Avec rotule With ball joint Ø 16</p> <table border="0"> <tr><td>1.4i 16v.</td><td>CM08/0B/0H</td><td>-08/01/03</td></tr> <tr><td>1.5 DCi</td><td>CM0F</td><td>-08/01/03</td></tr> <tr><td>1.6i 16v.</td><td>CM0C/0J</td><td>-08/01/03</td></tr> <tr><td>1.9 DCi</td><td>CM0G/1G</td><td>-08/01/03</td></tr> <tr><td>2.0i 16v.</td><td>CM0U</td><td>-08/01/03</td></tr> </table>	1.4i 16v.	CM08/0B/0H	-08/01/03	1.5 DCi	CM0F	-08/01/03	1.6i 16v.	CM0C/0J	-08/01/03	1.9 DCi	CM0G/1G	-08/01/03	2.0i 16v.	CM0U	-08/01/03	<p>7474022 OE 8200725673</p> <p>NEW</p> 	<p>Triangle de susp. D <i>Right track control arm</i></p> <p>3 Avec rotule With ball joint Ø 16</p> <table border="0"> <tr><td>1.4i 16v.</td><td>CM08/0B/0H</td><td>-08/01/03</td></tr> <tr><td>1.5 DCi</td><td>CM0F</td><td>-08/01/03</td></tr> <tr><td>1.6i 16v.</td><td>CM0C/0J</td><td>-08/01/03</td></tr> <tr><td>1.9 DCi</td><td>CM0G/1G</td><td>-08/01/03</td></tr> <tr><td>2.0i 16v.</td><td>CM0U</td><td>-08/01/03</td></tr> </table>	1.4i 16v.	CM08/0B/0H	-08/01/03	1.5 DCi	CM0F	-08/01/03	1.6i 16v.	CM0C/0J	-08/01/03	1.9 DCi	CM0G/1G	-08/01/03	2.0i 16v.	CM0U	-08/01/03																		
1.4i 16v.	CM08/0B/0H	-08/01/03																																																	
1.5 DCi	CM0F	-08/01/03																																																	
1.6i 16v.	CM0C/0J	-08/01/03																																																	
1.9 DCi	CM0G/1G	-08/01/03																																																	
2.0i 16v.	CM0U	-08/01/03																																																	
1.4i 16v.	CM08/0B/0H	-08/01/03																																																	
1.5 DCi	CM0F	-08/01/03																																																	
1.6i 16v.	CM0C/0J	-08/01/03																																																	
1.9 DCi	CM0G/1G	-08/01/03																																																	
2.0i 16v.	CM0U	-08/01/03																																																	
<p>4003221 Part/oe 8200298454</p> 	<p>Triangle de susp. G <i>Left track control arm</i></p> <p>4 Sans rotule Without ball joint</p> <table border="0"> <tr><td>1.4i 16v.</td><td></td><td>08/01/03-</td></tr> <tr><td>1.5 DCi</td><td>CM-</td><td>08/01/03-</td></tr> <tr><td>1.5 DCi</td><td>GM-</td><td></td></tr> <tr><td>1.6i 16v.</td><td></td><td>08/01/03-</td></tr> <tr><td>1.9 DCi</td><td></td><td>08/01/03-</td></tr> <tr><td>2.0i 16v.</td><td>CM05/0M/0U/0W/11/1L/1M/1N</td><td>08/01/03-</td></tr> <tr><td>2.0i 16v.</td><td>CM1T/1U/1V/2H/2J/2P/2R/2V</td><td>18/09/06-</td></tr> <tr><td>2.0 DCi</td><td></td><td></td></tr> </table>	1.4i 16v.		08/01/03-	1.5 DCi	CM-	08/01/03-	1.5 DCi	GM-		1.6i 16v.		08/01/03-	1.9 DCi		08/01/03-	2.0i 16v.	CM05/0M/0U/0W/11/1L/1M/1N	08/01/03-	2.0i 16v.	CM1T/1U/1V/2H/2J/2P/2R/2V	18/09/06-	2.0 DCi			<p>4003222 Part/oe 8200298455</p> 	<p>Triangle de susp. D <i>Right track control arm</i></p> <p>3 Sans rotule Without ball joint</p> <table border="0"> <tr><td>1.4i 16v.</td><td></td><td>08/01/03-</td></tr> <tr><td>1.5 DCi</td><td>CM-</td><td>08/01/03-</td></tr> <tr><td>1.5 DCi</td><td>GM-</td><td></td></tr> <tr><td>1.6i 16v.</td><td></td><td>08/01/03-</td></tr> <tr><td>1.9 DCi</td><td></td><td>08/01/03-</td></tr> <tr><td>2.0i 16v.</td><td>CM05/0M/0U/0W/11/1L/1M/1N</td><td>08/01/03-</td></tr> <tr><td>2.0i 16v.</td><td>CM1T/1U/1V/2H/2J/2P/2R/2V</td><td>18/09/06-</td></tr> <tr><td>2.0 DCi</td><td></td><td></td></tr> </table>	1.4i 16v.		08/01/03-	1.5 DCi	CM-	08/01/03-	1.5 DCi	GM-		1.6i 16v.		08/01/03-	1.9 DCi		08/01/03-	2.0i 16v.	CM05/0M/0U/0W/11/1L/1M/1N	08/01/03-	2.0i 16v.	CM1T/1U/1V/2H/2J/2P/2R/2V	18/09/06-	2.0 DCi		
1.4i 16v.		08/01/03-																																																	
1.5 DCi	CM-	08/01/03-																																																	
1.5 DCi	GM-																																																		
1.6i 16v.		08/01/03-																																																	
1.9 DCi		08/01/03-																																																	
2.0i 16v.	CM05/0M/0U/0W/11/1L/1M/1N	08/01/03-																																																	
2.0i 16v.	CM1T/1U/1V/2H/2J/2P/2R/2V	18/09/06-																																																	
2.0 DCi																																																			
1.4i 16v.		08/01/03-																																																	
1.5 DCi	CM-	08/01/03-																																																	
1.5 DCi	GM-																																																		
1.6i 16v.		08/01/03-																																																	
1.9 DCi		08/01/03-																																																	
2.0i 16v.	CM05/0M/0U/0W/11/1L/1M/1N	08/01/03-																																																	
2.0i 16v.	CM1T/1U/1V/2H/2J/2P/2R/2V	18/09/06-																																																	
2.0 DCi																																																			
<p>4005272 Part/oe 8200255760</p> 	<p>Rotule de susp. inf. G/D <i>L/R lower suspension ball joint</i></p> <p>1 Ø 16</p> <table border="0"> <tr><td>1.4i 16v.</td><td>CM08/0B/0H</td><td>-08/01/03</td></tr> <tr><td>1.5 DCi</td><td>CM0F</td><td>-08/01/03</td></tr> <tr><td>1.6i 16v.</td><td>CM0C/0J</td><td>-08/01/03</td></tr> <tr><td>1.9 DCi</td><td>CM0G/1G</td><td>-08/01/03</td></tr> <tr><td>2.0i 16v.</td><td>CM0U</td><td>-08/01/03</td></tr> </table>			1.4i 16v.	CM08/0B/0H	-08/01/03	1.5 DCi	CM0F	-08/01/03	1.6i 16v.	CM0C/0J	-08/01/03	1.9 DCi	CM0G/1G	-08/01/03	2.0i 16v.	CM0U	-08/01/03																																	
1.4i 16v.	CM08/0B/0H	-08/01/03																																																	
1.5 DCi	CM0F	-08/01/03																																																	
1.6i 16v.	CM0C/0J	-08/01/03																																																	
1.9 DCi	CM0G/1G	-08/01/03																																																	
2.0i 16v.	CM0U	-08/01/03																																																	
<p>4005280 Part/oe 8200346941</p> 	<p>Rotule de susp. inf. G/D <i>L/R lower suspension ball joint</i></p> <p>1 Ø 18</p> <table border="0"> <tr><td>1.4i 16v.</td><td>CM08/0B/0H</td><td>08/01/03-</td></tr> <tr><td>1.4i 16v.</td><td>CM1S/20</td><td></td></tr> <tr><td>1.5 DCi</td><td>CM0F</td><td>08/01/03-</td></tr> <tr><td>1.5 DCi</td><td>CM02/16/1E/1F/0T/13</td><td>GM02/0F/1E/1F/16</td></tr> <tr><td>1.6i 16v.</td><td>CM0C/0J</td><td>08/01/03-</td></tr> <tr><td>1.6i 16v.</td><td>CM0Y/1B/1R/1Y/2Y</td><td></td></tr> <tr><td>1.9 DCi</td><td>CM0G/1G</td><td>08/01/03-</td></tr> <tr><td>1.9 DCi</td><td>CM00/14/17/1D</td><td></td></tr> <tr><td>2.0i 16v.</td><td>CM0U</td><td>08/01/03-</td></tr> <tr><td>2.0i 16v.</td><td>CM05/0W/1M/1N/1T/1U/2P/2R/2V</td><td></td></tr> <tr><td>2.0 DCi</td><td>CM1K</td><td></td></tr> </table>			1.4i 16v.	CM08/0B/0H	08/01/03-	1.4i 16v.	CM1S/20		1.5 DCi	CM0F	08/01/03-	1.5 DCi	CM02/16/1E/1F/0T/13	GM02/0F/1E/1F/16	1.6i 16v.	CM0C/0J	08/01/03-	1.6i 16v.	CM0Y/1B/1R/1Y/2Y		1.9 DCi	CM0G/1G	08/01/03-	1.9 DCi	CM00/14/17/1D		2.0i 16v.	CM0U	08/01/03-	2.0i 16v.	CM05/0W/1M/1N/1T/1U/2P/2R/2V		2.0 DCi	CM1K																
1.4i 16v.	CM08/0B/0H	08/01/03-																																																	
1.4i 16v.	CM1S/20																																																		
1.5 DCi	CM0F	08/01/03-																																																	
1.5 DCi	CM02/16/1E/1F/0T/13	GM02/0F/1E/1F/16																																																	
1.6i 16v.	CM0C/0J	08/01/03-																																																	
1.6i 16v.	CM0Y/1B/1R/1Y/2Y																																																		
1.9 DCi	CM0G/1G	08/01/03-																																																	
1.9 DCi	CM00/14/17/1D																																																		
2.0i 16v.	CM0U	08/01/03-																																																	
2.0i 16v.	CM05/0W/1M/1N/1T/1U/2P/2R/2V																																																		
2.0 DCi	CM1K																																																		
<p>7964001 OE -</p> 	<p>Kit rép. triangle susp. G et D <i>L or R Track control arm bearing repair kit</i></p> <p>Sans visserie Without screws and bolts</p> <table border="0"> <tr><td>1.4i 16v.</td><td></td><td></td></tr> <tr><td>1.5 DCi</td><td></td><td></td></tr> <tr><td>1.6i 16v.</td><td></td><td></td></tr> <tr><td>1.9 DCi</td><td></td><td></td></tr> <tr><td>2.0i 16v.</td><td>CM05/0U/0W/1M/1N/1T/1U/2P/2R/2V</td><td></td></tr> <tr><td>2.0 DCi</td><td></td><td></td></tr> </table>			1.4i 16v.			1.5 DCi			1.6i 16v.			1.9 DCi			2.0i 16v.	CM05/0U/0W/1M/1N/1T/1U/2P/2R/2V		2.0 DCi																																
1.4i 16v.																																																			
1.5 DCi																																																			
1.6i 16v.																																																			
1.9 DCi																																																			
2.0i 16v.	CM05/0U/0W/1M/1N/1T/1U/2P/2R/2V																																																		
2.0 DCi																																																			

... Megane II Coupé ...





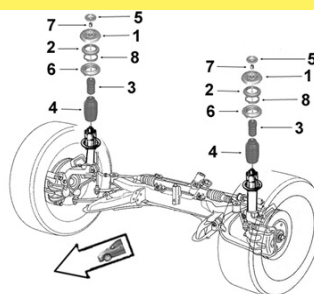





Support d'amortisseur
 Suspension mounting
 Soporte amortiguador
 Poduszka amortyzatora
 Опора амортизатора



RENAULT

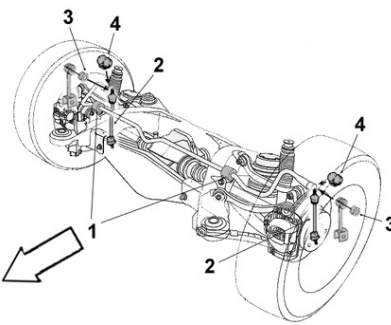

4001645 OE 8200222463	Support suspension G/D <i>L/R suspension mounting</i>	4001646 OE 8200630328	Support suspension G/D <i>L/R suspension mounting</i>
	1 1.4i 16v. CM08/0B/0H 1.5 DCi C/GM 02/0F 1.6i 16v. CM0C/0J/0Y/1B 1.9 DCi CM00/0G/1G 2.0i 16v. CM05/0U/0W/1M/1N 2.0 DCi Equip.E3P EA1/2/3/4 CM1K		1 2.0i 16v. CM0M/11/1L 2.0 DCi CM1W
2654012 OE 8200824774	Butée à billes G/D <i>L/R ball bearing</i>	4001629 OE 8200040073	Butée protecteur susp. <i>Suspension bush</i>
	2 1.4i 16v. CM08/0B/0H 1.5 DCi CM00/02 1.6i 16v. CM0C/0J/0Y/1B 1.9 DCi CM00/0G/1G 2.0i 16v. CM05/M/U/W/1M/N/L 11 2.0 DCi CM1K/1W		3 4 1.4i 16v. CM08/0B/0H 1.5 DCi C/GM 02/0F 1.6i 16v. CM0C/0J/0Y/1B 1.9 DCi CM00/0G/1G 2.0i 16v. Sauf Pack Extrême / Equip. TEAM CM0M/11 2.0i 16v. CM05/0U/0W/1L/1M/1N 2.0 DCi CM1K/1W
2654013 OE 8200432285	Butée protecteur susp. AV <i>Front suspension bush</i>	2954002 OE 7701208891	Kit rép. suspension G ou D <i>L/R stabilizing bar repair kit</i>
	3 4 2.0i 16v. Pack Extrême / Equip. TEAM CM0M/11/1V 2.0i 16v. CM2H/2J		1.4i 16v. CM08/0B/0H 1.5 DCi /FAP C/GM 02/0F 1.6i 16v. / GPL CM0C/0J/0Y/1B 1.9 DCi /FAP CM00/0G/1G 2.0i 16v. CM05/0U/0W/1M/1N 2.0 DCi Equip. E3P EA1/2/3/4 CM1K
	Barre stabilisatrice Stabilizer bar Barra estabilizadora Drażek stabilizatora стабилизатор поперечной устойчивости		
2304023 OE 7701063888	Palier de barre milieu <i>Middle bar main bearing</i>	4005518 OE 8200038285	Butoir de suspension <i>Bushing</i>
	1 2.0i 16v. CM2H/2J 2.0i 16v. Complément Pack Sport Extrême CM11 09/11/06- 2.0 DCi CM1W		4 1.6i 16v. CM0Y 1.6i 16v. susp. renf. réhaussée CM0C/1B 2.0i 16v. CM0M/11/1L/1M 2.0i 16v. susp. renf. réhaussée CM05/0U

... Megane II Coupé

SASIC

RENAULT



Support d'amortisseur
Suspension mounting
Soporte amortiguador
Poduszka amortyzatora
Опора амортизатора

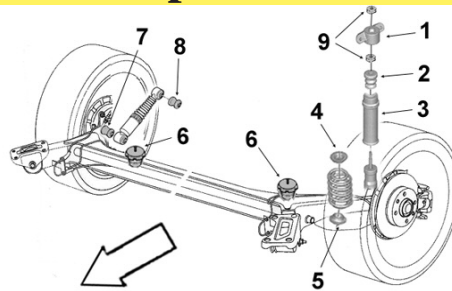

4005508

Butée de choc AR

OE 8200245679

Rear bumper buffer



5

1.4i 16v.
1.5 DCi
1.6i 16v.
1.9 DCi
2.0i 16v.

CM08/0B/0H
C/GM 02/0F
CM0C/0J/0Y/1B
CM00/0G/1G
CM05/0M/0U/0W/11/1L/1M/1N

Eléments TRAIN ARRIERE

Rear axle parts

Tren TRAS

Elementy zawieszenia tylnego

элементы задней оси.



2604006

Articulation essieu

OE 7701479190

Axle bush



Ø int.12 Ø ext.69 coll.80
long. tube int.90 ext.58.3 ep. coll. 10.3

1.4i 16v.
1.5 DCi
1.6i 16v.
1.9 DCi
2.0i 16v. CM05/0U/0W/1M/1N/1U
CM2H/2J/2V

2.0i 16v. Sauf équip. EAG CM1T
2.0 DCi Sauf équip. EAG CM1K
2.0 DCi CM1W

2604005

Articulation essieu

OE 7701479191

Axle bush



Ø int.12 Ø ext.69 coll.80
long. tube int.90 ext.58.5 ep. coll. 10.5

2.0i 16v. CM2P/2R
2.0i 16v. CM11 -09/11/06

2.0i 16v. Equip. EAG CM1T
2.0i 16v. F1TEAM CM1V
2.0 DCi Equip. EAG CM1K

Megane III ...

Eléments DIRECTION

Steering parts

Elementos Direcciones

Elementy układ kierowniczy

Элементы рулевой системы

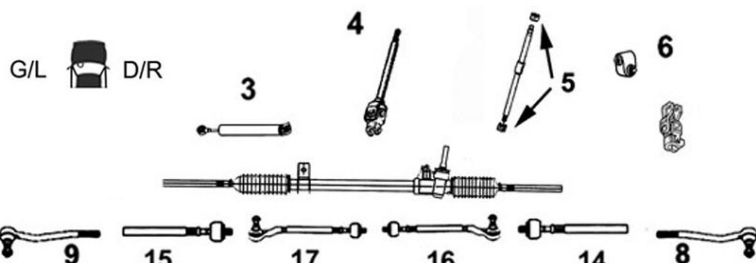

7774013

Axe de bielle G/D

Part/oe 485215612R

L/R axial joint



14 Côté dir. M14x1.5 Côté rot. M14x1.5 long 215 mm

15 1.2 TCE BZ11/6
1.4i Turbo BZ0F/1V
1.5 DCi BZ0A/B/C/D/6/9 BZ1A/F/G/M/W/0/4
1.6i 16v. BZ03/H/U BZ1B/H/R/U/Y BZ24
1.6 DCi BZ00 BZ12 BZ2A
1.9 DCi BZ0J/N BZ1J/K/S
2.0i Turbo BZ0K BZ1T BZ20/3
2.0i 16v. BZ0G BZ1P/E
2.0 DCi BZ0L/Y BZ27

... Megane III ...

<p>7674006 OE 485202710R</p> 	<p>Rotule de direction G <i>Left tie rod end</i></p> <p>9 M14 x 1.5 1.2 TCE BZ11/6 1.4i Turbo BZ0F/1V 1.5 DCi BZ0A/B/C/D/6/9 BZ1A/F/G/M/W/0/4 1.6i 16v. BZ03/H/U/1B/H/R/U/Y BZ24 1.6 DCi BZ00/12/2A 1.9 DCi BZ0J/N BZ1J/K/S 2.0i Turbo BZ0K BZ1T BZ20/3 2.0i 16v. BZ0G BZ1P/E 2.0 DCi BZ0L/Y BZ27</p>
---	---

<p>7674007 OE 485204680R</p> 	<p>Rotule de direction D <i>Right tie rod end</i></p> <p>8 M14 x 1.5 1.2 TCE BZ11/6 1.4i Turbo BZ0F/1V 1.5 DCi BZ0A/B/C/D/6/9 BZ1A/F/G/M/W/0/4 1.6i 16v. BZ03/H/U/1B/H/R/U/Y BZ24 1.6 DCi BZ00/12/2A 1.9 DCi BZ0J/N BZ1J/K/S 2.0i Turbo BZ0K BZ1T BZ20/3 2.0i 16v. BZ0G BZ1P/E 2.0 DCi BZ0L/Y BZ27</p>
--	--



Barre stabilisatrice
Stabilizer bar
Barra estabilizadora
Drażek stabilizatora
стабилизатор поперечной устойчивости

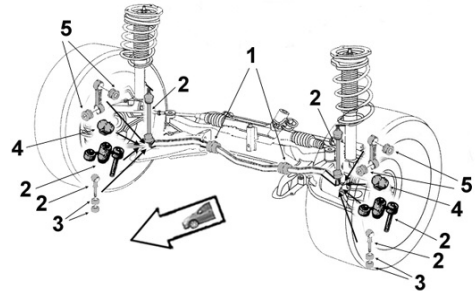



<p>2304019 OE 546180002R</p> 	<p>Biellette barre stab. <i>Stabilizer bar stub axle</i></p> <p>2 1.2 TCE BZ11/6 1.4i Turbo BZ0F/1V 1.5 DCi BZ0A/0B/0C/0D BZ1A/1F/1G/1M/1W/06/09 1.6i 16v. BZ03/0H/0U/1B/1H/1R/1U/1Y 1.6 DCi BZ00/12 1.9 DCi BZ0J/0N/1J/1K/1S 2.0i Turbo BZ0K/1T 2.0i 16v. BZ0G/1P/1E 2.0 DCi BZ0L/0Y</p>
--	---

<p>2304032 OE 546120005R</p> 	<p>Palier de barre milieu <i>Middle bar main bearing</i></p> <p>1 1.2 TCE BZ11 1.4i Turbo BZ0F/1V 1.5 DCi BZ0A/0B/0C/0D BZ1A/1F/1G/1M/1W/06/09/14 1.6i 16v. BZ03/0H/0U/1B/1H/1R/1U/1Y 1.6 DCi BZ00/12 1.9 DCi BZ0J/0N/1J/1K/1S 2.0i Turbo BZ0K/1T 2.0i 16v. BZ0G/1P/1E 2.0 DCi BZ0L/0Y</p>
--	--

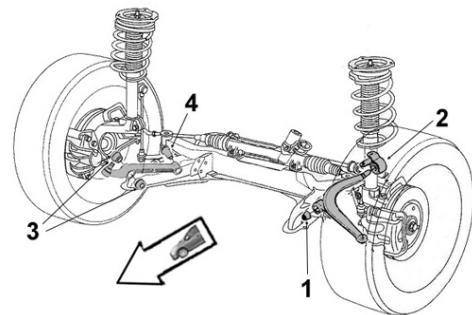

Eléments SUSPENSION
Suspension parts
Elementos suspensión
Elementy zawieszenie
Элементы подвески



<p>2254010 Part/oe 545008682R</p> 	<p>Articulation AV <i>Front bush</i></p> <p>1 Ø int. 18.5 Ø ext. 55 long. tube int. 50.5 ext. 31 1.2 TCE BZ11/16 1.4i Turbo BZ0F/1V 1.5 DCi BZ06/0A/0B/0C/12/09/0D/14/1A/1F/1G1/M/1W 12/09/12- 1.6i 16v. BZ03/0H/0U/1B/1H/1R/1U/1Y 12/09/12- 1.6 DCi BZ00/12 12/09/12- 1.9 DCi BZ0J/0N/1J/1K/1S 12/09/12- 2.0i 16v. BZ0G/1P/1E 12/09/12- 2.0i Turbo BZ0K/1T/20 12/09/12- 2.0 DCi BZ0L/0Y 12/09/12-</p>
--	--

<p>2254011 Part/oe 545008682R</p> 	<p>Articulation AR <i>Rear bush</i></p> <p>2 Ø int. 14.5 Ø ext. 58 long. tube int. 65 ext. 35.5 1.2 TCE BZ11/16 1.4i Turbo BZ0F/1V 1.5 DCi BZ06/0A/0B/0C/12/0D/14/1A/1F/1G1/M/1W 12/09/12- 1.6i 16v. BZ03/0H/0U/1B/1H/1R/1U/1Y 12/09/12- 1.6 DCi BZ00/12 12/09/12- 1.9 DCi BZ0J/0N/1J/1K/1S 12/09/12- 2.0i 16v. BZ0G/1P/1E 12/09/12-</p>
--	--

... Megane III ...

SASIC

RENAULT

Bras & Triangle de suspension

Control arm
Brazo y triángulo
Wahacz
Рычаг подвески

G/L  D/R



7474010

Triangle de susp. inf. G

OE 545018194R

Lower left track control arm

NEW



4 Avec rotule *With ball joint*
1.2 TCE BZ11/6
1.4i Turbo BZ0F BZ1V
1.5 DCi BZ0A/B/C/D/6
BZ1A/F/G/M/W/0/4
1.6i 16v. BZ03/H/U/1B/H/R/U/Y BZ24
1.6 DCi BZ00 BZ12 BZ2A
1.9 DCi BZ0J/N BZ1J/K/S
2.0i 16v. BZ0G BZ1P/E

7474011

Triangle de susp. inf. D

OE 545008682R

Lower right track control arm

NEW



3 Avec rotule *With ball joint*
1.2 TCE BZ11/6
1.4i Turbo BZ0F BZ1V
1.5 DCi BZ0A/B/C/D/6
BZ1A/F/G/M/W/0/4
1.6i 16v. BZ03/H/U/1B/H/R/U/Y BZ24
1.6 DCi BZ00 BZ12 BZ2A
1.9 DCi BZ0J/N BZ1J/K/S
2.0i 16v. BZ0G BZ1P/E

7574002

Rotule de susp. inf. G/D

Part/oe 545018194R

L/R lower suspension ball joint



1
1.2 TCE BZ11/6
1.4i Turbo BZ0F BZ1V
1.5 DCi BZ0A/B/C/D/6 BZ1A/F/G/M/W/0/4
1.6i 16v. BZ03/H/U BZ1B/H/R/U/Y BZ24
1.6 DCi BZ00 BZ12 BZ2A
1.9 DCi BZ0J/N BZ1J/K/S
2.0i 16v. BZ0G BZ1P/E



Support d'amortisseur

Suspension mounting
Soporte amortiguador
Poduszka amortyzatora
Опора амортизатора

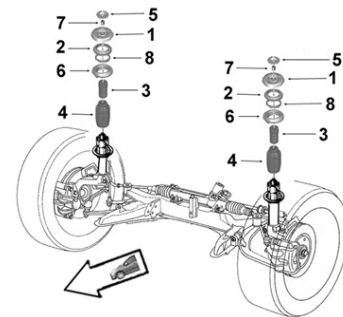

2654019

Support suspension G/D

OE 540340002R

L/R suspension mounting



1
1.2 TCE BZ11/16
1.4i Turbo BZ0F/1V
1.5 DCi BZ0A/0B/0C/0D/1A/1F/1G/1M/1W/06/09
1.6i 16v. BZ03/0H/0U/1B/1H/1R/1U/1Y
1.6 DCi BZ00/12
1.9 DCi BZ0J/0N/1J/1K/1S
2.0i Turbo BZ0K/1T
2.0i 16v. BZ0G/1P/1E
2.0 DCi BZ0L/0Y

2654023

Butée à billes G/D

OE 543256557R

L/R ball bearing



2
1.2 TCE BZ11
1.4i Turbo BZ0F/1V
1.5 DCi BZ0A/0B/0C/0D/1A/1F/1G/1M/1W/06/09/14
1.6i 16v. BZ03/0H/0U/1B/1H/1R/1U/1Y
1.6 DCi BZ00/12
1.9 DCi BZ0J/0N/1J/1K/1S
2.0i Turbo BZ0K/1T
2.0i 16v. BZ0G/1P/1E
2.0 DCi BZ0L/0Y

... Megane III

Eléments TRAIN ARRIERE

Rear axle parts

Tren TRAS

Elementy zawieszenia tylnego

элементы задней оси.



RENAULT



2604003

Articulation essieu AR

OE 550445344R

Rear axle bush



Ø int. 12 Ø ext. 69.5 coll. 80 long. tube int.89 ext.57.5 ep. coll.10.5

1.2 TCE	BZ11/16
1.4i Turbo	BZ0F/1V
1.5 DCi	BZ0A/0B/0C/0D/1A/1F/1G/1M/1W/06/09/14
1.6i 16v.	BZ03/0H/0U/1B/1H/1R/1U/1Y
1.6 DCi	BZ00/12
Jante tôle 16p. Jante alu 16/17p.	BZ0J/0N/1J/1K/1S
1.9 DCi	BZ0K/1T
2.0i Turbo	BZ0G/1P/1E
Jante alu Ø 17p.	BZ0L/0Y
2.0i 16v.	
2.0 DCi	Jante alu Ø 17p.

Megane III Break ...

Eléments DIRECTION

Steering parts

Elementos Direcciones

Elementy układ kierowniczy

Элементы рулевой системы

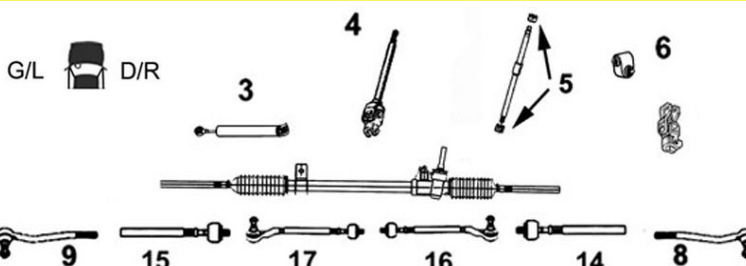

7774013

Axe de bielle G/D

Part/oe 485215612R

L/R axial joint



14 Côté dir. M14x1.5 Côté rot. M14x1.5 long 215 mm

15	1.2 TCE	KZ11/6
	1.4i Turbo	KZ0F/1V
	1.5 DCi	KZ0A/B/C/D/9 KZ1A/F/G/M/W/0/4
	1.6i 16v.	KZ03/H/U KZ1B/R/U/Y KZ24
	1.6 DCi	KZ00/12/2A
	1.9 DCi	KZ0J/N KZ1S
	2.0i Turbo	KZ0K/1T/20/23
	2.0i 16v.	KZ0G/1P
	2.0 DCi	KZ0L/Y KZ27

7674006

Rotule de direction G

OE 485202710R

Left tie rod end



9 M14 x 1.5

1.2 TCE	KZ11/6
1.4i Turbo	KZ0F/1V
1.5 DCi	KZ0A/B/C/D/9 KZ1A/F/G/M/W/0/4
1.6i 16v.	KZ03/H/U/1B/R/U/Y/24
1.6 DCi	KZ00 KZ12 KZ2A
1.9 DCi	KZ0J/N KZ1S
2.0i Turbo	KZ0K KZ1T KZ20/3
2.0i 16v.	KZ0G/1P
2.0 DCi	KZ0L/Y KZ27

7674007

Rotule de direction D

OE 485204680R

Right tie rod end



8 M14 x 1.5

1.2 TCE	KZ11/6
1.4i Turbo	KZ0F/1V
1.5 DCi	KZ0A/B/C/D/9 KZ1A/F/G/M/W/0/4
1.6i 16v.	KZ03/H/U/1B/R/U/Y KZ24
1.6 DCi	KZ00 KZ12 KZ2A
1.9 DCi	KZ0J/N KZ1S
2.0i Turbo	KZ0K KZ1T KZ20/3
2.0i 16v.	KZ0G KZ1P
2.0 DCi	KZ0L/Y KZ27

... Megane III Break ...

SASIC

RENAULT



Barre stabilisatrice
Stabilizer bar
Barra estabilizadora
Drażek stabilizatora
стабилизатор поперечной устойчивости

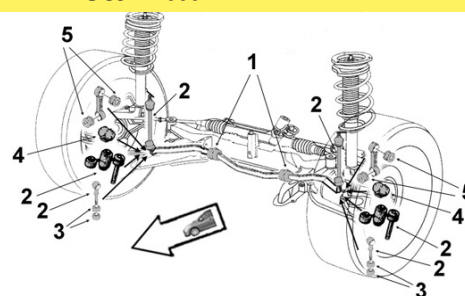

2304019 **Biellette barre stab.**
 OE 546180002R *Stabilizer bar stub axle*



2	1.2 TCE 1.4i Turbo 1.5 DCi	KZ11/16 KZ0F/1V KZ0A/0B/0C/0D KZ1A/1F/1G/1M/1W/09 KZ03/0H/0U/1B/1R/1U/1Y
	1.6i 16v. 1.6 DCi FAP 1.9 DCi 2.0i Turbo 2.0i 16v. 2.0 DCi	KZ00/12 KZ0J/0N/1S KZ0K/1T KZ0G/1P KZ0L/0Y

2304032 **Palier de barre milieu**
 OE 546120005R *Middle bar main bearing*



1	1.2 TCE Châssis sport 1	KZ11
	1.4i Turbo Châssis sport 1	KZ0F/1V
	1.5 DCi Châssis sport 1	KZ0B/0D/1A/1G/1M/1W/09/14
	1.6i 16v. Châssis sport 1	KZ03/0H/0U/1R/1U
	1.6 DCi Châssis sport 1	KZ00/12
	1.9 DCi Châssis sport 1	KZ0J/0N/1S
	2.0i Turbo Châssis sport 1	KZ0K/1T
	2.0i Turbo	KZ20
	2.0i 16v. Châssis sport 1	KZ0G/1P
	2.0 DCi Châssis sport 1	KZ0L



Eléments SUSPENSION
Suspension parts
Elementos suspensión
Elementy zawieszenie
Элементы подвески

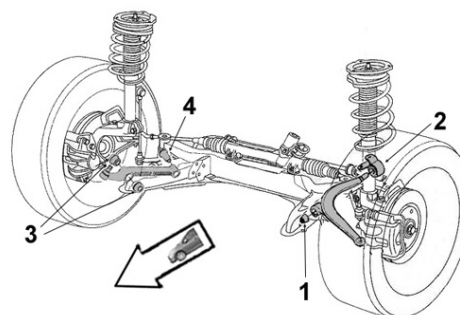

2254010 **Articulation AV**
 Part/oe 545008682R *Front bush*



1	Ø int. 18.5 Ø ext. 55 long. tube int. 50.5 ext. 31		
	1.2 TCE	KZ11/16	12/09/12-
	1.4i Turbo	KZ0F/1V	12/09/12-
	1.5 DCi	KZ0A/0B/0C/0D/09/14/1A/1F/1G/1M/1W	12/09/12-
	1.6i 16v.	KZ03/0H/0U/1B/1R/1U/1Y	12/09/12-
	1.6 DCi	KZ00/12	12/09/12-
	1.9 DCi	KZ0J/0N/1S	12/09/12-
	2.0i 16v.	KZ0G/1P	12/09/12-
	2.0i Turbo	KZ0K/1T/20/23	12/09/12-
	2.0 DCi	KZ0L/0Y	12/09/12-

2254011 **Articulation AR**
 Part/oe 545008682R *Rear bush*



2	Ø int. 14.5 Ø ext. 58 long. tube int. 65 ext. 35.5		
	1.4i Turbo	KZ0F/1V	12/09/12-
	1.5 DCi	KZ0A/0B/0C/0D/14/1A/1F/1G/1M/1W	12/09/12-
	1.6i 16v.	KZ03/0H/0U/1B/1R/1U/1Y	12/09/12-
	1.6 DCi	KZ00/12	12/09/12-
	1.9 DCi	KZ0J/0N/1S	12/09/12-
	2.0i 16v.	KZ0G/1P	12/09/12-

... Megane III Break ...

Bras & Triangle de suspension

Control arm
Brazo y triángulo
Wahacz
Рычаг подвески

G/L  D/R

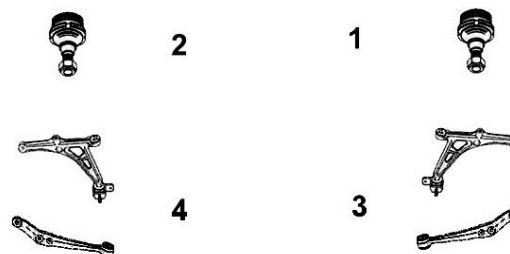

RENAULT



7474010

Triangle de susp. inf. G

OE 545018194R

Lower left track control arm

NEW



4 Avec rotule *With ball joint*
1.2 TCE KZ11/6
1.4i Turbo KZ0F KZ1V
1.5 DCi KZ0A/B/C/D
KZ1A/F/G/M/W/0/4
1.6i 16v. KZ03/H/U/1B/R/U/Y KZ24
1.6 DCi KZ00 KZ12 KZ2A
1.9 DCi KZ0J/N KZ1S
2.0i 16v. KZ0G KZ1P

7474011

Triangle de susp. inf. D

OE 545008682R

Lower right track control arm

NEW



3 Avec rotule *With ball joint*
1.2 TCE KZ11/6
1.4i Turbo KZ0F KZ1V
1.5 DCi KZ0A/B/C/D
KZ1A/F/G/M/W/0/4
1.6i 16v. KZ03/H/U/1B/R/U/Y KZ24
1.6 DCi KZ00 KZ12 KZ2A
1.9 DCi KZ0J/N KZ1S
2.0i 16v. KZ0G KZ1P

7574002

Rotule de susp. inf. G/D

Part/oe 545018194R

L/R lower suspension ball joint



1
2
1.2 TCE KZ11/6
1.4i Turbo KZ0F KZ1V
1.5 DCi KZ0A/B/C/D KZ1A/F/G/M/W/0/4
1.6i 16v. KZ03/H/U KZ1B/R/U/Y KZ24
1.6 DCi KZ00 KZ12 KZ2A
1.9 DCi KZ0J/N KZ1S
2.0i 16v. KZ0G KZ1P



Support d'amortisseur

Suspension mounting
Soporte amortiguador
Poduszka amortyzatora
Опора амортизатора

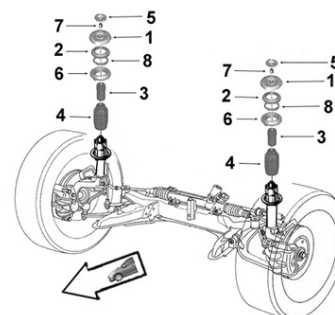

2654019

Support suspension G/D

OE 540340002R

L/R suspension mounting



1
1.2 TCE KZ11/16
1.4i Turbo KZ0F/1V
1.5 DCi KZ0A/0B/0C/0D/1A/1F/1G/1M/1W/09
1.6i 16v. KZ03/0H/0U/1B/1R/1U/1Y
1.6 DCi KZ00/12
1.9 DCi KZ0J/0N/1S
2.0i Turbo KZ0K/1T
2.0i 16v. KZ0G/1P
2.0 DCi KZ0L/0Y

2654023

Butée à billes G/D

OE 543256557R

L/R ball bearing



2
1.2 TCE KZ11
1.4i Turbo KZ0F/1V
1.5 DCi KZ0A/0B/0C/0D/1A/1F/1G/1M/1W/09/14
1.6i 16v. KZ03/0H/0U/1B/1R/1U/1Y
1.6 DCi KZ00/12
1.9 DCi KZ0J/0N/1S
2.0i Turbo KZ0K/1T/20
2.0i 16v. KZ0G/1P
2.0 DCi KZ0L/0Y

... Megane III Break

Eléments TRAIN ARRIERE

Rear axle parts

Tren TRAS

Elementy zawieszenia tylnego

элементы задней оси.



2604003

Articulation essieu AR

OE 550445344R

Rear axle bush



Ø int. 12 Ø ext. 69.5 coll. 80 long. tube int.89 ext.57.5 ep. coll.10.5

1.2 TCE	Jante tôle 16p.	Jante alu 16/17p.	KZ11/16
1.4i Turbo			KZ0F/1V
1.5 DCi			KZ0A/0B/0C/0D/1A/1F/1G/1M/1W/09
1.5 DCi	Jante tôle 16p.	Jante alu 16/17p.	KZ14
1.6i 16v.			KZ03/0H/0U/1B/1R/1U/1Y
1.6 DCi	Jante tôle 16p.	Jante alu 16/17p.	KZ00/12
1.9 DCi			KZ0J/0N/1S
2.0i Turbo	Jante alu Ø 17p.		KZ0K/1T
2.0i 16v.			KZ0G/1P
2.0 DCi	Jante alu Ø 17p.		KZ0L/0Y

Megane III Cab. CC ...

Eléments DIRECTION

Steering parts

Elementos Direcciones

Elementy uklad kierowniczy

Элементы рулевой системы

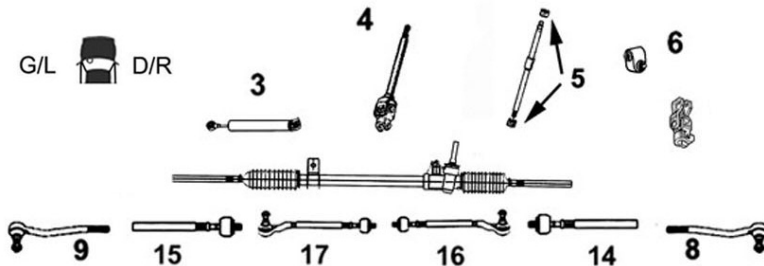

7774013

Axe de bielle G/D

Part/oe 485215612R

L/R axial joint



14 Côté dir. M14x1.5 Côté rot. M14x1.5 long 215 mm

15	1.2 TCE	EZ11/6
	1.4i Turbo	EZ0F/1V
	1.5 DCi	EZ07/9/B/D EZ1G/4
	1.6i 16v.	EZ03/U EZ1U/Y
	1.6 DCi	EZ00/2A
	1.9 DCi	EZ0J/N EZ1K/S
	2.0i Turbo	EZ0K/1T
	2.0i 16v.	EZ0G EZ1E/P
	2.0 DCi	EZ0L

7674006

Rotule de direction G

OE 485202710R

Left tie rod end



9 M14x1.5

1.2 TCE	EZ11/6
1.4i Turbo	EZ0F/1V
1.5 DCi	EZ07/9/B/D EZ1G/4
1.6i 16v.	EZ03/U EZ1U/Y
1.6 DCi	EZ00/2A
1.9 DCi	EZ0J/N EZ1K/S
2.0i Turbo	EZ0K/1T
2.0i 16v.	EZ0G EZ1E/P
2.0 DCi	EZ0L

7674007

Rotule de direction D

OE 485204680R

Right tie rod end



8 M14x1.5

1.2 TCE	EZ11/6
1.4i Turbo	EZ0F/1V
1.5 DCi	EZ07/9/B/D EZ1G/4
1.6i 16v.	EZ03/U EZ1U/Y
1.6 DCi	EZ00/2A
1.9 DCi	EZ0J/N EZ1K/S
2.0i Turbo	EZ0K/1T
2.0i 16v.	EZ0G EZ1E/P
2.0 DCi	EZ0L

... Megane III Cab. CC ...



Barre stabilisatrice
 Stabilizer bar
 Barra estabilizadora
 Drażek stabilizatora
 стабилизатор поперечной устойчивости

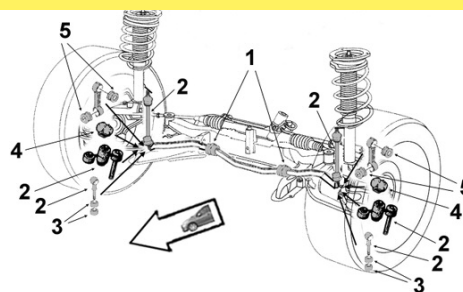

RENAULT



2304019

Biellette barre stab.

OE 546180002R

Stabilizer bar stub axle



2

Châssis cup

2.0i Turbo EZ0K/1T
 2.0 DCi EZ0L

2304031

Palier de barre milieu

OE 546120316R

Middle bar main bearing



1

Châssis cup

2.0i Turbo EZ0K/1T



Eléments SUSPENSION

Suspension parts
Elementos suspensión
Elementy zawieszenie
Элементы подвески

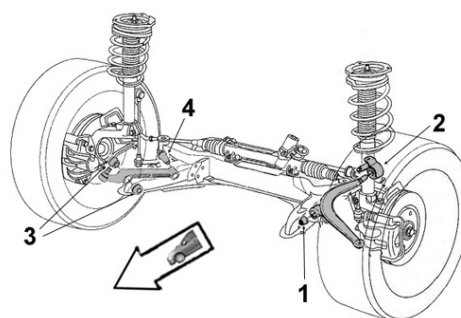

2254010

Articulation AV

Part/oe 545006560R

Front bush



1

Ø int. 18.5 Ø ext. 55 long. tube int. 50.5 ext. 31

1.2 TCE	EZ11/16	12/09/12-
1.4i Turbo	EZ0F/1V	12/09/12-
1.5 DCi	EZ07/09/0B/0D/14/1G	12/09/12-
1.6i 16v.	EZ03/0U/1U/1Y	12/09/12-
1.6 DCi	EZ00	12/09/12-
1.9 DCi	EZ0J/0N/1K/1S	12/09/12-
2.0i 16v.	EZ1E/1P	12/09/12-
2.0i Turbo	EZ0K/0L/1T	12/09/12-

2254011

Articulation AR

Part/oe 545008682R

Rear bush

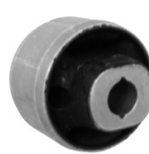

2

Ø int. 14.5 Ø ext. 58 long. tube int. 65 ext. 35.5

1.5 DCi	EZ09	12/09/12-
1.6 DCi	EZ00	12/09/12-
2.0i Turbo	EZ0K/0L/T	12/09/12-

Bras & Triangle de suspension

Control arm
Brazo y triángulo
Wahacz
Рычаг подвески

G/L D/R

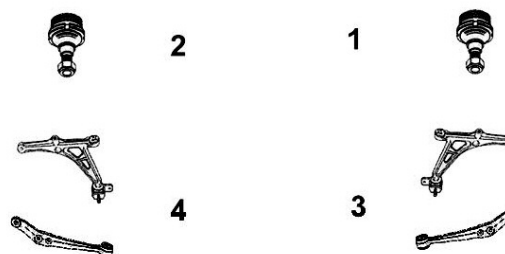

7474010

Triangle de susp. inf. G

OE 545018194R

Lower left track control arm

NEW

4

Avec rotule With ball joint

1.2 TCE	EZ11/6	-12/09/12
1.4i Turbo	EZ0F/1V	-12/09/12
1.5 DCi	EZ07/B/D EZ1G/4	-12/09/12
1.6i 16v.	EZ03/U EZ1U/Y	-12/09/12
1.9 DCi	EZ0J/N EZ1K/S	-12/09/12
2.0i 16v.	EZ1E/P	-12/09/12



7474011

Triangle de susp. inf. D

OE 545008682R

Lower right track control arm

NEW

3

Avec rotule With ball joint

1.2 TCE	EZ11/6	-12/09/12
1.4i Turbo	EZ0F/1V	-12/09/12
1.5 DCi	EZ07/B/D EZ1G/4	-12/09/12
1.6i 16v.	EZ03/U EZ1U/Y	-12/09/12
1.9 DCi	EZ0J/N EZ1K/S	-12/09/12
2.0i 16v.	EZ1E/P	-12/09/12



... Megane III Cab. CC

Bras & Triangle de suspension

Control arm
Brazo y triángulo
Wahacz
Рычаг подвески

G/L  D/R

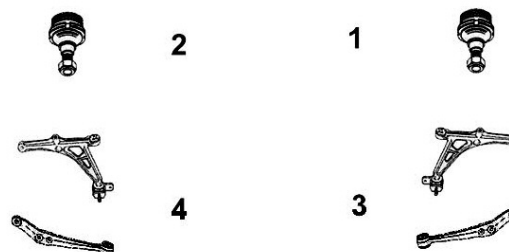

7574002

Rotule de susp. inf. G/D

Part/oe 545018194R

L/R lower suspension ball joint



1
2

1.2 TCE	EZ11/6	-12/09/12
1.4i Turbo	EZ0F/1V	-12/09/12
1.5 DCi	EZ07/B/D EZ1G/4	-12/09/12
1.6i 16v.	EZ03/U EZ1U/Y	-12/09/12
1.9 DCi	EZ0J/N EZ1K/S	-12/09/12
2.0i 16v.	EZ1E/P	-12/09/12



Support d'amortisseur

Suspension mounting
Soporte amortiguador
Poduszka amortyzatora
Опора амортизатора

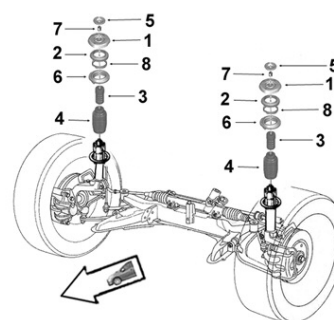

2654019

Support suspension G/D

OE 540340002R

L/R suspension mounting



1

1.4i Turbo	EZ0F/1V
1.5 DCi	EZ07/09/0B/0D/1G
1.6i 16v.	EZ03/0U/1U/1Y
1.9 DCi	EZ0J/0N/1K/1S
2.0i Turbo	EZ0K/1T
2.0i 16v.	EZ0G/1E/1P
2.0 DCi	EZ0L

2654023

Butée à billes G/D

OE 543256557R

L/R ball bearing



2

1.2 TCE	EZ11
1.4i Turbo	EZ0F/1V
1.5 DCi	EZ07/09/0B/0D/1G/14
1.6i 16v.	EZ03/0U/1U/1Y
1.6 DCi	EZ00
1.9 DCi	EZ0J/0N/1K/1S
2.0i Turbo	EZ0K/1T
2.0i 16v.	EZ0G/1E/1P
2.0 DCi	EZ0L

Megane III Coupé ...

Eléments DIRECTION

Steering parts
Elementos Direcciones
Elementy układ kierowniczy
Элементы рулевой системы

G/L  D/R

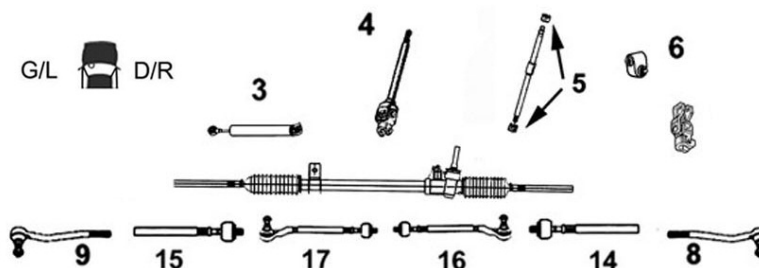

7774013

Axe de bielle G/D

Part/oe 485215612R

L/R axial joint





14 Côté dir. M14x1.5 Côté rot. M14x1.5 long 215 mm

1.2 TCE	DZ11/6
1.4i Turbo	DZ0F/1V
1.5 DCi	DZ0A/B/C/D/9 DZ1A/F/G/M/W/0/4
1.6i 16v.	DZ03/U DZ1B/H/U/Y DZ24
1.6 DCi	DZ00 DZ12 DZ2A
1.9 DCi	DZ0J/N DZ1J/K/S
2.0i Turbo	DZ0K DZ1T DZ20/3
2.0i 16v.	DZ0G DZ1E/P
2.0 DCi	DZ0L/Y DZ27

... Megane III Coupé ...

RENAULT





7674006 OE 485202710R	Rotule de direction G <i>Left tie rod end</i>	7674007 OE 485204680R	Rotule de direction D <i>Right tie rod end</i>
	9 M14 x 1.5 1.2 TCE DZ11/6 1.4i Turbo DZ0F/1V 1.5 DCi DZ0A/B/C/D/9 DZ1A/F/G/M/W/0/4 1.6i 16v. DZ03/U DZ1B/H/U/Y DZ24 1.6 DCi DZ00 DZ12 DZ2A 1.9 DCi DZ0J/N DZ1J/K/S 2.0i Turbo DZ0K DZ1T DZ20/3 2.0i 16v. DZ0G DZ1E/P 2.0 DCi DZ0L/Y DZ27		8 M14 x 1.5 1.2 TCE DZ11/6 1.4i Turbo DZ0F/1V 1.5 DCi DZ0A/B/C/D/9 DZ1A/F/G/M/W/0/4 1.6i 16v. DZ03/U DZ1B/H/U/Y DZ24 1.6 DCi DZ00 DZ12 DZ2A 1.9 DCi DZ0J/N DZ1J/K/S 2.0i Turbo DZ0K DZ1T DZ20/3 2.0i 16v. DZ0G DZ1E/P 2.0 DCi DZ0L/Y DZ27



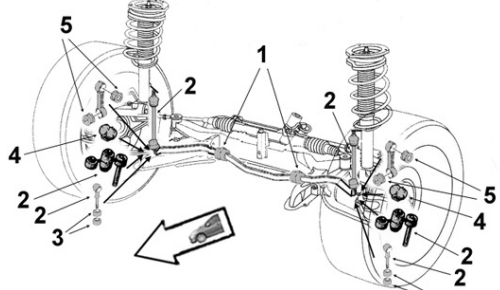

Barre stabilisatrice
Stabilizer bar
Barra estabilizadora
Drażek stabilizatora
стабилизатор поперечной устойчивости



2304019 OE 546180002R	Biellette barre stab. <i>Stabilizer bar stub axle</i>
	2 1.2 TCE DZ11/16 1.4i Turbo DZ0F/1V 1.5 DCi DZ0A/0B/0C/0D/1A/1F/1G/1M/1W/09 1.6i 16v. DZ03/0U/1B/1H/1U/1Y 1.6 DCi FAP DZ00/12 1.9 DCi DZ0J/0N/1J/1K/1S 2.0i Turbo DZ0K/04/1N/1P/1T 2.0i 16v. DZ0G/1E/1N/1P/15/18 2.0 DCi DZ0L/0Y

2304032 OE 546120005R	Palier de barre milieu <i>Middle bar main bearing</i>
	1 1.2 TCE DZ11 1.4i Turbo DZ0F/1V 1.5 DCi DZ0A/0B/0C/0D DZ1A/1F/1G/1M/1W/09/14 1.6i 16v. DZ03/0U/1B/1H/1U/1Y 1.6 DCi DZ00 1.9 DCi DZ0J/0N/1J/1K/1S 2.0i Turbo DZ0K/1T/20 2.0i 16v. DZ0G/1P/1E 2.0 DCi DZ0L/0Y

2304031 OE 546120316R	Palier de barre milieu <i>Middle bar main bearing</i>
	1 2.0i Turbo DZ15/18/21 2.0i Turbo Châssis cup DZ1N/17



Eléments SUSPENSION
Suspension parts
Elementos suspensión
Elementy zawieszenie
Элементы подвески

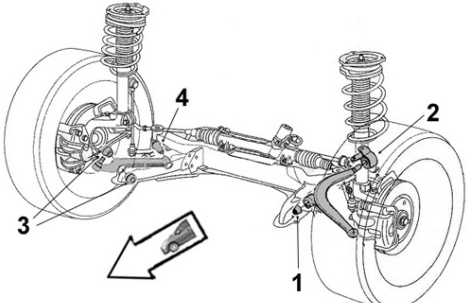

2254010 Part/oe 545008682R	Articulation AV <i>Front bush</i>
	1 Ø int. 18.5 Ø ext. 55 long. tube int. 50.5 ext. 31 1.2 TCE DZ11/16 1.4i Turbo DZ0F/1V 1.5 DCi DZ0A/0B/0C/0D/09/14/1A/1F/1G/1M/1W 1.6i 16v. DZ03/0U/1B/1H/1U/1Y 1.6 DCi DZ00 1.9 DCi DZ0N/1J/1K/1S 2.0i 16v. DZ0G/1E/1P 2.0i Turbo DZ0K/1T/20 2.0 DCi DZ0L/0Y

... Megane III Coupé ...



Eléments SUSPENSION

Suspension parts
Elementos suspensión
Elementy zawieszenie
Элементы подвески

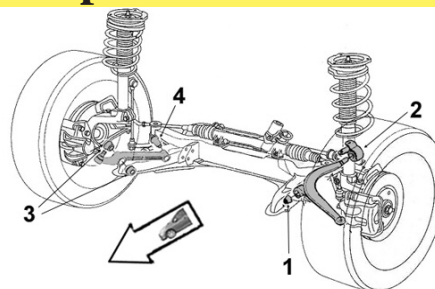

RENAULT

SASIC

2254011 Articulation AR

Part/oe 545008682R Rear bush



2 Ø int. 14.5 Ø ext. 58 long. tube int. 65 ext. 35.5

1.2 TCE	DZ11/16	
1.4i Turbo	DZ0F/1V	12/09/12-
1.5 DCi	DZ0A/0B/0C/0D/14/1A/1F/1G/1M/1W	12/09/12-
1.6i 16v.	DZ03/0U/1B/1H/1U/1Y	12/09/12-
1.6 DCi	DZ00	12/09/12-
1.9 DCi	DZ0N/1J/1K/1S	12/09/12-
2.0i 16v.	DZ0G/1E/1P	12/09/12-

Bras & Triangle de suspension

Control arm
Brazo y triángulo
Wahacz
Рычаг подвески

G/L D/R

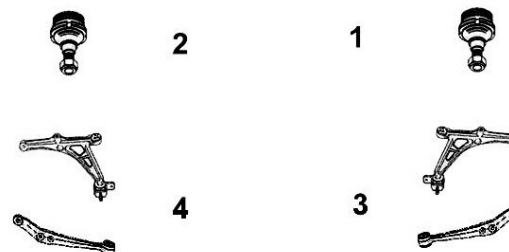

7474010 Triangle de susp. inf. G

OE 545018194R Lower left track control arm

NEW



4 Avec rotule With ball joint

1.2 TCE	DZ11/6
1.4i Turbo	DZ0F DZ1V
1.5 DCi	DZ0A/B/C/D
	DZ1A/F/G/M/W/0/4
1.6i 16v.	DZ03/U DZ1B/H/U/Y DZ24
1.6 DCi	DZ00
1.9 DCi	DZ0J/N DZ1J/K/S
2.0i 16v.	DZ0G DZ1E/P

7474011 Triangle de susp. inf. D

OE 545008682R Lower right track control arm

NEW



3 Avec rotule With ball joint

1.2 TCE	DZ11/6
1.4i Turbo	DZ0F DZ1V
1.5 DCi	DZ0A/B/C/D
	DZ1A/F/G/M/W/0/4
1.6i 16v.	DZ03/U DZ1B/H/U/Y DZ24
1.6 DCi	DZ00
1.9 DCi	DZ0J/N DZ1J/K/S
2.0i 16v.	DZ0G DZ1E/P

7574002 Rotule de susp. inf. G/D

Part/oe 545018194R L/R lower suspension ball joint



1
2

1.2 TCE	DZ11/6
1.4i Turbo	DZ0F DZ1V
1.5 DCi	DZ0A/B/C/D DZ1A/F/G/M/W/0/4
1.6i 16v.	DZ03/U DZ1B/H/U/Y DZ24
1.6 DCi	DZ00
1.9 DCi	DZ0J/N DZ1J/K/S
2.0i 16v.	DZ0G DZ1E/P

... Megane III Coupé



Support d'amortisseur

Suspension mounting
Soporte amortiguador
Poduszka amortyzatora
Опора амортизатора

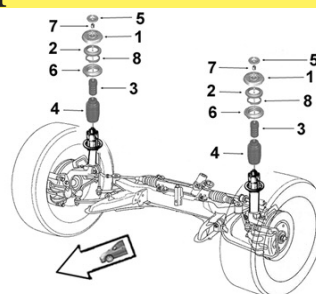

2654019

Support suspension G/D

OE 540340002R

L/R suspension mounting



1	1.2 TCE	DZ11/16
	1.4i Turbo	DZ0F/1V
	1.5 DCi	DZ0A/0B/0C/0D DZ1A/1F/1G/1M/1W/09
	1.6i 16v.	DZ03/0U/1B/1H/1U/1Y
	1.6 DCi	DZ00/0L/0Y/27
	1.9 DCi	DZ0J/0N/1J/1K/1S
	2.0i Turbo	DZ0K/1T
	2.0i 16v.	DZ0G/1P/1E
	2.0 DCi	DZ0L/0Y

2654023

Butée à billes G/D

OE 543256557R

L/R ball bearing



2	1.2 TCE	DZ11
	1.4i Turbo	DZ0F/1V
	1.5 DCi	DZ0A/0B/0C/0D DZ1A/1F/1G/1M/1W/09/14
	1.6i 16v.	DZ03/0U/1B/1H/1U/1Y
	1.6 DCi	DZ00
	1.9 DCi	DZ0J/0N/1J/1K/1S
	2.0i Turbo	DZ0K/04 DZ1N/1T/15/17/18/20/21
	2.0i 16v.	DZ0G/1P/1E
	2.0 DCi	DZ0L/0Y

Eléments TRAIN ARRIERE

Rear axle parts

Tren TRAS

Elementy zawieszenia tylnego

элементы задней оси.



2604003

Articulation essieu AR

OE 550445344R

Rear axle bush



	Ø int. 12 Ø ext. 69.5 coll. 80 long. tube int.89 ext.57.5 ep. coll.10.5	
	1.2 TCE	DZ11/16
	1.4i Turbo	DZ0F/1V
	1.5 DCi	DZ0A/0B/0C/0D/1A/1F/1G/1M/1W/09/14
	1.6i 16v.	DZ03/0U/1B/1H/1U/1Y
	1.6 DCi	Jante tôle 16p. Jante alu 16/17p.
	1.9 DCi	DZ00
	2.0i Turbo	DZ0J/0N/1J/1K/1S
	2.0i Turbo	DZ0K/1T
	2.0i 16v.	DZ1N/15/17/18
	2.0 DCi	DZ0G/1P/1E
	2.0 DCi	Jante alu 17p. DZ0L/0Y

Modus ...

Eléments DIRECTION

Steering parts

Elementos Direcciones

Elementy układ kierowniczy

Элементы рулевой системы

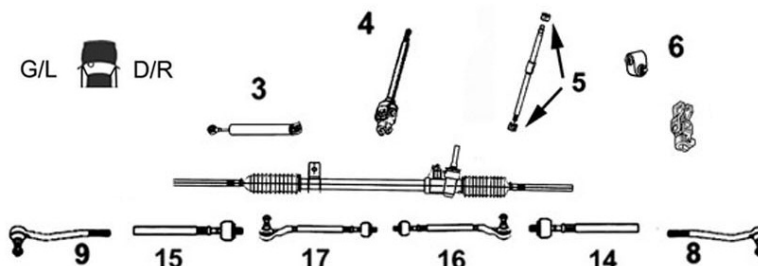

3008241

Axe de bielle G/D

Part/oe 7701475841

L/R axial joint



14 Côté dir. M14x1.5 Côté rot. M14x1.5 long 304 mm

15

1.2i 16v.
1.4i 16v.
1.5 DCi
1.6i 16v.

... Modus ...

Eléments DIRECTION

Steering parts

Elementos Direcciones

Elementy układ kierowniczy

Элементы рулевой системы

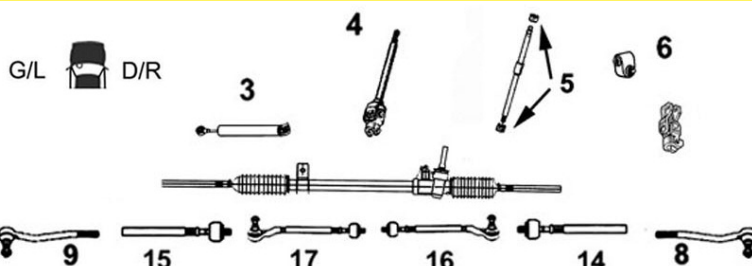

4006134

Rotule de direction G

OE 7701475842

Left tie rod end



9

1.2i 16v.
1.4i 16v.
1.5 DCi
1.6i 16v.

4006135

Rotule de direction D

OE 7701475843

Right tie rod end



8

1.2i 16v.
1.4i 16v.
1.5 DCi
1.6i 16v.



Barre stabilisatrice

Stabilizer bar

Barra estabilizadora

Drażek stabilizatora

стабилизатор поперечной устойчивости

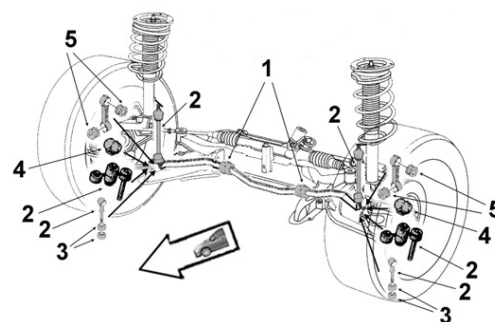

4005147

Biellette barre stab.

OE 8200127308

Stabilizer bar stub axle



2

Entraxe : 250 mm M10x150 X2

1.2i 16v. -28/04/10
1.4i 16v. -28/04/10
1.5 DCi -28/04/10
1.6i 16v. -28/04/10

2304015

Palier de barre milieu

OE 7701059672

Middle bar main bearing



1

Ø 21

1.2i 16v.
1.4i 16v.
1.5 DCi
1.6i 16v.



Eléments SUSPENSION

Suspension parts

Elementos suspensión

Elementy zawieszenie

Элементы подвески

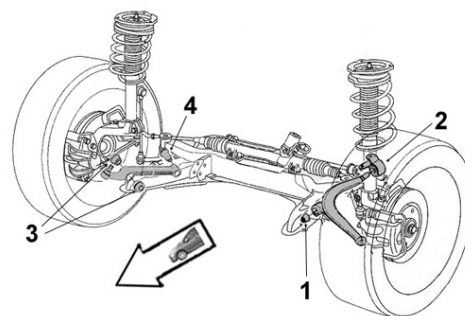

4001585

Articulation AV

Part/oe 8200744091

Front bush



1

**Ø int.12 Ø ext.36 coll.40
long. tube int.55 ext.39 ep. coll.5X2**

1.2i 16v.
1.4i 16v.
1.5 DCi
1.6i 16v.

4001584

Articulation AR

Part/oe 8200744091

Rear bush



2

Ø int.12 Ø ext.58 long. tube int.53 ext.27

1.2i 16v.
1.4i 16v.
1.5 DCi
1.6i 16v.

... Modus ...

Bras & Triangle de suspension

Control arm
Brazo y triángulo
Wahacz
Рычаг подвески

G/L  D/R



RENAULT



4003215

Triangle de susp. G

Part/oe 8200744091

Left track control arm



4 Sans rotule *Without ball joint*

1.2i 16v.
1.4i 16v.
1.5 DCi
1.6i 16v.

4003216

Triangle de susp. D

Part/oe 8200744092

Right track control arm



3 Sans rotule *Without ball joint*

1.2i 16v.
1.4i 16v.
1.5 DCi
1.6i 16v.

7474016

Triangle de susp. G

OE 8200744091

Left track control arm

NEW



4 Avec rotule *With ball joint* Ø 18

1.2i 16v.
1.4i 16v.
1.5 DCi
1.6i 16v.

7474015

Triangle de susp. D

OE 8200744092

Right track control arm

NEW



3 Avec rotule *With ball joint* Ø 18

1.2i 16v.
1.4i 16v.
1.5 DCi
1.6i 16v.

7574003

Rotule de susp. inf. G/D

OE 401604793R

L/R lower suspension ball joint



1
2 Ø 18

1.2i 16v.
1.4i 16v.
1.5 DCi
1.6i 16v.



Support d'amortisseur

Suspension mounting
Soporte amortiguador
Poduszka amortyzatora
Опора амортизатора

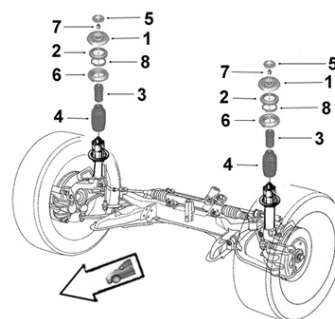

4001634

Support suspension G

OE 8200504291

Left suspension mounting



1

1.2i 16v.	FP-	
1.2i 16v. /ETH	JP-	-24/06/10
1.4i 16v.		-24/06/10
1.5 DCi	FP-	
1.5 DCi	JP-	-24/06/10
1.6i 16v.		-24/06/10

4001635

Support suspension D

OE 8200504295

Right suspension mounting



1

1.2i 16v.	FP-	
1.2i 16v. /ETH	JP-	-24/06/10
1.4i 16v.		-24/06/10
1.5 DCi	FP-	
1.5 DCi	JP-	-24/06/10
1.6i 16v.		-24/06/10

... Modus



Support d'amortisseur

Suspension mounting
Soporte amortiguador
Poduszka amortyzatora
Опора амортизатора

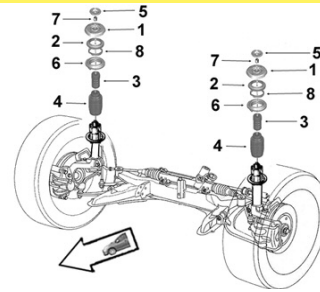

RENAULT

SASIC

2654035

Support suspension

OE 543024644R

Suspension mounting

NEW



1

1.2i 16v. JP- 24/06/10-
1.4i 16v. 24/06/10-
1.5 DCi JP0D/OE/02/05/06/07/08/1D 24/06/10-

1.5 DCi JP0F/0G/0H/17/1B 24/06/10-
1.6i 16v. 24/06/10-

2654030

Butée à billes G/D

OE 543259539R

L/R ball bearing

NEW



2

1.2i 16v. JP- 24/06/10-
1.4i 16v. 24/06/10-
1.5 DCi JP- 24/06/10-
1.6i 16v. 24/06/10-

2654007

Butée protecteur susp.

OE 8200127285

Suspension bush



3

4

1.2i 16v. FP-
1.2i 16v. /ETH JP- -24/06/10
1.4i 16v. JP- -24/06/10
1.5 DCi FP-
1.5 DCi JP- -24/06/10
1.6i 16v. -24/06/10

2654032

Protecteur amortisseur G/D

OE 543884315R

L/R shock absorber protector

NEW



4

1.2i 16v. JP- 24/06/10-
1.4i 16v. 24/06/10-
1.5 DCi JP- 24/06/10-
1.6i 16v. 24/06/10-

Safrane ...

Eléments DIRECTION

Steering parts
Elementos Direcciones
Elementy układ kierowniczy
Элементы рулевой системы

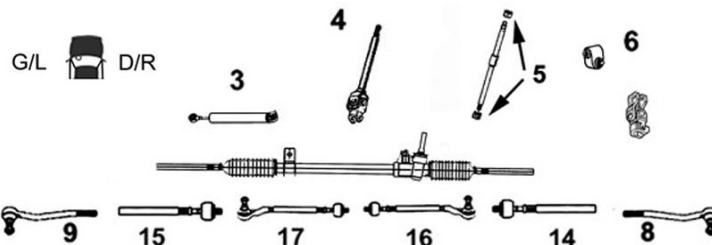

3008245

Axe de bielle G/D

Part/oe 7701469572

L/R axial joint



14

15

Côté dir. M12x1.0 Côté rot. M14x1.5 long 293 mm

TT /all models

4006233

Bielle de direction G

OE 7701466799

Left steering rod



17

TT /all models

4006234

Bielle de direction D

OE 7701466800

Right steering rod



16

TT /all models

... Safrane ...

RENAULT



4006130 OE 6000022714 Rotule de direction G <i>Left tie rod end</i>	4006131 OE 6000022715 Rotule de direction D <i>Right tie rod end</i>
<div style="display: flex; align-items: center;"> <div style="width: 100px; text-align: center; font-size: 24px; font-weight: bold;">9</div> <div style="flex-grow: 1;"> <p>TT /all models</p> </div> </div>	<div style="display: flex; align-items: center;"> <div style="width: 100px; text-align: center; font-size: 24px; font-weight: bold;">8</div> <div style="flex-grow: 1;"> <p>TT /all models</p> </div> </div>

Barre stabilisatrice
Stabilizer bar
Barra estabilizadora
Drażek stabilizatora
стабилизатор поперечной устойчивости

4005132 OE 7700805494 Biellette barre stab. <i>Stabilizer bar stub axle</i>	
<div style="display: flex; align-items: center;"> <div style="width: 100px; text-align: center; font-size: 24px; font-weight: bold;">2</div> <div style="flex-grow: 1;"> <p>TT /all models</p> </div> </div>	

Eléments SUSPENSION
Suspension parts
Elementos suspensión
Elementy zawieszenie
Элементы подвески

4001533 OE 7700806239 Articulation AV <i>Front bush</i>	4001534 OE 7700806238 Articulation AR <i>Rear bush</i>
<div style="display: flex; align-items: center;"> <div style="width: 100px; text-align: center; font-size: 24px; font-weight: bold;">1</div> <div style="flex-grow: 1;"> <p>Ø int.18 Ø ext.55 long. tube int.46 ext.30</p> <p>TT /all models</p> </div> </div>	<div style="display: flex; align-items: center;"> <div style="width: 100px; text-align: center; font-size: 24px; font-weight: bold;">2</div> <div style="flex-grow: 1;"> <p>Ø int.12.5 Ø ext.58 long. tube int.50 ext.29</p> <p>TT /all models</p> </div> </div>

... Safrane ...

SASIC

RENAULT

Bras & Triangle de suspension

Control arm
Brazo y triángulo
Wahacz
Рычаг подвески

G/L  D/R



4003376

Triangle de susp. G

OE 7700807580

Left track control arm

4 Avec rotule *With ball joint*



TT /all models

4003375

Triangle de susp. D

OE 7700807581

Right track control arm

3 Avec rotule *With ball joint*



TT /all models

4005267

Rotule de susp. inf. G/D

OE 7700421804

L/R lower suspension ball joint

1
2



TT /all models

1003574

Kit rép. triangle susp. G ou D

OE -

L or R track control arm bearing repair kit

Avec visserie *With screws and bolts*



TT /all models



Support d'amortisseur

Suspension mounting
Soporte amortiguador
Poduszka amortyzatora
Опора амортизатора

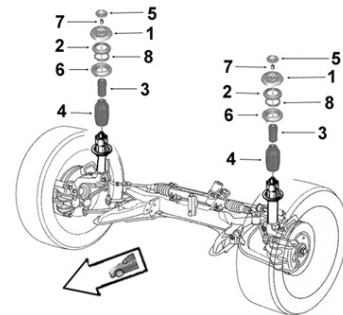

4001605

Support suspension G/D

OE 7700805920

L/R suspension mounting

1 susp. normale



2.0i	B540/2/E	-09/96
2.0i 16v.	B54L	09/96-
2.1 TD	B546	-09/96
2.2i	B541/3	-09/96
2.2 TD	B54G	09/96-
2.5i 20v.	B54F	09/96-
2.5 TD	B548	-09/96
3.0i V6 2WD	B544	-09/96
3.0i V6	B54B/J/M/N	09/96-

0355275

Butée à billes G/D

OE 7700824022

L/R ball bearing

2



TT /all models

... Safrane



Barre stabilisatrice

Stabilizer bar

Barra estabilizadora

Drażek stabilizatora

стабилизатор поперечной устойчивости

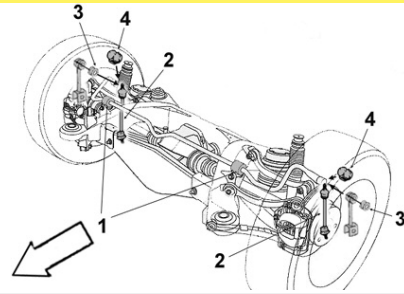

4005138

Biellette barre stab. AR

OE 7700806832

Rear stabilizer bar stub axle



2

TT /all models

RENAULT



Support d'amortisseur

Suspension mounting

Soporte amortiguador

Poduszka amortyzatora

Опора амортизатора

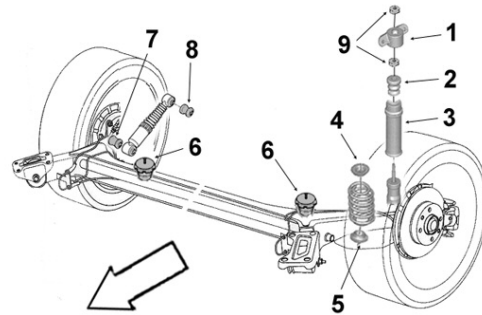

4001636

Support suspension G/D

OE 7700805922

L/R suspension mounting



1 susp. normale

2.0i	B540/2/E	-09/96
2.0i 16v.	B54L	09/96-
2.1 TD	B546	-09/96
2.2i	B541/3	-09/96
2.2 TD	B54G	09/96-
2.5i 20v.	B54F	09/96-
2.5 TD	B548	-09/96
3.0i V6 2WD	B544	-09/96
3.0i V6	B54B/J/M/N	09/96-

Scenic I -04/03 ...

Eléments DIRECTION

Steering parts

Elementos Direcciones

Elementy układu kierowniczy

Элементы рулевой системы

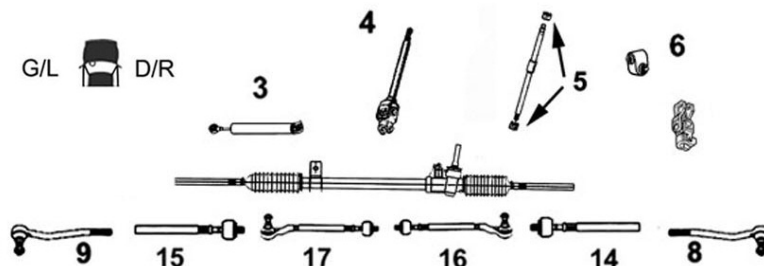

3008047

Axe de bielle G/D

Part/oe 7701472087

L/R axial joint



14 Côté dir. M14x1.5 Côté rot. M14x1.5 long 287 mm
15

TT /all models Dir. TRW FA0 JA0 JA1 17/02/99-





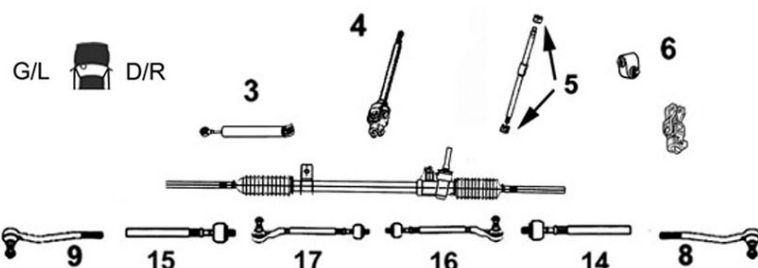



... Scenic I -04/03 ...

Eléments DIRECTION
Steering parts
Elementos Direcciones
Elementy układ kierowniczy
Элементы рулевой системы

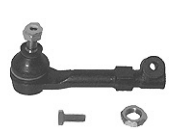

RENAULT

SASIC

<p>3008046 Part/oe 7701471844</p> 	<p>Axe de bielle G/D <i>L/R axial joint</i></p> <p>14 Côté dir. M12x1.0 Côté rot. M14x1.5 15 long 294 mm Dir. SMI</p> <p>1.6i 16v. JA04 -17/02/99 1.9 DTi JA0N -17/02/99 2.0i JA0G -17/02/99</p> <p>TT/all models FA0 JA0 JA1 17/02/99-</p>	<p>3008049 Part/oe 7701469502</p> 	<p>Axe de bielle G/D <i>L/R axial joint</i></p> <p>14 Côté dir. M12x1.0 Côté rot. M14x1.5 15 long 260 mm</p> <p>TT/all models Dir. SMI FA0 JA0 JA1 -18/09/98</p>
<p>3008050 Part/oe 7701471885</p> 	<p>Axe de bielle G/D <i>L/R axial joint</i></p> <p>14 Côté dir. M12x1.0 Côté rot. M14x1.5 15 long 257 mm Dir. SMI</p> <p>TT/all models JA0N/0/5/6/8 FA 18/09/98-17/02/99 1.4i JA0E 18/09/98-17/02/99 1.6i JA0L JA0F 18/09/98-17/02/99 1.9 D JA0J 18/09/98-17/02/99</p>	<p>3008109 Part/oe 7701469280</p> 	<p>Axe de bielle G/D <i>L/R axial joint</i></p> <p>14 Côté dir. M14x1.5 Côté rot. M14x1.5 15 long 255 mm</p> <p>TT/all models Dir. TRW FA0 JA0 JA1 -17/02/99</p>
<p>4006108 OE 7701472087</p> 	<p>Rotule de direction G <i>Left tie rod end</i></p> <p>9</p> <p>TT/all models Dir. SMI JA0E/0L/0F/0J/0N/00 -17/02/99 JA05/06/08 FA -17/02/99</p> <p>TT/all models Dir. TRW FA0 JA0 JA1 -17/02/99</p>	<p>4006109 OE 6000022721</p> 	<p>Rotule de direction D <i>Right tie rod end</i></p> <p>8</p> <p>TT/all models Dir. SMI JA0E/0L/0F/0J/0N/00 -17/02/99 JA05/06/08 FA -17/02/99</p> <p>TT/all models Dir. TRW FA0 JA0 JA1 -17/02/99</p>
<p>4006134 OE 7701474641</p> 	<p>Rotule de direction G <i>Left tie rod end</i></p> <p>9</p> <p>1.6i 16v. Dir. SMI JA04 -17/02/99 1.9 DTi Dir. SMI JA0N31 -17/02/99 2.0i Dir. SMI JA0G -17/02/99</p> <p>TT/all models Dir. SMI TRW FA0 JA0 JA1 17/02/99-</p>	<p>4006135 OE 7701047813</p> 	<p>Rotule de direction D <i>Right tie rod end</i></p> <p>8</p> <p>1.6i 16v. Dir. SMI JA04 -17/02/99 1.9 DTi Dir. SMI JA0N31 -17/02/99 2.0i Dir. SMI JA0G -17/02/99</p> <p>TT/all models Dir. SMI TRW FA0 JA0 JA1 17/02/99-</p>

... Scenic I -04/03 ...



Barre stabilisatrice
 Stabilizer bar
 Barra estabilizadora
 Drażek stabilizatora
 стабилизатор поперечной устойчивости

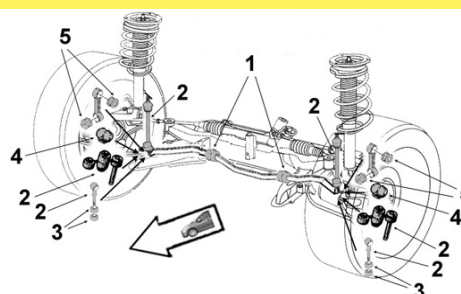

RENAULT
SAS

4005148 OE 7700437136	Biellette barre stab. <i>Stabilizer bar stub axle</i>	4005129 OE 7700847382	Palier de barre bout <i>End bar main bearing</i>
 2	1.9 DCi 4WD JA05/13/1S 2.0i 16v. 4WD JA0C	 2	1.4i JA0E -06/10/97 1.6i JA0F/OL -06/10/97 1.9 D JA0J -06/10/97 1.9 TD FA0Y JA0Y -06/10/97 2.0i JA0G -06/10/97
4001475 OE 7700784170	Palier de barre bout <i>End bar main bearing</i>	4005151 OE 8200150759	Palier de barre bout <i>End bar main bearing</i>
 4 Barre Ø 23	1.4i JA0E 06/10/97-13/05/98 1.6i JA0L 06/10/97-13/05/98 1.6i JA0F BVM 06/10/97-13/05/98	 4	1.4i JA0E 13/05/98- 1.4i 16v. JA0D/0W/10/1H 1.6i JA0L 13/05/98- 1.6i JA0F BVM 13/05/98-
4001522 OE 7700784171	Palier de barre bout <i>End bar main bearing</i>	2304005 OE 8200150768	Palier de barre bout <i>End bar main bearing</i>
 4 Barre Ø 24	1.6i JA0F BVA 06/10/97-13/05/98 1.9 D JA0J 06/10/97-13/05/98 1.9 D FA0J -13/05/98 1.9 DTi JA0N 06/10/97-13/05/98 1.9 DTi FA0N -13/05/98 1.9 TD FA0Y 06/10/97-13/05/98 1.9 TD JA0K/0Y 06/10/97- 2.0i JA0G 06/10/97-13/05/98	 4	1.6i JA0F BVA 13/05/98- 1.6i 16v. JA0B/00/04 1.9 DTi F/JA0N 13/05/98- 1.9 TD F/JA0J 13/05/98- 2.0i JA0G 13/05/98- 2.0i 16v. JA1B
4001476 OE 7700785788	Palier de barre milieu <i>Middle bar main bearing</i>	4001553 OE 7700428665	Palier de barre milieu <i>Middle bar main bearing</i>
 1 Barre Ø 23	1.4i JA0E 06/10/97-13/05/98 1.6i JA0L 06/10/97-13/05/98 1.6i JA0F BVM 06/10/97-13/05/98	 1 Barre Ø 23.5	1.4i JA0E 13/05/98- 1.4i 16v. JA0D/0W/10/1H 1.6i JA0L 13/05/98- 1.6i JA0F BVM 13/05/98-
4001517 OE 7700835929	Palier de barre milieu <i>Middle bar main bearing</i>		
 1 Barre Ø 24	1.4i JA0E -06/10/97 1.6i JA0L -06/10/97 1.6i JA0F BVM -06/10/97 1.6i JA0F BVA 06/10/97-13/05/98 1.9 D JA0J 06/10/97-13/05/98 1.9 D FA0J -13/05/98 1.9 DCi 4WD JA05 1.9 DTi JA0N 06/10/97-13/05/98 1.9 DTi FA0N -13/05/98 1.9 TD JA0K/0Y 06/10/97- 1.9 TD FA0Y 06/10/97-13/05/98 2.0i JA0G 06/10/97-13/05/98 2.0i 16v. 4WD JA0C/13/1S		

... Scenic I -04/03 ...



Barre stabilisatrice
 Stabilizer bar
 Barra estabilizadora
 Drażek stabilizatora
 стабилизатор поперечной устойчивости

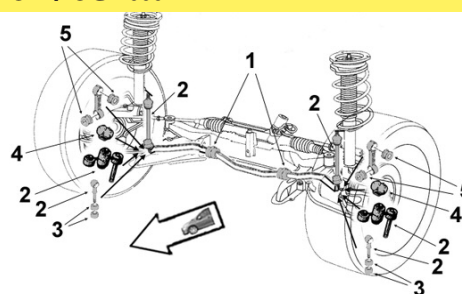

RENAULT



4001554 **Palier de barre milieu**
 OE 7700428738 *Middle bar main bearing*



1	Barre Ø 24.5			
	1.6i	JA0F	BVA	13/05/98-
	1.6i 16v.	JA0B/00/04/11/1J		
	1.8i 16v.	JA12/1A/1M/1R		
	1.9 D	FA0J	JA0J	13/05/98-
	1.9 DCi	JA01		
	1.9 DCi 2WD	JA05/1F		
	1.9 DTi	FA0N	JA0N	13/05/98-
	1.9 DTi	JA1U		
	1.9 TD	FA0Y		13/05/98-
	2.0i	JA0G		13/05/98-
	2.0i 16v.	JA1B/1L		
	2.0i 16v. 2WD	JA0C/13/1S		

4001518 **Palier de barre milieu**
 OE 7700847383 *Middle bar main bearing*



1	Barre Ø 25			
	1.6i	JA0F	BVA	-06/10/97
	1.9 D	JA0J		-06/10/97
	1.9 DTi	JA0N		-06/10/97
	1.9 TD	FA0Y	JA0K/0Y	-06/10/97
	2.0i	JA0G		-06/10/97

4005086 **Kit rép. barre stab. G et D**
 OE - *L R Stabilizing bar repair kit*

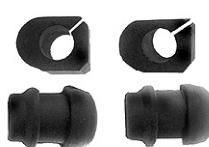

Barre Ø 24
 TT /all models FA0 JA0 JA1

4005070 **Kit rép. barre stab. G et D**
 OE - *L R Stabilizing bar repair kit*



Barre Ø 25
 TT /all models FA0 JA0 JA1



Eléments SUSPENSION
 Suspension parts
 Elementos suspensión
 Elementy zawieszenie
 Элементы подвески

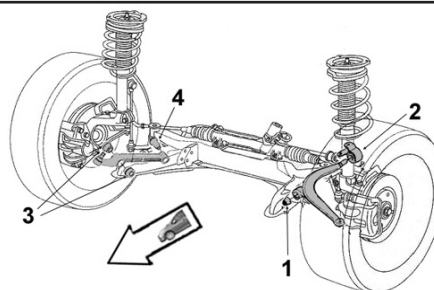

4001413 **Articulation AV/AR**
 OE 8200651163 *Front rear bush*









1	Ø int.12 Ø ext.45 long. tube int.46 ext.34.5			
2	1.4i /16v.	JA0E	JA0D/0W/10/1H	
	1.6i /16v.	JA0F/0L	JA00/04/0B/11/1J	
	1.8i 16v.	JA12/1A/1M/1R		
	1.9 D	FA0J	JA0J	
	1.9 DCi	JA01		
	1.9 DCi 2WD	JA05	BVM	
	1.9 DCi 2WD	JA05	BVA	13/12/00-
	1.9 DTi	FA0N	JA1U	JA0N BVM
	1.9 DTi	JA0N	BVA	13/12/00-
	1.9 TD	FA0Y	JA0K/0Y	
	2.0i /16v.	JA0G	JA1D	
	2.0i 16v. 2WD	JA13/1S		
	2.0i 16v. / 2WD	JA0C	JA1B/1L	13/12/00-



... Scenic I -04/03 ...



RENAULT





4001529 OE 8200651169	Articulation AV/AR <i>Front rear bush</i>	4005502 OE 8200033379	Articulation AV/AR <i>Front rear bush</i>
	1 2 Ø int.12 Ø ext.45 long. tube int.46 ext.35 1.9 DTi JA0N BVA -13/12/00 2.0i 16v. 2WD JA0C -13/12/00 2.0i 16v. JA1B/1L -13/12/00		1 2 Ø int.12 Ø ext.45 coll.47.8 long. tube int.46 ext.29 ep. Coll.4.1 1.9 DCi 4WD JA05 2.0i 16v. 4WD JA0C/13/1S

Bras & Triangle de suspension <i>Control arm</i> <i>Brazo y triángulo</i> <i>Wahacz</i> <i>Рычаг подвески</i>	G/L  D/R	 2  4	1  3 
--	---	--	--

4003358 OE 7700831368	Triangle de susp. G <i>Left track control arm</i>	4003357 OE 7700831369	Triangle de susp. D <i>Right track control arm</i>
	4 Avec rotule With ball joint TT /all models JA0B/0D/0W/0Y/00/04 1.4i JA0E 06/10/97- 1.6i JA0F/0L 06/10/97- 1.9 D FA0J 1.9 D JA0J 06/10/97- 1.9 DCi JA05/4X2 1.9 DTi JA0N BVM 1.9 DTi JA0N BVA 13/12/00- 1.9 TD JA0K/Y FA0Y 06/10/97- 2.0i JA0G 06/10/97- 2.0i 16v. JA1B 13/12/00-		3 Avec rotule With ball joint TT /all models JA0B/0D/0W/0Y/00/04 1.4i JA0E 06/10/97- 1.6i JA0F/0L 06/10/97- 1.9 D FA0J 1.9 D JA0J 06/10/97- 1.9 DCi JA05/4X2 1.9 DTi JA0N BVM 1.9 DTi JA0N BVA 13/12/00- 1.9 TD JA0K/Y FA0Y 06/10/97- 2.0i JA0G 06/10/97- 2.0i 16v. JA1B 13/12/00-

4003360 OE 8200737112	Triangle de susp. G <i>Left track control arm</i>	4003359 OE 8200737114	Triangle de susp. D <i>Right track control arm</i>
	4 Avec rotule With ball joint 1.9 DTi JA0N BVA -13/12/00 1.9 DTi FA0N 2.0i 16v. JA0C JA1D/L/S/3 2.0i 16v. JA1B -13/12/00 2.0i 16v. RX4 JA0C JA1S/3		3 Avec rotule With ball joint 1.9 DTi JA0N BVA -13/12/00 1.9 DTi FA0N 2.0i 16v. JA0C JA1D/L/S/3 2.0i 16v. JA1B -13/12/00 2.0i 16v. RX4 JA0C JA1S/3

4005273 OE 7701468411	Rotule de susp. inf. G/D <i>L/R lower suspension ball joint</i>		
	1 2 Trous fixation Ø10 1.9 D FA0J 06/10/97- 1.9 DCi JA05/4X2 06/10/97- 1.9 DTi FA0N 06/10/97- 1.9 TD FA0Y 06/10/97- TT /all models JA0B/0D/0E/0F/0G/0J/0K/0L/0N/0W/0Y/00/04/1B 06/10/97-		

4005277 Part/oe 8200942407	Rotule de susp. inf. G/D <i>L/R lower suspension ball joint</i>		
	1 2 Trous fixation Ø12 1.4i JA0E 06/10/97- 1.6i JA0F/0L 06/10/97- 1.9 D FA0J 1.9 D JA0J 06/10/97- 1.9 DCi JA05/4X2 1.9 DTi FA0N 1.9 DTi JA0N 06/10/97- 1.9 TD FA0Y JA0K/Y 06/10/97- 2.0i JA0G 06/10/97- TT /all models JA0B/0D/0W/00/04/1B		

... Scenic I -04/03 ...



RENAULT



Support d'amortisseur
 Suspension mounting
 Soporte amortiguador
 Poduszka amortyzatora
 Опора амортизатора

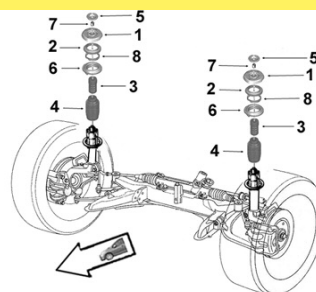

4001604

Support suspension G/D

OE 7700835254

L/R suspension mounting



1 1.4i/ 16v. JA0E JA0D/0W/10/1H
 1.6i/ 16v. JA0F/0L JA00/04/0B/11/1J
 1.8i 16v. JA12/1A/1M/1R
 1.9 D FA0J JA0J
 1.9 DCi JA01/05/1F
 1.9 DTi FA0N JA0N/1U
 1.9 TD FA0Y JA0K/0Y
 2.0i JA0G
 2.0i 16v. JA0C/13/1B/1D/1L/1S

4005301

Butée à billes G/D

OE 7700777654

L/R ball bearing



2 1.4i /16v. JA0E JA0D/0W/10/1H
 1.6i/ 16v. JA0F/0L JA00/04/0B/11/1J
 1.8i 16v. JA12/1A/1M/1R
 1.9 D FA0J JA0J
 1.9 DCi JA01/05/1F
 1.9 DTi FA0N JA0N/1U
 1.9 TD FA0Y JA0K/0Y
 2.0i JA0G
 2.0i 16v. JA0C/13/1B/1D/1L/1S

4001609

Butée de suspension G/D

OE 7704000661

L/R suspension bush



3
 TT /all models
 Sauf 1.9 DCi 4WD types JA05/1F
 Sauf 2.0i 16v. 4WD types JA0C/13/1S

4001643

Butée de suspension G/D

OE 7700437911

L/R suspension bush



3
 1.9 DCi 4WD JA05/1F
 2.0i 16v. 4WD JA0C/13/1S

4005372

Protecteur amortisseur G/D

OE 7700776743

L/R shock absorber protector



4
 TT /all models
 Sauf 1.9 DCi 4WD types JA05/1F
 Sauf 2.0i 16v. 4WD types JA0C/13/1S



Barre stabilisatrice
 Stabilizer bar
 Barra estabilizadora
 Drążek stabilizatora
 стабилизатор поперечной устойчивости

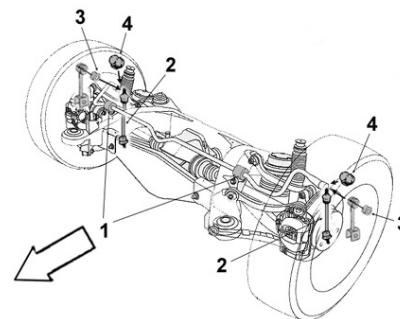

4005149

Biellette barre stab.

OE 7700436706

Stabilizer bar stub axle



2
 1.9 DCi 4WD JA05/1F
 2.0i 16v. 4WD JA13/1S/0C

... Scenic I -04/03 ...



Eléments SUSPENSION

Suspension parts

Elementos suspensión

Elementy zawieszenie

Элементы подвески

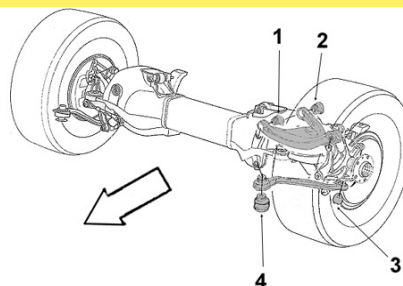

RENAULT



4001587

Articulation

OE 7700436707

Bush



1 Ø int.12 Ø ext.40 coll.50 long. tube int.60 ext.43 ep. coll.7
2

1.9 DCi 4WD
2.0i 16v. 4WD

JA05/1F
JA13/1S/0C



Support d'amortisseur

Suspension mounting

Soporte amortiguador

Poduszka amortyzatora

Опора амортизатора

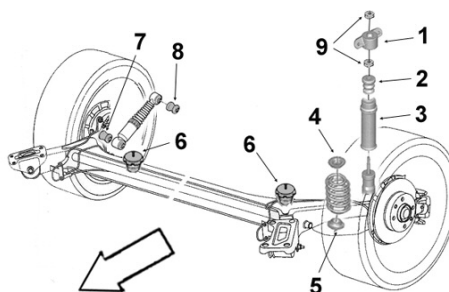

4005534

Butée de talonnage

OE 7700436705

Bushing



6 H74

1.9 DCi 4WD
2.0i 16v. 4WD

JA05/1F
JA13/1S/0C

Eléments TRAIN ARRIERE

Rear axle parts

Tren TRAS

Elementy zawieszenia tylnego

элементы задней оси.



4003385

Articulation

OE 7700762844

Bush



Ø int.32 Ø ext.72 long. tube int.73 ext.37

1.4i	JA0E		-27/10/97
1.6i	JA0F/0L		-27/10/97
1.9 D	JA0J		-27/10/97
1.9 DTi	JA0N		-27/10/97
1.9 TD	FA0Y	JA0K/0Y	-27/10/97
2.0i	JA0G		-27/10/97

... Scenic I -04/03

Eléments TRAIN ARRIERE

Rear axle parts

Tren TRAS

Elementy zawieszenia tylnego

элементы задней оси.



RENAULT



4003384

Articulation

OE 7700762843

Bush



Ø int.32 Ø ext.72 long.tube int.73 ext.37

1.4i	JA0E	27/10/97-
1.4i 16v.	JA0D/0W/10/1H	
1.6i	JA0F/0L	27/10/97-
1.6i 16v.	JA0B/00/04/11/1J	
1.8i 16v.	JA12/1A/1M/1R	
1.9 D	JA0J	27/10/97-
1.9 D	FA0J	
1.9 DCi	JA01	
1.9 DCi 2WD	JA05/1F	
1.9 DTi	JA0N	27/10/97-
1.9 DTi	FA0N JA1U	
1.9 TD	FA0Y JA0K/0Y	27/10/97-
2.0i	JA0G	27/10/97-
2.0i 16v.	JA1B/1D/1L	
2.0i 16v. 2WD	JA13/1S/0C	

4005526

Articulation berceau

OE 8200739838

Cradle bush



Ø int. 19 Ø ext.69.5 coll.83 long. tube int. 85.5 ext.66 ep. coll.14

1.9 DCi 4WD	JA05/1F
2.0i 16v. 4WD	JA13/1S/0C

Scenic II 05/03-03/09 ...

Eléments DIRECTION

Steering parts

Elementos Direcciones

Elementy uklad kierowniczy

Элементы рулевой системы

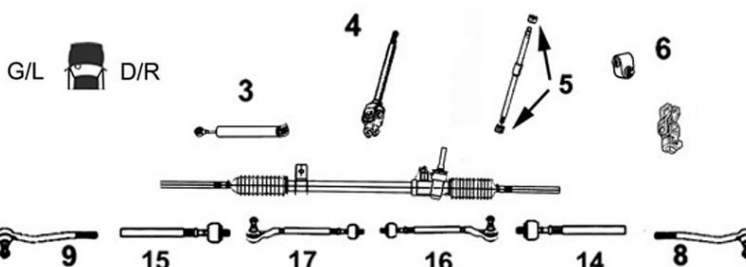

3008242

Axe de bielle G/D

Part/oe 7701474448

L/R axial joint



14 Côté dir. M14x1.5 Côté rot. M14x1.5 long 211 mm
15

1.4i 16v.
1.5 DCi
1.6i 16v.
1.9 DCi
2.0i 16v.
2.0 DCi

... Scenic II 05/03-03/09 ...

RENAULT



<p>4006161 Rotule de direction G OE 7701474795 <i>Left tie rod end</i></p>	<p>4006159 Rotule de direction D OE 7701474796 <i>Right tie rod end</i></p>
<p>9</p>	<p>8</p>
<p>1.4i 16v. 1.5 DCi 1.6i 16v. 1.9 DCi 2.0i 16v. 2.0 DCi</p>	<p>1.4i 16v. 1.5 DCi 1.6i 16v. 1.9 DCi 2.0i 16v. 2.0 DCi</p>

Barre stabilisatrice
Stabilizer bar
Barra estabilizadora
Drażek stabilizatora
 стабилизатор поперечной устойчивости

<p>4005146 OE 8200669065</p>	<p>Biellette barre stab. <i>Stabilizer bar stub axle</i></p>	<table border="0" style="width: 100%;"> <tr> <td style="width: 10%; text-align: center;">2</td> <td style="width: 40%;">1.4i 16v.</td> <td style="width: 30%;">JM0B/0H/1A</td> <td style="width: 20%;">07/03-</td> </tr> <tr> <td></td> <td>1.5 DCi Sans susp. renf. réhaussée</td> <td>JM02/0F</td> <td>07/03-</td> </tr> <tr> <td></td> <td>1.6i 16v.</td> <td>JM0Y/1Y</td> <td>07/03-</td> </tr> <tr> <td></td> <td>1.6i 16v. Sauf Susp. renf. réhaussée</td> <td>JM0C/0J/1B</td> <td>07/03-</td> </tr> <tr> <td></td> <td>1.6i 16v. Sauf équipement EA6</td> <td>JM1R</td> <td>09/06-</td> </tr> <tr> <td></td> <td>1.9 DCi</td> <td>JM1G</td> <td>07/03-</td> </tr> <tr> <td></td> <td>1.9 DCi Sans susp. renf. réhaussée</td> <td>JM0G</td> <td>07/03-</td> </tr> <tr> <td></td> <td>2.0i 16v.</td> <td>JM0W</td> <td>07/03-</td> </tr> <tr> <td></td> <td>2.0i 16v. Sans susp. renf. réhaussée</td> <td>JM05/0U/1N</td> <td>07/03-</td> </tr> <tr> <td></td> <td>2.0 DCi</td> <td>JM1K</td> <td></td> </tr> </table>	2	1.4i 16v.	JM0B/0H/1A	07/03-		1.5 DCi Sans susp. renf. réhaussée	JM02/0F	07/03-		1.6i 16v.	JM0Y/1Y	07/03-		1.6i 16v. Sauf Susp. renf. réhaussée	JM0C/0J/1B	07/03-		1.6i 16v. Sauf équipement EA6	JM1R	09/06-		1.9 DCi	JM1G	07/03-		1.9 DCi Sans susp. renf. réhaussée	JM0G	07/03-		2.0i 16v.	JM0W	07/03-		2.0i 16v. Sans susp. renf. réhaussée	JM05/0U/1N	07/03-		2.0 DCi	JM1K	
2	1.4i 16v.	JM0B/0H/1A	07/03-																																							
	1.5 DCi Sans susp. renf. réhaussée	JM02/0F	07/03-																																							
	1.6i 16v.	JM0Y/1Y	07/03-																																							
	1.6i 16v. Sauf Susp. renf. réhaussée	JM0C/0J/1B	07/03-																																							
	1.6i 16v. Sauf équipement EA6	JM1R	09/06-																																							
	1.9 DCi	JM1G	07/03-																																							
	1.9 DCi Sans susp. renf. réhaussée	JM0G	07/03-																																							
	2.0i 16v.	JM0W	07/03-																																							
	2.0i 16v. Sans susp. renf. réhaussée	JM05/0U/1N	07/03-																																							
	2.0 DCi	JM1K																																								

<p>2304002 OE 8200669066</p>	<p>Biellette barre stab. <i>Stabilizer bar stub axle</i></p>	<table border="0" style="width: 100%;"> <tr> <td style="width: 10%; text-align: center;">2</td> <td style="width: 40%;">1.5 DCi susp. normale</td> <td style="width: 30%;">JM0T</td> <td style="width: 20%;"></td> </tr> <tr> <td></td> <td>1.5 DCi susp. renforcée réhaussée</td> <td>JM02/0F</td> <td></td> </tr> <tr> <td></td> <td>1.6i 16v.</td> <td>JM2Y</td> <td></td> </tr> <tr> <td></td> <td>1.6i 16v. susp. renforcée réhaussée</td> <td>JM0C/1B</td> <td></td> </tr> <tr> <td></td> <td>1.6i 16v. Equipement EA6</td> <td>JM1R</td> <td>09/06-</td> </tr> <tr> <td></td> <td>1.9 DCi susp. normale</td> <td>JM12</td> <td></td> </tr> <tr> <td></td> <td>1.9 DCi susp. renforcée réhaussée</td> <td>JM0G</td> <td></td> </tr> <tr> <td></td> <td>2.0i 16v. susp. normale</td> <td>JM0S/1M/2T/2V</td> <td></td> </tr> <tr> <td></td> <td>2.0i 16v. susp. renforcée réhaussée</td> <td>JM05/0U</td> <td></td> </tr> </table>	2	1.5 DCi susp. normale	JM0T			1.5 DCi susp. renforcée réhaussée	JM02/0F			1.6i 16v.	JM2Y			1.6i 16v. susp. renforcée réhaussée	JM0C/1B			1.6i 16v. Equipement EA6	JM1R	09/06-		1.9 DCi susp. normale	JM12			1.9 DCi susp. renforcée réhaussée	JM0G			2.0i 16v. susp. normale	JM0S/1M/2T/2V			2.0i 16v. susp. renforcée réhaussée	JM05/0U	
2	1.5 DCi susp. normale	JM0T																																				
	1.5 DCi susp. renforcée réhaussée	JM02/0F																																				
	1.6i 16v.	JM2Y																																				
	1.6i 16v. susp. renforcée réhaussée	JM0C/1B																																				
	1.6i 16v. Equipement EA6	JM1R	09/06-																																			
	1.9 DCi susp. normale	JM12																																				
	1.9 DCi susp. renforcée réhaussée	JM0G																																				
	2.0i 16v. susp. normale	JM0S/1M/2T/2V																																				
	2.0i 16v. susp. renforcée réhaussée	JM05/0U																																				

<p>2304016 OE 7701059966</p>	<p>Palier de barre milieu <i>Middle bar main bearing</i></p>	<table border="0" style="width: 100%;"> <tr> <td style="width: 10%; text-align: center;">1</td> <td style="width: 40%;">Ø21</td> <td style="width: 30%;"></td> <td style="width: 20%;"></td> </tr> <tr> <td></td> <td>1.4i 16v.</td> <td>JM0B/0H/1A/1S</td> <td></td> </tr> <tr> <td></td> <td>1.5 DCi</td> <td>JM1F</td> <td></td> </tr> <tr> <td></td> <td>1.5 DCi Sauf équipement EA6</td> <td>JM16</td> <td></td> </tr> <tr> <td></td> <td>1.5 DCi Susp. normale</td> <td>JM02/0F</td> <td>-09/06</td> </tr> <tr> <td></td> <td>1.5 DCi</td> <td>JM02/0F</td> <td>09/06-</td> </tr> <tr> <td></td> <td>1.5 DCi Sauf équipement EA6</td> <td>JM13/1E</td> <td>09/06-</td> </tr> <tr> <td></td> <td>1.5 DCi</td> <td>JM0T</td> <td>09/06-</td> </tr> <tr> <td></td> <td>1.6i 16v.</td> <td>JM0J/0Y/1Y</td> <td></td> </tr> <tr> <td></td> <td>1.6i 16v. Susp. normale</td> <td>JM0C</td> <td>-09/06</td> </tr> <tr> <td></td> <td>1.6i 16v.</td> <td>JM0C</td> <td>09/06-</td> </tr> <tr> <td></td> <td>1.6i 16v. Sauf équipement EA6</td> <td>JM1R</td> <td>09/06-</td> </tr> <tr> <td></td> <td>1.9 DCi</td> <td>JM1G/15/17/2C</td> <td></td> </tr> <tr> <td></td> <td>1.9 DCi Sauf équipement EA6</td> <td>JM1D</td> <td></td> </tr> <tr> <td></td> <td>1.9 DCi Susp. normale</td> <td>JM0G</td> <td>-09/06</td> </tr> <tr> <td></td> <td>1.9 DCi Susp. renf. réhaussée Châssis long</td> <td>JM0G</td> <td>-09/06</td> </tr> <tr> <td></td> <td>1.9 DCi</td> <td>JM0G</td> <td>09/06-</td> </tr> <tr> <td></td> <td>1.9 DCi Châssis long</td> <td>JM12</td> <td></td> </tr> <tr> <td></td> <td>1.9 DCi</td> <td>JM14</td> <td>-09/06</td> </tr> <tr> <td></td> <td>1.9 DCi Châssis long Equipement EA6</td> <td>JM14</td> <td>09/06-</td> </tr> <tr> <td></td> <td>1.9 DCi Sauf équipement EA6</td> <td>JM14</td> <td>09/06-</td> </tr> <tr> <td></td> <td>2.0i 16v.</td> <td>JM0W/1N/1T/0S/2N</td> <td></td> </tr> <tr> <td></td> <td>2.0i 16v. Sauf équipement EA6</td> <td>JM1U</td> <td></td> </tr> <tr> <td></td> <td>2.0i 16v. Châssis long</td> <td>JM2V</td> <td></td> </tr> <tr> <td></td> <td>2.0i 16v. Susp. normale</td> <td>JM0U</td> <td></td> </tr> <tr> <td></td> <td>2.0i 16v. Susp. renf. réhaussée Châssis long</td> <td>JM0U</td> <td></td> </tr> <tr> <td></td> <td>2.0i 16v. Susp. normale</td> <td>JM05</td> <td>-09/06</td> </tr> <tr> <td></td> <td>2.0i 16v. Susp. renf. réhaussée Châssis long</td> <td>JM05</td> <td>-09/06</td> </tr> <tr> <td></td> <td>2.0i 16v. Châssis long Equipement EA6</td> <td>JM05</td> <td>09/06-</td> </tr> <tr> <td></td> <td>2.0i 16v. Sauf équipement EA6</td> <td>JM05</td> <td>09/06-</td> </tr> <tr> <td></td> <td>2.0 DCi</td> <td>JM1K</td> <td></td> </tr> </table>	1	Ø21				1.4i 16v.	JM0B/0H/1A/1S			1.5 DCi	JM1F			1.5 DCi Sauf équipement EA6	JM16			1.5 DCi Susp. normale	JM02/0F	-09/06		1.5 DCi	JM02/0F	09/06-		1.5 DCi Sauf équipement EA6	JM13/1E	09/06-		1.5 DCi	JM0T	09/06-		1.6i 16v.	JM0J/0Y/1Y			1.6i 16v. Susp. normale	JM0C	-09/06		1.6i 16v.	JM0C	09/06-		1.6i 16v. Sauf équipement EA6	JM1R	09/06-		1.9 DCi	JM1G/15/17/2C			1.9 DCi Sauf équipement EA6	JM1D			1.9 DCi Susp. normale	JM0G	-09/06		1.9 DCi Susp. renf. réhaussée Châssis long	JM0G	-09/06		1.9 DCi	JM0G	09/06-		1.9 DCi Châssis long	JM12			1.9 DCi	JM14	-09/06		1.9 DCi Châssis long Equipement EA6	JM14	09/06-		1.9 DCi Sauf équipement EA6	JM14	09/06-		2.0i 16v.	JM0W/1N/1T/0S/2N			2.0i 16v. Sauf équipement EA6	JM1U			2.0i 16v. Châssis long	JM2V			2.0i 16v. Susp. normale	JM0U			2.0i 16v. Susp. renf. réhaussée Châssis long	JM0U			2.0i 16v. Susp. normale	JM05	-09/06		2.0i 16v. Susp. renf. réhaussée Châssis long	JM05	-09/06		2.0i 16v. Châssis long Equipement EA6	JM05	09/06-		2.0i 16v. Sauf équipement EA6	JM05	09/06-		2.0 DCi	JM1K	
1	Ø21																																																																																																																													
	1.4i 16v.	JM0B/0H/1A/1S																																																																																																																												
	1.5 DCi	JM1F																																																																																																																												
	1.5 DCi Sauf équipement EA6	JM16																																																																																																																												
	1.5 DCi Susp. normale	JM02/0F	-09/06																																																																																																																											
	1.5 DCi	JM02/0F	09/06-																																																																																																																											
	1.5 DCi Sauf équipement EA6	JM13/1E	09/06-																																																																																																																											
	1.5 DCi	JM0T	09/06-																																																																																																																											
	1.6i 16v.	JM0J/0Y/1Y																																																																																																																												
	1.6i 16v. Susp. normale	JM0C	-09/06																																																																																																																											
	1.6i 16v.	JM0C	09/06-																																																																																																																											
	1.6i 16v. Sauf équipement EA6	JM1R	09/06-																																																																																																																											
	1.9 DCi	JM1G/15/17/2C																																																																																																																												
	1.9 DCi Sauf équipement EA6	JM1D																																																																																																																												
	1.9 DCi Susp. normale	JM0G	-09/06																																																																																																																											
	1.9 DCi Susp. renf. réhaussée Châssis long	JM0G	-09/06																																																																																																																											
	1.9 DCi	JM0G	09/06-																																																																																																																											
	1.9 DCi Châssis long	JM12																																																																																																																												
	1.9 DCi	JM14	-09/06																																																																																																																											
	1.9 DCi Châssis long Equipement EA6	JM14	09/06-																																																																																																																											
	1.9 DCi Sauf équipement EA6	JM14	09/06-																																																																																																																											
	2.0i 16v.	JM0W/1N/1T/0S/2N																																																																																																																												
	2.0i 16v. Sauf équipement EA6	JM1U																																																																																																																												
	2.0i 16v. Châssis long	JM2V																																																																																																																												
	2.0i 16v. Susp. normale	JM0U																																																																																																																												
	2.0i 16v. Susp. renf. réhaussée Châssis long	JM0U																																																																																																																												
	2.0i 16v. Susp. normale	JM05	-09/06																																																																																																																											
	2.0i 16v. Susp. renf. réhaussée Châssis long	JM05	-09/06																																																																																																																											
	2.0i 16v. Châssis long Equipement EA6	JM05	09/06-																																																																																																																											
	2.0i 16v. Sauf équipement EA6	JM05	09/06-																																																																																																																											
	2.0 DCi	JM1K																																																																																																																												

... Scenic II 05/03-03/09 ...



Barre stabilisatrice
 Stabilizer bar
 Barra estabilizadora
 Drążek stabilizatora
 стабилизатор поперечной устойчивости

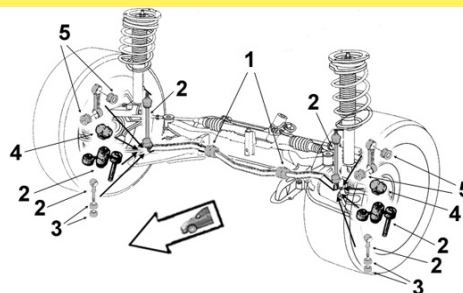

2304015

Palier de barre milieu

OE 7701059672

Middle bar main bearing



1 Ø21

1.5 DCi	JM2A/2B	
1.5 DCi Equipement EA6	JM16	
1.5 DCi	JM0T	-09/06
1.5 DCi Susp. renf. réhaussée	JM02/0F	-09/06
1.5 DCi Equipement EA6	JM13/1E	09/06-
1.6i 16v.	JM2Y	
1.6i 16v. Susp. renf. réhaussée	JM0C	-09/06
1.6i 16v. Equipement EA6	JM1R	09/06-
1.9 DCi Equipement EA6	JM1D	
1.9 DCi Susp. renf. réhaussée Châssis standard	JM0G	-09/06
1.9 DCi Châssis standard	JM12	
1.9 DCi Châssis standard Equipement EA6	JM14	09/06-
2.0i 16v.	JM1M/2T	
2.0i 16v. Equipement EA6	JM1U	
2.0i 16v. Susp. renf. réhaussée Châssis standard	JM0U	
2.0i 16v. Susp. renf. réhaussée Châssis standard	JM05	-09/06
2.0i 16v. Châssis standard	JM2V	
2.0i 16v. Châssis standard Equipement EA6	JM05	09/06-



Eléments SUSPENSION

Suspension parts
Elementos suspensión
Elementy zawieszenie
Элементы подвески

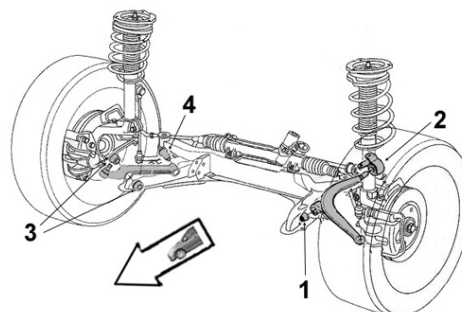

2254002

Articulation AV

Part/oe 8200725673

Front bush



1 Ø int. 12 Ø ext. 33 coll. 43
 long. tube int. 48 ext. 33 ep. coll.4

1.4i 16v.
 1.5 DCi
 1.6i 16v.
 1.9 DCi
 2.0i 16v.
 2.0 DCi

2254003

Articulation AR

Part/oe 8200679067

Rear bush



2 Ø int. 12.5 Ø ext. 58
 long. tube int. 53 ext. 29.5

1.4i 16v.
 1.5 DCi
 1.6i 16v.
 1.9 DCi
 2.0i 16v.
 2.0 DCi

... Scenic II 05/03-03/09 ...

Bras & Triangle de suspension

Control arm
Brazo y triángulo
Wahacz
Рычаг подвески

G/L  D/R

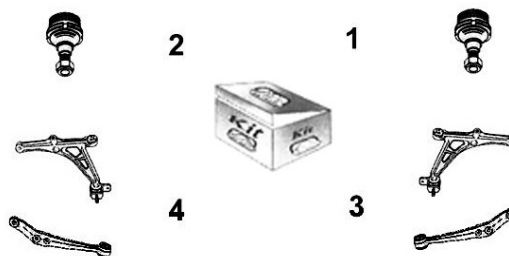

RENAULT



4003221

Triangle de susp. G

Part/oe 8200298454

Left track control arm



4 Sans rotule Without ball joint

1.4i 16v.
1.5 DCi
1.6i 16v.
1.9 DCi
2.0i 16v.
2.0 DCi

4003222

Triangle de susp. D

Part/oe 8200298455

Right track control arm



3 Sans rotule Without ball joint

1.4i 16v.
1.5 DCi
1.6i 16v.
1.9 DCi
2.0i 16v.
2.0 DCi

4005280

Rotule de susp. inf. G/D

Part/oe 8200346941

L/R lower suspension ball joint



1 Ø 18
2

1.4i 16v.
1.5 DCi
1.6i 16v.
1.9 DCi
2.0i 16v.
2.0 DCi

7964001

Kit rép. triangle susp. G et D

OE -

L or R Track control arm bearing repair kit



Sans visserie Without screws and bolts

1.4i 16v.
1.5 DCi
1.6i 16v.
1.9 DCi
2.0i 16v.
2.0 DCi



Support d'amortisseur

Suspension mounting
Soporte amortiguador
Poduszka amortyzatora
Опора амортизатора

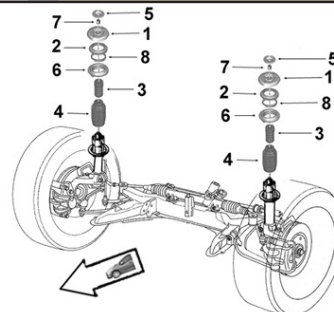

4001645

Support suspension G/D

OE 8200222463

L/R suspension mounting



1

1.4i 16v.
1.5 DCi
1.6i 16v.
1.9 DCi
2.0i 16v.
2.0 DCi

2654012

Butée à billes G/D

OE 8200824774

L/R ball bearing



2

1.4i 16v.
1.5 DCi
1.6i 16v.
1.9 DCi
2.0i 16v.
2.0 DCi

4001629

Butée protecteur susp.

OE 8200040073

Suspension bush



3

1.4i 16v.

4

1.5 DCi Châssis long avec susp. renf. réhaussée
1.5 DCi Châssis standard
1.5 DCi Châssis standard
1.6i 16v.
1.6i 16v. Châssis long avec susp. renf. réhaussée
1.6i 16v. Châssis standard
1.9 DCi Châssis long avec susp. renf. réhaussée
1.9 DCi Châssis long avec susp. renf. réhaussée
1.9 DCi Châssis standard
1.9 DCi Châssis standard
2.0i 16v.
2.0i 16v. Châssis long avec susp. renf. réhaussée
2.0i 16v. Châssis standard
2.0 DCi Châssis standard

JM0B/0H/1A/1S

JM02

JM0F/13/0T/1F/2A/2B

JM02/1E/16

JM0Y/1Y/2Y

JM1B

JM0C/0J/1B/1R

JM0G/2C

JM12

JM0G/1G/14/15/17/1D/2C

JM1M/0S/2N/2T/2V

JM05/0U

JM05/0U/0W/1N/1T/1U

JM1K

... Scenic II 05/03-03/09 ...



Support d'amortisseur

Suspension mounting
Soporte amortiguador
Poduszka amortyzatora
Опора амортизатора

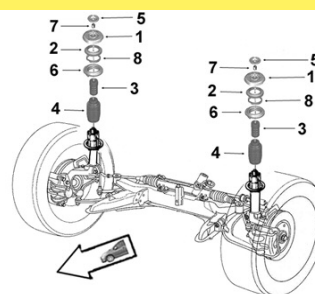

2654018

Butée protecteur susp.

OE 8200411123

Suspension bush



3
4

1.5 DCi	Châssis long	JM1E/16
1.5 DCi	Châssis long avec susp. normale	JM02
1.6i 16v.	Châssis long	JM0C/0J/1R
1.6i 16v.	Châssis long avec susp. normale	JM1B
1.9 DCi	Châssis long	JM1G/14/15/17/1D
1.9 DCi	Châssis long avec susp. normale	JM0G/2C
2.0i 16v.	Châssis long	JM0W/1N/1T/1U
2.0i 16v.	Châssis long avec susp. normale	JM05/0U
2.0 DCi	Châssis long	JM1K

2954002

Kit rép. suspension G ou D

OE 7701208891

L/R stabilizing bar repair kit



1.4i 16v.
1.5 DCi
1.6i 16v.
1.9 DCi
2.0i 16v.
2.0 DCi



Barre stabilisatrice

Stabilizer bar
Barra estabilizadora
Drażek stabilizatora
стабилизатор поперечной устойчивости

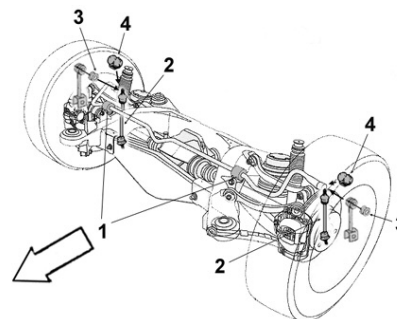

2304023

Palier de barre milieu

OE 7701063888

Middle bar main bearing



1

2.0 DCi

... Scenic II 05/03-03/09



Support d'amortisseur
Suspension mounting
Soporte amortiguador
Poduszka amortyzatora
Опора амортизатора

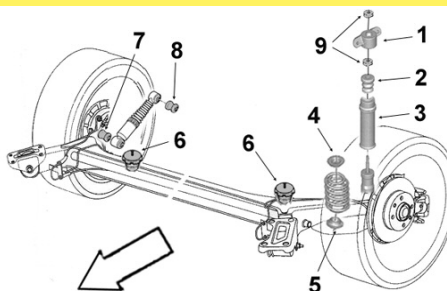

RENAULT



4005518 Butoir de suspension

OE 8200038285 *Bushing*



4	1.4i 16v.		JM0B/0H/1A	07/03-
	1.5 DCi	Châssis standard	JM02/13	07/03-
	1.5 DCi		JM0F	07/03-
	1.6i 16v.		JM0Y/1B	07/03-
	1.6i 16v.	Châssis standard	JM0C/0J	07/03-
	1.9 DCi	Châssis standard	JM0G/12/1G	07/03-
	2.0i 16v.		JM1M	07/03-
	2.0i 16v.	Châssis standard	JM05/0U/0W/1N	07/03-

4005508 Butée de choc AR

OE 8200245679 *Rear bumper buffer*



5	1.4i 16v.		JM0B/0H/1A	07/03-
	1.5 DCi	Châssis standard	JM02/13	07/03-
	1.5 DCi		JM0F	07/03-
	1.6i 16v.		JM0Y/1B	07/03-
	1.6i 16v.	Châssis standard	JM0C/0J	07/03-
	1.9 DCi	Châssis standard	JM0G/12/1G	07/03-
	2.0i 16v.		JM1M	07/03-
	2.0i 16v.	Châssis standard	JM05/0U/0W/1N	07/03-

4005509 Butée de choc AR

OE 8200380840 *Rear bumper buffer*



5	1.5 DCi	Châssis long	JM02	07/03-
	1.6i 16v.	Châssis long	JM0C/0J	07/03-
	1.9 DCi	Châssis long	JM0G/1G	07/03-
	2.0i 16v.	Châssis long	JM05/0U/0W/1N	07/03-

Eléments TRAIN ARRIERE

Rear axle parts

Tren TRAS

Elementy zawieszenia tylnego

элементы задней оси.



2604006 Articulation essieu

OE 7701479190 *Axle bush*



Ø int.12 Ø ext.69 coll.80 long. tube int.90 ext.58.3 ep. coll. 10.3

TT /all models

Scenic III 04/09- ...

Eléments DIRECTION

Steering parts

Elementos Direcciones

Elementy układ kierowniczy

Элементы рулевой системы

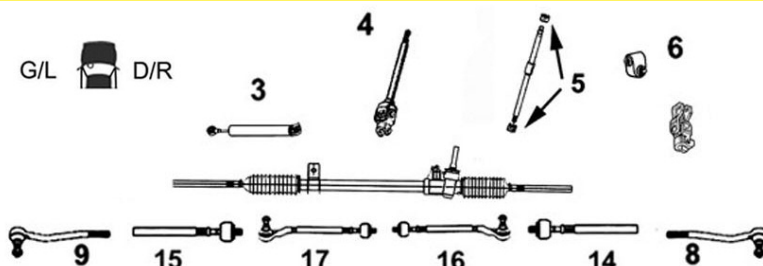

7774013

Axe de bielle G/D

Part/oe 485215612R

L/R axial joint



14 Côté dir. M14x1.5 Côté rot. M14x1.5 long 215 mm

15

1.2 TCE	JZ11/6
1.4i Turbo	JZ0F JZ1V
1.5 DCi	JZ02/7/9/A/B/D JZ1G/M/W/0/4
1.6i 16v.	JZ0U JZ1B/H/U JZ24
1.6i ETH	JZ03 JZ1Y
1.6 DCi	JZ00 JZ12
1.9 DCi	JZ0J/N JZ1J/K/S
2.0i 16v.	JZ0G JZ1E/P
2.0 DCi	JZ0L/Y JZ2A/5/6

7674006

Rotule de direction G

OE 485202710R

Left tie rod end



9 M14x1.5

1.2 TCE	JZ11/6
1.4i Turbo	JZ0F JZ1V
1.5 DCi	JZ02/7/9/A/B/D JZ1G/M/W/0/4
1.6i 16v.	JZ0U JZ1B/H/U JZ24
1.6i ETH	JZ03 JZ1Y
1.6 DCi	JZ00 JZ12
1.9 DCi	JZ0J/N JZ1J/K/S
2.0i 16v.	JZ0G JZ1E/P
2.0 DCi	JZ0L/Y JZ2A/5/6

7674007

Rotule de direction D

OE 485204680R

Right tie rod end



8 M14 x 1.5

1.2 TCE	JZ11/6
1.4i Turbo	JZ0F JZ1V
1.5 DCi	JZ02/7/9/A/B/D JZ1G/M/W/0/4
1.6i 16v.	JZ0U JZ1B/H/U JZ24
1.6i ETH	JZ03 JZ1Y
1.6 DCi	JZ00 JZ12
1.9 DCi	JZ0J/N JZ1J/K/S
2.0i 16v.	JZ0G JZ1E/P
2.0 DCi	JZ0L/Y JZ2A/5/6



Barre stabilisatrice

Stabilizer bar

Barra estabilizadora

Drażek stabilizatora

стабилизатор поперечной устойчивости

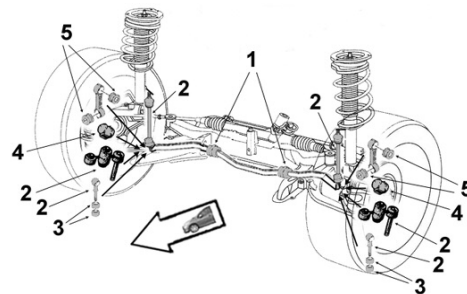

2304019

Biellette barre stab.

OE 546180002R

Stabilizer bar stub axle



2

1.4i Turbo	JZ0F/1V
1.5 DCi	JZ02/09/0A/0D/1G/1M/1W
1.5 DCi	Sauf susp. réhaussée JZ0B
1.6i 16v.	JZ0U/1U
1.6i ETH	JZ03/1Y
1.6 DCi	JZ00
1.9 DCi	JZ0J/0N/1S
2.0i 16v.	JZ0G/1P
2.0 DCi	JZ0L/0Y

... Scenic III 04/09- ...



Eléments SUSPENSION

Suspension parts
Elementos suspensión
Elementy zawieszenie
Элементы подвески

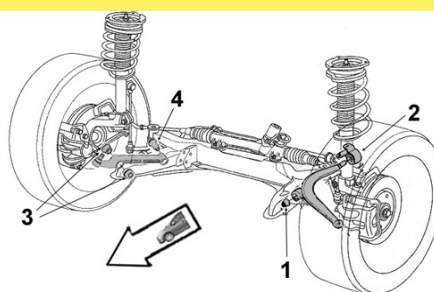

RENAULT



2254010

Articulation AV

Part/oe 545006560R

Front bush



1 Ø int. 18.5 Ø ext. 55 long. tube int. 50.5 ext. 31

1.5 DCi
1.6i /ETH

Bras & Triangle de suspension

Control arm
Brazo y triángulo
Wahacz
Рычаг подвески

G/L D/R



7474010

Triangle de susp. inf. G

OE 545018194R

Lower left track control arm

NEW

4 Avec rotule With ball joint jante tôle 15p.

1.5 DCi	Châssis standard	JZ02/B/D
		JZ1G/M/4
1.5 DCi		JZ0A
1.6i 16v.	Châssis standard	JZ0U/1U
1.6i 16v.		JZ1B/H
1.6i ETH	Châssis standard	JZ03/1Y



7474011

Triangle de susp. inf. D

OE 545008682R

Lower right track control arm

NEW

3 Avec rotule With ball joint jante tôle 15p.

1.5 DCi	Châssis standard	JZ02/B/D
		JZ1G/M/4
1.5 DCi		JZ0A
1.6i 16v.	Châssis standard	JZ0U/1U
1.6i 16v.		JZ1B/H
1.6i ETH	Châssis standard	JZ03/1Y



7574002

Rotule de susp. inf. G/D

Part/oe 545018194R

L/R lower suspension ball joint



1
2

1.5 DCi	JZ02/A/B/D	JZ1G/M/4
1.6i 16v.	JZ0U	JZ1B/H/U
1.6i ETH	JZ03	JZ1Y

... Scenic III 04/09-



Support d'amortisseur
 Suspension mounting
 Soporte amortiguador
 Poduszka amortyzatora
 Опора амортизатора

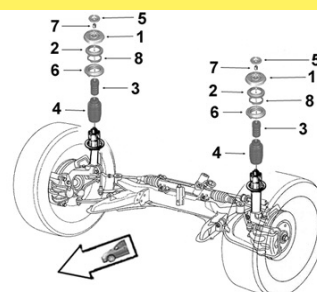

2654019

Support suspension G/D

OE 540340002R

L/R suspension mounting



1

1.4i Turbo	JZ0F/1V
1.5 DCi	JZ02/07/09/0A/0B/0D
	JZ1G/1M/1W
1.6i 16v./Turbo	JZ03/0U/1B/1H/1U/1Y
1.6 DCi	JZ00
1.9 DCi	JZ0J/0N/1K/1S
2.0i 16v.	JZ0G/1D/1E/1P
2.0 DCi	JZ0L/0Y

2654023

Butée à billes G/D

OE 543256557R

L/R ball bearing



2

1.2 TCE	JZ11
1.4i Turbo	JZ0F/1V
1.5 DCi	JZ02/07/09/0A/0B/0D
	JZ1G/1M/1W/14
1.6i 16v.	JZ0U/1B/1H/1U
1.6i ETH	JZ03/1Y
1.6 DCi	JZ00/12
1.9 DCi	JZ0J/0N/1J/1K/1S
2.0i 16v.	JZ0G/1D/1E/1P
2.0 DCi	JZ0L/0Y

Talisman



Support d'amortisseur
 Suspension mounting
 Soporte amortiguador
 Poduszka amortyzatora
 Опора амортизатора

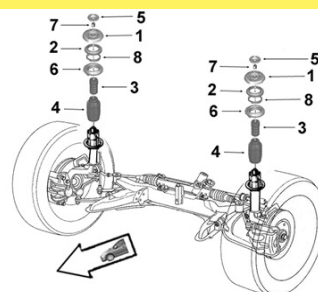

2654023

Butée à billes G/D

OE 543256557R

L/R ball bearing



2

2.5i V6	L2MD/MF	06/12-
3.5i V6	L2MB/MC	06/12-

Thalia Symbol I (LB) ...

Eléments DIRECTION

Steering parts

Elementos Direcciones

Elementy uklad kierowniczy

Элементы рулевой системы

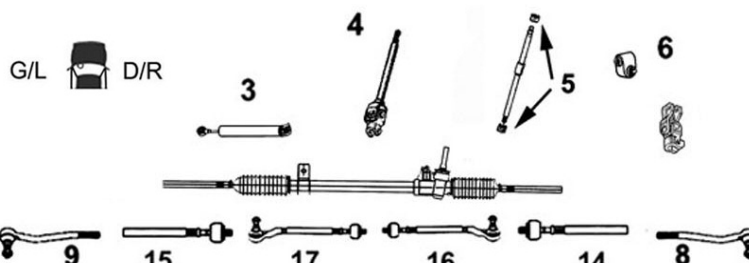

3008035

Axe de bielle G/D

Part/oe 7701472113

L/R axial joint



14 Côté dir. M12x1.0 Côté rot. M14x1.5
15 long 303 mm DNA

1.2i 16v.	LB11/19/1Y/2V/27/2U
1.4i	LB03/0B/17
1.5 DCi	LB1W/24/29

3008040

Axe de bielle G/D

Part/oe 7701472120

L/R axial joint











14 Côté dir. M12x1.0 Côté rot. M14x1.5
15 long 305 mm DA SMI

1.2i 16v.
1.4i/ 16v.
1.5 DCi
1.6
1.6i 16v.
1.9 D

... Thalia Symbol I (LB) ...

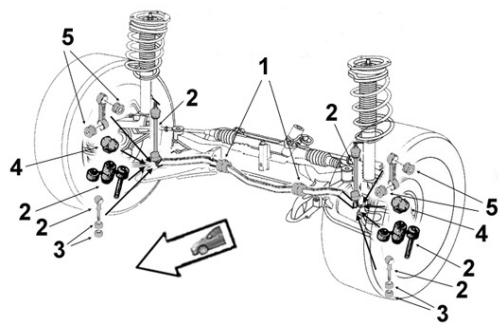
RENAULT

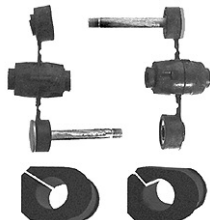

3008055 Axe de bielle G/D	
Part/oe 7701472735 <i>L/R axial joint</i>	
	14 Côté dir. M14x1.5 Côté rot. M14x1.5 long 294 mm DA TRW 15 1.2i 16v. 1.4i /16v. 1.5 DCi 1.6 1.6i 16v. 1.9 D
4006134 Rotule de direction G	4006135 Rotule de direction D
OE 7701474641 <i>Left tie rod end</i>	OE 7701047813 <i>Right tie rod end</i>
	
9 Dir. SMI TRW 1.2i 16v. 1.4i 1.4i 16v. 1.5 DCi 1.6 1.6i 16v. 1.9 D	8 Dir. SMI TRW 1.2i 16v. 1.4i 1.4i 16v. 1.5 DCi 1.6 1.6i 16v. 1.9 D
 Barre stabilisatrice Stabilizer bar Barra estabilizadora Drażek stabilizatora стабилизатор поперечной устойчивости	
	
4001505 Palier de barre bout	2304021 Palier de barre bout
OE 7700799404+7703034237 <i>End bar main bearing</i>	OE 8200891487+7703034237 <i>End bar main bearing</i>
	
2 1.2i 16v. LB11/19/1Y/2V -24/09/08 1.4i LB03/0B/17 -24/09/08 1.4i 16v. LB0K/0L/13/2A/2B -24/09/08 1.5 DCi LB07/1W/23/24/2E -24/09/08 1.6i LB00 -24/09/08 1.6i 16v. LB01/18/1B/1J/1V -24/09/08 1.9 D LB02 -24/09/08	2 1.2i 16v. 24/09/08- 1.4i 16v. 24/09/08- 1.5 DCi 24/09/08-
4001476 Palier de barre milieu	4001517 Palier de barre milieu
OE 7700785788 <i>Middle bar main bearing</i>	OE 7700835929 <i>Middle bar main bearing</i>
	
1 Barre Ø 23 1.2i 16v. LB11/19/2V 1.4i LB03/0B/17 1.6i LB00 1.9 D /Comm. LB02	1 Barre Ø 24 1.4i 16v. LB0K/13/2A/2B 1.5 DCi LB07/1W/24/2E 1.6i 16v. LB01/18/1B/1J/1V
4005078 Kit rép. barre stab. G et D	
OE - <i>L R Stabilizing bar repair kit</i>	
	Barre percée Ø 23 1.2i 16v. LB11/19/2V 1.4i LB03/0B/17 1.6i LB00

... Thalia Symbol I (LB) ...



Eléments SUSPENSION
Suspension parts
Elementos suspensión
Elementy zawieszenia
Элементы подвески

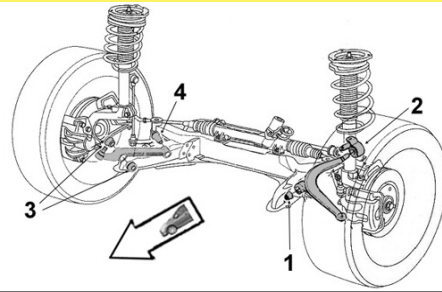

4001540

Articulation AV/AR

OE 7700424399

Front rear bush



1 Ø int.12 Ø ext.45.5 coll.59 long. tube int.46 ext.29.5 ep. coll.4
2

1.2i 16v.	LB11/19/1Y
1.4i	LB03/0B/17
1.4i 16v.	LB0K/0L/13/2A/2B
1.5 DCi	LB07/1W/23/24/2E
1.6i	LB00
1.6i 16v.	LB01/18/1B/1J/1V
1.9 D	LB02

Bras & Triangle de suspension

Control arm
Brazo y triángulo
Wahacz
Рычаг подвески

G/L  D/R



4003367

Triangle de susp. G

OE 8200197179

Left track control arm



4 Avec rotule *With ball joint*

1.2i 16v.	LB11/19/1Y/27/2M/2U
1.4i	LB03/0B/17
1.4i 16v.	LB0K/0L/13/2A/2B/3D
1.5 DCi	LB07/1W/23/24/2E/29
1.6	LB00
1.6i 16v.	LB01/18/1J/1V/26
1.6i 16v.	LB3E/3G/3H
1.9 D	LB02

4003366

Triangle de susp. D

OE 8200197187

Right track control arm



3 Avec rotule *With ball joint*

1.2i 16v.	LB11/19/1Y/27/2M/2U
1.4i	LB03/0B/17
1.4i 16v.	LB0K/0L/13/2A/2B/3D
1.5 DCi	LB07/1W/23/24/2E/29
1.6	LB00
1.6i 16v.	LB01/18/1J/1V/26
1.6i 16v.	LB3E/3G/3H
1.9 D	LB02

4005257

Rotule de susp. inf. G/D

OE 7701468883

L/R lower suspension ball joint



1 Trous fixation Ø10
2

1.0i 16v.	LB06	-18/09/02
1.2i 16v.	LB11/1Y	
1.2i 16v.	LB19	-18/09/02
1.4i /16v.	LB03/0B/17 LB0K/2A/2B	-18/09/02
1.4i 16v.	LB13/0P	
1.5 DCi	LB07	
1.5 DCi	LB1W	-18/09/02
1.6	LB00	
1.6i 16v.	LB01/18/1V/1R	-18/09/02
1.6i 16v.	LB1J	
1.9 D	LB02	

4005277

Rotule de susp. inf. G/D

Part/oe 7700430765

L/R lower suspension ball joint



1 Trous fixation Ø12
2

1.0i 16v.	LB2R/3B	
1.0i 16v.	LB06	19/09/02-
1.2i 16v.	LB27/2U	
1.2i 16v.	LB19	19/09/02-
1.4	LB3K/3P/3S	
1.4i 16v.	LB0L/3D/3R/3T	
1.4i /16v.	LB03/0B/17 LB0K/2A/2B	19/09/02-
1.5 DCi	LB23/24/2E/29/3M/3N	
1.5 DCi	LB1W	19/09/02-
1.6i 16v.	LB1B/26/3E/3G/3H/2K	
1.6i 16v.	LB01/18/1V/1R	19/09/02-

... Thalia Symbol I (LB) ...

RENAULT



1003576 OE - <i>L or R track control arm bearing repair kit</i>	Kit rép. triangle susp. G ou D Avec visserie <i>With screws and bolts</i> 1.2i 16v. LB11/19/1Y 1.4i LB03/0B/17 1.4i 16v. LB0K/0L/13/2A/2B 1.5 DCi LB07/1W/23/24/2E 1.6i LB00 1.6i 16v. LB01/18/1B/1J/1V	105A576S OE -	Kit rép. train AV Front axle repair kit Sans visserie <i>Without screws and bolts</i> 1.2i 16v. LB11/19/2V 1.4i LB03/0B/17 1.6i LB00
---	---	-------------------------	--

7964003 OE -	Kit rép. train AV Front axle repair kit Sans visserie <i>Without screws and bolts</i> 1.2i 16v. LB11/19/1Y 1.4i LB03/0B/17 1.4i 16v. LB0K/0L/13/2A/2B 1.5 DCi LB07/1W/23/24/2E 1.6i LB00 1.6i 16v. LB01/18/1B/1J/1V 1.9 D LB02		
------------------------	--	--	--



Support d'amortisseur
Suspension mounting
Soporte amortiguador
Poduszka amortyzatora
Опора амортизатора

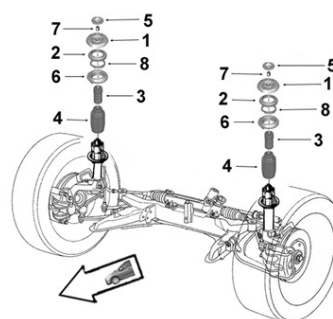

4001620 OE 7700426450	Coupelle rebond. <i>Spring cup</i> 5 1.2i 16v. LB11/19/1Y/2V 1.4i LB03/0B/17 1.4i 16v. LB0K/0L/13/2A/2B 1.5 DCi LB07/1W/23/24/2E 1.6i LB00 1.6i 16v. LB01/18/1B/1J/1V 1.9 D LB02	4001615 OE 7700829529	Tampon suspension G/D <i>L/R susp. rebound stop</i> 1 1.2i 16v. LB11/19/1Y/2V 1.4i LB03/0B/17 1.4i 16v. LB0K/0L/13/2A/2B 1.5 DCi LB07/1W/23/24/2E 1.6i 16v. LB01/18/1B/1J/1V 1.9 D LB02
---------------------------------	---	---------------------------------	---

4005300 OE 8200651172	Butée à billes G/D <i>L/R ball bearing</i> 2 1.2i 16v. LB11/19/1Y/2V 1.4i LB03/0B/17 1.4i 16v. LB0K/0L/13/2A/2B 1.5 DCi LB07/1W/23/24/2E 1.6i LB00 1.6i 16v. LB01/18/1B/1J/1V 1.9 D LB02		
---------------------------------	---	--	--

... Thalia Symbol I (LB)

Eléments TRAIN ARRIERE

Rear axle parts

Tren TRAS

Elementy zawieszenia tylnego

элементы задней оси.



RENAULT



4003324

Articulation AR

OE 8200042594

Rear bush



Ø int.10.3 Ø ext.45.2 coll.65.5 long. tube int.73 ext.51.3 ep. coll.14.6

1.2i 16v.	LB11/19/1Y/2V
1.4i	LB03/0B/17
1.4i 16v.	LB0K/13/2A/2B
1.5 DCi	LB07/1W/23/24/2E
1.6i	LB00
1.6i 16v.	LB01/18/1B/1J/1V
1.9 D	LB02

Thalia Symbol II (LU) ...

Eléments DIRECTION

Steering parts

Elementos Direcciones

Elementy układ kierowniczy

Элементы рулевой системы

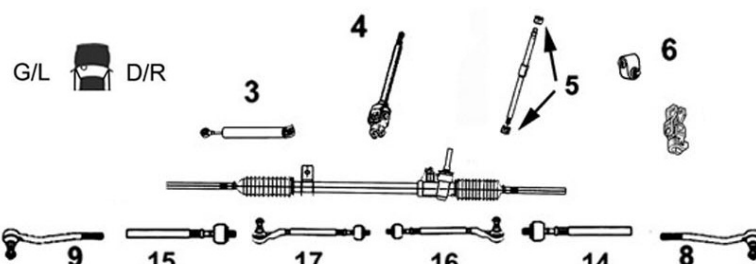

3008035

Axe de bielle G/D

Part/oe 7701472113

L/R axial joint



14 Côté dir. M12x1.0 Côté rot. M14x1.5
15 long 303 mm DNA

1.2i 16v.	LU2U/V/W LU30
1.4i	LU17 LU3K/P/S
1.4i 16v.	LU2B LU3D/R/T
1.5 DCi	LU1W LU24/5 LU3M/N
1.6i	LU02/7
1.6i 16v.	LU01/5/A/C LU1A/B/D/V/8 LU2M

3008055

Axe de bielle G/D

Part/oe 7701472734

L/R axial joint



14 Côté dir. M14x1.5 Côté rot. M14x1.5
15 long 294 mm DA

1.2i 16v.	LU2U/V/W LU30
1.4i	LU17 LU3K/P/S
1.4i 16v.	LU2B LU3D/R/T
1.5 DCi	LU1W LU24/5 LU3M/N
1.6i	LU02/7
1.6i 16v.	LU01/5/A/C LU1A/B/D/V/8 LU2M

4006134

Rotule de direction G

OE 7701474492

Left tie rod end



9

1.2i 16v.	LU2U/V/W LU30
1.4i	LU17 LU3K/P/S
1.4i 16v.	LU2B LU3D/R/T
1.5 DCi	LU1W LU24/5 LU3M/N
1.6i	LU02/7
1.6i 16v.	LU01/5/A/C LU1A/B/D/V/8 LU2M

4006135

Rotule de direction D

OE 7701474493

Right tie rod end



8

1.2i 16v.	LU2U/V/W LU30
1.4i	LU17 LU3K/P/S
1.4i 16v.	LU2B LU3D/R/T
1.5 DCi	LU1W LU24/5 LU3M/N
1.6i	LU02/7
1.6i 16v.	LU01/5/A/C LU1A/B/D/V/8 LU2M

... Thalia Symbol II (LU) ...



Barre stabilisatrice
 Stabilizer bar
 Barra estabilizadora
 Drążek stabilizatora
 стабилизатор поперечной устойчивости

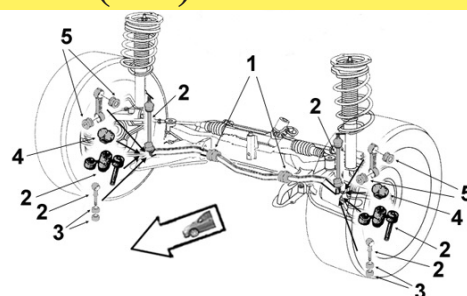

2304021 Palier de barre bout
 OE 8200891487+7703034237 End bar main bearing



2

1.2i 16v.	LU2U/2V/2W/30	29/09/08-
1.4i	LU17/3K/3P/3S	29/09/08-
1.4i 16v.	LU2B/3D/3R/3T	29/09/08-
1.5 DCi	LU1W/24/25/3M/3N	29/09/08-
1.6i	LU02/07	29/09/08-
1.6i 16v.	LU01/05/18/0A/0C/1A/1B/1D/1V/2M	29/09/08-



Eléments SUSPENSION
 Suspension parts
 Elementos suspensión
 Elementy zawieszenie
 Элементы подвески

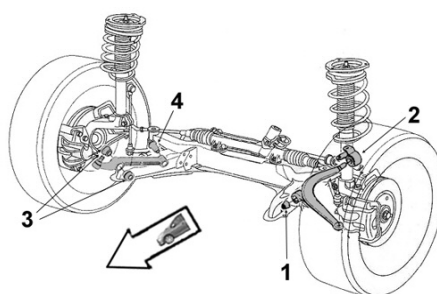

4001540 Articulation AV/AR
 OE 8200651161 Front rear bush



1
2

Ø int.12 Ø ext.45.5 coll.59 long. tube int.46 ext.29.5 ep. coll.4

1.2i 16v.	LU2U/2V/2W/30
1.4i 16v.	LU2B/3D/3R/3T
1.4i	LU17/3K/3P/3S
1.5 DCi	LU1W/24/25/3M/3N
1.6i	LU02/07
1.6i 16v.	LU01/05/18/0A/0C/1A/1B/1D/1V/2M

Bras & Triangle de suspension

Control arm
 Brazo y triángulo
 Wahacz
 Рычаг подвески

G/L D/R



7474030 Triangle de susp. G
 OE 8200942407 Left track control arm

NEW



4 Avec rotule With ball joint Ø 16

1.2i GPL	29/09/08-
1.2i 16v.	29/09/08-
1.4i /16v.	29/09/08-
1.4i MPi	29/09/08-
1.5 DCi	29/09/08-
1.6i	29/09/08-
1.6i 16v. /GPL	29/09/08-

7474029 Triangle de susp. D
 OE 8200942408 Right track control arm

NEW



3 Avec rotule With ball joint Ø 16

1.2i GPL	29/09/08-
1.2i 16v.	29/09/08-
1.4i /16v.	29/09/08-
1.4i MPi	29/09/08-
1.5 DCi	29/09/08-
1.6i	29/09/08-
1.6i 16v. /GPL	29/09/08-

... Thalia Symbol II (LU)

SASIC

RENAULT

Bras & Triangle de suspension

Control arm
Brazo y triángulo
Wahacz
Рычаг подвески

G/L  D/R

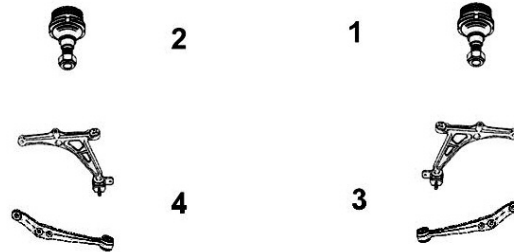

4005277 Rotule de susp. inf. G/D

Part/oe 8200942407 L/R lower suspension ball joint



1 2 Trous fixation Ø12

1.2i 16v.	LU2U/V/W LU30	29/09/08-
1.4i	LU17 LU3K/P/S	29/09/08-
1.4i 16v.	LU2B LU3D/R/T	29/09/08-
1.5 DCi	LU1W LU24/5 LU3M/N	29/09/08-
1.6i	LU02/7	29/09/08-
1.6i 16v.	LU01/5/A/C LU1A/B/D/V/8 LU2M	29/09/08-



Support d'amortisseur

Suspension mounting
Soporte amortiguador
Poduszka amortyzatora
Опора амортизатора

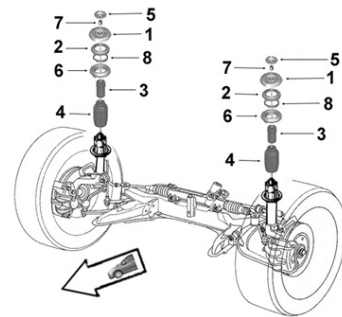

4001615 Tampon suspension G/D

OE 7700829529 L/R susp. rebound stop



1	1.2i 16v.	LU2U/2V/2W/30
	1.4i	LU17/3K/3P/3S
	1.4i 16v.	LU2B/3D/3R/3T
	1.5 DCi	LU1W/24/25/3M/3N
	1.6i	LU02/07
	1.6i 16v.	LU01/05/18/0A/0C LU1A/1B/1D/1V/2M

4005300 Butée à billes G/D

OE 8200651172 L/R ball bearing



2	1.2i 16v.	LU2U/2V/2W/30
	1.4i	LU17/3K/3P/3S
	1.4i 16v.	LU2B/3D/3R/3T
	1.5 DCi	LU1W/24/25/3M/3N
	1.6i	LU02/07
	1.6i 16v.	LU01/05/18/0A/0C LU1A/1B/1D/1V/2M

Twingo I ...

Éléments DIRECTION

Steering parts
Elementos Direcciones
Elementy układ kierowniczy
Элементы рулевой системы

G/L  D/R

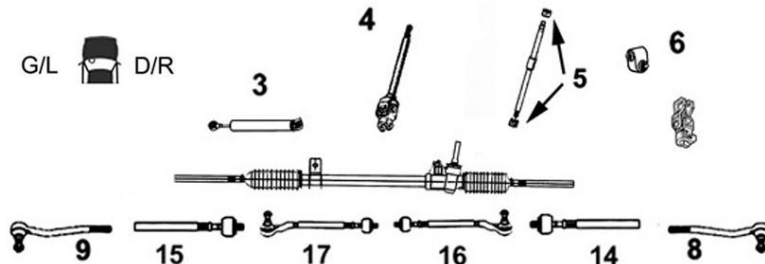

3008245 Axe de bielle G/D

Part/oe 7701469517 L/R axial joint



14 Côté dir. M12x1.0 Côté rot. M14x1.5
15 long 293 mm

1.2	C063/64 S063/64
1.2i	C066/68 S066 -15/12/99
1.2i	C067

3008246 Axe de bielle G/D

Part/oe 7701473498 L/R axial joint













14 Côté dir. M12x1.0 Côté rot. M14x1.5
15 long 318 mm

1.0i	C06Y
1.0i 16v.	C06H
1.2i	C066/68 S066 15/12/99-
1.2i	S068/6G C06G
1.2i 16v.	C060/61/62/6C/6D/6K/6V
1.2i 16v.	C06W S06C/6D/6K

... Twingo I ...

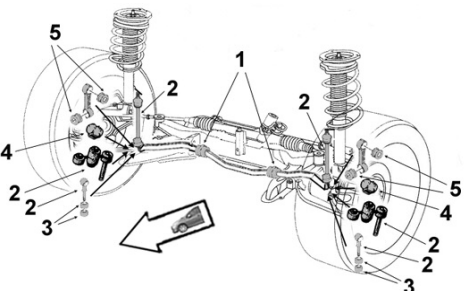
RENAULT



4006245 OE 7701467218	Bielle de direction G <i>Left steering rod</i>	4006247 OE 7701467219	Bielle de direction D <i>Right steering rod</i>
17	 <p>1.2 C063/64 S063/64 1.2i C066/68 S066 -15/12/99 1.2i C067</p>	16	 <p>1.2 C063/64 S063/64 1.2i C066/68 S066 -15/12/99 1.2i C067</p>
4006103 OE 6000022730	Rotule de direction G <i>Left tie rod end</i>	4006104 OE 6000022731	Rotule de direction D <i>Right tie rod end</i>
9	 <p>M14 x 1.5 1.2 C063/64 S063/64 1.2i C066/68 S066 -15/12/99 1.2i C067</p>	8	 <p>M14 x 1.5 1.2 C063/64 S063/64 1.2i C066/68 S066 -15/12/99 1.2i C067</p>
4006134 OE 7701474492	Rotule de direction G <i>Left tie rod end</i>	4006135 OE 7701474493	Rotule de direction D <i>Right tie rod end</i>
9	 <p>1.0i C06Y 1.0i 16v. C06H 1.2i C066/68 S066 15/12/99- 1.2i S068/6G C06G 1.2i 16v. C060/61/62/6C/6D/6K 1.2i 16v. C06W S06C/6D/6K</p>	8	 <p>1.0i C06Y 1.0i 16v. C06H 1.2i C066/68 S066 15/12/99- 1.2i S068/6G C06G 1.2i 16v. C060/61/62/6C/6D/6K 1.2i 16v. C06W S06C/6D/6K</p>
 <p>Barre stabilisatrice Stabilizer bar Barra estabilizadora Drażek stabilizatora стабилизатор поперечной устойчивости</p>			
4005118 OE 8200714446	Biellette barre stab. G <i>Left stabilizer bar stub axle</i>	4005119 OE 8200714448	Biellette barre stab. D <i>Right stabilizer bar stub axle</i>
2	 <p>1.2 susp. normale C066 BVM/ robotisée 09/00- 1.2 susp. renforcée C066 BVM/ robotisée 08/01- 1.2 susp. normale C068 09/00- 1.2 susp. normale C06C S068 1.2 S066 BVM 09/00- 1.2i C06 0/1/2/D/G/K/W 1.2i S06 0/C/D/G/K/W</p>	2	 <p>1.2 susp. normale C066 BVM/ robotisée 09/00- 1.2 susp. renforcée C066 BVM/ robotisée 08/01- 1.2 susp. normale C068 09/00- 1.2 susp. normale C06C S068 1.2 S066 BVM 09/00- 1.2i C06 0/1/2/D/G/K/W 1.2i S06 0/C/D/G/K/W</p>
2304029 OE 8200024373	Palier de barre milieu <i>Middle bar main bearing</i>		
1	 <p>1.0i 16v. C06H 08/01- 1.2i C066/68/6G S066/68/6G 1.2i S068/6G C06G 1.2i 16v. C060/61/62/6C/6D/6K/6V/6W 1.2i 16v. S06C/6D/6K</p>		

... Twingo I ...



Eléments SUSPENSION
Suspension parts
Elementos suspensión
Elementy zawieszenie
Элементы подвески

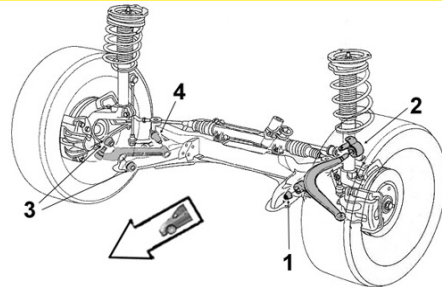

RENAULT

SASIC

4001530

Articulation AV

OE 8200651164

Front bush



1 Ø int.12 Ø ext.36 long. tube int.46 ext.33

1.0i	C06Y
1.0i 16v.	C06H
1.2	S06 K/M/W
1.2	C06 G/J/K/M/N/R/W
1.2i	C06 0/1/2/3/4/6/7/8/C/D
1.2i	S06 0/3/4/6/8/C/D/G

4001532

Articulation AR

OE 8200651168

Rear bush



2 Ø int.12 Ø ext.38 coll.49
long. tube int.46 ext.37 ep. coll.7

1.0i	C06Y
1.0i 16v.	C06H
1.2	C06G/J/K/M/N/R/W
1.2	S06G/K/M/W
1.2i	C060/1/2/3/4/6/7/8/C/D
1.2i	S060/3/4/6/8/C/D

Bras & Triangle de suspension

Control arm
Brazo y triángulo
Wahacz
Рычаг подвески

G/L D/R



4003374

Triangle de susp. G

OE 8200737125

Left track control arm



4 Avec rotule *With ball joint*

1.0i	C06Y
1.0i 16v.	C06H
1.2	C063/64 S063/64
1.2i	C066/67/68/6G S066/68/6G
1.2i 16v.	C060/61/62/6C/6D/6K/6V/6W
1.2i 16v.	S06C/6D/6K

4003372

Triangle de susp. D

OE 8200737126

Right track control arm



3 Avec rotule *With ball joint*

1.0i	C06Y
1.0i 16v.	C06H
1.2	C063/64 S063/64
1.2i	C066/67/68/6G S066/68/6G
1.2i 16v.	C060/61/62/6C/6D/6K/6V/6W
1.2i 16v.	S06C/6D/6K

4005257

Rotule de susp. inf. G/D

OE 7701468883

L/R lower suspension ball joint



1
2 Trous fixation Ø10

1.0i	C06Y
1.0i 16v.	C06H
1.2	C063/64 S063/64
1.2i	C066/67/68/6G
1.2i	S066/68/6G
1.2i 16v.	C060/61/62/6C/6D/6K/6V/6W
1.2i 16v.	S06C/6D/6K

1003572

Kit rép. triangle susp. G ou D

OE -

L or R track control arm bearing repair kit



Avec visserie *With screws and bolts*

1.0i	C06Y
1.0i 16v.	C06H
1.2	C063/64 S063/64
1.2i	C066/67/68/6G
1.2i	S066/68/6G
1.2i 16v.	C060/61/62/6C/6D/6K/6V/6W
1.2i 16v.	S06C/6D/6K

... Twingo I ...



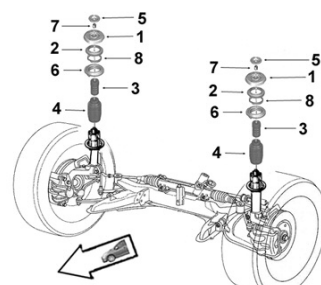

Support d'amortisseur
 Suspension mounting
 Soporte amortiguador
 Poduszka amortyzatora
 Опора амортизатора



RENAULT





4001620 OE 7700426450	Coupelle rebond. <i>Spring cup</i>	4001600 OE 7700827435	Tampon suspension G/D <i>L/R susp. rebound stop</i>
	<p style="text-align: center;">5</p> <p>1.2 C06 G/H/J/K/M/N/R/W/Y 1.2 S06G/K/M/W 1.2i C06 0/1/2/3/4/6/7/8/C/D 1.2i S060/3/4/6/8/C/D</p>		<p style="text-align: center;">1 H35.5mm</p> <p>1.2 C06 G/H/J/K/M/N/R/W/Y 1.2 S06G/K/M/W 1.2i C06 0/1/2/3/4/6/7/8/C/D 1.2i S060/3/4/6/8/C/D</p>

4005300 OE 8200651172	Butée à billes G/D <i>L/R ball bearing</i>	4005376 OE 7700819237	Butée protecteur susp. G/D <i>L/R suspension bush</i>
	<p style="text-align: center;">2</p> <p>1.2 C06 G/H/J/K/M/N/R/W/Y 1.2 S06G/K/M/W 1.2i C06 0/1/2/3/4/6/7/8/C/D 1.2i S060/3/4/6/8/C/D</p>		<p style="text-align: center;">3 4</p> <p>1.2 C06 G/H/J/K/M/N/R/W/Y 1.2 S06G/K/M/W 1.2i C06 0/1/2/3/4/6/7/8/C/D 1.2i S060/3/4/6/8/C/D</p>

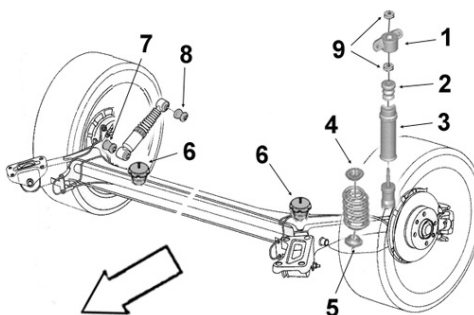

Support d'amortisseur
 Suspension mounting
 Soporte amortiguador
 Poduszka amortyzatora
 Опора амортизатора



4001638 OE 7700846916	Support suspension G/D <i>L/R suspension mounting</i>
	<p style="text-align: center;">1</p> <p>1.2 C06 G/H/J/K/M/N/R/W/Y 1.2 S06G/K/M/W 1.2i C06 0/1/2/3/4/6/7/8/C/D 1.2i S060/3/4/6/8/C/D</p>

4005510 OE 7700821159	Butée protecteur susp. G/D <i>L/R suspension bush</i>
	<p style="text-align: center;">2 3</p> <p>1.2 C06 G/H/J/K/M/N/R/W/Y 1.2 S06G/K/M/W 1.2i C06 0/1/2/3/4/6/7/8/C/D 1.2i S060/3/4/6/8/C/D</p>

... Twingo I

Eléments TRAIN ARRIERE

Rear axle parts

Tren TRAS

Elementy zawieszenia tylnego

элементы задней оси.



4003387

Articulation

OE 7700821167

Bush

Ø int.10 Ø ext.40 coll.51 long. tube int.70 ext.52 ep. coll.6



1.0i	C06Y
1.0i 16v.	C06H
1.2	C06G/H/J/K/M/N/R/W/Y
1.2	S06G/K/M/W
1.2i	C060/1/2/3/4/6/7/8/C/D
1.2i	S060/3/4/6/8/C/D

Twingo II ...

Eléments DIRECTION

Steering parts

Elementos Direcciones

Elementy układ kierowniczy

Элементы рулевой системы

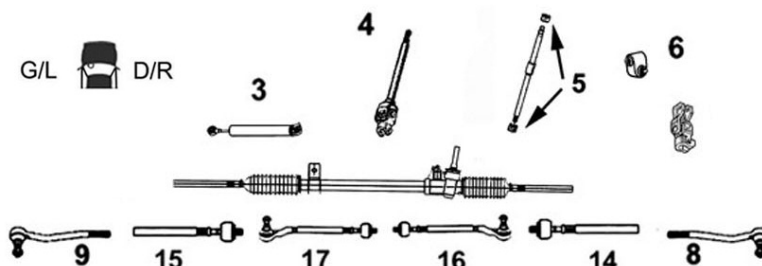

7774012

Axe de bielle G/D

Part/oe 7701477878

L/R axial joint

14 Côté dir. M12x1.0 Côté rot. M14x1.5 long 304 mm
15



1.2i	CN0D GN0D	07/07-
1.2i 16v. DA	CN0B/F/1/4/5	07/07-
1.2i 16v.	CN0A/C/K/P/V GN01	07/07-
1.5 DCi DA	CN00/3	07/07-
1.5 DCi	CN0E/U GN0E/0/3	07/07-

4006134

Rotule de direction G

OE 7701474492

Left tie rod end



9	1.2i	CN0D GN0D	07/07-
	1.2i 16v.	CN0A/B/C/F/K/P/V/1/4/5/6 GN01	07/07-
	1.5 DCi	CN0E/U/0/3 GN0E/0/3	07/07-
	1.6i 16v. RS	CN0N/R/S	07/07-

4006135

Rotule de direction D

OE 7701474493

Right tie rod end



8	1.2i	CN0D GN0D	07/07-
	1.2i 16v.	CN0A/B/C/F/K/P/V/1/4/5/6 GN01	07/07-
	1.5 DCi	CN0E/U/0/3 GN0E/0/3	07/07-
	1.6i 16v. RS	CN0N/R/S	07/07-

... Twingo II ...



Barre stabilisatrice
 Stabilizer bar
 Barra estabilizadora
 Drażek stabilizatora
 стабилизатор поперечной устойчивости

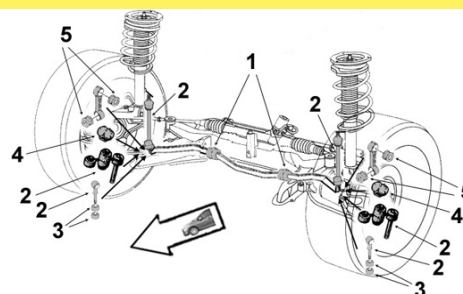

RENAULT



2304021 Palier de barre bout
 OE 8200891487+7703034237 End bar main bearing



2	1.2i	CN0D GN0D	22/09/08-
	1.2i 16v.	CN0A/0B/0C/0K/0P/0V CN01/04/05/0F GN01	22/09/08-
	1.5 DCi	CN0E/0U/00/03 GN0E/03	22/09/08-

2304018 Palier de barre milieu
 OE 8200691425 Middle bar main bearing



1	Ø 23
	1.2i CN0D 07/07-

2304017 Palier de barre milieu
 OE 8200681622 Middle bar main bearing



1	Ø 19.5
	1.6i 16v. RS CN0R 07/07-

Bras & Triangle de suspension

Control arm
 Brazo y triángulo
 Wahacz
 Рычаг подвески

G/L D/R



7474031 Triangle de susp. inf. G
 OE 8200942423 Lower left track control arm

NEW



4	Avec rotule With ball joint Ø 18		
	1.2i	CN0D GN0D	07/07-
	1.2i 16v.	CN0A/B/C/F/K/P/V/1/4/5/6 GN01	07/07-
	1.5 DCi	CN0E/U/0/3 GN0E/0/3	07/07-

7474032 Triangle de susp. inf. D
 OE 8200942403 Lower right track control arm

NEW



3	Avec rotule With ball joint Ø 18		
	1.2i	CN0D GN0D	07/07-
	1.2i 16v.	CN0A/B/C/F/K/P/V/1/4/5/6 GN01	07/07-
	1.5 DCi	CN0E/U/0/3 GN0E/0/3	07/07-

7574010 Rotule de susp. inf. G/D
 Part/oe 8200942403 L/R lower suspension ball joint



1			
2	1.2i	CN0D GN0D	07/07-
	1.2i 16v.	CN0A/B/C/F/K/P/V/1/4/5/6 GN01	07/07-
	1.5 DCi	CN0E/U/0/3 GN0E/0/3	07/07-

... Twingo II





SASIC

RENAULT

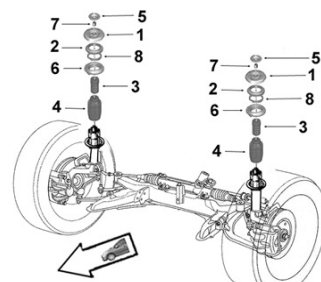



Support d'amortisseur
Suspension mounting
Soporte amortiguador
Poduszka amortyzatora
Опора амортизатора



<p>4001620 OE 7700426450</p> 	<p>Coupelle rebond. <i>Spring cup</i></p> <p>5</p> <p>1.2i CN0D GN0D 07/07- 1.2i 16v. CN0A/0B/0C/0K/0P/0V CN01/04/0F GN01 07/07- 1.5 DCi CN0E/0U/00/03 GN0E/03 07/07- 1.6i 16v. RS CN0R/0S/0N 07/07-</p>	<p>4005300 OE 8200651172</p> 	<p>Butée à billes G/D <i>L/R ball bearing</i></p> <p>2</p> <p>1.2i CN0D GN0D 07/07- 1.2i 16v. CN0A/0B/0C/0K/0P/0V CN01/04/0F GN01 07/07- 1.5 DCi CN0E/0U/00/03 GN0E/03 07/07- 1.6i 16v. RS CN0R/0S/0N 07/07-</p>
<p>4001614 OE 7700428440</p> 	<p>Protecteur amortisseur G/D <i>L/R shock absorber protector</i></p> <p>3 4</p> <p>1.2i CN0D GN0D 07/07- 1.2i 16v. CN0A/0B/0C/0K/0P/0V CN01/04/0F GN01 07/07- 1.5 DCi CN0E/0U/00/03 GN0E/03 07/07-</p>	<p>2654017 OE 8200747691</p> 	<p>Butée protecteur susp. <i>Suspension bush</i></p> <p>3 4</p> <p>1.6i 16v. RS Pack Extrême Châssis cup CN0R/0S/0N 07/07-</p>
<p>2654015 OE 8200681777</p>  <p>3 4</p> <p>1.6i 16v. RS Pack Extrême Châssis sport 2 CN0R/0S/0N 07/07- 1.6i 16v. RS Sans pack / pack sport CN0R/0S/0N 07/07-</p>			

Eléments TRAIN ARRIERE
Rear axle parts
Tren TRAS
Elementy zawieszenia tylnego
элементы задней оси.



<p>4003324 OE 8200042594</p> 	<p>Articulation AR <i>Rear bush</i></p> <p>Ø int.10.3 Ø ext.45.2 coll.65.5 long. tube int.73 ext.51.3 ep. coll.14.6</p> <p>1.2i CN0D GN0D 07/07- 1.2i 16v. CN0A/0C/0K/0P/0V CN01/04/0F GN01 07/07- 1.5 DCi CN0E/0U/00/03 GN0E/03 07/07-</p>	<p>4005527 OE 6000073602</p> 	<p>Articulation AR <i>Rear bush</i></p> <p>Ø int.10 Ø ext.45 coll.65 long. tube int.73 ext.50 ep. coll.15</p> <p>1.6i 16v. RS CN0R/0S/0N 07/07-</p>
---	--	--	--

Twizy

Bras & Triangle de suspension

Control arm
Brazo y triángulo
Wahacz
Рычаг подвески

G/L  D/R

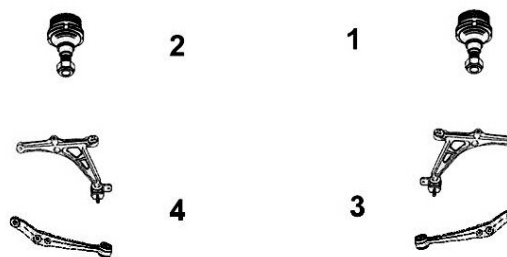

7574003

Rotule de susp. inf. G/D

OE 401604793R *L/R lower suspension ball joint*

1 Ø 18
2



TT Elec. /All models Electric

Bras & Triangle de suspension

Control arm
Brazo y triángulo
Wahacz
Рычаг подвески

G/L  D/R

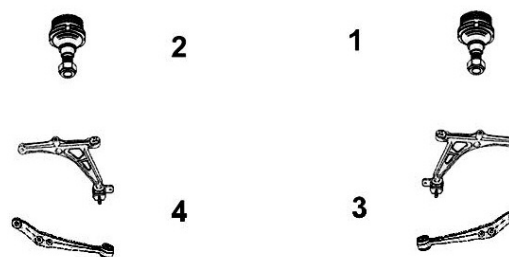

7574003

Rotule de susp. inf. G/D

OE 401604793R *L/R lower suspension ball joint*

1 Ø 18
2



TT Elec. /All models Electric

Vel Satis ...

Eléments DIRECTION

Steering parts
Elementos Direcciones
Elementy układu kierownicy
Элементы рулевой системы

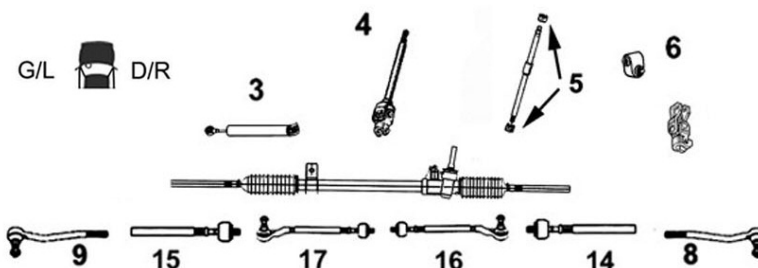

7774011

Axe de bielle G/D

Part/oe 7701478552 *L/R axial joint*

14 Côté dir. M12x1.0 Côté rot. M14x1.5 long 247 mm
15



2.0 Turbo	BJ0K/0P/0W/05
2.0 DCi	BJ03/0B
2.2 DCi	BJ0E/0F/0G/0H/0M/00
3.0 DCi	BJ0J/0N/0S
3.5i V6 24v.	BJ0R/0U/0V/01

... Vel Satis ...

Eléments DIRECTION

Steering parts

Elementos Direcciones

Elementy uklad kierowniczy

Элементы рулевой системы

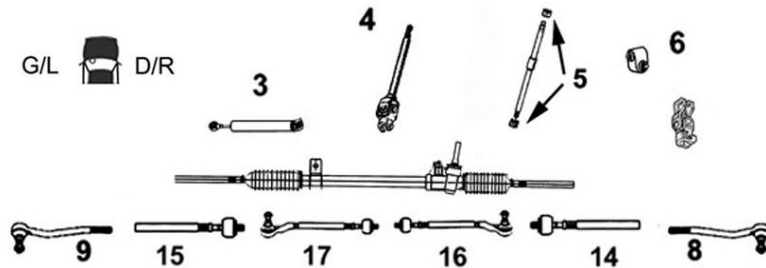

4006147

Rotule de direction G

OE 485202714R

Left tie rod end

9	2.0 Turbo	BJ0K/0P/0W/05
	2.0 DCi	BJ03/0B
	2.2 DCi	BJ0E/0F/0G/0H/0M/00
	3.0 DCi	BJ0J/0N/0S
	3.5i V6 24v.	BJ0R/0U/0V/01



4006148

Rotule de direction D

OE 485209446R

Right tie rod end

8	2.0 Turbo	BJ0K/0P/0W/05
	2.0 DCi	BJ03/0B
	2.2 DCi	BJ0E/0F/0G/0H/0M/00
	3.0 DCi	BJ0J/0N/0S
	3.5i V6 24v.	BJ0R/0U/0V/01



Barre stabilisatrice

Stabilizer bar

Barra estabilizadora

Drążek stabilizatora

стабилизатор поперечной устойчивости

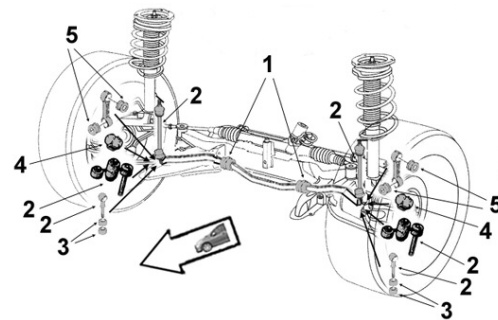

4005141

Biellette barre stab.

OE 8200661217

Stabilizer bar stub axle

2	2.0 Turbo	BJ0K/0P/0W
	2.0 DCi	BJ03/0B
	2.2 DCi	BJ0E/0F/0G/0H/0M
	3.0 DCi	BJ0J/0N
	3.5i V6 24v.	BJ0R/0U/0V



Bras & Triangle de suspension

Control arm

Brazo y triángulo

Wahacz

Рычаг подвески

G/L D/R

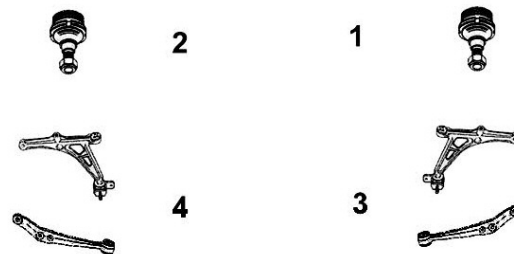

4005278

Rotule de susp. inf. G/D

OE 401606676R

L/R lower suspension ball joint

1 2	2.0 Turbo	BJ0K/0P/0W/05
	2.0 DCi	BJ03/0B
	2.2 DCi	BJ0E/0F/0G/0H/0M/00
	3.0 DCi	BJ0J/0N/0S
	3.5i V6 24v.	BJ0R/0U/0V/01



... Vel Satis ...







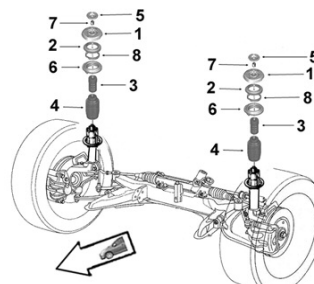



Support d'amortisseur

Suspension mounting
Soporte amortiguador
Poduszka amortyzatora
Опора амортизатора



RENAULT

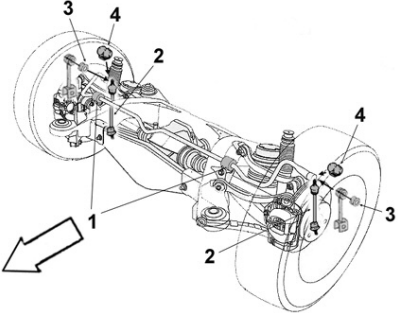

4001628 OE 8200002877	Coupelle rebond. G/D <i>L/R spring cup</i>	4001644 OE 8200201714	Support suspension G/D <i>L/R suspension mounting</i>
	<p style="text-align: center;">5</p> <p>2.0 Turbo BJ0K/0P/0W 2.2 DCi BJ0E/0F/0G/0H/0M 3.0 DCi BJ0J/0N 3.5i V6 24v. BJ0R/0U/0V</p>		<p style="text-align: center;">1</p> <p>2.0 Turbo BJ0K/0P/0W 2.2 DCi BJ0E/0F/0G/0H/0M 3.0 DCi BJ0J/0N 3.5i V6 24v. BJ0R/0U/0V</p>
2654025 OE 7700424481	Butée à billes G/D <i>L/R ball bearing</i>	4001626 OE 7700424482	Coupelle sup. ressort G/D <i>L R upper cup spring</i>
	<p style="text-align: center;">2</p> <p>2.0 Turbo BJ0K/0P/0W/05 2.0 DCi BJ03/0B 2.2 DCi BJ0E/0F/0G/0H/0M/00 3.0 DCi BJ0J/0N/0S 3.5i V6 24v. BJ0R/0U/0V/01</p>		<p style="text-align: center;">6</p> <p>2.0 Turbo BJ0K/0P/0W 2.2 DCi BJ0E/0F/0G/0H/0M 3.0 DCi BJ0J/0N 3.5i V6 24v. BJ0R/0U/0V</p>
4001642 OE 8200180137			
Butée de suspension G/D <i>L/R suspension bush</i>			
	<p style="text-align: center;">3 4</p> <p>2.0 Turbo BJ0K/0P/0W 2.0 DCi BJ03/0B 2.2 DCi BJ0E/0F/0G/0H/0M/00 3.0 DCi BJ0J/0N/0S 3.5i V6 24v. BJ0R/0U/0V</p>		
	Barre stabilisatrice Stabilizer bar Barra estabilizadora Drażek stabilizatora стабилизатор поперечной устойчивости		
2304008 OE 8200619922	Biellette barre stab. <i>Stabilizer bar stub axle</i>		
	<p style="text-align: center;">2</p> <p>2.0 Turbo BJ0K/0P/0W/05 2.0 DCi BJ03/0B 2.2 DCi BJ0E/0F/0G/0H/0M/00 3.0 DCi BJ0J/0N/0S 3.5i V6 24v. BJ0R/0U/0V/01</p>		

... Vel Satis



Eléments SUSPENSION

Suspension parts

Elementos suspensión

Elementy zawieszenie

Элементы подвески

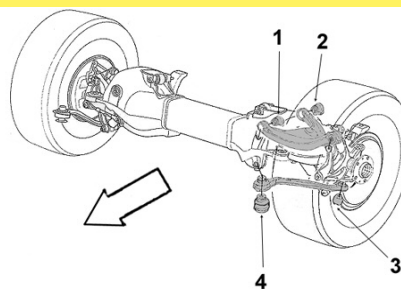

RENAULT

SASIC

4001586

Articulation AV

OE 8200300587

Front bush



1 Ø int.12 Ø ext.50 coll.64 long. tube int.61 ext.38 ep. coll.10

2.0 Turbo

BJ0K/0P/0W

2.2 DCi

BJ0E/0F/0G/0H/0M

3.0 DCi

BJ0J/0N

3.5i V6 24v.

BJ0R/0U/0V

Eléments TRAIN ARRIERE

Rear axle parts

Tren TRAS

Elementy zawieszenia tylnego

элементы задней оси.



4005533

Biellette bras inf. AR G

OE 8200602608

Link arm lower left rear



2.0 Turbo

BJ0K/0P/0W/05

2.0 DCi

BJ03/0B

2.2 DCi

BJ0E/0F/0G/0H/0M/00

3.0 DCi

BJ0J/0N/0S

3.5i V6 24v.

BJ0R/0U/0V/01

4005532

Biellette bras inf. AR D

OE 8200602609

Link arm lower right rear



2.0 Turbo

BJ0K/0P/0W/05

2.0 DCi

BJ03/0B

2.2 DCi

BJ0E/0F/0G/0H/0M/00

3.0 DCi

BJ0J/0N/0S

3.5i V6 24v.

BJ0R/0U/0V/01

Wind ...

Eléments DIRECTION

Steering parts

Elementos Direcciones

Elementy układ kierowniczy

Элементы рулевой системы

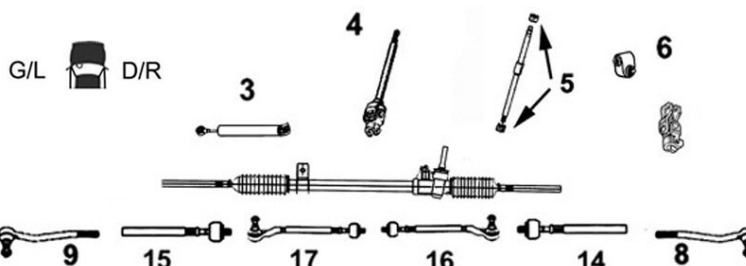

4006134

Rotule de direction G

OE 7701474492

Left tie rod end



9

1.2i Turbo

E4MA/MF 06/10-

1.6i

E4MB/MC 06/10-

4006135

Rotule de direction D

OE 7701474493

Right tie rod end



8

1.2i Turbo

E4MA/MF 06/10-

1.6i

E4MB/MC 06/10-

... Wind



Support d'amortisseur
 Suspension mounting
 Soporte amortiguador
 Poduszka amortyzatora
 Опора амортизатора

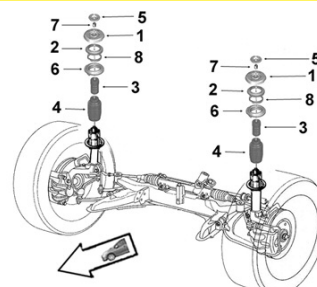

RENAULT
SASIC

4001647 Tampon suspension G/D OE 6000073600 <i>L/R susp. rebound stop</i>	4005300 Butée à billes G/D OE 8200651172 <i>L/R ball bearing</i>
<div style="display: flex; align-items: center;"> <div style="flex: 1;"> <p style="font-size: 24px; margin: 0;">1</p> <p style="margin: 5px 0;">1.2i Turbo E4MA/MF 06/10- 1.6i E4MB/MC 06/10-</p> </div> </div>	<div style="display: flex; align-items: center;"> <div style="flex: 1;"> <p style="font-size: 24px; margin: 0;">2</p> <p style="margin: 5px 0;">1.2i Turbo E4MA/MF 06/10- 1.6i E4MB/MC 06/10-</p> </div> </div>

2654015 Butée protecteur susp. AV OE 8200681777 <i>Front suspension bush</i>
<div style="display: flex; align-items: center;"> <div style="flex: 1;"> <p style="font-size: 24px; margin: 0;">3 4</p> <p style="margin: 5px 0;">1.2i Turbo E4MA/MF 06/10- 1.6i E4MB/MC 06/10-</p> </div> </div>

Zoé ...

Eléments DIRECTION
 Steering parts
 Elementos Direcciones
 Elementy układu kierowniczy
 Элементы рулевой системы

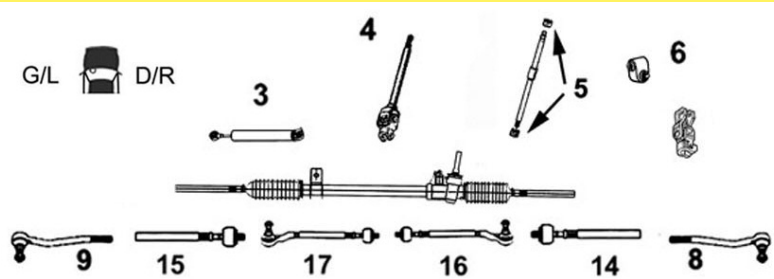

7674020 Rotule de direction G OE 485200368R <i>Left tie rod end</i>	7674021 Rotule de direction D OE 485208355R <i>Right tie rod end</i>
<div style="display: flex; align-items: center;"> <div style="border: 1px solid black; border-radius: 50%; padding: 2px; margin-right: 10px;">NEW</div> <div style="flex: 1;"> <p style="font-size: 24px; margin: 0;">9 M14 x 1.5</p> <p style="margin: 5px 0;">TT Elec. /All models Electric BFMA/B</p> </div> </div>	<div style="display: flex; align-items: center;"> <div style="border: 1px solid black; border-radius: 50%; padding: 2px; margin-right: 10px;">NEW</div> <div style="flex: 1;"> <p style="font-size: 24px; margin: 0;">8 M14 x 1.5</p> <p style="margin: 5px 0;">TT Elec. /All models Electric BFMA/B</p> </div> </div>

... Zoé ...



Barre stabilisatrice
 Stabilizer bar
 Barra estabilizadora
 Drażek stabilizatora
 стабилизатор поперечной устойчивости

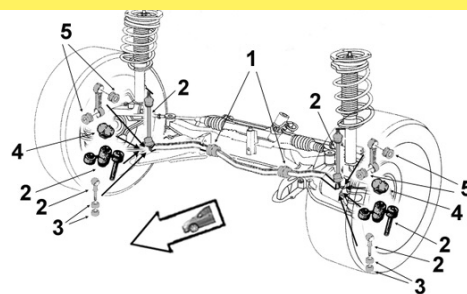

RENAULT

SASIC

4005147

Biellette barre stab.

OE 8200127308

Stabilizer bar stub axle



2 Entraxe : 250 mm M10x150 X2

TT Elec. / All models Electric -20/05/11

Bras & Triangle de suspension

Control arm
 Brazo y triángulo
 Wahacz
 Рычаг подвески

G/L D/R



7474028

Triangle de susp. G

OE 545055711R

Left track control arm

NEW



4 Avec rotule With ball joint Ø 18

TT Elec. / All models Electric
 BFMA/B 24/09/12-

7474027

Triangle de susp. D

OE 545046817R

Right track control arm

NEW



3 Avec rotule With ball joint Ø 18

TT Elec. / All models Electric
 BFMA/B 24/09/12-



Support d'amortisseur

Suspension mounting
 Soporte amortiguador
 Poduszka amortyzatora
 Опора амортизатора

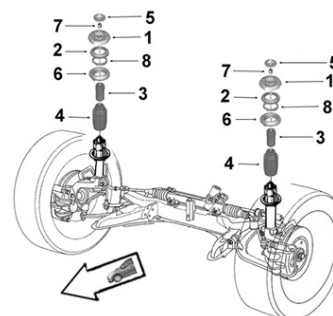

2654035

Support suspension

OE 543024644R

Suspension mounting

NEW



1

TT Elec. / All models Electric
 BFMA/B

2654030

Butée à billes G/D

OE 543259539R

L/R ball bearing

NEW



2

TT Elec. / All models Electric
 BFMA/B

... Zoé

2654032
Protecteur amortisseur G/D

OE 543884315R

L/R shock absorber protector

NEW

4

TT Elec. / All models Electric

BFMA/B

Express ...

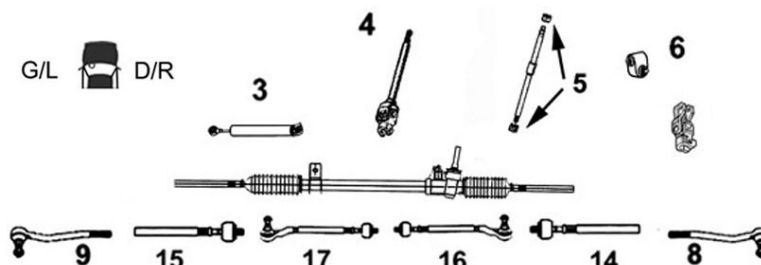
Eléments DIRECTION
Steering parts
Elementos Direcciones
Elementy uklad kierowniczy
Элементы рулевой системы

3008054
Axe de bielle G/D

OE -

L/R axial joint

14 Côté dir. M12x1.0 Côté rot. M14x1.5
15 long 256 mm

TT /all models

4006054B1
Bielle de direction G/D

OE 7701463346

L/R steering rod

16
17

TT /all models

4006112
Rotule de direction G/D

OE 7701469231

L/R tie rod end

8
9 M14x1.5

TT /all models

4004006
Axe de volant

OE 7700793457

Steering wheel shaft

4

TT /all models DNA 10/88-06/07/93

4006138
Douille à aiguilles colonne

OE 7703090293

Needle bearing

5

TT /all models

4001460
Noix cardan de direction

OE 7700687433

U joint

6

1.1 F40H F401

1.1 F401

1.6 D F404

TT /all models F40A/D/E/N/P/R/U/V/Y F406 G40A G40W F405 G40B G40C

TT /all models F40M F400 F402 F407

TT /all models F40F F40T F407

-01/08/91

08/91-

-09/91

09/91-

... Express ...



Barre stabilisatrice
 Stabilizer bar
 Barra estabilizadora
 Drażek stabilizatora
 стабилизатор поперечной устойчивости

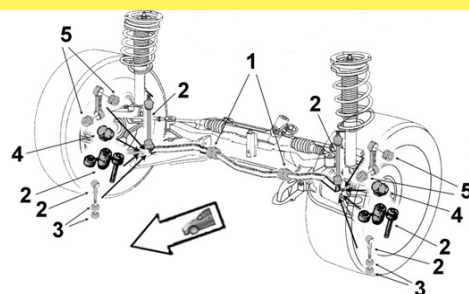

RENAULT



4001494

Palier de barre bout

OE 6001007821

End bar main bearing



4 Barre Ø21 Charge utile augmentée

1.1	F40H F401	-01/08/91
1.1	F401	08/91-
1.6 D	F404	

TT /all models	F40M F400 F402 F407	-09/91
TT /all models	F40F F40T F407	09/91-
TT /all models	F40A/D/E/N/P/R/U/V/Y	
	F405 G40B G40C F406 G40A G40W	

4001462

Palier de barre bout

OE 7700760265

End bar main bearing



4 Barre Ø22 Charge utile normale

.1	F40H F401	-01/08/91
1.1	F401	08/91-
1.6 D	F404	

TT /all models	F40M F400 F402 F407	-09/91
TT /all models	F40F F40T F407	09/91-
TT /all models	F40A/D/E/N/P/R/U/V/Y	
	F405 G40B G40C F406 G40A G40W	

4001445

Palier de barre milieu

OE 7700798052

Middle bar main bearing



1 Barre Ø21

1.1	F40H F401	-01/09/90
-----	-----------	-----------

TT /all models F40M/400/402/407 -09/91

TT /all models Charge utile augmentée
 F40A/D/E/N/P/R/U/V/Y
 F404 F405 G40B G40C

4001446

Palier de barre milieu

OE 7702144561

Middle bar main bearing



1 Barre Ø22 H 39

Equipement 161 260

1.1	F40H F401	09/90-01/08/91
1.6 D	F404	

4001472

Palier de barre milieu

OE 7700763934

Middle bar main bearing



1 Barre Ø22 H 29

1.1	F40H F401	-01/09/90
-----	-----------	-----------

1.1 Sauf équip. 161 260 F40H F401
 09/90-01/08/91

1.6 D Sauf équip. 161 260 F404

TT /all models F40M/400/402/407 -09/91

4001539

Palier de barre milieu

OE 7700798053

Middle bar main bearing



1 Barre Ø22 H 45

1.1	F401	08/91-
-----	------	--------

TT /all models F40F/40T/407 09/91-

TT /all models Charge utile normale
 F40A/D/E/N/P/R/U/V/Y
 F404/405 G40B/40C

TT /all models F406 G40A G40W

4005073

Kit rép. barre stab. G et D

OE -

L R Stabilizing bar repair kit

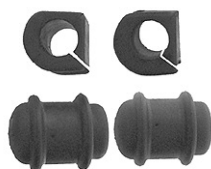

Barre Ø22 H 29

TT /all models

4005077

Kit rép. barre stab. G et D

OE -

L R Stabilizing bar repair kit

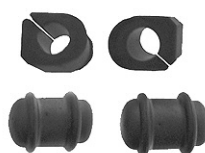

Barre Ø22 H 39

TT /all models

... Express ...

4005079

Kit rép. barre stab. G et D

OE -

L R Stabilizing bar repair kit

Barre Ø 23

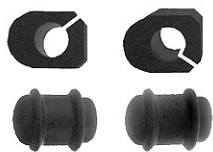

TT /all models 08/91-



Eléments SUSPENSION

Suspension parts

Elementos suspensión

Elementy zawieszenie

Элементы подвески

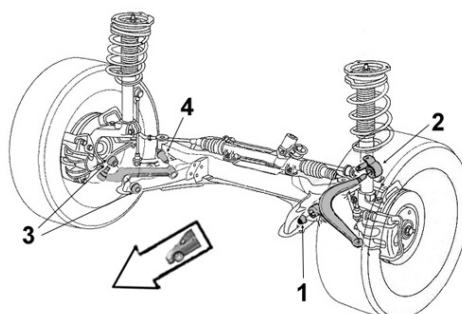

4001417

Articulation AV

OE 7704000681

Front bush



1 Ø int.12 Ø ext.32 long. tube int.46 ext.35

1.1 F40H F401 -01/09/90

TT /all models F40A/D/E/N/P/R/S/U/V/Y
F405 G40B G40C

TT /all models F40M/400/402/407 -09/91

4001406

Articulation AV

OE 7700762574

Front bush



1 Ø int.12 Ø ext.32 long. tube int.46 ext.35

1.1 F40H F401 09/90-01/08/91
1.1 F401 08/91-

1.6 D F404

TT /all models F40F/40T/407 09/91-
TT /all models F406 G40A/40W

4001406

Articulation AR

OE 7700762574

Rear bush



2 Ø int.12 Ø ext.32 long. tube int.46 ext.35

1.1 F40H F401 -01/09/90

TT /all models
F40A/D/E/N/P/R/U/V/Y F405 G40B/C

TT /all models
F40M F400 F402 F407 -09/91

4001417

Articulation AR

OE 7704000681

Rear bush



2 Ø int.12 Ø ext.32 long. tube int.46 ext.35

1.1 F40H F401 09/90-01/08/91
1.1 F401 08/91-

TT /all models F404/40F/40T/40S/407
09/91-

TT /all models F406 G40A/40C/40W

4001433

Articulation AR

OE 6001006724

Rear bush



2 Ø int.12 Ø ext.32 long. tube int.46 ext.35

1.6 D F404 -09/91

... Express ...

SASIC

RENAULT

Bras & Triangle de suspension

Control arm
Brazo y triángulo
Wahacz
Рычаг подвески

G/L  D/R



... Express



Support d'amortisseur

Suspension mounting
Soporte amortiguador
Poduszka amortyzatora
Опора амортизатора

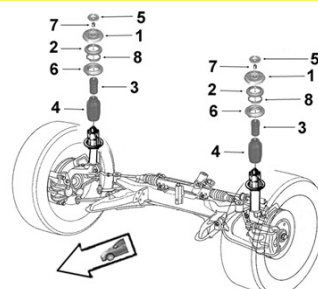

RENAULT



4001603 OE 7700757324	Tampon suspension G/D <i>L/R susp. rebound stop</i>	4005301 OE 7700777654	Butée à billes G/D <i>L/R ball bearing</i>
	1 1.1 F40H F401 -01/08/91 1.1 F401 08/91- 1.6 D F404 TT /all models F40M/400/402/407 -09/91 TT /all models F40F/40T/407 09/91- TT /all models F40A/D/E/N/P/R/U/V/Y F406/405 G40A/40B/40C/40W		2 1.1 F40H F401 -01/08/91 1.1 F401 08/91- 1.6 D F404 TT /all models F40M/400/402/407 -09/91 TT /all models F40F/40T/407 09/91- TT /all models F40A/D/E/N/P/R/U/V/Y F406/405 G40A/40B/40C/40W
4005371 OE 7700757323	Butée protecteur susp. G/D <i>L/R suspension bush</i>	4005220 OE -	Kit rép. suspension G ou D <i>L/R stabilizing bar repair kit</i>
	3 1.1 F401 4 1.6 D F404 TT /all models F40M/400/402/407 -09/91 TT /all models F40F/40T/407 09/91- TT /all models F40H -01/08/91 TT /all models F40A/D/E/N/P/R/U/V/Y F406/405 G40A/40B/40C/40W		1.4 F40Y 1.4i F40U/V TT /all models F40A/D/E/F/H/M/N/P/R/T F401/2/4/5/6/7 G40A/B/C/W
4005513 OE 6006001514	Butée de talonnage <i>Bushing</i>		
	6 1.4 Charge utile augmentée F40A 1.4 F40Y 1.4i Charge utile augmentée F40D/S/U/V 1.6 D Charge utile augmentée F404 1.9 D Charge utile augmentée F40E/N/P/R G40B/C TT Elec. /All models Electric G40W		
4005340B OE -	Kit rép. train AR G ou D <i>L/R rear axle repair kit</i>		
	TT /all models Charge utile augmentée		



Support d'amortisseur

Suspension mounting
Soporte amortiguador
Poduszka amortyzatora
Опора амортизатора

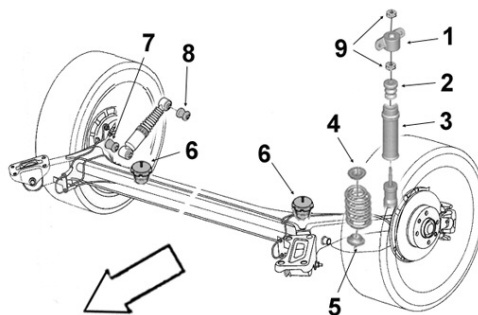

Kangoo I -02/03 VU ...

Eléments DIRECTION

Steering parts

Elementos Direcciones

Elementy układ kierowniczy

Элементы рулевой системы

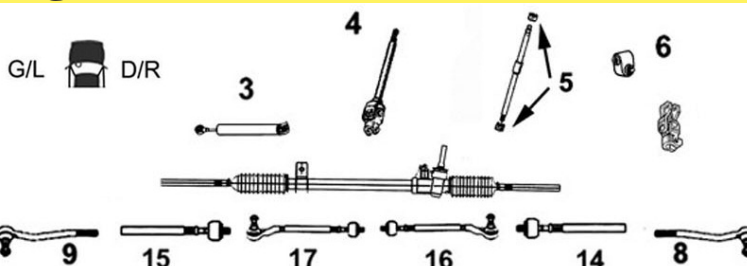

3008034 Axe de bielle G/D

Part/oe 7701470764 L/R axial joint



14 Côté dir. M12x1.0 Côté rot. M14x1.5 long 265 mm

1.2	DNA Véhicule tout chemin	FC0A	-03/02/99
1.2	DA	FC0A	-03/02/99
1.4	DNA Véhicule tout chemin	FC0C/0H	-03/02/99
1.4	DA	FC0C/0H	-03/02/99
1.6	DNA Susp. renforcée	FC00	-01/09/99
1.9 D	DNA Véhicule tout chemin	FC0D/0E	-03/02/99
1.9 D	DA	FC0D/0E	-03/02/99

3008035 Axe de bielle G/D

Part/oe 7701472113 L/R axial joint



14 Côté dir. M12x1.0 Côté rot. M14x1.5 long 303 mm

1.2	DNA	FC0A	03/02/99-
1.2	DNA	FC01/0F/1A	
1.4	DNA	FC0C/0H	03/02/99-
1.4	DNA	FC0B/0M	
1.5 DCi	DNA	FC07/09	
1.6	DNA Susp. renforcée	FC00	
1.9 D	DNA	FC0D/0E	03/02/99-
1.9 D	DNA	FC02/0J/0N	
1.9 DTi	DNA	FC0U	

3008040 Axe de bielle G/D

Part/oe 7701472120 L/R axial joint



14 Côté dir. M12x1.0 Côté rot. M14x1.5 long 305 mm

1.2	DA	FC0A	03/02/99-
1.2	DA	FC01/0F/1A	
1.2i 16v.	DA	FC0T/0W/05/1D/1K/1P	
1.4	DA	FC0C/0H	03/02/99-
1.4	DA	FC0B/0M	
1.5 DCi	DA	FC07/9	
1.6	DA	FC00	
1.6i 16v. 2WD		FC0P	
1.9 D	DA	FC0D/0E	03/02/99-
1.9 D	DA	FC02/0J/0N	
1.9 DCi 2WD		FC0V	
1.9 DTi	DA	FC0U	
TT Elec. /All models Electric		FC0Z	

3008181 Axe de bielle G/D

Part/oe 7701470763 L/R axial joint



14 Côté dir. M12x1.0 Côté rot. M14x1.5 long 264 mm

DNA Sauf tout chemin

1.2	FC0A	-03/02/99
1.4	FC0C/0H	-03/02/99
1.9 D	FC0D/0E	-03/02/99

3008243 Axe de bielle G/D

Part/oe 7701473656 L/R axial joint











14 Côté dir. M12x1.0 Côté rot. M14x1.5 long 314 mm

1.6i 16v. 4WD	FC0P
1.9 DCi 4WD	FC0V

... Kangoo I -02/03 VU ...

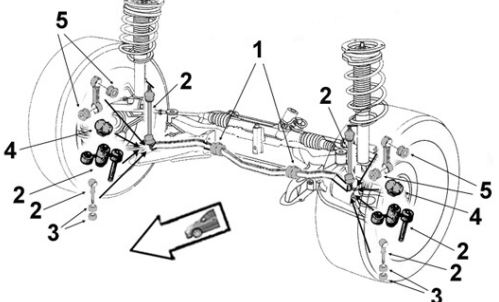
RENAULT

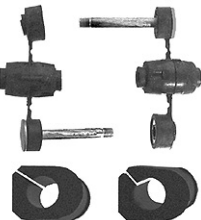
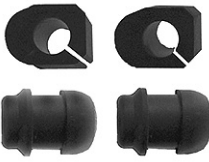

<p>4006108 OE 7701470765</p> 	<p>Rotule de direction G <i>Left tie rod end</i></p> <p>9</p> <p>1.2 FC0A -03/02/99</p>	<p>4006109 OE 7701470766</p> 	<p>Rotule de direction D <i>Right tie rod end</i></p> <p>8</p> <p>1.2 FC0A -03/02/99</p>
<p>4006134 OE 7701474641</p> 	<p>Rotule de direction G <i>Left tie rod end</i></p> <p>9</p> <p>1.0 1.2 sauf type FC0A 1.2 FC0A 03/02/99- 1.2i 16v. 1.4 1.5 DCi 1.6 1.6i 16v. 1.9 D 1.9 DCi 1.9 DTi</p>	<p>4006135 OE 7701047813</p> 	<p>Rotule de direction D <i>Right tie rod end</i></p> <p>8</p> <p>1.0 1.2 sauf type FC0A 1.2 FC0A 03/02/99- 1.2i 16v. 1.4 1.5 DCi 1.6 1.6i 16v. 1.9 D 1.9 DCi 1.9 DTi</p>
 <p>Barre stabilisatrice <i>Stabilizer bar</i> <i>Barra estabilizadora</i> <i>Drażek stabilizatora</i> <i>стабилизатор поперечной устойчивости</i></p>			
<p>4005148 OE 7700437136</p> 	<p>Biellette barre stab. <i>Stabilizer bar stub axle</i></p> <p>2</p> <p>1.6i 16v. 4WD FC0P/0S 1.9 DCi 4WD FC0V</p>	<p>4001505 OE 7700799404+7703034237</p> 	<p>Palier de barre bout <i>End bar main bearing</i></p> <p>2</p> <p>1.2i /GPL tout chemin Sans protection spéciale FC01/0A/0F 1.2i /GPL FC1A/1H 1.2i 16v. FC05/0T/0W/1D/1K/1P 1.4i FC0B/C/H/M 1.5 DCi FC07/08/09/1F/1G/1R/1S 1.6i 16v. 2WD FC0L/0P/0S/1N 1.9 D FC0D/0E/0J/0N 1.9 DCi 2WD tout chemin Sans protection spéciale FC0U/0V 1.9 DTi tout chemin Sans protection spéciale FC0U/0V</p>
<p>4005134 OE 7700314855</p> 	<p>Palier de barre bout <i>End bar main bearing</i></p> <p>4 Barre Ø 23</p> <p>1.2i 16v. tout chemin FC1P 1.6i FC00 1.6i 16v. FC0R/1B FC1M 1.9 D tout chemin FC0D/0E 1.9 D FC02 1.9 DCi 2WD tout chemin FC0V 1.9 DTi tout chemin FC0U</p>	<p>4001476 OE 7700785788</p> 	<p>Palier de barre milieu <i>Middle bar main bearing</i></p> <p>1 Barre Ø 23</p> <p>1.2i / GPL FC01/0A/1A 1.2i 16v. FC1D/1P 1.4 FC0C/0H 1.5 DCi FC07/08/09 1.6i FC00 1.6i 16v. FC0P/0R/0S/1B/1M 1.9 D FC02/0D/0E 1.9 DCi FC0V 1.9 DTi FC0U</p>
<p>4005078 OE -</p> 	<p>Kit rép. barre stab. G et D <i>L R Stabilizing bar repair kit</i></p> <p>Barre percée Ø 23</p> <p>1.2 FC05/0T/0W/1D/1P 1.2 sauf tout chemin FC1P 1.2i 16v. FC1A 1.2i 16v. sauf tout chemin FC01/0A/0F 1.4 FC0C/0H 1.5 DCi FC07 1.6i 16v. 2WD FC0P 1.9 D FC0N 1.9 D sauf tout chemin FC0D/0E/0J 1.9 DTi Sauf tout chemin FC0U TT Elec. /All models Electric FC0Z</p>	<p>4005080 OE -</p> 	<p>Kit rép. barre stab. G et D <i>L R Stabilizing bar repair kit</i></p> <p>Barre Ø 23</p> <p>1.6 FC00 1.9 D FC02 1.9 D Véhicule tout chemin FC0D/0E/0J 1.9 DTi Véhicule tout chemin FC0U</p>

... Kangoo I -02/03 VU ...



Eléments SUSPENSION

Suspension parts
Elementos suspensión
Elementy zawieszenia
Элементы подвески

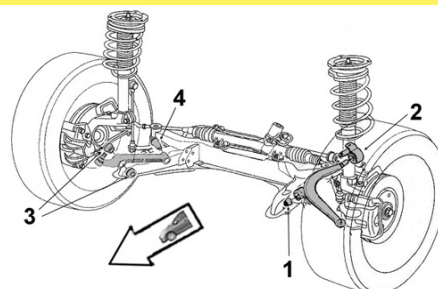

RENAULT

SASIC

4001546

Articulation AV/AR

OE 8200711554

Front rear bush



1	Ø int.12 Ø ext.45 coll.59 long. tube int.46 ext.30 ep. coll.4																																																
2	<table border="0"> <tr> <td>1.2</td> <td></td> <td>FC01/1A</td> <td></td> </tr> <tr> <td>1.2</td> <td>Véhicule tout chemin</td> <td>FC0A</td> <td>-03/03/99</td> </tr> <tr> <td>1.2</td> <td></td> <td>FC0A</td> <td>03/03/99-</td> </tr> <tr> <td>1.2i 16v.</td> <td></td> <td>FC05/1D/1P</td> <td></td> </tr> <tr> <td>1.4</td> <td></td> <td>FC0H</td> <td></td> </tr> <tr> <td>1.4</td> <td></td> <td>FC0C</td> <td>03/03/99-</td> </tr> <tr> <td>1.6i</td> <td></td> <td>FC00</td> <td></td> </tr> <tr> <td>1.6i 16v.</td> <td></td> <td>FC0R/1B FC1M</td> <td></td> </tr> <tr> <td>1.6i 16v. 2WD</td> <td></td> <td>FC0P/0S</td> <td></td> </tr> <tr> <td>1.9 D</td> <td></td> <td>FC02</td> <td></td> </tr> <tr> <td>1.9 D Véhicule tout chemin</td> <td></td> <td>FC0D/0E</td> <td></td> </tr> <tr> <td>1.9 DTi Véhicule tout chemin</td> <td></td> <td>FC0U</td> <td></td> </tr> </table>	1.2		FC01/1A		1.2	Véhicule tout chemin	FC0A	-03/03/99	1.2		FC0A	03/03/99-	1.2i 16v.		FC05/1D/1P		1.4		FC0H		1.4		FC0C	03/03/99-	1.6i		FC00		1.6i 16v.		FC0R/1B FC1M		1.6i 16v. 2WD		FC0P/0S		1.9 D		FC02		1.9 D Véhicule tout chemin		FC0D/0E		1.9 DTi Véhicule tout chemin		FC0U	
1.2		FC01/1A																																															
1.2	Véhicule tout chemin	FC0A	-03/03/99																																														
1.2		FC0A	03/03/99-																																														
1.2i 16v.		FC05/1D/1P																																															
1.4		FC0H																																															
1.4		FC0C	03/03/99-																																														
1.6i		FC00																																															
1.6i 16v.		FC0R/1B FC1M																																															
1.6i 16v. 2WD		FC0P/0S																																															
1.9 D		FC02																																															
1.9 D Véhicule tout chemin		FC0D/0E																																															
1.9 DTi Véhicule tout chemin		FC0U																																															

4001540

Articulation AV/AR

OE 8200651161

Front rear bush



1	Ø int.12 Ø ext.45.5 coll.59																												
2	long. tube int.46 ext.29.5 ep. coll.4																												
	<table border="0"> <tr> <td>1.2</td> <td>sauf tout chemin</td> <td>FC0A</td> <td>-03/03/99</td> </tr> <tr> <td>1.4</td> <td></td> <td>FC0C</td> <td>-03/03/99</td> </tr> <tr> <td>1.5 DCi 2WD</td> <td>sauf tout chemin</td> <td></td> <td></td> </tr> <tr> <td></td> <td></td> <td>FC07/08/09</td> <td></td> </tr> <tr> <td>1.9 D</td> <td>sauf tout chemin</td> <td>FC0D/0E</td> <td></td> </tr> <tr> <td>1.9 DCi 2WD</td> <td>sauf tout chemin</td> <td>FC0V</td> <td></td> </tr> <tr> <td>1.9 DTi</td> <td>sauf tout chemin</td> <td>FC0U</td> <td></td> </tr> </table>	1.2	sauf tout chemin	FC0A	-03/03/99	1.4		FC0C	-03/03/99	1.5 DCi 2WD	sauf tout chemin					FC07/08/09		1.9 D	sauf tout chemin	FC0D/0E		1.9 DCi 2WD	sauf tout chemin	FC0V		1.9 DTi	sauf tout chemin	FC0U	
1.2	sauf tout chemin	FC0A	-03/03/99																										
1.4		FC0C	-03/03/99																										
1.5 DCi 2WD	sauf tout chemin																												
		FC07/08/09																											
1.9 D	sauf tout chemin	FC0D/0E																											
1.9 DCi 2WD	sauf tout chemin	FC0V																											
1.9 DTi	sauf tout chemin	FC0U																											

4005502

Articulation AV/AR

OE 8200033379

Front rear bush



1	Ø int.12 Ø ext.45 coll.47.8		
2	long. tube int.46 ext.29 ep. Coll.4.1		
	<table border="0"> <tr> <td>1.6i 16v. 4WD</td> <td>FC0L/0P/0S</td> </tr> </table>	1.6i 16v. 4WD	FC0L/0P/0S
1.6i 16v. 4WD	FC0L/0P/0S		

Bras & Triangle de suspension

Control arm
Brazo y triángulo
Wahacz
Рычаг подвески

G/L  D/R



4003210

Triangle de susp. G

OE 7701474869

Left track control arm



4	Sans rotule Without tie rod end																																																												
	<table border="0"> <tr> <td>1.2</td> <td>Véhicule tout chemin</td> <td>FC0A</td> <td></td> </tr> <tr> <td>1.2</td> <td>sauf tout chemin</td> <td>FC0A</td> <td>03/03/99-</td> </tr> <tr> <td>1.2</td> <td>Véhicule tout chemin</td> <td>FC0F</td> <td></td> </tr> <tr> <td>1.2</td> <td>sauf tout chemin</td> <td>FC0F</td> <td>-28/03/01</td> </tr> <tr> <td>1.2</td> <td></td> <td>FC01</td> <td>-28/03/01</td> </tr> <tr> <td>1.2i 16v.</td> <td></td> <td>FC05</td> <td>-28/03/01</td> </tr> <tr> <td>1.4</td> <td></td> <td>FC0B/H/M</td> <td>-28/03/01</td> </tr> <tr> <td>1.4</td> <td></td> <td>FC0C</td> <td>03/03/99-</td> </tr> <tr> <td>1.5 DCi 2WD Véhicule tout chemin</td> <td></td> <td>FC07</td> <td></td> </tr> <tr> <td>1.6</td> <td></td> <td>FC00</td> <td></td> </tr> <tr> <td>1.6i 16v. 2WD</td> <td></td> <td>FC0P</td> <td>-28/03/01</td> </tr> <tr> <td>1.9 D</td> <td></td> <td>FC02</td> <td></td> </tr> <tr> <td>1.9 D Véhicule tout chemin</td> <td></td> <td>FC0D/E/J/N</td> <td></td> </tr> <tr> <td>1.9 DCi 2WD Véhicule tout chemin</td> <td></td> <td>FC0V</td> <td></td> </tr> <tr> <td>1.9 DTi Véhicule tout chemin</td> <td></td> <td>FC0U</td> <td></td> </tr> </table>	1.2	Véhicule tout chemin	FC0A		1.2	sauf tout chemin	FC0A	03/03/99-	1.2	Véhicule tout chemin	FC0F		1.2	sauf tout chemin	FC0F	-28/03/01	1.2		FC01	-28/03/01	1.2i 16v.		FC05	-28/03/01	1.4		FC0B/H/M	-28/03/01	1.4		FC0C	03/03/99-	1.5 DCi 2WD Véhicule tout chemin		FC07		1.6		FC00		1.6i 16v. 2WD		FC0P	-28/03/01	1.9 D		FC02		1.9 D Véhicule tout chemin		FC0D/E/J/N		1.9 DCi 2WD Véhicule tout chemin		FC0V		1.9 DTi Véhicule tout chemin		FC0U	
1.2	Véhicule tout chemin	FC0A																																																											
1.2	sauf tout chemin	FC0A	03/03/99-																																																										
1.2	Véhicule tout chemin	FC0F																																																											
1.2	sauf tout chemin	FC0F	-28/03/01																																																										
1.2		FC01	-28/03/01																																																										
1.2i 16v.		FC05	-28/03/01																																																										
1.4		FC0B/H/M	-28/03/01																																																										
1.4		FC0C	03/03/99-																																																										
1.5 DCi 2WD Véhicule tout chemin		FC07																																																											
1.6		FC00																																																											
1.6i 16v. 2WD		FC0P	-28/03/01																																																										
1.9 D		FC02																																																											
1.9 D Véhicule tout chemin		FC0D/E/J/N																																																											
1.9 DCi 2WD Véhicule tout chemin		FC0V																																																											
1.9 DTi Véhicule tout chemin		FC0U																																																											

4003211

Triangle de susp. D

OE 7701474870

Right track control arm









3	Sans rotule Without tie rod end																																																												
	<table border="0"> <tr> <td>1.2</td> <td>Véhicule tout chemin</td> <td>FC0A</td> <td></td> </tr> <tr> <td>1.2</td> <td>sauf tout chemin</td> <td>FC0A</td> <td>03/03/99-</td> </tr> <tr> <td>1.2</td> <td>Véhicule tout chemin</td> <td>FC0F</td> <td></td> </tr> <tr> <td>1.2</td> <td>sauf tout chemin</td> <td>FC0F</td> <td>-28/03/01</td> </tr> <tr> <td>1.2</td> <td></td> <td>FC01</td> <td>-28/03/01</td> </tr> <tr> <td>1.2i 16v.</td> <td></td> <td>FC05</td> <td>-28/03/01</td> </tr> <tr> <td>1.4</td> <td></td> <td>FC0B/H/M</td> <td>-28/03/01</td> </tr> <tr> <td>1.4</td> <td></td> <td>FC0C</td> <td>03/03/99-</td> </tr> <tr> <td>1.5 DCi 2WD Véhicule tout chemin</td> <td></td> <td>FC07</td> <td></td> </tr> <tr> <td>1.6</td> <td></td> <td>FC00</td> <td></td> </tr> <tr> <td>1.6i 16v. 2WD</td> <td></td> <td>FC0P</td> <td>-28/03/01</td> </tr> <tr> <td>1.9 D</td> <td></td> <td>FC02</td> <td></td> </tr> <tr> <td>1.9 D Véhicule tout chemin</td> <td></td> <td>FC0D/E/J/N</td> <td></td> </tr> <tr> <td>1.9 DCi 2WD Véhicule tout chemin</td> <td></td> <td>FC0V</td> <td></td> </tr> <tr> <td>1.9 DTi Véhicule tout chemin</td> <td></td> <td>FC0U</td> <td></td> </tr> </table>	1.2	Véhicule tout chemin	FC0A		1.2	sauf tout chemin	FC0A	03/03/99-	1.2	Véhicule tout chemin	FC0F		1.2	sauf tout chemin	FC0F	-28/03/01	1.2		FC01	-28/03/01	1.2i 16v.		FC05	-28/03/01	1.4		FC0B/H/M	-28/03/01	1.4		FC0C	03/03/99-	1.5 DCi 2WD Véhicule tout chemin		FC07		1.6		FC00		1.6i 16v. 2WD		FC0P	-28/03/01	1.9 D		FC02		1.9 D Véhicule tout chemin		FC0D/E/J/N		1.9 DCi 2WD Véhicule tout chemin		FC0V		1.9 DTi Véhicule tout chemin		FC0U	
1.2	Véhicule tout chemin	FC0A																																																											
1.2	sauf tout chemin	FC0A	03/03/99-																																																										
1.2	Véhicule tout chemin	FC0F																																																											
1.2	sauf tout chemin	FC0F	-28/03/01																																																										
1.2		FC01	-28/03/01																																																										
1.2i 16v.		FC05	-28/03/01																																																										
1.4		FC0B/H/M	-28/03/01																																																										
1.4		FC0C	03/03/99-																																																										
1.5 DCi 2WD Véhicule tout chemin		FC07																																																											
1.6		FC00																																																											
1.6i 16v. 2WD		FC0P	-28/03/01																																																										
1.9 D		FC02																																																											
1.9 D Véhicule tout chemin		FC0D/E/J/N																																																											
1.9 DCi 2WD Véhicule tout chemin		FC0V																																																											
1.9 DTi Véhicule tout chemin		FC0U																																																											

... Kangoo I -02/03 VU ...

RENAULT



<p>4003226 Part/oe 8200254163</p> 	<p>Triangle de susp. G <i>Left track control arm</i></p> <p>4 Sans rotule <i>Without tie rod end</i></p> <p>1.2 2WD FC01 28/03/01- 1.2 2WD sauf tout chemin FC0F 28/03/01- 1.2 2WD FC1A 1.2i 16v. FC05 28/03/01- 1.2i 16v. 2WD FC0T -18/09/02 1.2i 16v. 2WD FC0T/1D/1P/1K 19/09/02- 1.4 2WD sauf tout chemin FC0B/0M 19/09/02- 1.4 2WD FC0B/0M 28/03/01-18/09/02 1.5 DCi 2WD sauf tout chemin FC07 28/03/01- 1.6i 16v. 2WD FC0P 28/03/01-18/09/02 1.6i 16v. 2WD sauf tout chemin FC0P 19/09/02- 1.9 D 2WD sauf tout chemin FC0E/0J/0N 28/03/01- 1.9 DCi 2WD Sauf tout chemin FC0V 28/03/01-18/09/02 TT Elec. /All models Electric FC0Z</p>	<p>4003227 Part/oe 8200254166</p> 	<p>Triangle de susp. D <i>Right track control arm</i></p> <p>3 Sans rotule <i>Without tie rod end</i></p> <p>1.2 2WD FC01 28/03/01- 1.2 2WD sauf tout chemin FC0F 28/03/01- 1.2 2WD FC1A 1.2i 16v. FC05 28/03/01- 1.2i 16v. 2WD FC0T -18/09/02 1.2i 16v. 2WD FC0T/1D/1P/1K 19/09/02- 1.4 2WD sauf tout chemin FC0B/0M 19/09/02- 1.4 2WD FC0B/0M 28/03/01-18/09/02 1.5 DCi 2WD sauf tout chemin FC07 28/03/01- 1.6i 16v. 2WD FC0P 28/03/01-18/09/02 1.6i 16v. 2WD sauf tout chemin FC0P 19/09/02- 1.9 D 2WD sauf tout chemin FC0E/0J/0N 28/03/01- 1.9 DCi 2WD Sauf tout chemin FC0V 28/03/01-18/09/02 TT Elec. /All models Electric FC0Z</p>																																																
<p>4003367 OE 8200197179</p> 	<p>Triangle de susp. G <i>Left track control arm</i></p> <p>4 Avec rotule <i>With ball joint</i></p> <p>1.2 sauf tout chemin FC0A -03/03/99 1.4 FC0C -03/03/99 1.9 D sauf tout chemin FC0D 1.9 D sauf tout chemin FC0E/0J/0N -28/03/01 1.9 DCi 2WD sauf tout chemin FC0V -28/03/01 1.9 DTi sauf tout chemin FC0U</p>	<p>4003366 OE 8200197187</p> 	<p>Triangle de susp. D <i>Right track control arm</i></p> <p>3 Avec rotule <i>With ball joint</i></p> <p>1.2 sauf tout chemin FC0A -03/03/99 1.4 FC0C -03/03/99 1.9 D sauf tout chemin FC0D 1.9 D sauf tout chemin FC0E/0J/0N -28/03/01 1.9 DCi 2WD sauf tout chemin FC0V -28/03/01 1.9 DTi sauf tout chemin FC0U</p>																																																
<p>7474030 OE 8200942407</p> <p>NEW</p> 	<p>Triangle de susp. G <i>Left track control arm</i></p> <p>4 Avec rotule <i>With ball joint Ø 16</i></p> <p>Chemin normal Sans protection spéciale</p> <p>1.2i 2WD /GPL FC0A D7F710/20/22 -03/03/99 1.4i 2WD FC0C E7J780 -03/03/99 1.9 D 2WD FC0E/0J/0N F8Q630/32 -28/03/01 1.9 D 2WD FC0D F8Q662 1.9 DCi 2WD FC0V F9Q782/90 -28/03/01 1.9 DTi 2WD FC0U F9Q780</p>	<p>7474029 OE 8200942408</p> <p>NEW</p> 	<p>Triangle de susp. D <i>Right track control arm</i></p> <p>3 Avec rotule <i>With ball joint Ø 16</i></p> <p>Chemin normal Sans protection spéciale</p> <p>1.2i 2WD /GPL FC0A D7F710/20/22 -03/03/99 1.4i 2WD FC0C E7J780 -03/03/99 1.9 D 2WD FC0E/0J/0N F8Q630/32 -28/03/01 1.9 D 2WD FC0D F8Q662 1.9 DCi 2WD FC0V F9Q782/90 -28/03/01 1.9 DTi 2WD FC0U F9Q780</p>																																																
<p>4005273 OE 7701468411</p> 	<p>Rotule de susp. inf. G/D <i>L/R lower suspension ball joint</i></p> <p>1 Trous fixation Ø10</p> <table border="0"> <tr> <td>1.2</td> <td></td> <td>FC01</td> <td>-28/03/01</td> </tr> <tr> <td>1.2</td> <td>sauf tout chemin</td> <td>FC0A</td> <td>03/03/99-</td> </tr> <tr> <td>1.2</td> <td>Véhicule tout chemin</td> <td>FC0A/0F</td> <td></td> </tr> <tr> <td>1.2</td> <td>sauf tout chemin</td> <td>FC0F</td> <td>-28/03/01</td> </tr> <tr> <td>1.2i 16v.</td> <td></td> <td>FC05</td> <td>-28/03/01</td> </tr> <tr> <td>1.6</td> <td></td> <td>FC00</td> <td></td> </tr> <tr> <td>1.6i 16v. 2WD</td> <td></td> <td>FC0R</td> <td></td> </tr> <tr> <td>1.9 D</td> <td></td> <td>FC02</td> <td></td> </tr> <tr> <td>1.9 D</td> <td>Véhicule tout chemin</td> <td>FC0J/0N</td> <td></td> </tr> <tr> <td>1.9 D 2WD</td> <td>Véhicule tout chemin</td> <td>FC0D/0E</td> <td></td> </tr> <tr> <td>1.9 DCi 2WD</td> <td>Véhicule tout chemin</td> <td>FC0V</td> <td></td> </tr> <tr> <td>1.9 DTi</td> <td>Véhicule tout chemin</td> <td>FC0U</td> <td></td> </tr> </table>			1.2		FC01	-28/03/01	1.2	sauf tout chemin	FC0A	03/03/99-	1.2	Véhicule tout chemin	FC0A/0F		1.2	sauf tout chemin	FC0F	-28/03/01	1.2i 16v.		FC05	-28/03/01	1.6		FC00		1.6i 16v. 2WD		FC0R		1.9 D		FC02		1.9 D	Véhicule tout chemin	FC0J/0N		1.9 D 2WD	Véhicule tout chemin	FC0D/0E		1.9 DCi 2WD	Véhicule tout chemin	FC0V		1.9 DTi	Véhicule tout chemin	FC0U	
1.2		FC01	-28/03/01																																																
1.2	sauf tout chemin	FC0A	03/03/99-																																																
1.2	Véhicule tout chemin	FC0A/0F																																																	
1.2	sauf tout chemin	FC0F	-28/03/01																																																
1.2i 16v.		FC05	-28/03/01																																																
1.6		FC00																																																	
1.6i 16v. 2WD		FC0R																																																	
1.9 D		FC02																																																	
1.9 D	Véhicule tout chemin	FC0J/0N																																																	
1.9 D 2WD	Véhicule tout chemin	FC0D/0E																																																	
1.9 DCi 2WD	Véhicule tout chemin	FC0V																																																	
1.9 DTi	Véhicule tout chemin	FC0U																																																	

... Kangoo I -02/03 VU ...

Bras & Triangle de suspension

Control arm
Brazo y triángulo
Wahacz
Рычаг подвески

G/L  D/R



RENAULT

SASIC

4005257

Rotule de susp. inf. G/D

OE 7701472038

L/R lower suspension ball joint



1
2

Trous fixation Ø10

1.2 2WD		FC1A	-18/09/02
1.2i 16v.		FC05	28/03/01-18/09/02
1.2i 16v. 2WD		FC0T/0W	-18/09/02
1.4		FC0B/0M	-28/03/01
1.4 2WD		FC0C/0H	-18/09/02
1.4 2WD		FC0B/0M	28/03/01-18/09/02
1.5 DCi 2WD	sauf tout chemin	FC07	28/03/01-18/09/02
1.5 DCi 2WD		FC08/09	-18/09/02
1.6i 16v. 2WD		FC0L/0S	-18/09/02
1.6i 16v. 2WD		FC0P	-18/09/02
1.9 D 2WD	sauf tout chemin	FC0N/0E/0J/0N	28/03/01-18/09/02
1.9 DCi 2WD	sauf tout chemin	FC0V	28/03/01-18/09/02
1.9 DTi 2WD	sauf tout chemin	FC0U	-18/09/02

4005277

Rotule de susp. inf. G/D

Part/oe 8200942407 L/R lower suspension ball joint



1
2

Trous fixation Ø12

1.2 2WD	sauf tout chemin	FC0F	28/03/01-
1.2 2WD		FC01	28/03/01-
1.2 2WD		FC1A	19/09/02-
1.2i 16v.		FC05	19/09/02-
1.2i 16v. 2WD		FC0T/1D/1P/1K	19/09/02-
1.2i 16v. 2WD	sauf tout chemin	FC0W	19/09/02-
1.4 2WD	sauf tout chemin	FC0B/0M	19/09/02-
1.5 DCi 2WD	sauf tout chemin	FC07/9	19/09/02-
1.6i 16v. 2WD	sauf tout chemin	FC0P	19/09/02-
1.9 D 2WD	sauf tout chemin	FC0E/0J/0N	19/09/02-
1.9 DTi 2WD	sauf tout chemin	FC0U	19/09/02-

4005423

Kit rép. triangle susp. G ou D

OE -

L or R track control arm bearing repair kit

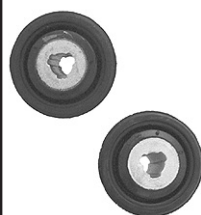

Sans visserie Without screws and bolts

1.2		FC05/0T/0W/1D/1P
1.2i 16v.		FC0A/0F/01/1A
1.4		FC0C/0H
1.5 DCi		FC07
1.6		FC00
1.6i 16v. 2WD		FC0P
1.9 D		FC0D/E/J/N/2
1.9 DCi 2WD		FC0V
1.9 DTi		FC0U
TT Elec. /All models Electric		FC0Z

7964003

Kit rép. train AV

OE -

Front axle repair kit



Sans visserie Without screws and bolts

1.4	FC0C	-03/03/99
1.9 D	sauf tout chemin	FC0D/0E
1.9 DTi	sauf tout chemin	FC0U

405A423S

Kit rép. train AV

OE -

Front axle repair kit



Sans visserie Without screws and bolts Barre Ø 23

1.6	FC00
1.9 D	FC02
1.9 D	Véhicule tout chemin FC0D/0E/0J
1.9 DTi	Véhicule tout chemin FC0U

... Kangoo I -02/03 VU ...





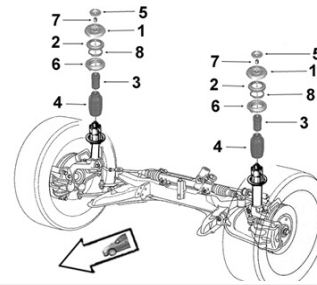



Support d'amortisseur
 Suspension mounting
 Soporte amortiguador
 Poduszka amortyzatora
 Опора амортизатора



RENAULT

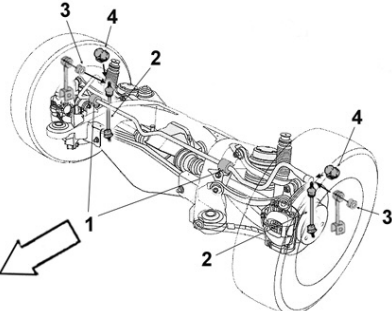

<p>4001620 OE 7700426450</p> 	<p>Coupelle rebond. <i>Spring cup</i></p> <p>5</p> <table style="width: 100%; border-collapse: collapse;"> <tr><td style="width: 15%;">1.2</td><td style="width: 15%;">FC01/0A/1A</td></tr> <tr><td>1.2i 16v.</td><td>FC1D/1P</td></tr> <tr><td>1.4</td><td>FC0C/0H</td></tr> <tr><td>1.5 DCi</td><td>FC07/08/09</td></tr> <tr><td>1.6i</td><td>FC00</td></tr> <tr><td>1.6i 16v.</td><td>FC0P/0R/0S/1B/1M</td></tr> <tr><td>1.9 D</td><td>FC02/0D/0E</td></tr> <tr><td>1.9 DCi</td><td>FC0V</td></tr> <tr><td>1.9 DTi</td><td>FC0U</td></tr> </table>	1.2	FC01/0A/1A	1.2i 16v.	FC1D/1P	1.4	FC0C/0H	1.5 DCi	FC07/08/09	1.6i	FC00	1.6i 16v.	FC0P/0R/0S/1B/1M	1.9 D	FC02/0D/0E	1.9 DCi	FC0V	1.9 DTi	FC0U	<p>4001615 OE 7700829529</p> 	<p>Tampon suspension G/D <i>L/R susp. rebound stop</i></p> <p>1</p> <table style="width: 100%; border-collapse: collapse;"> <tr><td style="width: 15%;">1.2</td><td style="width: 15%;">FC01/0A/1A</td></tr> <tr><td>1.2i 16v.</td><td>FC1D/1P</td></tr> <tr><td>1.4</td><td>FC0C/0H</td></tr> <tr><td>1.5 DCi</td><td>FC07/08/09</td></tr> <tr><td>1.6i</td><td>FC00</td></tr> <tr><td>1.6i 16v.</td><td>FC1M</td></tr> <tr><td>1.9 D</td><td>FC02/0D/0E</td></tr> <tr><td>1.9 DCi</td><td>FC0V</td></tr> <tr><td>1.9 DTi</td><td>FC0U</td></tr> </table>	1.2	FC01/0A/1A	1.2i 16v.	FC1D/1P	1.4	FC0C/0H	1.5 DCi	FC07/08/09	1.6i	FC00	1.6i 16v.	FC1M	1.9 D	FC02/0D/0E	1.9 DCi	FC0V	1.9 DTi	FC0U
1.2	FC01/0A/1A																																						
1.2i 16v.	FC1D/1P																																						
1.4	FC0C/0H																																						
1.5 DCi	FC07/08/09																																						
1.6i	FC00																																						
1.6i 16v.	FC0P/0R/0S/1B/1M																																						
1.9 D	FC02/0D/0E																																						
1.9 DCi	FC0V																																						
1.9 DTi	FC0U																																						
1.2	FC01/0A/1A																																						
1.2i 16v.	FC1D/1P																																						
1.4	FC0C/0H																																						
1.5 DCi	FC07/08/09																																						
1.6i	FC00																																						
1.6i 16v.	FC1M																																						
1.9 D	FC02/0D/0E																																						
1.9 DCi	FC0V																																						
1.9 DTi	FC0U																																						
<p>4005300 OE 8200651172</p> 	<p>Butée à billes G/D <i>L/R ball bearing</i></p> <p>2</p> <table style="width: 100%; border-collapse: collapse;"> <tr><td style="width: 15%;">1.2i / GPL</td><td style="width: 15%;">FC01/0A/1A</td></tr> <tr><td>1.2i 16v.</td><td>FC1D/1P</td></tr> <tr><td>1.4</td><td>FC0C/0H</td></tr> <tr><td>1.5 DCi</td><td>FC07/08/09</td></tr> <tr><td>1.6i</td><td>FC00</td></tr> <tr><td>1.6i 16v.</td><td>FC0P/0R/0S/1B/1M</td></tr> <tr><td>1.9 D</td><td>FC02/0D/0E</td></tr> <tr><td>1.9 DCi</td><td>FC0V</td></tr> <tr><td>1.9 DTi</td><td>FC0U</td></tr> </table>	1.2i / GPL	FC01/0A/1A	1.2i 16v.	FC1D/1P	1.4	FC0C/0H	1.5 DCi	FC07/08/09	1.6i	FC00	1.6i 16v.	FC0P/0R/0S/1B/1M	1.9 D	FC02/0D/0E	1.9 DCi	FC0V	1.9 DTi	FC0U	<p>4005373 OE 7700802667</p> 	<p>Butée protecteur susp. G/D <i>L/R suspension bush</i></p> <p>3 4</p> <table style="width: 100%; border-collapse: collapse;"> <tr><td style="width: 15%;">1.2i / GPL</td><td style="width: 15%;">FC01/0A/1A</td></tr> <tr><td>1.2i 16v.</td><td>FC1D/1P</td></tr> <tr><td>1.4</td><td>FC0C/0H</td></tr> <tr><td>1.5 DCi</td><td>FC07/08/09</td></tr> <tr><td>1.6i 16v.</td><td>FC0L/0P/0R/0S/1B/1M</td></tr> <tr><td>1.9 D</td><td>FC02/0D/0E</td></tr> <tr><td>1.9 DCi</td><td>FC0V</td></tr> <tr><td>1.9 DTi</td><td>FC0U</td></tr> </table>	1.2i / GPL	FC01/0A/1A	1.2i 16v.	FC1D/1P	1.4	FC0C/0H	1.5 DCi	FC07/08/09	1.6i 16v.	FC0L/0P/0R/0S/1B/1M	1.9 D	FC02/0D/0E	1.9 DCi	FC0V	1.9 DTi	FC0U		
1.2i / GPL	FC01/0A/1A																																						
1.2i 16v.	FC1D/1P																																						
1.4	FC0C/0H																																						
1.5 DCi	FC07/08/09																																						
1.6i	FC00																																						
1.6i 16v.	FC0P/0R/0S/1B/1M																																						
1.9 D	FC02/0D/0E																																						
1.9 DCi	FC0V																																						
1.9 DTi	FC0U																																						
1.2i / GPL	FC01/0A/1A																																						
1.2i 16v.	FC1D/1P																																						
1.4	FC0C/0H																																						
1.5 DCi	FC07/08/09																																						
1.6i 16v.	FC0L/0P/0R/0S/1B/1M																																						
1.9 D	FC02/0D/0E																																						
1.9 DCi	FC0V																																						
1.9 DTi	FC0U																																						
<p>4005229 OE -</p> 	<p>Kit rép. suspension G ou D <i>L/R stabilizing bar repair kit</i></p> <table style="width: 100%; border-collapse: collapse;"> <tr><td style="width: 15%;">1.2</td><td style="width: 15%;">FC05/0T/0W/1D/1P</td></tr> <tr><td>1.2i 16v.</td><td>FC01/0A/0F/1A</td></tr> <tr><td>1.4</td><td>FC0C/0H</td></tr> <tr><td>1.5 DCi</td><td>FC07</td></tr> <tr><td>1.6</td><td>FC00</td></tr> <tr><td>1.6i 16v.</td><td>FC0P</td></tr> <tr><td>1.9 D</td><td>FC02/0D/0E/0J/0N</td></tr> <tr><td>1.9 DCi</td><td>FC0V</td></tr> <tr><td>1.9 DTi</td><td>FC0U</td></tr> <tr><td>TT Elec. /All models Electric</td><td>FC0Z</td></tr> </table>			1.2	FC05/0T/0W/1D/1P	1.2i 16v.	FC01/0A/0F/1A	1.4	FC0C/0H	1.5 DCi	FC07	1.6	FC00	1.6i 16v.	FC0P	1.9 D	FC02/0D/0E/0J/0N	1.9 DCi	FC0V	1.9 DTi	FC0U	TT Elec. /All models Electric	FC0Z																
1.2	FC05/0T/0W/1D/1P																																						
1.2i 16v.	FC01/0A/0F/1A																																						
1.4	FC0C/0H																																						
1.5 DCi	FC07																																						
1.6	FC00																																						
1.6i 16v.	FC0P																																						
1.9 D	FC02/0D/0E/0J/0N																																						
1.9 DCi	FC0V																																						
1.9 DTi	FC0U																																						
TT Elec. /All models Electric	FC0Z																																						
<p>Barre stabilisatrice Stabilizer bar Barra estabilizadora Drażek stabilizatora стабилизатор поперечной устойчивости</p>																																							
<p>4005149 OE 7700436706</p> 	<p>Biellette barre stab. <i>Stabilizer bar stub axle</i></p> <p>2</p> <table style="width: 100%; border-collapse: collapse;"> <tr><td style="width: 15%;">1.9 DCi 4WD</td><td style="width: 15%;">FC0V</td></tr> </table>			1.9 DCi 4WD	FC0V																																		
1.9 DCi 4WD	FC0V																																						

... Kangoo I -02/03 VU

Eléments TRAIN ARRIERE

Rear axle parts

Tren TRAS

Elementy zawieszenia tylnego

элементы задней оси.



SASIC

RENAULT

4005350B

Kit rép. train AR G ou D

OE -

L/R rear axle repair kit



Train à tube

1.2	FC01/0A/0F
1.2i 16v.	FC05/0T/0W/1D/1P/1K
1.4	FC0B/C/H/M
1.5 DCi	FC07
1.6	FC00
1.6i 16v.	FC0P
1.9 D	FC02/0D/0E/0J/0N
1.9 DCi	FC0V
1.9 DTi	FC0U
TT Elec. /All models Electric	FC0Z

Kangoo I 03/03-12/07 VU ...

Eléments DIRECTION

Steering parts

Elementos Direcciones

Elementy uklad kierowniczy

Элементы рулевой системы

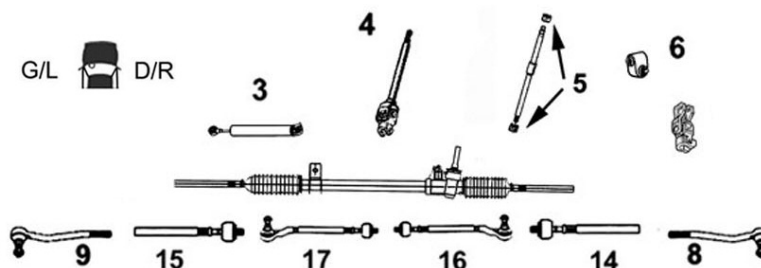

3008035

Axe de bielle G/D

Part/oe 7701472113

L/R axial joint



14 Côté dir. M12x1.0 Côté rot. M14x1.5 long 303 mm

15	1.0		FC0Y
	1.0i 16v.	DNA	FC06
	1.2	DNA	FC01/0A/0F/1A
	1.2i 16v.	DNA	FC05/0T/0W/1D/1P
	1.4	DNA	FC0B/0M
	1.5 DCi	DNA	FC07/08/09/1F
	1.6i 16v.	DNA	FC0R/1B/1T/1U/10
	1.9 D	DNA	FC0D/0E/0J/02/0N

3008040

Axe de bielle G/D

Part/oe 7701472120

L/R axial joint











14 Côté dir. M12x1.0 Côté rot. M14x1.5 long 305 mm

15	1.0i 16v.	DA	FC06
	1.2	DA	FC01/0A/0F/1A
	1.2		FC1H
	1.2i 16v.	DA	FC05/0T/0W/1D/1P
	1.2i 16v.		FC1K
	1.4	DA	FC0B/0M
	1.5 DCi	DA	FC07/08/09/1F
	1.5 DCi		FC1E/1G/1R/1S
	1.6i 16v.	DA	FC0R/1B/1U/1T/1U/10
	1.6i 16v.		FC1M/13/14/1W/1Y
	1.6i 16v. 2WD		FC0L/0P/0S/1N
	1.9 D	DA	FC0D/0E/0J/02/0N
	1.9 DCi 2WD		FC0V
	TT Elec. /All models Electric		FC0Z

... Kangoo I 03/03-12/07 VU ...

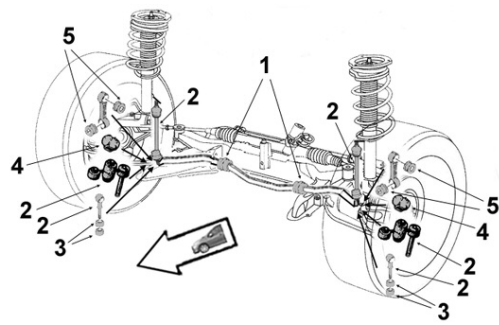
RENAULT



... Kangoo I 03/03-12/07 VU ...			
3008243	Axe de bielle G/D		
Part/oe 7701473656	L/R axial joint		
	14 Côté dir. M12x1.0 Côté rot. M14x1.5 long 314 mm 15	1.6i 16v. 4WD 1.9 DCi 4WD	FC0L/0P/0S/1N FC0V
4006134	Rotule de direction G	4006135	Rotule de direction D
OE 7701474641	Left tie rod end	OE 7701474642	Right tie rod end
	9 1.0i 16v. 1.2 1.2i 16v. 1.4 1.5 DCi 1.6i 16v. 1.9 D 1.9 DCi TT Elec. /All models Electric		8 1.0i 16v. 1.2 1.2i 16v. 1.4 1.5 DCi 1.6i 16v. 1.9 D 1.9 DCi TT Elec. /All models Electric
 Barre stabilisatrice Stabilizer bar Barra estabilizadora Drażek stabilizatora стабилизатор поперечной устойчивости			
4005148	Biellette barre stab.		
OE 7700437136	Stabilizer bar stub axle		
	2 1.6i 16v. 4WD 1.9 DCi 4WD	FC0L/0P/0S FC0V	
4001505	Palier de barre bout		
OE 7700799404+7703034237	End bar main bearing		
	2 1.2i /GPL tout chemin Sans protection spéciale 1.2i /GPL 1.2i 16v. 1.4i 1.5 DCi 1.6i 16v. 2WD 1.9 D 1.9 DCi 2WD tout chemin Sans protection spéciale	FC01/0A/0F FC1A/1H FC05/0T/0W/1D/1K/1P FC0B/0M FC07/08/09/1F/1G/1R/1S FC0L/0P/0S/1N FC0D/0E/0J/0N FC0U/0V	-16/01/07 -16/01/07 -16/01/07 -16/01/07 -16/01/07 -16/01/07 -16/01/07 -16/01/07
4005134	Palier de barre bout	4001476	Palier de barre milieu
OE 7700314855	End bar main bearing	OE 7700785788	Middle bar main bearing
	4 Barre Ø 23 1.2 1.2 tout chemin 1.2i 16v. tout chemin 1.6i 16v. FC0R/1B 1.9 D 1.9 D tout chemin		1 Barre Ø 23 1.2 1.2i 16v. 1.4i 1.5 DCi 1.6i 16v. 1.9 D 1.9 DCi TT Elec. /All models Electric
	FC0K FC01/0A/0F FC1P FC0R/1B FC02 FC0J		FC0F FC1D/1P FC0B FC07/08/09 FC0L/0P/0R/0S/1B/1M FC02/0J FC0N FC0V FC0Z

... Kangoo I 03/03-12/07 VU ...

RENAULT

SASIC



Barre stabilisatrice
Stabilizer bar
Barra estabilizadora
Drażek stabilizatora
 стабилизатор поперечной устойчивости

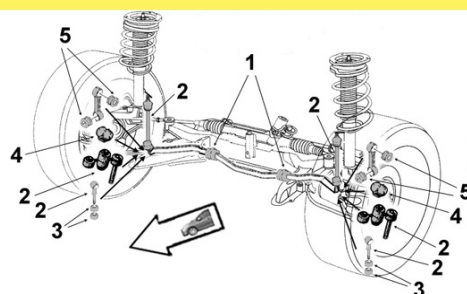

4005078 Kit rép. barre stab. G et D

OE - *L R Stabilizing bar repair kit*

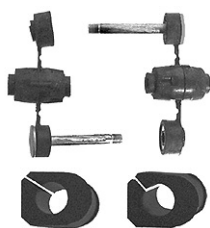

Barre percée Ø 23
 1.2 FC05/0T/0W/1D/1P
 1.2 sauf tout chemin FC1P
 1.2i 16v. FC1A
 1.2i 16v. sauf tout chemin FC01/0A/0F
 1.5 DCi FC07/08/09
 1.6i 16v. 2WD FC0L/0P/0S
 1.9 D FC0N
 1.9 D sauf tout chemin FC0D/0E/0J
 1.9 DCi 2WD sauf tout chemin FC0V
 TT Elec. /All models Electric FC0Z

4005080 Kit rép. barre stab. G et D

OE - *L R Stabilizing bar repair kit*

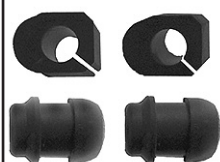

Barre Ø 23
 1.2 Véhicule tout chemin FC1P
 1.2i 16v. véhicule tout chemin FC01/0A/0F
 1.6i 16v. FC0R/1B/1M
 1.9 D FC02
 1.9 D Véhicule tout chemin FC0D/0E/0J
 1.9 DCi 2WD Véhicule tout chemin FC0V



Eléments SUSPENSION
Suspension parts
Elementos suspensión
Elementy zawieszenie
 Элементы подвески

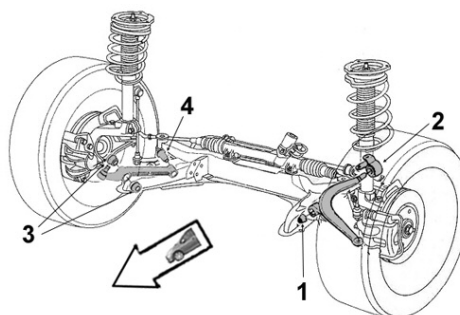

4001546 Articulation AV/AR

OE 8200711554 *Front rear bush*



1 Ø int.12 Ø ext.45 coll.59
2 long. tube int.46 ext.30 ep. coll.4
 1.2 FC0A/0F/01/1A
 1.2i 16v. FC05/1D/1P
 1.6i 16v. FC0R/1B FC1M
 1.6i 16v. 2WD FC0L/0P/0S
 1.9 D FC02
 1.9 D tout chemin FC0J FC0N

4001540 Articulation AV/AR

OE 7700424399 *Front rear bush*



1 Ø int.12 Ø ext.45.5 coll.59
2 long. tube int.46 ext.29.5 ep. coll.4
 1.5 DCi FC07/08/09
 1.9 D sauf tout chemin FC0J/0N
 TT Elec. /All models Electric FC0Z

4005502 Articulation AV/AR

OE 8200033379 *Front rear bush*



1 Ø int.12 Ø ext.45 coll.47.8 long. tube int.46 ext.29 ep. Coll.4.1
2
 1.6i 16v. 4WD FC0L/0P/0S
 1.9 DCi 4WD FC0V

... Kangoo I 03/03-12/07 VU ...

Bras & Triangle de suspension

Control arm
Brazo y triángulo
Wahacz
Рычаг подвески

G/L  D/R



RENAULT



... Kangoo I 03/03-12/07 VU ...

SASIC

RENAULT

Bras & Triangle de suspension

Control arm
Brazo y triángulo
Wahacz
Рычаг подвески









G/L  D/R

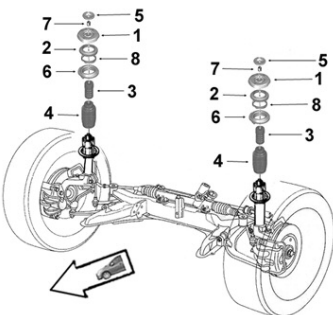

... Kangoo I 03/03-12/07 VU ...

RENAULT



... Kangoo I 03/03-12/07 VU ...																			
405A423S OE -	Kit rép. train AV <i>Front axle repair kit</i>																		
	<p>Sans visserie <i>Without screws and bolts</i> Barre Ø 23</p> <table border="0"> <tr> <td>1.2</td> <td>Véhicule tout chemin</td> <td>FC1P</td> </tr> <tr> <td>1.2i 16v.</td> <td>Véhicule tout chemin</td> <td>FC01/0A/0F</td> </tr> <tr> <td>1.6i 16v.</td> <td></td> <td>FC0R/1B/1M</td> </tr> <tr> <td>1.9 D</td> <td></td> <td>FC02</td> </tr> <tr> <td>1.9 D</td> <td>Véhicule tout chemin</td> <td>FC0D/0E/0J</td> </tr> <tr> <td>1.9 DCi 2WD</td> <td>Véhicule tout chemin</td> <td>FC0V</td> </tr> </table>	1.2	Véhicule tout chemin	FC1P	1.2i 16v.	Véhicule tout chemin	FC01/0A/0F	1.6i 16v.		FC0R/1B/1M	1.9 D		FC02	1.9 D	Véhicule tout chemin	FC0D/0E/0J	1.9 DCi 2WD	Véhicule tout chemin	FC0V
1.2	Véhicule tout chemin	FC1P																	
1.2i 16v.	Véhicule tout chemin	FC01/0A/0F																	
1.6i 16v.		FC0R/1B/1M																	
1.9 D		FC02																	
1.9 D	Véhicule tout chemin	FC0D/0E/0J																	
1.9 DCi 2WD	Véhicule tout chemin	FC0V																	
 Support d'amortisseur <i>Suspension mounting</i> <i>Soporte amortiguador</i> <i>Poduszka amortyzatora</i> <i>Опора амортизатора</i>																			
4001620 OE 7700426450	Coupelle rebond. <i>Spring cup</i>																		
	<p>5</p> <table border="0"> <tr> <td>1.2</td> <td>FC01/0A/1A</td> </tr> <tr> <td>1.2i / GPL</td> <td>FC0F</td> </tr> <tr> <td>1.2i 16v.</td> <td>FC1D/1P</td> </tr> <tr> <td>1.5 DCi</td> <td>FC07/08/09</td> </tr> <tr> <td>1.6i 16v.</td> <td>FC0L/0P/0R/0S/1B/1M</td> </tr> <tr> <td>1.9 D</td> <td>FC02/0J/0N</td> </tr> <tr> <td>1.9 DCi</td> <td>FC0V</td> </tr> </table> <p>TT Elec. /All models Electric FC0Z</p>	1.2	FC01/0A/1A	1.2i / GPL	FC0F	1.2i 16v.	FC1D/1P	1.5 DCi	FC07/08/09	1.6i 16v.	FC0L/0P/0R/0S/1B/1M	1.9 D	FC02/0J/0N	1.9 DCi	FC0V				
1.2	FC01/0A/1A																		
1.2i / GPL	FC0F																		
1.2i 16v.	FC1D/1P																		
1.5 DCi	FC07/08/09																		
1.6i 16v.	FC0L/0P/0R/0S/1B/1M																		
1.9 D	FC02/0J/0N																		
1.9 DCi	FC0V																		
4001615 OE 7700829529	Tampon suspension G/D <i>L/R susp. rebound stop</i>																		
	<p>1</p> <table border="0"> <tr> <td>1.2</td> <td>FC01/0A/0F/1A</td> </tr> <tr> <td>1.2i 16v.</td> <td>FC1D/1P</td> </tr> <tr> <td>1.5 DCi</td> <td>FC07/08/09</td> </tr> <tr> <td>1.6i 16v.</td> <td>FC0L/0P/0R/0S/1B/1M</td> </tr> <tr> <td>1.9 D</td> <td>FC02/0J/0N</td> </tr> <tr> <td>1.9 DCi</td> <td>FC0V</td> </tr> </table> <p>TT Elec. /All models Electric FC0Z</p>	1.2	FC01/0A/0F/1A	1.2i 16v.	FC1D/1P	1.5 DCi	FC07/08/09	1.6i 16v.	FC0L/0P/0R/0S/1B/1M	1.9 D	FC02/0J/0N	1.9 DCi	FC0V						
1.2	FC01/0A/0F/1A																		
1.2i 16v.	FC1D/1P																		
1.5 DCi	FC07/08/09																		
1.6i 16v.	FC0L/0P/0R/0S/1B/1M																		
1.9 D	FC02/0J/0N																		
1.9 DCi	FC0V																		
4005300 OE 8200651172	Butée à billes G/D <i>L/R ball bearing</i>																		
	<p>2</p> <table border="0"> <tr> <td>1.2</td> <td>FC01/0A/0F/1A</td> </tr> <tr> <td>1.2i 16v.</td> <td>FC1D/1P</td> </tr> <tr> <td>1.4i</td> <td>FC0B/M</td> </tr> <tr> <td>1.5 DCi</td> <td>FC07/08/09</td> </tr> <tr> <td>1.6i 16v.</td> <td>FC0L/0P/0R/0S/1B/1M</td> </tr> <tr> <td>1.9 D</td> <td>FC02/0J/0N</td> </tr> <tr> <td>1.9 DCi</td> <td>FC0V</td> </tr> </table> <p>TT Elec. /All models Electric FC0Z</p>	1.2	FC01/0A/0F/1A	1.2i 16v.	FC1D/1P	1.4i	FC0B/M	1.5 DCi	FC07/08/09	1.6i 16v.	FC0L/0P/0R/0S/1B/1M	1.9 D	FC02/0J/0N	1.9 DCi	FC0V				
1.2	FC01/0A/0F/1A																		
1.2i 16v.	FC1D/1P																		
1.4i	FC0B/M																		
1.5 DCi	FC07/08/09																		
1.6i 16v.	FC0L/0P/0R/0S/1B/1M																		
1.9 D	FC02/0J/0N																		
1.9 DCi	FC0V																		
4005373 OE 7700802667	Butée protecteur susp. G/D <i>L/R suspension bush</i>																		
	<p>3 4</p> <table border="0"> <tr> <td>1.2</td> <td>FC01/0A/0F/1A</td> </tr> <tr> <td>1.2i 16v.</td> <td>FC1D/1P</td> </tr> <tr> <td>1.4i</td> <td>FC0B/0M</td> </tr> <tr> <td>1.5 DCi</td> <td>FC07/08/09</td> </tr> <tr> <td>1.6i 16v.</td> <td>FC0L/0P/0R/0S/1B/1M</td> </tr> <tr> <td>1.9 D</td> <td>FC02/0J/0N</td> </tr> <tr> <td>1.9 DCi</td> <td>FC0V</td> </tr> </table> <p>TT Elec. /All models Electric FC0Z</p>	1.2	FC01/0A/0F/1A	1.2i 16v.	FC1D/1P	1.4i	FC0B/0M	1.5 DCi	FC07/08/09	1.6i 16v.	FC0L/0P/0R/0S/1B/1M	1.9 D	FC02/0J/0N	1.9 DCi	FC0V				
1.2	FC01/0A/0F/1A																		
1.2i 16v.	FC1D/1P																		
1.4i	FC0B/0M																		
1.5 DCi	FC07/08/09																		
1.6i 16v.	FC0L/0P/0R/0S/1B/1M																		
1.9 D	FC02/0J/0N																		
1.9 DCi	FC0V																		
4005229 OE -																			
Kit rép. suspension G ou D <i>L/R stabilizing bar repair kit</i>																			
	<table border="0"> <tr> <td>1.2</td> <td>FC05/0T/0W/1D/1P</td> </tr> <tr> <td>1.2i 16v.</td> <td>FC01/0A/0F/1A</td> </tr> <tr> <td>1.5 DCi</td> <td>FC07/08/09</td> </tr> <tr> <td>1.6i 16v.</td> <td>FC0L/0P/0R/0S/1B/1M</td> </tr> <tr> <td>1.9 D</td> <td>FC02/0D/0E/0J/0N</td> </tr> </table> <p>TT Elec. /All models Electric FC0Z</p>	1.2	FC05/0T/0W/1D/1P	1.2i 16v.	FC01/0A/0F/1A	1.5 DCi	FC07/08/09	1.6i 16v.	FC0L/0P/0R/0S/1B/1M	1.9 D	FC02/0D/0E/0J/0N								
1.2	FC05/0T/0W/1D/1P																		
1.2i 16v.	FC01/0A/0F/1A																		
1.5 DCi	FC07/08/09																		
1.6i 16v.	FC0L/0P/0R/0S/1B/1M																		
1.9 D	FC02/0D/0E/0J/0N																		

... Kangoo I 03/03-12/07 VU



Barre stabilisatrice
 Stabilizer bar
 Barra estabilizadora
 Drążek stabilizatora
 стабилизатор поперечной устойчивости

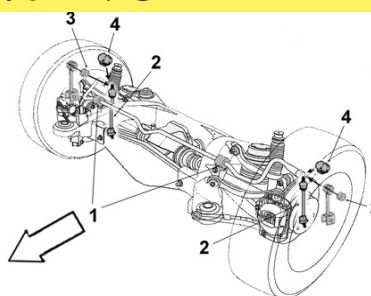

4005149

Biellette barre stab.

OE 7700436706

Stabilizer bar stub axle

2



1.9 DCi 4WD FC0V



Eléments SUSPENSION

Suspension parts
Elementos suspensión
Elementy zawieszenie
Элементы подвески

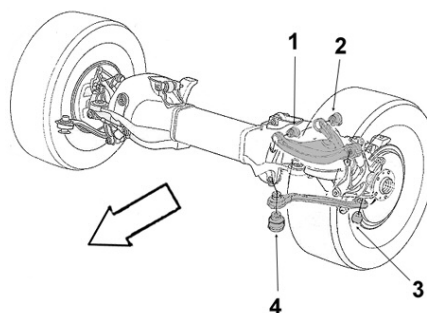

4001587

Articulation

OE 7700436707

Bush

1
2

Ø int.12 Ø ext.40 coll.50 long. tube int.60 ext.43 ep. coll.7



1.6i 16v. 4WD FC0P/0S
 1.9 DCi 4WD FC0V

Eléments TRAIN ARRIERE

Rear axle parts
Tren TRAS
Elementy zawieszenia tylnego
элементы задней оси.



4005350B

Kit rép. train AR G ou D

OE -

L/R rear axle repair kit

Train à tube



1.2 FC01/0A/0F
 1.2i 16v. FC05/0T/0W/1D/1P/1K
 1.5 DCi FC07/08/09/1E/1F/1G/1R/1S
 1.6i 16v. FC0L/0P/0R/0S/1B/1N/1T/1U/1M
 1.9 D FC02/0D/0E/0J/0N
 TT Elec. /All models Electric FC0Z

Kangoo II 01/08- VU ...

Eléments DIRECTION

Steering parts

Elementos Direcciones

Elementy układ kierowniczy

Элементы рулевой системы

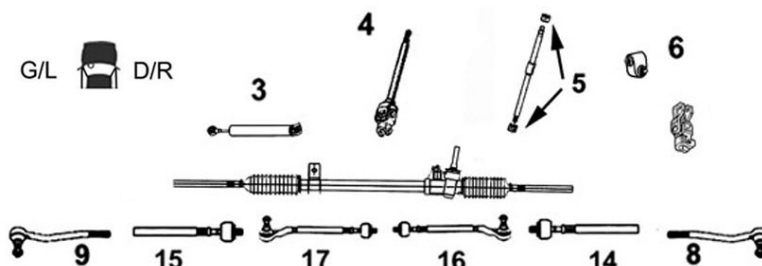

7774013

Axe de bielle G/D

Part/oe 485215961R

L/R axial joint



14 Côté dir. M14x1.5 Côté rot. M14x1.5 long 215 mm

15

1.2 TCE

FW02

1.5 DCi

FW0A/B/C/F/G/H/K/L/4/5/6/7/8

1.6i

FW00/E/N/P/Y

1.6i 16v.

FW0D/U/W/1/3/9

TT Elec. /All models Electric

FW0Z

7674008

Rotule de direction G

OE 7701478407

Left tie rod end



9 M14 x 1.5

1.2 TCE FW02

1.5 DCi FW0A/B/C/F/G/H/K/L/4/5/6/7/8

1.6i FW00/E/N/P/Y

1.6i 16v. FW0D/U/W/1/3/9

TT Elec. /All models Electric

FW0Z

7674009

Rotule de direction D

OE 7701478408

Right tie rod end



8 M14 x 1.5

1.2 TCE FW02

1.5 DCi FW0A/B/C/F/G/H/K/L/4/5/6/7/8

1.6i FW00/E/N/P/Y

1.6i 16v. FW0D/U/W/1/3/9

TT Elec. /All models Electric

FW0Z



Barre stabilisatrice

Stabilizer bar

Barra estabilizadora

Drażek stabilizatora

стабилизатор поперечной устойчивости

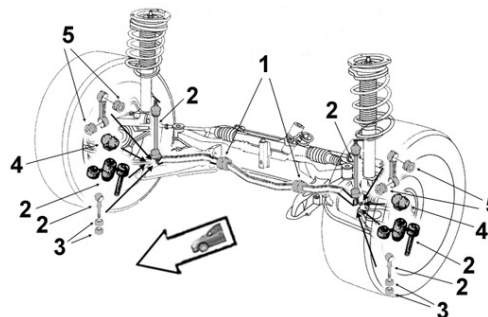

4005146

Biellette barre stab.

OE 8200669065

Stabilizer bar stub axle



2

1.5 DCi FW0A/0B/0C/0F/0G/0K/0L
FW04/05/0H

1.6i FW00/0E/0N/0P/0Y

1.6i 16v. FW0D/0W/01/0U

2304020

Palier de barre milieu

OE 7701070790

Middle bar main bearing



1 Barre Ø 19 Châssis court

1.5 DCi FW0A/0B/0C/0F/0G/0K/0L
FW04/05/0H/08

1.6i FW00/0E/0N/0P/0Y

1.6i 16v. FW0D/0W/01/0U/03

TT Elec. /All models Electric

FW0Z

2304022

Palier de barre milieu

OE 7701069131

Middle bar main bearing



1 Barre Ø 20 Châssis long / standard

1.5 DCi

FW0A/0B/0C/0F/0G/0K/0L FW04/05/0H/08

1.6i

FW00/0E/0N/0P/0Y

1.6i 16v.

FW0D/0W/01/0U/03

TT Elec. /All models Electric

FW0Z

... Kangoo II 01/08- VU

SASIC

RENAULT

Bras & Triangle de suspension

Control arm
Brazo y triángulo
Wahacz
Рычаг подвески

G/L  D/R

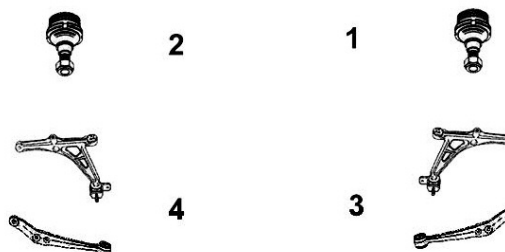

7474003

Triangle de susp. G

OE 8200586561

Left track control arm

4 Avec rotule With ball joint

1.2 TCE FW02
1.5 DCi FW0A/B/C/F/G/H/K/L/4/5/6/7/8
1.6i FW00/E/N/P/Y
1.6i 16v. FW0D/U/W/1/3/9

TT Elec. /All models Electric FW0Z



7474005

Triangle de susp. D

OE 8200586567

Right track control arm

3 Avec rotule With ball joint

1.2 TCE FW02
1.5 DCi FW0A/B/C/F/G/H/K/L/4/5/6/7/8
1.6i FW00/E/N/P/Y
1.6i 16v. FW0D/U/W/1/3/9

TT Elec. /All models Electric FW0Z



7574008

Rotule de susp. G

Part/oe 8200586561

L Susp. ball joint

2

1.2 TCE FW02
1.5 DCi FW0A/B/C/F/G/H/K/L/4/5/6/7/8
1.6i FW00/E/N/P/Y
1.6i 16v. FW0D/U/W/1/3/9

TT Elec. /All models Electric FW0Z



7574009

Rotule de susp. D

Part/oe 8200586567

R Suspension ball joint

1

1.2 TCE FW02
1.5 DCi FW0A/B/C/F/G/H/K/L/4/5/6/7/8
1.6i FW00/E/N/P/Y
1.6i 16v. FW0D/U/W/1/3/9

TT Elec. /All models Electric FW0Z



Support d'amortisseur

Suspension mounting
Soporte amortiguador
Poduszka amortyzatora
Опора амортизатора

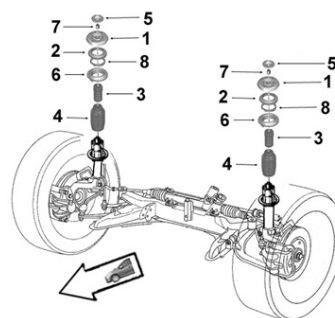

2654011

Support suspension

OE 8200591283

Suspension mounting

1

1.5 DCi FW0A/B/C/F/G/H/K/L/4/5
1.6i FW00/E/N/P/Y
1.6i 16v. FW0D/U/W/1



Eléments TRAIN ARRIERE

Rear axle parts
Tren TRAS
Elementy zawieszenia tylnego
элементы задней оси.



2604002

Articulation essieu

OE 8200380965

Axle bush

Ø int. 12 Ø ext. 70 coll. 80
long. tube int. 90 ext. 58 ep. coll.10

1.5 DCi FW0A/0B/0C/0F/0G/0K/0L
FW04/05/0H

1.6i FW00/0E/0N/0P/0Y
1.6i 16v. FW0D/0W/01/0U



Mascott ...

Eléments DIRECTION

Steering parts

Elementos Direcciones

Elementy układ kierowniczy

Элементы рулевой системы

G/L  D/R

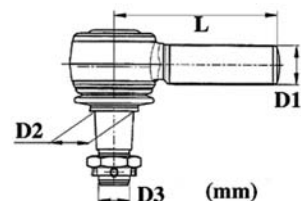

RENAULT



T731014

OE 5001844135

Rotule G

L ball joint

**Mâle Male D1 : 24x1.5 D2 : 20
D3 : 16 x 1.5 L115**

TT / All models -05/06
TT / All models 01/02-05/06
TT / All models DXi 06/06-



T731013

OE 5001844136

Rotule D

R ball joint

**Mâle Male D1 : 24x1.5 D2 : 20
D3 : 16 x 1.5 L115**

TT / All models -05/06
TT / All models 01/02-05/06
TT / All models DXi 06/06-



T731024

OE 5001847437

Rotule G

L ball joint

**Mâle Male D1 : 24x1.5 D2 : 22
D3 : 18 x 1.5 L105**

TT / All models 01/02-12/02



T731023

OE 5001847436

Rotule D

R ball joint

**Mâle Male D1 : 24x1.5 D2 : 22
D3 : 18 x 1.5 L105**

TT / All models 01/02-12/02



Barre stabilisatrice

Stabilizer bar

Barra estabilizadora

Drażek stabilizatora

стабилизатор поперечной устойчивости

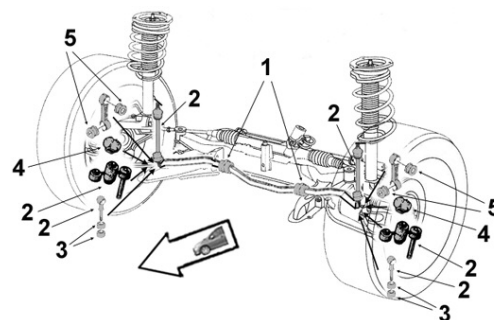

T251001

OE 5516010769

Bague de barre stab.

Stab. bar ring

4 Ø 18 x 34 / L 54

TT / All models -05/06



... Mascott



Eléments SUSPENSION

Suspension parts

Elementos suspensión

Elementy zawieszenie

Элементы подвески

RENAULT

SASIC

T791007

Kit pivot de roue

OE 5001865610

Pivot wheel repair kit

axe 27.5/28 x 155 axial 27.5/28 x 155 bague 27.5/35x31.2 bague 28/35x31.2 roulement 48 x 11.5/14 accessoires



TT / all models 150
TT / All models DXi3

01/99-05/04
06/06-11/07



Barre stabilisatrice

Stabilizer bar

Barra estabilizadora

Drążek stabilizatora

стабилизатор поперечной устойчивости

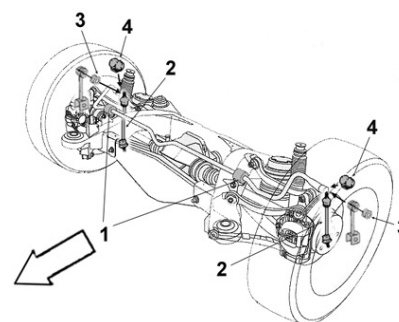

T251001

Bague de barre stab.

OE 5516010769

Stab. bar ring

4 Ø 18 x 34 / L 54



TT / All models -05/06

T251035

Bague de barre stab.

OE 5010215010

Stab. bar ring

1 Ø 36x79/ L 80x66



TT / All models -05/06

Master I ...

Eléments DIRECTION

Steering parts

Elementos Direcciones

Elementy układ kierowniczy

Элементы рулевой системы

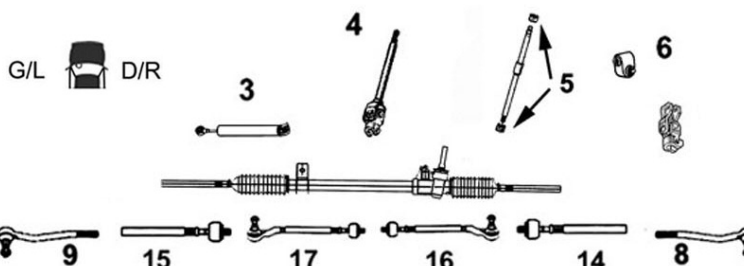

7774010

Axe de bielle G/D

Part/oe 7701352441

L/R axial joint

NEW



14 Côté dir. M16x1.5 Côté rot. M16x1.5
15 Long 222 mm

TT / all models R..... Q..... 01/81-06/96

4006132

Rotule de direction G/D

OE 7701462427

L/R tie rod end













8
9

TT / all models R..... Q.....

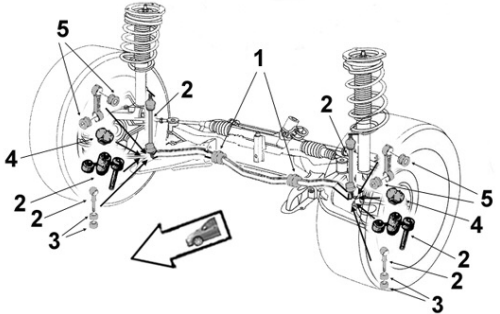
... Master I ...

RENAULT

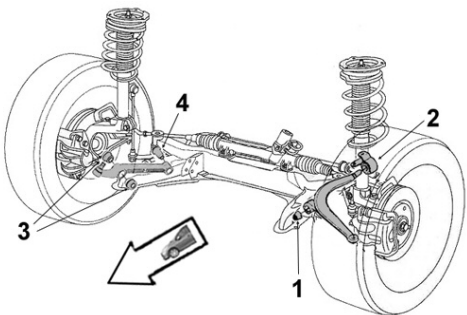

4004007 OE 6006000779	Axe de volant <i>Steering wheel shaft</i>	4006142 OE 7701348973	Bague axe de volant <i>Bushing steering wheel shaft</i>
	4 TT /all models DNA grand cardan R..... Q.....		5 TT /all models Colonne de dir. R..... Q..... 03/89-
4004008 OE 5000389581	Cardan colonne de direction <i>Cardan joint</i>	4006138 OE 7703090293	Douille à aiguilles colonne <i>Needle bearing</i>
	7 TT /all models Petit cardan R..... Q.....		5 TT /all models R..... Q..... -03/89
 <p>Barre stabilisatrice <i>Stabilizer bar</i> Barra estabilizadora Drażek stabilizatora стабилизатор поперечной устойчивости</p>			
4001510 OE 5000387333	Tampon élastique <i>Snubber</i>	4001509 OE 5000392464	Palier de barre milieu <i>Middle bar main bearing</i>
	3 TT /all models -10/97		1 Barre Ø 30 TT /all models -10/97
 <p>Eléments SUSPENSION <i>Suspension parts</i> Elementos suspensión Elementy zawieszenie Элементы подвески</p>			
4001625 OE 5000391054	Butée tirant <i>Bushing</i>	4001508 OE 7700734714	Articulation sup. <i>Upper bush</i>
	TT /all models Propulsion -ch B00002607 TT /all models Traction -ch B00021420		4 Ø int.12 Ø ext.27 coll.47 long. tube int.41.85 ext.31 ep. coll.8.35 TT /all models Propulsion Ch- B00002608 -10/97 TT /all models Traction Ch- B00021421 -10/97

... Master I ...



Eléments SUSPENSION
Suspension parts
Elementos suspensión
Elementy zawieszenie
Элементы подвески

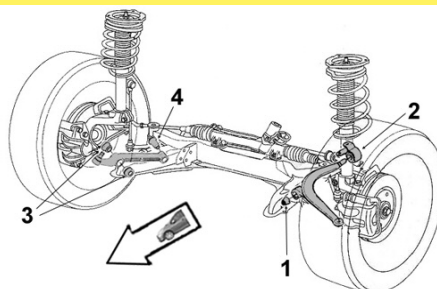

RENAULT

SASIC

4001506

Articulation inf. AV

OE 5000391010

Front lower bush



1 Ø int.24 Ø ext.38 coll.50
 long. tube int.57 ext.49 ep. coll.8

TT /all models -10/97

4001507

Articulation inf. AR

OE 5000391009

Rear lower bush



2 Ø int.24 Ø ext.38 coll.50
 long. tube int.57 ext.49 ep. coll.8

TT /all models -10/97

**Bras & Triangle
 de suspension**

Control arm
Brazo y triángulo
Wahacz
Рычаг подвески

G/L D/R



4005268

Rotule de susp. sup. G/D

OE 7701462692

L/R upper susp. ball joint



1
2

TT /all models R..... Q.....

4005269

Rotule de susp. inf. G/D

OE 7701462693

L/R lower suspension ball joint



1
2

TT /all models R..... Q.....

405A417S

Kit rép. train AV

OE -

Front axle repair kit



Sans visserie *Without screws and bolts*
Barre Ø 32

TT /all models R Ch- 00021421 (84-)

4005417

Kit rép. triangle susp. G ou D

OE -

L or R track control arm bearing repair kit



Avec visserie *With screws and bolts*

TT /all models R Ch- 00021421 (84-)
 TT /all models Q Ch- 00002608 (83-)

... Master I



Support d'amortisseur

Suspension mounting
Soporte amortiguador
Poduszka amortyzatora
Опора амортизатора

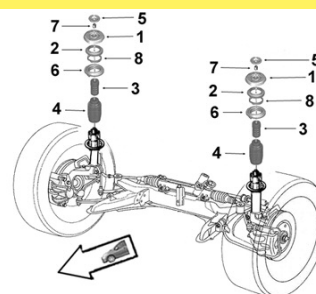

4001619

OE 7700739241

Butée protecteur susp. G/D

L/R suspension bush



3
4

TT /all models -10/97

RENAULT



Autres pièces

Other parts
Otras piezas
Inne części
другие части



4001720

OE 5000387433

Art. traverse AV

Front cross bar bush



Ø int.10 Ø ext.40 long. tube int.42 ext.31

TT /all models R--2 -02/89
TT /all models Q--- -10/97
TT /all models R--3 -10/97
TT /all models R--4 -10/97

4001722

OE 6006000974

Art. traverse AV

Front cross bar bush



Ø int. 10 Ø ext.52 long. tube int.53.5 ext.32

TT /all models R--2 03/89-10/97
TT /all models R--A -10/97
TT /all models R--6 -10/97



Barre stabilisatrice

Stabilizer bar
Barra estabilizadora
Drażek stabilizatora
стабилизатор поперечной устойчивости

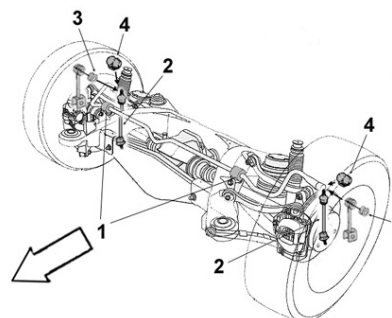

4005133

OE 7700302278

Biellette barre stab. AR

Rear stabilizer bar stub axle



2

TT /all models
Sauf susp. pneumatique -10/97

4001512

OE 5000387990

Palier de barre milieu

Middle bar main bearing



1

Barre Ø 24

TT /all models Propulsion -10/97

Master II ...

Eléments DIRECTION

Steering parts

Elementos Direcciones

Elementy układu kierowniczy

Элементы рулевой системы

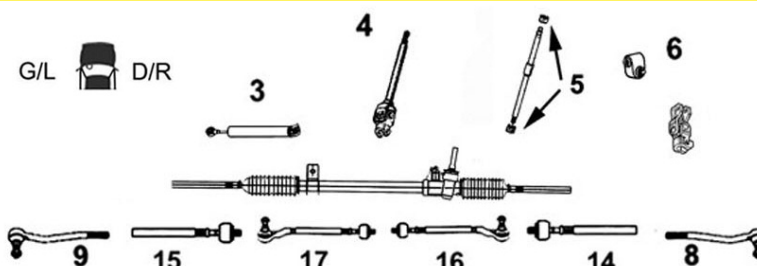

3008249 Axe de bielle G/D

Part/oe 7701470362 L/R axial joint

14 Côté dir. M14x1.5 Côté rot. M16x1.5 long 176 mm

15



1.9 DCi	10/97-
1.9 DTi	10/97-
2.2 DCi	10/97-
2.5 D	10/97-
2.5 DCi	10/97-
2.8 DTi	10/97-
3.0 DCi	10/97-

4006153 Rotule de direction G

OE 7701470363 Left tie rod end

9



1.9 DCi	10/97-
1.9 DTi	10/97-
2.2 DCi	10/97-
2.5 D	10/97-
2.5 DCi	10/97-
2.8 DTi	10/97-
3.0 DCi	10/97-

4006154 Rotule de direction D

OE 7701470364 Right tie rod end

8



1.9 DCi	10/97-
1.9 DTi	10/97-
2.2 DCi	10/97-
2.5 D	10/97-
2.5 DCi	10/97-
2.8 DTi	10/97-
3.0 DCi	10/97-



Barre stabilisatrice

Stabilizer bar

Barra estabilizadora

Drażek stabilizatora

стабилизатор поперечной устойчивости

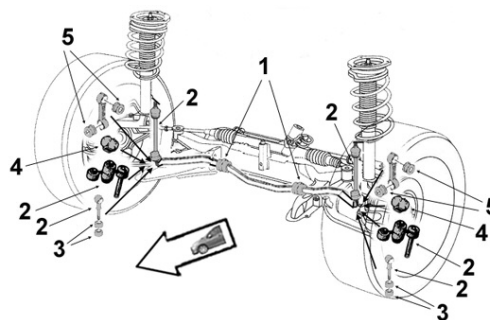

4005140 Bielle barre stab. G

OE 8200713522 Left stabilizer bar stub axle

2



1.9 DCi	10/97-
1.9 DTi	10/97-
2.2 DCi	10/97-
2.5 D	10/97-
2.5 DCi	10/97-
2.8 DTi	10/97-
3.0 DCi	10/97-

4005139 Bielle barre stab. D

OE 8200713523 Right stabilizer bar stub axle

2



1.9 DCi	10/97-
1.9 DTi	10/97-
2.2 DCi	10/97-
2.5 D	10/97-
2.5 DCi	10/97-
2.8 DTi	10/97-
3.0 DCi	10/97-

4001552 Palier de barre milieu

OE 7700309154 Middle bar main bearing

1 Barre Ø 26



1.9 DCi	10/97-
1.9 DTi	10/97-
2.2 DCi	10/97-
2.5 D	10/97-
2.5 DCi	10/97-
2.8 DTi	10/97-
3.0 DCi	10/97-

... Master II ...



Eléments SUSPENSION

Suspension parts
Elementos suspensión
Elementy zawieszenie
Элементы подвески

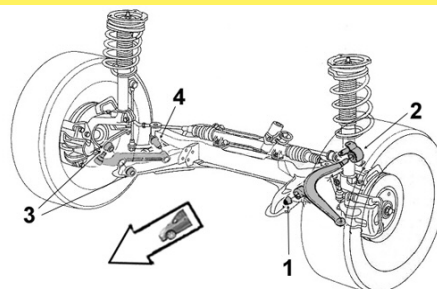

RENAULT



2254001 Articulation Sup.

Part/oe 7700302115 Upper bush



4 Ø int. 22 Ø ext. 47 coll. 58 x2 long. tube int. 60 ext. 45 ep. coll.3x2

1.9 DCi	10/97-
1.9 DTi	10/97-
2.2 DCi	10/97-
2.5 D	10/97-
2.5 DCi	10/97-
2.8 DTi	10/97-
3.0 DCi	10/97-

4001548 Art. AV triangle inf.

OE 7700302122 Lower track control arm front bush



1 Ø int.28 Ø ext.55 coll.75 long. tube int.74 ext.58 ep. coll.6

1.9 DCi	10/97-
1.9 DTi	10/97-
2.2 DCi	10/97-
2.5 D	10/97-
2.5 DCi	10/97-
2.8 DTi	10/97-
3.0 DCi	10/97-

4001545 Art. AR triangle inf.

OE 7700302123 Lower track control arm rear bush



2 Ø int.28 Ø ext.55 coll.75 long. tube int.89 ext.58 ep. coll.14

1.9 DCi	10/97-
1.9 DTi	10/97-
2.2 DCi	10/97-
2.5 D	10/97-
2.5 DCi	10/97-
2.8 DTi	10/97-
3.0 DCi	10/97-

Bras & Triangle de suspension

Control arm
Brazo y triángulo
Wahacz
Рычаг подвески

G/L D/R

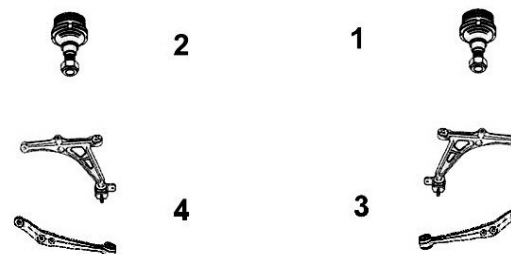

9005768 Triangle de susp. inf. G

OE 8200767822 Lower left track control arm



4 Avec rotule With ball joint Fonte Iron

1.9 DCi	-26/09/07
1.9 DTi	-26/09/07
2.2 DCi	-26/09/07
2.5 D	-26/09/07
2.5 DCi	-26/09/07
2.8 DTi	-26/09/07
3.0 DCi	-26/09/07

9005767 Triangle de susp. inf. D

OE 8200767825 Lower right track control arm



3 Avec rotule With ball joint Fonte Iron

1.9 DCi	-26/09/07
1.9 DTi	-26/09/07
2.2 DCi	-26/09/07
2.5 D	-26/09/07
2.5 DCi	-26/09/07
2.8 DTi	-26/09/07
3.0 DCi	-26/09/07

7474006 Triangle de susp. inf. G

OE 8200750273 Lower left track control arm



4 Avec rotule With ball joint

1.9 DCi	26/09/07-
1.9 DTi	26/09/07-
2.5 DCi	26/09/07-
3.0 DCi	26/09/07-

7474007 Triangle de susp. inf. D

OE 8200750274 Lower right track control arm



3 Avec rotule With ball joint

1.9 DCi	26/09/07-
1.9 DTi	26/09/07-
2.5 DCi	26/09/07-
3.0 DCi	26/09/07-

... Master II ...

Bras & Triangle de suspension

Control arm
Brazo y triángulo
Wahacz
Рычаг подвески

G/L  D/R

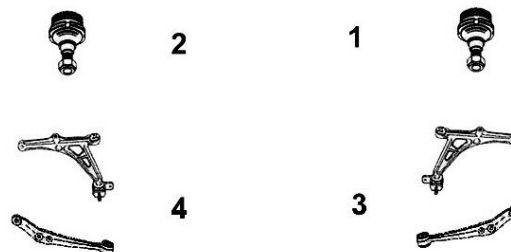

4005279 Rotule de susp. sup. G/D

OE 7700312851 L/R upper susp. ball joint



1
2

1.9 DCi
1.9 DTi
2.2 DCi
2.5 D
2.5 DCi
2.8 DTi
3.0 DCi

7574001

OE 7701056970

Rotule appui ressort

Ball joint Spring support



1
2

1.9 DCi
1.9 DTi
2.2 DCi
2.5 D
2.5 DCi
2.8 DTi
3.0 DCi

4005276 Rotule de susp. inf. G/D

OE 7701056969 L/R lower suspension ball joint



1
2

Ø 22
1.9 DCi -26/09/07
1.9 DTi -26/09/07
2.2 DCi -26/09/07
2.5 D -26/09/07
2.5 DCi -26/09/07
2.8 DTi -26/09/07
3.0 DCi -26/09/07

7574007

OE 7701070154

Rotule de susp. inf. G/D

L/R lower suspension ball joint



1
2

Ø 24
1.9 DCi 26/09/07-
1.9 DTi 26/09/07-
2.5 DCi 26/09/07-
3.0 DCi 26/09/07-



Barre stabilisatrice

Stabilizer bar
Barra estabilizadora
Drażek stabilizatora
стабилизатор поперечной устойчивости

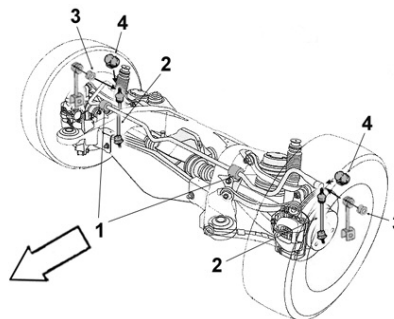

4005133 Bielle barre stab. AR

OE 7700302278 Rear stabilizer bar stub axle



2

TT /all models	susp. normale pavillon surelevé empattement 3580mm	FD-	10/97-
TT /all models	susp. normale empattement 4080mm	FD-	10/97-
TT /all models	susp. pneumatique	FD-/ JD-	10/97-
TT /all models		ED-/ HD-/ UD-	10/97-

... Master II

2304007
Palier de barre milieu

OE 7700667184

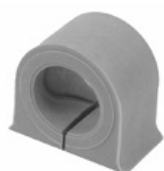
Middle bar main bearing

1 Ø 22.4

1.9 DCi	Susp. normale pavillon surelevé empattement 3580mm	FD-		
1.9 DCi	Susp. normale empattement 4080mm	FD-		
1.9 DCi	Susp. pneumatique			
1.9 DTi	Susp. normale pavillon surelevé empattement 3580mm	FD-		
1.9 DTi	Susp. normale empattement 4080mm	FD-		
1.9 DTi	Susp. pneumatique			
2.2 DCi	Susp. normale pavillon surelevé empattement 3580mm	FD-		
2.2 DCi	Susp. normale empattement 4080mm	FD-		
2.2 DCi	Susp. pneumatique	FD-	JD-	
2.2 DCi		ED-	HD-	UD-
2.5 D	Susp. normale pavillon surelevé empattement 3580mm	FD-		
2.5 D	Susp. normale empattement 4080mm	FD-		
2.5 D	Susp. pneumatique		JD-	
2.5 D		ED-	HD-	UD-
2.5 DCi	Susp. normale pavillon surelevé empattement 3580mm	FD-		
2.5 DCi	Susp. normale empattement 4080mm	FD-		
2.5 DCi	Susp. pneumatique	FD-	JD-	
2.5 DCi		ED-	HD-	UD-
2.8 DTi	Susp. normale pavillon surelevé empattement 3580mm	FD-		
2.8 DTi	Susp. normale empattement 4080mm	FD-		
2.8 DTi	Susp. pneumatique	FD-	JD-	
2.8 DTi		ED-	HD-	UD-
3.0 DCi	Susp. normale pavillon surelevé empattement 3580mm	FD-		
3.0 DCi	Susp. normale empattement 4080mm	FD-		
3.0 DCi	Susp. pneumatique	FD-	JD-	
3.0 DCi		ED-	HD-	UD-

Éléments TRAIN ARRIERE

Rear axle parts
Tren TRAS
Elementy zawieszenia tylnego
элементы задней оси.

4003377
Articulation AV lame

OE 8200024453

Front leaf bush

**Ø int.16 Ø ext. 41 coll. 45 x2
long. tube int.77 ext.64 ep. coll.3.5x2**

 TT /all models Susp. normale/
renforcée/ pneumatique 10/97-

4003348
Articulation AR lame

OE 8200024454

Rear leaf bush

**Ø int.14 Ø ext.40 coll.45 x2
long. tube int.77 ext.65 ep. coll.3X2**

 TT /all models Susp. normale/
renforcée/ pneumatique 10/97-

Master III ...

Eléments DIRECTION
 Steering parts
 Elementos Direcciones
 Elementy układ kierowniczy
 Элементы рулевой системы

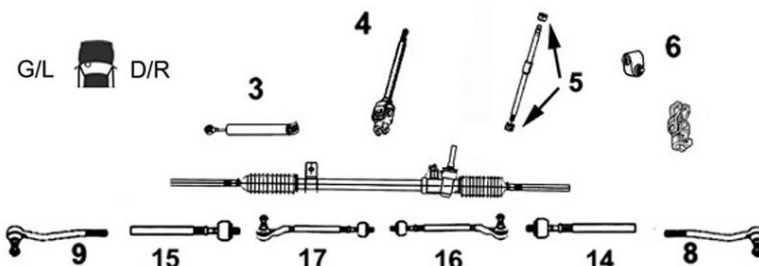

7774017 Axe de bielle G/D

Part/oe 485212373R L/R axial joint

NEW



14 Côté dir. M16x1.5 Côté rot. M18x1.5 long 251 mm

2.3 DCi	EV0A/B/C/D/E/F/J/H
2.3 DCi	FV0A/B/C/D/E/F/G/H/J/K/M/N/P
2.3 DCi	HV0A/B/C/D/E/F/G/H/J/K/N
2.3 DCi	JV0A/B/C/D/F/G/H/J/N/P
2.3 DCi	UV0A/B/C/D/E/F/G/H/J/K/M/P

7674013 Rotule de direction G

OE 485206730R Left tie rod end

NEW



9

2.3 DCi	EV0A/B/C/D/E/F/J/H
2.3 DCi	FV0A/B/C/D/E/F/G/H/J/K/M/N/P
2.3 DCi	HV0A/B/C/D/E/F/G/H/J/K/N
2.3 DCi	JV0A/B/C/D/F/G/H/J/N/P
2.3 DCi	UV0A/B/C/D/E/F/G/H/J/K/M/P

7674015 Rotule de direction D

OE 485200780R Right tie rod end

NEW



8

2.3 DCi	EV0A/B/C/D/E/F/J/H
2.3 DCi	FV0A/B/C/D/E/F/G/H/J/K/M/N/P
2.3 DCi	HV0A/B/C/D/E/F/G/H/J/K/N
2.3 DCi	JV0A/B/C/D/F/G/H/J/N/P
2.3 DCi	UV0A/B/C/D/E/F/G/H/J/K/M/P



Barre stabilisatrice
 Stabilizer bar
 Barra estabilizadora
 Drażek stabilizatora
 стабилизатор поперечной устойчивости

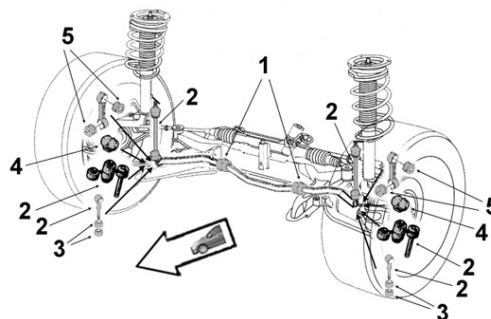

2304030 Biellette barre stab.

OE 546180004R Stabilizer bar stub axle



2

2.3 DCi	E/F/H/UV0E F/H/J/UV0G F/H/UV0K F/UV0M
2.3 DCi	E/F/H/J/UV 0A/0B/0C/0D/0F/0J/0H

... Master III ...

Bras & Triangle de suspension

Control arm
Brazo y triángulo
Wahacz
Рычаг подвески

G/L  D/R

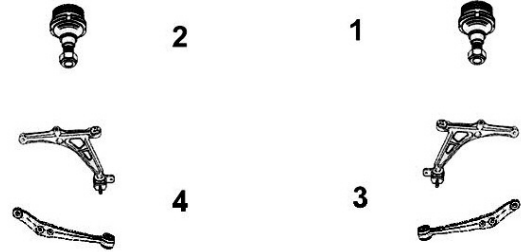

RENAULT



... Master III

**Barre stabilisatrice**

Stabilizer bar

Barra estabilizadora

Drażek stabilizatora

стабилизатор поперечной устойчивости

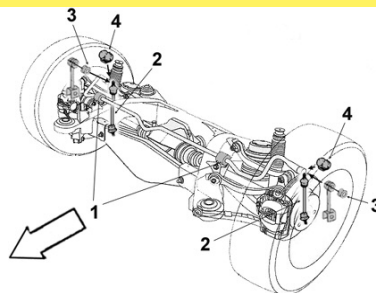
**2304039****Biellette barre stab.**

OE 551100019R

Stabilizer bar stub axle

2



2.3 DCi
2.3 DCi Propulsion
2.3 DCi Propulsion
2.3 DCi Traction
2.3 DCi Traction
2.3 DCi Traction
2.3 DCi Traction
2.3 DCi Traction

Susp. normale
Susp. normale roues simples
Susp. normale roues simples
Susp. normale
Susp. normale
Susp. normale
Susp. normale pavillon H30 empattement VU 20
Susp. normale empattement VU 30

JV0A/B/C/D/F/G/H/J/N/P
HV0A/B/C/D/E/F/G/H/J/K/N
UV0A/B/C/D/E/F/G/H/J/K/M/P
EV0A/B/C/D/E/F/H
HV0A/B/C/D/E/F/G/H/J/K/N
UV0A/B/C/D/E/F/G/H/J/K/M/P
FV0A/B/C/E/F/G/H/J/K/M/N/P
FV0A/B/C/E/F/G/H/J/K/M/N/P

**Support d'amortisseur**

Suspension mounting

Soporte amortiguador

Poduszka amortyzatora

Опора амортизатора

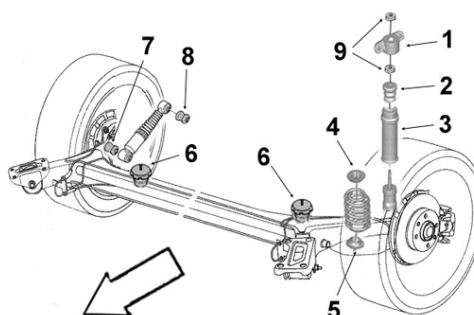
**2654026****Butée de talonnage**

OE 552419683R

Bushing

6

H148 Camping-car /Châssis auvent Traction AV Sauf susp. pneumatique



2.3 DCi
2.3 DCi

UV0G/0K/0M
E/UV 0A/0B/0C/0D/0E/0F/0H/0J

Messenger B70/80/90 110/20 ...**Eléments DIRECTION**

Steering parts

Elementos Direcciones

Elementy układ kierowniczy

Элементы рулевой системы

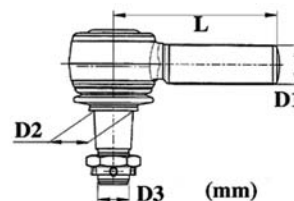
G/L  D/R**T731014****Rotule G**

OE 5001844135

L ball joint

Mâle Male D1 : 24x1.5 D2 : 20
D3 : 16 x 1.5 L115

TT / All models 4x2

**T731013****Rotule D**

OE 5001844136

R ball joint

Mâle Male D1 : 24x1.5 D2 : 20
D3 : 16 x 1.5 L115

TT / All models 4x2



... Messenger B70/80/90 110/20 ...



Barre stabilisatrice
Stabilizer bar
Barra estabilizadora
Drażek stabilizatora
 стабилизатор поперечной устойчивости

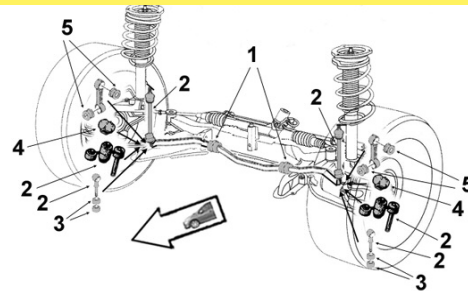

4001524

Palier de barre

OE 5000391730

Bar main bearing



1 Barre Ø 30 Bar Ø 30

TT / all models B90

T251001

Bague de barre stab.

OE 5516010769

Stab. bar ring



4 Ø 18 x 34 / L 54

TT / All models



Eléments SUSPENSION

Suspension parts
Elementos suspensión
Elementy zawieszenie
 Элементы подвески

T791016

Kit pivot de roue

OE 5001836749

Pivot wheel repair kit



axe 27.5/28 x 153 axial 27.5/28 x 153 bague 27.5/35x34 bague 28/35x33 roulement 48 x 12/15 accessoires

TT / All models B70/90 -04/90

TT / All models B80/110/120 -04/99



Barre stabilisatrice

Stabilizer bar
Barra estabilizadora
Drażek stabilizatora
 стабилизатор поперечной устойчивости

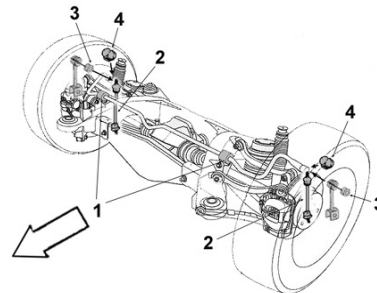

T251001

Bague de barre stab.

OE 5516010769

Stab. bar ring



4 Ø 18 x 34 / L 54

TT / All models

T251035

Bague de barre stab.

OE 5010215010

Stab. bar ring



1 Ø 36x79 / L 80x66

TT / All models

... Messenger B70/80/90 110/20

Eléments TRAIN ARRIERE

Rear axle parts

Tren TRAS

Elementy zawieszenia tylnego

элементы задней оси.



RENAULT



4003389

Articulation AV lame

OE 5000392206

Front leaf bush



Ø int.16 Ø ext.36.5 coll.38 x2
long. tube int.70 ext.60 ep. coll.4x2

TT /all models
B90 3TS 4TS 5T / 4WD 3 lames

4003392

Articulation lame

OE 5000396624

Leaf bush



Ø int.16 Ø ext.45 coll.47.5 x2
long. tube int.65 ext.60 ep. coll.5x2

TT /all models B90 CT

Trafic I ...

Eléments DIRECTION

Steering parts

Elementos Direcciones

Elementy uklad kierowniczy

Элементы рулевой системы

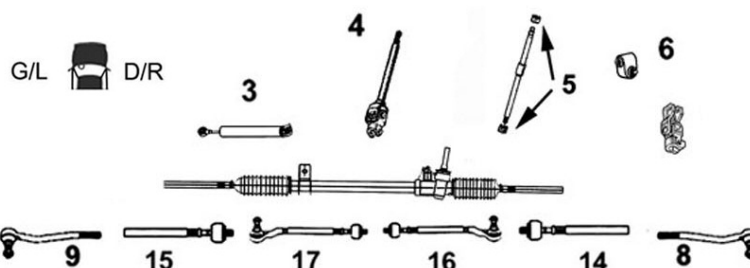

3008052

Axe de bielle G/D

OE -

L/R axial joint



14 Côté dir. M12x1.0 Côté rot. M14x1.5
15 long 288 mm Bielle X =227

TT /all models P3 P5 P6 P8
TT /all models T1/1/2/3/4/5/6
TT /all models T7/9/A/B/C/E

3008244

Axe de bielle G/D

OE -

L/R axial joint



14 Côté dir. M12x1.0 Côté rot. M14x1.5
15 long 295 mm Bielle X =236

TT /all models PA PC
TT /all models P3 P5 P6 P8
TT /all models V2/3/4/5/9

4006052

Bielle de direction G/D

OE 7701463035

L/R steering rod



16 Bielle X =227
17

TT /all models P3 P5 P6 P8
TT /all models T1/2/3/4/5/6
TT /all models T7/9/A/B/C/E

4006133

Rotule de direction G/D

OE 7701461770

L/R tie rod end



8
9

TT /all models PA PC
TT /all models P3 P5 P6 P8
TT /all models T1/2/3/4/5/6
TT /all models V2/3/4/5/9
TT /all models T7/9/A/B/C/E

4004003

Axe de volant

OE 7700670684

Steering wheel shaft



4

TT /all models PA PC
TT /all models P3 P5 P6 P8
TT /all models T1/2/3/4/5/6
TT /all models V2/3/4/5/9
TT /all models T7/9/A/B/C/E

4006142

Bague axe de volant

OE 7701348973

Bushing steering wheel shaft



5

Colonne de dir. sup.

TT /all models PA PC 03/89-
TT /all models P3 P5 P6 P8 03/89-
TT /all models V2/3/4/5/9 03/89-
TT /all models T1/2/3/4/5/6 03/89-
TT /all models T7/9/A/B/C/E 03/89-

... Trafic I ...

4006143

Bague axe de volant

OE 7700720958

Bushing steering wheel shaft



5 Colonne de dir. inf.

TT /all models	PA PC	03/89-
TT /all models	P3 P5 P6 P8	03/89-
TT /all models	T1/2/3/4/5/6	03/89-
TT /all models	V2/3/4/5/9	03/89-
TT /all models	T7/9/A/B/C/E	03/89-



Barre stabilisatrice

Stabilizer bar

Barra estabilizadora

Drażek stabilizatora

стабилизатор поперечной устойчивости

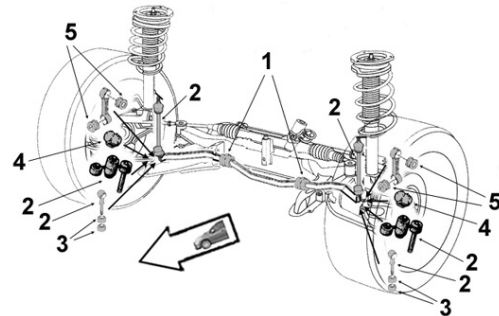

4001440

Palier de barre milieu

OE 7700667182

Middle bar main bearing



1 Blanc white Barre Ø 17.4

TT /all models	T V	03/89-
TT /all models		01/97-

4001442

Palier de barre milieu

OE 7700667186

Middle bar main bearing



1 Jaune Yellow Barre Ø 25.5

TT /all models	T V	03/89-
TT /all models		01/97-

4001443

Palier de barre milieu

OE 7700667187

Middle bar main bearing



1 Bleu Blue Barre Ø 27.4

TT /all models	P	
TT /all models	T V	03/89-
TT /all models		01/97-

4001514

Articulation barre stab.

OE 7700611100

Stabilizer bar bush



3 Ø int.9 Ø ext.29 long. tube int.26 ext.22.5

TT /all models	P	
TT /all models	T V	03/89-
TT /all models		01/97-



Eléments SUSPENSION

Suspension parts

Elementos suspensión

Elementy zawieszenie

Элементы подвески

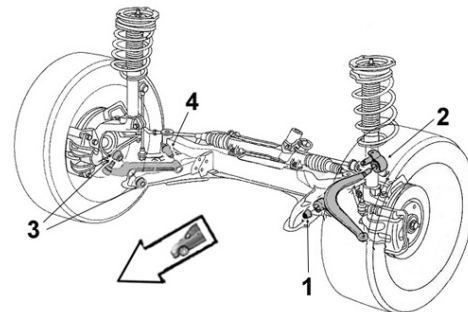

4001513

Articulation AV/AR

OE 7701349064

Front rear bush



1 2 Ø int.18 Ø ext.36 long. tube int.58.5 ext.48.5

TT /all models	P	
TT /all models	T V	03/89-
TT /all models		01/97-

... Trafic I ...

SASIC

RENAULT

Bras & Triangle de suspension

Control arm
Brazo y triángulo
Wahacz
Рычаг подвески

G/L  D/R



4005270

Rotule de susp. inf. G/D

OE 7701461667

L/R lower suspension ball joint



1
2

TT /all models PA PC
TT /all models P3 P5 P6 P8
TT /all models T1/1/2/3/4/5/6
TT /all models T7//9/A/B/C/E
TT /all models V2/3/4/5/9

405A418S

Kit rép. train AV

OE -

Front axle repair kit



Sans visserie *Without screws and bolts*

TT /all models PA PC
TT /all models P3 P5 P6 P8
TT /all models T1/1/2/3/4/5/6
TT /all models T7//9/A/B/C/E
TT /all models V2/3/4/5/9

4005418

Kit rép. triangle susp. G ou D

OE -

L or R track control arm bearing repair kit



Avec visserie *With screws and bolts*

TT /all models PA PC
TT /all models P3 P5 P6 P8
TT /all models T1/1/2/3/4/5/6
TT /all models T7//9/A/B/C/E
TT /all models V2/3/4/5/9



Support d'amortisseur

Suspension mounting
Soporte amortiguador
Poduszka amortyzatora
Опора амортизатора

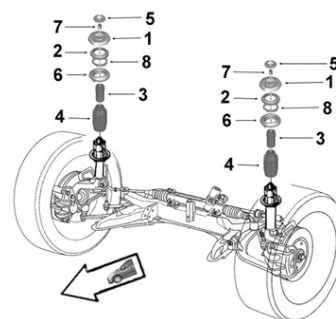

4001612

Support suspension G/D

OE 7700734718

L/R suspension mounting



1 **Avec roulement** *With bearing*

TT /all models P
TT /all models T V 03/89-
TT /all models 01/97-

4001610

Butée de suspension G/D

OE 7700714835

L/R suspension bush



3

TT /all models P
TT /all models T V 03/89-
TT /all models 01/97-

4005378

Protecteur amortisseur G/D

OE 7704001726

L/R shock absorber protector



4

TT /all models P
TT /all models T V 03/89-
TT /all models 01/97-

4005212

Kit rép. protection amort. G et D

OE -

L/R susp. mounting repair kit



TT /all models PA PC
TT /all models P3 P5 P6 P8
TT /all models T1/1/2/3/4/5/6 03/89-
TT /all models T7//9/A/B/C/E 03/89-
TT /all models V2/3/4/5/9 03/89-

... Trafic I



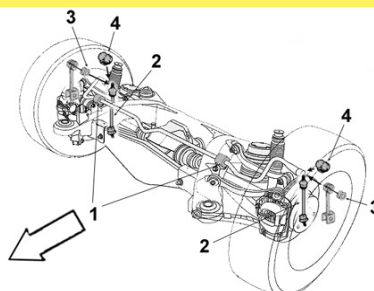

Barre stabilisatrice
 Stabilizer bar
 Barra estabilizadora
 Drążek stabilizatora
 стабилизатор поперечной устойчивости



RENAULT





4003380	Biellette barre stab. AR	4003381	Biellette barre stab. AR
OE 7704001091	Rear stabilizer bar stub axle	OE 7704001232	Rear stabilizer bar stub axle
	2 TT /all models T5 03/89-		2 TT /all models TB T7 03/89- 2.0 1400 1600kg TE 03/89-

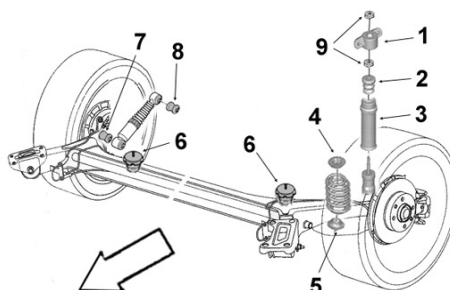

Support d'amortisseur
 Suspension mounting
 Soporte amortiguador
 Poduszka amortyzatora
 Опора амортизатора





4003395	Butée de talonnage G/D	4003396	Butée de talonnage G/D
OE 7704000423	L/R bushing	OE 7704001647	L/R bushing
	6 long. 99 larg. 71 H49.5 TT /all models TE T7 T5 TB 03/89-		6 long. 100 larg. 71.5 H62.9 TT /all models TC TG TH TM 03/89- T1 T2 T3 T4 03/89-

Eléments TRAIN ARRIERE

Rear axle parts
 Tren TRAS
 Elementy zawieszenia tylnego
 элементы задней оси.



4005519	Art. jumelle lame ressort	4003391	Articulation lame
Part/oe 7704001921	Spring shackle bush	OE 7700730733	Leaf bush
	TT /all models PC-- P3-- 03/89- TT /all models T1 T2 T3 T4 03/89-10/97 TT /all models T5 T7 TB TC 03/89- TT /all models V3 V4 V5 03/89- 1.9 D TF 11/97- 1.9 D TH 09/97- 2.0 1400 1600kg TE 03/89-10/97 2.1 D TM 03/89-10/97		Ø int.14 Ø ext.37 coll.42 x2 long. tube int.80 ext.68 ep. coll.5x2 TT /all models Sauf TC V3 V4 V5 T V 03/89- Sauf TC V3 V4 V5 01/97-

Trafic II ...

SASIC

RENAULT

Eléments DIRECTION
 Steering parts
 Elementos Direcciones
 Elementy układ kierowniczy
 Элементы рулевой системы

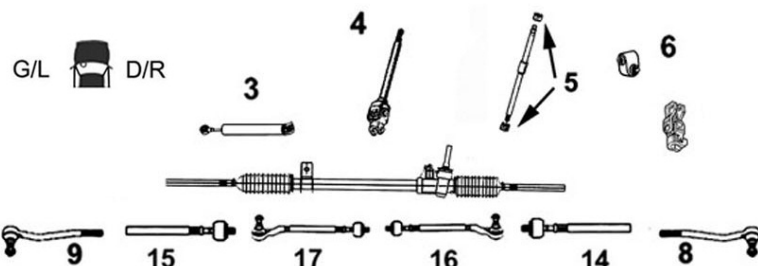

3008247 Axe de bielle G/D

Part/oe 7701473333 L/R axial joint



14 Côté dir. M12x1.0 Côté rot. M14x1.5 long 263 mm

1.9 DCi	EL0B/C	FL0B/C/K	JL0B/C/K
2.0i 16v.	EL0A/L	FL0A/G/L/N/W/2	JL0A/G/L/N/W/2
2.0 DCi	EL0H/M/P/S/0/1	FL0H/M/P/S/U/0/1	JL0H/M/P/S/U/0/1
2.5 DCi	EL0D/J/R/V	FL0D/J/R/V	JL0D/J/R/V

4006147 Rotule de direction G

OE 485202714R Left tie rod end



9	1.9 DCi	EL0B/C	FL0B/C/K
	1.9 DCi	JL0B/C/K	
	2.0i 16v.	EL0A/L	FL0A/G/L/N/W/2
	2.0i 16v.	JL0A/G/L/N/W/2	
	2.0 DCi	EL0H/M/P/S/0/1	
	2.0 DCi	FL0H/M/P/S/U/0/1	
	2.0 DCi	JL0H/M/P/S/U/0/1	
	2.5 DCi	EL0D/J/R/V	
	2.5 DCi	FL0D/J/R/V	JL0D/J/R/V

4006148 Rotule de direction D

OE 485209446R Right tie rod end



8	1.9 DCi	EL0B/C	FL0B/C/K
	1.9 DCi	JL0B/C/K	
	2.0i 16v.	EL0A/L	FL0A/G/L/N/W/2
	2.0i 16v.	JL0A/G/L/N/W/2	
	2.0 DCi	EL0H/M/P/S/0/1	
	2.0 DCi	FL0H/M/P/S/U/0/1	
	2.0 DCi	JL0H/M/P/S/U/0/1	
	2.5 DCi	EL0D/J/R/V	
	2.5 DCi	FL0D/J/R/V	JL0D/J/R/V



Barre stabilisatrice
 Stabilizer bar
 Barra estabilizadora
 Drażek stabilizatora
 стабилизатор поперечной устойчивости

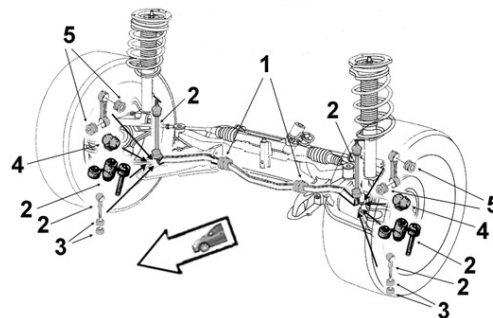

4005141 Bielle barre stab.

OE 8200661217 Stabilizer bar stub axle



2	1.9 DCi	EL0B/C	FL0B/C/K	05/01-		
	1.9 DCi	JL0B/C		05/01-		
	2.0i 16v.	EL0A	FL0A/G	JL0A/G	05/01-	
	2.0 DCi	E/F/JL	0H/M/P/S	F/JL	0U/0/1	05/01-
	2.5 DCi	EL0D	FL0D	JL0D		05/01-

... Trafic II ...



Eléments SUSPENSION

Suspension parts
Elementos suspensión
Elementy zawieszenie
Элементы подвески

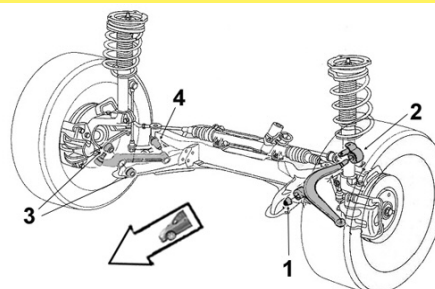

RENAULT



2254007

Articulation AV

Part/oe 8200602617 Front bush



1 Ø int.18 Ø ext.55 long. tube int. 50 ext. 31

1.9 DCi	EL0B/0C FL0B JL0B	
1.9 DCi	FL0C/0K JL0C/0K	-10/06
1.9 DCi Jante tôle 16 Pouces	FL0C/0K JL0C/0K	10/06-11/12/06
2.0i 16v.	EL0A FL0A/0G JL0A/0G	
2.0i 16v. Jante tôle 16 Pouces	EL0L FL0L/0N JL0L/0N	-11/12/06
2.0 DCi Jante tôle 16 Pouces	FL0H/M	-11/12/06
2.0 DCi Jante tôle 16 Pouces Châssis long standard	FL0H BV rob. 6	-11/12/06
2.5 DCi	EL0D FL0D JL0D	
2.5 DCi Châssis court Jante tôle 16 pouces	FL0J	-11/12/06

2254008

Articulation AR

Part/oe 8200602617 Rear bush



2 Ø int. 14 Ø ext. 58 long. tube int. 54 ext. 29

1.9 DCi	EL0B/0C FL0B JL0B	
1.9 DCi	FL0C/0K JL0C/0K	-10/06
1.9 DCi Jante tôle 16 Pouces	FL0C/0K JL0C/0K	10/06-11/12/06
2.0i 16v. Jante tôle 16 Pouces	EL0L FL0L/0N	-11/12/06
2.0i 16v.	EL0A FL0A/0G JL0A/0G	
2.0i 16v.	JL0L/0N	-11/12/06
2.0 DCi Jante tôle 16 Pouces	FL0H/M	-11/12/06
2.0 DCi Jante tôle 16 Pouces Châssis long standard	FL0H BV rob. 6	-11/12/06
2.5 DCi	EL0D FL0D JL0D	
2.5 DCi Châssis court Jante tôle 16 pouces	FL0J	-11/12/06

Bras & Triangle de suspension

Control arm
Brazo y triángulo
Wahacz
Рычаг подвески

G/L D/R

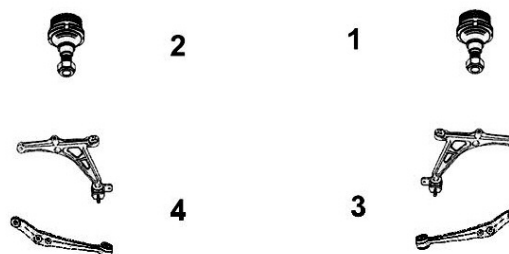

9005770

Triangle de susp. inf. G

OE 8200565072 Lower left track control arm



4 Avec rotule With ball joint

1.9 DCi	EL0B/0C FL0B JL0B	
1.9 DCi	FL0C/0K JL0C/0K	-10/06
1.9 DCi Jante tôle 16 Pouces	FL0C/0K JL0C/0K	10/06-11/12/06
2.0i 16v.	EL0A FL0A/0G JL0A/0G	
2.0i 16v. Jante tôle 16 Pouces	EL0L FL0L/0N JL0L/0N	-11/12/06
2.0 DCi Jante tôle 16 Pouces	FL0H/M	-11/12/06
2.0 DCi Jante tôle 16 Pouces	Châssis long standard	FL0H BV rob. 6
		-11/12/06
2.5 DCi	EL0D FL0D JL0D	
2.5 DCi Châssis court	Jante tôle 16 pouces	FLOJ -11/12/06

9005769

Triangle de susp. inf. D

OE 8200565079 Lower right track control arm



3 Avec rotule With ball joint

1.9 DCi	EL0B/0C FL0B JL0B	
1.9 DCi	FL0C/0K JL0C/0K	-10/06
1.9 DCi Jante tôle 16 Pouces	FL0C/0K JL0C/0K	10/06-11/12/06
2.0i 16v.	EL0A FL0A/0G JL0A/0G	
2.0i 16v. Jante tôle 16 Pouces	EL0L FL0L/0N JL0L/0N	-11/12/06
2.0 DCi Jante tôle 16 Pouces	FL0H/M	-11/12/06
2.0 DCi Jante tôle 16 Pouces	Châssis long standard	FL0H BV rob. 6
		-11/12/06
2.5 DCi	EL0D FL0D JL0D	
2.5 DCi Châssis court	Jante tôle 16 pouces	FLOJ -11/12/06

... Trafic II ...

Bras & Triangle de suspension

Control arm
Brazo y triángulo
Wahacz
Рычаг подвески

G/L  D/R

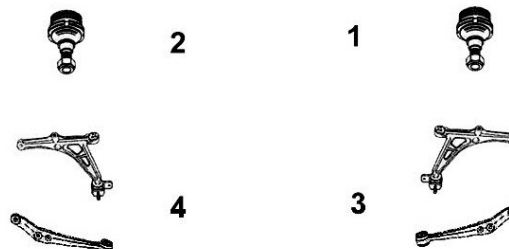

RENAULT



7474026

Triangle de susp. inf. G

OE 8200876659

Lower left track control arm

NEW

4 Avec rotule With ball joint



1.9 DCi		FL0C/OK	10/06-11/12/06
1.9 DCi	Jante alu 16 Pouces	JL0C/OK	10/06-
1.9 DCi	Jante tôle 16 Pouces	JL0C/OK	11/12/06-
2.0i	Jante alu 16 Pouces	EL0L	
2.0i	Jante tôle 16 Pouces	EL0L	11/12/06-
2.0i 16v.		FL02/OW JL02/OW	
2.0i 16v.	Jante alu 16 Pouces	FL0L JL0L/ON	
2.0i 16v.	Jante tôle 16 Pouces	FL0L JL0L/ON	11/12/06-
2.0 DCi		EL00/01/0H/0M/0P/0S	FL/JL/00/01/0P/0S/0U
2.0 DCi	Jante tôle 16 Pouces Châssis long surélevé	FL0H BV rob. 6	-11/12/06
2.0 DCi	Jante tôle 16 Pouces	FL0H JL0H/0M	11/12/06-
2.0 DCi	Jante tôle 16 Pouces Châssis long	JL0H/0M	-11/12/06
2.0 DCi	Jante alu 16 Pouces	FL0H JL0H/0M	
2.5 DCi		EL0J/0R/0V	FL/JL/0R/0V
2.5 DCi	Jante alu 16 Pouces	FL0J JL0J	
2.5 DCi	Jante tôle 16 Pouces Châssis long	FL0J JL0J	-11/12/06
2.5 DCi	Jante tôle 16 Pouces	FL0J JL0J	11/12/06-

7474025

Triangle de susp. inf. D

OE 8200876657

Lower right track control arm

NEW

3 Avec rotule With ball joint



1.9 DCi		FL0C/OK	10/06-11/12/06
1.9 DCi	Jante alu 16 Pouces	JL0C/OK	10/06-
1.9 DCi	Jante tôle 16 Pouces	JL0C/OK	11/12/06-
2.0i	Jante alu 16 Pouces	EL0L	
2.0i	Jante tôle 16 Pouces	EL0L	11/12/06-
2.0i 16v.		FL02/OW JL02/OW	
2.0i 16v.	Jante alu 16 Pouces	FL0L JL0L/ON	
2.0i 16v.	Jante tôle 16 Pouces	FL0L JL0L/ON	11/12/06-
2.0 DCi		EL00/01/0H/0M/0P/0S	FL/JL/00/01/0P/0S/0U
2.0 DCi	Jante tôle 16 Pouces Châssis long surélevé	FL0H BV rob. 6	-11/12/06
2.0 DCi	Jante tôle 16 Pouces	FL0H JL0H/0M	11/12/06-
2.0 DCi	Jante tôle 16 Pouces Châssis long	JL0H/0M	-11/12/06
2.5 DCi		EL0J/0R/0V	FL/JL/0R/0V
2.5 DCi	Jante alu 16 Pouces	FL0J JL0J	
2.5 DCi	Jante tôle 16 Pouces Châssis long	FL0J JL0J	-11/12/06
2.5 DCi	Jante tôle 16 Pouces	FL0J JL0J	11/12/06-

4005278

Rotule de susp. inf. G/D

OE 401606676R

L/R lower suspension ball joint



1.9 DCi		EL0B/0C	FL0B	JL0B	
1.9 DCi		FL0C/OK	JL0C/OK		-10/06
1.9 DCi	Jante tôle 16 Pouces	FL0C/OK	JL0C/OK		10/06-11/12/06
2.0i 16v.		EL0A	FL0A/0G	JL0A/0G	
2.0i 16v.	Jante tôle 16 Pouces	EL0L	FL0L/ON	JL0L/ON	-11/12/06
2.0 DCi	Jante tôle 16 Pouces Sauf Châssis long surélevé	FL0H	BV rob. 6		-11/12/06
2.0 DCi	Jante tôle 16 Pouces Sauf Châssis long	JL0H/0M			-11/12/06
2.0 DCi	Jante tôle 16 Pouces	FL0M			-11/12/06
2.5 DCi		EL0D	FL0D	JL0D	
2.5 DCi	Châssis court Jante tôle 16 pouces	FL0J	JL0J		-11/12/06

... Trafic II ...

RENAULT



4005281

Rotule de susp. inf. G/D

OE 7701477385

L/R lower suspension ball joint



1 2	1.9 DCi	Jante alu 16 Pouces	FLOC/0K JL0C/0K	10/06-11/12/06
	1.9 DCi		FLOC/0K JL0C/0K	11/12/06-
	2.0i 16v.	Jante alu 16 Pouces	EL0L FL0L/0N JL0L/0N	-11/12/06
	2.0i 16v.		EL0L FL0L/0N JL0L/0N	11/12/06-
	2.0i 16v.		FL0W/02 JL0W/02	
	2.0 DCi	Jante alu 16 Pouces Sauf Châssis long surélevé	FL0H BV rob. 6	-11/12/06
	2.0 DCi	Châssis long surélevé	FL0H BV rob. 6	-11/12/06
	2.0 DCi	Jante alu 16 Pouces Sauf Châssis long	JL0H/0M	-11/12/06
	2.0 DCi	Châssis long	JL0H/0M	-11/12/06
	2.0 DCi		EL0H/0M/0P/0S/00/01	
	2.0 DCi		FL/JL/0U/0P/0S/00/01	
	2.0 DCi	Jante alu 16 Pouces	FL0M	-11/12/06
	2.0 DCi		FL0H/0M JL0H/0M	11/12/06-
	2.5 DCi		EL0J/0R/0V FL0R/0V JL0R/0V	



Support d'amortisseur

Suspension mounting
Soporte amortiguador
Poduszka amortyzatora
Опора амортизатора

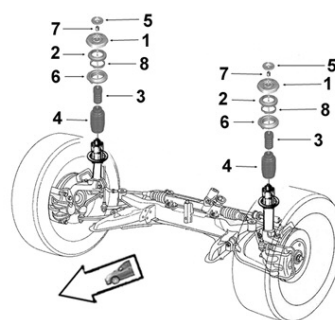

4001632

Coupelle rebond.

OE 8200619656

Spring cup



5	1.9 DCi	EL0B/0C FL0B/0C/0K	05/01-
	1.9 DCi	JL0B/0C	05/01-
	2.0i 16v.	EL0A FL/JL/0A/0G	05/01-
	2.5 DCi	EL0D FL0D JL0D	05/01-

4005524

Entretoise

OE 8200619779

Brace



7	Ø int.16 Ø ext.23 long. tube ext.27		
	1.9 DCi	EL0B/0C FL0B/0C/0K	05/01-
	1.9 DCi	JL0B/0C	05/01-
	2.0i 16v.	EL0A FL/JL/0A/0G	05/01-
	2.5 DCi	EL0D FL0D JL0D	05/01-

4001637

Support suspension G/D

OE 8200904007

L/R suspension mounting



1	1.9 DCi	05/01-
	2.0 DCi	08/06-
	2.0i 16v.	05/01-
	2.5 DCi	05/01-

4005306

Butée à billes

OE 8200010518

Ball bearing



2	1.9 DCi	EL0B/0C	FL0B/0C/0K	05/01-	
	1.9 DCi	JL0B/0C/0K		05/01-	
	2.0i 16v.	EL0A/L	FL0A/G/L/N/W/2	JL0A/G/L/N/W/2	05/01-
	2.0 DCi	EL0H/M/P/S	FL0H/M/U/0/1/P/S	JL0H/M/U/0/1/P/S	05/01-
	2.5 DCi	EL0D/J/R/V	FL0D/J/R/V	JL0D/J/R/V	05/01-

... Trafic II

SASIC

RENAULT



Support d'amortisseur
Suspension mounting
Soporte amortiguador
Poduszka amortyzatora
Опора амортизатора

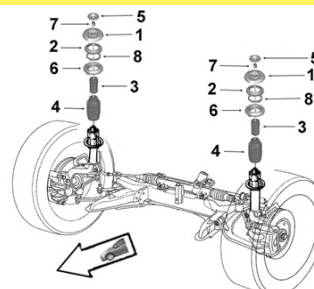

4001633

Coupelle sup. ressort

OE 8200630478

Upper cup spring

6



1.9 DCi	EL0B/C	FL0B/C/K	05/01-
1.9 DCi	JL0B/C		05/01-
2.0i 16v.	EL0A	FL/JL/0A/G	05/01-
2.5 DCi	EL0D	FL0D JL0D	05/01-

4001630

Butée protecteur susp. AV

OE 8200010491

Front suspension bush

3



1.9 DCi	EL0B/C	FL0B/C/K	05/01-
1.9 DCi	JL0B/C		05/01-
2.0i 16v.	EL0A/L	FL0A/G/L/N/W/2	05/01-
	JL0A/G/L/N/W/2		05/01-
2.0 DCi	EL0H/M/P/S	FL0H/M/U/0/1/P/S	05/01-
	JL0H/M/U/0/1/P/S		05/01-
2.5 DCi	EL0D/J/R/V	FL0D/J/R/V	05/01-
	JL0D/J/R/V		05/01-



Support d'amortisseur
Suspension mounting
Soporte amortiguador
Poduszka amortyzatora
Опора амортизатора

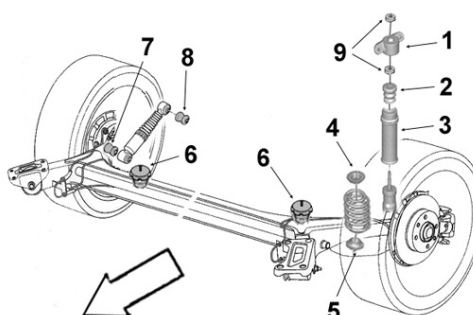

2654003

Appui inf. ressort AR

OE 8200190743

Lower support Rear spring

5



1.9 DCi	EL0B/0C	FL0B/0C/0K	JL0B/0C/0K	05/01-
2.0i 16v.	EL0A/0L	FL0A/0G/0L/0N/0W	JL0A/0G/0L/0N/0W	05/01-
2.0 DCi	EL0H/0M	FL0H/0M/0U	JL0H/0M/0U	05/01-
2.5 DCi	EL0D/0J/0R/0V	FL0D/0J/0R/0V	JL0D/0J/0R/0V	05/01-

Eléments TRAIN ARRIERE

Rear axle parts

Tren TRAS

Elementy zawieszenia tylnego

элементы задней оси.



4005507

Articulation AR

OE 8200431675

Rear bush

Ø int.12.8 Ø ext.70 long.tube int.70 ext.60.1



1.9 DCi	EL0B/0C	FL0B/0C/0K		05/01-
1.9 DCi	JL0B/0C			05/01-
2.0	EL0A	FL0A/0G	JL0A/0G	05/01-
2.5 DCi	EL0D	FL0D	JL0D	05/01-

25 45

Eléments DIRECTION
Steering parts
Elementos Direcciones
Elementy układ kierowniczy
Элементы рулевой системы

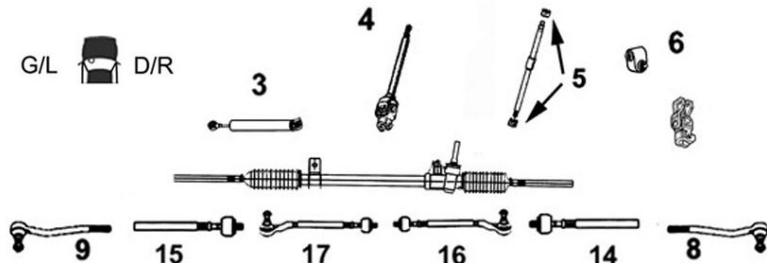

9006588 Rotule de direction G/D

OE QJB000826EVA *L/R tie rod end*



8 M14 x 1.5
9 -ch YD461772

1.4i 16v.	25		01/00-11/02
1.6i 16v.	25		01/00-11/02
1.8i 16v.	25	18K4K	01/00-09/01
2.0 iDT	25	20T2N	01/00-08/04

9006697 Rotule de direction G

OE QGX100050 *Left tie rod end*



9 M14 x 1.5

1.4i 16v.	45	
1.6i 16v.	45	
1.8i 16v.	45	
2.0 V6	45	BVA
2.0 TD	45	

9006695 Rotule de direction D

OE QGX100060 *Right tie rod end*



8 M14 x 1.5

1.4i 16v.	45	
1.6i 16v.	45	
1.8i 16v.	45	
2.0 V6	45	BVA
2.0 TD	45	

Bras & Triangle de suspension

Control arm
Brazo y triángulo
Wahacz
Рычаг подвески

G/L D/R

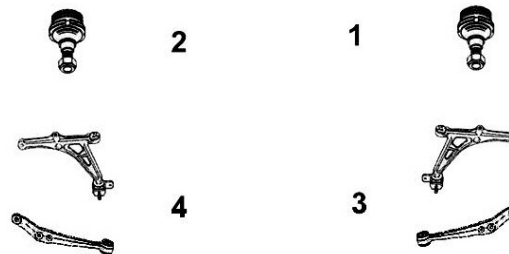

9005198 Bras de suspension G

OE RBJ100791 *Left track control arm*



4 Avec rotule With ball joint

1.4i 16v.	25		01/00-11/02
1.6i 16v.	25		01/00-11/02
1.8i 16v.	25	18K4F	01/00-08/04
2.0 iDT	25	20T2N	01/00-08/04

9005197 Bras de suspension D

OE RBJ100781 *Right track control arm*



3 Avec rotule With ball joint

1.4i 16v.	25		01/00-11/02
1.6i 16v.	25		01/00-11/02
1.8i 16v.	25	18K4F	01/00-08/04
2.0 iDT	25	20T2N	01/00-08/04

75

Eléments DIRECTION
 Steering parts
 Elementos Direcciones
 Elementy układ kierowniczy
 Элементы рулевой системы

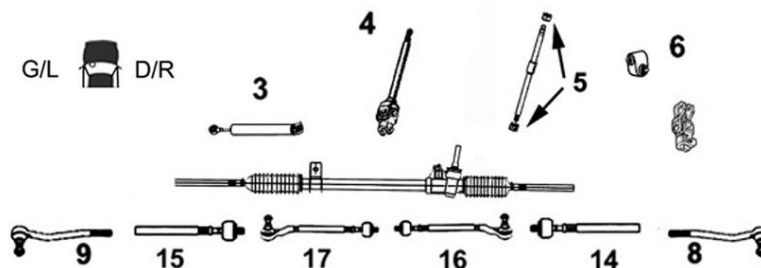

9006699 Rotule de direction G
 OE QJB100190 Left tie rod end



9 M14 x 1.5

1.8i Turbo
 2.0i V6
 2.0 CDT
 2.0 CDTi
 2.5i V6

9006698 Rotule de direction D
 OE QJB100180 Right tie rod end



8 M14 x 1.5

1.8i Turbo
 2.0 V6
 2.0 CDT
 2.0 CDTi
 2.5 V6

100

Eléments DIRECTION
 Steering parts
 Elementos Direcciones
 Elementy układ kierowniczy
 Элементы рулевой системы

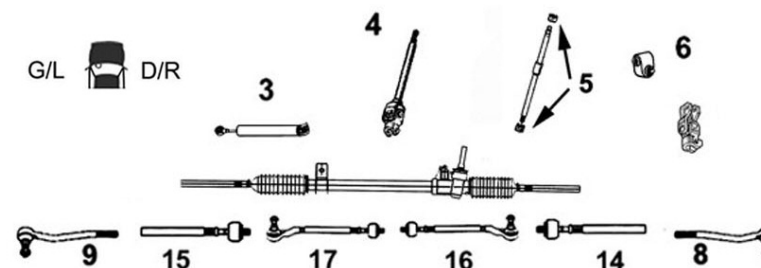

9006584 Rotule de direction G/D
 OE GSJ734 L/R tie rod end



8
9

TT /all models Rover 111 114
 Sauf 16v. 1/2 x 20 UNF pneus 155

04/90-

Bras & Triangle de suspension

Control arm
 Brazo y triángulo
 Wahacz
 Рычаг подвески

G/L D/R

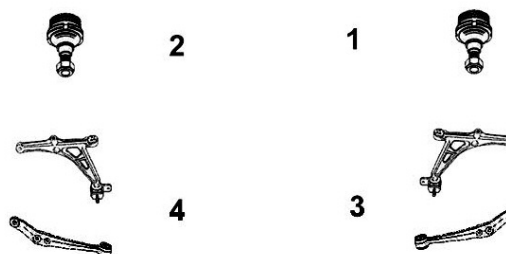

9005401 Rotule de susp. G/D Sup.
 OE RBG000020SLP L/R upper susp. ball joint



1
2

TT /all models Rover 111 114

Pneus 155 et 185

04/90-

200

Eléments DIRECTION
 Steering parts
 Elementos Direcciones
 Elementy układ kierowniczy
 Элементы рулевой системы

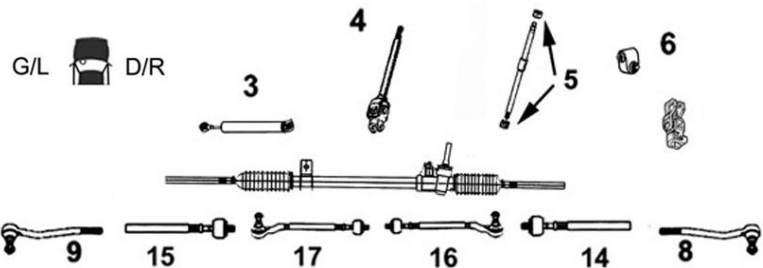

9006585
 OE GSJ281

Rotule de direction G/D
 L/R tie rod end



8 M12 x 1.25
9
 TT/all models 213 214 216
 1.8 218 08/84-06/90
 2.0 220 08/84-06/90

9006588
 OE QJB100120

Rotule de direction G/D
 L/R tie rod end

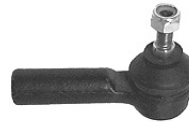

8 M14 x 1.5
9
 TT /all models 214 216 218 220
 06/90-02/96

Bras & Triangle de suspension

Control arm
 Brazo y triángulo
 Wahacz
 Рычаг подвески

G/L D/R

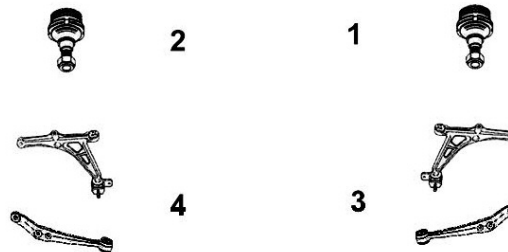

9005198
 OE RBJ100791

Bras de suspension G
 Left track control arm



4 Avec rotule With ball joint
 TT /all models 214 216 218 220
 06/90-02/96

9005197
 OE RBJ100781

Bras de suspension D
 Right track control arm



3 Avec rotule With ball joint
 TT /all models 214 216 218 220
 06/90-02/96

400 ...

Eléments DIRECTION
 Steering parts
 Elementos Direcciones
 Elementy układ kierowniczy
 Элементы рулевой системы

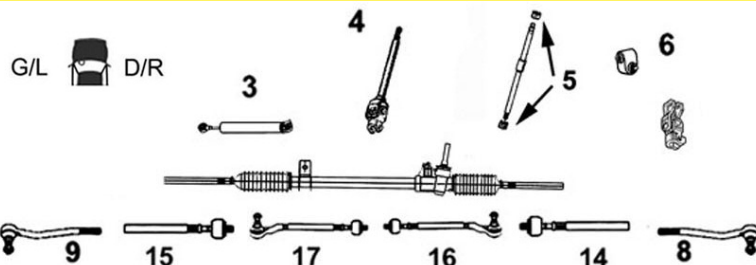

9006588
 OE QJB100120

Rotule de direction G/D
 L/R tie rod end



8 M14 x 1.5
9
 TT /all models 414 416 418 420
 06/90-

... 400

Bras & Triangle de suspension

Control arm
Brazo y triángulo
Wahacz
Рычаг подвески

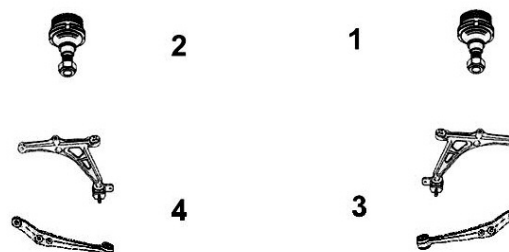
G/L  D/R**9005198****Bras de suspension G**

OE RBJ100791

*Left track control arm***4** Avec rotule With ball joint

TT /all models 414 416 418 420
06/90-

9005197**Bras de suspension D**

OE RBJ100781

*Right track control arm***3** Avec rotule With ball joint

TT /all models 414 416 418 420
06/90-

Metro**Eléments DIRECTION**

Steering parts
Elementos Direcciones
Elementy układ kierowniczy
Элементы рулевой системы

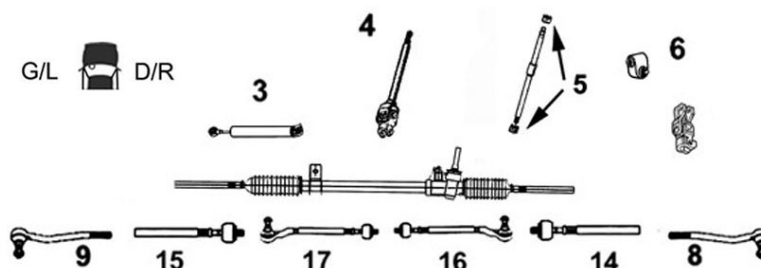
G/L  D/R**9006584****Rotule de direction G/D**

OE QJB10004EVA

*L/R tie rod end***8**
9

TT /all models
TT /all models

Sauf 16v.

1/2UNF

1/2 x 20 UNF pneu 155

01/80-04/90

04/90-

Bras & Triangle de suspension

Control arm
Brazo y triángulo
Wahacz
Рычаг подвески

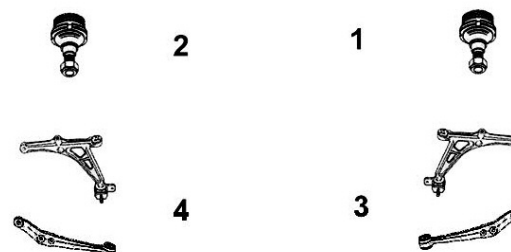
G/L  D/R**9005401****Rotule de susp. G/D Inf./sup.**OE RBG000020SLP *Susp. ball joint L/R inner/outer***1**
2

TT /all models
TT /all models

Pneus 155 et 185

11/84-04/90

04/90-

Mini

Eléments DIRECTION
Steering parts
Elementos Direcciones
Elementy układ kierowniczy
Элементы рулевой системы

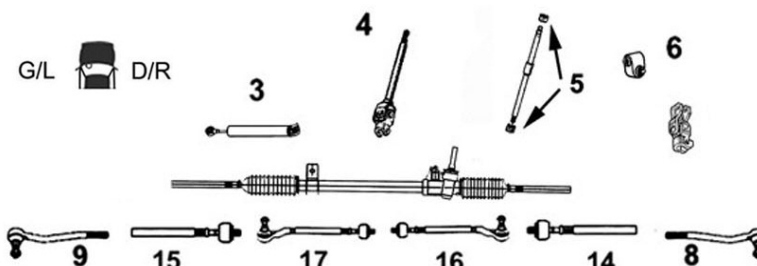

9006584 Rotule de direction G/D

OE QJB10004EVA L/R tie rod end

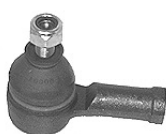

8
9

TT /all models 1000kg 1200kg Ch- 463278

9-3

Eléments DIRECTION
Steering parts
Elementos Direcciones
Elementy układ kierowniczy
Элементы рулевой системы

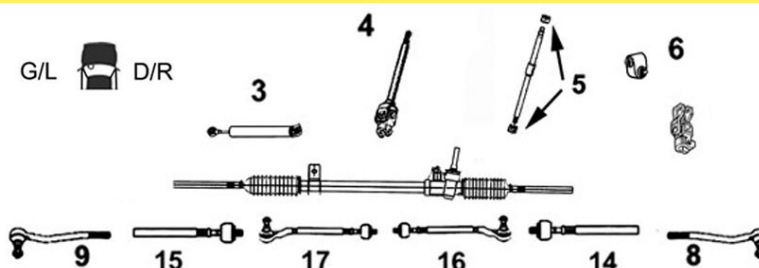

9006370 Rotule de direction G

OE 4242749 Left tie rod end



9

M16 x 1.5

2.0i 16v. /Turbo -08/02
2.2 TiD -08/02
2.3i 16v. Turbo -08/02

9006371 Rotule de direction D

OE 4242756 Right tie rod end



8

M16 x 1.5

2.0i 16v. /Turbo -08/02
2.2 TiD -08/02
2.3i 16v. Turbo -08/02

9006558 Rotule de direction G

OE 93194328 Left tie rod end



9

M14 x 1.5

1.8i 16v. 4ptes 09/02-
1.9 CDTi 09/04-

9006557 Rotule de direction D

OE 93172255 Right tie rod end



8

M14 x 1.5

1.8i 16v. 4ptes 09/02-
1.9 CDTi 09/04-

9-5 ...

Eléments DIRECTION
Steering parts
Elementos Direcciones
Elementy układ kierowniczy
Элементы рулевой системы

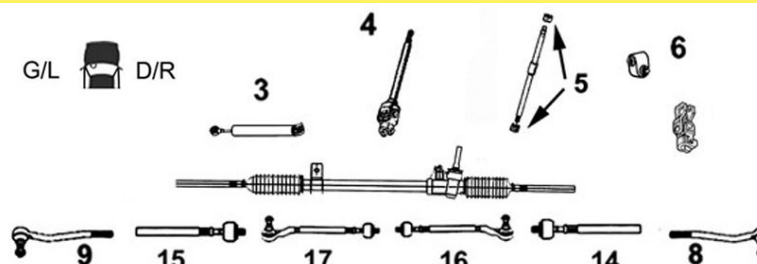

9006561 Rotule de direction G/D

OE 4836540 L/R tie rod end



8
9

M14 x 1.5

2.0i 16v. Turbo
2.0i 16v. Turbo 4ptes Break
2.3i 16v. Turbo
2.3i 16v. Turbo 185hp 136kw 250hp 184kw 4ptes Break
3.0 T V6
3.0 T V6 4ptes Break

B205E -06/01
07/01-12/01
B235E B235R -06/01
07/01-12/01
-06/01
07/01-12/01

... 9-5

Eléments DIRECTION

Steering parts
Elementos Direcciones
Elementy układ kierowniczy
Элементы рулевой системы

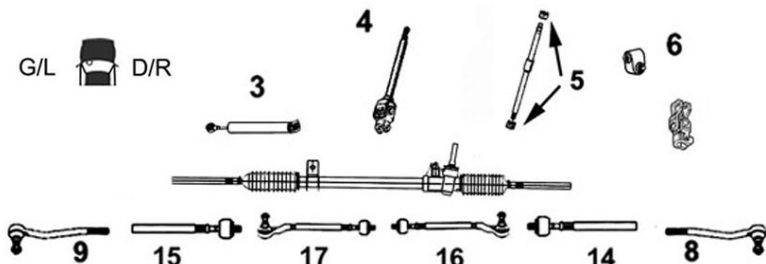

9006558

Rotule de direction G

OE 93172254

Left tie rod end



9

M14x1.5

2.0i 16v. Turbo 4ptes Break 01/02-
2.2 TID 4ptes Break 07/01-
2.3i 16v. Turbo 185hp 220hp 250hp
4ptes Break 07/01-
3.0 T V6 4ptes Break 01/02-
3.0 TID V6 4ptes Break 07/01-

9006557

Rotule de direction D

OE 93194329

Right tie rod end



8

M14x1.5

2.0i 16v. Turbo 4ptes Break 01/02-
2.2 TID 4ptes Break 07/01-
2.3i 16v. Turbo 185hp 220hp 250hp
4ptes Break 07/01-
3.0 T V6 4ptes Break 01/02-
3.0 TID V6 4ptes Break 07/01-

Bras & Triangle de suspension

Control arm
Brazo y triángulo
Wahacz
Рычаг подвески



9005564

Rotule de susp. inf. G/D

OE 5237516

L/R lower suspension ball joint



1

2.0i 16v. Turbo 4ptes Break 01/02-
2.2 TID 07/01-
2.3i 16v. Turbo 185hp 220hp 250hp 4ptes Break 07/01-
3.0 T V6 4ptes Break 01/02-
3.0 TID V6 4ptes Break 01/02-

9000

Eléments DIRECTION

Steering parts
Elementos Direcciones
Elementy układ kierowniczy
Элементы рулевой системы

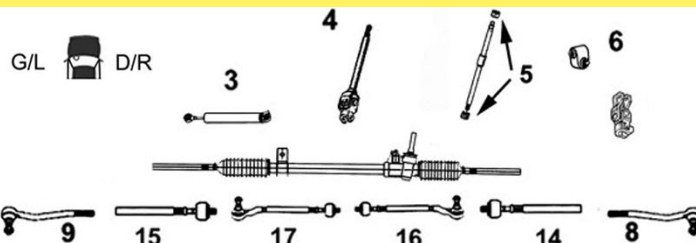

9006279

Axe de bielle G/D

OE 8962250

L/R axial joint



14

15

Côté dir. M14x1.5 Côté rot. M14x1.5 long 305 mm

TT /all models 01/85-

Bras & Triangle de suspension

Control arm
Brazo y triángulo
Wahacz
Рычаг подвески



9005448

Rotule de susp. inf. G/D

OE 8972135

L/R lower suspension ball joint



1

2

TT /all models 01/85-

Alhambra ...

Eléments DIRECTION

Steering parts

Elementos Direcciones

Elementy uklad kierowniczy

Элементы рулевой системы

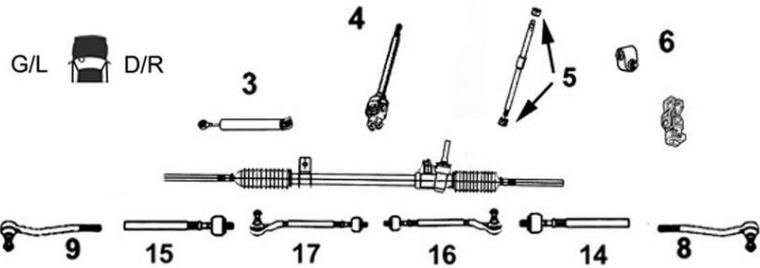

9006229 Axe de bielle G/D

Part/oe 7M3422804A L/R axial joint



14 Côté dir. M14x1.5 Côté rot. M14x1.5 long 184 mm

15

TT /all models

-05/10

9006460 Rotule de direction G

OE 7M0422817A Left tie rod end



9 M14 x 1.5

TT /all models

-05/10

9006459 Rotule de direction D

OE 7M0422818A Right tie rod end



8 M14 x 1.5

TT /all models

-05/10

9006638 Rotule de direction G

OE 1K0423811J Left tie rod end



9 M16 x 1.5

1.4 TSi CAVA 09/10-
2.0 TDi CFFB 09/10-

9006637 Rotule de direction D

OE 1K0423812J Right tie rod end



8 M16 x 1.5

1.4 TSi CAVA 09/10-
2.0 TDi CFFB 09/10-

... Alhambra ...

SASIC

SEAT



Barre stabilisatrice
 Stabilizer bar
 Barra estabilizadora
 Drażek stabilizatora
 стабилизатор поперечной устойчивости

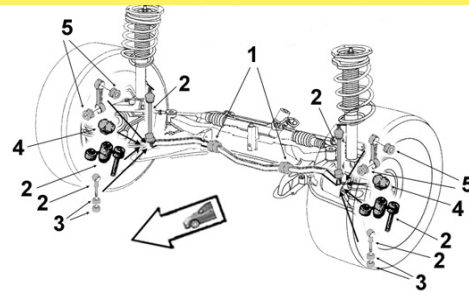

2306010 **Biellette barre stab.**
 OE 1K0411315P *Stabilizer bar stub axle*

9001779 **Palier de barre milieu**
 OE 7M0411031 *Middle bar main bearing*



2

1.4 TSi 06/10-
 2.0 TDi 06/10-



1 Ø 16.5

TT /all models -05/10



Eléments SUSPENSION
 Suspension parts
 Elementos suspensión
 Elementy zawieszenie
 Элементы подвески

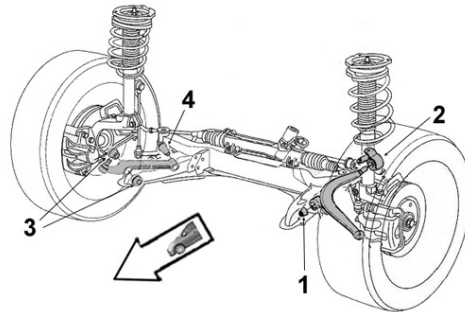

9001763 **Articulation AR**
 OE 7M0407181A *Rear bush*



2 Ø int.18 Ø ext.60.5 long. tube int. 48 ext. 33 ep. coll.4

TT /all models -05/10

2256007 **Articulation AR inf.**
 OE 3C0199231D *Rear lower bush*



2

1.4 TSi 09/10-
 2.0 TDi 140hp 103kw 170hp 125kw 09/10-

9001436 **Articulation AV**
 OE 7M0501541 *Front bush*



1 Ø int.14 Ø ext.35 coll.38 x2 long. tube int.60 ext.33 ep. coll.5x2

TT /all models -05/10

... Alhambra ...

Bras & Triangle de suspension





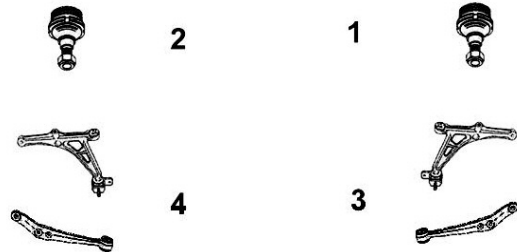

Control arm
Brazo y triángulo
Wahacz
Рычаг подвески

G/L  D/R



SEAT



<p>9005751 OE 7M0407151B</p> 	<p>Triangle de susp. G <i>Left track control arm</i></p> <p>4 Sans rotule <i>Without tie rod end</i></p> <p>TT /all models -05/10</p>	<p>9005752 OE 7M0407152B</p> 	<p>Triangle de susp. D <i>Right track control arm</i></p> <p>3 Sans rotule <i>Without tie rod end</i></p> <p>TT /all models -07/00</p>
<p>7476038 OE 3C0407151G</p> 	<p>Triangle de susp. G/D <i>L/R track control arm</i></p> <p>3 4 Sans rotule <i>Without tie rod end</i></p> <p>1.4 TSi CAVA BVM 09/10- 2.0 TDi CFFB BVM/rob. 09/10-</p>	<p>9005247 OE 7M3407365C</p> 	<p>Rotule de susp. inf. G/D <i>L/R lower suspension ball joint</i></p> <p>1 2</p> <p>TT /all models -05/10</p>
<div style="display: flex; justify-content: space-between;"> <div data-bbox="232 1234 348 1280"> </div> <div data-bbox="232 1292 518 1436"> <p>Support d'amortisseur <i>Suspension mounting</i> <i>Soporte amortiguador</i> <i>Poduszka amortyzatora</i> <i>Опора амортизатора</i></p> </div> <div data-bbox="1053 1175 1384 1482"> </div> </div>			
<p>9005352 OE 1J0412249</p> 	<p>Butée à billes G/D <i>L/R ball bearing</i></p> <p>2</p> <p>TT /all models -05/10</p>	<p>9005363 OE 357412303F</p> 	<p>Butée de suspension G/D <i>L/R suspension bush</i></p> <p>3 H83</p> <p>1.9 TDi -07/00 2.0 -07/00</p>
<p>2656053 OE 6N0413175A</p> 	<p>Protecteur amortisseur G/D <i>L/R shock absorber protector</i></p> <p>4 H206</p> <p>1.4 TSi 09/10- 2.0 TDi 09/10-</p>		

... Alhambra



Eléments SUSPENSION
Suspension parts
Elementos suspensión
Elementy zawieszenie
Элементы подвески

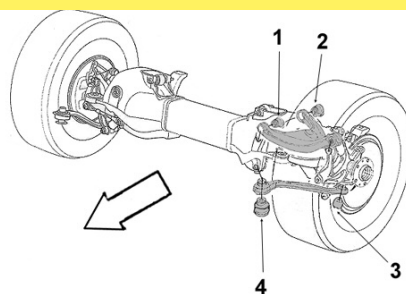

9001436

Articulation AV

OE 7M0501541

Front bush

1 Ø int.14 Ø ext.35 coll.38 x2 long. tube int.60 ext.33 ep. coll.5x2



TT /all models

-05/10

Altea ...

Eléments DIRECTION
Steering parts
Elementos Direcciones
Elementy układ kierowniczy
Элементы рулевой системы

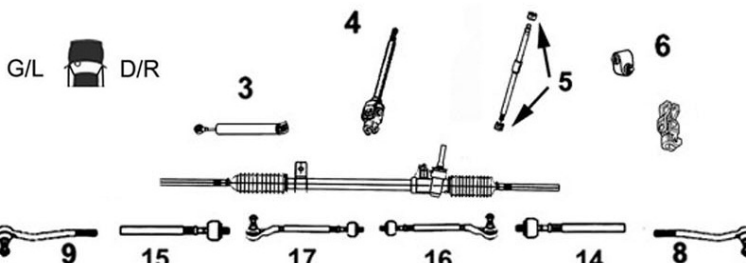

9006873

Axe de bielle G/D

OE 1K0423810A

L/R axial joint

14 Côté dir. M16x1.5 Côté rot. M16x1.5 long 310 mm
15



1.2 TSi
 1.4 /TFSi TSi
 1.6i
 1.6 TDi
 1.8 TFSi
 1.9 TDi
 2.0 FSi BVM / Tiptronic
 2.0 TFSi
 2.0 TDi /DPF /4WD

9006638

Rotule de direction G

OE 1K0423811J

Left tie rod end

9 M16 x 1.5



1.2 TSi /XL
 1.4i
 1.4 TFSi /XL
 1.4 TSi XL Freetrack
 1.6i /XL
 1.6 TDi FAP /XL /Freetrack
 1.8 TFSi /XL
 1.9 TDi /FAP /XL
 2.0 FSi BVM / Tiptronic
 2.0 TFSi
 2.0 TFSi XL Freetrack 4WD BVM
 2.0 TDi FAP /XL /Freetrack

9006637

Rotule de direction D

OE 1K0423812J

Right tie rod end

8 M16 x 1.5



1.2 TSi /XL
 1.4i
 1.4 TFSi /XL
 1.4 TSi XL Freetrack
 1.6i /XL
 1.6 TDi FAP /XL /Freetrack
 1.8 TFSi /XL
 1.9 TDi /FAP /XL
 2.0 FSi BVM / Tiptronic
 2.0 TFSi
 2.0 TFSi XL Freetrack 4WD BVM
 2.0 TDi FAP /XL /Freetrack

... Altea ...



Barre stabilisatrice
 Stabilizer bar
 Barra estabilizadora
 Drażek stabilizatora
 стабилизатор поперечной устойчивости

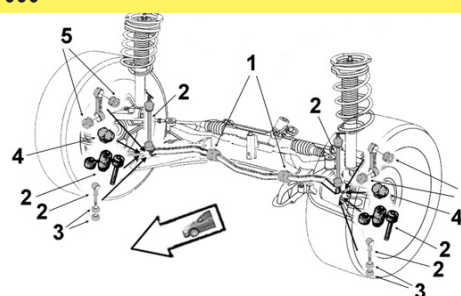

2306010 **Biellette barre stab.**
 OE 1K0411315P *Stabilizer bar stub axle*



2	1.2 TSi 1.4i 1.4 TSi 1.6i 1.6 TDi 1.8 TFSi 1.9 TDi /FAP 2.0 FSi 2.0 TFSi /4WD 2.0 TDi /DPF /4WD	BVM	04/10- 05/06- 11/07- 04/04- 10/09- 01/07- 04/04- 05/04-06/07 04/06- 04/04-
----------	--	-----	---



Eléments SUSPENSION
 Suspension parts
 Elementos suspensión
 Elementy zawieszenie
 Элементы подвески

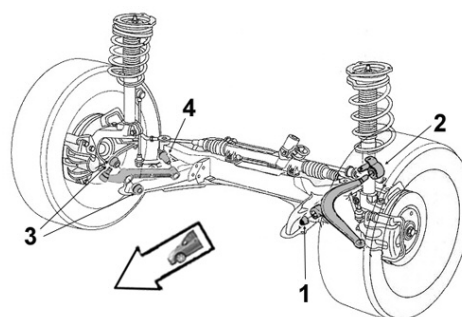

2256003 **Articulation AR G**
 OE 1K0199231J *Left rear bush*



2	1.4 TFSi 1.6i 1.8 TFSi 1.9 TDi /FAP -ch 5P4000500 2.0 FSi -ch 5P4000500 2.0 TFSi /4WD 2.0 TDi /DPF /4WD -ch 5P4000500	11/07- 04/04-05/09 01/07- 04/04- 05/04-06/07 04/06- 04/04-05/09
----------	---	---

2256002 **Articulation AR D**
 OE 1K0199232J *Right rear bush*



2	1.4 TFSi 1.6i 1.8 TFSi 1.9 TDi /FAP -ch 5P4000500 2.0 FSi -ch 5P4000500 2.0 TFSi /4WD 2.0 TDi /DPF /4WD -ch 5P4000500	11/07- 04/04-05/09 01/07- 04/04- 05/04-06/07 04/06- 04/04-05/09
----------	---	---

9001759 **Articulation AV**
 OE 1K0407182 *Front bush*



1	Ø int.12 Ø ext.40 coll.48 long. tube int.54 ext.33 ep. coll.6	
	1.2 TSi 1.4i 1.4 TFSi 1.4 TSi 1.6i 1.6 TDi 1.8 TFSi 1.9 TDi /FAP 2.0 FSi 2.0 TFSi /4WD 2.0 TDi /DPF /4WD	04/10- 05/06- 11/07- 11/07- 04/04- 10/09- 01/07- 04/04- 05/04-06/07 04/06- 04/04-

... Altea ...

SASIC

SEAT

Bras & Triangle de suspension

Control arm
Brazo y triángulo
Wahacz
Рычаг подвески

G/L  D/R



... Altea ...



Support d'amortisseur
Suspension mounting
Soporte amortiguador
Poduszka amortyzatora
Опора амортизатора

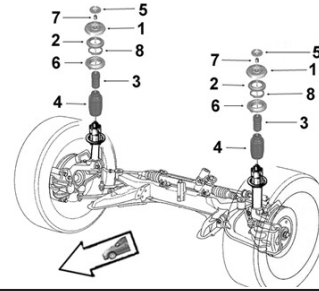

SEAT



9005622 OE 1K0412331B	Support suspension G/D <i>L/R suspension mounting</i>	2656052 OE 1K0412303B	Butée de suspension <i>Shock bush</i>
	1 1.2 TSi 1.4 /TFSi/TSi 1.6 04/04- 1.6 TDi 10/09- 1.8 TFSi 1.9 TDi /FAP 04/04- 2.0 FSi 05/04-06/07 2.0 TFSi 10/06-05/09 2.0 TDi /DPF /4WD 04/04-		3 H70 1.2 TSi 06/10- 1.4i 05/09- 1.4 TFSi 11/07- 1.4 TSi 01/10- 1.6i 04/04- 1.6 TDi 10/09- 1.8 TFSi 12/06- 1.9 TDi 04/04- 2.0 FSi 05/04- 2.0 TFSi 10/06-06/09 2.0 TDi 04/04-
2656004 OE 1K0412303E	Butée de suspension <i>Shock bush</i>	9005334 OE 1K0412303F	Butée de suspension <i>Shock bush</i>
	3 H55 1.6i BVM 04/04-		3 H55 1.9 TDi 04/04-05/09 2.0 FSi 05/04-06/07 2.0 TDi 04/04-05/09
2656053 OE 6N0413175A			
Protecteur amortisseur G/D <i>L/R shock absorber protector</i>			
	4 H206 1.2 TSi 06/10- 1.4i 05/09- 1.4 TFSi 11/07- 1.4 TSi 01/10- 1.6i 04/04- 1.6 TDi 10/09- 1.8 TFSi 12/06- 1.9 TDi 04/04- 2.0 FSi 05/04-06/07 2.0 TFSi 10/06-06/09 2.0 TDi 06/04-		
	Barre stabilisatrice <i>Stabilizer bar</i> <i>Barra estabilizadora</i> <i>Drażek stabilizatora</i> <i>стабилизатор поперечной устойчивости</i>		
9005094 OE 1K0505465K	Biellette barre stab. <i>Stabilizer bar stub axle</i>	2306013 OE 1K0511327AQ	Palier de barre milieu <i>Middle bar main bearing</i>
	2 1.2 TSi 04/10- 1.4i 05/06- 1.4 TFSi TSi 11/07- 1.6 04/04- 1.6 TDi 10/09- 1.8 TFSi 01/07- 1.9 TDi /FAP 04/04- 2.0 FSi 05/04-06/07 2.0 TFSi /4WD 04/06- 2.0 TDi /DPF /4WD 04/04-		1 Barre Ø 19.6 1.6i BVM 04/04- 1.9 TDi /FAP BVM 04/04- 2.0 FSi 05/04-06/07 2.0 TDi /DPF /4WD 04/04-

... Altea

Eléments TRAIN ARRIERE

Rear axle parts

Tren TRAS

Elementy zawieszenia tylnego

элементы задней оси.



SASIC

SEAT

9001786 Articulation essieu G/D inf.

OE 1K0505553A Lower L/R axle bush



Ø int. 12 Ø ext. 37 long. tube int. 50 ext. 28

1.2 TSi	04/10-
1.4i	05/06-
1.4 TFSi	11/07-
1.4 TSi	11/07-
1.6i	04/04-
1.6 TDi	10/09-
1.8 TFSi	01/07-
1.9 TDi /FAP	04/04-
2.0 FSi	05/04-06/07
2.0 TFSi /4WD	04/04-
2.0 TDi /DPF /4WD	04/04-

Arosa ...

Eléments DIRECTION

Steering parts

Elementos Direcciones

Elementy układ kierowniczy

Элементы рулевой системы

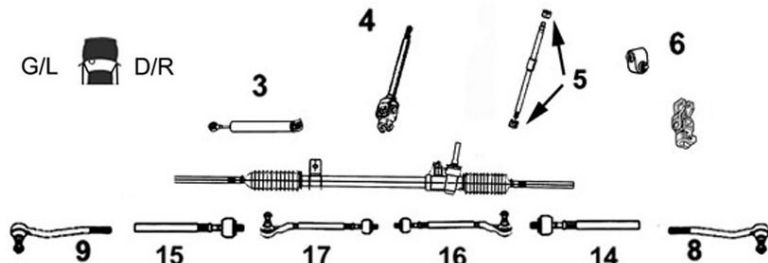

9006234 Axe de bielle G/D

Part/oe 6N0419804 L/R axial joint



14	Côté dir. M22x1.5
15	Côté rot. M14x1.5 long 320 mm
TT /all models DNA	
-ch 6HW055365	

9006235 Axe de bielle G/D

Part/oe 6N0422821A L/R axial joint



14	Côté dir. M14x1.5
15	Côté rot. M14x1.5 long 311 mm
TT /all models DA	
-ch 6HW055365	

9006250 Axe de bielle G/D

Part/oe 6X0419804A L/R axial joint



14	Côté dir. M22x1.5
15	Côté rot. M14x1.5 long 330 mm
TT /all models DNA	
Ch- 6HW055366 02/98-	

9006251 Axe de bielle G/D

Part/oe 6Q0423803E L/R axial joint



14	Côté dir. M14x1.5
15	Côté rot. M14x1.5 long 295 mm
TT /all models DA	
Ch- 6HW055366 02/98-	

9006869 Axe de bielle G/D

Part/oe 6N0422804C L/R axial joint







14	Côté dir. M14x1.5	Côté rot. M14x1.5 long 292 mm	
15			
1.4i 16v.			DA
1.4 TDi			DA
			11/00-04/04
			11/00-06/05

... Arosa ...

SEAT

SASIC

9006619 OE 6N0419811	Rotule de direction G <i>Left tie rod end</i>	9006618 OE 6N0419812	Rotule de direction D <i>Right tie rod end</i>
	9 M14 x 1.5 TT /all models -ch 6HW055365		8 M14 x 1.5 TT /all models -ch 6HW055365
9006628 OE 6X0422811	Rotule de direction G <i>Left tie rod end</i>	9006629 OE 6X0422812	Rotule de direction D <i>Right tie rod end</i>
	9 M14 x 1.5 TT /all models Ch- 6HW055366 02/98-		8 M14 x 1.5 TT /all models Ch- 6HW055366 02/98-



Barre stabilisatrice
Stabilizer bar
Barra estabilizadora
Drażek stabilizatora
стабилизатор поперечной устойчивости

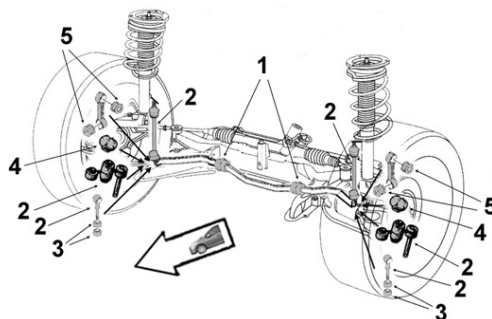



9005080 OE 6N0411315C	Biellette barre stab. <i>Stabilizer bar stub axle</i>
	2 Ø 18 Axe fileté M 8 x 1.25 1.0 1.4 1.7 SDi

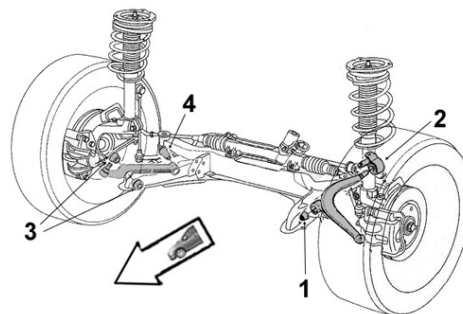

Eléments SUSPENSION
Suspension parts
Elementos suspensión
Elementy zawieszenie
Элементы подвески



2256008 OE 6N0407182	Articulation AV <i>Front bush</i>	9001692 OE 6N0407181	Articulation AR <i>Rear bush</i>
	1 Ø int. 10 Ø ext. 28 Coll. 34 long. tube int. 47 ext. 25 1.0 05/97-06/04 1.4i 05/97-06/04 1.4i 16v. 01/00-06/04 1.4 TDi 01/00-06/04 1.7 SDi		2 Ø int.17 Ø ext.59.5 long. tube int.46 ext.23.5 1.0 1.4 1.4 TDi 1.7 SDi

... Arosa ...

SASIC

SEAT

Bras & Triangle de suspension

Control arm
Brazo y triángulo
Wahacz
Рычаг подвески

G/L  D/R

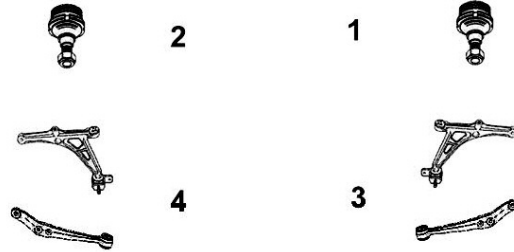

9005138

Triangle de susp. G/D

OE 6X0407151A

L/R track control arm



3 **Sans rotule** Without tie rod end

4

TT /all models

7476121

Triangle de susp. G

OE 6N0407151B+6N0407365 Left track control arm



NEW

4 **Avec rotule** With ball joint

TT /all models

7476120

Triangle de susp. D

OE 6N0407151B+6N0407365A Right track control arm



NEW

3 **Avec rotule** With ball joint

TT /all models

9005270

Rotule de susp. inf. G

OE 6N0407365 Left lower suspension ball joint



2 **Axe Ø 15**

TT /all models

9005269

Rotule de susp. inf. D

OE 6N0407365A Right lower suspension ball joint



1 **Axe Ø 15**

TT /all models



Support d'amortisseur

Suspension mounting
Soporte amortiguador
Poduszka amortyzatora
Опора амортизатора

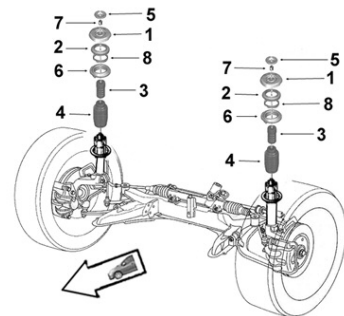

9005616

Support suspension G/D

OE 6N0412331A

L/R suspension mounting



1

1.0
1.4
1.4 TDi
1.7 SDi
1.9 TDi

01/03-

9005352

Butée à billes G/D

OE 1J0412249



L/R ball bearing









2

1.0
1.4
1.4 TDi
1.7 SDi

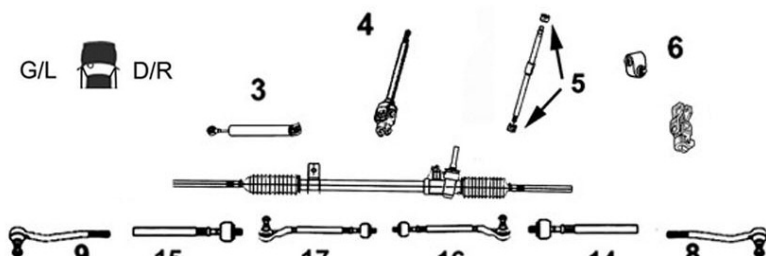
... Arosa

<p>9005327 Protecteur amortisseur G/D OE 357413175A <i>L/R shock absorber protector</i></p>  <p>4 H221.5</p> <p>1.0 1.4 1.7 SDi</p>	<p>9005338 Butée de suspension OE 1H0412303B <i>Shock bush</i></p>  <p>3 H64</p> <p>1.0 07/97- 1.4 07/97- 1.4 TDi 04/00- 1.7 SDi 10/98-</p>
<p>Eléments TRAIN ARRIERE <i>Rear axle parts</i> Tren TRAS Elementy zawieszenia tylnego элементы задней оси.</p> 	<p>9001703 Articulation essieu AR OE 6N0501541D <i>Rear axle bush</i></p>  <p>Ø int.10 Ø ext.58 coll.66 long. tube int.58 ext.41 ep. coll.9</p> <p>1.0 1.4 1.4i 16v. 1.4 TDi 1.7 SDi</p>

Cordoba ...

<p>Eléments DIRECTION <i>Steering parts</i> Elementos Direcciones Elementy uklad kierowniczy Элементы рулевой системы</p>	
<p>9006218 Axe de bielle G/D Part/oe 1H0422803A <i>L/R axial joint</i></p>  <p>14 Côté dir. M14x1.5 15 Côté rot. M14x1.5 long 371 mm</p> <p>TT /all models DA 01/93-12/98</p>	<p>9006210 Axe de bielle G/D Part/oe 191419803 <i>L/R axial joint</i></p>  <p>14 Côté dir. M22x1.5 15 Côté rot. M14x1.5 long 368 mm</p> <p>TT /all models DNA 01/93-10/02</p>
<p>9006872 Axe de bielle G/D Part/oe 6K0422821E <i>L/R axial joint</i></p>  <p>14 Côté dir. M14x1.5 15 Côté rot. M14x1.5 long 318 mm</p> <p>1.0 01/99-01/02 1.4 /16v. 01/99-01/02 1.6 01/99-01/02 1.8 Turbo 20v. 01/99-01/02 1.9 SDi 01/99-01/02 1.9 TDi 01/99-01/02</p>	<p>9006251 Axe de bielle G/D Part/oe 6Q0423803B <i>L/R axial joint</i></p>  <p>14 Côté dir. M14x1.5 15 Côté rot. M14x1.5 long 295 mm Dir. TRW</p> <p>1.4i 16v. 02/02- 1.4 TDi 02/02- 1.9 SDi 02/02- 1.9 TDi 02/02-</p>
<p>9006874 Axe de bielle G/D OE 6Q0423810C <i>L/R axial joint</i></p>  <p>14 Côté dir. M16x1.5 Côté rot. M14x1.5 long 299 mm 15 Dir. SMI Koyo</p> <p>1.4i 16v. 02/02- 1.4 TDi 02/02- 1.9 SDi 02/02- 1.9 TDi 02/02-</p>	

SEAT



... Cordoba ...

Eléments DIRECTION

Steering parts

Elementos Direcciones

Elementy układ kierowniczy

Элементы рулевой системы

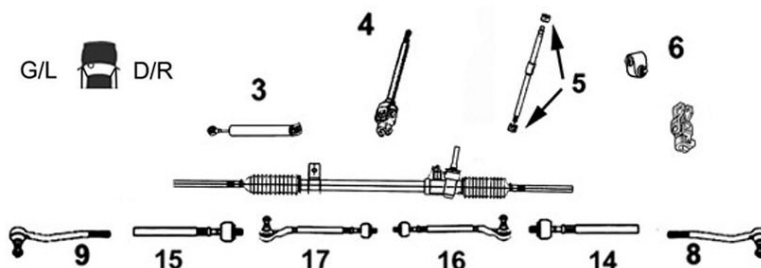

9006380

Rotule de direction G

OE 3A0422811

Left tie rod end



9

M14 x 1.5

TT /all models DNA DA 01/93-12/98
1.0 01/99-01/02
1.4 /16v. 01/99-01/02
1.6 01/99-01/02
1.8 Turbo 20v. 01/99-01/02
1.9 SDi 01/99-01/02
1.9 TDi 01/99-01/02

9006381

Rotule de direction D

OE 191419812

Right tie rod end



8

M14 x 1.5

TT /all models DNA DA 01/93-12/98
1.0 01/99-01/02
1.4 /16v. 01/99-01/02
1.6 01/99-01/02
1.8 Turbo 20v. 01/99-01/02
1.9 SDi 01/99-01/02
1.9 TDi 01/99-01/02

9006634

Rotule de direction G

OE 6Q0423811

Left tie rod end



9

M14 x 1.5

Dir. SMI Koyo TRW

1.4i /16v. 02/02-
1.4 TDi 02/02-
1.9 SDi 02/02-
1.9 TDi 02/02-

9006635

Rotule de direction D

OE 6Q0423812

Right tie rod end



8

M14 x 1.5

Dir. SMI Koyo TRW

1.4i /16v. 02/02-
1.4 TDi 02/02-
1.9 SDi 02/02-
1.9 TDi 02/02-



Barre stabilisatrice

Stabilizer bar

Barra estabilizadora

Drażek stabilizatora

стабилизатор поперечной устойчивости

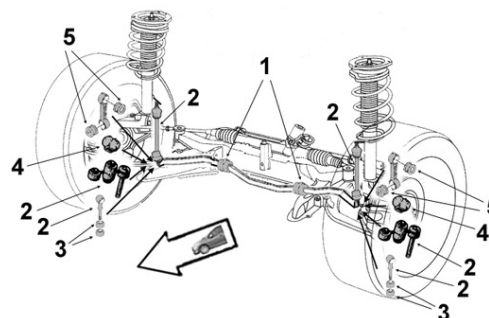

9005089

Biellette barre stab.

OE 6Q0411315N

Stabilizer bar stub axle



2

1.4i 16v.
1.4 TDi
1.9 SDi

01/03-
01/03-
01/03-

9001522

Palier de barre milieu

OE 191411314

Middle bar main bearing



1

Barre Ø 17 -ch 6KV143400

1.4
1.6
1.9 D
1.9 SDi
1.9 TD
1.9 TDi
2.0
2.0i 16v.

9001760

Palier de barre milieu

OE 1H0411314

Middle bar main bearing



1

Barre Ø 20 Ch- 6KV143401

1.4
1.6
1.8
1.9 D
1.9 TD
1.9 TDi
2.0
2.0i 16v.

... Cordoba ...



Eléments SUSPENSION

Suspension parts

Elementos suspensión

Elementy zawieszenie

Элементы подвески

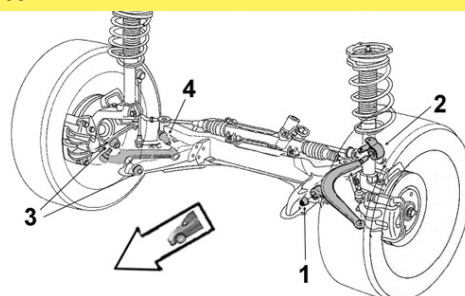

SEAT



2256038

Articulation AV

OE 6Q0407182A

Front bush



1	Ø int.12 Ø ext.33 coll.39 long. tube int. 54 ext.30	-Ch 6L8157034	
	1.2i	BVM	05/06-
	1.2i 12v.	BVM	10/02-
	1.4i	BVM	05/06-
	1.4i 16v.		10/02-
	1.4 TDi	BVM	06/03-
	1.6i	BVM	10/06-
	1.9 SDi	BVM	10/02-10/05
	1.9 TDi	BVM	10/02-03/06
	2.0i	BVM	06/03-

9001523

Articulation AV

OE 357407182

Front bush



1	Ø int.12 Ø ext.33 coll.36 long. tube int.54 ext.29 ep. coll.5	
	1.4	01/93-12/98
	1.4i 16v.	01/01-10/02
	1.6	01/93-12/98
	1.6	01/01-10/02
	1.8 /16v.	01/93-12/98
	1.9 D	01/93-12/98
	1.9 TDi	01/93-12/98
	1.9 TDi	01/01-10/02
	2.0/i 16v.	01/93-12/98

9001520

Articulation AR

OE 191407181E

Rear bush



2	Ø int.17 Ø ext.60.5 long. tube int.41 ext.24.5	
	1.4	01/93-12/98
	1.6	01/93-12/98
	1.8	01/93-12/98
	1.8i 16v.	01/93-12/98
	1.9 D	01/93-12/98
	1.9 TDi	01/93-12/98
	2.0	01/93-12/98

2256001

Articulation AR

OE 6Q0407183A

Rear bush



2	Ø int.18.5 Ø ext.64 coll.71.5 long. tube int.35 ext.46	
	1.4i 16v.	01/03-
	1.4 TDi	01/03-
	1.9 SDi	01/03-
	1.9 TDi	01/03-

Bras & Triangle de suspension

Control arm
Brazo y triángulo
Wahacz
Рычаг подвески

G/L D/R

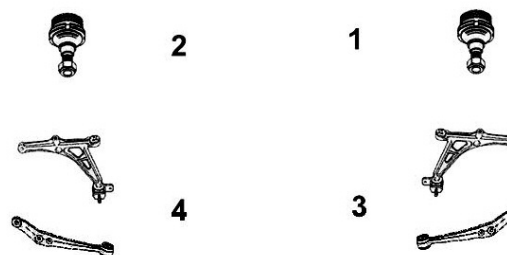

9005133

Triangle de susp. G/D

OE 191407151B

L/R track control arm



3	Sans rotule Without tie rod end	
4		
	TT /all models	01/93-12/98
	1.0	01/99-01/02
	1.4 /16v.	01/99-01/02
	1.6	01/99-01/02
	1.8 Turbo 20v.	01/99-01/02
	1.9 SDi	01/99-01/02
	1.9 TDi	01/99-01/02

9005758

Triangle de susp. inf. G/D

OE 6Q0407151L

Lower L/R track control arm



3	Sans rotule Without tie rod end	
4		
	1.4i 16v.	02/02-02/03/08
	1.4 TDi	02/02-02/03/08
	1.9 SDi	02/02-02/03/08
	1.9 TDi	02/02-02/03/08

... Cordoba ...

SASIC

SEAT

Bras & Triangle de suspension

Control arm
Brazo y triángulo
Wahacz
Рычаг подвески

G/L  D/R



7476107 Triangle de susp. G
OE 191407151B+357407365 Left track control arm

NEW



4 Avec rotule With ball joint Ø 19
TT /all models 01/93-12/98
1.0 01/99-01/02
1.4 01/99-01/02
1.4i 16v. 01/99-01/02
1.6 01/99-01/02
1.8 Turbo 20v. 01/99-01/02
1.9 SDi 01/99-01/02
1.9 TDi 01/99-01/02

7476108 Triangle de susp. D
OE 191407151B+357407365 Right track control arm

NEW



3 Avec rotule With ball joint Ø 19
TT /all models 01/93-12/98
1.0 01/99-01/02
1.4 01/99-01/02
1.4i 16v. 01/99-01/02
1.6 01/99-01/02
1.8 Turbo 20v. 01/99-01/02
1.9 SDi 01/99-01/02
1.9 TDi 01/99-01/02

7476123 Triangle de susp. G
OE 6Q0407151L+6Q0407365M Left track control arm

NEW



4 Avec rotule With ball joint
1.4i 16v. 02/02-
1.4 TDi 02/02-
1.9 SDi 02/02-
1.9 TDi 02/02-

7476122 Triangle de susp. D
OE 6Q0407151L+6Q0407366M Right track control arm

NEW



3 Avec rotule With ball joint
1.4i 16v. 02/02-
1.4 TDi 02/02-
1.9 SDi 02/02-
1.9 TDi 02/02-

9005260 Rotule de susp. inf. G/D
OE 357407365 L/R lower suspension ball joint



1 Ø 19 Cylindrique
TT /all models 01/93-12/98
1.0 01/99-01/02
1.4 /16v. 01/99-01/02
1.6 01/99-01/02
1.8 Turbo 20v. 01/99-01/02
1.9 SDi 01/99-01/02
1.9 TDi 01/99-01/02

9005478 Rotule de susp. inf. G
OE 6Q0407365M Left lower suspension ball joint



2 -ch 6L-8-185000
1.4i 16v. 02/02-
1.4 TDi 02/02-
1.9 SDi 02/02-
1.9 TDi 02/02-

9005479 Rotule de susp. inf. D
OE 6Q0407366M Right lower suspension ball joint



1 -ch 6L-8-185000
1.4i 16v. 02/02-
1.4 TDi 02/02-
1.9 SDi 02/02-
1.9 TDi 02/02-

9155490 Kit rép. train AV
OE - Front axle repair kit



Sans visserie Without screws and bolts
Barre Ø 17

TT /all models 01/93-12/98

... Cordoba ...



Support d'amortisseur
Suspension mounting
Soporte amortiguador
Poduszka amortyzatora
Опора амортизатора

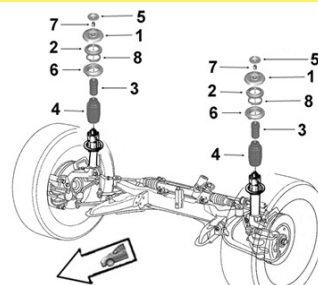

SEAT



<p>9005604 OE 191412329</p>	<p>Support suspension AV G/D <i>L/R front susp. mounting</i></p> <p>1 Avec roulement <i>With bearing</i></p> <table border="0"> <tr><td>1.4</td><td>03/93-10/95</td></tr> <tr><td>1.6</td><td>03/93-10/95</td></tr> <tr><td>1.8</td><td>03/93-10/95</td></tr> <tr><td>1.8i 16v.</td><td>03/93-10/95</td></tr> <tr><td>1.9 D</td><td>03/93-10/95</td></tr> <tr><td>2.0</td><td>03/93-10/95</td></tr> </table>	1.4	03/93-10/95	1.6	03/93-10/95	1.8	03/93-10/95	1.8i 16v.	03/93-10/95	1.9 D	03/93-10/95	2.0	03/93-10/95	<p>9005623 OE 6N0412331E</p>	<p>Support suspension G/D <i>L/R suspension mounting</i></p> <p>1</p> <table border="0"> <tr><td>1.4i 16v.</td><td>03/02-</td></tr> <tr><td>1.4 TDi</td><td>01/03-</td></tr> <tr><td>1.9 SDi</td><td>01/03-</td></tr> <tr><td>1.9 TDi</td><td>01/03-</td></tr> </table>	1.4i 16v.	03/02-	1.4 TDi	01/03-	1.9 SDi	01/03-	1.9 TDi	01/03-														
1.4	03/93-10/95																																				
1.6	03/93-10/95																																				
1.8	03/93-10/95																																				
1.8i 16v.	03/93-10/95																																				
1.9 D	03/93-10/95																																				
2.0	03/93-10/95																																				
1.4i 16v.	03/02-																																				
1.4 TDi	01/03-																																				
1.9 SDi	01/03-																																				
1.9 TDi	01/03-																																				
<p>9001709 OE 357412331A</p>	<p>Support suspension G/D <i>L/R suspension mounting</i></p> <p>1</p> <table border="0"> <tr><td>1.8</td><td>11/95-06/99</td></tr> <tr><td>1.8i 16v.</td><td>11/95-06/99</td></tr> <tr><td>1.9 D</td><td>11/95-06/99</td></tr> <tr><td>1.9 SDi</td><td>11/95-06/99</td></tr> <tr><td>1.9 TD</td><td>11/95-06/99</td></tr> <tr><td>1.9 TDi</td><td>11/95-06/99</td></tr> <tr><td>2.0</td><td>11/95-06/99</td></tr> <tr><td>2.0i 16v.</td><td>11/95-06/99</td></tr> </table>	1.8	11/95-06/99	1.8i 16v.	11/95-06/99	1.9 D	11/95-06/99	1.9 SDi	11/95-06/99	1.9 TD	11/95-06/99	1.9 TDi	11/95-06/99	2.0	11/95-06/99	2.0i 16v.	11/95-06/99	<p>9005352 OE 1J0412249</p>	<p>Butée à billes G/D <i>L/R ball bearing</i></p> <p>2</p> <table border="0"> <tr><td>1.4</td><td>11/96-09/99</td></tr> <tr><td>1.6</td><td>12/93-09/99</td></tr> <tr><td>1.8</td><td>12/93-10/96</td></tr> <tr><td>1.8i 16v.</td><td>07/94-10/96</td></tr> <tr><td>1.9 SDi</td><td>12/93-09/99</td></tr> <tr><td>1.9 TD</td><td>01/94-10/96</td></tr> <tr><td>1.9 TDi</td><td>11/96-09/99</td></tr> <tr><td>2.0</td><td>03/95-10/96</td></tr> <tr><td>2.0 16v.</td><td>05/96-09/99</td></tr> </table>	1.4	11/96-09/99	1.6	12/93-09/99	1.8	12/93-10/96	1.8i 16v.	07/94-10/96	1.9 SDi	12/93-09/99	1.9 TD	01/94-10/96	1.9 TDi	11/96-09/99	2.0	03/95-10/96	2.0 16v.	05/96-09/99
1.8	11/95-06/99																																				
1.8i 16v.	11/95-06/99																																				
1.9 D	11/95-06/99																																				
1.9 SDi	11/95-06/99																																				
1.9 TD	11/95-06/99																																				
1.9 TDi	11/95-06/99																																				
2.0	11/95-06/99																																				
2.0i 16v.	11/95-06/99																																				
1.4	11/96-09/99																																				
1.6	12/93-09/99																																				
1.8	12/93-10/96																																				
1.8i 16v.	07/94-10/96																																				
1.9 SDi	12/93-09/99																																				
1.9 TD	01/94-10/96																																				
1.9 TDi	11/96-09/99																																				
2.0	03/95-10/96																																				
2.0 16v.	05/96-09/99																																				
<p>2656048 OE 6Q0412301A</p>	<p>Butée de suspension <i>Shock bush</i></p> <p>3 H56</p> <table border="0"> <tr><td>1.4i /16v.</td><td>10/02-05/09</td></tr> <tr><td>1.4 TDi</td><td>06/03-05/09</td></tr> <tr><td>1.9 SDi</td><td>10/02-03/06</td></tr> <tr><td>1.9 TDi</td><td>10/02-05/09</td></tr> </table>	1.4i /16v.	10/02-05/09	1.4 TDi	06/03-05/09	1.9 SDi	10/02-03/06	1.9 TDi	10/02-05/09	<p>9005362 OE 357412303E</p>	<p>Butée de suspension G/D <i>L/R suspension bush</i></p> <p>3 H84 -ch 6KTR080000</p> <table border="0"> <tr><td>1.4</td><td>12/93-</td></tr> <tr><td>1.6</td><td>12/93-</td></tr> <tr><td>1.8</td><td>12/93-</td></tr> <tr><td>1.8i 16v.</td><td>07/94-</td></tr> <tr><td>1.9 D</td><td>01/94-</td></tr> <tr><td>1.9 SDi</td><td>12/93-</td></tr> <tr><td>1.9 TD</td><td>01/94-</td></tr> <tr><td>2.0</td><td>12/93-</td></tr> </table>	1.4	12/93-	1.6	12/93-	1.8	12/93-	1.8i 16v.	07/94-	1.9 D	01/94-	1.9 SDi	12/93-	1.9 TD	01/94-	2.0	12/93-										
1.4i /16v.	10/02-05/09																																				
1.4 TDi	06/03-05/09																																				
1.9 SDi	10/02-03/06																																				
1.9 TDi	10/02-05/09																																				
1.4	12/93-																																				
1.6	12/93-																																				
1.8	12/93-																																				
1.8i 16v.	07/94-																																				
1.9 D	01/94-																																				
1.9 SDi	12/93-																																				
1.9 TD	01/94-																																				
2.0	12/93-																																				
<p>9005363 OE 357412303F</p>	<p>Butée de suspension G/D <i>L/R suspension bush</i></p> <p>3 H83</p> <table border="0"> <tr><td>1.4</td><td>01/93-12/98</td></tr> <tr><td>1.6</td><td>01/93-12/98</td></tr> <tr><td>1.8</td><td>01/93-12/98</td></tr> <tr><td>1.8i 16v.</td><td>01/93-12/98</td></tr> <tr><td>1.9 D</td><td>01/93-12/98</td></tr> <tr><td>1.9 TDi sauf 115hp 85kw</td><td>01/93-12/98</td></tr> <tr><td>2.0</td><td>01/93-12/98</td></tr> <tr><td>2.0i 16v.</td><td>01/93-12/98</td></tr> </table>	1.4	01/93-12/98	1.6	01/93-12/98	1.8	01/93-12/98	1.8i 16v.	01/93-12/98	1.9 D	01/93-12/98	1.9 TDi sauf 115hp 85kw	01/93-12/98	2.0	01/93-12/98	2.0i 16v.	01/93-12/98	<p>2656002 OE 1H0412303</p>	<p>Butée de suspension <i>Shock bush</i></p> <p>3 H103</p> <table border="0"> <tr><td>1.9 TDi</td><td>12/97-09/99</td></tr> </table>	1.9 TDi	12/97-09/99																
1.4	01/93-12/98																																				
1.6	01/93-12/98																																				
1.8	01/93-12/98																																				
1.8i 16v.	01/93-12/98																																				
1.9 D	01/93-12/98																																				
1.9 TDi sauf 115hp 85kw	01/93-12/98																																				
2.0	01/93-12/98																																				
2.0i 16v.	01/93-12/98																																				
1.9 TDi	12/97-09/99																																				
<p>9005369 OE 1H0413175</p>	<p>Protecteur amortisseur G/D <i>L/R shock absorber protector</i></p> <p>4</p> <table border="0"> <tr><td>1.4</td><td>01/93-12/98</td></tr> <tr><td>1.6</td><td>01/93-12/98</td></tr> <tr><td>1.8</td><td>01/93-12/98</td></tr> <tr><td>1.8i 16v.</td><td>01/93-12/98</td></tr> <tr><td>1.9 D</td><td>01/93-12/98</td></tr> <tr><td>1.9 TDi</td><td>01/93-12/98</td></tr> <tr><td>2.0</td><td>01/93-12/98</td></tr> <tr><td>2.0i 16v.</td><td>01/93-12/98</td></tr> </table>	1.4	01/93-12/98	1.6	01/93-12/98	1.8	01/93-12/98	1.8i 16v.	01/93-12/98	1.9 D	01/93-12/98	1.9 TDi	01/93-12/98	2.0	01/93-12/98	2.0i 16v.	01/93-12/98	<p>2656053 OE 6N0413175A</p>	<p>Protecteur amortisseur G/D <i>L/R shock absorber protector</i></p> <p>4 H206</p> <table border="0"> <tr><td>1.4i</td><td>05/06-05/09</td></tr> <tr><td>1.4i 16v.</td><td>09/00-10/02</td></tr> <tr><td>1.4 TDi</td><td>05/05-05/09</td></tr> <tr><td>1.8i Turbo</td><td>01/01-10/02</td></tr> <tr><td>1.9 SDi</td><td>09/99-10/02</td></tr> <tr><td>1.9 TDi</td><td>03/06-05/09</td></tr> </table>	1.4i	05/06-05/09	1.4i 16v.	09/00-10/02	1.4 TDi	05/05-05/09	1.8i Turbo	01/01-10/02	1.9 SDi	09/99-10/02	1.9 TDi	03/06-05/09						
1.4	01/93-12/98																																				
1.6	01/93-12/98																																				
1.8	01/93-12/98																																				
1.8i 16v.	01/93-12/98																																				
1.9 D	01/93-12/98																																				
1.9 TDi	01/93-12/98																																				
2.0	01/93-12/98																																				
2.0i 16v.	01/93-12/98																																				
1.4i	05/06-05/09																																				
1.4i 16v.	09/00-10/02																																				
1.4 TDi	05/05-05/09																																				
1.8i Turbo	01/01-10/02																																				
1.9 SDi	09/99-10/02																																				
1.9 TDi	03/06-05/09																																				

... Cordoba ...



Support d'amortisseur
 Suspension mounting
 Soporte amortiguador
 Poduszka amortyzatora
 Опора амортизатора

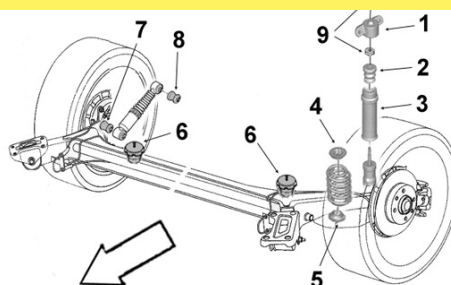

9005630 **Support suspension G/D**
 OE 1J0513353B *L/R suspension mounting*



1		
	1.4i 16v.	01/03-
	1.4 TDi	01/03-
	1.9 SDi	01/03-
	1.9 TDi	01/03-

9005364 **Butée de suspension AR G/D**
 OE 6K0512131A *L/R rear suspension bush*



2	H110	
	1.0	-09/99
	1.4 sauf Vario	-09/99
	1.6 sauf Vario	-09/99
	1.8 /i 16v.	-09/99
	1.9 D	-09/99
	1.9 TDi	-09/99
	2.0	-09/99
	2.0i 16v.	-09/99

Eléments TRAIN ARRIERE
 Rear axle parts
 Tren TRAS
 Elementy zawieszenia tylnego
 элементы задней оси.



9001703 **Articulation essieu AR**
 OE 6N0501541D *Rear axle bush*



**Ø int.10 Ø ext.58 coll.66
 long. tube int.58 ext.41 ep. coll.9**

1.4	01/93-12/98
1.6	01/93-12/98
1.8	01/93-12/98
1.8i 16v.	01/93-12/98
1.9 D	01/93-12/98
1.9 TDi	01/93-12/98
2.0/i 16v.	01/93-12/98

9001750 **Articulation essieu G/D**
 OE 6Q0501541E *L/R axle bush*



**Ø int.12 Ø ext.70 coll.88
 long. tube int.90 ext.64 ep. coll.11**

1.4i 16v.	01/03-
1.4 TDi	01/03-
1.9 SDi	01/03-
1.9 TDi	01/03-

Exeo ...

Eléments DIRECTION
 Steering parts
 Elementos Direcciones
 Elementy układ kierowniczy
 Элементы рулевой системы

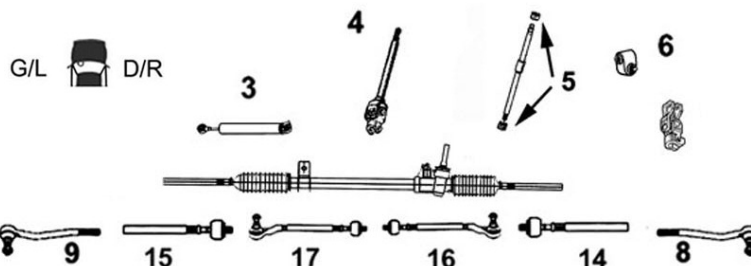

7776081 **Axe de bielle G/D**
 OE 8E0422821C *L/R axial joint*

NEW



14 Côté dir. M16x1.5 Côté rot. M14x1.5 long 128 mm
15

1.6i / Break	02/09-
1.8 TSi / Break	02/09-
1.8 TSi / Break	02/09-
2.0 TFSi TSi / Break	02/09-
2.0 TDi FAP Break	02/09-

... Exeo ...



Barre stabilisatrice
 Stabilizer bar
 Barra estabilizadora
 Drażek stabilizatora
 стабилизатор поперечной устойчивости

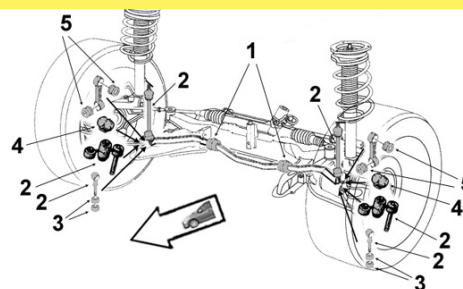

SEAT



9005069 OE 8E0411317	Biellette barre stab. G <i>Left stabilizer bar stub axle</i>	9005068 OE 8E0411318	Biellette barre stab. D <i>Right stabilizer bar stub axle</i>
2	2	2	2
	1.6i /Break 03/09- 1.8i Turbo /Break 12/08- 2.0 TFSi /Break 03/09- 2.0 TDi /Break 12/08-		1.6i /Break 03/09- 1.8i Turbo /Break 12/08- 2.0 TFSi /Break 03/09- 2.0 TDi /Break 12/08-
9001740 OE 4D0411327J			
Palier de barre milieu <i>Middle bar main bearing</i>			
1 Ø29			
	1.6i /Break 03/09- 1.8i Turbo /Break 12/08- 2.0 TFSi /Break 03/09- 2.0 TDi /Break 12/08-		
Bras & Triangle de suspension <i>Control arm</i> <i>Brazo y triángulo</i> <i>Wahacz</i> Рычаг подвески			
G/L D/R		2 	1
		4 	3
7476206 OE 8E0407509P	Bras de suspension Sup. AR G <i>Rear Upper left track control arm</i>	7476207 OE 8E0407510P	Bras de suspension Sup. AR D <i>Rear Upper right track control arm</i>
NEW	4	NEW	3
	Avec rotule With ball joint Ø 16 1.6i / Break 02/09- 1.8 TSi / Break 02/09- 2.0 TFSi / Break 02/09- 2.0 TDi / Break 02/09-		Avec rotule With ball joint Ø 16 1.6i / Break 02/09- 1.8 TSi / Break 02/09- 2.0 TFSi / Break 02/09- 2.0 TDi / Break 02/09-
7476202 OE 8E0407693AL	Bras de susp. AR inf. G <i>Left rear lower track control arm</i>	7476203 OE 8E0407694AL	Bras de susp. AR inf. D <i>Right rear lower track control arm</i>
NEW	4	NEW	3
	Avec rotule With ball joint 1.6i / Break 02/09- 1.8 TSi / Break 02/09- 2.0 TSi /TFSi / Break 02/09- 2.0 TDi /FAP /ST 02/09-		Avec rotule With ball joint 1.6i / Break 02/09- 1.8 TSi / Break 02/09- 2.0 TSi /TFSi / Break 02/09- 2.0 TDi /FAP /ST 02/09-

... Exeo

SASIC

SEAT

Bras & Triangle de suspension

Control arm
Brazo y triángulo
Wahacz
Рычаг подвески

G/L  D/R

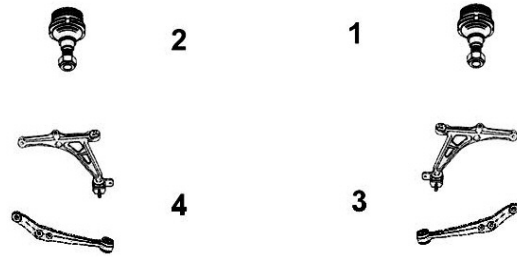

7476019

Bras de susp. AV inf. G/D

OE 8E0407151R

L/R front lower track control arm

3 Avec rotule With ball joint

4



1.6i / Break	03/09-
1.8i Turbo / Break	03/09-
2.0 TFSi / Break	03/09-
2.0 TDi / Break	03/09-



Barre stabilisatrice

Stabilizer bar
Barra estabilizadora
Drażek stabilizatora
стабилизатор поперечной устойчивости

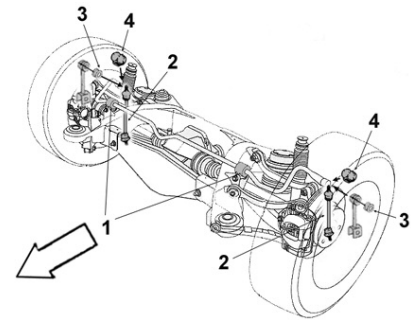

2306012

Biellette barre stab.

OE 8E0505465AF

Stabilizer bar stub axle

2



1.6i /Break	03/09-
1.8i Turbo /Break	12/08-
2.0 TFSi /Break	03/09-
2.0 TDi /Break	12/08-

2306104

Palier de barre

OE 8E0511327A

Bar main bearing

1

Ø 17.5



1.6i /Break	03/09-
1.8 Turbo /Break	03/09-
2.0 TFSi /Break	03/09-
2.0 TDi /Break	03/09-

Eléments TRAIN ARRIERE

Rear axle parts
Tren TRAS
Elementy zawieszenia tylnego
элементы задней оси.



9001776

Articulation porte moyeu

OE 8E0505203D

Hub seat bush

Ø int.12 Ø ext.44 coll.46 coll.51 long. tube int.60 ext.27 ep. coll.5



1.6i /Break	03/09-
1.8i Turbo /Break	12/08-
2.0 TFSi /Break	03/09-
2.0 TDi /Break	12/08-

Ibiza I 84-93 ...

Eléments DIRECTION
Steering parts
Elementos Direcciones
Elementy układ kierowniczy
Элементы рулевой системы

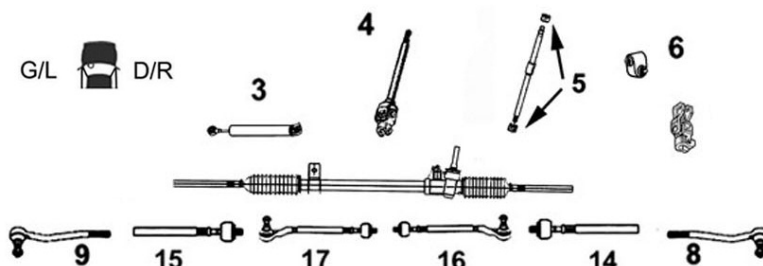

SEAT



9006262 Axe de bielle G/D

OE SE022162449B *L/R axial joint*



14 Côté dir. M14x1.5 Côté rot. M12x1.5 long 275 mm
 15

TT /all models

07/86-04/93

9006333 Rotule de direction G/D

OE SE022162406A *L/R tie rod end*



8 M12 x 1.5
 9

TT /all models

06/84-04/93



Barre stabilisatrice
Stabilizer bar
Barra estabilizadora
Drażek stabilizatora
стабилизатор поперечной устойчивости

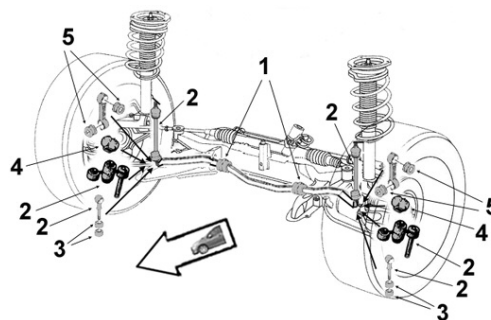

9001575 Liaison élastique AV

OE SE021156228A *Front elastic link*



0.9
 1.2
 1.5
 1.7 D

01/87-12/93
 01/87-12/93
 01/87-12/93
 01/87-12/93

9001528 Palier de barre femelle

OE 132156127A *Female bar main bearing*



1.2 -12/93
 1.5 -12/93
 1.7 D -12/93

9001527 Palier de barre mâle

OE 132156126A *Male bar main bearing*



1.2 -12/93
 1.5 -12/93
 1.7 D -12/93

... Ibiza I 84-93

Bras & Triangle de suspension

Control arm
Brazo y triángulo
Wahacz
Рычаг подвески

G/L  D/R



9005130

Bras de suspension G/D

OE SE021156110A

L/R track control arm

3 Avec rotule With ball joint Axe lisse Ø 15
4



TT /all models 07/86-12/88

9005131

Bras de suspension G/D

OE SE021156110B

L/R track control arm

3 Avec rotule With ball joint Axe lisse Ø 17
4



TT /all models 12/88-04/93

Ibiza II III IV 93-01(6K) ...

Eléments DIRECTION

Steering parts
Elementos Direcciones
Elementy układ kierowniczy
Элементы рулевой системы

G/L  D/R

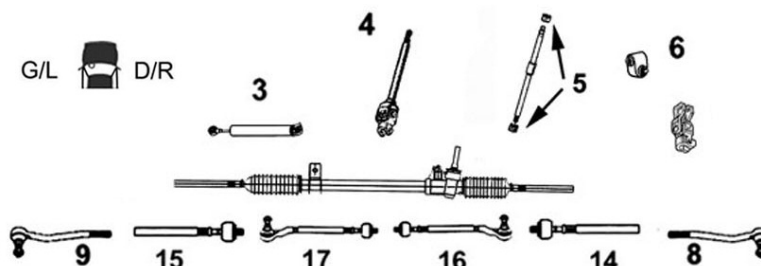

9006210

Axe de bielle G/D

Part/oe 191419803

L/R axial joint

14 Côté dir. M22x1.5
15 Côté rot. M14x1.5 long 368 mm



TT /all models DNA 6K1 05/93-

9006217

Axe de bielle G/D

Part/oe 191422804A

L/R axial joint

14 Côté dir. M14x1.5
15 Côté rot. M14x1.5 long 347 mm



TT /all models DA 6K1 05/93-12/97

9006871

Axe de bielle G/D

Part/oe 6K0422821

L/R axial joint

14 Côté dir. M14x1.5 Côté rot. M14x1.5 long 345 mm
15



TT /all models 6K1 01/97-12/99

9006872

Axe de bielle G/D

Part/oe 6K0422821E

L/R axial joint

14 Côté dir. M14x1.5 Côté rot. M14x1.5 long 318 mm
15



TT /all models	6K1	01/97-12/98
1.0	6K1	01/99-
1.4 /16v.	6K1	01/99-
1.6	6K1	01/99-
1.8 Turbo 20v.	6K1	01/99-
1.9 SDi	6K1	01/99-
1.9 TDi	6K1	01/99-

... Ibiza II III IV 93-01(6K)

Eléments DIRECTION

Steering parts

Elementos Direcciones

Elementy uklad kierowniczy

Элементы рулевой системы

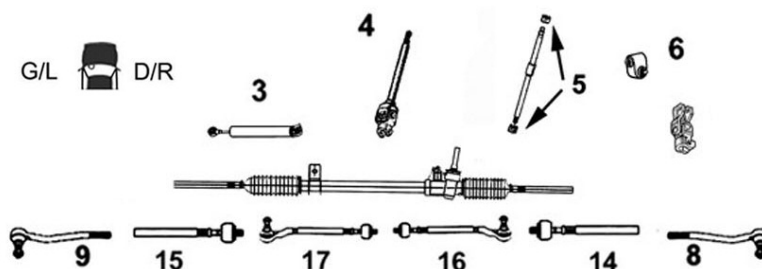

SEAT



9006380

Rotule de direction G

OE 3A0422811

Left tie rod end



9

M14 x 1.5

TT /all models	DNA DA	6K1	05/93-12/99
1.0		6K1	01/99-
1.4 /16v.		6K1	01/99-
1.6		6K1	01/99-
1.8 Turbo 20v.		6K1	01/99-
1.9 SDi		6K1	01/99-
1.9 TDi		6K1	01/99-

9006381

Rotule de direction D

OE 191419812

Right tie rod end



8

M14 x 1.5

TT /all models	DNA DA	6K1	05/93-12/99
1.0		6K1	01/99-
1.4 /16v.		6K1	01/99-
1.6		6K1	01/99-
1.8 Turbo 20v.		6K1	01/99-
1.9 SDi		6K1	01/99-
1.9 TDi		6K1	01/99-



Barre stabilisatrice

Stabilizer bar

Barra estabilizadora

Drażek stabilizatora

стабилизатор поперечной устойчивости

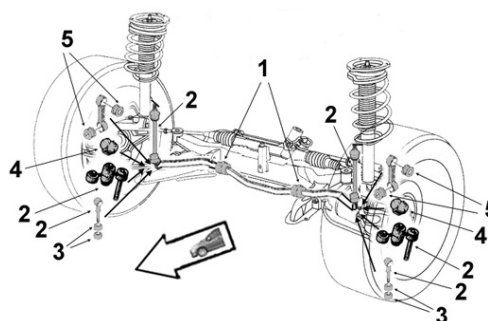

9005050

Biellette barre stab.

OE 191411315B

Stabilizer bar stub axle



2

Ø int.17

1.8	6K1	Ch- 6K-ZR040000 -ch 6KZ-R550000
1.9 D	6K1	07/94-04/96
1.9 TD	6K1	07/94-04/96 Sans ABS
2.0	6K1	07/94-03/99 Sans ABS

9001522

Palier de barre milieu

OE 191411314

Middle bar main bearing



1

Barre Ø 17

1.0	6K1	01/93-
1.3	6K1	01/93-12/98
1.4	6K1	01/93-
1.6	6K1	
	-ch 6KV143400	01/93-
1.8	6K1	01/93-12/98
1.8i 16v.	6K1	01/93-12/98
1.9 D	6K1	
	-ch 6KV143400	01/93-12/99
1.9 TD TDi	6K1	
	-ch 6KV143400	01/93-12/99
2.0	6K1	
	-ch 6KV143400	01/93-12/99
2.0i 16v.	6K1	
	-ch 6KV143400	01/93-12/99

9001760

Palier de barre milieu

OE 1H0411314

Middle bar main bearing



1

Barre Ø 20

1.0	6K1	Ch- KX430580
		-02/02
1.4i /16v.	6K1	07/98-02/02
1.6	6K1	07/98-
1.8i 20v. Turbo	6K1	10/99-02/02
1.9 D	6K1	07/98-09/99
1.9 SDi	6K1	07/98-02/02
1.9 TD	6K1	07/98-09/99
1.9 TDi	6K1	07/98-02/02
2.0	6K1	07/98-09/99
2.0i 16v.	6K1	07/98-09/99

... Ibiza II III IV 93-01(6K) ...



Eléments SUSPENSION

Suspension parts

Elementos suspensión

Elementy zawieszenia

Элементы подвески

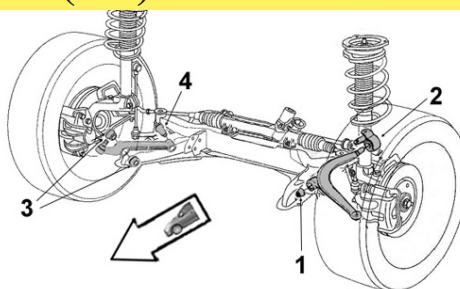

SEAT

9001523

Articulation AV

OE 357407182

Front bush



1	Ø int.12 Ø ext.33 coll.36 long. tube int.54 ext.29 ep. coll.5
1.0	6K1 01/93-
1.3	6K1 01/93-09/99
1.4 /16v.	6K1 01/93-
1.6	6K1 01/93-
1.8i /16v.	6K1 01/93-09/99
1.8i 20v. Turbo	6K1 10/99-
1.9 D	6K1 01/93-09/99
1.9 SDi	6K1 01/93-
1.9 TD	6K1 01/93-09/99
1.9 TDi	6K1 01/93-
2.0i /16v.	6K1 01/93-09/99

9001520

Articulation AR

OE 191407181D

Rear bush



2	Ø int.17 Ø ext.60.5 long. tube int.41 ext.24.5
1.0	6K1 01/93-
1.3	6K1 01/93-09/99
1.4 /16v.	6K1 01/93-
1.6	6K1 01/93-
1.8i /16v.	6K1 01/93-09/99
1.8i 20v. Turbo	6K1 10/99-
1.9 D	6K1 01/93-09/99
1.9 SDi	6K1 01/93-
1.9 TD	6K1 01/93-09/99
1.9 TDi	6K1 01/93-
2.0i /16v.	6K1 01/93-09/99

Bras & Triangle de suspension

Control arm

Brazo y triángulo

Wahacz

Рычаг подвески

G/L D/R

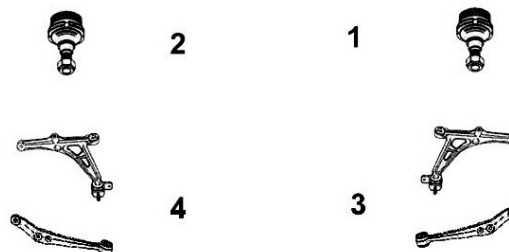

9005133

Triangle de susp. G/D

OE 191407151B

L/R track control arm



3	Sans rotule Without tie rod end
4	
TT /all models	6K1 05/93-12/99
1.0i	6K1 01/99-
1.4 /16v.	6K1 01/99-
1.6	6K1 03/93-
1.8 Turbo 20v.	6K1 01/99-
1.9 SDi	6K1 01/99-
1.9 TDi	6K1 01/99-

7476107

Triangle de susp. G

OE 191407151B+357407365 *Left track control arm*



4	Avec rotule With ball joint Ø 19
TT /all models	6K1 05/93-12/99
1.0i	6K1 01/99-
1.4 /16v.	6K1 01/99-
1.6	6K1 01/99-
1.8 Turbo 20v.	6K1 01/99-
1.9 SDi	6K1 01/99-
1.9 TDi	6K1 01/99-

7476108

Triangle de susp. D

OE 191407151B+357407365 *Right track control arm*



3	Avec rotule With ball joint Ø 19
TT /all models	6K1 05/93-12/99
1.0i	6K1 01/99-
1.4 /16v.	6K1 01/99-
1.6	6K1 01/99-
1.8 Turbo 20v.	6K1 01/99-
1.9 SDi	6K1 01/99-
1.9 TDi	6K1 01/99-

9005260

Rotule de susp. inf. G/D

OE 357407365

L/R lower suspension ball joint



1	Ø 19 Cylindrique
2	
TT /all models	6K1 05/93-12/99
1.0i	6K1 01/99-
1.4 /16v.	6K1 01/99-
1.6	6K1 01/99-
1.8 Turbo 20v.	6K1 01/99-
1.9 SDi	6K1 01/99-
1.9 TDi	6K1 01/99-

9155490

Kit rép. train AV

OE -

Front axle repair kit



**Sans visserie Without screws and bolts
Barre Ø 17**

TT /all models 6K1 05/93-12/99

... Ibiza II III IV 93-01(6K) ...





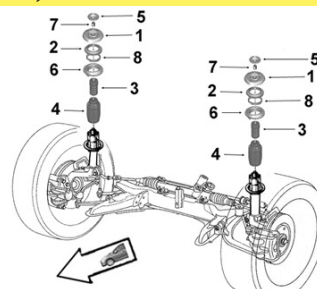





Support d'amortisseur
Suspension mounting
Soporte amortiguador
Poduszka amortyzatora
Опора амортизатора



SEAT



<p>9005604 OE 191412329</p> 	<p>Support suspension AV G/D <i>L/R front susp. mounting</i></p> <p>1 Avec roulement With bearing</p> <table border="1"> <tr><td>1.0</td><td>6K1</td><td>01/93-12/98</td></tr> <tr><td>1.3</td><td>6K1</td><td>01/93-12/98</td></tr> <tr><td>1.4</td><td>6K1</td><td>01/93-12/98</td></tr> <tr><td>1.6</td><td>6K1</td><td>01/93-12/98</td></tr> <tr><td>1.8</td><td>6K1</td><td>01/93-12/98</td></tr> <tr><td>1.9 D</td><td>6K1</td><td>01/93-12/98</td></tr> <tr><td>1.9 TD</td><td>6K1</td><td>01/93-12/98</td></tr> <tr><td>2.0</td><td>6K1</td><td>01/93-12/98</td></tr> </table>	1.0	6K1	01/93-12/98	1.3	6K1	01/93-12/98	1.4	6K1	01/93-12/98	1.6	6K1	01/93-12/98	1.8	6K1	01/93-12/98	1.9 D	6K1	01/93-12/98	1.9 TD	6K1	01/93-12/98	2.0	6K1	01/93-12/98	<p>9005623 OE 6N0412331E</p> 	<p>Support suspension G/D <i>L/R suspension mounting</i></p> <p>1</p> <table border="1"> <tr><td>1.0</td><td>6K1</td><td>10/99-02/02</td></tr> <tr><td>1.4</td><td>6K1</td><td>10/99-02/02</td></tr> <tr><td>1.6</td><td>6K1</td><td>10/99-02/02</td></tr> <tr><td>1.8i 20v. Turbo</td><td>6K1</td><td>10/99-02/02</td></tr> <tr><td>1.9 SDi</td><td>6K1</td><td>10/99-02/02</td></tr> <tr><td>1.9 TDi</td><td>6K1</td><td>10/99-02/02</td></tr> </table>	1.0	6K1	10/99-02/02	1.4	6K1	10/99-02/02	1.6	6K1	10/99-02/02	1.8i 20v. Turbo	6K1	10/99-02/02	1.9 SDi	6K1	10/99-02/02	1.9 TDi	6K1	10/99-02/02			
1.0	6K1	01/93-12/98																																														
1.3	6K1	01/93-12/98																																														
1.4	6K1	01/93-12/98																																														
1.6	6K1	01/93-12/98																																														
1.8	6K1	01/93-12/98																																														
1.9 D	6K1	01/93-12/98																																														
1.9 TD	6K1	01/93-12/98																																														
2.0	6K1	01/93-12/98																																														
1.0	6K1	10/99-02/02																																														
1.4	6K1	10/99-02/02																																														
1.6	6K1	10/99-02/02																																														
1.8i 20v. Turbo	6K1	10/99-02/02																																														
1.9 SDi	6K1	10/99-02/02																																														
1.9 TDi	6K1	10/99-02/02																																														
<p>9001709 OE 357412331A</p> 	<p>Support suspension G/D <i>L/R suspension mounting</i></p> <p>1</p> <table border="1"> <tr><td>1.8i 16v. GT</td><td>6K1</td><td>-04/96</td></tr> <tr><td>1.9 D</td><td>6K1</td><td>-04/96</td></tr> <tr><td>1.9 SDi</td><td>6K1 Ch-</td><td>6KTR080001 -04/96</td></tr> <tr><td>1.9 TD</td><td>6K1</td><td>-04/96</td></tr> <tr><td>1.9 TDi</td><td>6K1</td><td>12/97-09/99</td></tr> <tr><td>2.0i 16v.</td><td>6K1</td><td>05/96-09/99</td></tr> <tr><td>2.0i GT</td><td>6K1</td><td>-04/96</td></tr> </table>	1.8i 16v. GT	6K1	-04/96	1.9 D	6K1	-04/96	1.9 SDi	6K1 Ch-	6KTR080001 -04/96	1.9 TD	6K1	-04/96	1.9 TDi	6K1	12/97-09/99	2.0i 16v.	6K1	05/96-09/99	2.0i GT	6K1	-04/96	<p>9005352 OE 1J0412249</p> 	<p>Butée à billes G/D <i>L/R ball bearing</i></p> <p>2</p> <table border="1"> <tr><td>1.4</td><td>6K1</td><td>11/96-09/99</td></tr> <tr><td>1.6</td><td>6K1</td><td>12/93-09/99</td></tr> <tr><td>1.8 /16v.</td><td>6K1</td><td>12/93-12/99</td></tr> <tr><td>1.9 SDi</td><td>6K1</td><td>12/93-09/99</td></tr> <tr><td>1.9 TD</td><td>6K1</td><td>01/94-10/96</td></tr> <tr><td>1.9 TDi</td><td>6K1</td><td>11/96-09/99</td></tr> <tr><td>2.0</td><td>6K1</td><td>03/95-10/96</td></tr> </table>	1.4	6K1	11/96-09/99	1.6	6K1	12/93-09/99	1.8 /16v.	6K1	12/93-12/99	1.9 SDi	6K1	12/93-09/99	1.9 TD	6K1	01/94-10/96	1.9 TDi	6K1	11/96-09/99	2.0	6K1	03/95-10/96			
1.8i 16v. GT	6K1	-04/96																																														
1.9 D	6K1	-04/96																																														
1.9 SDi	6K1 Ch-	6KTR080001 -04/96																																														
1.9 TD	6K1	-04/96																																														
1.9 TDi	6K1	12/97-09/99																																														
2.0i 16v.	6K1	05/96-09/99																																														
2.0i GT	6K1	-04/96																																														
1.4	6K1	11/96-09/99																																														
1.6	6K1	12/93-09/99																																														
1.8 /16v.	6K1	12/93-12/99																																														
1.9 SDi	6K1	12/93-09/99																																														
1.9 TD	6K1	01/94-10/96																																														
1.9 TDi	6K1	11/96-09/99																																														
2.0	6K1	03/95-10/96																																														
<p>9005362 OE 357412303E</p> 	<p>Butée de suspension G/D <i>L/R suspension bush</i></p> <p>3 H84</p> <table border="1"> <tr><td>1.0/1.05</td><td>6K1</td><td>05/93-04/96</td></tr> <tr><td>1.3</td><td>6K1</td><td>05/93-04/96</td></tr> <tr><td>1.4</td><td>6K1 -ch</td><td>6K-TR080000 05/93-</td></tr> <tr><td>1.6</td><td>6K1 -ch</td><td>6K-TR080000 05/93-</td></tr> <tr><td>1.8</td><td>6K1 -ch</td><td>6K-TR080000 05/93-</td></tr> <tr><td>1.9 D</td><td>6K1</td><td>05/93-04/96</td></tr> <tr><td>1.9 SDi</td><td>6K1</td><td>05/93-04/96</td></tr> <tr><td>1.9 TD</td><td>6K1</td><td>05/93-04/96</td></tr> <tr><td>2.0</td><td>6K1 -ch</td><td>6K-TR080000 05/93-</td></tr> </table>	1.0/1.05	6K1	05/93-04/96	1.3	6K1	05/93-04/96	1.4	6K1 -ch	6K-TR080000 05/93-	1.6	6K1 -ch	6K-TR080000 05/93-	1.8	6K1 -ch	6K-TR080000 05/93-	1.9 D	6K1	05/93-04/96	1.9 SDi	6K1	05/93-04/96	1.9 TD	6K1	05/93-04/96	2.0	6K1 -ch	6K-TR080000 05/93-	<p>2656008 OE 6N0412303A</p> 	<p>Butée de suspension <i>Shock bush</i></p> <p>3 H63 -ch 6KX430579</p> <table border="1"> <tr><td>1.0i</td><td>BVM</td><td>09/99-01/01</td></tr> <tr><td>1.4i /16v.</td><td>BVM</td><td>09/99-03/02</td></tr> <tr><td>1.6i</td><td></td><td>09/99-03/02</td></tr> <tr><td>1.8i 20v. Turbo</td><td></td><td>04/00-03/02</td></tr> <tr><td>1.9 SDi</td><td>BVM</td><td>09/99-03/02</td></tr> <tr><td>1.9 TDi</td><td>BVM</td><td>09/99-03/02</td></tr> </table>	1.0i	BVM	09/99-01/01	1.4i /16v.	BVM	09/99-03/02	1.6i		09/99-03/02	1.8i 20v. Turbo		04/00-03/02	1.9 SDi	BVM	09/99-03/02	1.9 TDi	BVM	09/99-03/02
1.0/1.05	6K1	05/93-04/96																																														
1.3	6K1	05/93-04/96																																														
1.4	6K1 -ch	6K-TR080000 05/93-																																														
1.6	6K1 -ch	6K-TR080000 05/93-																																														
1.8	6K1 -ch	6K-TR080000 05/93-																																														
1.9 D	6K1	05/93-04/96																																														
1.9 SDi	6K1	05/93-04/96																																														
1.9 TD	6K1	05/93-04/96																																														
2.0	6K1 -ch	6K-TR080000 05/93-																																														
1.0i	BVM	09/99-01/01																																														
1.4i /16v.	BVM	09/99-03/02																																														
1.6i		09/99-03/02																																														
1.8i 20v. Turbo		04/00-03/02																																														
1.9 SDi	BVM	09/99-03/02																																														
1.9 TDi	BVM	09/99-03/02																																														
<p>9005363 OE 357412303F</p> 	<p>Butée de suspension G/D <i>L/R suspension bush</i></p> <p>3 H83</p> <table border="1"> <tr><td>1.8i 16v.</td><td>6K1</td><td>07/94-04/96</td></tr> <tr><td>2.0</td><td>6K1</td><td>07/94-04/96</td></tr> </table>			1.8i 16v.	6K1	07/94-04/96	2.0	6K1	07/94-04/96																																							
1.8i 16v.	6K1	07/94-04/96																																														
2.0	6K1	07/94-04/96																																														
<p>9005369 OE 1H0413175</p> 	<p>Protecteur amortisseur G/D <i>L/R shock absorber protector</i></p> <p>4</p> <table border="1"> <tr><td>1.0 1.05</td><td>6K1</td><td>01/93-12/98</td></tr> <tr><td>1.3</td><td>6K1</td><td>01/93-12/98</td></tr> <tr><td>1.4 /16v.</td><td>6K1</td><td>01/93-12/98</td></tr> <tr><td>1.6</td><td>6K1</td><td>01/93-12/98</td></tr> <tr><td>1.8</td><td>6K1</td><td>01/93-12/98</td></tr> <tr><td>1.9 D</td><td>6K1</td><td>01/93-12/98</td></tr> <tr><td>1.9 SDi</td><td>6K1</td><td>01/93-12/98</td></tr> <tr><td>1.9 TD</td><td>6K1</td><td>01/93-12/98</td></tr> <tr><td>2.0 /16v.</td><td>6K1</td><td>01/93-12/98</td></tr> </table>	1.0 1.05	6K1	01/93-12/98	1.3	6K1	01/93-12/98	1.4 /16v.	6K1	01/93-12/98	1.6	6K1	01/93-12/98	1.8	6K1	01/93-12/98	1.9 D	6K1	01/93-12/98	1.9 SDi	6K1	01/93-12/98	1.9 TD	6K1	01/93-12/98	2.0 /16v.	6K1	01/93-12/98	<p>2656053 OE 6N0413175A</p> 	<p>Protecteur amortisseur G/D <i>L/R shock absorber protector</i></p> <p>4 H206</p> <table border="1"> <tr><td>1.0</td><td></td><td>11/96-01/01</td></tr> <tr><td>1.4i 16v.</td><td></td><td>09/00-03/02</td></tr> <tr><td>1.8i Turbo</td><td></td><td>04/00-03/02</td></tr> <tr><td>1.9 TDi</td><td></td><td>11/96-03/02</td></tr> <tr><td>2.0 16 16v.</td><td></td><td>07/98-09/99</td></tr> </table>	1.0		11/96-01/01	1.4i 16v.		09/00-03/02	1.8i Turbo		04/00-03/02	1.9 TDi		11/96-03/02	2.0 16 16v.		07/98-09/99			
1.0 1.05	6K1	01/93-12/98																																														
1.3	6K1	01/93-12/98																																														
1.4 /16v.	6K1	01/93-12/98																																														
1.6	6K1	01/93-12/98																																														
1.8	6K1	01/93-12/98																																														
1.9 D	6K1	01/93-12/98																																														
1.9 SDi	6K1	01/93-12/98																																														
1.9 TD	6K1	01/93-12/98																																														
2.0 /16v.	6K1	01/93-12/98																																														
1.0		11/96-01/01																																														
1.4i 16v.		09/00-03/02																																														
1.8i Turbo		04/00-03/02																																														
1.9 TDi		11/96-03/02																																														
2.0 16 16v.		07/98-09/99																																														

... Ibiza II III IV 93-01(6K)



Support d'amortisseur
 Suspension mounting
 Soporte amortiguador
 Poduszka amortyzatora
 Опора амортизатора

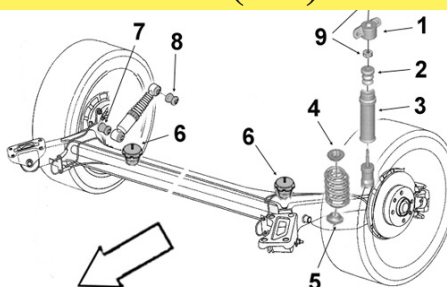

9005364 Butée de suspension AR G/D

OE 6K0512131A L/R rear suspension bush



2	H110			
	1.0 1.05	6K1		-09/99
	1.3	6K1		-09/99
	1.4 /16v.	6K1		-09/99
	1.6	6K1		-09/99
	1.8	6K1		-09/99
	1.9 D TD	6K1		-09/99
	1.9 SDi	6K1		-09/99
	2.0 /16v.	6K1		-09/99

Eléments TRAIN ARRIERE

Rear axle parts
 Tren TRAS
 Elementy zawieszenia tylnego
 элементы задней оси.



9001703 Articulation essieu AR

OE 6N0501541D Rear axle bush



Ø int.10 Ø ext.58 coll.66
 long. tube int.58 ext.41 ep. coll.9

1.0	6K1	05/93-09/99
1.3	6K1	05/93-09/99
1.4	6K1	05/93-09/99
1.6	6K1	05/93-09/99
1.8 /16v.	6K1	05/93-09/99
1.9 D	6K1	05/93-09/99
1.9 SDi	6K1	08/96-09/99
1.9 TD TDi	6K1	05/93-09/99
2.0 /16v.	6K1	05/93-09/99

9001789 Articulation essieu AR

OE 6K0501541A Rear axle bush



Ø int.12 Ø ext.72 coll.80
 long. tube int.90 ext.55 ep. coll.5/9

1.0	6K1	10/99-
1.4 /16v.	6K1	10/99-
1.6	6K1	10/99-
1.8i 20v. Turbo	6K1	10/99-
1.9 SDi	6K1	10/99-
1.9 TDi	6K1	10/99-

Ibiza V 01- (6J 6L) ...

Eléments DIRECTION

Steering parts
 Elementos Direcciones
 Elementy układ kierowniczy
 Элементы рулевой системы

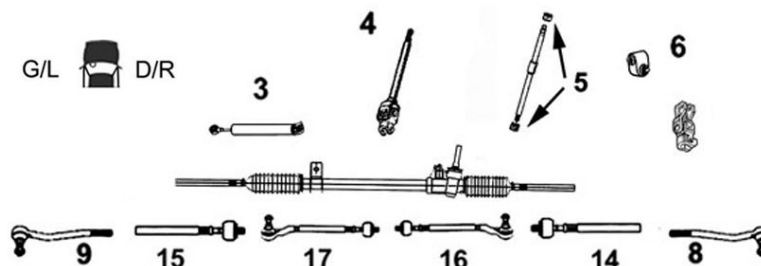

9006874 Axe de bielle G/D

OE 6Q0423810C L/R axial joint



14	Côté dir. M16x1.5		
15	Côté rot. M14x1.5 long 299 mm		
Dir. SMI Koyo			
1.2	6L1		-12/09
1.2i 12v.	6L1		
1.4	6L1		05/06-12/09
1.4i 16v.	6L1		
1.4 TDi	6L1		
1.8 Turbo	6L1		11/03-12/09
1.9 SDi TDi	6L1		

9006251 Axe de bielle G/D

Part/oe 6Q0423803B L/R axial joint



14	Côté dir. M14x1.5		
15	Côté rot. M14x1.5 long 295 mm		
Dir. TRW			
1.2i 12v.	6L1		-12/09
1.4i 16v.	6L1		
1.4 TDi	6L1		
1.8 Turbo	6L1		11/03-12/09
1.9 SDi	6L1		
1.9 TDi	6L1		-06/09

... Ibiza V 01- (6J 6L)

SEAT

SASIC

7776079 Axe de bielle G/D

Part/oe 6R0423803A L/R axial joint

NEW



14 Côté dir. M14x1.5 Côté rot. M14x1.5 long 310 mm

15	1.2i	10/09-
	1.2 TDi	09/10-
	1.2 TFSi /TSi	10/10-
	1.4i/TSi	04/09-
	1.4 TDi	04/09-
	1.6i	04/09-
	1.6 TDi	04/09-
	1.9 TDi	07/09-
	2.0 TDi	01/10-

9006634 Rotule de direction G

OE 6Q0423811C Left tie rod end



9	M14 x 1.5	
	1.2	05/06-
	1.2i 12v.	
	1.2 TDi	09/10-
	1.2 TSi TFSi	10/10-
	1.4i	
	1.4i 16v.	
	1.4 TDi	
	1.4 TSi /Cupra	05/08-
	1.6i /GPL	08/08-
	1.6i 16v.	11/06-
	1.6 TDi FAP	05/08-
	1.8 Turbo	11/03-12/09
	1.9 SDi	
	1.9 TDi	
	2.0 TDi	01/10-

9006635 Rotule de direction D

OE 6Q0423812C Right tie rod end



8	M14 x 1.5	
	1.2	05/06-
	1.2i 12v.	
	1.2 TDi	09/10-
	1.2 TSi TFSi	10/10-
	1.4i	
	1.4i 16v.	
	1.4 TDi	
	1.4 TSi /Cupra	05/08-
	1.6i /GPL	08/08-
	1.6i 16v.	11/06-
	1.6 TDi FAP	05/08-
	1.8 Turbo	11/03-12/09
	1.9 SDi	
	1.9 TDi	
	2.0 TDi	01/10-



Barre stabilisatrice
Stabilizer bar
Barra estabilizadora
Drażek stabilizatora
стабилизатор поперечной устойчивости

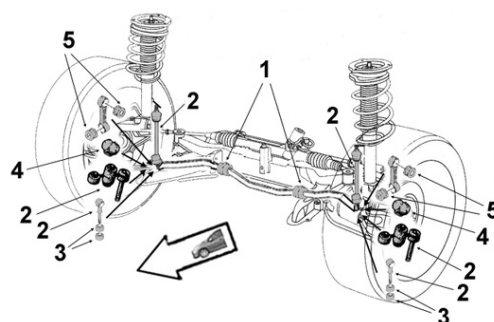

9005089 Bielle barre stab.

OE 6Q0411315N Stabilizer bar stub axle



2		
	1.2i 12v.	03/02-
	1.2 TSi /TDi	09/10-
	1.4i 16v.	03/02-
	1.4 TSi	06/09-
	1.4 TDi	03/02-
	1.6i 16v.	05/08-
	1.6 TDi	05/09-
	1.8 Turbo Cupra R	01/04-02/08
	1.9 SDi TDi	03/02-
	2.0 TDi	01/10-

2306017 Palier de barre milieu

OE 6Q0411314P Middle bar main bearing

NEW



1	Barre Ø 18	
	1.2i	Ch- 6L-3-164393 -06/06
	1.2i 12v.	Ch- 6L-3-164393
	1.2 TSi TFSi	09/10-
	1.2 TDi	04/10-
	1.4i /16v.	Ch- 6L-3-164393
	1.4 TSi	06/09-
	1.4 TDi	Ch- 6L-3-164393
	1.6i /16v.	Ch- 6L-3-164393
	1.6 TDi	05/09-
	1.8i Turbo	12/03-05/08
	1.9 SDi	Ch- 6L-3-164393 -12/05
	1.9 TDi	Ch- 6L-3-164393
	2.0 TDi	01/10-

2306019 Palier de barre milieu

OE 6Q0411314R Middle bar main bearing



1	Barre Ø 18	
	1.2i 12v.	02/02-
	1.2i	06/07-05/08
	1.2 TSi TFSi	09/10-
	1.2 TDi	04/10-
	1.4i 16v.	02/02-
	1.4 TSi	CAVE /VF 06/09-
	1.4 TDi	05/02-
	1.6i /16v.	02/03-
	1.6 TDi	CAYA/B/C 05/09-
	1.8i Turbo	12/03-05/08
	1.9 SDi	02/02-12/05
	1.9 TDi	02/02-
	2.0 TDi	01/10-

2306018 Palier de barre milieu

OE 6Q0411314Q Middle bar main bearing



1	Barre Ø 19	
	1.2i	02/02-
	1.2i 12v.	05/06-
	1.2 TSi TFSi	09/10-
	1.2 TDi	04/10-
	1.4i 16v.	02/02-
	1.4 TSi	CAVE /F 06/09-
	1.4 TDi	05/02-
	1.6i	07/08-
	1.6 TDi	CAYA/B/C 05/09-
	1.8i Turbo	12/03-05/08
	1.9 SDi	02/02-12/05
	1.9 TDi	02/02-
	2.0 TDi	01/10-

...Ibiza V 01- (6J 6L)...



Eléments SUSPENSION
 Suspension parts
 Elementos suspensión
 Elementy zawieszenie
 Элементы подвески

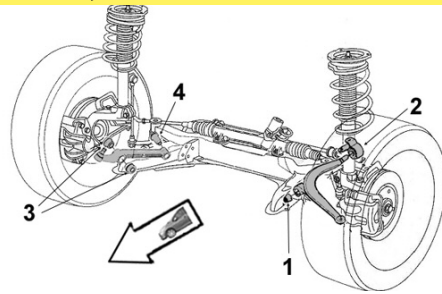

SEAT

2256038

Articulation AV

OE 6Q0407182A

Front bush



1 Ø int.12 Ø ext.33 coll.39
 long. tube int.54 ext.30
 1.2i 12v. BVM 03/02-05/06
 1.4i 16v. 03/02-08/08
 1.4 TDi BVM 06/03-10/05
 1.6 02/03-
 1.8i Turbo BVM 11/03-08/08
 1.9 SDi BVM 03/02-10/05
 1.9 TDi BVM 03/02-08/08

9001523

Articulation AV

OE 357407182

Front bush



1 Ø int.12 Ø ext.33 coll.36
 long. tube int.54 ext.29 ep. coll.5
 1.2i 03/08-
 1.2 TDi 04/10-
 1.2 TSi TFSi 09/10-
 1.4i 03/08-
 1.4 TDi 07/08-
 1.4 TSi 06/09-
 1.6i 05/08-
 1.6 TDi 05/09-
 1.9 TDi 03/08-
 2.0 TDi 01/10-

2256001

Articulation AR

OE 6Q0407183A

Rear bush



2 Ø int.18.5 Ø ext.64 coll.71.5
 long. tube int.35 ext.46
 1.2i 12v. 6L1 03/02-
 1.4i 16v. 6L1 03/02-03/08
 1.4 TDi 6L1 03/02-03/08
 1.8i Turbo 01/04-05/08
 1.9 SDi 6L1 03/02-
 1.9 TDi 6L1 03/02-03/08

9001542

Articulation AR

OE 1J0407181

Rear bush



2 Ø int.13 Ø ext.59.5 long. tube int.41 ext.23.5
 1.2i 03/08-
 1.2 TDi 05/10-
 1.2 TSi TFSi 09/10-
 1.4i 03/08-
 1.4 TDi 07/08-
 1.4 TSi 06/09-
 1.6i 05/08-
 1.6 TDi 05/09-
 1.9 TDi 03/08-
 2.0 TDi 01/10-

Bras & Triangle de suspension

Control arm
 Brazo y triángulo
 Wahacz
 Рычаг подвески

G/L D/R

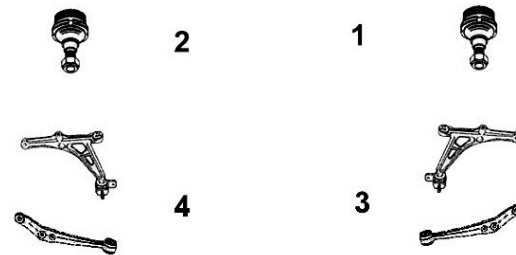

9005758

Triangle de susp. inf. G/D

OE 6Q0407151L

Lower L/R track control arm



3
4 Sans rotule Without tie rod end
 1.2 05/06-13/03/08
 1.2i 12v. -13/03/08
 1.4i/16v. -13/03/08
 1.4 TDi -13/03/08
 1.8 Turbo -13/03/08
 1.9 SDi -13/03/08
 1.9 TDi -13/03/08

7476123

Triangle de susp. G

OE 6Q0407151L+6Q0407365M Left track control arm



4 Avec rotule With ball joint
 1.2 05/06-13/03/08
 1.2i 12v. -13/03/08
 1.4i 05/06-13/03/08
 1.4i 16v. -13/03/08
 1.4 TDi -ch 6L-6-523398 -13/03/08
 1.8 Turbo -13/03/08
 1.9 SDi -13/03/08
 1.9 TDi -ch 6L-6-523398 -13/03/08

7476122

Triangle de susp. D

OE 6Q0407151L+6Q0407366M Right track control arm



3 Avec rotule With ball joint
 1.2 05/06-13/03/08
 1.2i 12v. -13/03/08
 1.4i 05/06-13/03/08
 1.4i 16v. -13/03/08
 1.4 TDi -ch 6L-6-523398 -13/03/08
 1.8 Turbo -13/03/08
 1.9 SDi -13/03/08
 1.9 TDi -ch 6L-6-523398 -13/03/08

... Ibiza V 01- (6J 6L) ...

SEAT



7476091 OE 6R0407151F	Triangle de susp. inf. G <i>Lower left track control arm</i>	7476092 OE 6R0407152F	Triangle de susp. inf. D <i>Lower right track control arm</i>																																								
	4 Sans rotule <i>Without tie rod end</i> <table style="width: 100%; border-collapse: collapse;"> <tr><td style="width: 60%;">1.2i</td><td style="width: 40%;">05/08-</td></tr> <tr><td>1.2 TDi</td><td>09/10-</td></tr> <tr><td>1.2 TSi</td><td>10/10-</td></tr> <tr><td>1.4i</td><td>05/08-</td></tr> <tr><td>1.4 TSi /Cupra</td><td>05/08-</td></tr> <tr><td>1.4 TDi</td><td>05/08-</td></tr> <tr><td>1.6i</td><td>05/08-</td></tr> <tr><td>1.6 TDi</td><td>04/09-</td></tr> <tr><td>1.9 TDi</td><td>05/08-</td></tr> <tr><td>2.0 TDi</td><td>01/10-</td></tr> </table>	1.2i	05/08-	1.2 TDi	09/10-	1.2 TSi	10/10-	1.4i	05/08-	1.4 TSi /Cupra	05/08-	1.4 TDi	05/08-	1.6i	05/08-	1.6 TDi	04/09-	1.9 TDi	05/08-	2.0 TDi	01/10-		3 Sans rotule <i>Without tie rod end</i> <table style="width: 100%; border-collapse: collapse;"> <tr><td style="width: 60%;">1.2i</td><td style="width: 40%;">05/08-</td></tr> <tr><td>1.2 TDi</td><td>09/10-</td></tr> <tr><td>1.2 TSi</td><td>10/10-</td></tr> <tr><td>1.4i</td><td>05/08-</td></tr> <tr><td>1.4 TSi /Cupra</td><td>05/08-</td></tr> <tr><td>1.4 TDi</td><td>05/08-</td></tr> <tr><td>1.6i</td><td>05/08-</td></tr> <tr><td>1.6 TDi</td><td>04/09-</td></tr> <tr><td>1.9 TDi</td><td>05/08-</td></tr> <tr><td>2.0 TDi</td><td>01/10-</td></tr> </table>	1.2i	05/08-	1.2 TDi	09/10-	1.2 TSi	10/10-	1.4i	05/08-	1.4 TSi /Cupra	05/08-	1.4 TDi	05/08-	1.6i	05/08-	1.6 TDi	04/09-	1.9 TDi	05/08-	2.0 TDi	01/10-
1.2i	05/08-																																										
1.2 TDi	09/10-																																										
1.2 TSi	10/10-																																										
1.4i	05/08-																																										
1.4 TSi /Cupra	05/08-																																										
1.4 TDi	05/08-																																										
1.6i	05/08-																																										
1.6 TDi	04/09-																																										
1.9 TDi	05/08-																																										
2.0 TDi	01/10-																																										
1.2i	05/08-																																										
1.2 TDi	09/10-																																										
1.2 TSi	10/10-																																										
1.4i	05/08-																																										
1.4 TSi /Cupra	05/08-																																										
1.4 TDi	05/08-																																										
1.6i	05/08-																																										
1.6 TDi	04/09-																																										
1.9 TDi	05/08-																																										
2.0 TDi	01/10-																																										
7476183 OE 6R0407151F+6R0407365A	Triangle de susp. inf. G <i>Lower left track control arm</i>	7476184 OE 6R0407152F+6R0407366A	Triangle de susp. inf. D <i>Lower right track control arm</i>																																								
	4 Avec rotule <i>With ball joint</i> <table style="width: 100%; border-collapse: collapse;"> <tr><td style="width: 60%;">1.2i</td><td style="width: 40%;">05/08-</td></tr> <tr><td>1.2 TSi</td><td>10/10-10/13</td></tr> <tr><td>1.2 TDi FAP</td><td>09/10-10/13</td></tr> <tr><td>1.4i</td><td>05/08-10/13</td></tr> <tr><td>1.4 TSi /Cupra</td><td>05/08-10/13</td></tr> <tr><td>1.4 TDi FAP</td><td>05/08-10/13</td></tr> <tr><td>1.6i</td><td>05/08-10/13</td></tr> <tr><td>1.6 TDi FAP</td><td>04/09-10/13</td></tr> <tr><td>1.9 TDi FAP</td><td>05/08-10/13</td></tr> <tr><td>2.0 TDi</td><td>01/10-10/13</td></tr> </table>	1.2i	05/08-	1.2 TSi	10/10-10/13	1.2 TDi FAP	09/10-10/13	1.4i	05/08-10/13	1.4 TSi /Cupra	05/08-10/13	1.4 TDi FAP	05/08-10/13	1.6i	05/08-10/13	1.6 TDi FAP	04/09-10/13	1.9 TDi FAP	05/08-10/13	2.0 TDi	01/10-10/13		3 Avec rotule <i>With ball joint</i> <table style="width: 100%; border-collapse: collapse;"> <tr><td style="width: 60%;">1.2i</td><td style="width: 40%;">05/08-10/13</td></tr> <tr><td>1.2 TSi</td><td>10/10-10/13</td></tr> <tr><td>1.2 TDi FAP</td><td>09/10-10/13</td></tr> <tr><td>1.4i</td><td>05/08-10/13</td></tr> <tr><td>1.4 TSi /Cupra</td><td>05/08-10/13</td></tr> <tr><td>1.4 TDi FAP</td><td>05/08-10/13</td></tr> <tr><td>1.6i</td><td>05/08-10/13</td></tr> <tr><td>1.6 TDi FAP</td><td>04/09-10/13</td></tr> <tr><td>1.9 TDi FAP</td><td>05/08-10/13</td></tr> <tr><td>2.0 TDi</td><td>01/10-10/13</td></tr> </table>	1.2i	05/08-10/13	1.2 TSi	10/10-10/13	1.2 TDi FAP	09/10-10/13	1.4i	05/08-10/13	1.4 TSi /Cupra	05/08-10/13	1.4 TDi FAP	05/08-10/13	1.6i	05/08-10/13	1.6 TDi FAP	04/09-10/13	1.9 TDi FAP	05/08-10/13	2.0 TDi	01/10-10/13
1.2i	05/08-																																										
1.2 TSi	10/10-10/13																																										
1.2 TDi FAP	09/10-10/13																																										
1.4i	05/08-10/13																																										
1.4 TSi /Cupra	05/08-10/13																																										
1.4 TDi FAP	05/08-10/13																																										
1.6i	05/08-10/13																																										
1.6 TDi FAP	04/09-10/13																																										
1.9 TDi FAP	05/08-10/13																																										
2.0 TDi	01/10-10/13																																										
1.2i	05/08-10/13																																										
1.2 TSi	10/10-10/13																																										
1.2 TDi FAP	09/10-10/13																																										
1.4i	05/08-10/13																																										
1.4 TSi /Cupra	05/08-10/13																																										
1.4 TDi FAP	05/08-10/13																																										
1.6i	05/08-10/13																																										
1.6 TDi FAP	04/09-10/13																																										
1.9 TDi FAP	05/08-10/13																																										
2.0 TDi	01/10-10/13																																										
9005478 OE 6Q0407365M	Rotule de susp. inf. G <i>Left lower suspension ball joint</i>	9005479 OE 6Q0407366M	Rotule de susp. inf. D <i>Right lower suspension ball joint</i>																																								
	2 <table style="width: 100%; border-collapse: collapse;"> <tr><td style="width: 60%;">1.2</td><td style="width: 40%;">05/06-13/03/08</td></tr> <tr><td>1.2i 12v. -ch 6L-6-523398</td><td>-13/03/08</td></tr> <tr><td>1.4</td><td>05/06-13/03/08</td></tr> <tr><td>1.4i 16v. -ch 6L-6-523398</td><td>-13/03/08</td></tr> <tr><td>1.4 TDi -ch 6L-6-523398</td><td>-13/03/08</td></tr> <tr><td>1.8 Turbo</td><td>11/03-13/03/08</td></tr> <tr><td>1.9 SDi -ch 6L-6-523398</td><td>-13/03/08</td></tr> <tr><td>1.9 TDi -ch 6L-6-523398</td><td>-13/03/08</td></tr> </table>	1.2	05/06-13/03/08	1.2i 12v. -ch 6L-6-523398	-13/03/08	1.4	05/06-13/03/08	1.4i 16v. -ch 6L-6-523398	-13/03/08	1.4 TDi -ch 6L-6-523398	-13/03/08	1.8 Turbo	11/03-13/03/08	1.9 SDi -ch 6L-6-523398	-13/03/08	1.9 TDi -ch 6L-6-523398	-13/03/08		1 <table style="width: 100%; border-collapse: collapse;"> <tr><td style="width: 60%;">1.2</td><td style="width: 40%;">05/06-13/03/08</td></tr> <tr><td>1.2i 12v. -ch 6L-6-523398</td><td>-13/03/08</td></tr> <tr><td>1.4</td><td>05/06-13/03/08</td></tr> <tr><td>1.4i 16v. -ch 6L-6-523398</td><td>-13/03/08</td></tr> <tr><td>1.4 TDi -ch 6L-6-523398</td><td>-13/03/08</td></tr> <tr><td>1.8 Turbo</td><td>11/03-13/03/08</td></tr> <tr><td>1.9 SDi -ch 6L-6-523398</td><td>-13/03/08</td></tr> <tr><td>1.9 TDi -ch 6L-6-523398</td><td>-13/03/08</td></tr> </table>	1.2	05/06-13/03/08	1.2i 12v. -ch 6L-6-523398	-13/03/08	1.4	05/06-13/03/08	1.4i 16v. -ch 6L-6-523398	-13/03/08	1.4 TDi -ch 6L-6-523398	-13/03/08	1.8 Turbo	11/03-13/03/08	1.9 SDi -ch 6L-6-523398	-13/03/08	1.9 TDi -ch 6L-6-523398	-13/03/08								
1.2	05/06-13/03/08																																										
1.2i 12v. -ch 6L-6-523398	-13/03/08																																										
1.4	05/06-13/03/08																																										
1.4i 16v. -ch 6L-6-523398	-13/03/08																																										
1.4 TDi -ch 6L-6-523398	-13/03/08																																										
1.8 Turbo	11/03-13/03/08																																										
1.9 SDi -ch 6L-6-523398	-13/03/08																																										
1.9 TDi -ch 6L-6-523398	-13/03/08																																										
1.2	05/06-13/03/08																																										
1.2i 12v. -ch 6L-6-523398	-13/03/08																																										
1.4	05/06-13/03/08																																										
1.4i 16v. -ch 6L-6-523398	-13/03/08																																										
1.4 TDi -ch 6L-6-523398	-13/03/08																																										
1.8 Turbo	11/03-13/03/08																																										
1.9 SDi -ch 6L-6-523398	-13/03/08																																										
1.9 TDi -ch 6L-6-523398	-13/03/08																																										
7576019 OE 6R0407365A	Rotule de susp. inf. G <i>Left lower suspension ball joint</i>	7576020 OE 6R0407366A	Rotule de susp. inf. D <i>Right lower suspension ball joint</i>																																								
	2 <table style="width: 100%; border-collapse: collapse;"> <tr><td style="width: 60%;">1.2i</td><td style="width: 40%;">05/08-10/13</td></tr> <tr><td>1.2 TDi FAP</td><td>09/10-10/13</td></tr> <tr><td>1.2 TSi</td><td>10/10-10/13</td></tr> <tr><td>1.4i</td><td>05/08-10/13</td></tr> <tr><td>1.4 TDi FAP</td><td>05/08-10/13</td></tr> <tr><td>1.4 TSi /Cupra</td><td>05/08-10/13</td></tr> <tr><td>1.6i</td><td>05/08-10/13</td></tr> <tr><td>1.6 TDi FAP</td><td>04/09-10/13</td></tr> <tr><td>1.9 TDi FAP</td><td>05/08-10/13</td></tr> <tr><td>2.0 TDi</td><td>01/10-10/13</td></tr> </table>	1.2i	05/08-10/13	1.2 TDi FAP	09/10-10/13	1.2 TSi	10/10-10/13	1.4i	05/08-10/13	1.4 TDi FAP	05/08-10/13	1.4 TSi /Cupra	05/08-10/13	1.6i	05/08-10/13	1.6 TDi FAP	04/09-10/13	1.9 TDi FAP	05/08-10/13	2.0 TDi	01/10-10/13		1 <table style="width: 100%; border-collapse: collapse;"> <tr><td style="width: 60%;">1.2i</td><td style="width: 40%;">05/08-10/13</td></tr> <tr><td>1.2 TDi FAP</td><td>09/10-10/13</td></tr> <tr><td>1.2 TSi</td><td>10/10-10/13</td></tr> <tr><td>1.4i</td><td>05/08-10/13</td></tr> <tr><td>1.4 TDi FAP</td><td>05/08-10/13</td></tr> <tr><td>1.4 TSi /Cupra</td><td>05/08-10/13</td></tr> <tr><td>1.6i</td><td>05/08-10/13</td></tr> <tr><td>1.6 TDi FAP</td><td>04/09-10/13</td></tr> <tr><td>1.9 TDi FAP</td><td>05/08-10/13</td></tr> <tr><td>2.0 TDi</td><td>01/10-10/13</td></tr> </table>	1.2i	05/08-10/13	1.2 TDi FAP	09/10-10/13	1.2 TSi	10/10-10/13	1.4i	05/08-10/13	1.4 TDi FAP	05/08-10/13	1.4 TSi /Cupra	05/08-10/13	1.6i	05/08-10/13	1.6 TDi FAP	04/09-10/13	1.9 TDi FAP	05/08-10/13	2.0 TDi	01/10-10/13
1.2i	05/08-10/13																																										
1.2 TDi FAP	09/10-10/13																																										
1.2 TSi	10/10-10/13																																										
1.4i	05/08-10/13																																										
1.4 TDi FAP	05/08-10/13																																										
1.4 TSi /Cupra	05/08-10/13																																										
1.6i	05/08-10/13																																										
1.6 TDi FAP	04/09-10/13																																										
1.9 TDi FAP	05/08-10/13																																										
2.0 TDi	01/10-10/13																																										
1.2i	05/08-10/13																																										
1.2 TDi FAP	09/10-10/13																																										
1.2 TSi	10/10-10/13																																										
1.4i	05/08-10/13																																										
1.4 TDi FAP	05/08-10/13																																										
1.4 TSi /Cupra	05/08-10/13																																										
1.6i	05/08-10/13																																										
1.6 TDi FAP	04/09-10/13																																										
1.9 TDi FAP	05/08-10/13																																										
2.0 TDi	01/10-10/13																																										

... Ibiza V 01- (6J 6L) ...





SASIC

SEAT

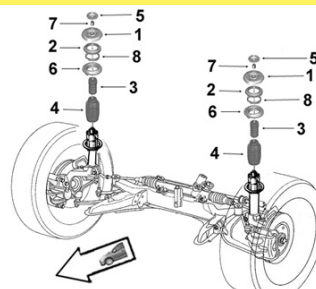

Support d'amortisseur
Suspension mounting
Soporte amortiguador
Poduszka amortyzatora
Опора амортизатора



9005623 Support suspension G/D OE 6N0412331E <i>L/R suspension mounting</i>		9005614 Tampon suspension AV G/D OE 1J0412331C <i>L/R front suspension rebound stop</i>	
	1 1.2i 12v. 03/02-05/08 1.4i 16v. 03/02-03/08 1.4 TDi 03/02-12/09 1.9 SDi 03/02- 1.9 TDi 03/02-03/08		1 1.2 TSi TFSi 09/10- 1.2i 05/08- 1.2 TDi 04/10- 1.4i 16v. 03/08- 1.4 TSi 06/09- 1.4 TDi 07/08- 1.6i 16v. 05/08- 1.6 TDi 05/09- 1.9 TDi 03/08- 2.0 TDi 01/10-
			9005352 Butée à billes G/D OE 1J0412249 <i>L/R ball bearing</i>
2656048 Butée de suspension OE 6Q0412301A <i>Shock bush</i>		9005338 Butée de suspension OE 1H0412303B <i>Shock bush</i>	
	3 H56 1.2i 05/06-12/09 1.2i 12v. 03/02-12/09 1.4i 16v. 03/02-12/09 1.4 TDi 06/03-12/09 1.8i Turbo 11/03-12/09 1.9 SDi 03/02-10/05 1.9 TDi 03/02-12/09		3 H64 1.2i 03/08- 1.2 TSi TFSi 09/10- 1.2 TDi 04/10- 1.4i 03/08- 1.4 TSi 06/09- 1.6i 05/08- 1.6 TDi 05/09- 2.0 TDi 01/10-
			2656053 Protecteur amortisseur G/D OE 6N0413175A <i>L/R shock absorber protector</i>
9005327 Protecteur amortisseur G/D OE 357413175A <i>L/R shock absorber protector</i>		4 H221.5 1.2i 03/08- 1.2 TSi TFSi 09/10- 1.2 TDi 04/10- 1.4i 03/08- 1.4 TSi Sauf Break 06/09- 1.6i 05/08- 1.6 TDi 05/09- 2.0 TDi 01/10-	
			

... Ibiza V 01- (6J 6L)

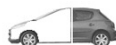

Support d'amortisseur
 Suspension mounting
 Soporte amortiguador
 Poduszka amortyzatora
 Опора амортизатора

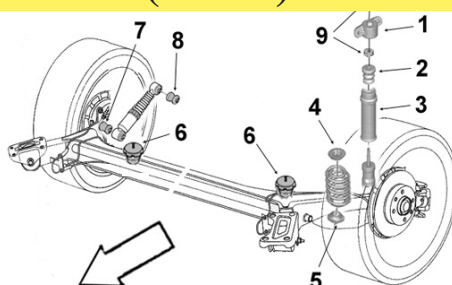

SEAT



9005630 **Support suspension G/D**
 OE 1J0513353B *L/R suspension mounting*



1	1.2i /12v.	6L1	03/02-
	1.4i 16v.	6L1	03/02-08/10
	1.4 TDi	6L1	03/02-08/10
	1.6i	6L1	05/08-08/10
	1.6 TDi	6L1	05/08-08/10
	1.9 SDi	6L1	03/02-08/10
	1.9 TDi	6L1	03/02-08/10
		ASY	

Eléments TRAIN ARRIERE

Rear axle parts
Tren TRAS
Elementy zawieszenia tylnego
элементы задней оси.



2606001 **Articulation traverse**
 OE 6R0501541A *Cross bar bush*



Ø int.12 Ø ext. 71.5 coll. 80
 long. tube int. 90 ext. 54.5

Châssis normal

1.2i	13/09/10-
1.2 TSi TDi	13/09/10-
1.4 TSi / Cupra	13/09/10-
1.6i	13/09/10-
1.6 TDi FAP	13/09/10-
1.9 TDi FAP	13/09/10-

9001750 **Articulation essieu G/D**
 OE 6Q0501541E *L/R axle bush*



Ø int.12 Ø ext.70 coll.88
 long. tube int.90 ext.64 ep. coll.11

1.2i	05/06-13/09/10
1.2i 12v.	03/02-13/09/10
1.2 TDi	09/10-13/09/10
1.4i	05/06-13/09/10
1.4i 16v.	03/02-13/09/10
1.4 TSi/Cupra	05/08-13/09/10
1.4 TDi	06/03-13/09/10
1.6i	05/08-13/09/10
1.6 TDi	05/08-13/09/10
1.9 SDi	03/02-10/05
1.9 TDi	03/02-13/09/10

Leon ...

Eléments DIRECTION

Steering parts
Elementos Direcciones
Elementy uklad kierowniczy
Элементы рулевой системы

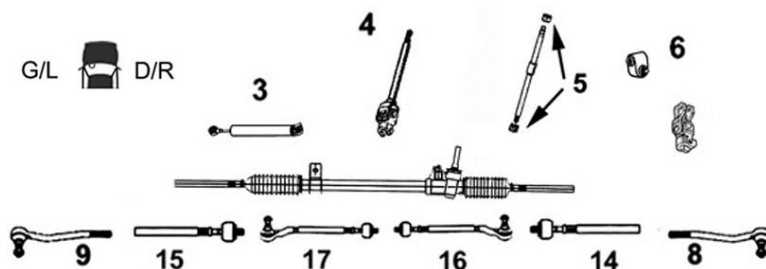

9006219 **Axe de bielle G/D**
 Part/oe 1J0422803H *L/R axial joint*



14 **Côté dir. M16x1.5 Côté rot. M14x1.5 long 320 mm**
15

1.4i 16v.	-06/06
1.6 /i 16v.	-06/06
1.8i 20v.	-06/06
1.9 SDi	-06/06
1.9 TDi	-06/06
2.8i V6 24v. /4WD	01/01-05/02

... Leon ...

Eléments DIRECTION

Steering parts

Elementos Direcciones

Elementy układ kierowniczy

Элементы рулевой системы

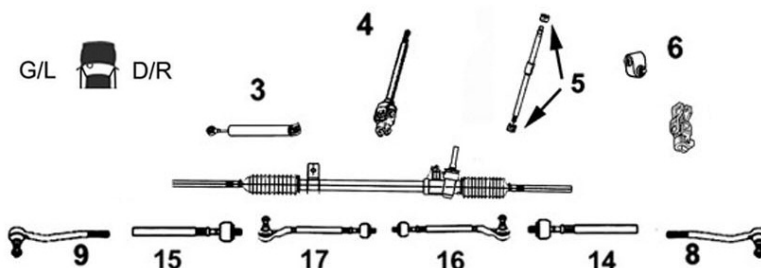

9006873

Axe de bielle G/D

OE 1K0423810A

L/R axial joint



14 Côté dir. M16x1.5 Côté rot. M16x1.5 long 310 mm

15

1.2 TSi	03/10-
1.4i	05/09-
1.4 TFSi	11/07-
1.4 TSi	10/12-
1.6i	09/05-
1.6 TDi	01/10-
1.8 TFSi	11/07-
1.9 TDi	09/05-
2.0 FSi	09/05-
2.0 TFSi	11/05-
2.0 TSi	05/09-
2.0 TDi	09/05-

9006634

Rotule de direction G

OE 1J0422812B

Left tie rod end



9 M14 x 1.5 Dir. TRW

1.4i 16v.	-06/06
1.6	-06/06
1.6i 16v.	09/00-06/06
1.8i 20v. /4WD	-06/06
1.9 SDi	-06/06
1.9 TDi /4WD	-06/06
2.8 24v.	01/01-05/02

9006635

Rotule de direction D

OE 1J0422811B

Right tie rod end



8 M14 x 1.5 Dir. TRW

1.4i 16v.	-06/06
1.6	-06/06
1.6i 16v.	09/00-06/06
1.8i 20v. /4WD	-06/06
1.9 SDi	-06/06
1.9 TDi /4WD	-06/06
2.8 24v.	01/01-05/02

9006638

Rotule de direction G

OE 1K0423811J

Left tie rod end



9 M16 x 1.5

1.2 TSi	03/10-
1.4i	05/09-
1.4 TFSi	11/07-
1.4 TSi	10/12-
1.6i	09/05-
1.6 TDi FAP	01/10-
1.8 TFSi	11/07-
1.9 TDi	09/05-
2.0 FSi	09/05-05/09
2.0 TFSi	11/05-10/06
2.0 TFSi CDLA BVM	09/09-
2.0 TSi	05/09-
2.0 TDi	09/05-

9006637

Rotule de direction D

OE 1K0423812J

Right tie rod end



8 M16 x 1.5

1.2 TSi	03/10-
1.4i	05/09-
1.4 TFSi	11/07-
1.4 TSi	10/12-
1.6i	09/05-
1.6 TDi FAP	01/10-
1.8 TFSi	11/07-
1.9 TDi	09/05-
2.0 FSi	09/05-05/09
2.0 TFSi	11/05-10/06
2.0 TFSi CDLA BVM	09/09-
2.0 TSi	05/09-
2.0 TDi	09/05-



Barre stabilisatrice

Stabilizer bar

Barra estabilizadora

Drażek stabilizatora

стабилизатор поперечной устойчивости

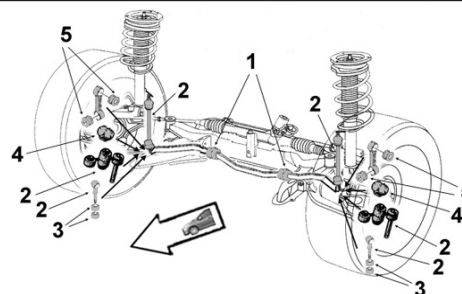

9005084

Biellette barre stab.

OE 1J0411315J

Stabilizer bar stub axle



2 Barre Ø 21

1.4i 16v.	04/00-09/05
1.6	04/00-09/05
1.9 SDi	04/00-09/05
1.9 TDi	04/00-09/05

9005093

Biellette barre stab.

OE 1J0411315K

Stabilizer bar stub axle













2 Barre Ø 23

1.4i 16v.	04/00-09/05
1.6i 16v.	04/00-09/05
1.8i 20v. /Turbo	04/00-09/05
1.9 SDi	04/00-09/05
1.9 TDi	04/00-09/05

... Leon ...

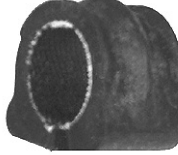
SEAT

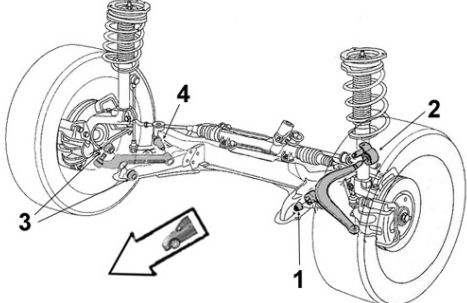
SASIC

9005090		Biellette barre stab.	
OE 1J0411315G		<i>Stabilizer bar stub axle</i>	
	2	Barre Ø 23	
		1.4i 16v. 1.6 1.9 SDi 1.9 TDi	04/00-09/05 04/00-09/05 04/00-09/05 04/00-09/05
2306007		Biellette barre stab. G	
OE 1J0411315D		<i>Left stabilizer bar stub axle</i>	
	2	Barre Ø 23	
		1.8i 20v. Turbo 4WD 180hp 132kw 04/00-06/03 1.9 TDi 4WD 150kw 110kw 01/01-09/05 2.8i V6 24v. 4WD 205hp 150kw 01/01-05/02 2.8i VR6 24v. 205hp 150kw 01/01-05/02	
2306008		Biellette barre stab. D	
OE 1J0411316D		<i>Right stabilizer bar stub axle</i>	
	2	Barre Ø 23	
		1.8i 20v. Turbo 4WD 180hp 132kw 04/00-06/03 1.9 TDi 4WD 150kw 110kw 01/01-09/05 2.8i V6 24v. 4WD 205hp 150kw 01/01-05/02 2.8i VR6 24v. 205hp 150kw 01/01-05/02	
2306010		Biellette barre stab.	
OE 1K0411315P		<i>Stabilizer bar stub axle</i>	
	2	Barre Ø 23	
		1.2 TSi 02/10- 1.4i 06/06- 1.4 TFSi 12/07- 1.6i 07/05- 1.6 TDi 02/10- 1.8 TSi 06/07- 1.9 TDi 10/06- 2.0 FSi 07/05- 2.0 TSi TFSi 05/05- 2.0 TDi 09/05-	
9005018		Liaison élastique	
OE 1J0411327		<i>Elastic link</i>	
	5	Ø int.14.5 ext.Ø29 coll.35 x2 long. tube int.22.5 ext.18 ep. coll.2 x2	
		1.4i 16v. 04/00- 1.6i 16v. 04/00- 1.8i 20v. 04/00- 1.9 SDi 04/00- 1.9 TDi 04/00- 2.8 V6 04/00-	
9001730		Palier de barre milieu	
OE 1J0411314R		<i>Middle bar main bearing</i>	
	1	Barre Ø 21	
		1.4i 16v. 1.6 1.9 SDi 1.9 TDi	
9001732		Palier de barre milieu	
OE 1J0411314T		<i>Middle bar main bearing</i>	
	1	Barre Ø 23	
		1.4i 16v. 04/00- 1.6i 16v. 04/00- 1.8i 20v. /Turbo 04/00- 1.9 SDi 04/00- 1.9 TDi 04/00- 2.8i V6 24v. 4WD 01/01-05/02	
			
Eléments SUSPENSION		Eléments SUSPENSION	
<i>Suspension parts</i>		<i>Suspension parts</i>	
<i>Elementos suspensión</i>		<i>Elementos suspensión</i>	
<i>Elementy zawieszenia</i>		<i>Elementy zawieszenia</i>	
<i>Элементы подвески</i>		<i>Элементы подвески</i>	
9001523		Articulation AV	
OE 357407182		<i>Front bush</i>	
	1	Ø int.12 Ø ext.33 coll.36 long. tube int.54 ext.29 ep. coll.5	
		1.4i 16v. 04/00- 1.6 BVM BVA 04/00- 1.6i 16v. 04/00- 1.8i 20v. /Turbo 04/00- 1.9 SDi 04/00- 1.9 TDi 04/00- 2.8i V6 24v. 4WD 01/01-	
9001759		Articulation AV	
OE 1K0407182		<i>Front bush</i>	
	1	Ø int.12 Ø ext.40 coll.48 long. tube int.54 ext.33 ep. coll.6	
		1.4i 16v. 06/06- 1.4 TFSi 11/07- 1.6 07/05- 1.8 TSi 06/07- 1.9 TDi 07/05- 2.0 FSi 07/05-05/10 2.0 TFSi 05/05- 2.0 TDi 07/05-	

... Leon ...



Eléments SUSPENSION
Suspension parts
Elementos suspensión
Elementy zawieszenie
Элементы подвески

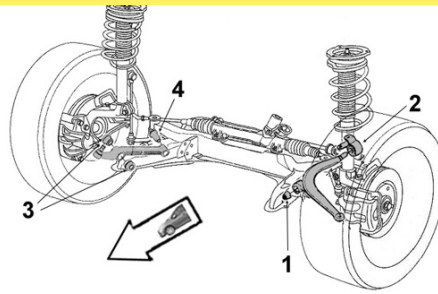

SEAT

SASIC

9001542

Articulation AR

OE 1J0407181

Rear bush

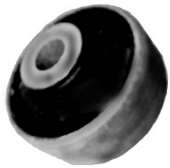

2 Ø int.13 Ø ext.59.5
 long. tube int.41 ext.23.5

1.4i 16v.
 1.6
 1.6i 16v.
 1.8i 20v. /Turbo
 1.9 SDi
 1.9 TDi
 2.8i V6 24v. 4WD

BVM BVA

04/00-09/05
 04/00-09/05
 04/00-09/05
 04/00-09/05
 04/00-09/05
 04/00-09/05
 01/01-09/05

2256003

Articulation AR G

OE 1K0199231J

Left rear bush



2

1.6i	BSE	09/05-05/09
1.9 TDi	BKC BXE	10/06-05/09
2.0 FSI	BLR BVY	09/05-05/09
2.0 TFSI	BWA	11/05-10/06
2.0 TDi	BKD	09/05-05/09

2256002

Articulation AR D

OE 1K0199232J

Right rear bush



2

1.6i	BSE	09/05-05/09
1.9 TDi	BKC BXE	10/06-05/09
2.0 FSI	BLR BVY	09/05-05/09
2.0 TFSI	BWA	11/05-10/06
2.0 TDi	BKD	09/05-05/09

Bras & Triangle de suspension

Control arm
Brazo y triángulo
Wahacz
Рычаг подвески

G/L D/R

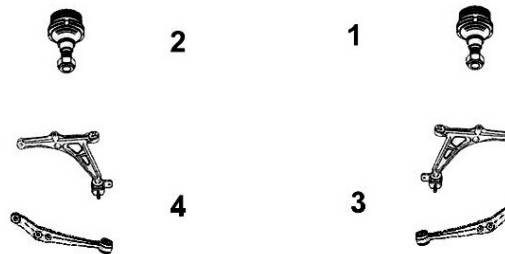

9005136

Triangle de susp. G/D

OE 1J0407151C

L/R track control arm



3 Sans rotule Without tie rod end

4 1.4i 16v.
 1.6
 1.6i 16v.
 1.8i 20v. /4WD Sauf Cupra
 1.9 SDi
 1.9 TDi
 2.8 V6 /4WD

-06/06
 -06/06
 -06/06
 -06/06
 -06/06
 -06/06
 01/01-05/02

9005757

Triangle de susp. G

OE 1K0407151AB

Left track control arm



4 acier steel Sans rotule Without tie rod end

1.4i	05/09-
1.4 TFSi	11/07-
1.6i	09/05-
1.8 TFSi	11/07-
1.9 TDi	09/05-
2.0 FSi	09/05-05/09
2.0 TFSi TSi	11/05-
2.0 TDi	09/05-

9005756

Triangle de susp. D

OE 1K0407152AB













Right track control arm



3 acier steel Sans rotule Without tie rod end

1.4i	05/09-
1.4 TFSi	11/07-
1.6i	09/05-
1.8 TFSi	11/07-
1.9 TDi	09/05-
2.0 FSi	09/05-05/09
2.0 TFSi TSi	11/05-
2.0 TDi	09/05-

... Leon ...

7476018 Triangle de susp. G OE 1K0407151AK <i>Left track control arm</i>	7476017 Triangle de susp. D OE 1K0407152BF <i>Right track control arm</i>
	
4 Fonte Iron Sans rotule Without tie rod end 1.4i 05/09- 1.4 TFSi 11/07- 1.6i 09/05- 1.8 TFSi 11/07- 1.9 TDi 09/05- 2.0 FSi 09/05-05/09 2.0 TFSi 11/05- 2.0 TSi 05/09- 2.0 TDi 09/05-	3 Fonte Iron Sans rotule Without tie rod end 1.4i 05/09- 1.4 TFSi 11/07- 1.6i 09/05- 1.8 TFSi 11/07- 1.9 TDi 09/05- 2.0 FSi 09/05-05/09 2.0 TFSi 11/05- 2.0 TSi 05/09- 2.0 TDi 09/05-
7476118 Triangle de susp. G OE 1J0407151C+1J0407365H <i>Left track control arm</i>	7476119 Triangle de susp. D OE 1J0407151C+1J0407366H <i>Right track control arm</i>
	
NEW 3 Avec rotule With ball joint 1.4i 16v. -06/06 1.6/i 16v. -06/06 1.8i 20v. /4WD -06/06 1.9 SDi -06/06 1.9 TDi /4WD -06/06 2.8 V6 01/01-05/02	NEW 4 Avec rotule With ball joint 1.4i 16v. -06/06 1.6/i 16v. -06/06 1.8i 20v. /4WD -06/06 1.9 SDi -06/06 1.9 TDi /4WD -06/06 2.8 V6 01/01-05/02
7476128 Triangle de susp. G OE 1K0407151AD+1K0407365C <i>Left track control arm</i>	7476127 Triangle de susp. D OE 1K0407152AD+1K0407366C <i>Right track control arm</i>
	
NEW 4 Avec rotule With ball joint 1.4i 05/09- 1.4 TFSi 11/07- 1.6i 09/05- 1.8 TFSi 11/07- 1.9 TDi 09/05- 2.0 FSi 09/05-05/09 2.0 TFSi 11/05-05/09 2.0 TSi 05/09- 2.0 TDi 09/05-	NEW 3 Avec rotule With ball joint 1.4i 05/09- 1.4 TFSi 11/07- 1.6i 09/05- 1.8 TFSi 11/07- 1.9 TDi 09/05- 2.0 FSi 09/05-05/09 2.0 TFSi 11/05-05/09 2.0 TSi 05/09- 2.0 TDi 09/05-
9005266 Rotule de susp. inf. G OE 1J0407365J <i>Left lower suspension ball joint</i>	9005267 Rotule de susp. inf. D OE 1J0407366J <i>Right lower suspension ball joint</i>
	
2 Axe Ø 18 pour triangle acier 1.4i 16v. -06/06 1.6 -06/06 1.6i 16v. -09/05 1.8i 20v. /4WD -06/06 1.9 SDi -06/06 1.9 TDi /4WD -06/06 2.8 V6 01/01-05/02	1 Axe Ø 18 pour triangle acier 1.4i 16v. -06/06 1.6 -06/06 1.6i 16v. -09/05 1.8i 20v. /4WD -06/06 1.9 SDi -06/06 1.9 TDi /4WD -06/06 2.8 V6 01/01-05/02
7576007 Rotule de susp. inf. G OE 3C0407365A <i>Left lower suspension ball joint</i>	7576005 Rotule de susp. inf. D OE 3C0407366A <i>Right lower suspension ball joint</i>
	
2 -ch 1P-6-102599 1.4i 05/09- 1.4 TFSi 11/07- 1.6i 09/05- 1.8 TFSi 06/07- 1.9 TDi 09/05- 2.0 FSi 09/05- 2.0 TFSi 11/05- 2.0 TDi 09/05-	1 -ch 1P-6-102599 1.4i 05/09- 1.4 TFSi 11/07- 1.6i 09/05- 1.8 TFSi 06/07- 1.9 TDi 09/05- 2.0 FSi 09/05- 2.0 TFSi 11/05- 2.0 TDi 09/05-
9005570 Rotule de susp. inf. G OE 1K0407365C <i>Left lower suspension ball joint</i>	9005569 Rotule de susp. inf. D OE 1K0407366C <i>Right lower suspension ball joint</i>
	
2 1.4 05/99- Ch- 1P6102599 1.4 TFSi 1.6i 1.8 TFSi 1.9 TDi 2.0 FSi 2.0 TSi 2.0 TFSi -05/09 2.0 TDi	1 1.4 05/99- Ch- 1P6102599 1.4 TFSi 1.6i 1.8 TFSi 1.9 TDi 2.0 FSi 2.0 TSi 2.0 TFSi -05/09 2.0 TDi

... Leon ...









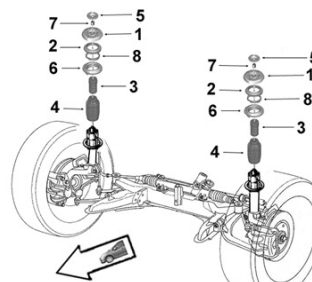

SASIC

SEAT

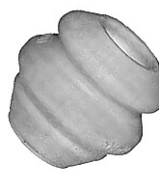

Support d'amortisseur
Suspension mounting
Soporte amortiguador
Poduszka amortyzatora
Опора амортизатора



<p>9005614 OE 1J0412331C</p> 	<p>Tampon suspension AV G/D <i>L/R front suspension rebound stop</i></p> <p>1</p> <table border="0"> <tr><td>1.4i 16v.</td><td>04/00-09/05</td></tr> <tr><td>1.6</td><td>04/00-09/05</td></tr> <tr><td>1.6i 16v.</td><td>04/00-09/05</td></tr> <tr><td>1.8i 20v. /Turbo</td><td>04/00-09/05</td></tr> <tr><td>1.9 SDi</td><td>04/00-09/05</td></tr> <tr><td>1.9 TDi</td><td>04/00-09/05</td></tr> <tr><td>2.8i V6 24v. /4WD</td><td>01/01-09/05</td></tr> </table>	1.4i 16v.	04/00-09/05	1.6	04/00-09/05	1.6i 16v.	04/00-09/05	1.8i 20v. /Turbo	04/00-09/05	1.9 SDi	04/00-09/05	1.9 TDi	04/00-09/05	2.8i V6 24v. /4WD	01/01-09/05	<p>9005622 OE 1K0412331B</p> 	<p>Support suspension G/D <i>L/R suspension mounting</i></p> <p>1</p> <table border="0"> <tr><td>1.6</td><td>09/05-05/09</td></tr> <tr><td>1.9 TDi</td><td>10/06-05/09</td></tr> <tr><td>2.0 FSi</td><td>09/05-05/09</td></tr> <tr><td>2.0 TFSi</td><td>09/05-05/09</td></tr> <tr><td>2.0 TDi</td><td>09/05-05/09</td></tr> </table>	1.6	09/05-05/09	1.9 TDi	10/06-05/09	2.0 FSi	09/05-05/09	2.0 TFSi	09/05-05/09	2.0 TDi	09/05-05/09														
1.4i 16v.	04/00-09/05																																								
1.6	04/00-09/05																																								
1.6i 16v.	04/00-09/05																																								
1.8i 20v. /Turbo	04/00-09/05																																								
1.9 SDi	04/00-09/05																																								
1.9 TDi	04/00-09/05																																								
2.8i V6 24v. /4WD	01/01-09/05																																								
1.6	09/05-05/09																																								
1.9 TDi	10/06-05/09																																								
2.0 FSi	09/05-05/09																																								
2.0 TFSi	09/05-05/09																																								
2.0 TDi	09/05-05/09																																								
<p>9005352 OE 1J0412249</p> 	<p>Butée à billes G/D <i>L/R ball bearing</i></p> <p>2</p> <table border="0"> <tr><td>1.4i 16v.</td><td>04/00-09/05</td></tr> <tr><td>1.6</td><td>04/00-09/05</td></tr> <tr><td>1.6i 16v.</td><td>04/00-09/05</td></tr> <tr><td>1.8i 20v. /Turbo</td><td>04/00-09/05</td></tr> <tr><td>1.9 SDi</td><td>04/00-09/05</td></tr> <tr><td>1.9 TDi</td><td>04/00-09/05</td></tr> <tr><td>2.8i V6 24v. 4WD</td><td>01/01-09/05</td></tr> </table>	1.4i 16v.	04/00-09/05	1.6	04/00-09/05	1.6i 16v.	04/00-09/05	1.8i 20v. /Turbo	04/00-09/05	1.9 SDi	04/00-09/05	1.9 TDi	04/00-09/05	2.8i V6 24v. 4WD	01/01-09/05	<p>2656004 OE 1K0412303E</p> 	<p>Butée de suspension <i>Shock bush</i></p> <p>3</p> <table border="0"> <tr><td>H55</td><td></td></tr> <tr><td>1.2 TSi</td><td>02/10-</td></tr> <tr><td>1.6i BVM</td><td>09/05-05/09</td></tr> <tr><td>1.6 TDi</td><td>02/10-</td></tr> <tr><td>1.9 TDi BVM</td><td>10/06-05/09</td></tr> <tr><td>2.0 TFSi</td><td>09/05-</td></tr> <tr><td>2.0 TDi</td><td>07/05-</td></tr> </table>	H55		1.2 TSi	02/10-	1.6i BVM	09/05-05/09	1.6 TDi	02/10-	1.9 TDi BVM	10/06-05/09	2.0 TFSi	09/05-	2.0 TDi	07/05-										
1.4i 16v.	04/00-09/05																																								
1.6	04/00-09/05																																								
1.6i 16v.	04/00-09/05																																								
1.8i 20v. /Turbo	04/00-09/05																																								
1.9 SDi	04/00-09/05																																								
1.9 TDi	04/00-09/05																																								
2.8i V6 24v. 4WD	01/01-09/05																																								
H55																																									
1.2 TSi	02/10-																																								
1.6i BVM	09/05-05/09																																								
1.6 TDi	02/10-																																								
1.9 TDi BVM	10/06-05/09																																								
2.0 TFSi	09/05-																																								
2.0 TDi	07/05-																																								
<p>2656052 OE 1K0412303B</p> 	<p>Butée de suspension <i>Shock bush</i></p> <p>3</p> <table border="0"> <tr><td>H70</td><td></td></tr> <tr><td>1.2 TSi</td><td>03/10-</td></tr> <tr><td>1.4i/TFSi</td><td>05/09-</td></tr> <tr><td>1.6i</td><td>09/05-</td></tr> <tr><td>1.6 TDi</td><td>01/10-</td></tr> <tr><td>1.8 TFSi</td><td>11/07-</td></tr> <tr><td>1.9 TDi</td><td>09/05-</td></tr> <tr><td>2.0 FSi</td><td>09/05-05/09</td></tr> <tr><td>2.0 TFSi</td><td>11/05-</td></tr> <tr><td>2.0 TSi</td><td>05/09-</td></tr> <tr><td>2.0 TDi</td><td>09/05-</td></tr> </table>	H70		1.2 TSi	03/10-	1.4i/TFSi	05/09-	1.6i	09/05-	1.6 TDi	01/10-	1.8 TFSi	11/07-	1.9 TDi	09/05-	2.0 FSi	09/05-05/09	2.0 TFSi	11/05-	2.0 TSi	05/09-	2.0 TDi	09/05-	<p>9005338 OE 1H0412303B</p> 	<p>Butée de suspension <i>Shock bush</i></p> <p>3</p> <table border="0"> <tr><td>H64</td><td></td></tr> <tr><td>1.4i 16v.</td><td>04/00-09/05</td></tr> <tr><td>1.6</td><td>04/00-09/05</td></tr> <tr><td>1.6i 16v.</td><td>04/00-09/05</td></tr> <tr><td>1.8i 20v. /Turbo</td><td>04/00-09/05</td></tr> <tr><td>1.9 SDi</td><td>04/00-09/05</td></tr> <tr><td>1.9 TDi</td><td>04/00-09/05</td></tr> </table>	H64		1.4i 16v.	04/00-09/05	1.6	04/00-09/05	1.6i 16v.	04/00-09/05	1.8i 20v. /Turbo	04/00-09/05	1.9 SDi	04/00-09/05	1.9 TDi	04/00-09/05		
H70																																									
1.2 TSi	03/10-																																								
1.4i/TFSi	05/09-																																								
1.6i	09/05-																																								
1.6 TDi	01/10-																																								
1.8 TFSi	11/07-																																								
1.9 TDi	09/05-																																								
2.0 FSi	09/05-05/09																																								
2.0 TFSi	11/05-																																								
2.0 TSi	05/09-																																								
2.0 TDi	09/05-																																								
H64																																									
1.4i 16v.	04/00-09/05																																								
1.6	04/00-09/05																																								
1.6i 16v.	04/00-09/05																																								
1.8i 20v. /Turbo	04/00-09/05																																								
1.9 SDi	04/00-09/05																																								
1.9 TDi	04/00-09/05																																								
<p>2656003 OE 1J0412303</p> 	<p>Butée de suspension <i>Shock bush</i></p> <p>3</p> <table border="0"> <tr><td>H53</td><td></td></tr> <tr><td>1.4i 16v. Sport</td><td>BVM 04/00-09/05</td></tr> <tr><td>1.6i Sport</td><td>04/00-09/00</td></tr> <tr><td>1.6i 16v. Sport</td><td>BVM 09/00-09/05</td></tr> <tr><td>1.8i 20v. Sport</td><td>09/00-09/05</td></tr> <tr><td>1.8i 20v. Turbo Sport</td><td>BVM 04/00-09/05</td></tr> <tr><td>1.9 SDi Sport</td><td>BVM 04/00-06/03</td></tr> <tr><td>1.9 TDi /4WD Sport</td><td>BVM 04/00-09/05</td></tr> <tr><td>2.8i V6 24v. 4WD Sport/VR6 24v. Sport</td><td>BVM 01/01-05/02</td></tr> </table>	H53		1.4i 16v. Sport	BVM 04/00-09/05	1.6i Sport	04/00-09/00	1.6i 16v. Sport	BVM 09/00-09/05	1.8i 20v. Sport	09/00-09/05	1.8i 20v. Turbo Sport	BVM 04/00-09/05	1.9 SDi Sport	BVM 04/00-06/03	1.9 TDi /4WD Sport	BVM 04/00-09/05	2.8i V6 24v. 4WD Sport/VR6 24v. Sport	BVM 01/01-05/02	<p>9005334 OE 1K0412303F</p> 	<p>Butée de suspension <i>Shock bush</i></p> <p>3</p> <table border="0"> <tr><td>H55</td><td></td></tr> <tr><td>2.0 FSi</td><td>09/05-05/09</td></tr> <tr><td>2.0 TFSi</td><td>09/05-05/09</td></tr> <tr><td>2.0 TDi</td><td>09/05-05/09</td></tr> </table>	H55		2.0 FSi	09/05-05/09	2.0 TFSi	09/05-05/09	2.0 TDi	09/05-05/09												
H53																																									
1.4i 16v. Sport	BVM 04/00-09/05																																								
1.6i Sport	04/00-09/00																																								
1.6i 16v. Sport	BVM 09/00-09/05																																								
1.8i 20v. Sport	09/00-09/05																																								
1.8i 20v. Turbo Sport	BVM 04/00-09/05																																								
1.9 SDi Sport	BVM 04/00-06/03																																								
1.9 TDi /4WD Sport	BVM 04/00-09/05																																								
2.8i V6 24v. 4WD Sport/VR6 24v. Sport	BVM 01/01-05/02																																								
H55																																									
2.0 FSi	09/05-05/09																																								
2.0 TFSi	09/05-05/09																																								
2.0 TDi	09/05-05/09																																								
<p>9005327 OE 357413175A</p> 	<p>Protecteur amortisseur G/D <i>L/R shock absorber protector</i></p> <p>4</p> <table border="0"> <tr><td>H221.5</td><td></td></tr> <tr><td>1.4i 16v.</td><td>04/00-09/05</td></tr> <tr><td>1.6/i 16v.</td><td>04/00-09/05</td></tr> <tr><td>1.8i 20v. /Turbo</td><td>04/00-09/05</td></tr> <tr><td>1.9 SDi</td><td>04/00-09/05</td></tr> <tr><td>1.9 TDi</td><td>04/00-09/05</td></tr> <tr><td>2.8i V6 24v. 4WD</td><td>01/01-09/05</td></tr> </table>	H221.5		1.4i 16v.	04/00-09/05	1.6/i 16v.	04/00-09/05	1.8i 20v. /Turbo	04/00-09/05	1.9 SDi	04/00-09/05	1.9 TDi	04/00-09/05	2.8i V6 24v. 4WD	01/01-09/05	<p>2656053 OE 6N0413175A</p> 	<p>Protecteur amortisseur G/D <i>L/R shock absorber protector</i></p> <p>4</p> <table border="0"> <tr><td>H206</td><td></td></tr> <tr><td>1.2 TSi</td><td>03/10-</td></tr> <tr><td>1.4i</td><td>05/09-</td></tr> <tr><td>1.4 TFSi</td><td>11/07-</td></tr> <tr><td>1.6i</td><td>09/05-</td></tr> <tr><td>1.6 TDi</td><td>01/10-</td></tr> <tr><td>1.8 TFSi</td><td>11/07-</td></tr> <tr><td>1.9 TDi</td><td>09/05-</td></tr> <tr><td>2.0 FSi</td><td>09/05-05/09</td></tr> <tr><td>2.0 TFSi</td><td>11/05-</td></tr> <tr><td>2.0 TSi</td><td>05/09-</td></tr> <tr><td>2.0 TDi</td><td>09/05-</td></tr> </table>	H206		1.2 TSi	03/10-	1.4i	05/09-	1.4 TFSi	11/07-	1.6i	09/05-	1.6 TDi	01/10-	1.8 TFSi	11/07-	1.9 TDi	09/05-	2.0 FSi	09/05-05/09	2.0 TFSi	11/05-	2.0 TSi	05/09-	2.0 TDi	09/05-
H221.5																																									
1.4i 16v.	04/00-09/05																																								
1.6/i 16v.	04/00-09/05																																								
1.8i 20v. /Turbo	04/00-09/05																																								
1.9 SDi	04/00-09/05																																								
1.9 TDi	04/00-09/05																																								
2.8i V6 24v. 4WD	01/01-09/05																																								
H206																																									
1.2 TSi	03/10-																																								
1.4i	05/09-																																								
1.4 TFSi	11/07-																																								
1.6i	09/05-																																								
1.6 TDi	01/10-																																								
1.8 TFSi	11/07-																																								
1.9 TDi	09/05-																																								
2.0 FSi	09/05-05/09																																								
2.0 TFSi	11/05-																																								
2.0 TSi	05/09-																																								
2.0 TDi	09/05-																																								

... Leon ...



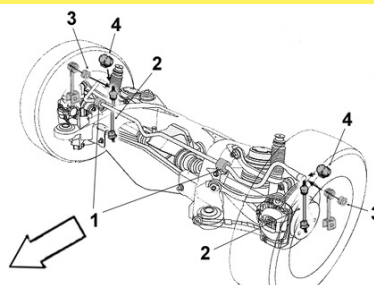

Barre stabilisatrice
 Stabilizer bar
 Barra estabilizadora
 Drażek stabilizatora
 стабилизатор поперечной устойчивости



SEAT



9005094 OE 1K0505465K	Biellette barre stab. <i>Stabilizer bar stub axle</i>	2306009 OE 1J0505466B	Biellette barre stab. <i>Stabilizer bar stub axle</i>
	2 1.2 TSi 02/10- 1.4i 16v. 06/06- 1.4 TFSi 11/07- 1.6i 07/05- 1.6 TDi 02/10- 1.8 TSi 06/07- 1.9 TDi 07/05- 2.0 FSi 07/05-05/10 2.0 TFSi 07/05- 2.0 TDi 07/05-		2 1.8i 20v. Turbo 4WD 180hp 132kw BVM 04/00-06/03 1.9 TDi 4WD 150hp 110kw BVM 01/01-09/05 2.8i V6 24v. 4WD 205hp 150kw BVM 01/01-05/02 2.8i VR6 24v. 205hp 150kw BVM 01/01-05/02

9001737 OE 1K0511327AR	Palier de barre milieu <i>Middle bar main bearing</i>		
	1 Barre Ø 20.7 1.2 TSi 1.4i 16v. 1.4 TFSi 1.6i 1.6 TDi 1.8i TSi 1.9 TDi 2.0 FSi 2.0 TFSi TSi 2.0 TDi		02/10- 06/06- 11/07- 07/05- 02/10- 06/07- 07/05- 07/05-05/10 05/05- 07/05-

2306014 OE 1K0511327AS	Palier de barre milieu <i>Middle bar main bearing</i>		
	1 Barre Ø 21.7 1.4i 16v. 1.4 TFSi 1.6i 1.8 TSi 1.9 TDi 2.0 FSi 2.0 TFSi 2.0 TDi		06/06- 12/07- 09/05- 06/07- 07/05- 09/05-05/09 05/05- 09/05-



Support d'amortisseur
 Suspension mounting
 Soporte amortiguador
 Poduszka amortyzatora
 Опора амортизатора

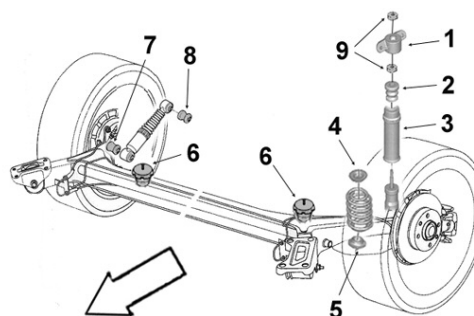

9005630 OE 1J0513353B	Support suspension G/D <i>L/R suspension mounting</i>		
	1 1.4i 16v. 1.6 1.6i 16v. 1.8i 20v. 1.9 SDi 1.9 TDi	BVM BVA	04/00-09/05 04/00-09/05 04/00-09/05 04/00-09/05 04/00-09/05 04/00-09/05

... Leon

Eléments TRAIN ARRIERE

Rear axle parts

Tren TRAS

Elementy zawieszenia tylnego

элементы задней оси.



SASIC

SEAT

2606001

Articulation traverse

OE 6R0501541A

Cross bar bush



Ø int. 12 Ø ext. 71.5 coll. 80
long. tube int. 90 ext. 54.5

1.4i 16v. BVM 04/00-09/05
1.6i 04/00-09/00
1.6i 16v. BVM 09/00-09/05
1.8i 20v. sauf cupra 04/00-06/03
1.8i 20v. Turbo BVM 04/00-09/05
1.9 SDi BVM 04/00-06/03
1.9 TDi BVM 04/00-09/05

9001786

Articulation essieu G/D inf.

OE 1K0505553A

Lower L/R axle bush



Ø int. 12 Ø ext. 37 long. tube int. 50 ext. 28

1.4i 16v. 06/06-
1.4 TFSi 11/07-
1.6 07/05-
1.8 TSi 06/07-
1.9 TDi 07/05-
2.0 FSi 07/05-05/10
2.0 TFSi 09/05-05/09
2.0 TDi 07/05-

Malaga

Eléments DIRECTION

Steering parts

Elementos Direcciones

Elementy uklad kierowniczy

Элементы рулевой системы

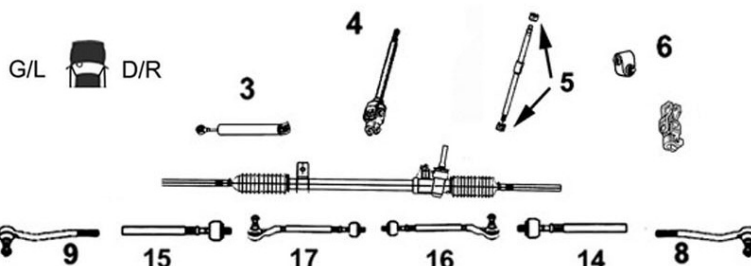

9006262

Axe de bielle G/D

OE SE022162449B

L/R axial joint



14 Côté dir. M14x1.5
15 Côté rot. M12x1.5 long 275 mm

TT /all models 07/86-12/92

9006333

Rotule de direction G/D

OE SE022162406A

L/R tie rod end



8 M12 x 1.5
9

TT /all models 09/85-12/92

Bras & Triangle de suspension

Control arm

Brazo y triángulo

Wahacz

Рычаг подвески

G/L D/R

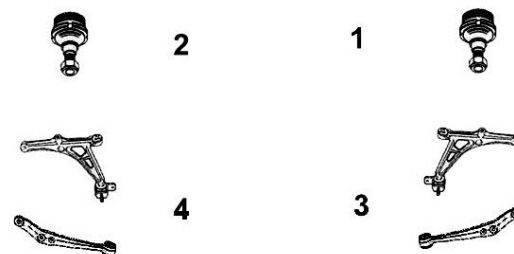

9005130

Bras de suspension G/D

OE SE021156110A

L/R track control arm



3 Avec rotule With ball joint
4 Avec rotule With ball joint Axe lisse Ø 15

TT /all models 07/86-12/88

9005131

Bras de suspension G/D

OE SE021156110B

L/R track control arm



3 Avec rotule With ball joint
4 Avec rotule With ball joint Axe lisse Ø 17

TT /all models 12/88-12/92

Marbella

Eléments DIRECTION

Steering parts

Elementos Direcciones

Elementy układ kierowniczy

Элементы рулевой системы

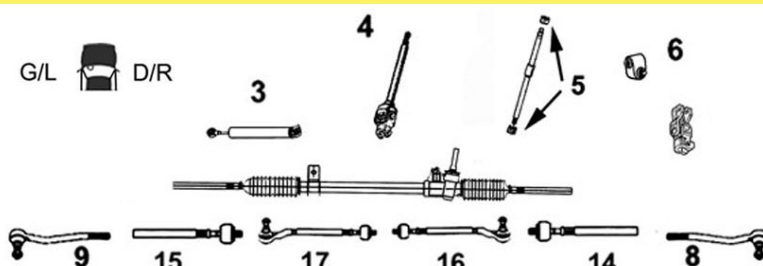

9006264

Axe de bielle G/D

Part/oe 141162449A L/R axial joint



14 Côté dir. M14x1.5
15 Côté rot. M12x1.5 long 192 mm

TT /all models 10/82-

9006332

Rotule de direction G/D

OE SE141162410A L/R tie rod end



8 M12 x 1.5
9

TT /all models 10/82-

Bras & Triangle de suspension

Control arm

Brazo y triángulo

Wahacz

Рычаг подвески

G/L D/R

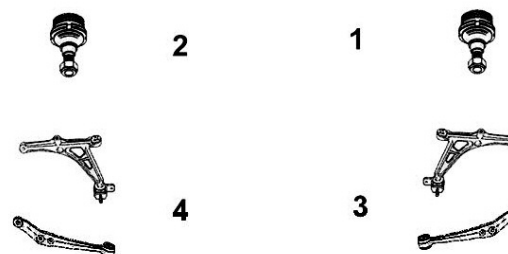

9005107

Bras de suspension G/D

OE SE141156110A L/R track control arm



3 Sans rotule Without tie rod end
4

TT /all models

01/80-

7576001

Rotule de susp. inf. G/D

OE - L/R lower suspension ball joint



1
2

TT /all models Sans support

01/80-

9005230

Rotule de susp. inf. G/D

OE 004402649 L/R lower suspension ball joint



1
2

TT /all models Sans support

01/80-

Mii ...

SASIC

SEAT



Barre stabilisatrice
 Stabilizer bar
 Barra estabilizadora
 Drażek stabilizatora
 стабилизатор поперечной устойчивости

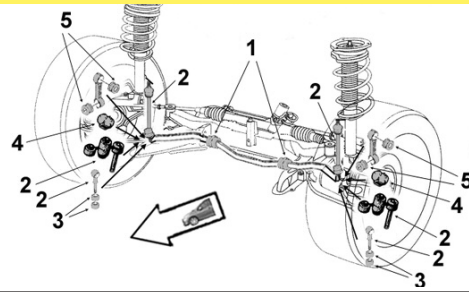

2306017 **Palier de barre milieu**
 OE 6Q0411314P *Middle bar main bearing*

NEW



1 Barre Ø 18

1.0i



Eléments SUSPENSION
 Suspension parts
 Elementos suspensión
 Elementy zawieszenie
 Элементы подвески

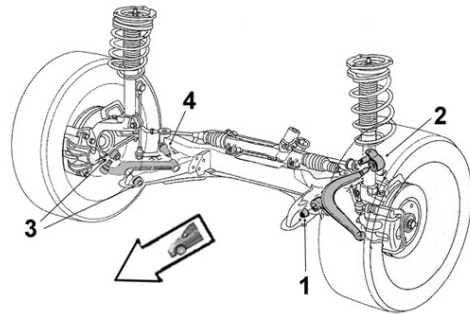

9001523 **Articulation AV**
 OE 357407182 *Front bush*



1 Ø int.12 Ø ext.33 coll.36
 long. tube int.54 ext.29 ep. coll.5

1.0i

9001542 **Articulation AR**
 OE 1J0407181 *Rear bush*



2 Ø int.13 Ø ext.59.5
 long. tube int.41 ext.23.5

1.0i

Bras & Triangle de suspension

Control arm
 Brazo y triángulo
 Wahacz
 Рычаг подвески

G/L  D/R



7576019 **Rotule de susp. inf. G**
 OE 6R0407365A *Left lower suspension ball joint*

NEW



2

1.0i CHYA /B BVM 11/11-

7576020 **Rotule de susp. inf. D**
 OE 6R0407366A *Right lower suspension ball joint*

NEW



1

1.0i CHYA /B BVM 11/11-

... Mii



Support d'amortisseur
 Suspension mounting
 Soporte amortiguador
 Poduszka amortyzatora
 Опора амортизатора

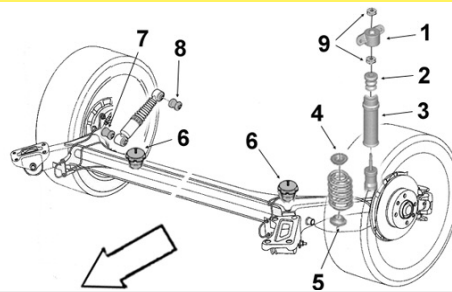

2656062

Bague palier susp.

OE 1S0512335A

bearing ring suspension



9 Ø int. 15.8 Ø ext. 41 long. tube int.27 ext.24.3

1.0i

Eléments TRAIN ARRIERE

Rear axle parts
 Tren TRAS
 Elementy zawieszenia tylnego
 элементы задней оси.



2606005

Articulation essieu AR

OE 1S0501541B

Rear axle bush



Ø int.10 Ø ext.58 coll.74
 long. tube int. 64 ext. 41 ep coll. 15.3

1.0i

Toledo...

Eléments DIRECTION

Steering parts
 Elementos Direcciones
 Elementy uklad kierowniczy
 Элементы рулевой системы

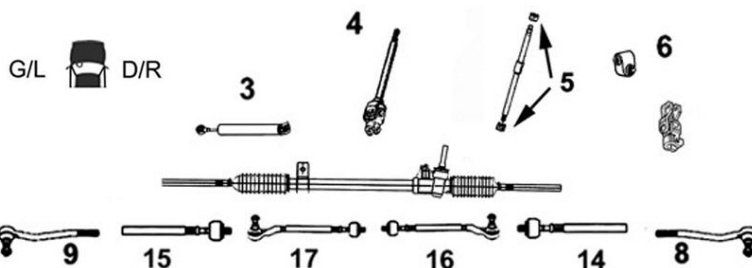

9006210

Axe de bielle G/D

Part/oe 191419803

L/R axial joint



14 Côté dir. M22x1.5
15 Côté rot. M14x1.5 long 368 mm

TT /all models DNA 01/91-

9006218

Axe de bielle G/D

Part/oe 1H0422803A

L/R axial joint



14 Côté dir. M14x1.5
15 Côté rot. M14x1.5 long 371 mm

TT /all models DA 01/91-

7776079

Axe de bielle G/D

Part/oe 6R0423803A

L/R axial joint



14 Côté dir. M14x1.5
15 Côté rot. M14x1.5 long 310 mm

1.2i 06/12-
 1.2 TSi 06/12-
 1.4 TSi 06/12-
 1.6 TDi 06/12-

9006219

Axe de bielle G/D

Part/oe 1J0422803H

L/R axial joint



14 Côté dir. M16x1.5
15 Côté rot. M14x1.5 long 320 mm

1.6i 04/99-09/00
 1.6i 16v. 09/00-09/04
 1.8i 20v. /Turbo 04/99-09/04
 1.9 TDi 04/99-09/04
 2.3i 20v. 04/99-05/02

Toledo ...

Éléments DIRECTION

Steering parts

Elementos Direcciones

Elementy układ kierowniczy

Элементы рулевой системы

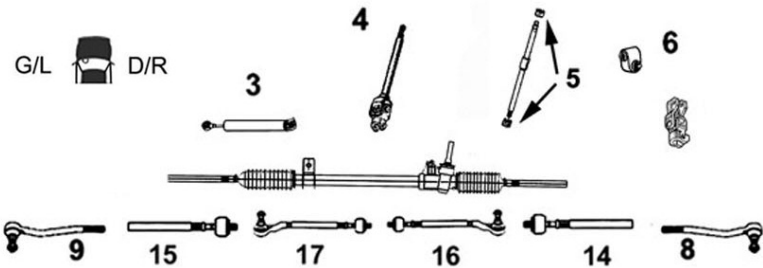

9006873

Axe de bielle G/D

OE 1K0423810A

L/R axial joint



14
15

Côté dir. M16x1.5 Côté rot. M16x1.5 long 310 mm

1.6i
1.9 TDi
2.0 FSi
2.0 TDi

09/04-
09/04-
09/04-
09/04-

9006380

Rotule de direction G

OE 3A0422811

Left tie rod end



9

M14 x 1.5

TT /all models DNA DA
01/91-03/99

9006381

Rotule de direction D

OE 191419812

Right tie rod end



8

M14 x 1.5

TT /all models DNA DA
01/91-03/99

9006634

Rotule de direction G

OE 1J0422812B

Left tie rod end



9

M14 x 1.5

TT/all models Dir. TRW 04/99-

1.2 i 06/12-
1.2 TSi 06/12-
1.4 TSi 06/12-
1.6 TDi FAP 06/12-

9006635

Rotule de direction D

OE 1J0422811B

Right tie rod end



8

M14 x 1.5

TT/all models Dir. TRW 04/99-

1.2 i 06/12-
1.2 TSi 06/12-
1.4 TSi 06/12-
1.6 TDi FAP 06/12-

9006638

Rotule de direction G

OE 1K0423811J

Left tie rod end



9

M16 x 1.5

1.6 09/04-
1.9 TDi 09/04-
2.0 FSi 09/04-
2.0 TDi 09/04-

9006637

Rotule de direction D

OE 1K0423812J

Right tie rod end



8

M16 x 1.5

1.6 09/04-
1.9 TDi 09/04-
2.0 FSi 09/04-
2.0 TDi 09/04-

... Toledo ...



Barre stabilisatrice
 Stabilizer bar
 Barra estabilizadora
 Drażek stabilizatora
 стабилизатор поперечной устойчивости

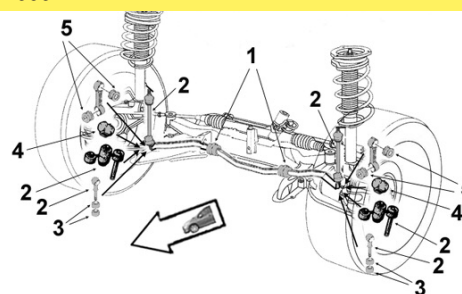

SEAT



9005050 OE 191411315B	Biellette barre stab. <i>Stabilizer bar stub axle</i>	9005084 OE 1J0411315J	Biellette barre stab. <i>Stabilizer bar stub axle</i>
	2 Ø int.17 -ch 1L-ZD320000 1.6 01/91- 1.8 01/91- 1.9 D 01/91- 1.9 TD 01/91- 2.0 01/91-		2 Barre Ø 21 1.6i 16v. 04/99- 1.9 SDi 04/99- 1.9 TDi 04/99-
9005093 OE 1J0411315K	Biellette barre stab. <i>Stabilizer bar stub axle</i>	9005090 OE 1J0411315G	Biellette barre stab. <i>Stabilizer bar stub axle</i>
	2 Barre Ø 23 1.6 04/99- 1.6i 16v. 09/00- 1.8i 20v. /Turbo 04/99- 1.9 TDi 04/99- 2.3i VR5 20v. 04/99-		2 Barre Ø 23 1.6i 16v. 04/99- 1.9 SDi 04/99- 1.9 TDi 04/99-
2306007 OE 1J0411315D	Biellette barre stab. G <i>Left stabilizer bar stub axle</i>	2306008 OE 1J0411316D	Biellette barre stab. D <i>Right stabilizer bar stub axle</i>
	2 1.6i 04/99-09/00 1.6i 16v. BVM 09/00-09/04 1.8i 20v. 04/99-09/04 1.8i 20v. Turbo BVM 05/02-09/04 1.9 TDi BVM 04/99-04/04 2.3i VR5 20v. BVM 04/99-05/02		2 1.6i 04/99-09/00 1.6i 16v. BVM 09/00-09/04 1.8i 20v. 04/99-09/04 1.8i 20v. Turbo BVM 05/02-09/04 1.9 TDi BVM 04/99-04/04 2.3i VR5 20v. BVM 04/99-05/02
2306010 OE 1K0411315P	Biellette barre stab. <i>Stabilizer bar stub axle</i>	9005018 OE 1J0411327	Liaison élastique <i>Elastic link</i>
	2 1.6i BVM 09/04- 1.9 TDi BVM 09/04- 2.0 FSi 09/04- 2.0 TDi 16v. 09/04-		5 Ø int.14.5 ext. Ø29 coll.35 x2 long. tube int.22.5 ext.18 ep. coll.2 x2 1.6 04/99- 1.8i 20v. 04/99- 1.9 TDi 04/99- 2.3i VR5 20v. 04/99-
9001522 OE 191411314	Palier de barre milieu <i>Middle bar main bearing</i>	2306019 OE 6Q0411314R	Palier de barre milieu <i>Middle bar main bearing</i>
	1 Barre Ø 17 1.8 01/96-05/98 1.9 D 01/96-05/98 1.9 TDi 01/96-05/98 2.0 01/96-05/98 2.0i 16v. 01/96-05/98		1 Barre Ø 18 1.2i /TSi 06/12- 1.4 TSi 06/12- 1.6 TDi 06/12-

... Toledo ...



Barre stabilisatrice
 Stabilizer bar
 Barra estabilizadora
 Drażek stabilizatora
 стабилизатор поперечной устойчивости

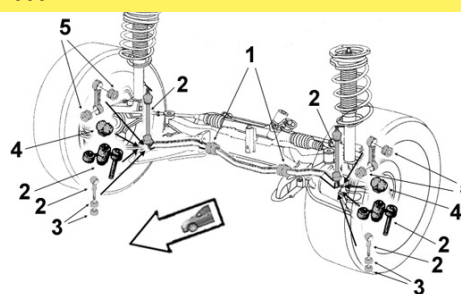

2306018 **Palier de barre milieu**
 OE 6Q0411314Q *Middle bar main bearing*



1 Barre Ø 19

1.2i /TSi	06/12-
1.4 TSi	06/12-
1.6 TDi	06/12-

9001730 **Palier de barre milieu**
 OE 1J0411314R *Middle bar main bearing*



1 Barre Ø 21

1.6	04/99-
1.6i 16v.	04/99-
1.8i 20v. /Turbo	04/99-
1.9 SDi	04/99-
1.9 TDi	04/99-
2.3i VR5 20v.	04/99-

9001732 **Palier de barre milieu**
 OE 1J0411314T *Middle bar main bearing*

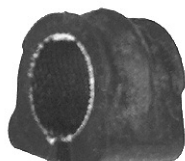

1 Barre Ø 23

1.6	09/99-
1.6i 16v.	09/00-
1.8i 20v. /Turbo	04/99-
1.9 SDi	04/99-
1.9 TDi	04/99-
2.3i VR5 20v.	04/99-



Eléments SUSPENSION
 Suspension parts
 Elementos suspensión
 Elementy zawieszenie
 Элементы подвески

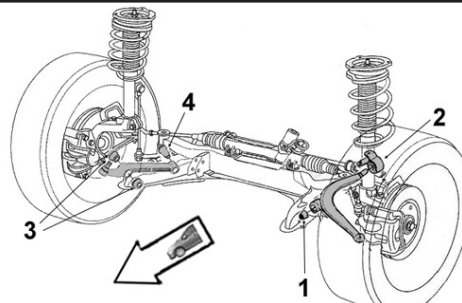

9001523 **Articulation AV**
 OE 357407182 *Front bush*



**1 Ø int.12 Ø ext.33 coll.36
 long. tube int.54 ext.29 ep. coll.5**

1.2i /TSi	06/12-
1.4 TSi	06/12-
1.6	04/99-
1.6i 16v.	01/91-
1.6 TDi	06/12-
1.8/i 16v.	01/91-
1.8i 20v. /Turbo	04/99-
1.9 D TD TDi	01/91-
1.9 SDi	04/99-
2.0 /i 16v.	01/91-
2.3i VR5 20v.	04/99-

9001520 **Articulation AR**
 OE 191407181E *Rear bush*



**2 Ø int.17 Ø ext.60.5
 long. tube int.41 ext.24.5**

1.6	01/91-04/99
1.8	01/91-04/99
1.8i 16v.	01/91-04/99
1.9 D	01/91-04/99
1.9 TD	01/91-04/99
1.9 TDi	01/91-04/99
2.0	01/91-04/99
2.0i 16v.	01/91-04/99

9001542 **Articulation AR**
 OE 1J0407181 *Rear bush*



**2 Ø int.13 Ø ext.59.5
 long. tube int.41 ext.23.5**

1.2i /TSi	06/12-
1.4 TSi	06/12-
1.6/i 16v.	04/99-
1.6 TDi	06/12-
1.8i 20v. /Turbo	04/99-
1.9 SDi TDi	04/99-
2.3i VR5 20v.	04/99-













9001759 **Articulation AV**
 OE 1K0407182 *Front bush*



**1 Ø int.12 Ø ext.40 coll.48
 long. tube int.54 ext.33 ep. coll.6**

1.6	09/04-
1.9 TDi	09/04-
2.0 FSi 16v.	09/04-
2.0 TDi 16v.	09/04-

... Toledo ...

2256003 OE 1K0199231J	Articulation AR G <i>Left rear bush</i>	2256002 OE 1K0199232J	Articulation AR D <i>Right rear bush</i>
	2		2
	1.6i 10/04-05/09 1.9 TDi 10/04- 2.0 FSi 10/04- 2.0 TDi 10/04-05/09		1.6i 10/04-05/09 1.9 TDi 10/04- 2.0 FSi 10/04- 2.0 TDi 10/04-05/09
Bras & Triangle de suspension <i>Control arm</i> <i>Brazo y triángulo</i> <i>Wahacz</i> <i>Рычаг подвески</i>		G/L  D/R	
9005133 OE 191407151B	Triangle de susp. G/D <i>L/R track control arm</i>	9005136 OE 1J0407151C	Triangle de susp. G/D <i>L/R track control arm</i>
	3 4		3 4
	Sans rotule <i>Without tie rod end</i> TT /all models 01/91-03/99 Sauf 2.0 16v.		Sans rotule <i>Without tie rod end</i> TT /all models 04/99-
9005753 OE 1H0407151A	Triangle de susp. G <i>Left track control arm</i>	9005754 OE 1H0407152	Triangle de susp. D <i>Right track control arm</i>
	4		3
	Sans rotule <i>Without tie rod end</i> 2.0i 16v. 01/96-03/99		Sans rotule <i>Without tie rod end</i> 2.0i 16v. 01/96-03/99
7476018 OE 1K0407151AD	Triangle de susp. G <i>Left track control arm</i>	7476017 OE 1K0407152AD	Triangle de susp. D <i>Right track control arm</i>
	4		3
	Fonte Iron Sans rotule <i>Without tie rod end</i> 1.9 TDi 09/04-05/09 2.0 TDi 16v. 09/04-05/09		Fonte Iron Sans rotule <i>Without tie rod end</i> 1.9 TDi 09/04-05/09 2.0 TDi 16v. 09/04-05/09
9005757 OE 1K0407151AB	Triangle de susp. G <i>Left track control arm</i>	9005756 OE 1K0407152AB	Triangle de susp. D <i>Right track control arm</i>
	4		3
	acier steel Sans rotule <i>Without tie rod end</i> 1.6i 09/04-05/09 1.9 TDi 09/04-05/09 2.0 FSi 09/04-05/09 2.0 TDi 09/04-05/09		acier steel Sans rotule <i>Without tie rod end</i> 1.6i 09/04-05/09 1.9 TDi 09/04-05/09 2.0 FSi 09/04-05/09 2.0 TDi 09/04-05/09

SEAT



...Toledo...

SASIC

SEAT

Bras & Triangle de suspension











Control arm
Brazo y triángulo
Wahacz
Рычаг подвески

G/L  D/R



7476091 OE 6R0407151F Triangle de susp. inf. G <i>Lower left track control arm</i>	7476092 OE 6R0407152F Triangle de susp. inf. D <i>Lower right track control arm</i>
 	 
4 Sans rotule Without tie rod end 1.2i 06/12- 1.2 TSi 06/12- 1.4 TSi 06/12- 1.6 TDi 06/12-	3 Sans rotule Without tie rod end 1.2i 06/12- 1.2 TSi 06/12- 1.4 TSi 06/12- 1.6 TDi 06/12-
7476107 OE 191407151B+357407365 <i>Left track control arm</i>	7476108 OE 191407151B+357407365 <i>Right track control arm</i>
 	 
4 Avec rotule With ball joint Ø 19 TT /all models 01/91-03/99 Sauf 2.0 16v.	3 Avec rotule With ball joint Ø 19 TT /all models 01/91-03/99 Sauf 2.0 16v.
7476118 OE 1J0407151C+1J0407365H <i>Left track control arm</i>	7476119 OE 1J0407151C+1J0407366H <i>Right track control arm</i>
 	 
4 Avec rotule With ball joint TT /all models 04/99-	3 Avec rotule With ball joint TT /all models 04/99-
7476117 OE 1H0407151A+1H0407365 <i>Left track control arm</i>	7476115 OE 1H0407152+1H0407365 <i>Right track control arm</i>
 	 
4 Avec rotule With ball joint 2.0i 16v. 01/96-03/99	3 Avec rotule With ball joint 2.0i 16v. 01/96-03/99
7476128 OE 1K0407151AD+1K0407365C <i>Left track control arm</i>	7476127 OE 1K0407152AD+1K0407366C <i>Right track control arm</i>
 	 
4 Avec rotule With ball joint 1.9 TDi 09/04-05/09 2.0 TDi 16v. 09/04-05/09	3 Avec rotule With ball joint 1.9 TDi 09/04-05/09 2.0 TDi 16v. 09/04-05/09

...Toledo...

7476183	Triangle de susp. inf. G	7476184	Triangle de susp. inf. D
OE 6R0407151F+6R0407365A <i>Lower left track control arm</i>		OE 6R0407152F+6R0407366A <i>Lower right track control arm</i>	
NEW	4 Avec rotule With ball joint	NEW	3 Avec rotule With ball joint
	1.2i 06/12- 1.2 TSi 06/12- 1.4 TSi 06/12- 1.6 TDi 06/12-		1.2i 06/12- 1.2 TSi 06/12- 1.4 TSi 06/12- 1.6 TDi 06/12-
9005260	Rotule de susp. inf. G/D	9005268	Rotule de susp. inf. G/D
OE 357407365 <i>L/R lower suspension ball joint</i>		OE 1H0407365 <i>L/R lower suspension ball joint</i>	
	1 2 Ø 19 Cylindrique		1 2 Cône Ø 16.8 - Ø 18
	TT /all models 01/91-03/99 Sauf 2.0 16v.		2.0i 16v. 01/96-03/99
9005266	Rotule de susp. inf. G	9005267	Rotule de susp. inf. D
OE 1J0407365J <i>Left lower suspension ball joint</i>		OE 1J0407366J <i>Right lower suspension ball joint</i>	
	2 Axe Ø 18		1 Axe Ø 18
	TT /all models 04/99-		TT /all models 04/99-
9005570	Rotule de susp. inf. G	9005569	Rotule de susp. inf. D
OE 1K0407365C <i>Left lower suspension ball joint</i>		OE 1K0407366C <i>Right lower suspension ball joint</i>	
	2		1
	1.6i 09/04-05/09 1.9 TDi 09/04-05/09 2.0 FSi 09/04-05/09 2.0 TDi 16v. 09/04-05/09		1.6i 09/04-05/09 1.9 TDi 09/04-05/09 2.0 FSi 09/04-05/09 2.0 TDi 16v. 09/04-05/09
7576019	Rotule de susp. inf. G	7576020	Rotule de susp. inf. D
OE 6R0407365A <i>Left lower suspension ball joint</i>		OE 6R0407366A <i>Right lower suspension ball joint</i>	
NEW	2	NEW	1
	1.2i 06/12- 1.2 TSi 06/12- 1.4 TSi 06/12- 1.6 TDi 06/12-		1.2i 06/12- 1.2 TSi 06/12- 1.4 TSi 06/12- 1.6 TDi 06/12-
9155490	Kit rép. train AV		
OE - <i>Front axle repair kit</i>			
	Sans visserie Without screws and bolts Barre Ø 17		
	TT /all models	01/91-	

SEAT



... Toledo ...









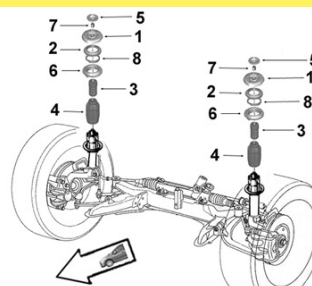

SASIC

SEAT



Support d'amortisseur
Suspension mounting
Soporte amortiguador
Poduszka amortyzatora
Опора амортизатора











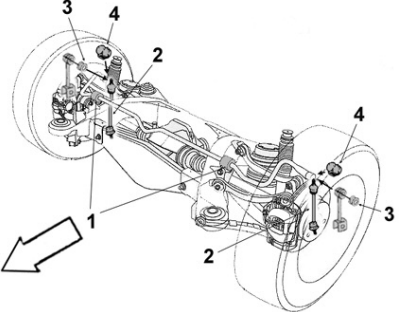

9005604 OE 191412329	Support suspension AV G/D <i>L/R front susp. mounting</i>	9001709 OE 357412331A	Support suspension G/D <i>L/R suspension mounting</i>
	1 Avec roulement <i>With bearing</i> 1.6 -01/96 1.9 D -01/96 1.9 TD -01/96 2.0 -01/96		1 1.8 01/96-01/97 1.9 TDi 01/96-05/98 2.0 01/96-05/98 2.0i 16v. 01/96-05/98
9005614 OE 1J0412331C	Tampon suspension AV G/D <i>L/R front suspension rebound stop</i>	9005622 OE 1K0412331B	Support suspension G/D <i>L/R suspension mounting</i>
	1 1.6 04/99- 1.6i 16v. 09/00- 1.8i 20v. 04/99- 1.8i 20v. Turbo 04/99- 1.9 SDi 04/99- 1.9 TDi 04/99- 2.3i VR5 20v. 04/99-		1 1.6 09/04- 1.9 TDi 09/04- 2.0 FSi 16v. 09/04- 2.0 TDi 16v. 09/04-
9005352 OE 1J0412249	Butée à billes G/D <i>L/R ball bearing</i>	9005363 OE 357412303F	Butée de suspension G/D <i>L/R suspension bush</i>
	2 1.6 04/99- 1.6i 16v. 09/00- 1.8 01/96- 1.8i 20v. /Turbo 09/00- 1.9 D SDi TDi 01/96- 2.0 01/96-05/98 2.0i 16v. 01/96- 2.3i VR5 20v. 09/00-		3 H83 1.2i /TSi 06/12- 1.4 TSi 06/12- 1.6 TDi 06/12- 1.9 TDi -04/99
9005362 OE 357412303E	Butée de suspension G/D <i>L/R suspension bush</i>	9005338 OE 1H0412303B	Butée de suspension <i>Shock bush</i>
	3 H84 1.6 -04/99 1.8 -04/99 1.8i 16v. -04/99 1.9 D -04/99 1.9 TD -04/99 2.0 -04/99 2.0i 16v. -04/99		3 H64 1.6 04/99- Sauf susp. sport 1.6i 16v. 04/99- 1.8i 20v. /Turbo 04/99- 1.9 SDi 04/99- 1.9 TDi 04/99- 2.3i VR5 20v. 04/99-
9005334 OE 1K0412303F	Butée de suspension <i>Shock bush</i>	2656002 OE 1H0412303	Butée de suspension <i>Shock bush</i>
	3 H55 1.9 TDi 09/04- 2.0 FSi 16v. 09/04- 2.0 TDi 09/04-		3 H103 1.6i 04/99-09/00 1.6i 16v. BVM 09/00-09/04 1.8i 20v./Turbo BVM 04/99-09/04 1.9 TDi BVM 04/99-04/04 2.3i V5 20v. BVM 04/99-09/00 2.3i VR5 20v. BVM 09/00-05/02

... Toledo ...

SEAT

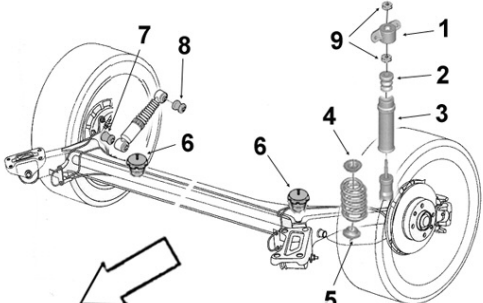

2656004 OE 1K0412303E	Butée de suspension <i>Shock bush</i>	9005327 OE 357413175A	Protecteur amortisseur G/D <i>L/R shock absorber protector</i>
	3 H55 1.6i BVM 09/04-		4 H221.5 1.2i /TSi 06/12- 1.4 TSi 06/12- 1.6 04/99- 1.6i 16v. 09/00- 1.6 TDi 06/12- 1.8i 20v. /Turbo 09/00- 1.9 SDi TDi 09/00- 2.3i VR5 20v. 09/00-
9005369 OE 1H0413175	Protecteur amortisseur G/D <i>L/R shock absorber protector</i>	2656053 OE 6N0413175A	Protecteur amortisseur G/D <i>L/R shock absorber protector</i>
	4 1.9 TDi -04/99		4 H206 1.6i 09/04-05/09 1.9 TDi 09/04-05/09 2.0 FSi 09/04-05/09 2.0 TDi 09/04-05/09
 <p>Barre stabilisatrice <i>Stabilizer bar</i> <i>Barra estabilizadora</i> <i>Drażek stabilizatora</i> стабилизатор поперечной устойчивости</p>			
9005094 OE 1K0505465K	Biellette barre stab. <i>Stabilizer bar stub axle</i>	2306013 OE 1K0511327AQ	Palier de barre milieu <i>Middle bar main bearing</i>
	2 1.6 09/04- 1.9 TDi 09/04- 2.0 FSi 16v. 09/04- 2.0 TDi 16v. 09/04-		1 Barre Ø 19.6 1.6i BVM 09/04- 1.9 TDi BVM 09/04- 2.0 FSi 09/04-06/07 2.0 TDi 16v. 09/04-
 <p>Support d'amortisseur <i>Suspension mounting</i> <i>Soporte amortiguador</i> <i>Poduszka amortyzatora</i> Опора амортизатора</p>			
9005630 OE 1J0513353B	Support suspension G/D <i>L/R suspension mounting</i>	9005328 OE 1J0512131B	Butée de suspension G/D <i>L/R suspension bush</i>
	1 1.6 04/99- 1.6i 16v. 04/99- 1.8i 20v. /Turbo 04/99- 1.9 SDi 04/99- 1.9 TDi 04/99- 2.3i VR5 20v. 04/99-		2 H 129 1.6 04/99- 1.6i 16v. 04/99- 1.8i 20v. /Turbo 04/99- 1.9 SDi 04/99- 1.9 TDi 04/99- 2.3i VR5 20v. 04/99-

... Toledo



Support d'amortisseur
 Suspension mounting
 Soporte amortiguador
 Poduszka amortyzatora
 Опора амортизатора

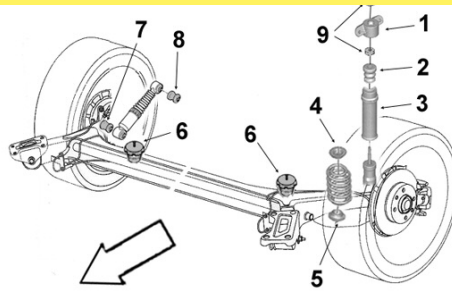

SEAT



9005361 **Butée de suspension AR G/D**
 OE 191512131B *L/R rear suspension bush*



2 H146

1.8	01/96-05/98
1.9 D	01/96-05/98
1.9 TDi	01/96-05/98
2.0	01/96-05/98

9005368 **Protecteur amortisseur G/D**
 OE 191513425 *L/R shock absorber protector*



3 H90

1.6	-04/99
1.8 /i 16v.	-04/99
1.9 D	-04/99
1.9 TD	-04/99
1.9 TDi	-04/99
2.0	-04/99
2.0i 16v.	-04/99

Eléments TRAIN ARRIERE

Rear axle parts
Tren TRAS
Elementy zawieszenia tylnego
элементы задней оси.



9001704 **Articulation essieu AR G/D**
 OE 191501541 *L/R Rear axle bush*



Ø int.12 Ø ext.44.5 coll.72 long. tube int.90 ext.58 ep. coll.2.5

1.8	01/96-05/98
1.9 D	01/96-05/98
1.9 TDi	01/96-05/98
2.0	01/96-05/98

9001705 **Articulation essieu AR G/D**
 OE 1H0501541A *L/R Rear axle bush*



Ø int.12 Ø ext.56.5 coll.74 long. tube int.90 ext.51 ep. coll.3

2.0i 16v.	01/96-01/97
-----------	-------------

2606001 **Articulation traverse**
 OE 6R0501541A *Cross bar bush*



Ø int. 12 Ø ext. 71.5 coll. 80 long. tube int. 90 ext. 54.5

1.6i	04/99-09/00
1.6i 16v. BVM	09/00-09/04
1.8i 20v. /Turbo	05/02-09/04
1.9 TDi BVM	04/99-04/04
2.3i VR5 20v. BVM	04/99-05/02

9001786 **Articulation essieu G/D inf.**
 OE 1K0505553A *Lower L/R axle bush*



Ø int. 12 Ø ext. 37 long. tube int. 50 ext. 28

1.6	09/04-
1.9 TDi	09/04-
2.0 FSi 16v.	09/04-
2.0 TDi 16v.	09/04-

Inca ...

Eléments DIRECTION

Steering parts

Elementos Direcciones

Elementy układ kierowniczy

Элементы рулевой системы

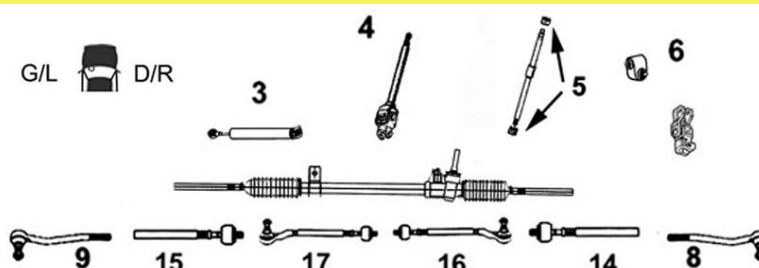

9006380

Rotule de direction G

OE 3A0422811

Left tie rod end



**9 M14 x 1.5
DA**

1.4	AEX	01/96-
1.6	1F	01/96-
1.7 SDi	AHB	01/96-
1.9 SDi	1Y	01/96-

9006381

Rotule de direction D

OE 3A0422812

Right tie rod end



**8 M14 x 1.5
DA**

1.4	AEX	01/96-
1.6	1F	01/96-
1.7 SDi	AHB	01/96-
1.9 SDi	1Y	01/96-



Barre stabilisatrice

Stabilizer bar

Barra estabilizadora

Drążek stabilizatora

стабилизатор поперечной устойчивости

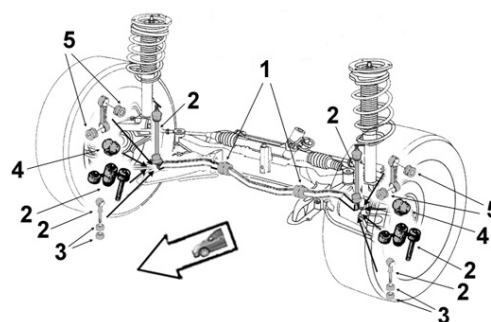

9001522

Palier de barre milieu

OE 191411314

Middle bar main bearing



1 Barre Ø 17

1.4	01/96-
1.6	01/96-
1.7 SDi	01/96-
1.9 D	01/96-
1.9 SDi	01/96-



Eléments SUSPENSION

Suspension parts

Elementos suspensión

Elementy zawieszenie

Элементы подвески

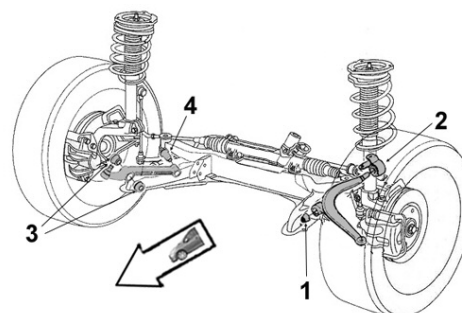

9001520

Articulation AR

OE 191407181E

Rear bush



**2 Ø int.17 Ø ext.60.5
long. tube int.41 ext.24.5**

1.4	01/96-
1.6	01/96-
1.7 SDi	01/96-
1.9 D	01/96-
1.9 SDi	01/96-

9001523

Articulation AV

OE 357407182

Front bush



**1 Ø int.12 Ø ext.33 coll.36
long. tube int.54 ext.29 ep. coll.5**

1.4	01/96-
1.6	01/96-
1.7 SDi	01/96-
1.9 D	01/96-
1.9 SDi	01/96-

... Inca

SASIC

SEAT

Bras & Triangle de suspension

Control arm
Brazo y triángulo
Wahacz
Рычаг подвески

G/L  D/R



7476107	Triangle de susp. G												
OE 191407151B+357407365 <i>Left track control arm</i>													
NEW	4 Avec rotule <i>With ball joint</i> Ø 19												
	<table border="0"> <tr><td>1.4</td><td>AEX</td><td>01/96-</td></tr> <tr><td>1.6</td><td>1F</td><td>01/96-</td></tr> <tr><td>1.7 SDi</td><td>AHB</td><td>01/96-</td></tr> <tr><td>1.9 SDi</td><td>1Y</td><td>01/96-</td></tr> </table>	1.4	AEX	01/96-	1.6	1F	01/96-	1.7 SDi	AHB	01/96-	1.9 SDi	1Y	01/96-
1.4	AEX	01/96-											
1.6	1F	01/96-											
1.7 SDi	AHB	01/96-											
1.9 SDi	1Y	01/96-											

7476108	Triangle de susp. D												
OE 191407151B+357407365 <i>Right track control arm</i>													
NEW	3 Avec rotule <i>With ball joint</i> Ø 19												
	<table border="0"> <tr><td>1.4</td><td>AEX</td><td>01/96-</td></tr> <tr><td>1.6</td><td>1F</td><td>01/96-</td></tr> <tr><td>1.7 SDi</td><td>AHB</td><td>01/96-</td></tr> <tr><td>1.9 SDi</td><td>1Y</td><td>01/96-</td></tr> </table>	1.4	AEX	01/96-	1.6	1F	01/96-	1.7 SDi	AHB	01/96-	1.9 SDi	1Y	01/96-
1.4	AEX	01/96-											
1.6	1F	01/96-											
1.7 SDi	AHB	01/96-											
1.9 SDi	1Y	01/96-											

9005133	Triangle de susp. G/D												
OE 191407151B <i>L/R track control arm</i>													
	3 Sans rotule <i>Without tie rod end</i>												
	4												
<table border="0"> <tr><td>1.4</td><td>AEX</td><td>01/96-</td></tr> <tr><td>1.6</td><td>1F</td><td>01/96-</td></tr> <tr><td>1.7 SDi</td><td>AHB</td><td>01/96-</td></tr> <tr><td>1.9 SDi</td><td>1Y</td><td>01/96-</td></tr> </table>	1.4	AEX	01/96-	1.6	1F	01/96-	1.7 SDi	AHB	01/96-	1.9 SDi	1Y	01/96-	
1.4	AEX	01/96-											
1.6	1F	01/96-											
1.7 SDi	AHB	01/96-											
1.9 SDi	1Y	01/96-											

9005260	Rotule de susp. inf. G/D												
OE 357407365 <i>L/R lower suspension ball joint</i>													
	1 Ø 19 <i>Cylindrique</i>												
	2												
<table border="0"> <tr><td>1.4</td><td>AEX</td><td>01/96-</td></tr> <tr><td>1.6</td><td>1F</td><td>01/96-</td></tr> <tr><td>1.7 SDi</td><td>AHB</td><td>01/96-</td></tr> <tr><td>1.9 SDi</td><td>1Y</td><td>01/96-</td></tr> </table>	1.4	AEX	01/96-	1.6	1F	01/96-	1.7 SDi	AHB	01/96-	1.9 SDi	1Y	01/96-	
1.4	AEX	01/96-											
1.6	1F	01/96-											
1.7 SDi	AHB	01/96-											
1.9 SDi	1Y	01/96-											



Support d'amortisseur
Suspension mounting
Soporte amortiguador
Poduszka amortyzatora
Опора амортизатора

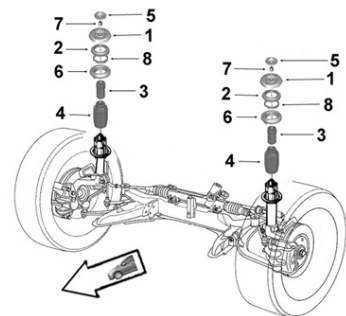

9001709	Support suspension G/D															
OE 357412331A <i>L/R suspension mounting</i>																
	1															
<table border="0"> <tr><td>1.4</td><td></td><td></td></tr> <tr><td>1.6</td><td></td><td></td></tr> <tr><td>1.7 SDi</td><td></td><td></td></tr> <tr><td>1.9 D</td><td></td><td></td></tr> <tr><td>1.9 SDi</td><td></td><td></td></tr> </table>	1.4			1.6			1.7 SDi			1.9 D			1.9 SDi			
1.4																
1.6																
1.7 SDi																
1.9 D																
1.9 SDi																

Citigo ...



Barre stabilisatrice
 Stabilizer bar
 Barra estabilizadora
 Drażek stabilizatora
 стабилизатор поперечной устойчивости

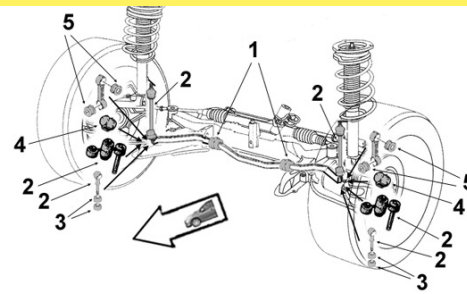

2306017 **Palier de barre milieu**
 OE 6Q0411314P *Middle bar main bearing*

NEW



1 Barre Ø 18

1.0i



Eléments SUSPENSION
 Suspension parts
 Elementos suspensión
 Elementy zawieszenie
 Элементы подвески

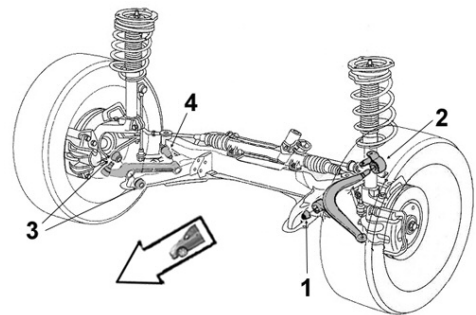

9001542 **Articulation AR**
 OE 1J0407181 *Rear bush*



2 Ø int.13 Ø ext.59.5 long. tube int.41 ext.23.5

1.0i

Bras & Triangle de suspension

Control arm
 Brazo y triángulo
 Wahacz
 Рычаг подвески

G/L  D/R

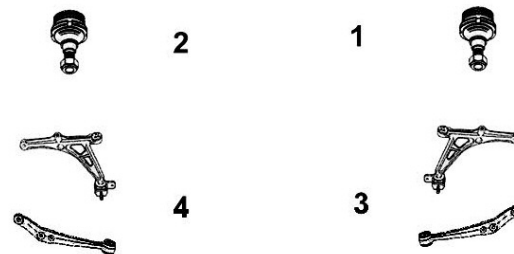

7576019 **Rotule de susp. inf. G**
 OE 6R0407365A *Left lower suspension ball joint*

NEW



2

1.0i

11/11-

7576020 **Rotule de susp. inf. D**
 OE 6R0407366A *Right lower suspension ball joint*

NEW



1

1.0i

11/11-

... Citigo



Support d'amortisseur
 Suspension mounting
 Soporte amortiguador
 Poduszka amortyzatora
 Опора амортизатора

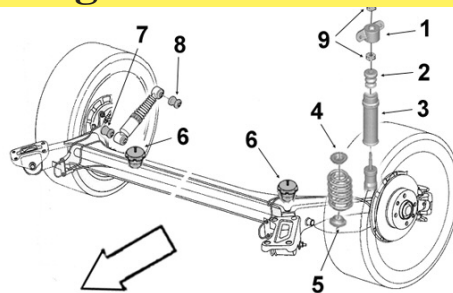

2656062

Bague palier susp.

OE 1S0512335A

bearing ring suspension

9 Ø int. 15.8 Ø ext. 41 long. tube int.27 ext.24.3



1.0i

Eléments TRAIN ARRIERE

Rear axle parts

Tren TRAS

Elementy zawieszenia tylnego

элементы задней оси.



2606005

Articulation essieu AR

OE 1S0501541B

Rear axle bush

Ø int.10 Ø ext.58 coll.74
 long. tube int. 64 ext. 41 ep coll. 15.3



1.0i

Fabia ...

Eléments DIRECTION

Steering parts

Elementos Direcciones

Elementy uklad kierowniczy

Элементы рулевой системы

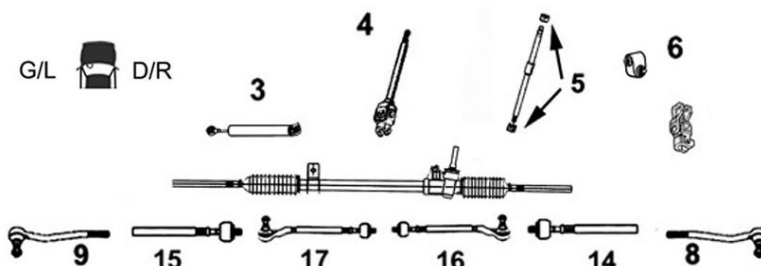

9006874

Axe de bielle G/D

OE 6Q0423810C

L/R axial joint



14 Côté dir. M16x1.5
15 Côté rot. M14x1.5 long 299 mm
 Dir. SMI Koyo

1.2	01/03-09/04
1.4	04/00-12/02
1.4i 16v.	04/00-09/04
1.4 TDi	06/03-09/04
1.9 SDi	04/00-09/04
1.9 TDi	04/00-09/04

9006251

Axe de bielle G/D

Part/oe 6Q0423803B

L/R axial joint



14 Côté dir. M14x1.5
15 Côté rot. M14x1.5 long 295 mm

1.4i /16v.	Dir. TRW
1.9 SDi	Dir. SMI Koyo TRW
1.9 TDi	Dir. TRW

9006634

Rotule de direction G

OE 6R0423811

Left tie rod end



9 M14 x 1.5
 1.2i /TSi
 1.2 TDi FAP
 1.4i /16v./TSi RS
 1.4 TDi
 1.6i
 1.6 TDi FAP
 1.9 SDi
 1.9 TDi

9006635

Rotule de direction D

OE 6R0423812

Right tie rod end



8 M14 x 1.5
 1.2i /TSi
 1.2 TDi FAP
 1.4i /16v./TSi RS
 1.4 TDi
 1.6i
 1.6 TDi FAP
 1.9 SDi
 1.9 TDi

... Fabia ...





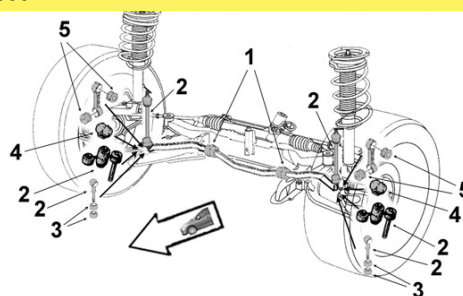



Barre stabilisatrice
Stabilizer bar
Barra estabilizadora
Drażek stabilizatora
 стабилизатор поперечной устойчивости



SKODA

SASIC

9005089 OE 6Q0411315N	Biellette barre stab. <i>Stabilizer bar stub axle</i>	2306019 OE 6Q0411314R	Palier de barre milieu <i>Middle bar main bearing</i>
	2 1.2 /Break 01/03- 1.2 TSi /Break 03/10- 1.4 /Break /1.4i 16v. 04/00- 1.4 TSi /Break 05/10- 1.4 TDi /Break 06/03- 1.6i /Break 04/07- 1.6 TDi /Break 03/10- 1.9 SDi TDi 04/00-		1 Barre Ø 18 1.2i /Break Ch- 6Y3651671 BVM 03/10- 1.2 TSi /TDi /Break 03/10- 1.4i /Break Ch-6Y3651671 BVM -12/02 1.4i 16v. /Break Ch- 6Y3651671 -09/04 1.4 TSi /Break 05/10- 1.4 TDi /Break Ch- 6Y3651671 BVM 1.6i /Break 04/07- 1.6 TDi /Break 03/10- 1.9 SDi /Break Ch-6Y3651671 BVM -09/04 1.9 TDi /Break Ch- 6Y3651671 BVM
2306015 OE 6Q0411314F	Palier de barre milieu <i>Middle bar main bearing</i>	2306018 OE 6Q0411314Q	Palier de barre milieu <i>Middle bar main bearing</i>
	1 Ø 19 -ch 6Y3651670 1.2i /Break BVM 01/03- 1.4i /Break BVM 04/00- 1.4i 16v./Break 04/00- 1.4 TDi/Break BVM 06/03- 1.9 SDi/Break BVM 04/00- 1.9 TDi/Break BVM 04/00-		1 Barre Ø 19 1.2i /Break Ch- 6Y3651671 BVM 03/10- 1.2 TSi /TDi /Break 03/10- 1.4i /Break Ch-6Y3651671 BVM -12/02 1.4i 16v. /Break Ch- 6Y3651671 -09/04 1.4 TSi /Break 05/10- 1.4 TDi /Break Ch- 6Y3651671 BVM 1.6i /Break 04/07- 1.6 TDi /Break 03/10- 1.9 SDi /Break Ch-6Y3651671 BVM -09/04 1.9 TDi /Break Ch- 6Y3651671 BVM
2306022 OE 8Z0411314B	Palier de barre milieu <i>Middle bar main bearing</i>	2306017 OE 6Q0411314P	Palier de barre milieu <i>Middle bar main bearing</i>
	1 Barre Ø 20 -ch 6Y3651670 1.2i /Break BVM 01/03-09/04 1.4i /Break BVM 04/00-12/02 1.4i 16v. /Break 04/00-09/04 1.4 TDi/Break BVM 06/03-09/04 1.9 SDi/Break BVM 04/00-09/04 1.9 TDi/Break BVM 04/00-09/04		1 Barre Ø 18 1.2i /Break BVM 01/03-09/04 1.2 TSi TDi /Break 03/10- 1.4i /Break BVM 04/00-12/02 1.4i 16v./Break 04/00-09/04 1.4 TSi/Break 09/10- 1.4 TDi/Break BVM 06/03-09/04 1.6 TDi/Break 03/10- 1.9 SDi/Break BVM 04/00-09/04 1.9 TDi /Break BVM 04/00-09/04



Eléments SUSPENSION
Suspension parts
Elementos suspensión
Elementy zawieszenie
 Элементы подвески

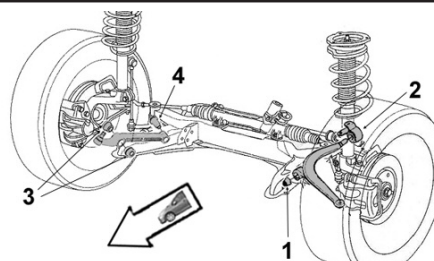

9001523 OE 357407182	Articulation AV <i>Front bush</i>
	1 Ø int.12 Ø ext.33 coll.36 long. tube int.54 ext.29 ep. coll.5 1.2i Berline Ch- 5J-8A502657 /5J-08B503032 /5J-8K450961 /5J-83172974 05/07-03/10 1.2i Break 01/08-03/10 1.2 TSi /Break 03/10- 1.2 TDi /Break 05/10- 1.4i Berline Ch- 5J-8A502657 /5J-08B503032 /5J-8K450961 /5J-83172974 05/07- 1.4i Break 01/08- 1.4 TSi /Break 05/10- 1.4 TDi Berl. Ch- 5J-8A502657 /5J-08B503032 /5J-8K450961 /5J-83172974 05/07-03/10 1.4 TDi Break 01/08-03/10 1.6i Berline Ch- 5J-8A502657 /5J-08B503032 /5J-8K450961 /5J-83172974 05/07-03/10 1.6i Break 01/08-03/10 1.6 TDi /Break 03/10- 1.9 TDi Berl. Ch- 5J-8A502657 /5J-08B503032 /5J-8K450961 /5J-83172974 05/07-03/10 1.9 TDi Break 01/08-03/10

... Fabia ...



Eléments SUSPENSION

Suspension parts
Elementos suspensión
Elementy zawieszenie
Элементы подвески

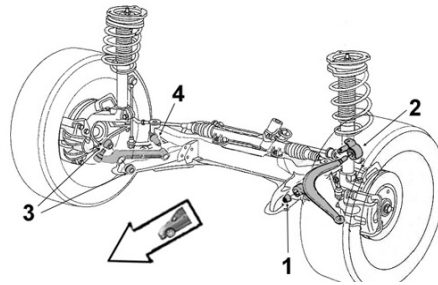

SKODA

2256001

Articulation AR

OE 6Q0407183A

Rear bush



2 Øint.18.5 Ø ext.64 coll.71.5 long. tube int.35 ext.46
Ch- 6Y4975196

1.2i /Break
1.4i /Break
1.4i 16v. /Break
1.4 TDi /Break
1.9 SDi /Break
1.9 TDi /RS /Break

01/03-09/04
04/00-12/02
04/00-09/04
06/03-09/04
04/00-09/04
04/00-09/04

9001542

Articulation AR

OE 1J0407181

Rear bush



2 Øint.13 Ø ext.59.5 long. tube int.41 ext.23.5

1.2i /Break Ch- 5J-8A502657 /5J-08B503032 /5J-8K450961 /5J-83172974
1.2 TSi TDi /Break Ch- 5J-8A502657 /5J-08B503032 /5J-8K450961 /5J-83172974
1.4i /Break Ch- 5J-8A502657 /5J-08B503032 /5J-8K450961 /5J-83172974
1.4 TDi Ch- 5J-8A502657 /5J-08B503032 /5J-8K450961 /5J-83172974
1.4 TDi Break Ch- 5J-8A502657 /5J-08B503032 /5J-8K450961 /5J-83172974
1.6i Ch- 5J-8A502657 /5J-08B503032 /5J-8K450961 /5J-83172974
1.6i Break Ch- 5J-8A502657 /5J-08B503032 /5J-8K450961 /5J-83172974
1.6 TDi /Break Ch- 5J-8A502657 /5J-08B503032 /5J-8K450961 /5J-83172974
1.9 TDi Ch- 5J-8A502657 /5J-08B503032 /5J-8K450961 /5J-83172974
1.9 TDi Break Ch- 5J-8A502657 /5J-08B503032 /5J-8K450961 /5J-83172974

05/07-03/10
05/07-03/10
05/07-03/10
01/08-03/10
05/07-03/10
01/08-03/10
03/10-05/07-03/10
05/07-03/10
01/08-03/10

Bras & Triangle de suspension

Control arm
Brazo y triángulo
Wahacz
Рычаг подвески

G/L D/R



9005758

Triangle de susp. inf. G/D

OE 6Q0407151L

Lower L/R track control arm



3 Sans rotule Without ball joint
4

1.2 /Break
1.4i /Break
1.4i 16v. /Break
1.4 TDi /Break
1.6i /Break
1.9 SDi /Break
1.9 TDi /Break

01/03-03/10
04/00-03/10
11/00-12/07
06/03-03/10
05/07-03/10
04/00-12/07
04/00-03/10

7476123

Triangle de susp. G

OE 6Q0407151L+6Q0407365M Left track control arm

NEW



4 Avec rotule With ball joint

1.2 /Break 01/03-03/10
1.4i /Break 04/00-03/10
1.4i 16v. /Break 11/00-12/07
1.4 TDi /Break 06/03-03/10
1.6i /Break 05/07-03/10
1.9 SDi /Break 04/00-12/07
1.9 TDi /Break 04/00-03/10

7476122

Triangle de susp. D

OE 6Q0407151L+6Q0407366M Right track control arm







NEW



3 Avec rotule With ball joint

1.2 /Break 01/03-03/10
1.4i /Break 04/00-03/10
1.4i 16v. /Break 11/00-12/07
1.4 TDi /Break 06/03-03/10
1.6i /Break 05/07-03/10
1.9 SDi /Break 04/00-12/07
1.9 TDi /Break 04/00-03/10

... Fabia ...

... Fabia ...			
7476183 Triangle de susp. inf. G OE 6R0407151F+6R0407365A <i>Lower left track control arm</i>			
	<p>NEW</p> <p>4 Avec rotule With ball joint</p> <p>1.2i Ch-5J-8A502657 Ch-5J-8B503032 Ch-5J-8K450961 Ch-5L-83172974 BBMO BVM 05/07-03/10 1.2i /Break Ch-5J-8A502657 Ch-5J-8B503032 Ch-5J-8K450961 Ch-5L-83172974 BZG BVM 05/07-03/10 1.2 TSi /Break CBZA /B 03/10- 1.2 TDi FAP /Break CFWA BVM 03/10- 1.4i /Break Ch-5J-8A502657 Ch-5J-8B503032 Ch-5J-8K450961 Ch-5L-83172974 BXW BVM 05/07-03/10 1.4 TSi /Break CAVE BV Rob. 09/10- 1.4 TDi /Break Ch-5J-8A502657 Ch-5J-8B503032 Ch-5J-8K450961 Ch-5L-83172974 BMS BVM 05/07-03/10 1.6i /Break Ch-5J-8A502657 Ch-5J-8B503032 Ch-5J-8K450961 Ch-5L-83172974 BTS 05/07-03/10 1.6 TDi FAP /Break CAYA/B/C BVM 03/10- 1.9 TDi FAP /Break Ch-5J-8A502657 Ch-5J-8B503032 Ch-5J-8K450961 Ch-5L-83172974 BLS BSW BVM 05/07-03/10</p>		
7476184 Triangle de susp. inf. D OE 6R0407152F+6R0407366A <i>Lower right track control arm</i>			
	<p>NEW</p> <p>3 Avec rotule With ball joint</p> <p>1.2i Ch-5J-8A502657 Ch-5J-8B503032 Ch-5J-8K450961 Ch-5L-83172974 BBMO BVM 05/07-03/10 1.2i /Break Ch-5J-8A502657 Ch-5J-8B503032 Ch-5J-8K450961 Ch-5L-83172974 BZG BVM 05/07-03/10 1.2 TSi /Break CBZA /B 03/10- 1.2 TDi FAP /Break CFWA BVM 03/10- 1.4i /Break Ch-5J-8A502657 Ch-5J-8B503032 Ch-5J-8K450961 Ch-5L-83172974 BXW BVM 05/07-03/10 1.4 TSi /Break CAVE BV Rob. 09/10- 1.4 TDi /Break Ch-5J-8A502657 Ch-5J-8B503032 Ch-5J-8K450961 Ch-5L-83172974 BMS BVM 05/07-03/10 1.6i /Break Ch-5J-8A502657 Ch-5J-8B503032 Ch-5J-8K450961 Ch-5L-83172974 BTS 05/07-03/10 1.6 TDi FAP /Break CAYA/B/C BVM 03/10- 1.9 TDi FAP /Break Ch-5J-8A502657 Ch-5J-8B503032 Ch-5J-8K450961 Ch-5L-83172974 BLS BSW BVM 05/07-03/10</p>		
7476091 Triangle de susp. inf. G OE 6R0407151F <i>Lower left track control arm</i>	7476092 Triangle de susp. inf. D OE 6R0407152F <i>Lower right track control arm</i>		
	<p>NEW</p> <p>4 Sans rotule Without ball joint</p> <p>1.9 TDi FAP /Break Ch- 5J-8B503032 BLS BSW BVM 05/07-03/10</p>		<p>NEW</p> <p>3 Sans rotule Without ball joint</p> <p>1.9 TDi FAP /Break Ch- 5J-8B503032 BLS BSW BVM 05/07-03/10</p>
9005478 Rotule de susp. inf. G OE 6Q0407365M <i>Left lower suspension ball joint</i>			
	<p>2 -ch 5J-8A502656 /8B503031 /8K450960 /83172973</p> <p>1.2 /Break 01/03- 1.4i /Break 1.4i 16v. /Break 1.4 TDi /Break 06/03- 1.6i /Break 05/07- 1.9 SDi /Break 1.9 TDi /Break</p>		
9005479 Rotule de susp. inf. D OE 6Q0407366M <i>Right lower suspension ball joint</i>			
	<p>1 -ch 5J-8A502656 /8B503031 /8K450960 /83172973</p> <p>1.2 /Break 01/03- 1.4i /Break 1.4i 16v. /Break 1.4 TDi /Break 06/03- 1.6i /Break 05/07- 1.9 SDi /Break 1.9 TDi /Break</p>		

... Fabia ...

Bras & Triangle de suspension

Control arm
Brazo y triángulo
Wahacz
Рычаг подвески

G/L  D/R

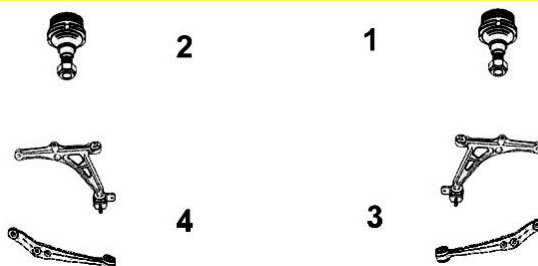

7576019

Rotule de susp. inf. G

OE 6R0407365A

Left lower suspension ball joint

NEW

2



1.2i	Ch- 5J-8A502657 Ch- 5J-8K450961	Ch- 5J-8B503032 Ch- 5L-83172974	BBMO	BVM	05/07-03/10
1.2i Break	Ch- 5J-8B503032 Ch- 5L-83172974	Ch- 5J-8A502657 Ch- 5J-8A502657	BBM	BVM	01/08-03/10
1.2i /Break	Ch- 5J-8A502657 Ch- 5J-8K450961	Ch- 5J-8B503032 Ch- 5L-83172974	BZG CGPA CHFA	BVM	05/07-03/10
1.2i /Break			CGPA /B CHFA	BVM	03/10-
1.2 TSi /Break			CBZA /B		03/10-
1.2 TDi FAP/Break			CFWA	BVM	03/10-
1.4i /Break	Ch- 5J-8A502657 Ch- 5J-8K450961	Ch- 5J-8B503032 Ch- 5L-83172974	BXW	BVM	05/07-03/10
1.4i /Break			CGGB	BVM	03/10-
1.4 TSi /Break			CAVE	BV Rob.	09/10-
1.4 TDi/FAP /Break	Ch- 5J-8A502657 Ch- 5J-8K450961	Ch- 5J-8B503032 Ch- 5L-83172974	BMS BNM /V	BVM	05/07-03/10
1.6i /Break	Ch- 5J-8A502657 Ch- 5J-8K450961	Ch- 5J-8B503032 Ch- 5L-83172974	BTS		05/07-03/10
1.6 TDi FAP /Break			CAYA /B /C	BVM	03/10-
1.9 TDi FAP /Break	Ch- 5J-8A502657 Ch- 5J-8K450961	Ch- 5J-8B503032 Ch- 5L-83172974	BLS BSW	BVM	05/07-03/10

7576020

Rotule de susp. inf. D

OE 6R0407366A

Right lower suspension ball joint

NEW

1



1.2i	Ch- 5J-8A502657 Ch- 5J-8K450961	Ch- 5J-8B503032 Ch- 5L-83172974	BBMO	BVM	05/07-03/10
1.2i Break	Ch- 5J-8B503032 Ch- 5L-83172974	Ch- 5J-8A502657 Ch- 5J-8A502657	BBM	BVM	01/08-03/10
1.2i /Break	Ch- 5J-8A502657 Ch- 5J-8K450961	Ch- 5J-8B503032 Ch- 5L-83172974	BZG CGPA CHFA	BVM	05/07-03/10
1.2i /Break			CGPA /B CHFA	BVM	03/10-
1.2 TSi /Break			CBZA /B		03/10-
1.2 TDi FAP/Break			CFWA	BVM	03/10-
1.4i /Break	Ch- 5J-8A502657 Ch- 5J-8K450961	Ch- 5J-8B503032 Ch- 5L-83172974	BXW	BVM	05/07-03/10
1.4i /Break			CGGB	BVM	03/10-
1.4 TSi /Break			CAVE	BV Rob.	09/10-
1.4 TDi/FAP /Break	Ch- 5J-8A502657 Ch- 5J-8K450961	Ch- 5J-8B503032 Ch- 5L-83172974	BMS BNM /V	BVM	05/07-03/10
1.6i /Break	Ch- 5J-8A502657 Ch- 5J-8K450961	Ch- 5J-8B503032 Ch- 5L-83172974	BTS		05/07-03/10
1.6 TDi FAP /Break			CAYA /B /C	BVM	03/10-
1.9 TDi FAP /Break	Ch- 5J-8A502657 Ch- 5J-8K450961	Ch- 5J-8B503032 Ch- 5L-83172974	BLS BSW	BVM	05/07-03/10

... Fabia ...



Support d'amortisseur
Suspension mounting
Soporte amortiguador
Poduszka amortyzatora
Опора амортизатора

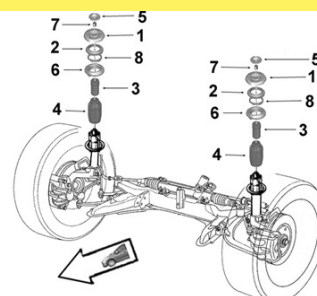

SKODA



9005623 **Support suspension G/D**
 OE 6N0412331E *L/R suspension mounting*



1	1.2 /Break	-ch 5J-9A508236/5J -9B505015 /9K506833 -93120132	01/03-
	1.4 /Break		04/00-
	1.4i 16v.		04/00-
	1.4 TDi /Break		06/03-
	1.6i /Break	-ch 5J-9B505015 /9K506833 -93120132	05/07-
	1.9 SDi		04/00-
	1.9 TDi /Break	-ch 5J-9A508236/5J-9B505015 /9K506833 -93120132	04/00-

9005614 **Tampon suspension AV G/D**
 OE 1J0412331C *L/R front suspension rebound stop*



1	Ch- 5J-9A508237/5J-9B505016/5J-5K506834/5J-93120133		
	1.2i /Break		05/07-
	1.4i /Break		05/07-
	1.9 TDi /Break		05/07-

9005352 **Butée à billes G/D**
 OE 1J0412249 *L/R ball bearing*



2	Ch- 5J-9A508937 ch- 5J-9B505016 ch- 5J-5K506834 ch- 5J-93120133		
	1.2i /Break		05/07-03/10
	1.4i /Break		05/07-03/10
	1.4 TDi /Break		05/07-03/10
	1.9 TDi /Break		05/07-03/10

2656008 **Butée de suspension**
 OE 6N0412303A *Shock bush*



3	H63		
	1.2i /Break	BVM	01/03-
	1.4i /Break	BVM	04/00-
	1.4i 16v. /Break		04/00-
	1.4 TDi /Break	BVM	06/03-
	1.6i /Break		04/07-
	1.9 SDi /Break	BVM	04/00-
	1.9 TDi /Break	BVM	04/00-

2656053 **Protecteur amortisseur G/D**
 OE 6N0413175A *L/R shock absorber protector*



4	H206		
	1.2 /Break		01/03-03/10
	1.4i /16v. /Break		04/00-05/07
	1.4 TDi /Break		06/03-03/10
	1.6i /Break		05/07-03/10
	1.9 SDi /Break		04/00-12/05
	1.9 TDi /RS /Break		04/00-03/10

... Fabia



Support d'amortisseur
Suspension mounting
Soporte amortiguador
Poduszka amortyzatora
Опора амортизатора

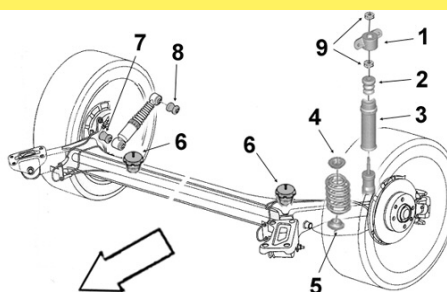

9005630

Support suspension G/D

OE 1J0513353B

L/R suspension mounting



1

1.2 /TSi /Break
 1.2 TDi /Break
 1.4i //16v. /Break
 1.4 TSi /Break
 1.4 TDi /Break
 1.6i /Break
 1.6 TDi /Break
 1.9 SDi / TDi /Break

07/01-
 03/10-
 04/00-
 03/10-
 04/03-
 05/07-03/10
 03/10-
 04/00-

Eléments TRAIN ARRIERE

Rear axle parts

Tren TRAS

Elementy zawieszenia tylnego

элементы задней оси.



2606001

Articulation traverse

OE 6R0501541A

Cross bar bush



Ø int. 12 Ø ext. 71.5 coll. 80 long. tube int. 90 ext. 54.5

1.2i /Break
 1.2 TSi /Break
 1.2 TDi /Break
 1.4i /Break
 1.4i 16v. /Break
 1.4 TSi /Break
 1.4 TDi /Break
 1.6i /Break
 1.6 TDi /Break
 1.9 SDi /Break
 1.9 TDi /Break

BVM

BVM

BVM

BVM

BVM

01/03-
 03/10-
 05/10-
 04/00-12/02
 04/00-
 05/10-
 06/03-
 04/07-
 03/10-
 04/00-09/04
 04/00-

Favorit ...

Eléments DIRECTION

Steering parts

Elementos Direcciones

Elementy uklad kierowniczy

Элементы рулевой системы

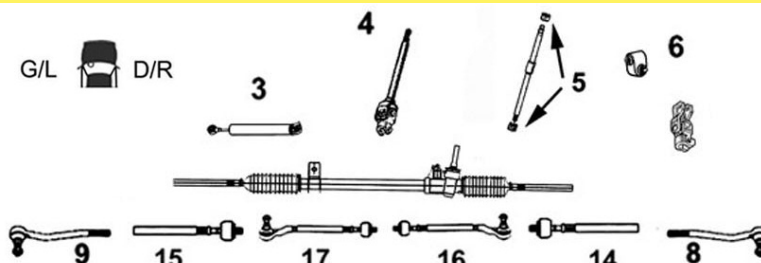

9006600

Rotule de direction G/D

OE 115500440

L/R tie rod end



8

M12 x 1.0

TT /all models

02/89-

... Favorit

Bras & Triangle de suspension

Control arm
Brazo y triángulo
Wahacz
Рычаг подвески

G/L  D/R

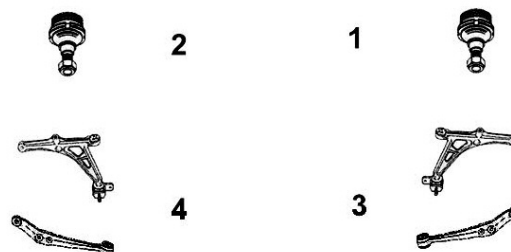

9005454

Rotule de susp. inf. G/D

OE 115420240

L/R lower suspension ball joint



1
2

TT /all models

02/89-

Felicia

Eléments DIRECTION

Steering parts
Elementos Direcciones
Elementy uklad kierowniczy
Элементы рулевой системы

G/L  D/R

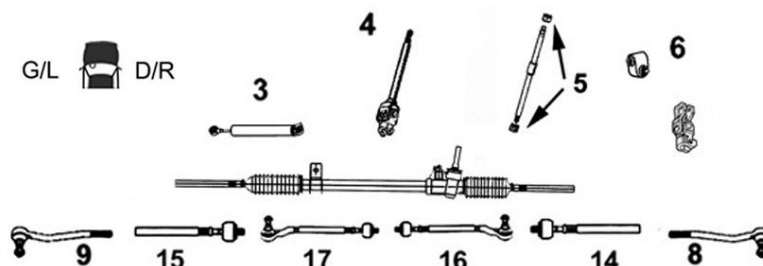

9006861

Axe de bielle G/D

Part/oe 007350278N

L/R axial joint



14 Côté dir. M14x1.5
15 Côté rot. M12x1.0 long 360 mm

TT /all models DNA 02/95-

9006600

Rotule de direction G/D

OE 6U0422811

L/R tie rod end



8 M12 x 1.0
9

TT /all models 02/95-

Bras & Triangle de suspension

Control arm
Brazo y triángulo
Wahacz
Рычаг подвески

G/L  D/R

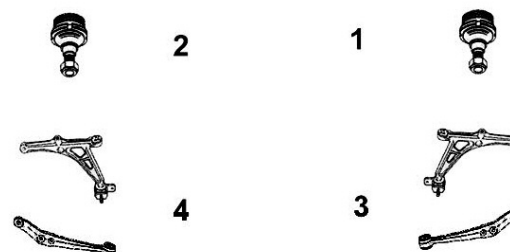

9005454

Rotule de susp. inf. G/D

OE 6U0407365

L/R lower suspension ball joint



1
2

TT /all models

02/95-

SKODA



Octavia ...

Eléments DIRECTION
Steering parts
Elementos Direcciones
Elementy układ kierowniczy
Элементы рулевой системы

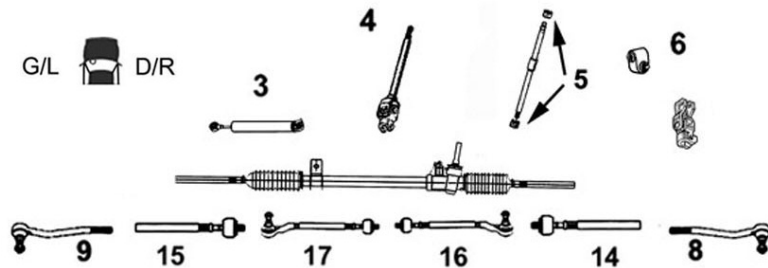

SKODA

SASIC

9006213 **Axe de bielle G/D**
 Part/oe 1J0422807A *L/R axial joint*



14 Côté dir. M16x1.5
15 Côté rot. M14x1.5 long 338 mm

TT /all models 11/96-12/99

9006219 **Axe de bielle G/D**
 Part/oe 1J0422803H *L/R axial joint*



14 Côté dir. M16x1.5
15 Côté rot. M14x1.5 long 320 mm

TT /all models 01/99-

9006873 **Axe de bielle G/D**
 OE 1K0423810A *L/R axial joint*



14 Côté dir. M16x1.5 **15** Côté rot. M16x1.5 long 310 mm
 1.2i Turbo
 1.4 TSi
 1.6i
 1.6 FSi
 1.6 TDi
 1.8 TFSi
 1.9 TDi /4WD
 2.0 FSi
 2.0 TFSi
 2.0 TDi /4WD

03/10-
 10/08-
 06/04-
 06/04-10/08
 10/09-
 07/07-
 06/04-
 10/04-06/07
 10/05-
 06/04-

9006385 **Rotule de direction G**
 OE 1J0422811A *Left tie rod end*



9 M14 x 1.5

TT /all models 11/96-12/99
 Sauf 99hp 66kw type mines 1UAGR2

9006384 **Rotule de direction D**
 OE 1J0422812A *Right tie rod end*



8 M14 x 1.5

TT /all models 11/96-12/99
 Sauf 99hp 66kw type mines 1UAGR2

9006634 **Rotule de direction G**
 OE 1J0422812B *Left tie rod end*



9 M14 x 1.5

TT /all models 90hp 66kw
 Dir. TRW 1UAGR2 05/97-
 TT /all models Sauf 90hp 66kw
 Dir. TRW 1UAGR2 01/99-

9006635 **Rotule de direction D**
 OE 1J0422811B *Right tie rod end*



8 M14 x 1.5

TT /all models 90hp 66kw
 Dir. TRW 1UAGR2 05/97-
 TT /all models Sauf 90hp 66kw
 Dir. TRW 1UAGR2 01/99-

9006638 **Rotule de direction G**
 OE 1K0423811K *Left tie rod end*



9 M16 x 1.5

1.2i Turbo / Break 19/04/10-
 1.6 TDi FAP / Break/4WD 19/04/10-
 2.0 TDi FAP / Break/4WD 19/04/10-

9006637 **Rotule de direction D**
 OE 1K0423812K *Right tie rod end*





8 M16 x 1.5

1.2i Turbo / Break 19/04/10-
 1.6 TDi FAP / Break/4WD 19/04/10-
 2.0 TDi FAP / Break/4WD 19/04/10-

... Octavia ...

SKODA



SASIC



9006640 OE 1K0423811G	Rotule de direction G <i>Left tie rod end</i>	9006639 OE 1K0423812G	Rotule de direction D <i>Right tie rod end</i>		
	9 M16 x 1.5		8 M16 x 1.5		
	1.2i Turbo /Break		03/10-18/04/10	1.2i Turbo /Break	03/10-18/04/10
	1.4 TSi /Break		10/08-18/04/10	1.4 TSi /Break	10/08-18/04/10
	1.6i /Break		06/04-18/04/10	1.6i /Break	06/04-18/04/10
	1.6 FSi /Break		06/04-10/08	1.6 FSi /Break	06/04-10/08
	1.6 TDi /Break		10/09-18/04/10	1.6 TDi /Break	10/09-18/04/10
	1.8 TFSi /Break		07/07-18/04/10	1.8 TFSi /Break	07/07-18/04/10
	1.9 TDi /Break		06/04-18/04/10	1.9 TDi /Break	06/04-18/04/10
	2.0 FSi /Break		10/04-06/07	2.0 FSi /Break	10/04-06/07
	2.0 TFSi /Break		10/08-18/04/10	2.0 TFSi /Break	10/08-18/04/10
2.0 TDi /4WD /Break	06/04-18/04/10	2.0 TDi /4WD /Break	06/04-18/04/10		

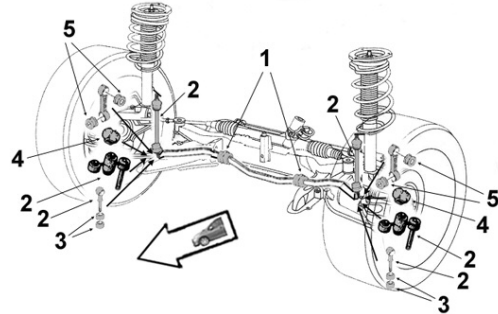



Barre stabilisatrice
Stabilizer bar
Barra estabilizadora
Drażek stabilizatora
 стабилизатор поперечной устойчивости



2306010 OE 1K0411315P	Biellette barre stab. <i>Stabilizer bar stub axle</i>	9005084 OE 1J0411315J	Biellette barre stab. <i>Stabilizer bar stub axle</i>		
	2		2 Barre Ø 21		
	1.2i Turbo /Break		02/10-	1.6	05/97-10/00
	1.4 TSi /Break		11/08-	1.8i 20v.	05/97-10/00
	1.6i /Break		06/04-	1.9 TDi AXR /SZ/HF	/GR/LH/TD/SV 05/97-10/00
	1.6 FSi /Break		02/04-10/08		
	1.6 TDi /4WD /Break		06/09-		
	1.8 TSi /4WD /Break		06/07-		
	1.9 TDi /4WD /Break		06/04-12/10		
	2.0 FSi/RS/4WD/Break		11/04-		
	2.0 TFSi /Break		10/05-		
2.0 TDi /RS/4WD/Break	02/04-				

9005090 OE 1J0411315G	Biellette barre stab. <i>Stabilizer bar stub axle</i>	9005093 OE 1J0411315K	Biellette barre stab. <i>Stabilizer bar stub axle</i>
	2 Barre Ø 23		2 Barre Ø 23
	1.8i 20v. Turbo		06/99-10/00

9005018 OE 1J0411327	Liaison élastique <i>Elastic link</i>	2306134 OE 1J0411314S	Palier de barre <i>Bar main bearing</i>		
	5		1 Ø 17		
	Ø int.14.5 ext. Ø29 coll.35 x2 long. tube int.22.5 ext.18 ep. coll.2 x2		1.4i 16v. /Break	01/01-12/10	
	1.6		09/96-10/00	1.6i /Break	01/01-12/10
	1.8i 20v.		09/96-10/00	1.8i Turbo 4WD/RS/Break	01/01-12/10
1.9 TDi	09/96-10/00	1.9 SDi /Break	01/01-12/03		
		1.9 TDi /Break	01/01-03/10		
		1.9 TDi 4WD Break	01/01-02/06		
		2.0i APK AEG	01/01-05/07		
		2.0i 4WD Break AZH	01/01-09/04		
		2.0i Break AQYAPKAEQ	01/01-05/07		

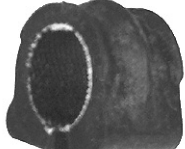
9001730 OE 1J0411314R	Palier de barre milieu <i>Middle bar main bearing</i>	9001732 OE 1J0411314T	Palier de barre milieu <i>Middle bar main bearing</i>		
	1 Barre Ø 21		1 Barre Ø 23		
	1.6i		05/97-10/00	1.8i 20v. Turbo	06/99-10/00
	1.8i 20v.		05/97-10/00		
	1.9 TDi 90hp 66kw 110hp 81kw		05/97-10/00		

... Octavia ...



Eléments SUSPENSION

Suspension parts

Elementos suspensión

Elementy zawieszenie

Элементы подвески

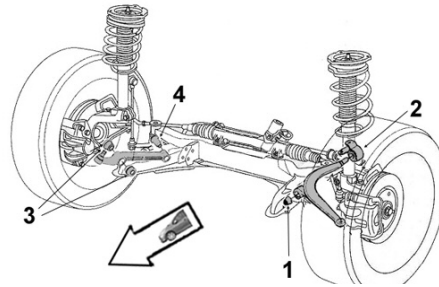

SKODA

SASIC

9001523

Articulation AV

OE 357407182

Front bush



1 Ø int.12 Ø ext.33 coll.36
long. tube int.54 ext.29 ep. coll.5

1.6	-06/04
1.8i 20v.	-06/04
1.8i 20v. Turbo	-06/04
1.9 SDi	-06/04
1.9 TDi	-06/04
2.0	-06/04

9001759

Articulation AV

OE 1K0407182

Front bush



1 Ø int.12 Ø ext.40 coll.48
long. tube int.54 ext.33 ep. coll.6

1.4 TSi /Break	10/08-
1.6i /Break	06/04-
1.6 FSi /Break	02/04-10/08
1.8 TSi /4WD /Break	06/07-
1.9 TDi /4WD /Break	06/04-12/10
2.0 FSi/RS/4WD/Break	11/04-
2.0 TDi/RS/4WD/Break	02/04-

9001542

Articulation AR

OE 1J0407181

Rear bush



2 Ø int.13 Ø ext.59.5
long. tube int.41 ext.23.5

1.6	-06/04
1.8i 20v.	-10/00
1.8i 20v. Turbo	-06/04
1.9 TDi	-06/04
2.0	10/00-06/04

2256003

Articulation AR G

OE 1K0199231J

Left rear bush



2

1.4 TSi /Break	11/08-
1.6i /Break	06/04-
1.6 FSi /4WD /Break	02/04-10/08
1.8 TSi /4WD /Break	06/07-
1.9 TDi /4WD /Break	06/07-12/10
2.0 FSi/RS/4WD/Break	11/04-
2.0 TDi/RS/4WD/Break	02/04-

2256002

Articulation AR D

OE 1K0199232J

Right rear bush



2

1.4 TSi /Break	11/08-
1.6i /Break	06/04-
1.6 FSi /4WD /Break	02/04-10/08
1.8 TSi /4WD /Break	06/07-
1.9 TDi /4WD /Break	06/07-12/10
2.0 FSi/RS/4WD/Break	11/04-
2.0 TDi/RS/4WD/Break	02/04-

Bras & Triangle de suspension

Control arm
Brazo y triángulo
Wahacz
Рычаг подвески

G/L  D/R

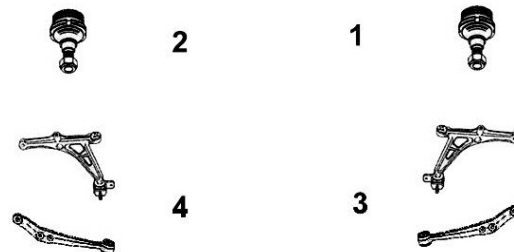

9005136

Triangle de susp. G/D

OE 1J0407151

L/R track control arm



3
4 Sans rotule Without tie rod end

TT /all models

11/96-05/04

... Octavia ...

SKODA



7476118		Triangle de susp. G		7476119		Triangle de susp. D	
OE 1J0407151C+1J0407365H		<i>Left track control arm</i>		OE 1J0407151C+1J0407366H		<i>Right track control arm</i>	
NEW	3	Avec rotule <i>With ball joint</i>		NEW	4	Avec rotule <i>With ball joint</i>	
		TT /all models	11/96-05/04			TT /all models	11/96-05/04
7476018		Triangle de susp. G		7476017		Triangle de susp. D	
OE 1K0407151AC		<i>Left track control arm</i>		OE 1K0407152AD		<i>Right track control arm</i>	
	4	Fonte Iron Sans rotule <i>Without ball joint</i>			3	Fonte Iron Sans rotule <i>Without ball joint</i>	
		1.6i /Break	06/04-			1.6i /Break	06/04-
		1.6 FSi /Break	06/04-10/08			1.6 FSi /Break	06/04-10/08
		1.8 TFSi /Break	07/07-10/08			1.8 TFSi /Break	07/07-10/08
		1.9 TDi/Break/4WD Break	06/04-			1.9 TDi/Break/4WD Break	06/04-
		2.0 FSi /Break	10/04-06/07			2.0 FSi /Break	10/04-06/07
		2.0 TFSi /Break	10/05-10/08			2.0 TFSi /Break	10/05-10/08
		2.0 TDi/Break/4WD Break	06/04-			2.0 TDi/Break/4WD Break	06/04-
7476128		Triangle de susp. G		7476127		Triangle de susp. D	
OE 1K0407151AC+1K0407365C		<i>Left track control arm</i>		OE 1K0407152AC+1K0407366C		<i>Right track control arm</i>	
NEW	4	Avec rotule <i>With ball joint</i>		NEW	3	Avec rotule <i>With ball joint</i>	
		1.6i	01/05-			1.6i	01/05-
		1.6 FSi /Break	06/04-10/08			1.6 FSi /Break	06/04-10/08
		1.8 TFSi /Break	07/07-10/08			1.8 TFSi /Break	07/07-10/08
		1.9 TDi/Break/4WD break	06/04-			1.9 TDi/Break/4WD break	06/04-
		2.0 FSi /Break	10/04-06/07			2.0 FSi /Break	10/04-06/07
		2.0 TFSi /Break	10/05-10/08			2.0 TFSi /Break	10/05-10/08
		2.0 TDi/Break/4WD Break	06/04-			2.0 TDi/Break/4WD Break	06/04-
9005266		Rotule de susp. inf. G		9005267		Rotule de susp. inf. D	
OE 1J0407365J		<i>Left lower suspension ball joint</i>		OE 1J0407366J		<i>Right lower suspension ball joint</i>	
	2	Axe Ø 18			1	Axe Ø 18	
		TT /all models	11/96-05/04			TT /all models	11/96-05/04
9005570		Rotule de susp. inf. G		9005569			
OE 1K0407365C		<i>Left lower suspension ball joint</i>		Rotule de susp. inf. D			
		2		<i>Right lower suspension ball joint</i>			
		1.2 TSi /Break		1			
		1.4 TSi		1.2 TSi /Break			
		1.6i		1.4 TSi			
		1.6 FSi /Break		1.6i			
		1.6 TDi		1.6 FSi /Break			
		1.8 TFSi /Break		1.6 TDi			
		1.9 TDi /Break /4WD Break		1.8 TFSi /Break			
		2.0 FSi /Break		1.9 TDi /Break /4WD Break			
		2.0 TFSi /Break		2.0 FSi /Break			
		2.0 TDi /Break /4WD Break		2.0 TFSi /Break			
				2.0 TDi /Break /4WD Break			
				03/10-			
				10/08-			
				01/05-			
				06/04-10/08			
				10/09-			
				07/07-			
				06/04-			
				10/04-06/07			
				10/05-			
				06/04-			

... Octavia ...







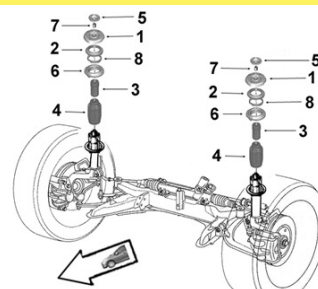

SASIC

SKODA

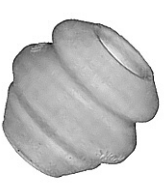
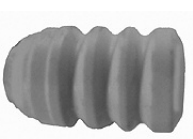

Support d'amortisseur
Suspension mounting
Soporte amortiguador
Poduszka amortyzatora
Опора амортизатора



<p>9005614 OE 1J0412331C</p> 	<p>Tampon suspension AV G/D <i>L/R front suspension rebound stop</i></p> <p>1</p> <table border="1"> <tr><td>1.6</td><td>-12/00</td></tr> <tr><td>1.8i 20v.</td><td>-12/00</td></tr> <tr><td>1.8i 20v. Turbo</td><td>06/99-06/10</td></tr> <tr><td>1.9 TDi Phase 1</td><td>05/97-06/10</td></tr> <tr><td>2.0</td><td>10/00-06/10</td></tr> </table>	1.6	-12/00	1.8i 20v.	-12/00	1.8i 20v. Turbo	06/99-06/10	1.9 TDi Phase 1	05/97-06/10	2.0	10/00-06/10	<p>9005622 OE 1K0412331B</p> 	<p>Support suspension G/D <i>L/R suspension mounting</i></p> <p>1</p> <table border="1"> <tr><td>1.4 TSi</td><td>10/08-</td></tr> <tr><td>1.6i</td><td>06/04-</td></tr> <tr><td>1.6 FSi</td><td>06/04-10/08</td></tr> <tr><td>1.8 TFSi</td><td>07/07-</td></tr> <tr><td>1.9 TDi Phase 2</td><td>06/04-</td></tr> <tr><td>2.0 FSi</td><td>10/04-06/07</td></tr> <tr><td>2.0 TFSi</td><td>10/05-</td></tr> <tr><td>2.0 TDi</td><td>06/04-</td></tr> </table>	1.4 TSi	10/08-	1.6i	06/04-	1.6 FSi	06/04-10/08	1.8 TFSi	07/07-	1.9 TDi Phase 2	06/04-	2.0 FSi	10/04-06/07	2.0 TFSi	10/05-	2.0 TDi	06/04-				
1.6	-12/00																																
1.8i 20v.	-12/00																																
1.8i 20v. Turbo	06/99-06/10																																
1.9 TDi Phase 1	05/97-06/10																																
2.0	10/00-06/10																																
1.4 TSi	10/08-																																
1.6i	06/04-																																
1.6 FSi	06/04-10/08																																
1.8 TFSi	07/07-																																
1.9 TDi Phase 2	06/04-																																
2.0 FSi	10/04-06/07																																
2.0 TFSi	10/05-																																
2.0 TDi	06/04-																																
<p>9005352 OE 1J0412249</p> 	<p>Butée à billes G/D <i>L/R ball bearing</i></p> <p>2</p> <table border="1"> <tr><td>1.6</td><td>10/00-06/10</td></tr> <tr><td>1.8i 20v.</td><td>-10/00</td></tr> <tr><td>1.8i 20v. Turbo</td><td>10/00-</td></tr> <tr><td>1.9 SDi</td><td>-10/00</td></tr> <tr><td>1.9 TDi</td><td></td></tr> <tr><td>2.0</td><td>10/00-</td></tr> </table>	1.6	10/00-06/10	1.8i 20v.	-10/00	1.8i 20v. Turbo	10/00-	1.9 SDi	-10/00	1.9 TDi		2.0	10/00-	<p>2656052 OE 1K0412303B</p> 	<p>Butée de suspension <i>Shock bush</i></p> <p>3 H70</p> <table border="1"> <tr><td>1.2i Turbo /Break</td><td>03/10-</td></tr> <tr><td>1.4 TSi /Break</td><td>10/08-</td></tr> <tr><td>1.6i /Break</td><td>06/04-</td></tr> <tr><td>1.6 FSi /Break</td><td>06/04-10/08</td></tr> <tr><td>1.6 TDi /Break</td><td>10/09-</td></tr> <tr><td>1.8 TFSi /Break</td><td>07/07-</td></tr> <tr><td>1.9 TDi /4WD /Break</td><td>06/04-</td></tr> <tr><td>2.0 FSi /Break</td><td>10/04-06/07</td></tr> <tr><td>2.0 TDi /4WD /Break</td><td>06/04-</td></tr> </table>	1.2i Turbo /Break	03/10-	1.4 TSi /Break	10/08-	1.6i /Break	06/04-	1.6 FSi /Break	06/04-10/08	1.6 TDi /Break	10/09-	1.8 TFSi /Break	07/07-	1.9 TDi /4WD /Break	06/04-	2.0 FSi /Break	10/04-06/07	2.0 TDi /4WD /Break	06/04-
1.6	10/00-06/10																																
1.8i 20v.	-10/00																																
1.8i 20v. Turbo	10/00-																																
1.9 SDi	-10/00																																
1.9 TDi																																	
2.0	10/00-																																
1.2i Turbo /Break	03/10-																																
1.4 TSi /Break	10/08-																																
1.6i /Break	06/04-																																
1.6 FSi /Break	06/04-10/08																																
1.6 TDi /Break	10/09-																																
1.8 TFSi /Break	07/07-																																
1.9 TDi /4WD /Break	06/04-																																
2.0 FSi /Break	10/04-06/07																																
2.0 TDi /4WD /Break	06/04-																																
<p>9005338 OE 1H0412303B</p> 	<p>Butée de suspension <i>Shock bush</i></p> <p>3 H64</p> <table border="1"> <tr><td>1.6</td><td>05/97-06/10</td></tr> <tr><td>1.8i 20v.</td><td>-10/00</td></tr> <tr><td>1.8i 20v. Turbo</td><td>06/99-06/10</td></tr> <tr><td>1.9 SDi</td><td>-10/00</td></tr> <tr><td>1.9 TDi</td><td>05/97-06/10</td></tr> <tr><td>2.0</td><td>10/00-06/10</td></tr> </table>	1.6	05/97-06/10	1.8i 20v.	-10/00	1.8i 20v. Turbo	06/99-06/10	1.9 SDi	-10/00	1.9 TDi	05/97-06/10	2.0	10/00-06/10	<p>2656003 OE 1J0412303</p> 	<p>Butée de suspension <i>Shock bush</i></p> <p>3 H53</p> <table border="1"> <tr><td>1.8i 20v. Turbo /Break</td><td></td></tr> <tr><td>BVM</td><td>03/01-06/04</td></tr> </table>	1.8i 20v. Turbo /Break		BVM	03/01-06/04														
1.6	05/97-06/10																																
1.8i 20v.	-10/00																																
1.8i 20v. Turbo	06/99-06/10																																
1.9 SDi	-10/00																																
1.9 TDi	05/97-06/10																																
2.0	10/00-06/10																																
1.8i 20v. Turbo /Break																																	
BVM	03/01-06/04																																
<p>9005363 OE 357412303F</p> 	<p>Butée de suspension G/D <i>L/R suspension bush</i></p> <p>3 H83</p> <table border="1"> <tr><td>1.8i 20v. Turbo 4WD</td><td>09/01-02/02</td></tr> <tr><td>1.9 TDi 4WD</td><td>10/00-06/04</td></tr> <tr><td>2.0 4WD</td><td>10/00-09/01</td></tr> </table>	1.8i 20v. Turbo 4WD	09/01-02/02	1.9 TDi 4WD	10/00-06/04	2.0 4WD	10/00-09/01	<p>9005334 OE 1K0412303F</p> 	<p>Butée de suspension <i>Shock bush</i></p> <p>3 H55 Châssis Sport</p> <table border="1"> <tr><td>1.8 TFSi</td><td>07/07-10/08</td></tr> <tr><td>1.9 TDi</td><td>06/04-10/08</td></tr> <tr><td>2.0 FSi</td><td>10/04-06/07</td></tr> <tr><td>2.0 TFSi</td><td>10/05-</td></tr> <tr><td>2.0 TDi</td><td>06/04-</td></tr> </table>	1.8 TFSi	07/07-10/08	1.9 TDi	06/04-10/08	2.0 FSi	10/04-06/07	2.0 TFSi	10/05-	2.0 TDi	06/04-														
1.8i 20v. Turbo 4WD	09/01-02/02																																
1.9 TDi 4WD	10/00-06/04																																
2.0 4WD	10/00-09/01																																
1.8 TFSi	07/07-10/08																																
1.9 TDi	06/04-10/08																																
2.0 FSi	10/04-06/07																																
2.0 TFSi	10/05-																																
2.0 TDi	06/04-																																
<p>2656053 OE 6N0413175A</p> 	<p>Protecteur amortisseur G/D <i>L/R shock absorber protector</i></p> <p>4 H206</p> <table border="1"> <tr><td>1.2i Turbo /Break</td><td>03/10-</td></tr> <tr><td>1.4 TSi /Break</td><td>10/08-</td></tr> <tr><td>1.6i /Break</td><td>06/04-</td></tr> <tr><td>1.6 FSi /Break</td><td>06/04-10/08</td></tr> <tr><td>1.6 TDi /Break</td><td>10/09-</td></tr> <tr><td>1.8 TFSi /Break</td><td>07/07-</td></tr> <tr><td>1.9 TDi /4WD /Break</td><td>06/04-</td></tr> <tr><td>2.0 FSi /Break</td><td>10/04-06/07</td></tr> <tr><td>2.0 TFSi /Break</td><td>10/05-</td></tr> <tr><td>2.0 TDi /4WD Break</td><td>06/04-</td></tr> </table>	1.2i Turbo /Break	03/10-	1.4 TSi /Break	10/08-	1.6i /Break	06/04-	1.6 FSi /Break	06/04-10/08	1.6 TDi /Break	10/09-	1.8 TFSi /Break	07/07-	1.9 TDi /4WD /Break	06/04-	2.0 FSi /Break	10/04-06/07	2.0 TFSi /Break	10/05-	2.0 TDi /4WD Break	06/04-	<p>9005327 OE 357413175A</p> 	<p>Protecteur amortisseur G/D <i>L/R shock absorber protector</i></p> <p>4 H221.5</p> <table border="1"> <tr><td>1.6</td><td>-10/00</td></tr> <tr><td>1.8i 20v.</td><td>-10/00</td></tr> <tr><td>1.8i 20v. Turbo</td><td>-10/00</td></tr> <tr><td>1.9 SDi</td><td>-10/00</td></tr> <tr><td>1.9 TDi</td><td>-10/00</td></tr> </table>	1.6	-10/00	1.8i 20v.	-10/00	1.8i 20v. Turbo	-10/00	1.9 SDi	-10/00	1.9 TDi	-10/00
1.2i Turbo /Break	03/10-																																
1.4 TSi /Break	10/08-																																
1.6i /Break	06/04-																																
1.6 FSi /Break	06/04-10/08																																
1.6 TDi /Break	10/09-																																
1.8 TFSi /Break	07/07-																																
1.9 TDi /4WD /Break	06/04-																																
2.0 FSi /Break	10/04-06/07																																
2.0 TFSi /Break	10/05-																																
2.0 TDi /4WD Break	06/04-																																
1.6	-10/00																																
1.8i 20v.	-10/00																																
1.8i 20v. Turbo	-10/00																																
1.9 SDi	-10/00																																
1.9 TDi	-10/00																																

... Octavia ...



Barre stabilisatrice
 Stabilizer bar
 Barra estabilizadora
 Drażek stabilizatora
 стабилизатор поперечной устойчивости

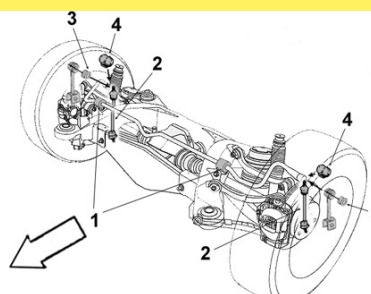

SKODA



9005094 **Biellette barre stab.**
 OE 1K0505465K *Stabilizer bar stub axle*



2	1.2 TSi /Break	02/10-
	1.4 TSi /Break	11/08-
	1.6i /Break	06/04-
	1.6 FSi /Break	02/04-10/08
	1.6 TDi /4WD /Break	06/09-
	1.8 TSi /4WD /Break	06/07-
	1.9 TDi /4WD /Break	06/04-12/10
	2.0 FSi /RS /4WD /Break	11/04-
	2.0 TDi /RS /4WD /Break	02/04-

9001739 **Palier de barre milieu**
 OE 1K0511327AP *Middle bar main bearing*



1	Barre Ø 18.5	
	1.6i /Break	06/04-
	1.6 FSi /Break	02/04-10/08
	1.8 TSi /Break	06/07-
	1.9 TDi /4WD /Break	06/04-12/10
	2.0 FSi/RS/4WD/Break	11/04-
	2.0 TDi/RS/4WD/Break	02/04-

2306013 **Palier de barre milieu**
 OE 1K0511327AQ *Middle bar main bearing*



1	Barre Ø 19.6	
	1.4 TSi /Break	10/08-
	1.6i /Break	06/04-
	1.6 FSi /Break	02/04-10/08
	1.8 TSi /4WD /Break	06/07-
	1.9 TDi /4WD /Break	06/04-12/10
	2.0 FSi/RS/4WD/Break	11/04-
	2.0 TDi/RS/4WD/Break	02/04-

9001737 **Palier de barre milieu**
 OE 1K0511327AR *Middle bar main bearing*



1	Barre Ø 20.7	
	1.4 TSi /Break	10/08-
	1.6i /Break	06/04-
	1.6 FSi /Break	02/04-10/08
	1.8 TSi /Break	06/07-
	1.9 TDi /4WD /Break	06/04-12/10
	2.0 FSi/RS/4WD/Break	11/04-
2.0 TDi/RS/4WD/Break	02/04-	

2306014 **Palier de barre milieu**
 OE 1K0511327AS *Middle bar main bearing*



1	Barre Ø 21.7	
	1.4 TSi /Break	10/08-
	1.6i /Break	06/04-
	1.6 FSi /Break	02/04-10/08
	1.8 TSi /Break	06/07-
	1.9 TDi /4WD /Break	06/04-12/10
	2.0 FSi/RS/4WD/Break	11/04-
	2.0 TDi/RS/4WD/Break	02/04-



Support d'amortisseur
 Suspension mounting
 Soporte amortiguador
 Poduszka amortyzatora
 Опора амортизатора

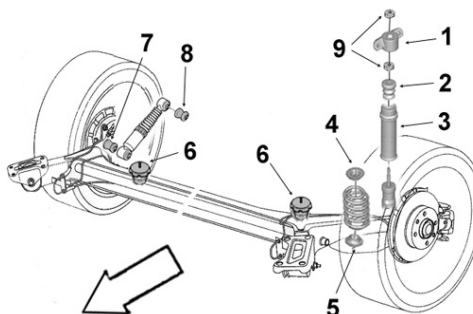

9005630 **Support suspension G/D**
 OE 1J0513353B *L/R suspension mounting*



1	1.6	Ch- 1U-V-028927	05/97-10/00
	1.8i 20v./ Turbo		05/97-10/00
	1.9 TDi	Ch- 1U-V-028927	05/97-10/00

9005328 **Butée de suspension G/D**
 OE 1J0512131B *L/R suspension bush*



2	H 129		
	1.6i	Ch- 1U-W-084581	05/97-06/10
	1.8i 20v./ Turbo	Ch- 1U-W-084581	05/97-06/10
	1.9 TDi	Ch- 1U-W-084581	05/97-10/10
	2.0i		10/00-06/10

... Octavia



Support d'amortisseur
 Suspension mounting
 Soporte amortiguador
 Poduszka amortyzatora
 Опора амортизатора

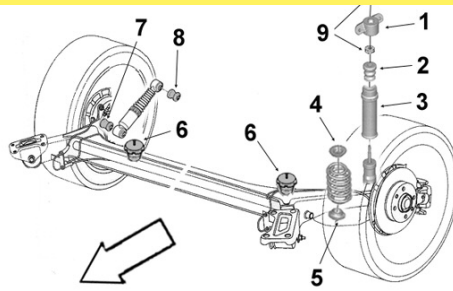

2656051 **Butée de suspension**
 OE 1K0511353P *Shock bush*



2 H 133
 -ch 1Z-6A151261 1Z-62261242 1Z-68086262
 1.4 TSi /Break 10/08-
 1.6i /Break 06/04-10/08
 1.6 FSi /Break 06/04-10/08
 1.8 TFSi /Break 07/07-
 1.9 TDi /Break 06/04-
 2.0 FSi /Break 10/04-06/07
 2.0 TDi /4WD /Break 06/04-

Eléments TRAIN ARRIERE
 Rear axle parts
 Tren TRAS
 Elementy zawieszenia tylnego
 элементы задней оси.



2606001 **Articulation traverse**
 OE 6R0501541A *Cross bar bush*



Ø int. 12 Ø ext. 71.5 coll. 80
long. tube int. 90 ext. 54.5
 1.6i 05/97-10/00
 1.8i 20v. 05/97-10/00
 1.8i 20v. Turbo 06/99-10/00
 1.9 TDi BVM 05/97-10/00

9001786 **Articulation essieu G/D inf.**
 OE 1K0505553A *Lower L/R axle bush*



Ø int. 12 Ø ext. 37 long. tube int. 50 ext. 28
 1.4 TSi /Break 10/08-
 1.6i /Break 06/04-
 1.6 FSi /Break 02/04-10/08
 1.8 TSi /4WD /Break 06/07-
 1.9 TDi /4WD /Break 06/04-12/10
 2.0 FSi/RS/4WD/Break 11/04-
 2.0 TDi/RS/4WD/Break 02/04-

Rapid ...

Eléments DIRECTION
 Steering parts
 Elementos Direcciones
 Elementy uklad kierowniczy
 Элементы рулевой системы

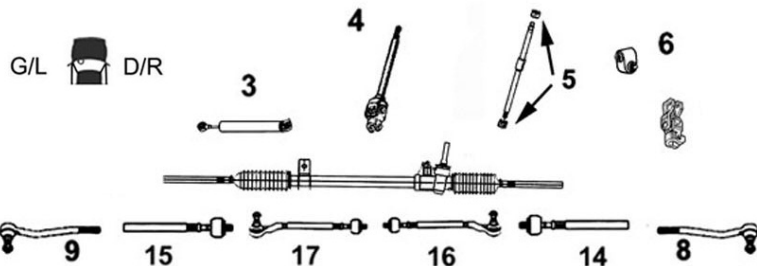

7776079 **Axe de bielle G/D**
 Part/oe 6R0423803A *L/R axial joint*

NEW



14 Côté dir. M14x1.5 Côté rot. M14x1.5 long 310 mm
15
 1.2i 10/12-
 1.2 TSi 10/12-
 1.4 TSi 10/12-
 1.6 TDi 10/12-

... Rapid ...

SKODA



9006634 Rotule de direction G OE 6R0423811 <i>Left tie rod end</i>	9006635 Rotule de direction D OE 6R0423812 <i>Right tie rod end</i>
9 M14 x 1.5 1.2i 1.2 TSi 1.4 TSi 1.6 TDi FAP	8 M14 x 1.5 1.2i 1.2 TSi 1.4 TSi 1.6 TDi FAP

Eléments SUSPENSION
Suspension parts
Elementos suspensión
Elementy zawieszenie
Элементы подвески

9001523 Articulation AV OE 357407182 <i>Front bush</i>	9001542 Articulation AR OE 1J0407181 <i>Rear bush</i>
1 Ø int.12 Ø ext.33 coll.36 long. tube int.54 ext.29 ep. coll.5 1.2i /TSi 1.4 TSi 1.6 TDi	2 Ø int.13 Ø ext.59.5 long. tube int.41 ext.23.5 1.2i /TSi 1.4 TSi 1.6 TDi

Bras & Triangle de suspension
Control arm
Brazo y triángulo
Wahacz
Рычаг подвески

G/L D/R

7576019 Rotule de susp. inf. G OE 6R0407365A <i>Left lower suspension ball joint</i>	
2 1.2i 1.2 TSi 1.4 TSi 1.6 TDi	10/12- 10/12- 10/12- 10/12-

7576020 Rotule de susp. inf. D OE 6R0407366A <i>Right lower suspension ball joint</i>	
1 1.2i 1.2 TSi 1.4 TSi 1.6 TDi	10/12- 10/12- 10/12- 10/12-

... Rapid



Support d'amortisseur
Suspension mounting
Soporte amortiguador
Poduszka amortyzatora
Опора амортизатора

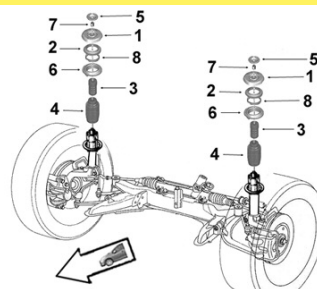

9005327

Protecteur amortisseur G/D

OE 357413175A

L/R shock absorber protector

4 H221.5



1.2i /TSi
 1.4 TSi
 1.6 TDi

Roomster...

Eléments DIRECTION

Steering parts

Elementos Direcciones

Elementy uklad kierowniczy

Элементы рулевой системы

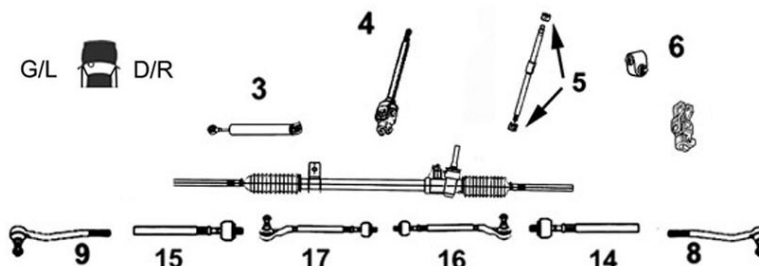

9006874

Axe de bielle G/D

OE 6Q0423810C

L/R axial joint



14 Côté dir. M16x1.5 Côté rot. M14x1.5 long 299 mm
15 Dir. SMI Koyo

1.2i
 1.2i 12v.
 1.4i
 1.4 TDi
 1.6i
 1.9 TDi

12/06-09/10
 12/06-09/10
 09/06-09/10
 09/06-09/10
 09/06-09/10
 03/06-09/10

9006634

Rotule de direction G

OE 6Q0423811C

Left tie rod end

9 M14 x 1.5



1.2i	12/06-
1.2 TSi	10/10-
1.2 TDi FAP	10/10-
1.4i	09/06-
1.4 TDi	01/07-09/10
1.6i	09/06-09/10
1.6 TDi FAP	10/10-
1.9 TDi	03/06-09/10

9006635

Rotule de direction D

OE 6Q0423812C

Right tie rod end

8 M14 x 1.5



1.2i	12/06-
1.2 TSi	10/10-
1.2 TDi FAP	10/10-
1.4i	09/06-
1.4 TDi	01/07-09/10
1.6i	09/06-09/10
1.6 TDi FAP	10/10-
1.9 TDi	03/06-09/10

... Roomster ...



Barre stabilisatrice
 Stabilizer bar
 Barra estabilizadora
 Drażek stabilizatora
 стабилизатор поперечной устойчивости

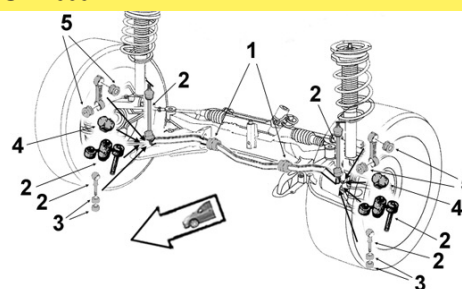

9005089 **Biellette barre stab.**
 OE 6Q0411315N *Stabilizer bar stub axle*



2

1.2i	09/06-
1.4i	09/06-
1.4 TDi	09/06-
1.6i	09/06-
1.9 TDi	09/06-

2306019 **Palier de barre milieu**
 OE 6Q0411314R *Middle bar main bearing*



1 Barre Ø 18

1.2i	05/06-
1.2 TSi	03/10-
1.2 TDi	03/10-
1.4i	09/06-
1.4 TDi	07/06-03/10
1.6i	09/06-
1.6 TDi	03/10-
1.9 TDi	09/06-03/10



Eléments SUSPENSION
 Suspension parts
 Elementos suspensión
 Elementy zawieszenie
 Элементы подвески

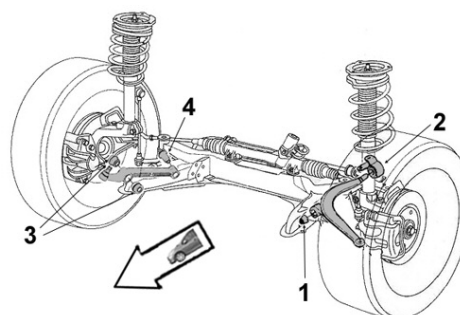

9001523 **Articulation AV**
 OE 357407182 *Front bush*



1 Ø int.12 Ø ext.33 coll.36
 long. tube int.54 ext.29 ep. coll.5

1.2i Ch- 5J-8B600705/5J-85069021	
1.2 TSi TDi	03/10-
1.4i Ch- 5J-8B600705/5J-85069021	
1.4 TDi Ch- 5J-8B600705/5J-85069021	
1.6i Ch- 5J-8B600705/5J-85069021	
1.6 TDi	03/10-
1.9 TDi Ch- 5J-8B600705/5J-85069021	-03/10

9001542 **Articulation AR**
 OE 1J0407181 *Rear bush*



2 Ø int.13 Ø ext.59.5
 long. tube int.54 ext.29 ep. coll.5

1.2i Ch- 5J-8B600705/5J-85069021	
1.2 TSi TDi	03/10-
1.4i Ch- 5J-8B600705/5J-85069021	
1.4 TDi Ch- 5J-8B600705/5J-85069021	
1.6i Ch- 5J-8B600705/5J-85069021	
1.6 TDi	03/10-
1.9 TDi Ch- 5J-8B600705/5J-85069021	-03/10

Bras & Triangle de suspension

Control arm
 Brazo y triángulo
 Wahacz
 Рычаг подвески

G/L D/R

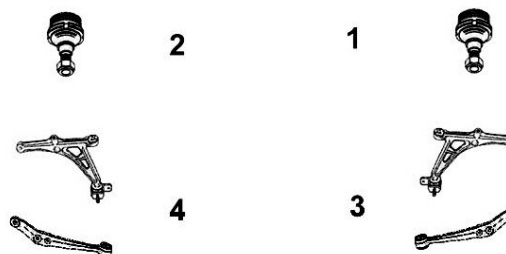

9005758 **Triangle de susp. inf. G/D**
 OE 6Q0407151L *Lower L/R track control arm*



3 Sans rotule Without ball joint

1.2i	09/06-16/03/08
1.4i	09/06-16/03/08
1.4 TDi	09/06-16/03/08
1.6i	09/06-16/03/08
1.9 TDi	09/06-16/03/08

... Roomster ...

Bras & Triangle de suspension

Control arm
Brazo y triángulo
Wahacz
Рычаг подвески

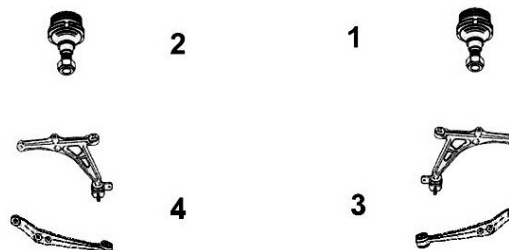
G/L  D/R

7476123 Triangle de susp. G
OE 6Q0407151L+6Q0407365M Left track control arm

NEW

**4** Avec rotule With ball joint

1.4i	09/06-
1.4 TDi	09/06-
1.6i	09/06-
1.9 TDi	09/06-

7476122 Triangle de susp. D
OE 6Q0407151L+6Q0407366M Right track control arm

NEW

**3** Avec rotule With ball joint

1.4i	09/06-
1.4 TDi	09/06-
1.6i	09/06-
1.9 TDi	09/06-

7476183 Triangle de susp. inf. G
OE 6R0407151F+6R0407365A Lower left track control arm

NEW

**4** Avec rotule With ball joint

1.2i	10/10-
1.2 TSi	10/10-
1.2 TDi FAP	10/10-
1.4i	10/10-
1.4 TDi /FAP	03/08-09/10
1.6i	03/08-09/10
1.6 TDi FAP	10/10-
1.9 TDi	03/08-09/10

7476184 Triangle de susp. inf. D
OE 6R0407152F+6R0407366A Lower right track control arm

NEW

**3** Avec rotule With ball joint

1.2i	10/10-
1.2 TSi	10/10-
1.2 TDi FAP	10/10-
1.4i	10/10-
1.4 TDi /FAP	03/08-09/10
1.6i	03/08-09/10
1.6 TDi FAP	10/10-
1.9 TDi	03/08-09/10

9005478 Rotule de susp. inf. G
OE 6Q0407365M Left lower suspension ball joint

9

1.2i	-16/03/08
1.4i	-16/03/08
1.4 TDi	-16/03/08
1.6i	-16/03/08
1.9 TDi	-16/03/08

9005479 Rotule de susp. inf. D
OE 6Q0407366M Right lower suspension ball joint

1

1.2i	-16/03/08
1.4i	-16/03/08
1.4 TDi	-16/03/08
1.6i	-16/03/08
1.9 TDi	-16/03/08

7576019 Rotule de susp. inf. G
OE 6R0407365A Left lower suspension ball joint

2

NEW



1.2i /12v.	03/08-
1.2 TSi	10/10-
1.2 TDi FAP	10/10-
1.4i	03/08-
1.4 TDi /FAP	03/08-09/10
1.6i	03/08-09/10
1.6 TDi FAP	10/10-
1.9 TDi	03/08-09/10

7576020 Rotule de susp. inf. D
OE 6R0407366A Right lower suspension ball joint

1

NEW



1.2i /12v.	03/08-
1.2 TSi	10/10-
1.2 TDi FAP	10/10-
1.4i	03/08-
1.4 TDi /FAP	03/08-09/10
1.6i	03/08-09/10
1.6 TDi FAP	10/10-
1.9 TDi	03/08-09/10

... Roomster





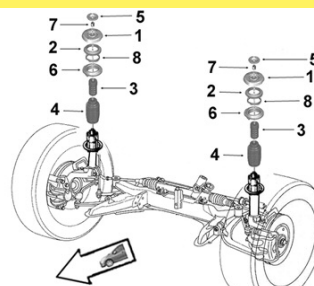

Support d'amortisseur

Suspension mounting
Soporte amortiguador
Poduszka amortyzatora
Опора амортизатора



SKODA





9005623 OE 6N0412331E	Support suspension G/D <i>L/R suspension mounting</i>	9005614 OE 1J0412331C	Tampon suspension AV G/D <i>L/R front suspension rebound stop</i>
	1 Châssis standard -ch 5J-9B601131 /5J-95032164 1.2i 05/06- 1.4i 09/06- 1.4 TDi 07/06- 1.6i 09/06- 1.9 TDi 09/06-		1 Ch-5J-9B601132/5J-95032165 1.2i /TSi 1.4i 1.4 TDi 1.6i 1.9 TDi 1.2 TDi 10/10- 1.6 TDi 10/10-
9005352 OE 1J0412249	Butée à billes G/D <i>L/R ball bearing</i>	2656053 OE 6N0413175A	Protecteur amortisseur G/D <i>L/R shock absorber protector</i>
	2 Ch-5J-9B601132/5J-95032165 1.2i 1.4i 1.4 TDi 1.6i 1.9 TDi		4 H206 -ch 5J-9B601131 /5J-95032164 1.2i 09/06- 1.4i 09/06- 1.4 TDi 09/06- 1.6 09/06- 1.9 TDi 03/06-
9005327 OE 357413175A	Protecteur amortisseur G/D <i>L/R shock absorber protector</i>		
	4 H221.5 Ch-5J-9B601132/5J-95032165 1.2i /TSi 1.2 TDi 10/10- 1.4i 1.4 TDi 1.6i 1.6 TDi 10/10-		

Superb ...

Eléments DIRECTION

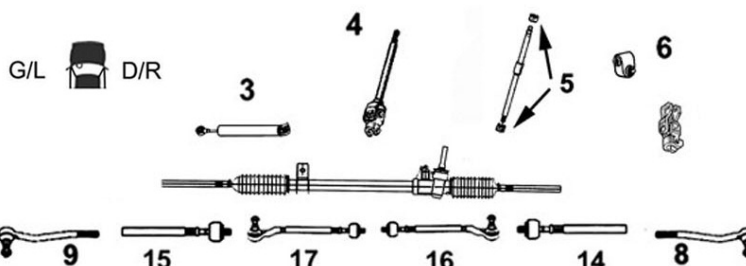
Steering parts
Elementos Direcciones
Elementy układ kierowniczy
Элементы рулевой системы



9006873 OE 1K0423810A	Axe de bielle G/D <i>L/R axial joint</i>		
	14 Côté dir. M16x1.5 Côté rot. M16x1.5 long 310 mm 15 1.4 TFSi 06/08- 1.4 TSi Break 10/09- 1.8 TFSi /4WD /Break 06/08- 1.9 TDi 105hp 77kw /Break 06/08- 2.0 TDi /4WD /Break 06/08- 3.6 FSi 4WD /Break 06/08-		

... Superb ...

Eléments DIRECTION
Steering parts
Elementos Direcciones
Elementy układ kierowniczy
Элементы рулевой системы

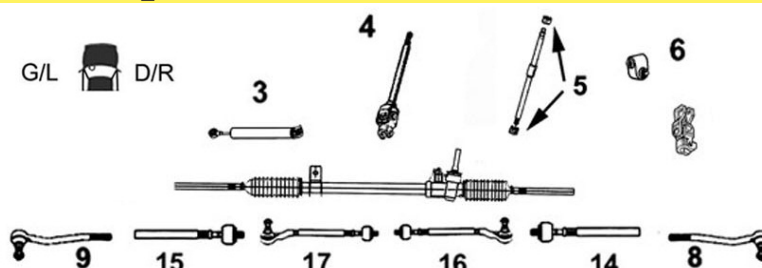

9006640 Rotule de direction G

OE 1K0423811G *Left tie rod end*



9 M16 x 1.5
-ch 18APR2010 DA

1.4 TFSI	06/08-
1.8 TFSi /4WD	06/08-
1.9 TDi	06/08-
2.0 TDi /4WD	06/08-
3.6 FSi 4WD	06/08-

9006639 Rotule de direction D

OE 1K0423812G *Right tie rod end*



8 M16 x 1.5
-ch 18APR2010 DA

1.4 TFSI	06/08-
1.8 TFSi /4WD	06/08-
1.9 TDi	06/08-
2.0 TDi /4WD	06/08-
3.6 FSi 4WD	06/08-

9006638 Rotule de direction G

OE 1K0423811K *Left tie rod end*



9 M16 x 1.5

1.4 TFSi / Break	19/04/10-
1.8 TFSi / Break /4WD	19/04/10-
1.9 TDi / Break BXE	19/04/10-
1.9 TDi FAP BLS	19/04/10-
2.0 TDi/FAP/Break/4WD	19/04/10-
3.6 FSi 4WD / Break	19/04/10-

9006637 Rotule de direction D

OE 1K0423812K *Right tie rod end*



8 M16 x 1.5

1.4 TFSi / Break	19/04/10-
1.8 TFSi / Break /4WD	19/04/10-
1.9 TDi / Break BXE	19/04/10-
1.9 TDi FAP BLS	19/04/10-
2.0 TDi/FAP/Break/4WD	19/04/10-
3.6 FSi 4WD / Break	19/04/10-



Barre stabilisatrice
Stabilizer bar
Barra estabilizadora
Drażek stabilizatora
стабилизатор поперечной устойчивости

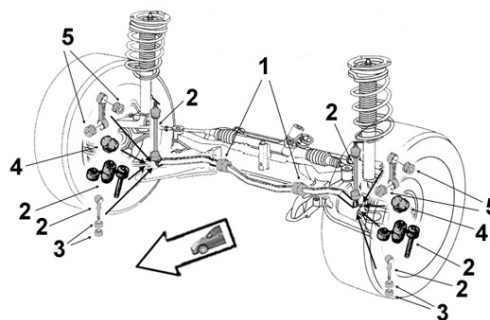

2306010 Biellette barre stab.

OE 1K0411315P *Stabilizer bar stub axle*



2

1.4 TSi /Break	06/08-
1.8 TSi /4WD /Break	03/08-
1.9 TDi /Break	03/08-
2.0 TDi /4WD /Break	03/08-
3.6 FSi 4WD /Break	11/08-

... Superb ...



Eléments SUSPENSION

Suspension parts

Elementos suspensión

Elementy zawieszenia

Элементы подвески

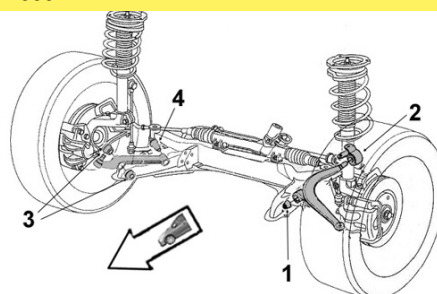

SKODA



9001759

Articulation AV

OE 1K0407182

Front bush



1 Ø int.12 Ø ext.40 coll.48 long. tube int.54 ext.33 ep. coll.6

1.4 TSi /Break
1.8 TSi /4WD /Break
1.9 TDi /Break
2.0 TDi /4WD /Break
3.6 FSi 4WD /Break

07/08-
03/08-
03/08-
03/08-
11/08-

2256003

Articulation AR G

OE 1K0199231J

Left rear bush



2

1.4 TFSi /Break 07/08-08/10
1.8 TSi /4WD /Break 03/08-08/10
1.9 TDi /Break 03/08-08/10
2.0 TDi /4WD /Break 03/08-08/10
3.6 FSi 4WD /Break 11/08-08/10

2256002

Articulation AR D

OE 1K0199232J

Right rear bush



2

1.4 TFSi /Break 07/08-08/10
1.8 TSi /4WD /Break 03/08-08/10
1.9 TDi /Break 03/08-08/10
2.0 TDi /4WD /Break 03/08-08/10
3.6 FSi 4WD /Break 11/08-08/10

Bras & Triangle de suspension

Control arm
Brazo y triángulo
Wahacz
Рычаг подвески

G/L D/R

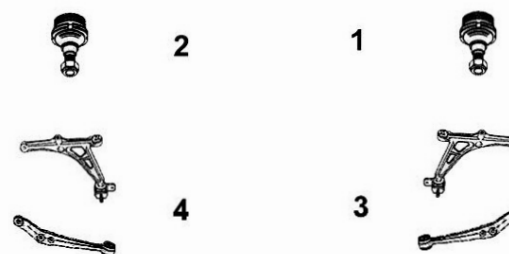

7476018

Triangle de susp. G

OE 1K0407151T

Left track control arm



4 Fonte Iron Sans rotule Without ball joint

1.4 TFSi 06/08-08/10
1.8 TFSi /4WD /Break 06/08-08/10
1.9 TDi /Break 06/08-08/10
2.0 TDi /4WD /Break 06/08-08/10
3.0 FSi 4WD /Break 06/08-08/10

7476017

Triangle de susp. D

OE 1K0407152T

Right track control arm



3 Fonte Iron Sans rotule Without ball joint

1.4 TFSi 06/08-08/10
1.8 TFSi /4WD /Break 06/08-08/10
1.9 TDi /Break 06/08-08/10
2.0 TDi /4WD /Break 06/08-08/10
3.0 FSi 4WD /Break 06/08-08/10

7476128

Triangle de susp. G

OE 1K0407151AC+1K0407365C *Left track control arm*

NEW



4 Avec rotule With ball joint

1.4 TFSi 06/08-08/10
1.8 TFSi /4WD /Break 06/08-08/10
1.9 TDi /Break 06/08-08/10
2.0 TDi /4WD /Break 06/08-08/10

7476127

Triangle de susp. D

OE 1K0407152AC+1K0407366C *Right track control arm*

NEW



3 Avec rotule With ball joint

1.4 TFSi 06/08-08/10
1.8 TFSi /4WD /Break 06/08-08/10
1.9 TDi /Break 06/08-08/10
2.0 TDi /4WD /Break 06/08-08/10

... Superb ...

SASIC









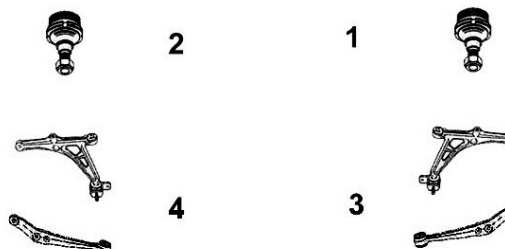

SKODA

Bras & Triangle de suspension

Control arm
Brazo y triángulo
Wahacz
Рычаг подвески

G/L  D/R



9005749 OE 8E0407509A	Bras de susp. AR sup. G <i>Left rear upper track control arm</i>	9005750 OE 8E0407510A	Bras de susp. AR sup. D <i>Right rear upper track control arm</i>
	4 Avec rotule With ball joint 1.8i 20v. Turbo 06/02-04/04 1.9 TDi 06/02-06/08 2.0i 06/02-04/04 2.0 TDi 01/06-06/08 2.5 TDi 06/02-06/07 2.8i V6 06/02-06/08		3 Avec rotule With ball joint 1.8i 20v. Turbo 06/02-04/04 1.9 TDi 06/02-06/08 2.0i 06/02-04/04 2.0 TDi 01/06-06/08 2.5 TDi 06/02-06/07 2.8i V6 06/02-06/08
9005140 OE 8E0407505A	Bras de susp. AV sup. G <i>Left front upper track control arm</i>	9005141 OE 8E0407506A	Bras de susp. AV sup. D <i>Right front upper track control arm</i>
	4 Avec rotule With ball joint 1.8i 20v. 06/02-04/04 1.9 TDi 06/02-06/08 2.0i 06/02-04/04 2.0 TDi 06/02-06/07 2.5 TDi 06/02-06/08 2.8i V6 01/06-06/08		3 Avec rotule With ball joint 1.8i 20v. 06/02-04/04 1.9 TDi 06/02-06/08 2.0i 06/02-04/04 2.0 TDi 06/02-06/07 2.5 TDi 06/02-06/08 2.8i V6 01/06-06/08
9005156 OE 8E0407693AG	Bras de susp. AR inf. G <i>Left rear lower track control arm</i>	9005154 OE 8E0407694AG	Bras de susp. AR inf. D <i>Right rear lower track control arm</i>
	4 Avec rotule With ball joint 1.8i 20v. Turbo 06/02-06/08 1.9 TDi 06/02-06/08 2.0i 06/02-04/04 2.0 TDi 01/06-06/08 2.5 TDi 06/02-06/07 2.8i V6 06/02-06/08		3 Avec rotule With ball joint 1.8i 20v. Turbo 06/02-06/08 1.9 TDi 06/02-06/08 2.0i 06/02-04/04 2.0 TDi 01/06-06/08 2.5 TDi 06/02-06/07 2.8i V6 06/02-06/08
9005157 OE 4D0407151P	Bras de susp. AV inf. G/D <i>L/R front lower track control arm</i>	7476033 OE 4B3407151K	Bras de susp. AV inf. G/D <i>L/R front lower track control arm</i>
	3 Avec rotule With ball joint 4 -ch 3U3021397 1.8i 20v. -04/04 1.9 TDi -12/05 2.0i -04/04 2.5 TDi -06/07 2.8i V6 -06/08		3 Avec rotule With ball joint 4 Ch- 3U-3-021398 1.8i 20v. Turbo -04/04 1.9 TDi -06/08 2.0i -04/04 2.0 TDi -06/08 2.5 TDi -06/07 2.8i V6 -06/08
9005570 OE 1K0407365C	Rotule de susp. inf. G <i>Left lower suspension ball joint</i>	9005569 OE 1K0407366C	Rotule de susp. inf. D <i>Right lower suspension ball joint</i>
	2 1.4 TFSi 06/08- 1.4 TSi Break 10/09- 1.8 TFSi /4WD /Break 06/08- 1.9 TDi /Break 06/08- 2.0 TDi /4WD /Break 06/08- 3.6 FSi 4WD /Break 06/08-		1 1.4 TFSi 06/08- 1.4 TSi Break 10/09- 1.8 TFSi /4WD /Break 06/08- 1.9 TDi /Break 06/08- 2.0 TDi /4WD /Break 06/08- 3.6 FSi 4WD /Break 06/08-

... Superb



Support d'amortisseur
Suspension mounting
Soporte amortiguador
Poduszka amortyzatora
Опора амортизатора

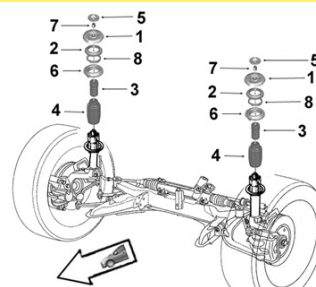

SKODA



9005622 **Support suspension G/D**
 OE 1K0412331B *L/R suspension mounting*



1

1.4 TFSi /Break	06/08-
1.4 TSi Break	10/09-
1.8 TFSi /4WD /Break	06/08-
1.9 TDi /Break	06/08-
2.0 TDi /4WD /Break	03/08-
3.6 FSi 4WD /Break	11/08-

9005326 **Butée de suspension G/D**
 OE 8D0412131F *L/R suspension bush*

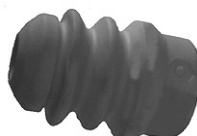

3 H85

1.8i 20v. Turbo	06/02-04/04
1.9 TDi	06/02-
2.0	06/02-04/04
2.0 TDi	01/06-06/08
2.5 TDi	06/02-06/07
2.8	06/02-06/08

2656052 **Butée de suspension**
 OE 1K0412303B *Shock bush*



3 H70

1.4 TFSi /Break	06/08-
1.8 TFSi /4WD /Break	06/08-
1.9 TDi /Break	06/08-
2.0 TDi /4WD /Break	06/08-
3.6 FSi 4WD /Break	06/08-

2656053 **Protecteur amortisseur G/D**
 OE 6N0413175A *L/R shock absorber protector*



4 H206

1.4 TFSi /Break	06/08-
1.8 TFSi /4WD /Break	06/08-
1.9 TDi /Break	06/08-
2.0 TDi /4WD /Break	06/08-
3.6 FSi 4WD /Break	06/08-



Barre stabilisatrice
Stabilizer bar
Barra estabilizadora
Drażek stabilizatora
стабилизатор поперечной устойчивости

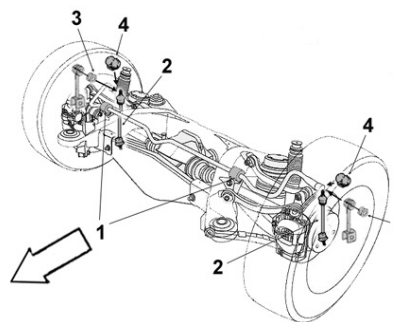

9005094 **Biellette barre stab.**
 OE 1K0505465K *Stabilizer bar stub axle*



2

1.4 TFSi /Break	07/08-
1.8 TSi /4WD /Break	03/08-
1.9 TDi /Break	03/08-
2.0 TDi /4WD /Break	03/08-
3.6 4WD /Break	11/08-

9001739 **Palier de barre milieu**
 OE 1K0511327AP *Middle bar main bearing*



1 Barre Ø 18.5

1.4 TFSi /Break	07/08-
1.8 TSi /4WD /Break	07/08-
1.9 TDi /Break	03/08-
2.0 TDi /4WD /Break	03/08-

Éléments TRAIN ARRIERE
Rear axle parts
Tren TRAS
Elementy zawieszenia tylnego
элементы задней оси.



9001786 **Articulation essieu G/D inf.**
 OE 1K0505553A *Lower L/R axle bush*
 Ø int. 12 Ø ext. 37 long. tube int. 50 ext. 28



1.4 TFSi	07/08-
1.8 TSi /4WD	07/08-
1.9 TDi	03/08-
2.0 TDi /4WD	03/08-
3.6 FSi 4WD	11/08-

Yeti ...

Eléments DIRECTION

Steering parts

Elementos Direcciones

Elementy układ kierowniczy

Элементы рулевой системы

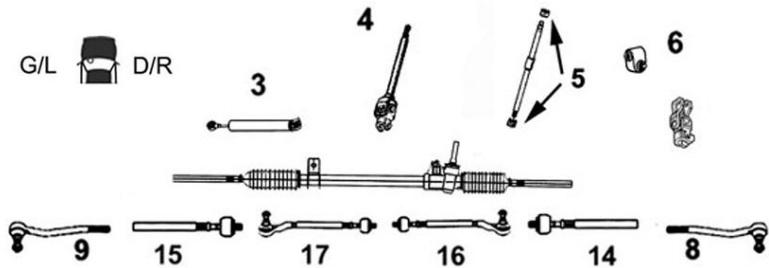

SASIC

SKODA

9006873

Axe de bielle G/D

OE 1K0423810A

L/R axial joint

14
15

Côté dir. M16x1.5 Côté rot. M16x1.5 long 310 mm



1.2 TSi
1.8 TFSi 4WD
2.0 TDi /4WD

09/09-
10/09-
09/09-

9006638

Rotule de direction G

OE 1K0423811K

Left tie rod end

9

M16 x 1.5



1.2 TSi 19/04/10-
1.8 TFSi 4WD 19/04/10-
2.0 TDi /FAP /4WD 19/04/10-

9006637

Rotule de direction D

OE 1K0423812K

Right tie rod end

8

M16 x 1.5



1.2 TSi 19/04/10-
1.8 TFSi 4WD 19/04/10-
2.0 TDi /FAP /4WD 19/04/10-

9006640

Rotule de direction G

OE 1K0423811G

Left tie rod end

9

M16 x 1.5



1.2 TSi DA -ch 18APR2010 09/09-
1.8 TFSi 4WD DA
-ch 18APR2010 10/09-
2.0 TDi /4WD DA
-ch 18APR2010 09/09-

9006639

Rotule de direction D

OE 1K0423812G

Right tie rod end

8

M16 x 1.5



1.2 TSi DA -ch 18APR2010 09/09-
1.8 TFSi 4WD DA
-ch 18APR2010 10/09-
2.0 TDi /4WD DA
-ch 18APR2010 09/09-



Barre stabilisatrice

Stabilizer bar

Barra estabilizadora

Drażek stabilizatora

стабилизатор поперечной устойчивости

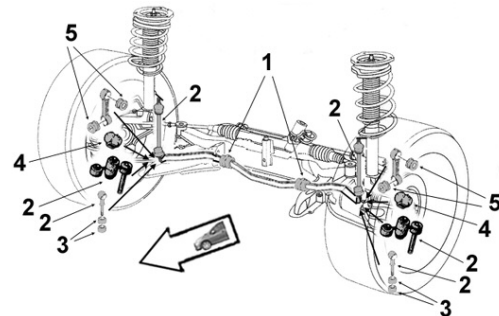

2306010

Biellette barre stab.

OE 1K0411315P

Stabilizer bar stub axle

2



1.2 TSi
1.8 TSi 4WD
2.0 TDi /4WD

... Yeti ...



Eléments SUSPENSION
Suspension parts
Elementos suspensión
Elementy zawieszenie
Элементы подвески

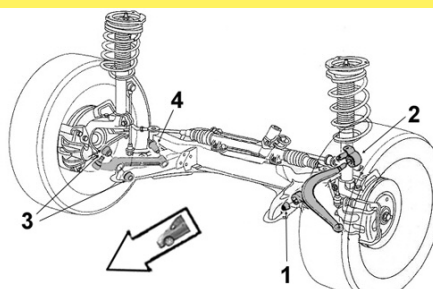

SKODA



9001759

Articulation AV

OE 1K0407182

Front bush



1 Ø int.12 Ø ext.40 coll.48 long. tube int.54 ext.33 ep. coll.6

1.2 TSi
 1.8 TSi 4WD
 2.0 TDi /4WD

2256003

Articulation AR G

OE 1K0199231J

Left rear bush



2

1.2 TSi -08/10
 1.8 TSi 4WD -08/10
 2.0 TDi /4WD -08/10

2256002

Articulation AR D

OE 1K0199232J

Right rear bush



2

1.2 TSi -08/10
 1.8 TSi 4WD -08/10
 2.0 TDi /4WD -08/10

Bras & Triangle de suspension

Control arm
Brazo y triángulo
Wahacz
Рычаг подвески

G/L D/R

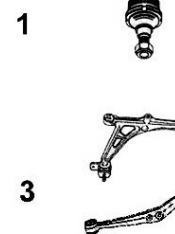
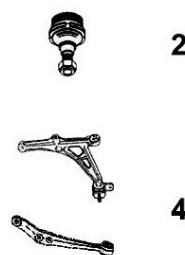

9005570

Rotule de susp. inf. G

OE 1K0407365C

Left lower suspension ball joint



2

1.2 TSi 09/09-
 1.8 TFSi 10/09-
 2.0 TDi 09/09-

9005569

Rotule de susp. inf. D

OE 1K0407366C

Right lower suspension ball joint



1

1.2 TSi 09/09-
 1.8 TFSi 10/09-
 2.0 TDi 09/09-

... Yeti

SASIC

SKODA



Support d'amortisseur
Suspension mounting
Soporte amortiguador
Poduszka amortyzatora
Опора амортизатора

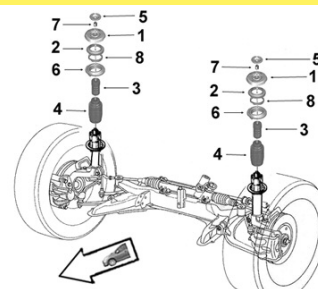

9005622 **Support suspension G/D**
OE 1K0412331B *L/R suspension mounting*



1

1.2 TSi
1.8 TSi 4WD
2.0 TDi /4WD

2656053 **Protecteur amortisseur G/D**
OE 6N0413175A *L/R shock absorber protector*



4 H206

1.2 TSi 10/09-
1.8 TFSi 4WD 10/09-
2.0 TDi /4WD 10/09-



Barre stabilisatrice
Stabilizer bar
Barra estabilizadora
Drażek stabilizatora
стабилизатор поперечной устойчивости

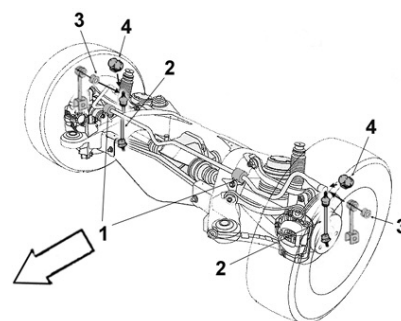

9005094 **Biellette barre stab.**
OE 1K0505465K *Stabilizer bar stub axle*



2

1.2 TSi
1.8 TSi 4WD
2.0 TDi /4WD

2306013 **Palier de barre milieu**
OE 1K0511327AQ *Middle bar main bearing*



1 Barre Ø 19.6

1.2 TSi
1.8 TSi 4WD
2.0 TDi /4WD

Eléments TRAIN ARRIERE
Rear axle parts
Tren TRAS
Elementy zawieszenia tylnego
элементы задней оси.



9001786 **Articulation essieu G/D inf.**
OE 1K0505553A *Lower L/R axle bush*



Ø int. 12 Ø ext. 37 long. tube int. 50 ext. 28

1.2 TSi
1.8 TSi 4WD
2.0 TDi /4WD

City

Bras & Triangle de suspension

Control arm
Brazo y triángulo
Wahacz
Рычаг подвески

G/L  D/R

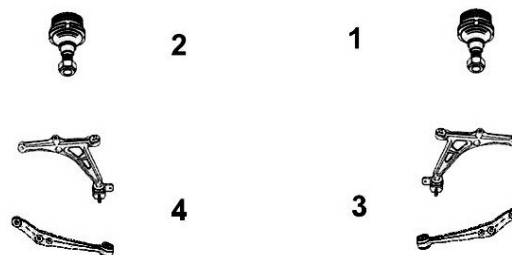

SMART



7576011 Rotule de susp. inf. G/D

OE 2271V007000005 L/R lower suspension ball joint



1
2

0.6i Turbo
0.8 CDi

Forfour



Barre stabilisatrice

Stabilizer bar
Barra estabilizadora
Drażek stabilizatora
стабилизатор поперечной устойчивости

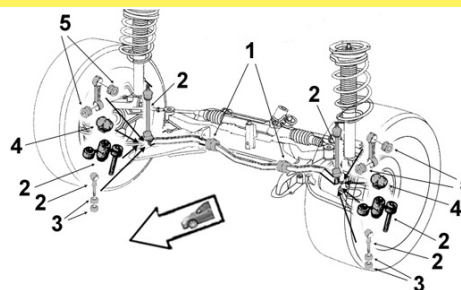

2306073 Biellette barre stab.

OE 4543200010 Stabilizer bar stub axle



2

1.1i
1.3i
1.5i
1.5 CDi FAP

01/04-12/06
01/04-12/06
01/04-12/06
09/04-12/06

Fortwo ...



Barre stabilisatrice

Stabilizer bar
Barra estabilizadora
Drażek stabilizatora
стабилизатор поперечной устойчивости

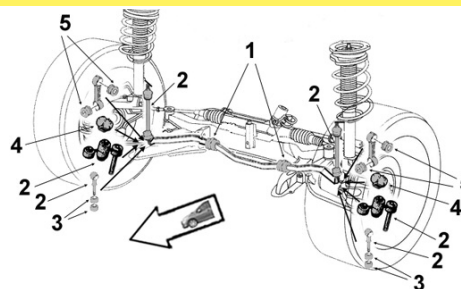

2306071 Biellette barre stab.

OE 4513200189 Stabilizer bar stub axle



2

0.6i Turbo /Cab.
0.8 CDi /Cab.
1.0i /Cab.
1.0i Turbo /Cab.

05/02-12/02
06/07-
04/07-
04/07-

... Fortwo



Eléments SUSPENSION

Suspension parts

Elementos suspensión

Elementy zawieszenie

Элементы подвески

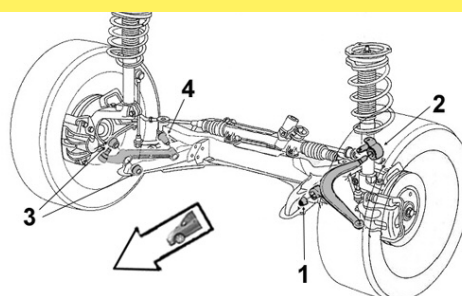

SMART

2256043

Articulation AV/AR

OE 4513300010

Front rear bush



1
2 Ø int. 12 Ø ext. 39 coll. 51 long. tube int. 37 ext.30

0.6i Turbo /Cab.

0.8 CDi /Cab.

1.0i /Cab.

1.0i Turbo /Cab.

03/02-12/06

06/07-

04/07-

04/07-

Bras & Triangle de suspension

Control arm

Brazo y triángulo

Wahacz

Рычаг подвески

G/L  D/R

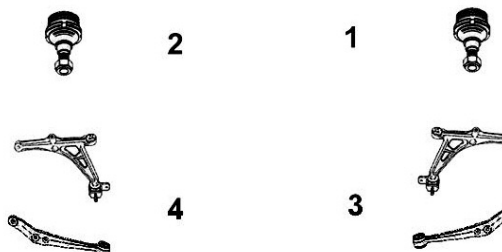

7576011

Rotule de susp. inf. G/D

OE 2271V007000005 L/R lower suspension ball joint



1
2

0.6i Turbo /Cab.

0.7i Turbo /Cab.

0.8 CDi /Cab.

-12/06

-12/06

-12/06

Roadster

Bras & Triangle de suspension

Control arm

Brazo y triángulo

Wahacz

Рычаг подвески

G/L  D/R

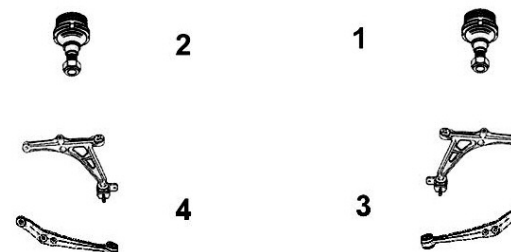

7576011

Rotule de susp. inf. G/D

OE 2271V007000005 L/R lower suspension ball joint



1
2

0.7i Turbo Coupé/Cabriolet

Alto

Eléments DIRECTION

Steering parts

Elementos Direcciones

Elementy układ kierowniczy

Элементы рулевой системы

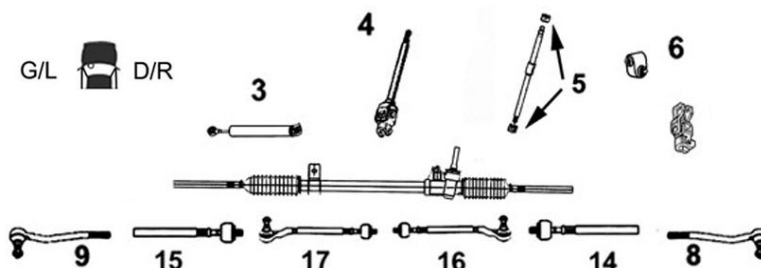

7676085

Rotule de direction G/D

OE 4881063J00

L/R tie rod end

NEW



8
9

M12x1.25

1.0i 16v.

01/09-

Bras & Triangle de suspension

Control arm

Brazo y triángulo

Wahacz

Рычаг подвески

G/L D/R

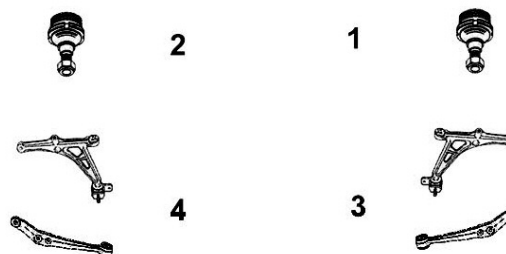

7476041

Bras de susp. AV inf. G/D

OE 4520050E00

L/R front lower track control arm



3
4

Ø15 Avec rotule With ball joint

0.8i

1.0i

1.1i

06/82-11/93

09/94-06/02

06/02-12/05

Splash ...

Eléments DIRECTION

Steering parts

Elementos Direcciones

Elementy układ kierowniczy

Элементы рулевой системы

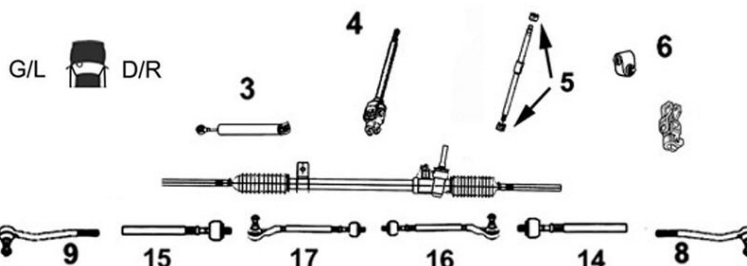

7776095

Axe de bielle G/D

OE 4883063J00000

L/R axial joint

NEW



14
15

Côté dir. M18x1.5

15 Côté rot. M12x1.25 long 306 mm

1.0i 16v.

1.2i 16v.

1.3 CDTi DPF

1.3 DDiS

03/08-

03/08-

03/08-

03/08-

7676085

Rotule de direction G/D

OE 4881063J00

L/R tie rod end

NEW



8
9

M12x1.25

1.0i /16v.

1.2i /16v.

1.3 CDTi DPF

03/08-

03/08-

03/08-

... Splash

Bras & Triangle de suspension

Control arm
Brazo y triángulo
Wahacz
Рычаг подвески

G/L  D/R



7476104 Triangle de susp. G
OE 4520272K01000 Left track control arm

NEW



4 Avec rotule With ball joint Ø 16.5

1.0i	BVM	03/08-
1.2i	BVM BVA	03/08-
1.3 CDTi DPF	BVM	03/08-
1.3 DDiS	BVM	03/08-

7476105 Triangle de susp. D
OE 4520172K01000 Right track control arm

NEW



3 Avec rotule With ball joint Ø 16.5

1.0i	BVM	03/08-
1.2i	BVM BVA	03/08-
1.3 CDTi DPF	BVM	03/08-
1.3 DDiS	BVM	03/08-

Swift

Eléments DIRECTION

Steering parts
Elementos Direcciones
Elementy układ kierowniczy
Элементы рулевой системы

G/L  D/R

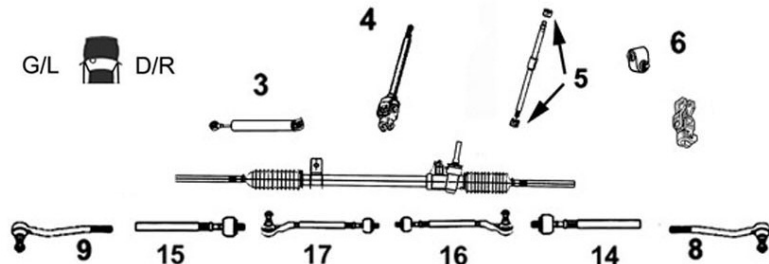

7776095 Axe de bielle G/D
OE 4883063J00000 L/R axial joint

NEW



14 Côté dir. M18x1.5
15 Côté rot. M12x1.25 long 306 mm

1.3i /4WD	03/05-09/11
1.3 DDiS	03/05-09/11
1.6i 16v.	01/07-09/11

7676085 Rotule de direction G/D
OE 4881063J00 L/R tie rod end

NEW



8
9 M12x1.25

1.3i /4WD	03/05-09/11
1.3 DDiS	03/05-09/11
1.5i /4WD	03/05-09/11
1.6i 16v.	03/05-09/11

Bras & Triangle de suspension

Control arm
Brazo y triángulo
Wahacz
Рычаг подвески

G/L  D/R

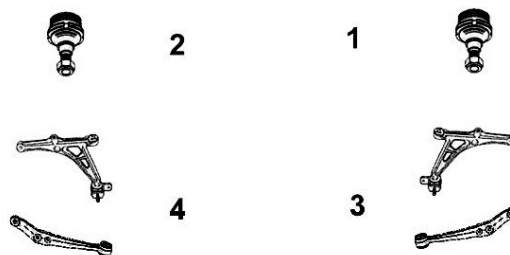

7476104 Triangle de susp. G
OE 4520272K01000 Left track control arm

NEW



4 Avec rotule With ball joint Ø 16.5

1.3 DDiS	03/05-
1.6i	01/07-

7476105 Triangle de susp. D
OE 4520172K01000 Right track control arm

NEW



3 Avec rotule With ball joint Ø 16.5

1.3 DDiS	03/05-
1.6i	01/07-

Wagon R

Bras & Triangle de suspension

Control arm
Brazo y triángulo
Wahacz
Рычаг подвески

G/L  D/R

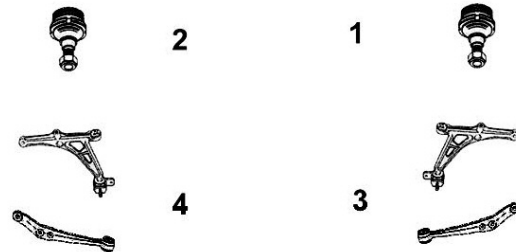

7476232

Bras de susp. AV inf. G/D

OE 4520075F21

L/R front lower track control arm

NEW

3 Ø15 Avec rotule With ball joint
4



1.0i
1.2i /4WD
1.3i /4WD

02/98-04/00
04/99-04/00
04/00-04/05

1100 1307 1308 1309 1510 Horizon

Eléments DIRECTION

Steering parts
Elementos Direcciones
Elementy układ kierowniczy
Элементы рулевой системы

G/L  D/R

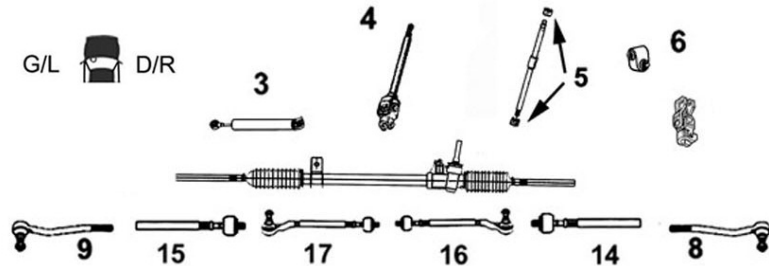

6003000

Rotule de direction G/D

OE 12891400

L/R tie rod end



8 M12 x 1.0
9

TT /all models

Bras & Triangle de suspension

Control arm
Brazo y triángulo
Wahacz
Рычаг подвески

G/L  D/R

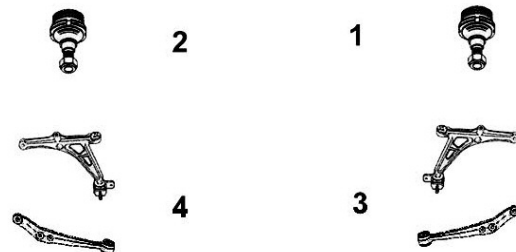

6003001

Rotule de susp. sup. G/D

OE 12858600

L/R upper susp. ball joint



1
2

TT /all models

SUZUKI

SASIC

TALBOT

SASIC

Samba

Eléments DIRECTION

Steering parts

Elementos Direcciones

Elementy układ kierowniczy

Элементы рулевой системы

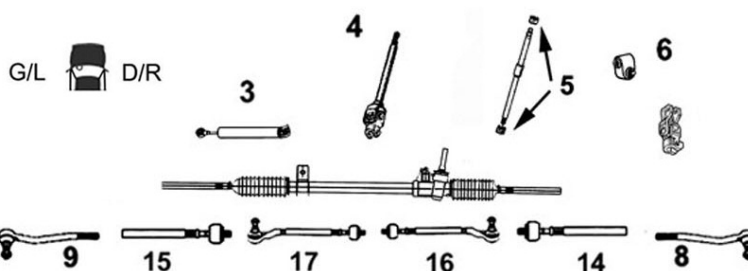
**3008153****Axe de bielle G/D**

OE -

L/R axial joint

- 14 Côté dir. M12x1.0
15 Côté rot. M14x1.5 long 262 mm

TT /all models

8123153B1**Bielle de direction G/D**

OE 381215

L/R steering rod

- 16
17

TT /all models

8173183**Rotule de direction G/D**

OE 381750

L/R tie rod end

- 8
9 M14 x 1.5

TT /all models

Bras & Triangle de suspension

Control arm

Brazo y triángulo

Wahacz

Рычаг подвески

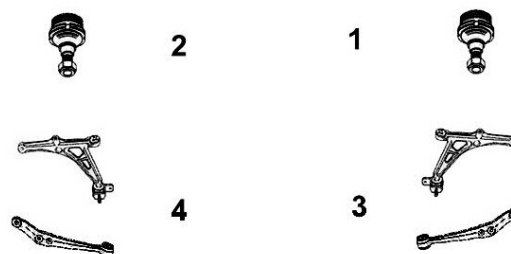
G/L  D/R**5203343****Bras de suspension G**

OE 352034

Left track control arm

- 4 Avec rotule With ball joint

TT /all models

5213233**Bras de suspension D**

OE 352123

Right track control arm

- 3 Avec rotule With ball joint

TT /all models

Auris

Eléments DIRECTION

Steering parts

Elementos Direcciones

Elementy układ kierowniczy

Элементы рулевой системы

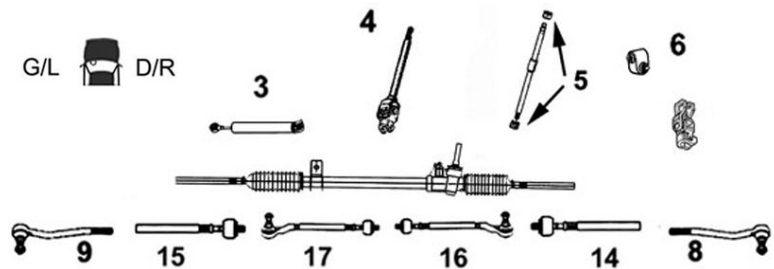

7676042

Rotule de direction G

OE 4504709270

Left tie rod end



9

1.3i
1.4i 16v.
1.4 D4-D
1.6i
2.0 D4-D
2.2 D4-D

-03/10

7676041

Rotule de direction D

OE 4504609570

Right tie rod end



8

1.3i
1.4i 16v.
1.4 D4-D
1.6i
2.0 D4-D
2.2 D4-D

-03/10

Bras & Triangle de suspension

Control arm

Brazo y triángulo

Wahacz

Рычаг подвески

G/L D/R

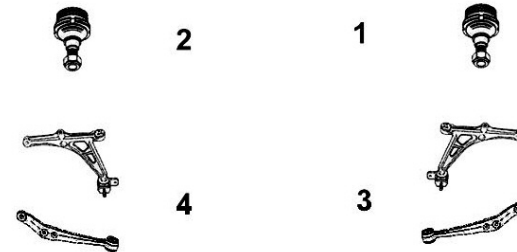

7576037

Rotule de susp. inf. G/D

OE 4333049095

L/R lower suspension ball joint

NEW



1
2

1.3i
1.4i
1.4 D4-D
1.6i
1.8i Hybride
2.0 D4-D
2.2 D4-D

10/08-
01/10-
03/07-
03/07-
09/10-
03/07-
03/07-

Avensis ...

Eléments DIRECTION

Steering parts

Elementos Direcciones

Elementy układ kierowniczy

Элементы рулевой системы

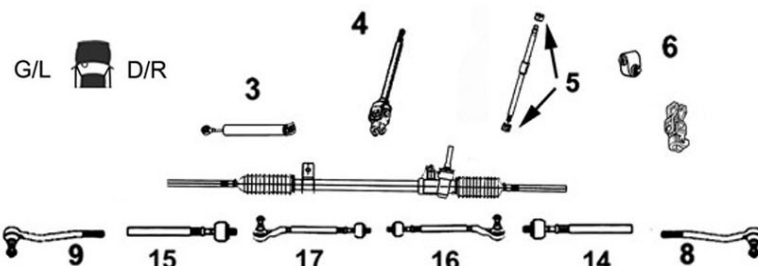

7776043

Axe de bielle G/D

OE 4550305050

L/R axial joint



14
15

Côté dir. M16x1.5
Côté rot. M14x1.5 long 240 mm
1.6i /Break -10/00
1.6 VTi /Break -05/03
1.8i 16v. /Break -05/03
2.0i /Break -10/00
2.0i WTi D4 /Break -05/03
2.0 D4-D /Break -05/03
2.0 TD /Break -10/00

7676043

Rotule de direction G/D

OE 4504609230

L/R tie rod end



8
9

M15x1.5

1.6 VTi
1.8 VTi

03/03-08/06
03/03-11/09

... Avensis ...

Eléments DIRECTION
Steering parts
Elementos Direcciones
Elementy układ kierowniczy
Элементы рулевой системы

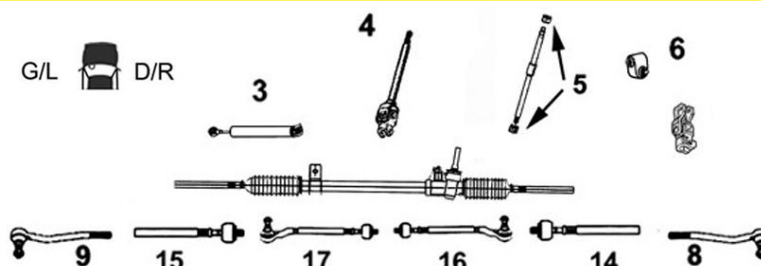

7676044 Rotule de direction G/D

OE 4504629425 *L/R tie rod end*



8
9 M16 x 1.5

2.0i WTi D4 /Break
 2.0 D4-D /Break
 2.2 D4-D /Break
 2.4i VTi /Break

03/03-08/06
 03/03-11/09
 05/05-11/99
 01/03-11/09

9006641 Rotule de direction G

OE 4504729125 *Left tie rod end*



9 M14 x 1.5

1.6i 16v. -02/03
 1.6 VTi -02/03
 1.8i 16v. -02/03
 2.0i 16v. -02/03
 2.0 WTi -02/03
 2.0 D4-D -02/03
 2.0 TD -02/03

9006607 Rotule de direction D

OE 4504629365 *Right tie rod end*



8 M14 x 1.5

1.6i 16v. -02/03
 1.6 VTi -02/03
 1.8i 16v. -02/03
 2.0i 16v. -02/03
 2.0 WTi -02/03
 2.0 D4-D -02/03
 2.0 TD -02/03

Bras & Triangle de suspension

Control arm
Brazo y triángulo
Wahacz
Рычаг подвески

G/L D/R

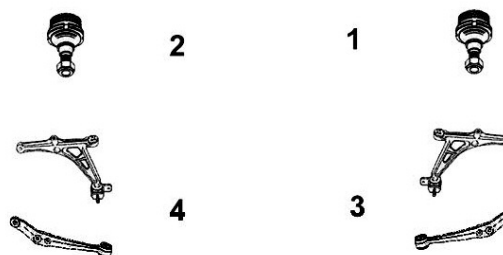

7476081 Triangle de susp. G

OE 4806905050 *Left track control arm*



4 Sans rotule Without tie rod end

1.6i 16v. /Break -10/00
 1.6 VTi /Break -05/03
 1.8i 16v. /Break -05/03
 2.0i 16v. /Break -10/00
 2.0i WTi D4 /Break -05/03
 2.0 D4-D /Break -05/03
 2.0 TD /Break -10/00

7476080 Triangle de susp. D

OE 4806805050 *Right track control arm*



3 Sans rotule Without tie rod end

1.6i 16v. /Break -10/00
 1.6 VTi /Break -05/03
 1.8i 16v. /Break -05/03
 2.0i 16v. /Break -10/00
 2.0i WTi D4 /Break -05/03
 2.0 D4-D /Break -05/03
 2.0 TD /Break -10/00

7476134 Triangle de susp. G

OE 4806905050+4333029375 *Left track control arm*



4 Avec rotule With ball joint

1.6i 16v. /Break -10/00
 1.6 VTi /Break -05/03
 1.8i 16v. /Break -05/03
 2.0i 16v. /Break -10/00
 2.0i WTi D4 /Break -05/03
 2.0 D4-D /Break -05/03
 2.0 TD /Break -10/00

7476133 Triangle de susp. D

OE 4806805050+4333029375 *Right track control arm*







3 Avec rotule With ball joint

1.6i 16v. /Break -10/00
 1.6 VTi /Break -05/03
 1.8i 16v. /Break -05/03
 2.0i 16v. /Break -10/00
 2.0i WTi D4 /Break -05/03
 2.0 D4-D /Break -05/03
 2.0 TD /Break -10/00

... Avensis

TOYOTA

SASIC

7476167 OE 4806905070	Triangle de susp. G <i>Left track control arm</i>	7476165 OE 4806805070	Triangle de susp. D <i>Right track control arm</i>
NEW 	4 Sans rotule <i>Without tie rod end</i> 1.8 VTi /Break 05/03-11/09 2.0 VVT-i /Break 05/03-08/06 2.0 D4-D /Break 05/03-11/09 2.2 D4-D /Break 03/05-11/09 2.4i VTi /Break 01/04-11/09	NEW 	3 Sans rotule <i>Without tie rod end</i> 1.8 VTi /Break 05/03-11/09 2.0 VVT-i /Break 05/03-08/06 2.0 D4-D /Break 05/03-11/09 2.2 D4-D /Break 03/05-11/09 2.4i VTi /Break 01/04-11/09
9005567 OE 4333029375	Rotule de susp. inf. G/D <i>L/R lower suspension ball joint</i>	7576012 OE 4333009210	Rotule de susp. inf. G/D <i>L/R lower suspension ball joint</i>
	1 2 1.6i 16v. /Break -10/00 1.6 VTi /Break -05/03 1.8i 16v. /Break BVM BVA -02/03 2.0i WTi D4 /Break -05/03 2.0i 16v. /Break -10/00 2.0 D4-D /Break -02/03 2.0 TD /Break -02/03		1 2 1.6 VTi /Break 05/03-08/06 1.8 VTi /Break 05/03-11/09 2.0i WTi D4 /Break 05/03-08/06 2.0 D4-D /Break 05/05-11/09 2.2 D4-D Break 07/05-08/06 2.4i VTi /Break 01/04-11/09



Support d'amortisseur
Suspension mounting
Soporte amortiguador
Poduszka amortyzatora
Опора амортизатора

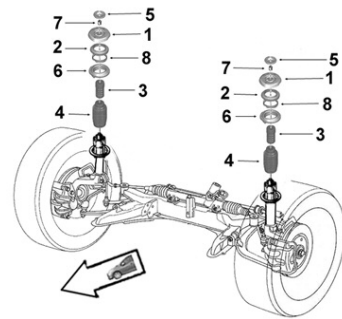

9001768 OE 4860905010	Coupelle amortisseur AV <i>Front shock absorber cup</i>
	1 1.6i 16v. 1.6 VTi 1.8i 16v. 2.0 /WTi 2.0 D4-D 2.0 TD
	09/00-05/03



Barre stabilisatrice
Stabilizer bar
Barra estabilizadora
Drażek stabilizatora
стабилизатор поперечной устойчивости

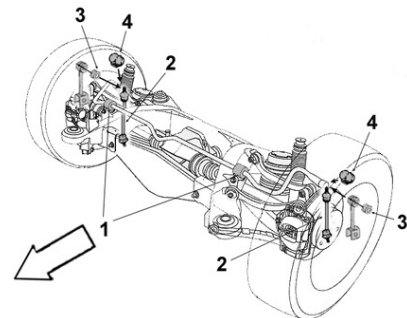

9005049 OE 4883005020	Biellette barre stab. <i>Stabilizer bar stub axle</i>
	2 1.6i 16v. 1.6 VTi 1.8i 16v. 2.0i 16v. 2.0 WTi 2.0 D4-D 2.0 TD
	10/97- 10/97-

Avensis Verso

Eléments DIRECTION
 Steering parts
 Elementos Direcciones
 Elementy układ kierowniczy
 Элементы рулевой системы

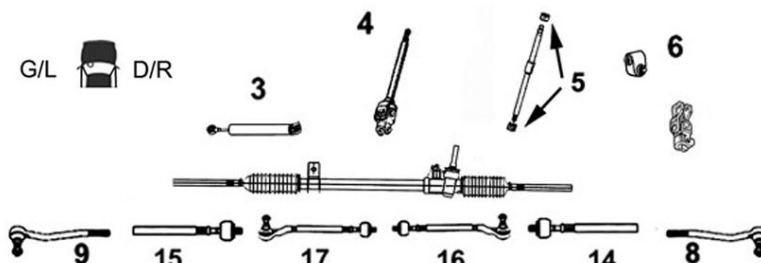

7776044 Axe de bielle G/D

Part/oe 4550349105 L/R axial joint



14 Côté dir. M14x1.5 Côté rot. M16x1.5 long 290 mm

2.0 VTi
 2.0 D4-D

07/01-09/06
 07/01-09/06

Aygo ...

Eléments DIRECTION
 Steering parts
 Elementos Direcciones
 Elementy układ kierowniczy
 Элементы рулевой системы

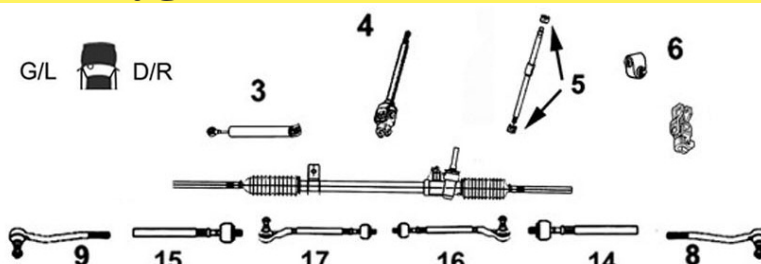

7770011 Axe de bielle G/D

Part/oe 455000H010 L/R axial joint



NEW

14 Côté dir. M14x1.5 Côté rot. M12x1.25 long 223 mm

1.0i 12v.
 1.4 D4-D

06/05-
 06/05-

8173633 Rotule de direction G

OE 4504709125 Left tie rod end



9 M12 x 1.25

1.0i 12v.
 1.4 D4-D

06/05-
 06/05-

8173643 Rotule de direction D

OE 4504609295 Right tie rod end



8 M12 x 1.25

1.0i 12v.
 1.4 D4-D

06/05-
 06/05-

... Aygo ...



Barre stabilisatrice
 Stabilizer bar
 Barra estabilizadora
 Drażek stabilizatora
 стабилизатор поперечной устойчивости

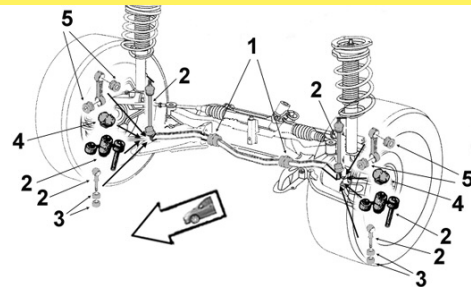

2300044

Liaison élastique

OE 488170D010

Elastic link

3



1.0 WTi
1.4 D4-D

06/05-
06/05-

2300016

Palier de barre milieu

OE 488150H010

Middle bar main bearing

1



1.0 WTi
1.4 D4-D



Eléments SUSPENSION

Suspension parts
Elementos suspensión
Elementy zawieszenie
Элементы подвески

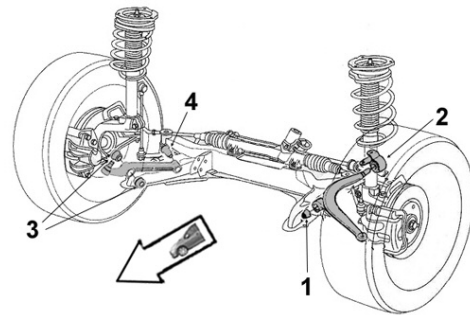

2250003

Articulation AV

Part/oe 480680H010 *Front bush*

1 Ø int. 12 Ø ext. 33 coll. 34
long. tube int. 53 ext. 31 ep. coll. 6X2



1.0 WTi
1.4 D4-D

06/05-
06/05-

2250006

Articulation AR

Part/oe 480680H010 *Rear bush*

2 Ø int. 19 Ø ext. 57
long. tube int. 62 ext. 26



1.0 WTi
1.4 D4-D

06/05-
06/05-

Bras & Triangle de suspension

Control arm
Brazo y triángulo
Wahacz
Рычаг подвески

G/L  D/R



2

1



4

3



7570002

Rotule de susp. inf. G/D

Part/oe 4806859035 *L/R lower suspension ball joint*

1
2



1.0 WTi
1.4 D4-D

06/05-
06/05-

... Aygo



Support d'amortisseur
Suspension mounting
Soporte amortiguador
Poduszka amortyzatora
Опора амортизатора

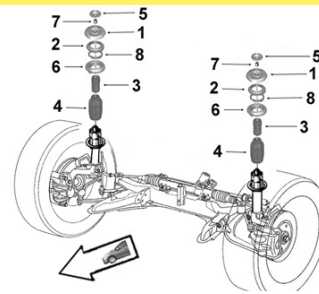

2650022 **Support suspension G/D**
 OE 486090H010 *L/R suspension mounting*



1 **Sans roulement** *Without bearing*

1.0 WTi
1.4 D4-D

2650004 **Butée à billes G/D**
 OE 486190H010 *L/R ball bearing*



2

1.0 WTi
1.4 D4-D

2650008 **Butée de suspension G/D**
 OE 483310H010 *L/R suspension bush*



3

1.0 WTi
1.4 D4-D

Corolla ...

Eléments DIRECTION
Steering parts
Elementos Direcciones
Elementy uklad kierowniczy
Элементы рулевой системы

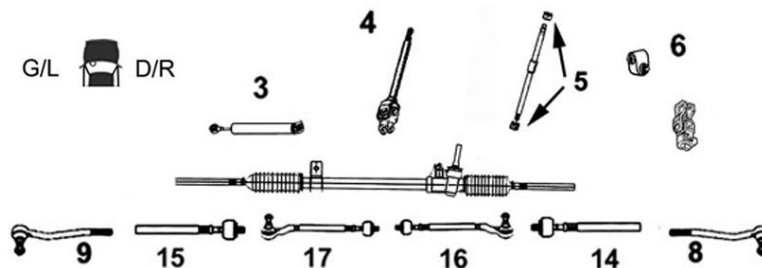

9006865 **Axe de bielle G/D**
 OE 4550319036 *L/R axial joint*



14 Côté dir. M14x1.5
15 Côté rot. M14x1.5 long 313 mm

TT /all models 10/84-03/87

7776048 **Axe de bielle G/D**
 Part/oe 4550319215 *L/R axial joint*



14 Côté dir. M14x1.5
15 Côté rot. M14x1.5 long 315 mm

1.3i /Break	07/92-02/00
1.4i /Break	04/97-01/02
1.6i /Break	07/92-01/02
1.8i /Break	11/92-04/97
1.9 D Break	02/00-01/02
2.0 D /Break	07/92-02/00
2.0 D4-D /Break	09/00-01/02

7776045 **Axe de bielle G/D**
 OE 4550312130 *L/R axial joint*



14 Côté dir. M14x1.5
15 Côté rot. M14x1.5 long 270 mm

1.4i 16v. /Break	01/02-07/04
1.6 VTi /Break	01/02-07/04
1.8i 16v. 192hp 141kw	01/02-07/04
2.0 D4-D /Break	01/02-07/04

9006604 **Rotule de direction G/D**
 OE 4504629305 *L/R tie rod end*



8 M14 x 1.5
9

1.3i 01/93-10/01

... Corolla ...

TOYOTA



9006604 OE ES2382	Rotule de direction G/D <i>L/R tie rod end</i>		
	8 M14x1.5 9 1.4i 16v. 1.6 1.6 VTi 1.8 1.9 D 2.0 D 2.0 D4-D		02/00-12/01 01/93-02/00 02/00-12/01 -12/97 02/00-12/01 01/93-10/01 09/00-12/01

9006605 OE 4504749045	Rotule de direction G <i>L tie rod end</i>		
	9 M14x1.5 1.4i 16v. 11/01-10/03 1.6 VTi 11/01-10/03 1.8i 16v. 11/01-10/03 2.0 D4-D 11/01-08/07		

9006603 OE 4504649115	Rotule de direction D <i>Right tie rod end</i>		
	8 M14x1.5 1.4i 16v. 11/01-10/03 1.6 VTi BVM BVA 11/01-10/03 1.8i 16v. 11/01-10/03 2.0 D4-D 11/01-08/07		



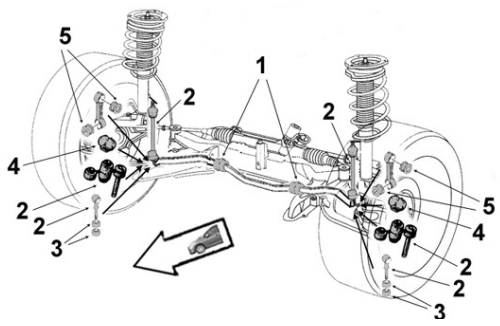

Barre stabilisatrice
Stabilizer bar
Barra estabilizadora
Drażek stabilizatora
стабилизатор поперечной устойчивости



9005044 OE 4882033010	Biellette barre stab. <i>Stabilizer bar stub axle</i>		
	2 1.6i /Break 2.0 D /Break		05/92-01/02 04/97-01/02

Bras & Triangle de suspension
Control arm
Brazo y triángulo
Wahacz
Рычаг подвески

G/L  D/R



2

4



1

3

7476083 OE 4806912171	Triangle de susp. G <i>Left track control arm</i>		
	4 Sans rotule Without tie rod end 1.3i /Break 06/97-02/00 1.4i /Break 02/00-01/02 1.6i /Break 04/97-02/00 1.9 D /Break 02/00-01/02 2.0 D /Break 06/97-02/00 2.0 D4-D /Break 09/00-01/02		

7476082 OE 4806812171	Triangle de susp. D <i>Right track control arm</i>		
	3 Sans rotule Without tie rod end 1.3i /Break 06/97-02/00 1.4i /Break 02/00-01/02 1.6i /Break 04/97-02/00 1.9 D /Break 02/00-01/02 2.0 D /Break 06/97-02/00 2.0 D4-D /Break 09/00-01/02		

... Corolla

SASIC





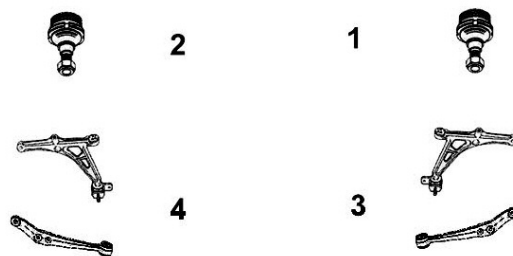

TOYOTA

Bras & Triangle de suspension

Control arm
Brazo y triángulo
Wahacz
Рычаг подвески

G/L  D/R



7476182 Triangle de susp. G OE 4806912171+4333049185 <i>Left track control arm</i> 	4 Avec rotule With ball joint 1.3i /Break 06/97-02/00 1.4i /Break 02/00-01/02 1.6i /Break 04/97-02/00 1.9 D /Break 02/00-01/02 2.0 D /Break 06/97-02/00 2.0 D4-D /Break 09/00-01/02	7476181 Triangle de susp. D OE 4806812171+4333049185 <i>Right track control arm</i> 	3 Avec rotule With ball joint 1.3i /Break 06/97-02/00 1.4i /Break 02/00-01/02 1.6i /Break 04/97-02/00 1.9 D /Break 02/00-01/02 2.0 D /Break 06/97-02/00 2.0 D4-D /Break 09/00-01/02
9005849 Triangle de susp. inf. G OE 4806913010 <i>Lower left track control arm</i> 	4 Sans rotule Without tie rod end 1.4i 16v. 01/02-08/07 1.4 D4-D /Break 07/04-08/07 1.6 VTi 01/02-08/07 1.8i 16v. 01/02-07/04 2.0 D4-D 01/02-08/07 2.0 D4-D Break 11/02-08/07	9005848 Triangle de susp. inf. D OE 4806813010 <i>Lower right track control arm</i> 	3 Sans rotule Without tie rod end 1.4i 16v. 01/02-08/07 1.4 D4-D /Break 07/04-08/07 1.6 VTi 01/02-08/07 1.8i 16v. 01/02-07/04 2.0 D4-D 01/02-08/07 2.0 D4-D Break 11/02-08/07
7476140 Triangle de susp. G OE 4806913010+4333009090 <i>Left track control arm</i> 	4 Avec rotule With ball joint 1.6 VTi 01/02-08/07 1.8i 16v. 01/02-07/04 2.0 D4-D 01/02-08/07 2.0 D4-D Break 07/04-08/07	7476141 Triangle de susp. D OE 4806813010+4333009090 <i>Right track control arm</i> 	3 Avec rotule With ball joint 1.6 VTi 01/02-08/07 1.8i 16v. 01/02-07/04 2.0 D4-D 01/02-08/07 2.0 D4-D Break 07/04-08/07
9005568 Rotule de susp. inf. G/D OE 4333009090 <i>L/R lower suspension ball joint</i> 	1 2 1.3i 05/95-10/01 1.4i /Break 02/00-01/02 1.4i 11/01- 1.4 D4-D 07/04-08/07 1.6i /Break 04/97-02/00 1.6 VTi BVM BVA 11/01- 1.8 11/01- 1.8i 16v. 01/93-04/06 1.9 D /Break 02/00-01/02 2.0 D /Break 06/97-02/00 2.0 D4-D /Break 09/00-08/07		

Corolla Verso ...

Eléments DIRECTION
 Steering parts
 Elementos Direcciones
 Elementy układ kierowniczy
 Элементы рулевой системы

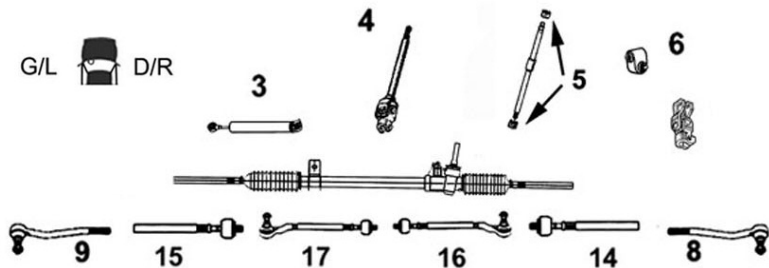

7776045 **Axe de bielle G/D**
 OE 4550319255 *L/R axial joint*



14 Côté dir. M14x1.5 Côté rot. M14x1.5 long 270 mm
15

1.4i 16v.
 1.6 VTi
 1.8i
 2.0 D4-D

01/02-05/04
 01/02-05/04
 01/02-05/04
 01/02-05/04

9006605 **Rotule de direction G**
 OE 4504719115 *Left tie rod end*



9 M14 x 1.5

1.6 VTi
 1.8i 16v.
 2.0 D4-D

01/02-05/04
 01/02-05/04
 01/02-05/04

9006603 **Rotule de direction D**
 OE 4504619265 *Right tie rod end*



8 M14 x 1.5

1.6 VTi
 1.8i 16v.
 2.0 D4-D

01/02-05/04
 01/02-05/04
 01/02-05/04

Bras & Triangle de suspension

Control arm
 Brazo y triángulo
 Wahacz
 Рычаг подвески

G/L D/R

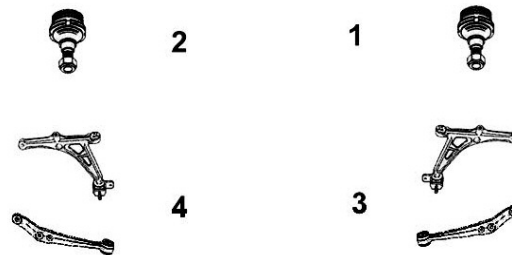

9005849 **Triangle de susp. inf. G**
 OE 4806912260 *Lower left track control arm*



4 Sans rotule Without tie rod end

1.6 VTi
 1.8
 2.0 D4-D

09/01-05/04
 09/01-05/04
 01/02-05/04

9005848 **Triangle de susp. inf. D**
 OE 4806812260 *Lower right track control arm*



3 Sans rotule Without tie rod end

1.6 VTi
 1.8
 2.0 D4-D

09/01-05/04
 09/01-05/04
 01/02-05/04

7476140 **Triangle de susp. G**
 OE 4806913010+4333009090 *Left track control arm*



NEW

4 Avec rotule With ball joint

1.6 VTi
 1.8
 2.0 D4-D

09/01-05/04
 09/01-05/04
 01/02-05/04

7476141 **Triangle de susp. D**
 OE 4806813010+4333009090 *Right track control arm*



NEW

3 Avec rotule With ball joint

1.6 VTi
 1.8
 2.0 D4-D

09/01-05/04
 09/01-05/04
 01/02-05/04

... Corolla Verso

Bras & Triangle de suspension

Control arm
Brazo y triángulo
Wahacz
Рычаг подвески

G/L  D/R

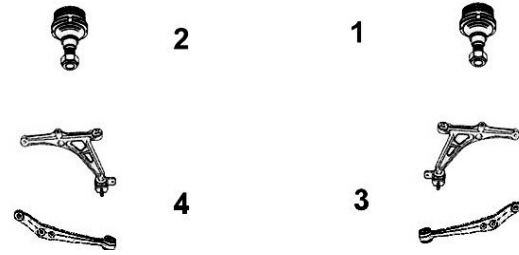

9005568

Rotule de susp. inf. G/D

OE 4333009090

L/R lower suspension ball joint



1
2

1.6 VTi
1.8
2.0 D4-D

09/01-
09/01-
11/01-

Prius

Bras & Triangle de suspension

Control arm
Brazo y triángulo
Wahacz
Рычаг подвески

G/L  D/R



9005568

Rotule de susp. inf. G/D

OE 4333009090

L/R lower suspension ball joint



1
2

1.5i 16v.
1.8i 100hp 73kw

2ZR BV Séq.

05/00-01/04
06/09-02/12

Rav4 ...

Eléments DIRECTION

Steering parts
Elementos Direcciones
Elementy układ kierowniczy
Элементы рулевой системы

G/L  D/R

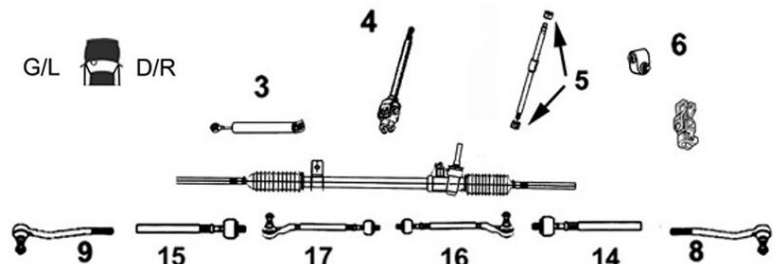

7776047

Axe de bielle G/D

Part/oe 4550349055

L/R axial joint



14
15

Côté dir. M14x1.5
Côté rot. M15x1.5 long 300 mm

1.8i 4WD
2.0i 4WD
2.0 D4-D 4WD

02/01-06/03
07/00-06/03
07/01-06/03

7776048

Axe de bielle G/D

Part/oe 4550319215

L/R axial joint



14
15

Côté dir. M14x1.5
Côté rot. M14x1.5 long 315 mm









2.0i 4WD

06/94-07/00

... Rav4 ...

TOYOTA

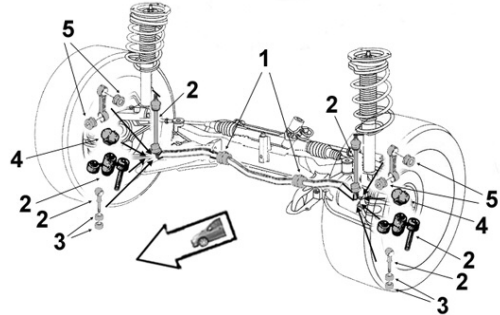







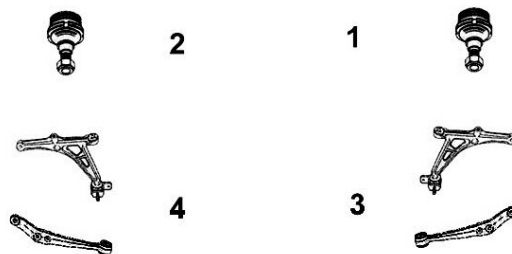

9006604 Rotule de direction G/D OE ES2382 <i>L/R tie rod end</i>	
	8 M14 x 1.5 9 2.0 BVM BVA -04/00
9006643 Rotule de direction G OE 4504749025 <i>Left tie rod end</i>	
	9 M16 x 1.5 2.0 BVM BVA 05/00-09/03 2.0 150hp 111kw BVM BVA 10/03- 2.0 D4-D 05/00-
9006642 Rotule de direction D OE 4504649095 <i>Right tie rod end</i>	
	8 M16 x 1.5 2.0 BVM BVA 05/00-09/03 2.0 150hp 111kw BVM BVA 10/03- 2.0 D4-D 05/00-
7676088 Rotule de direction G OE 4504749135 <i>Left tie rod end</i>	
	9 M16 x 1.5 2.0i 4WD 02/06- 2.2 D4-D /4WD 02/06-
7676087 Rotule de direction D OE 4504649195 <i>Right tie rod end</i>	
	8 M16 x 1.5 2.0i /4WD 02/06- 2.2 D4-D /4WD 02/06-
	
<p>Barre stabilisatrice Stabilizer bar Barra estabilizadora Drażek stabilizatora стабилизатор поперечной устойчивости</p>	
9005044 Biellette barre stab. OE 4882033010 <i>Stabilizer bar stub axle</i>	
	2 2.0 3ptes BVM BVA -04/00

... Rav4 ...

Bras & Triangle de suspension

Control arm
Brazo y triángulo
Wahacz
Рычаг подвески

G/L  D/R

7476088 OE 4806942022	Triangle de susp. G <i>Left track control arm</i>	7476087 OE 4806842022	Triangle de susp. D <i>Right track control arm</i>
	4 Sans rotule Without tie rod end 2.0i 4WD -07/00		3 Sans rotule Without tie rod end 2.0i 4WD -07/00
7476228 OE 4806942050	Triangle de susp. G <i>Left track control arm</i>	7476229 OE 4806842050	Triangle de susp. D <i>Right track control arm</i>
	4 Sans rotule Without tie rod end 2.0i 4WD 1AZ 02/06-11/09 2.2 D4-D 4WD /FAP 2AD 02/06-11/09		3 Sans rotule Without tie rod end 2.0i 4WD 1AZ 02/06-11/09 2.2 D4-D 4WD /FAP 2AD 02/06-11/09
7576013 OE 4333049025	Rotule de susp. inf. G/D <i>L/R lower suspension ball joint</i>		
	1 2 2.0i -07/00		
9005568 OE 4333009090	Rotule de susp. inf. G/D <i>L/R lower suspension ball joint</i>		
	1 2 2.0 BVM BVA 05/00-09/03 2.0i 150hp 110kw BVM BVA 10/03- 2.0 D4-D 05/00-12/05		
7576037 OE 4333049095	Rotule de susp. inf. G/D <i>L/R lower suspension ball joint</i>		
	1 2 2.0 /4WD 01/06- 2.2 D4-D /4WD 01/06-		

... Rav4



Support d'amortisseur

Suspension mounting
Soporte amortiguador
Poduszka amortyzatora
Опора амортизатора

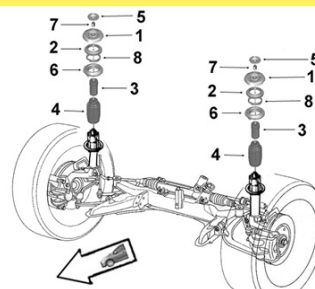

2656024

Support suspension G/D

OE 4860942012

L/R suspension mounting

1



2.0i 4WD
2.0 D4-D 4WD

1AZFE
1CDFTV

BVM

01/05/00-12/05
01/05/00-12/05

Urban



Barre stabilisatrice

Stabilizer bar
Barra estabilizadora
Drażek stabilizatora
стабилизатор поперечной устойчивости

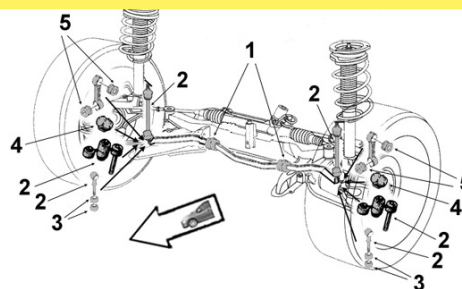

2306054

Biellette barre stab.

OE 488200D010

Stabilizer bar stub axle

2



1.3i
1.4 D4-D /4WD

04/09-
04/09-

Verso 06/09- ...



Barre stabilisatrice

Stabilizer bar
Barra estabilizadora
Drażek stabilizatora
стабилизатор поперечной устойчивости

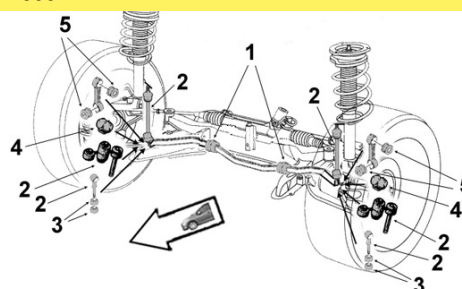

2306054

Biellette barre stab.

OE 488200D010

Stabilizer bar stub axle

2



1.3i
1.4 D4-D

01/11-
01/11-

... Verso 06/09-

Bras & Triangle de suspension

Control arm
Brazo y triángulo
Wahacz
Рычаг подвески

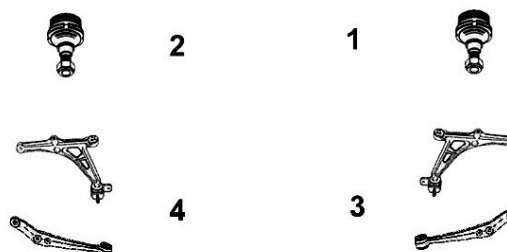
G/L  D/R**7576037****Rotule de susp. inf. G/D**

OE 4333049095

L/R lower suspension ball joint

NEW

1 2

1.6i
1.8i
2.0 D4-D
2.2 D4-D

06/09-
06/09-
06/09-
06/09-



Yaris ...

Eléments DIRECTION

Steering parts
Elementos Direcciones
Elementy układ kierowniczy
Элементы рулевой системы

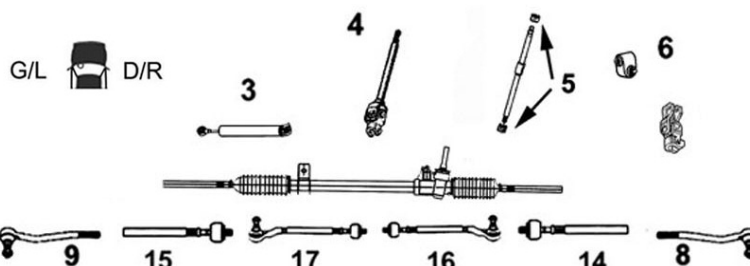
**7776050****Axe de bielle G/D**

Part/oe 455030D030 L/R axial joint

14 Côté dir. M14x1.5
15 Côté rot. M12x1.25 long 247 mm

1.0i 16v. 04/99-12/05
1.3 VVT-i 04/02-12/05
1.4 D4-D 12/01-12/05

**7776049****Axe de bielle G/D**

OE 4550359045

L/R axial joint

14 Côté dir. M14x1.5
15 Côté rot. M12x1.25 long 240 mm

1.0i 16v. -11/05
1.3i 16v. -11/05
1.3i 16v. Verso -04/06
1.4 D4-D -11/05
1.4 D4-D Verso -04/06
1.5i VVTi Verso -04/06

**7776051****Axe de bielle G/D**

Part/oe 4550359055 L/R axial joint

14 Côté dir. M14x1.5 Côté rot. M14x1.5 long 340 mm
15

1.5i VVTi

11/01-12/05

**7676047****Rotule de direction G**

OE 4504759035

Left tie rod end

9 M12x1.25
1.0i 16v. -12/05
1.3i 16v. -12/05
1.3i 16v. Verso -04/06
1.3 VVT-i -12/05
1.4 D4-D -12/05
1.4 D4-D Verso -04/06
1.5i VVTi 105hp 78kw -12/05
1.5i VVTi Verso -04/06

**7676045****Rotule de direction D**

OE 4504659045

Right tie rod end











8 M12x1.25
1.0i 16v. -12/05
1.3i 16v. -12/05
1.3i 16v. Verso -04/06
1.3 VVT-i -12/05
1.4 D4-D -12/05
1.4 D4-D Verso -04/06
1.5i VVTi 105hp 78kw -12/05
1.5i VVTi Verso -04/06

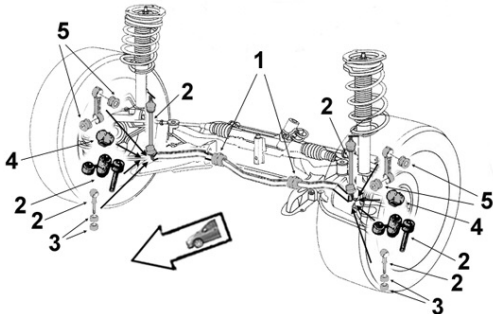

... Yaris ...

TOYOTA



7676090 OE 4504709220	Rotule de direction G <i>Left tie rod end</i>	7676089 OE 4504609480	Rotule de direction D <i>Right tie rod end</i>
NEW 	9 M14 x 1.5 1.0i 12v. 12/05-11/09 1.0i 12v. 03/11- 1.3i 01/09- 1.3 VVT-i 12/05-11/09 1.4 D4-D 12/05-05/11 1.4 D4-D FAP 09/11-	NEW 	8 M14 x 1.5 1.0i 12v. 12/05-11/09 1.0i 12v. 03/11- 1.3i 01/09- 1.3 VVT-i 12/05-11/09 1.4 D4-D 12/05-05/11 1.4 D4-D FAP 09/11-
9006604 OE 4504629305	Rotule de direction G/D <i>L/R tie rod end</i>		
	8 M14 x 1.5 9 1.5i VVTi 04/01-		
	Barre stabilisatrice <i>Stabilizer bar</i> <i>Barra estabilizadora</i> <i>Drążek stabilizatora</i> <i>стабилизатор поперечной устойчивости</i>		
2306054 OE 488200D010	Biellette barre stab. <i>Stabilizer bar stub axle</i>	2306055 OE 4881952010	Biellette barre stab. <i>Stabilizer bar stub axle</i>
	2 1.0i 12v. 03/11- 1.3i 1.3 VVT-i 1.4 D4-D 1.8i BVM		2 1.3i 16v. Verso 03/03-04/06 1.4 D4-D Verso BVM5 03/03-04/06 1.5i VVTi Verso BVM5 03/03-04/06
2306092 OE 4881552010	Palier de barre milieu <i>Middle bar main bearing</i>	2306088 OE 488150D100	Palier de barre milieu <i>Middle bar main bearing</i>
	1 Barre Ø 23 1.0i 16v. Fabrication Japon 04/99-03/03		1 Ø 24 1.0i 12v. 12/05- 1.3 VVT-i 01/09- 1.3i 03/11- 1.3i 16v. 12/05-11/09 1.4 D4-D 12/05- 1.8 WTi
2306091 OE 4881552030	Palier de barre milieu <i>Middle bar main bearing</i>		
	1 Barre Ø 25 1.0i 16v. 04/99-03/03 1.3i 16v. 04/99-03/03 1.3i 16v. Verso 03/03-04/06 1.4 D4-D 12/01-03/03 1.4 D4-D Verso 03/03-04/06 1.5i VVTi 11/01-12/05 1.5i VVTi Verso 03/03-04/06		

... Yaris ...



Eléments SUSPENSION
Suspension parts
Elementos suspensión
Elementy zawieszenia
Элементы подвески

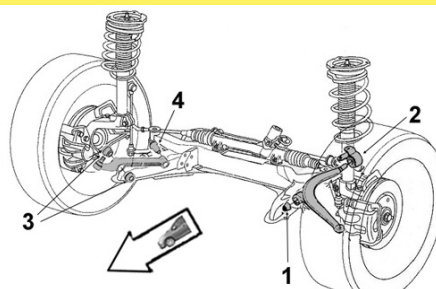

TOYOTA

2250003 Articulation AV

Part/oe 4806859035 Front bush



1 Ø int. 12 Ø ext. 33 coll. 34 long. tube int. 53 ext. 31 ep. coll. 6X2

1.0i 16v.		04/99-12/05
1.3i 16v.		09/99-03/03
1.3i 16v. Verso		03/03-04/06
1.3 VVT-i		03/03-12/05
1.4 D4-D	BVM	12/01-12/05
1.4 D4-D Verso	BVM	03/03-04/06
1.5i VVTi	BVM	11/01-12/05
1.5i VVTi Verso	BVM	03/03-04/06

2256045 Articulation AR

Part/oe 4806859035 Rear bush



2 Ø int. 12 Ø ext. 55 coll. 61 long. tube int. 58 ext. 24 ep. coll. 2.4

1.0i 16v.		04/99-12/05
1.3i 16v.		09/99-03/03
1.3i 16v. Verso		03/03-04/06
1.3 VVT-i		03/03-12/05
1.4 D4-D	BVM	12/01-12/05
1.4 D4-D Verso	BVM	03/03-04/06
1.5i VVTi	BVM	11/01-12/05
1.5i VVTi Verso	BVM	03/03-04/06

Bras & Triangle de suspension

Control arm
Brazo y triángulo
Wahacz
Рычаг подвески

G/L D/R

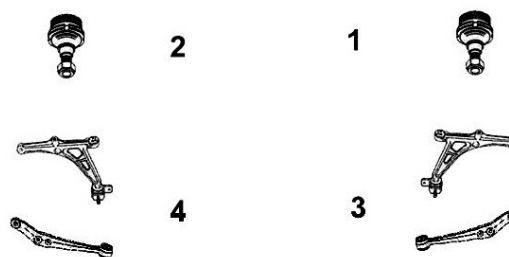

9005847 Triangle de susp. inf. G

OE 4806959035 Lower left track control arm



4 Avec rotule With ball joint

1.0i 16v.		04/99-12/05
1.3i 16v.		09/99-03/03
1.3i 16v. Verso		03/03-04/06
1.3 VVT-i		03/03-12/05
1.4 D4-D	BVM	12/01-12/05
1.4 D4-D Verso	BVM	03/03-04/06
1.5i VVTi	BVM	11/01-12/05
1.5i VVTi Verso	BVM	03/03-04/06

9005846 Triangle de susp. inf. D

OE 4806859035 Lower right track control arm



3 Avec rotule With ball joint

1.0i 16v.		04/99-12/05
1.3i 16v.		09/99-03/03
1.3i 16v. Verso		03/03-04/06
1.3 VVT-i		03/03-12/05
1.4 D4-D	BVM	12/01-12/05
1.4 D4-D Verso	BVM	03/03-04/06
1.5i VVTi	BVM	11/01-12/05
1.5i VVTi Verso	BVM	03/03-04/06

7476164 Triangle de susp. G

OE 4806909041 Left track control arm



NEW

4 Avec rotule With ball joint

1.0i 12v.		01/09-05/11
1.3i		01/09-05/11
1.4 D4-D		01/09-05/11

7476163 Triangle de susp. D

OE 4806809041 Right track control arm



NEW

3 Avec rotule With ball joint

1.0i 12v.		01/09-05/11
1.3i		01/09-05/11
1.4 D4-D		01/09-05/11

... Yaris

7570002

Rotule de susp. inf. G/D

Part/oe 4806859035

L/R lower suspension ball joint



1
2

1.0i 16v.
1.3i 16v.
1.3i 16v. Verso
1.4 D4-D
1.4 D4-D Verso
1.5i VVTi
1.5i VVTi Verso

04/99-03/03
09/99-03/03
03/03-04/06
04/99-03/03
03/03-04/06
04/99-12/05
03/03-04/06



Support d'amortisseur

Suspension mounting
Soporte amortiguador
Poduszka amortyzatora
Опора амортизатора

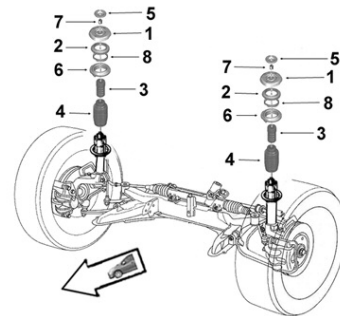

2656055

Support suspension G/D

OE 4860952021

L/R suspension mounting



1

1.0i 16v.

01/99-08/05

2656027

Support suspension G/D

OE 4860952050

L/R suspension mounting



1

1.3i 16v.

01/99-08/05

New Beetle ...

Eléments DIRECTION

Steering parts
Elementos Direcciones
Elementy układ kierowniczy
Элементы рулевой системы

G/L D/R

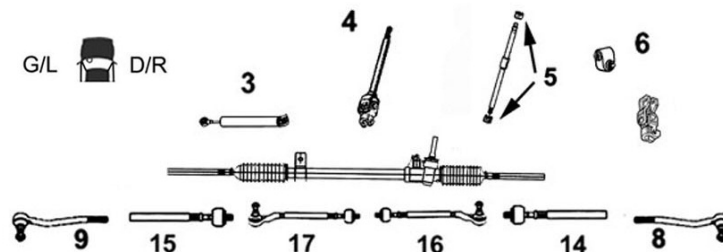

9006219

Axe de bielle G/D

Part/oe 1J0422804H

L/R axial joint



14
15

Côté dir. M16x1.5 Côté rot. M14x1.5 long 320 mm

1.4i 16v. /Cab.
1.6i
1.6i 16v. /Cab.
1.8i 20v. Turbo
1.9 TDi /Cab.
2.0 /Cab.
2.3i V5 20v.

05/01-
05/01-
05/01-
11/99-10/05

05/01-

9006634

Rotule de direction G

OE 1J0422812B

Left tie rod end



9

M14 x 1.5
Dir. TRW

1.4i 16v. /Cab. 05/01-
1.6i 05/01-
1.6i 16v. /Cab. 05/01-
1.8i 20v. Turbo 11/99-10/05
1.9 TDi /Cab.
2.0 /Cab.
2.3i V5 20v. 05/01-

9006635

Rotule de direction D

OE 1J0422811B

Right tie rod end



8

M14 x 1.5
Dir. TRW

1.4i 16v. /Cab. 05/01-
1.6i 05/01-
1.6i 16v. /Cab. 05/01-
1.8i 20v. Turbo 11/99-10/05
1.9 TDi /Cab.
2.0 /Cab.
2.3i V5 20v. 05/01-

... New Beetle ...

Eléments DIRECTION

Steering parts

Elementos Direcciones

Elementy układ kierowniczy

Элементы рулевой системы

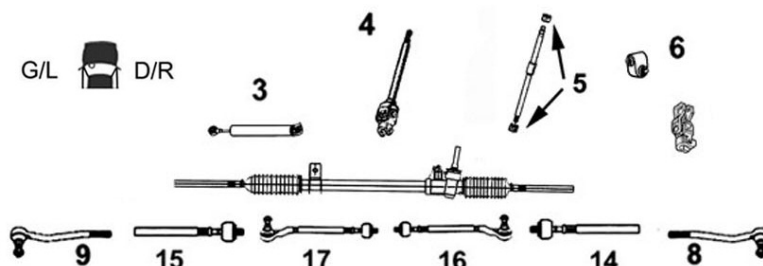

9006638 Rotule de direction G

OE 1K0423811K

Left tie rod end



9

M16 x 1.5

1.2i TSi	09/11-
1.4 TSi	11/11-
1.6 TDi FAP	11/11-
2.0 TSi	09/11-

9006637 Rotule de direction D

OE 1K0423812K

Right tie rod end



8

M16 x 1.5

1.2i TSi	09/11-
1.4 TSi	11/11-
1.6 TDi FAP	11/11-
2.0 TSi	09/11-



Barre stabilisatrice

Stabilizer bar

Barra estabilizadora

Drążek stabilizatora

стабилизатор поперечной устойчивости

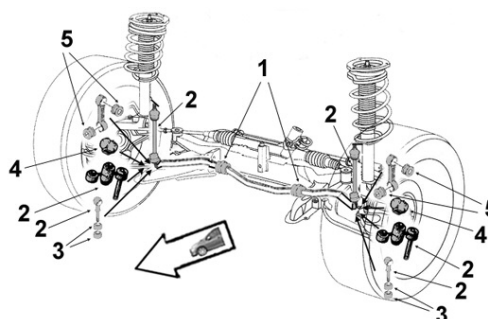

2306010 Bielle barre stab.

OE 1K0411315P

Stabilizer bar stub axle



2

1.2 TSi	09/11-
1.4 TSi	09/11-
1.6 TDi	09/11-
2.0 TSi	09/11-

9005093 Bielle barre stab.

OE 1J0411315K

Stabilizer bar stub axle



2

Barre Ø 23

1.4i 16v.	05/01-
1.6i /16v.	03/00-
1.8i 20v. Turbo	11/99-12/01
1.9 TDi	01/99-
2.0	11/99-
2.3i V5 20v.	09/01-12/01

9005084 Bielle barre stab.

OE 1J0411315J

Stabilizer bar stub axle



2

Barre Ø 21

1.6i /16v.	03/00-
1.8i 20v. Turbo	11/99-12/01
1.9 TDi	01/99-
2.0	11/99-
2.3i V5 20v.	09/01-12/01

9005090 Bielle barre stab.

OE 1J0411315G

Stabilizer bar stub axle



2

Barre Ø 23

1.6i /16v.	03/00-
1.8i 20v. Turbo	11/99-
1.9 TDi	01/99-
2.0	01/99-
2.3i V5 20v.	09/01-

9005018 Liaison élastique

OE 1J0411327

Elastic link





5

Ø int.14.5 ext. Ø29 coll.35 x2 long. tube int.22.5 ext.18 ep. coll.2 x2

1.6i /16v.	03/00-
1.8i 20v. Turbo	11/99-12/01
1.9 TDi	01/99-
2.0	01/99-
2.3i V5 20v.	09/01-12/01

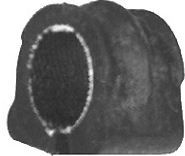

... New Beetle ...

<p>9001730 Palier de barre milieu OE 1J0411314R <i>Middle bar main bearing</i></p>	<p>9001732 Palier de barre milieu OE 1J0411314T <i>Middle bar main bearing</i></p>																						
 <p>1 Barre Ø 21</p> <table style="width: 100%; border-collapse: collapse;"> <tr><td>1.4i 16v.</td><td style="text-align: right;">-05/01</td></tr> <tr><td>1.6i</td><td style="text-align: right;">-05/01</td></tr> <tr><td>1.8i 20v. Turbo</td><td style="text-align: right;">-05/01</td></tr> <tr><td>1.9 TDi</td><td style="text-align: right;">-05/01</td></tr> <tr><td>2.0</td><td style="text-align: right;">-05/01</td></tr> </table>	1.4i 16v.	-05/01	1.6i	-05/01	1.8i 20v. Turbo	-05/01	1.9 TDi	-05/01	2.0	-05/01	 <p>1 Barre Ø 23</p> <table style="width: 100%; border-collapse: collapse;"> <tr><td>1.4i 16v.</td><td style="text-align: right;">05/01-</td></tr> <tr><td>1.6i /16v.</td><td style="text-align: right;">03/00-</td></tr> <tr><td>1.8i 20v. Turbo</td><td style="text-align: right;">11/99-10/05</td></tr> <tr><td>1.9 TDi</td><td style="text-align: right;">01/99-</td></tr> <tr><td>2.0</td><td style="text-align: right;">01/99-</td></tr> <tr><td>2.3i V5 20v.</td><td style="text-align: right;">09/01-10/05</td></tr> </table>	1.4i 16v.	05/01-	1.6i /16v.	03/00-	1.8i 20v. Turbo	11/99-10/05	1.9 TDi	01/99-	2.0	01/99-	2.3i V5 20v.	09/01-10/05
1.4i 16v.	-05/01																						
1.6i	-05/01																						
1.8i 20v. Turbo	-05/01																						
1.9 TDi	-05/01																						
2.0	-05/01																						
1.4i 16v.	05/01-																						
1.6i /16v.	03/00-																						
1.8i 20v. Turbo	11/99-10/05																						
1.9 TDi	01/99-																						
2.0	01/99-																						
2.3i V5 20v.	09/01-10/05																						

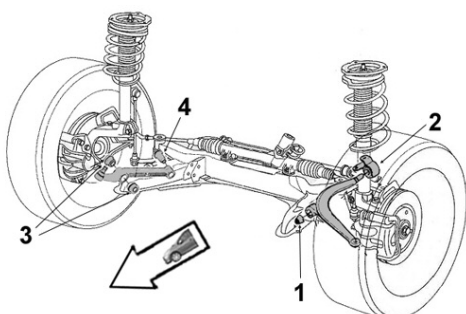

Eléments SUSPENSION
Suspension parts
Elementos suspensión
Elementy zawieszenia
Элементы подвески



<p>9001759 Articulation AV OE 1K0407182 <i>Front bush</i></p>	<p>9001523 Articulation AV OE 357407182 <i>Front bush</i></p>																				
 <p>1 Ø int.12 Ø ext.40 coll.48 long. tube int.54 ext.33 ep. coll.6</p> <table style="width: 100%; border-collapse: collapse;"> <tr><td>1.2 TSi</td><td style="text-align: right;">09/11-</td></tr> <tr><td>1.4 TSi</td><td style="text-align: right;">09/11-</td></tr> <tr><td>1.6 TDi</td><td style="text-align: right;">09/11-</td></tr> <tr><td>2.0 TSi</td><td style="text-align: right;">09/11-</td></tr> </table>	1.2 TSi	09/11-	1.4 TSi	09/11-	1.6 TDi	09/11-	2.0 TSi	09/11-	 <p>1 Ø int.12 Ø ext.33 coll.36 long. tube int.54 ext.29 ep. coll.5</p> <table style="width: 100%; border-collapse: collapse;"> <tr><td>1.4i 16v.</td><td style="text-align: right;">05/01-09/10</td></tr> <tr><td>1.6i /16v.</td><td style="text-align: right;">03/00-09/10</td></tr> <tr><td>1.8i 20v. Turbo</td><td style="text-align: right;">11/99-12/01</td></tr> <tr><td>1.9 TDi</td><td style="text-align: right;">01/99-09/10</td></tr> <tr><td>2.0</td><td style="text-align: right;">01/99-09/10</td></tr> <tr><td>2.3i V5 20v.</td><td style="text-align: right;">09/01-12/01</td></tr> </table>	1.4i 16v.	05/01-09/10	1.6i /16v.	03/00-09/10	1.8i 20v. Turbo	11/99-12/01	1.9 TDi	01/99-09/10	2.0	01/99-09/10	2.3i V5 20v.	09/01-12/01
1.2 TSi	09/11-																				
1.4 TSi	09/11-																				
1.6 TDi	09/11-																				
2.0 TSi	09/11-																				
1.4i 16v.	05/01-09/10																				
1.6i /16v.	03/00-09/10																				
1.8i 20v. Turbo	11/99-12/01																				
1.9 TDi	01/99-09/10																				
2.0	01/99-09/10																				
2.3i V5 20v.	09/01-12/01																				

<p>9001542 Articulation AR OE 1J0407181 <i>Rear bush</i></p>													
 <p>2 Ø int.13 Ø ext.59.5 long. tube int.41 ext.23.5</p> <table style="width: 100%; border-collapse: collapse;"> <tr><td>1.4i 16v.</td><td style="text-align: right;">05/01-09/10</td></tr> <tr><td>1.6i /16v.</td><td style="text-align: right;">03/00-09/10</td></tr> <tr><td>1.8i 20v. Turbo</td><td style="text-align: right;">11/99-09/10</td></tr> <tr><td>1.9 TDi</td><td style="text-align: right;">01/99-09/10</td></tr> <tr><td>2.0</td><td style="text-align: right;">01/99-09/10</td></tr> <tr><td>2.3i V5 20v.</td><td style="text-align: right;">09/01-09/10</td></tr> </table>	1.4i 16v.	05/01-09/10	1.6i /16v.	03/00-09/10	1.8i 20v. Turbo	11/99-09/10	1.9 TDi	01/99-09/10	2.0	01/99-09/10	2.3i V5 20v.	09/01-09/10	
1.4i 16v.	05/01-09/10												
1.6i /16v.	03/00-09/10												
1.8i 20v. Turbo	11/99-09/10												
1.9 TDi	01/99-09/10												
2.0	01/99-09/10												
2.3i V5 20v.	09/01-09/10												

Bras & Triangle de suspension
Control arm
Brazo y triángulo
Wahacz
Рычаг подвески

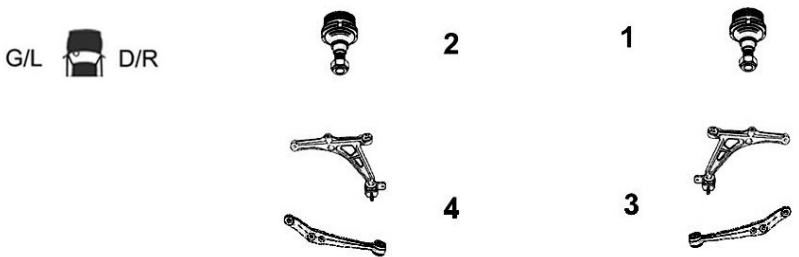

<p>9005136 Triangle de susp. G/D OE 1J0407151C <i>L/R track control arm</i></p>																	
 <p>3 Sans rotule Without tie rod end 4 TT /all models</p> <table style="width: 100%; border-collapse: collapse;"> <tr><td>1.4i 16v. /Cab.</td><td style="text-align: right;">-05/01</td></tr> <tr><td>1.6i</td><td style="text-align: right;">05/01-09/10</td></tr> <tr><td>1.6i 16v. /Cab.</td><td style="text-align: right;">05/01-09/10</td></tr> <tr><td>1.8i 20v.</td><td style="text-align: right;">05/01-09/10</td></tr> <tr><td>1.9 TDi /Cab.</td><td style="text-align: right;">11/99-10/05</td></tr> <tr><td>2.0i /Cab.</td><td style="text-align: right;">05/01-09/10</td></tr> <tr><td>2.3i V5 20v.</td><td style="text-align: right;">01/99-09/10</td></tr> <tr><td></td><td style="text-align: right;">05/01-09/10</td></tr> </table> <p style="text-align: center;">AQN</p>	1.4i 16v. /Cab.	-05/01	1.6i	05/01-09/10	1.6i 16v. /Cab.	05/01-09/10	1.8i 20v.	05/01-09/10	1.9 TDi /Cab.	11/99-10/05	2.0i /Cab.	05/01-09/10	2.3i V5 20v.	01/99-09/10		05/01-09/10	
1.4i 16v. /Cab.	-05/01																
1.6i	05/01-09/10																
1.6i 16v. /Cab.	05/01-09/10																
1.8i 20v.	05/01-09/10																
1.9 TDi /Cab.	11/99-10/05																
2.0i /Cab.	05/01-09/10																
2.3i V5 20v.	01/99-09/10																
	05/01-09/10																

... New Beetle ...

Bras & Triangle de suspension

Control arm
Brazo y triángulo
Wahacz
Рычаг подвески

G/L  D/R

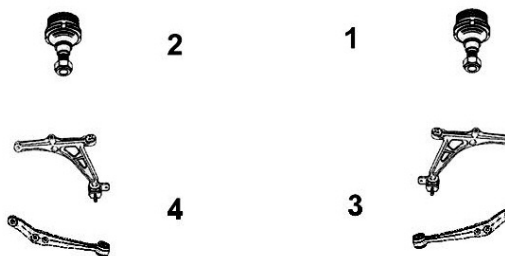

7476118 Triangle de susp. G
OE 1J0407151C+1J040735H Left track control arm

NEW



3	Avec rotule With ball joint	
	TT /all models	-05/01
	1.4i 16v. /Cab.	05/01-09/10
	1.6i	05/01-09/10
	1.6i 16v. /Cab.	05/01-09/10
	1.8i 20v.	11/99-10/05
	1.9 TDi /Cab.	05/01-09/10
	2.0i /Cab.	01/99-09/10
	2.3i V5 20v.	05/01-09/10

7476119 Triangle de susp. D
OE 1J0407151C+1J0407366H Right track control arm

NEW



4	Avec rotule With ball joint	
	TT /all models	-05/01
	1.4i 16v. /Cab.	05/01-09/10
	1.6i	05/01-09/10
	1.6i 16v. /Cab.	05/01-09/10
	1.8i 20v.	11/99-10/05
	1.9 TDi /Cab.	05/01-09/10
	2.0i /Cab.	01/99-09/10
	2.3i V5 20v.	05/01-09/10

9005266 Rotule de susp. inf. G
OE 1J0407365J Left lower suspension ball joint



2	Axe Ø 18	
	TT /all models	-05/01
	1.4i 16v. /Cab.	05/01-
	1.6i	05/01-
	1.6i 16v. /Cab.	05/01-
	1.8i 20v.	11/99-10/05
	1.9 TDi /Cab.	03/00-
	2.0i /Cab.	01/99-
	2.3i V5 20v.	05/01-

9005267 Rotule de susp. inf. D
OE 1J0407366J Right lower suspension ball joint



1	Axe Ø 18	
	TT /all models	-05/01
	1.4i 16v. /Cab.	05/01-
	1.6i	05/01-
	1.6i 16v. /Cab.	05/01-
	1.8i 20v.	11/99-10/05
	1.9 TDi /Cab.	10/05-
	2.0i /Cab.	01/99-
	2.3i V5 20v.	05/01-

9005570 Rotule de susp. inf. G
OE 1K0407365C Left lower suspension ball joint



2		
	1.2 TSi	09/11-
	1.4 TSi	11/11-
	1.6 TDi	11/11-
	2.0 TSi	09/11-

9005569 Rotule de susp. inf. D
OE 1K0407366C Right lower suspension ball joint



1		
	1.2 TSi	09/11-
	1.4 TSi	11/11-
	1.6 TDi	11/11-
	2.0 TSi	09/11-



Support d'amortisseur

Suspension mounting
Soporte amortiguador
Poduszka amortyzatora
Опора амортизатора

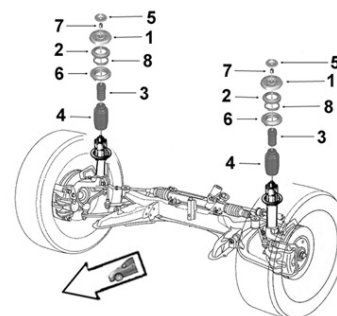

9005614 Tampon suspension AV G/D
OE 1J0412331C L/R front suspension rebound stop







1		
	1.4i 16v.	05/01-
	1.6i /16v.	03/00-
	1.8i 20v. Turbo	11/99-12/01
	1.9 TDi	01/99-
	2.0	01/99-
	2.3i V5 20v.	09/01-12/01

9005352 Butée à billes G/D
OE 1J0412249 L/R ball bearing



2		
	1.4i 16v.	05/01-
	1.6i /16v.	03/00-
	1.8i 20v. Turbo	11/99-12/01
	1.9 TDi	01/99-
	2.0	01/99-
	2.3i V5 20v.	09/01-12/01

... New Beetle ...

2656003 OE 1J0412303	Butée de suspension <i>Shock bush</i>	2656052 OE 1K0412303B	Butée de suspension <i>Shock bush</i>
	3 H53 1.4i 16v. BVM 01/02- 1.6i BVM 03/00-10/05 1.6i 16v. 03/00- 1.8i 20v. Turbo BVM 11/99-10/05 1.9 TDi 01/99- 2.0i BVM 01/99-10/05 2.3i V5 20v. BVM 09/01-10/05		3 H70 1.2 TSi 09/11- 1.4 TSi 11/11- 1.6 TDi 11/11-
9005327 OE 357413175A	Protecteur amortisseur G/D <i>L/R shock absorber protector</i>	2656053 OE 6N0413175A	Protecteur amortisseur G/D <i>L/R shock absorber protector</i>
	4 H221.5 1.4i 16v. 05/01- 1.6i /16v. 03/00- 1.8i 20v. Turbo 11/99-12/01 1.9 TDi 01/99- 2.0 01/99- 2.3i V5 20v. 09/01-12/01		4 H206 1.2 TSi 09/11- 1.4 TSi 11/11- 1.6 TDi 11/11- 2.0 TSi 09/11-



Barre stabilisatrice
Stabilizer bar
Barra estabilizadora
Drażek stabilizatora
 стабилизатор поперечной устойчивости

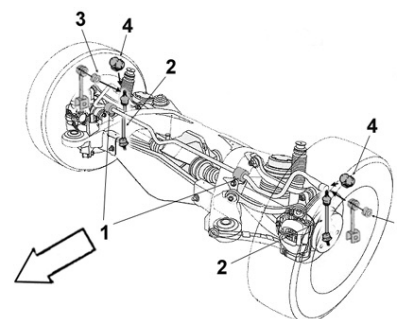

9005094 OE 1K0505465K	Biellette barre stab. <i>Stabilizer bar stub axle</i>		
	2 1.2 TSi 09/11- 1.4 TSi 09/11- 1.6 TDi 09/11- 2.0 TSi 09/11-		



Support d'amortisseur
Suspension mounting
Soporte amortiguador
Poduszka amortyzatora
 Опора амортизатора

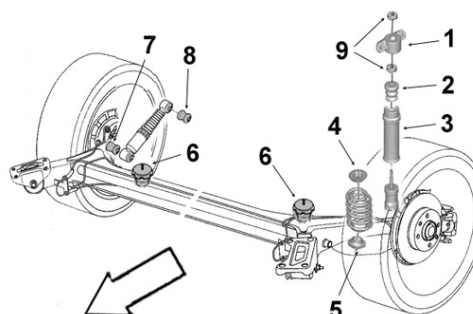

9005630 OE 1J0513353B	Support suspension G/D <i>L/R suspension mounting</i>		
	1 1.9 TDi ALH ATD 01/99-		



VOLKSWAGEN

... New Beetle

Eléments TRAIN ARRIERE
Rear axle parts
Tren TRAS
Elementy zawieszenia tylnego
элементы задней оси.



2606001

OE 6R0501541A

Articulation traverse

Cross bar bush

Ø int. 12 Ø ext. 71.5 coll. 80
long. tube int. 90 ext. 54.5



1.4i 16v.	BVM	01/02-03/00-
1.6i		10/00-10/05
1.6i 16v.		11/99-10/05
1.8i 20v. Turbo	BVM	01/99-
1.9 TDi		01/99-10/05
2.0i	BVM	01/99-10/05
2.3i V5 20v.	BVM	09/01-10/05

Bora ...

Eléments DIRECTION
Steering parts
Elementos Direcciones
Elementy uklad kierowniczy
Элементы рулевой системы

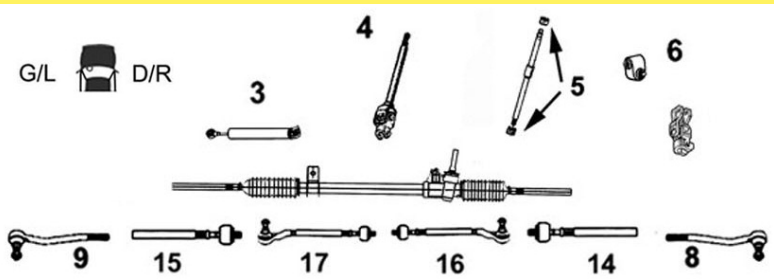

9006219

Axe de bielle G/D

Part/oe 1J0422803H L/R axial joint



14 Côté dir. M16x1.5 Côté rot. M14x1.5 long 320 mm

1.6i		
1.6i 16v.		
1.8i Turbo /GTi		
1.9 TDi		
2.0i		
2.3i V5 20v.		
2.8i V6 /4WD		

10/00-12/05

9006634

Rotule de direction G

OE 1J0422812B Left tie rod end



9 M14 x 1.5 Dir. TRW

1.6i		
1.6i 16v.		10/00-12/05
1.8i GTi Turbo		10/00-12/02
1.8i 20v. Turbo		12/02-12/05
1.9 TDi		
2.0i		10/98-09/00
2.3i V5 20v.		
2.8i V6 24v.		03/00-12/05

9006635

Rotule de direction D

OE 1J0422811B Right tie rod end



8 M14 x 1.5 Dir. TRW

1.6i		
1.6i 16v.		10/00-12/05
1.8i GTi Turbo		10/00-12/02
1.8i 20v. Turbo		12/02-12/05
1.9 TDi		
2.0i		10/98-09/00
2.3i V5 20v.		
2.8i V6 24v.		03/00-12/05



Barre stabilisatrice
Stabilizer bar
Barra estabilizadora
Drażek stabilizatora
стабилизатор поперечной устойчивости

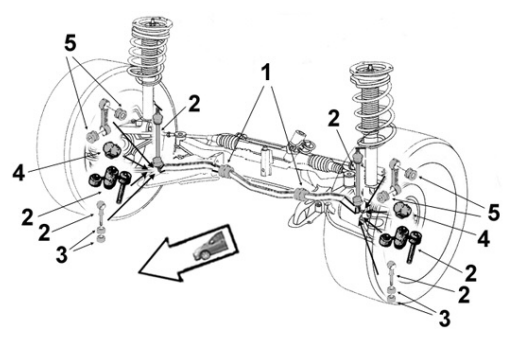

9005084

Biellette barre stab.

OE 1J0411315J Stabilizer bar stub axle



2 Barre Ø 21 -ch 1JX999000

1.6i		
1.9 TDi		
2.3i V5 20v.		sauf 4 motion

9005090

Biellette barre stab.



OE 1J0411315G Stabilizer bar stub axle





2 Barre Ø 23
2.3i V5 20v. 4 motion -ch 1JX999000

Ch- 1JY000001		
1.6i		
1.9 TDi		
2.3i V5 20v.		sauf 4 motion

... Bora ...

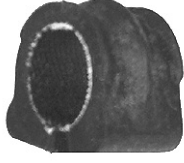

9005018 OE 1J0411327	Liaison élastique <i>Elastic link</i>	9001730 OE 1J0411314R	Palier de barre milieu <i>Middle bar main bearing</i>
	5 Ø int.14.5 ext. Ø29 coll.35 x2 long. tube int.22.5 ext.18 ep. coll.2 x2 1.6i 1.9 TDi 2.3i V5 20v. sauf 4 motion		1 Barre Ø 21 -ch 1JX999000 1.6i 1.9 TDi 90hp 66kw 2.3i V5 20v.

9001732 OE 1J0411314T	Palier de barre milieu <i>Middle bar main bearing</i>	2306134 OE 1J0411314S	Palier de barre <i>Bar main bearing</i>
	1 Barre Ø 23 Ch- 1JY000001 1.6i 1.9 TDi 90hp 66kw 2.3i V5 20v.		1 Ø 17 1.8i 4WD /Break 02/99-05/05 1.9TDi 4WD /Break 02/99-05/05 2.0 4WD /Break 04/00-05/05 2.3 V5 4WD /Break 12/98-05/05 2.8 V6 4WD /Break 03/99-05/05



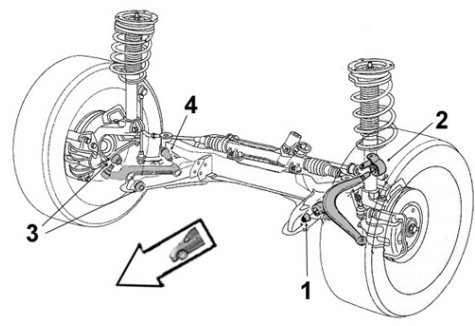

Eléments SUSPENSION
Suspension parts
Elementos suspensión
Elementy zawieszenie
Элементы подвески

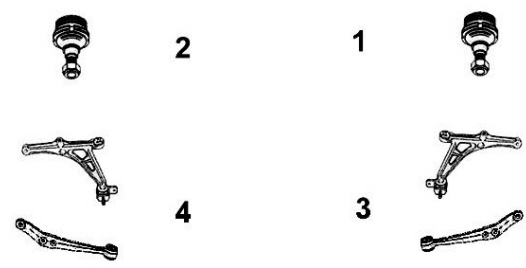

9001523 OE 357407182	Articulation AV <i>Front bush</i>	9001542 OE 1J0407181	Articulation AR <i>Rear bush</i>
	1 Ø int.12 Ø ext.33 coll.36 long. tube int.54 ext.29 ep. coll.5 1.6i 1.9 TDi 2.3i V5 20v.		2 Ø int.13 Ø ext.59.5 long. tube int.41 ext.23.5 1.6i 1.9 TDi 2.3i V5 20v.

Bras & Triangle de suspension
Control arm
Brazo y triángulo
Wahacz
Рычаг подвески



9005136 OE 1J0407151C	Triangle de susp. G/D <i>L/R track control arm</i>		
	3 4 Sans rotule <i>Without tie rod end</i> 1.6i 1.6i 16v. 1.8 GTi /20v. Turbo 1.9 TDi 2.0i 2.3i V5 20v. 2.8i V6	 10/00- 10/00-	

Les réf. constructeurs (OE) ne servent qu'à identifier les pièces et sont données à titre indicatif.

... Bora ...

Bras & Triangle de suspension

Control arm
Brazo y triángulo
Wahacz
Рычаг подвески

G/L  D/R

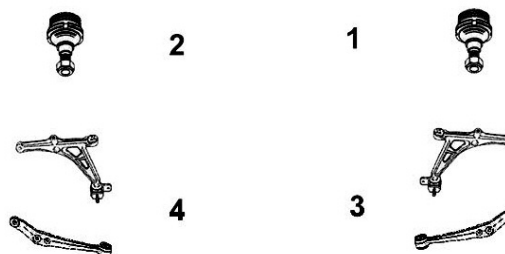

7476118 Triangle de susp. G
OE 1J0407151C+1J040735H Left track control arm

NEW



3 Avec rotule With ball joint
1.6i
1.6i 16v. 10/00-
1.8 GTi /20v. Turbo 10/00-
1.9 TDi 10/98-09/00
2.0i
2.3i V5 20v. 10/98-09/00
2.8i V6 03/00-

7476119 Triangle de susp. D
OE 1J0407151C+1J0407366H Right track control arm

NEW



4 Avec rotule With ball joint
1.6i
1.6i 16v. 10/00-
1.8 GTi /20v. Turbo 10/00-
1.9 TDi 10/98-09/00
2.0i
2.3i V5 20v. 10/98-09/00
2.8i V6 03/00-

9005266 Rotule de susp. inf. G
OE 1J0407365J Left lower suspension ball joint



2 Axe Ø 18
1.6i
1.6i 16v. 10/00-
1.8 GTi /20v. Turbo 10/00-
1.9 TDi 10/98-09/00
2.0i
2.3i V5 20v. 10/98-09/00
2.8i V6 03/00-

9005267 Rotule de susp. inf. D
OE 1J0407366J Right lower suspension ball joint



1 Axe Ø 18
1.6i
1.6i 16v. 10/00-
1.8 GTi /20v. Turbo 10/00-
1.9 TDi 10/98-09/00
2.0i
2.3i V5 20v. 10/98-09/00
2.8i V6 03/00-



Support d'amortisseur
Suspension mounting
Soporte amortiguador
Poduszka amortyzatora
Опора амортизатора

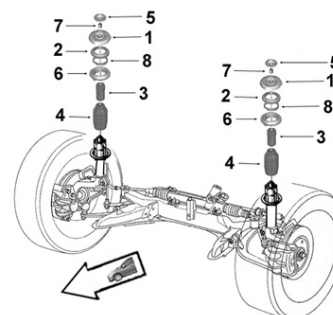

9005614 Tampon suspension AV G/D
OE 1J0412331C L/R front suspension rebound stop



1
1.6i
1.9 TDi
2.3i V5 20v.

9005352 Butée à billes G/D
OE 1J0412249 L/R ball bearing



2
1.6i
1.6i 16v. 10/00-
1.8i 20v. Turbo -12/05
1.9 TDi
2.0 10/98-
2.3i V5 20v.
2.8 V6 4WD 03/00-12/05

2656003 Butée de suspension
OE 1J0412303 Shock bush

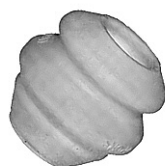

3 H53
1.6i /Break 10/98-12/05
1.6i 16v. /Break 10/00-12/05
1.8 GTi Turbo /Break 10/00-12/02
1.8i 20v. Turbo /Break 12/02-12/05
1.9 TDi /Break 10/98-12/05
2.0i /Break 10/98-09/00
2.3i V5 20v. /Break 10/98-05/04
2.8i V6 4WD 03/00-12/05
2.8i VR6 24v. 03/00-12/05

9005338 Butée de suspension
OE 1H0412303B Shock bush



3 H64
1.6i /Break
1.8i 20v. Turbo /Break
1.9 TDi /Break
2.0i /Break
2.3 VR5 /Break -ch 1JY320000
2.8

... Bora

9005327 **Protecteur amortisseur G/D**
OE 357413175A *L/R shock absorber protector*



4 H221.5

1.6i
1.9 TDi
2.3i V5 20v.



Support d'amortisseur
Suspension mounting
Soporte amortiguador
Poduszka amortyzatora
Опора амортизатора

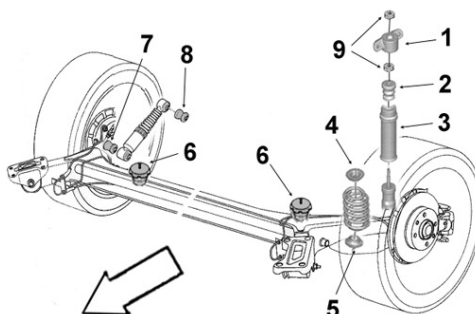

9005630 **Support suspension G/D**
OE 1J0513353B *L/R suspension mounting*



1

1.6i
1.9 TDi
2.3i V5 20v. sauf 4 motion

9005328 **Butée de suspension G/D**
OE 1J0512131B *L/R suspension bush*

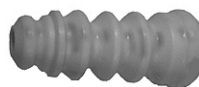

2 H 129

1.6i Berline
1.8i 20v. Turbo Break Ch- 1J1400001
1.9 TDi Berline
1.9 TDi Break Ch- 1J1400001
2.0 Berline
2.3i V5 20v. Berline sauf 4 motion
2.3i V5 20v. Break Ch- 1J1400001

Eléments TRAIN ARRIERE
Rear axle parts
Tren TRAS
Elementy zawieszenia tylnego
элементы задней оси.



2606001 **Articulation traverse**
OE 6R0501541A *Cross bar bush*



Ø int. 12 Ø ext. 71.5 coll. 80
long. tube int. 90 ext. 54.5

1.6i
1.9 TDi
2.3i V5 20v. sauf 4 motion

Corrado ...

Eléments DIRECTION
Steering parts
Elementos Direcciones
Elementy uklad kierowniczy
Элементы рулевой системы

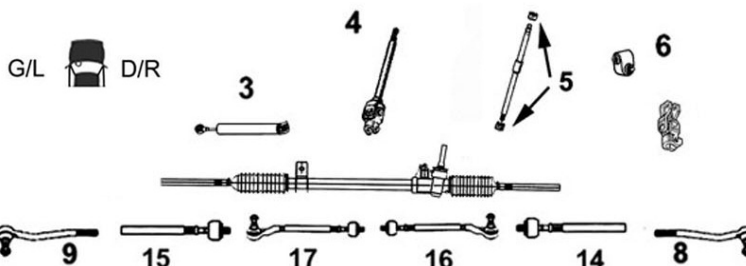

9006214 **Axe de bielle G/D**
Part/oe 3A0422804C *L/R axial joint*



14 Côté dir. M14x1.5
15 Côté rot. M14x1.5 long 361 mm

TT /all models sauf VR6 DA 09/88-

9006218 **Axe de bielle G/D**
Part/oe 1H0422803A *L/R axial joint*



14 Côté dir. M14x1.5
15 Côté rot. M14x1.5 long 371 mm

2.9 VR6 DA 09/88-

... Corrado ...

Eléments DIRECTION

Steering parts
Elementos Direcciones
Elementy układ kierowniczy
Элементы рулевой системы

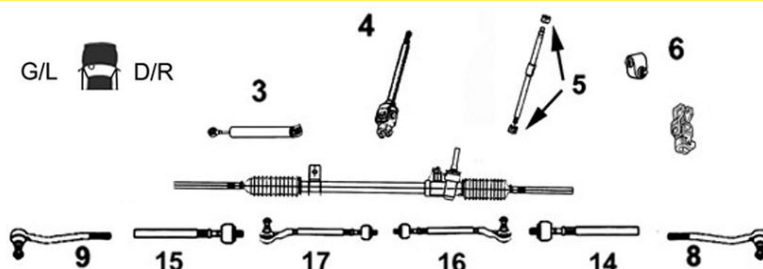

9006380 **Rotule de direction G**
 OE 191419811 *Left tie rod end*



9 M14 x 1.5

 TT /all models 09/88-

9006381 **Rotule de direction D**
 OE 191419812 *Right tie rod end*



8 M14 x 1.5

 TT /all models 09/88-



Barre stabilisatrice

Stabilizer bar
Barra estabilizadora
Drażek stabilizatora
 стабилизатор поперечной устойчивости

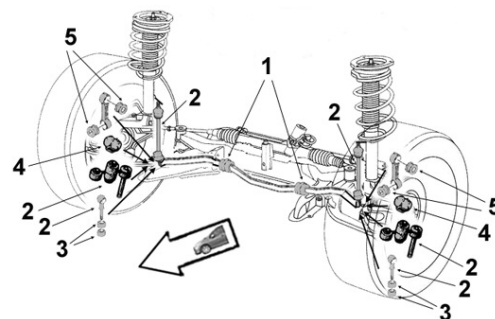

9001522 **Palier de barre milieu**
 OE 191411314 *Middle bar main bearing*



1 Barre Ø 17

 1.8i 16v.
 1.8 G60
 2.0
 2.0i 16v.
 2.9 VR6



Eléments SUSPENSION

Suspension parts
Elementos suspensión
Elementy zawieszenie
 Элементы подвески

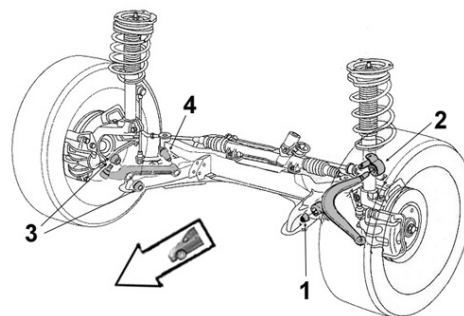

9001523 **Articulation AV**
 OE 357407182 *Front bush*



1 Ø int.12 Ø ext.33 coll.36
 long. tube int.54 ext.29 ep. coll.5

 1.8i 16v. 01/89-
 1.8 G60 01/89-
 2.0 01/89-
 2.0i 16v. 01/89-
 2.9 VR6 01/89-

9001520 **Articulation AR**
 OE 191407181D *Rear bush*



2 Ø int.17 Ø ext.60.5
 long. tube int.41 ext.24.5

 1.8i 16v. 01/89-
 1.8 G60 01/89-
 2.0 01/89-
 2.0i 16v. 01/89-
 2.9 VR6 01/89-

... Corrado ...

Bras & Triangle de suspension

Control arm
Brazo y triángulo
Wahacz
Рычаг подвески

G/L  D/R

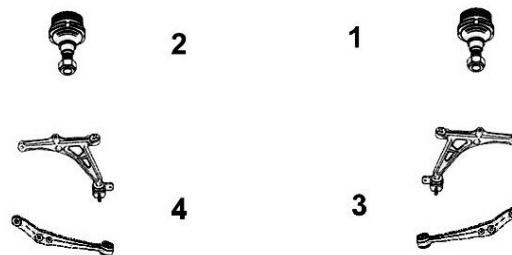

9005133

Triangle de susp. G/D

OE 191407151B

L/R track control arm



3 Sans rotule Without tie rod end

4

TT /all models Sauf 2.9

09/88-

7476107

Triangle de susp. G

OE 191407151B+357407365 Left track control arm

NEW



4 Avec rotule With ball joint Ø 19

TT /all models Sauf 2.9 09/88-

7476108

Triangle de susp. D

OE 191407151B+357407365 Right track control arm

NEW



3 Avec rotule With ball joint Ø 19

TT /all models Sauf 2.9 09/88-

9005260

Rotule de susp. inf. G/D

OE 357407365

L/R lower suspension ball joint



1 Ø 19 Cylindrique

2

TT /all models Sauf 2.9 09/88-

9005268

Rotule de susp. inf. G/D

OE 1H0407366A

L/R lower suspension ball joint



1 Cône Ø 16.8 - Ø 18

2

2.9 VR6

09/88-



Support d'amortisseur

Suspension mounting
Soporte amortiguador
Poduszka amortyzatora
Опора амортизатора

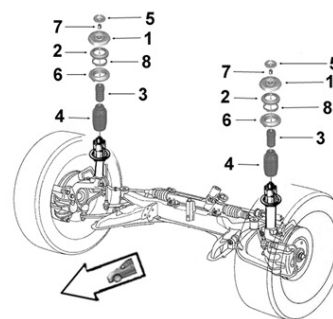

9001708

Support suspension G/D

OE 357412329

L/R suspension mounting



1 Avec roulement With bearing

1.8i 16v. -12/93
1.8 G60 -12/93
2.0 -07/94
2.0i 16v. -07/94

9001709

Support suspension G/D

OE 357412331A

L/R suspension mounting



1

2.0 07/94-
2.0i 16v. 07/94-
2.9 VR6 08/91-

... Corrado ...



Support d'amortisseur
 Suspension mounting
 Soporte amortiguador
 Poduszka amortyzatora
 Опора амортизатора

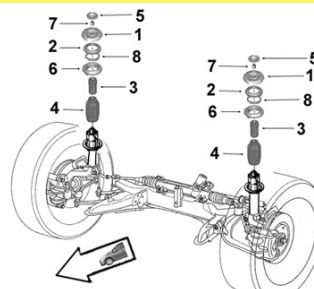

9005362

Butée de suspension G/D

OE 357412303E

L/R suspension bush

3

H84



1.8i 16v. -07/94
 1.8 G60 -07/94
 2.0 -07/94
 2.0i 16v. -07/94

9005363

Butée de suspension G/D

OE 357412303F

L/R suspension bush

3

H83



2.0 07/94-
 2.0i 16v. 07/94-
 2.9 VR6 07/94-

9005369

Protecteur amortisseur G/D

OE 1H0413175

L/R shock absorber protector

4

-ch 50R000898



1.8i 16v.
 1.8 G60
 2.0
 2.0i 16v.
 2.9 VR6

9005327

Protecteur amortisseur G/D

OE 357413175A

L/R shock absorber protector

4

H221.5
Ch- 50R000899



1.8i 16v.
 1.8 G60
 2.0
 2.0i 16v.
 2.9 VR6



Support d'amortisseur
 Suspension mounting
 Soporte amortiguador
 Poduszka amortyzatora
 Опора амортизатора

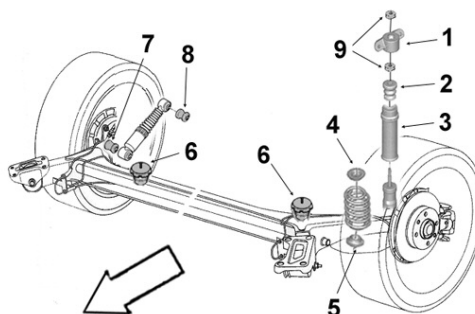

9005361

Butée de suspension AR G/D

OE 191512131B

L/R rear suspension bush

2

H146



1.8i 16v.
 1.8 G60
 2.0
 2.0i 16v.
 2.9 VR6

9005368

Protecteur amortisseur G/D

OE 191513425

L/R shock absorber protector

3

H90



1.8i 16v.
 1.8 G60
 2.0
 2.0i 16v.
 2.9 VR6

... Corrado

Eléments TRAIN ARRIERE

Rear axle parts

Tren TRAS

Elementy zawieszenia tylnego

элементы задней оси.

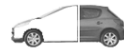

9001705

Articulation essieu AR G/D

OE 1H0501541A

L/R Rear axle bush



Ø int.12 Ø ext.56.5 coll.74
long. tube int.90 ext.51 ep. coll.3

1.8i 16v.
1.8 G60
2.0
2.0i 16v.
2.9 VR6

9001704

Articulation essieu AR G/D

OE 191501541

L/R Rear axle bush



Ø int.12 Ø ext.44.5 coll.72
long. tube int.90 ext.58 ep. coll.2.5

1.8i 16v. -07/92
1.8 G60 -09/93
2.0 -12/95
2.0i 16v. -12/95

Derby

Eléments DIRECTION

Steering parts

Elementos Direcciones

Elementy uklad kierowniczy

Элементы рулевой системы

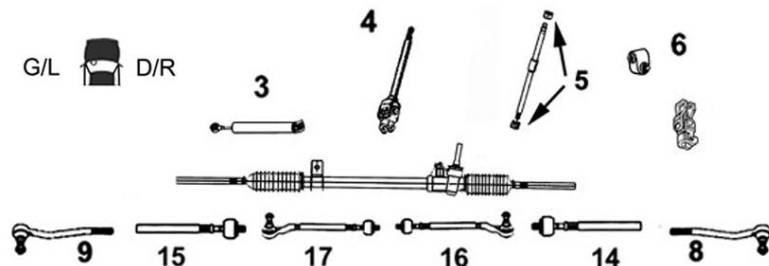

9006382

Rotule de direction G/D

OE 811419812

L/R tie rod end



8 M14 x 1.5
9

TT /all models

04/75-08/85



Support d'amortisseur

Suspension mounting

Soporte amortiguador

Poduszka amortyzatora

Опора амортизатора

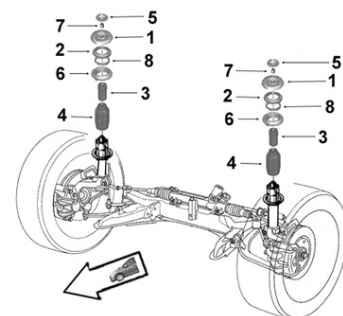

8005201

Support suspension G/D

OE 871412323A

L/R suspension mounting



1 Avec roulement With bearing

1.05

01/84-06/94

Eos ...

Eléments DIRECTION
Steering parts
Elementos Direcciones
Elementy układ kierowniczy
Элементы рулевой системы

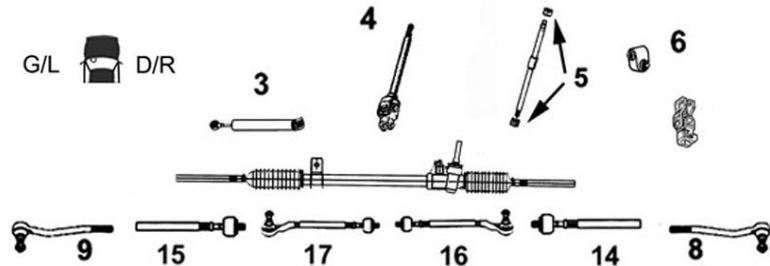

9006873 **Axe de bielle G/D**
 OE 1K0423810A *L/R axial joint*



14 Côté dir. M16x1.5 Côté rot. M16x1.5 long 310 mm
15

1.4 TSi	10/07-
1.6 FSi	06/06-10/07
2.0 FSi	04/06-07/08
2.0 TFSi	04/06-
2.0 TDi	04/06-
3.2 FSi	12/06-
3.6 FSi	04/09-

9006638 **Rotule de direction G**
 OE 1K0423811J *Left tie rod end*



9 M16 x 1.5

1.4 TSi	10/07-
1.6 FSi	06/06-10/07
2.0 FSi	04/06-07/08
2.0 TFSi TSi	04/06-
2.0 TDi /FAP	04/06-
3.2 FSi	12/06-
3.6 FSi	04/09-

9006637 **Rotule de direction D**
 OE 1K0423812J *Right tie rod end*



8 M16 x 1.5

1.4 TSi	10/07-
1.6 FSi	06/06-10/07
2.0 FSi	04/06-07/08
2.0 TFSi TSi	04/06-
2.0 TDi /FAP	04/06-
3.2 FSi	12/06-
3.6 FSi	04/09-



Barre stabilisatrice
Stabilizer bar
Barra estabilizadora
Drażek stabilizatora
 стабилизатор поперечной устойчивости

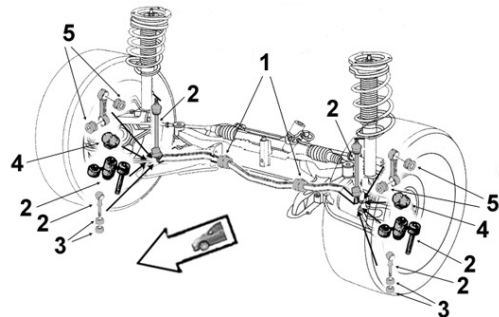

2306010 **Biellette barre stab.**
 OE 1K0411315P *Stabilizer bar stub axle*



2

1.4 TSi	-ch 1FZBV006059	11/07-
1.6 TSi		06/06-05/08
2.0 FSi		03/06-05/08
2.0 TFSi TSi	-ch 1FZBV006059	03/06-
2.0 TDi	-ch 1FZBV006059	04/06-
3.2 FSi		06/06-
3.6 FSi		05/09-

... Eos ...



Eléments SUSPENSION

Suspension parts

Elementos suspensión

Elementy zawieszenie

Элементы подвески

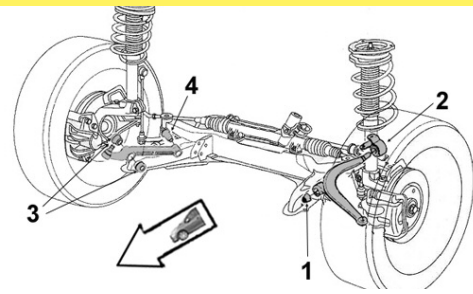

VOLKSWAGEN



9001759

Articulation AV

OE 1K0407182

Front bush



1 Ø int.12 Ø ext.40 coll.48 long. tube int.54 ext.33 ep. coll.6

1.4 TSi
1.6 FSi
2.0 FSi
2.0 TFSi TSI
2.0 TDi
3.2 FSi
3.6 FSi

06/06-05/08
06/06-05/08
03/06-
06/06-
06/06-
05/09-

2256003

Articulation AR G

OE 1K0199231J

Left rear bush



2

1.4 TSi
1.6 FSi
2.0 FSi
2.0 TFSi
2.0 TDi
3.2 FSi
3.6 FSi

06/06-05/08
03/06-05/08
03/06-
06/06-
06/06-
05/09-

2256002

Articulation AR D

OE 1K0199232J

Right rear bush



2

1.4 TSi
1.6 FSi
2.0 FSi
2.0 TFSi
2.0 TDi
3.2 FSi
3.6 FSi

06/06-05/08
03/06-05/08
03/06-
06/06-
06/06-
05/09-

Bras & Triangle de suspension

Control arm
Brazo y triángulo
Wahacz
Рычаг подвески

G/L D/R

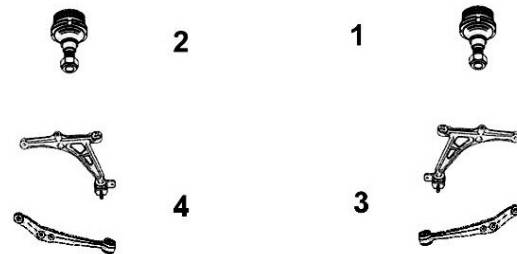

7476018

Triangle de susp. G

OE 1K0407151AC

Left track control arm



4 Fonte Iron Sans rotule Without tie rod end

1.4 TSi
1.6 FSi
2.0 FSi
2.0 TFSi
2.0 TDi
3.2 FSi
3.6 FSi

10/07-
06/06-10/07
04/06-07/08
04/06-
04/06-
12/06-
04/09-

7476017

Triangle de susp. D

OE 1K0407152AC

Right track control arm



3 Fonte Iron Sans rotule Without tie rod end

1.4 TSi
1.6 FSi
2.0 FSi
2.0 TFSi
2.0 TDi
3.2 FSi
3.6 FSi

10/07-
06/06-10/07
04/06-07/08
04/06-
04/06-
12/06-
04/09-

7476128

Triangle de susp. G

OE 1K0407151AC+1K0407365C *Left track control arm*

NEW



4 Avec rotule With ball joint

1.4 TSi
1.6 FSi
2.0 FSi
2.0 TFSi
2.0 TDi
3.2 FSi
3.6 FSi

10/07-
06/06-10/07
04/06-07/08
04/06-
04/06-
12/06-
04/09-

7476127

Triangle de susp. D

OE 1K0407152M+1K0407366C *Right track control arm*

NEW



3 Avec rotule With ball joint

1.4 TSi
1.6 FSi
2.0 FSi
2.0 TFSi
2.0 TDi
3.2 FSi
3.6 FSi

10/07-
06/06-10/07
04/06-07/08
04/06-
04/06-
12/06-
04/09-

... Eos ...

Bras & Triangle de suspension

Control arm
Brazo y triángulo
Wahacz
Рычаг подвески

G/L D/R



9005570

Rotule de susp. inf. G

OE 1K0407365C

Left lower suspension ball joint



2

1.4 TSi	10/07-
1.6 FSi	06/06-10/07
2.0 FSi	04/06-07/08
2.0 TFSi	04/06-
2.0 TDi	04/06-
3.2 FSi	12/06-
3.6 FSi	04/06-

9005569

Rotule de susp. inf. D

OE 1K0407366C

Right lower suspension ball joint



1

1.4 TSi	10/07-
1.6 FSi	06/06-10/07
2.0 FSi	04/06-07/08
2.0 TFSi	04/06-
2.0 TDi	04/06-
3.2 FSi	12/06-
3.6 FSi	04/06-



Support d'amortisseur

Suspension mounting
Soporte amortiguador
Poduszka amortyzatora
Опора амортизатора

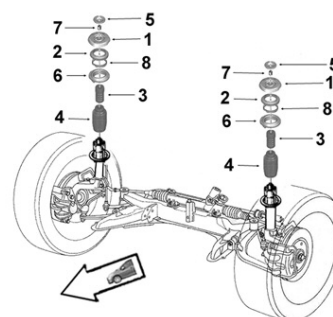

9005622

Support suspension G/D

OE 1K0412331B

L/R suspension mounting



1

1.4 TSi	11/07-
1.6 FSi	06/06-05/08
2.0 FSi	03/06-05/08
2.0 TFSi	03/06-
2.0 TDi	06/06-05/08
3.2 FSi	06/06-
3.6 FSi	04/09-

9005334

Butée de suspension

OE 1K0412303F

Shock bush



3

H55
Châssis sport

1.4 TSi	01/11-
1.6 FSi	06/06-05/08
2.0 FSi	03/06-05/08
2.0 TFSi	03/06-
2.0 TDi	06/06-
3.2 FSi	06/06-

2656004

Butée de suspension

OE 1K0412303E

Shock bush



3

H55
Susp. pilotées

1.4 TSi	01/11-
2.0 TSi	01/11-
2.0 TDi	01/11-

2656052

Butée de suspension

OE 1K0412303B

Shock bush



3

H70

1.4 TSi	10/07-
1.6 FSi	06/06-10/07
2.0 FSi	04/06-07/08
2.0 TFSi	04/06-01/11
2.0 TSi	01/11-
2.0 TDi	04/06-
3.2 FSi	12/06-01/11
3.6 FSi	04/09-01/11

2656053

Protecteur amortisseur G/D

OE 6N0413175A

L/R shock absorber protector



4

H206

1.4 TSi	10/07-
1.6 FSi	06/06-10/07
2.0 FSi	04/06-07/08
2.0 TFSi	04/06-01/11
2.0 TSi	01/11-
2.0 TDi	04/06-
3.2 FSi	12/06-01/11
3.6 FSi	04/09-01/11

... Eos



Barre stabilisatrice
Stabilizer bar
Barra estabilizadora
Drażek stabilizatora
 стабилизатор поперечной устойчивости

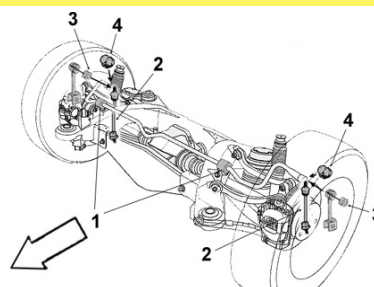

9005094 **Biellette barre stab.**
 OE 1K0505465K *Stabilizer bar stub axle*



2

1.4 TSi	11/07-
1.6 FSi	06/06-05/08
2.0 FSi	03/06-05/08
2.0 TFSi	03/06-
2.0 TDi	06/06-
3.2 FSi	06/06-
3.6 FSi	05/09-

2306013 **Palier de barre milieu**
 OE 1K0511327AQ *Middle bar main bearing*



1 Barre Ø 19.6

1.4 TSi	01/11-
2.0 TSi	01/11-
2.0 TDi	01/11-

9001737 **Palier de barre milieu**
 OE 1K0511327AR *Middle bar main bearing*



1 Barre Ø 20.7

1.4 TSi	11/07-
1.6 FSi	06/06-05/08
2.0 FSi	03/06-
2.0 TFSi	03/06-
2.0 TDi	06/06-
3.2 FSi	06/06-
3.6 FSi	05/09-

2306014 **Palier de barre milieu**
 OE 1K0511327AS *Middle bar main bearing*



1 Barre Ø 21.7

1.4 TSi	11/07-
1.6 FSi	06/06-05/08
2.0 FSi	03/06-
2.0 TFSi	03/06-
2.0 TDi	06/06-
3.2 FSi	06/06-
3.6 FSi	05/09-



Support d'amortisseur
Suspension mounting
Soporte amortiguador
Poduszka amortyzatora
 Опора амортизатора

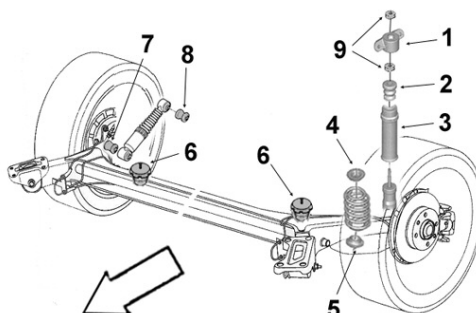

2656049 **Butée de suspension**
 OE 1K0511353M *Shock bush*



2 H 133

1.4 TSi	10/07-
1.6 FSi	06/07-10/07
2.0 FSi	04/06-07/08
2.0 TSI TFSi	04/06-
2.0 TDi	04/06-
3.2 FSi	12/06-01/11
3.6 FSi	04/09-01/11

Golf I 76-83 ...



VOLKSWAGEN

Eléments DIRECTION
Steering parts
Elementos Direcciones
Elementy układ kierowniczy
Элементы рулевой системы

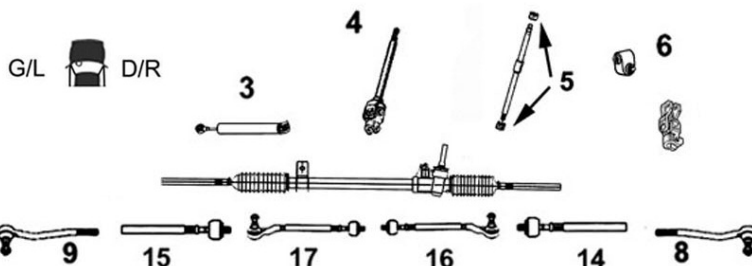

9006209

Axe de bielle G/D

OE 171419821

L/R axial joint



- 14 Côté dir. M22x1.5
- 15 Côté rot. M14x1.5 long 342 mm

TT /all models DNA 08/74-10/83

9006383

Rotule de direction G/D

OE 3A0422811A

L/R tie rod end



- 8 M14 x 1.5
- 9

TT /all models 08/74-10/83



Barre stabilisatrice
Stabilizer bar
Barra estabilizadora
Drażek stabilizatora
стабилизатор поперечной устойчивости

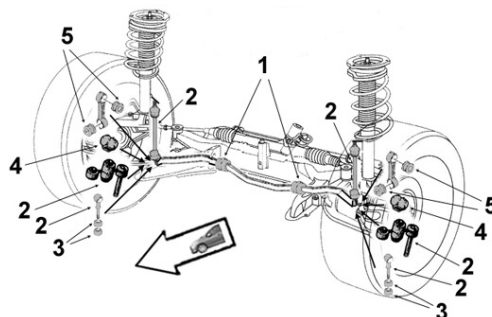

9001698

Palier de barre bout

OE 171411314A

End bar main bearing



4

- 1.6
- 1.8

9001699

Palier de barre milieu

OE 171411313

Middle bar main bearing



1

- 1.6
- 1.8



Eléments SUSPENSION
Suspension parts
Elementos suspensión
Elementy zawieszenie
Элементы подвески

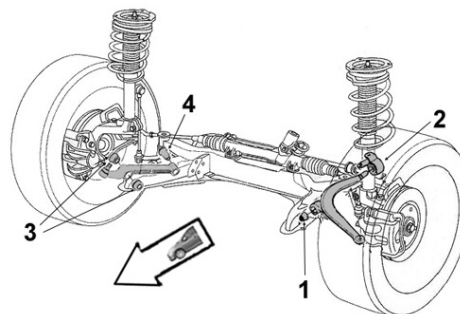

9001694

Articulation AV

OE 171407182D

Front bush



- 1 Ø int.12 Ø ext.33 coll.35 x2
long. tube int.61 ext.30 ep. coll.5.5

- 1.1
- 1.3
- 1.5
- 1.5 D
- 1.6 /GTi
- 1.6 D TD
- 1.8 GTi

9001693

Articulation AR

OE 171407181A

Rear bush



2

- 1.1
- 1.3
- 1.5
- 1.5 D
- 1.6/GTi
- 1.6 D TD
- 1.8 GTi

... Golf I 76-83 ...

Bras & Triangle de suspension

Control arm
Brazo y triángulo
Wahacz
Рычаг подвески

G/L  D/R

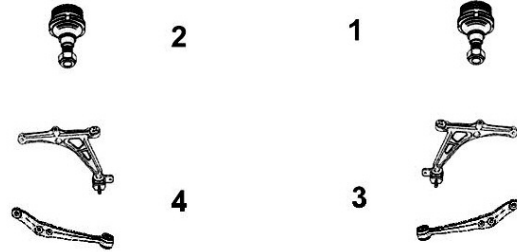

9005139

Triangle de susp. G/D

OE 171407153D

L/R track control arm



3 Sans rotule Without tie rod end
4

TT /all models

08/74-10/83

7476102

Triangle de susp. G

OE 171407153D+171407365G Left track control arm

NEW



4 Avec rotule With ball joint Ø 17

TT /all models Ch- 1783173584
10/77-10/83

7476103

Triangle de susp. D

OE 171407153D+171407365G Right track control arm

NEW



3 Avec rotule With ball joint Ø 17

TT /all models Ch- 1783173584
10/77-10/83

9005262

Rotule de susp. inf. G/D

OE 171407365G

L/R lower suspension ball joint



1 Ø 17
2

TT /all models

Ch- 1783173584

10/77-10/83



Support d'amortisseur

Suspension mounting
Soporte amortiguador
Poduszka amortyzatora
Опора амортизатора

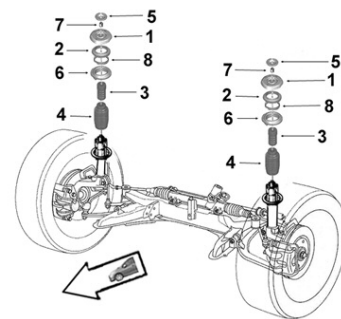

9001707

Support suspension G/D

OE 171412329A

L/R suspension mounting



1 Avec roulement With bearing

1.1
1.3
1.5
1.5 D
1.6
1.6 GTi
1.6 D TD
1.8 GTi

9005362

Butée de suspension G/D

OE 357412303E

L/R suspension bush



3 H84

1.1
1.3
1.5
1.5 D
1.6
1.6 GTi
1.6 D TD
1.8 GTi

Golf II 83-91 ...

SASIC

VOLKSWAGEN

Eléments DIRECTION
Steering parts
Elementos Direcciones
Elementy układ kierowniczy
Элементы рулевой системы

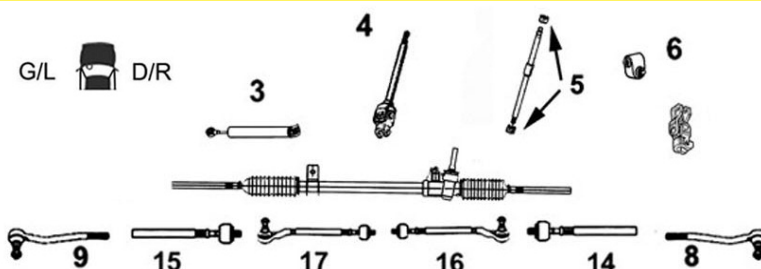

9006210 Axe de bielle G/D

Part/oe 191419803 L/R axial joint



14 Côté dir. M22x1.5
 15 Côté rot. M14x1.5 long 368 mm

TT /all models DNA 08/83-10/91

9006217 Axe de bielle G/D

Part/oe 191422803A L/R axial joint



14 Côté dir. M14x1.5
 15 Côté rot. M14x1.5 long 347 mm

TT /all models DA 08/83-10/91

9006380 Rotule de direction G

OE 191419811 Left tie rod end



9 M14 x 1.5

TT /all models 08/83-10/91

9006381 Rotule de direction D

OE 191419812 Right tie rod end



8 M14 x 1.5

TT /all models 08/83-10/91



Barre stabilisatrice
Stabilizer bar
Barra estabilizadora
Drażek stabilizatora
стабилизатор поперечной устойчивости

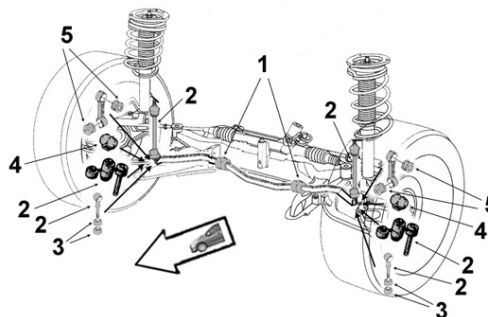

9005050 Biellette barre stab.

OE 191411315B Stabilizer bar stub axle



2 Ø int.17
 1.3
 1.6
 1.6 D
 1.6 TD
 1.8
 1.8 G60
 1.8 GTi /16v.

9001522 Palier de barre milieu

OE 191411314 Middle bar main bearing



1 Barre Ø 17
 1.3
 1.6
 1.6 D
 1.6 TD
 1.8
 1.8 GTi
 1.8 GTi 16v.
 1.8 G60

... Golf II 83-91 ...



Eléments SUSPENSION

Suspension parts

Elementos suspensión



Elementy zawieszenie

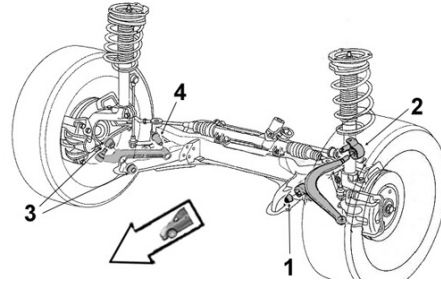





Элементы подвески





VOLKSWAGEN





9001523 OE 357407182	Articulation AV <i>Front bush</i>	9001520 OE 191407181D	Articulation AR <i>Rear bush</i>
	1 Ø int.12 Ø ext.33 coll.36 long. tube int.54 ext.29 ep. coll.5 1.3 1.6 1.6 D 1.6 TD 1.8 1.8 G60 1.8 GTi /16v.		2 Ø int.17 Ø ext.60.5 long. tube int.41 ext.24.5 1.3 1.6 1.6 D 1.6 TD 1.8 1.8 GTi /16v. 1.8 G60

Bras & Triangle de suspension <i>Control arm</i> <i>Brazo y triángulo</i> <i>Wahacz</i> Рычаг подвески	G/L  D/R	 2	 1
		 4	 3
			

9005133 OE 191407151B	Triangle de susp. G/D <i>L/R track control arm</i>	3 4	Sans rotule <i>Without tie rod end</i>
	TT /all models		08/83-10/91

7476107 OE 191407151B+357407365	Triangle de susp. G <i>Left track control arm</i>	7476108 OE 191407151B+357407365	Triangle de susp. D <i>Right track control arm</i>
	4 Avec rotule <i>With ball joint</i> Ø 19 TT /all models 08/87-10/91		3 Avec rotule <i>With ball joint</i> Ø 19 TT /all models 08/87-10/91

9005261 OE 191407365	Rotule de susp. inf. G/D <i>L/R lower suspension ball joint</i>	9005260 OE 357407365	Rotule de susp. inf. G/D <i>L/R lower suspension ball joint</i>
	1 Ø 17 2 TT /all models 08/83-07/87		1 Ø 19 <i>Cylindrique</i> 2 TT /all models 08/87-10/91

... Golf II 83-91 ...



VOLKSWAGEN

Bras & Triangle de suspension

Control arm
Brazo y triángulo
Wahacz
Рычаг подвески

G/L D/R



9155490

Kit rép. train AV

OE -

Front axle repair kit

Sans visserie Without screws and bolts
Barre Ø 17



TT /all models

08/83-10/91



Support d'amortisseur

Suspension mounting
Soporte amortiguador
Poduszka amortyzatora
Опора амортизатора

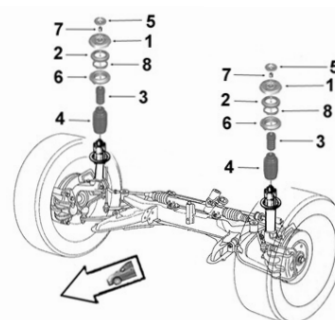

9005604

Support suspension AV G/D

OE 191412329

L/R front susp. mounting

1 Avec roulement With bearing



1.3
1.6
1.6 D
1.6 TD
1.8
1.8 GTi /16v.
1.8 G60

9005362

Butée de suspension G/D

OE 357412303E

L/R suspension bush

3 H84



1.3
1.6
1.6 D
1.6 TD
1.8
1.8 GTi /16v.
1.8 G60



Support d'amortisseur

Suspension mounting
Soporte amortiguador
Poduszka amortyzatora
Опора амортизатора

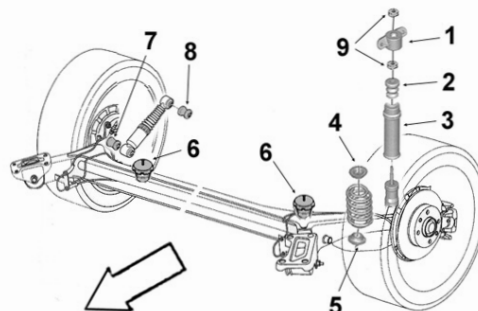

9005361

Butée de suspension AR G/D

OE 191512131B

L/R rear suspension bush

2 H146



1.3 -10/91
1.6 -10/91
1.6 D -10/91
1.6 TD -10/91
1.8 -10/91
1.8 GTi /16v. -10/91
1.8 G60 -10/91

9005368

Protecteur amortisseur G/D

OE 191513425

L/R shock absorber protector

3 H90



1.3
1.6
1.6 D
1.6 TD
1.8
1.8 GTi /16v.
1.8 G60

... Golf II 83-91

Eléments TRAIN ARRIERE

Rear axle parts
Tren TRAS
Elementy zawieszenia tylnego
элементы задней оси.



9001704

OE 191501541

Articulation essieu AR G/D

L/R Rear axle bush



Ø int.12 Ø ext.44.5 coll.72
long. tube int.90 ext.58 ep. coll.2.5
1.3 -10/91
1.6 -10/91
1.6 D TD -10/91
1.8 -10/91
1.8 GTi /16v. / G60 -10/91

Golf III 91-97 ...

Eléments DIRECTION

Steering parts
Elementos Direcciones
Elementy uklad kierowniczy
Элементы рулевой системы

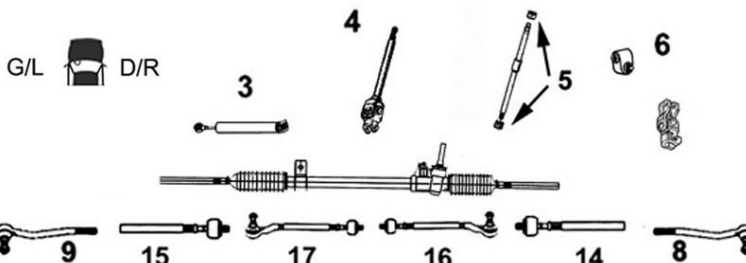

9006211

Axe de bielle G/D

Part/oe 1H0419803 L/R axial joint



14 Côté dir. M22x1.5 Côté rot. M14x1.5 long 394 mm
15

TT /all models DNA

11/91-10/97

9006212

Axe de bielle G/D

OE 191422821C L/R axial joint



14 Côté dir. M14x1.5 Côté rot. M14x1.5 long 359 mm
15

TT /all models DA ZF

11/91-10/97

9006218

Axe de bielle G/D

Part/oe 1H0422803 L/R axial joint



14 Côté dir. M14x1.5 Côté rot. M14x1.5 long 371 mm
15 DA TRW

2.0 GTi 16v.
2.8 VR6

11/91-10/97
11/91-10/97

9006380

Rotule de direction G

OE 191419811

Left tie rod end



9 M14x1.5

TT /all models DNA DA 11/91-10/97

9006381

Rotule de direction D

OE 191419812

Right tie rod end



8 M14x1.5

TT /all models DNA DA 11/91-10/97

... Golf III 91-97 ...



VOLKSWAGEN



Barre stabilisatrice
 Stabilizer bar
 Barra estabilizadora
 Drążek stabilizatora
 стабилизатор поперечной устойчивости

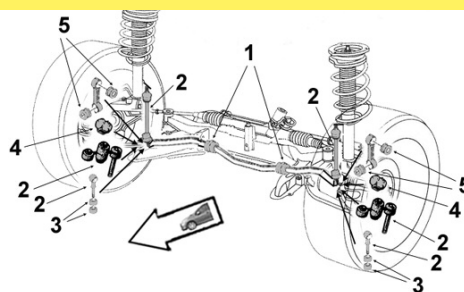

9005050 **Biellette barre stab.**
 OE 191411315B *Stabilizer bar stub axle*



2 Ø int.17
 1.4i
 1.6 /i
 1.8 /SW/ 4WD
 1.9 D /SW
 1.9 SDi /SW
 1.9 TD
 1.9 TDi /SW
 2.0
 2.8 VR6

9001522 **Palier de barre milieu**
 OE 191411314 *Middle bar main bearing*



1 Barre Ø 17
 1.4i
 1.6 /i
 1.8
 1.9 D
 1.9 SDi
 1.9 TD TDi
 2.0
 2.0i 16v.
 2.8 VR6

9001760 **Palier de barre milieu**
 OE 1H0411314 *Middle bar main bearing*

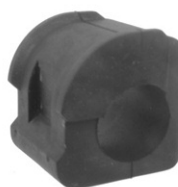

1 Barre Ø 20
 2.0 /GTi
 01/97-12/97



Eléments SUSPENSION
 Suspension parts
 Elementos suspensión
 Elementy zawieszenie
 Элементы подвески

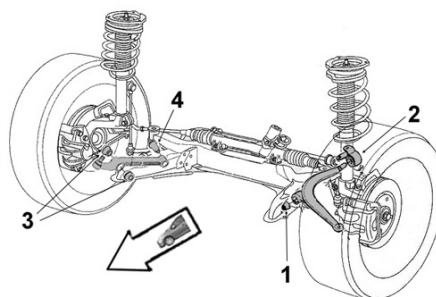

9001523 **Articulation AV**
 OE 357407182 *Front bush*



1 Ø int.12 Ø ext.33 coll.36 long. tube int.54 ext.29 ep. coll.5
 1.4i
 1.6 /i
 1.8
 1.9 SDi
 1.9 TD TDi
 2.0/i 16v.
 2.8 VR6

9001520 **Articulation AR**
 OE 191407181D *Rear bush*



2 Ø int.17 Ø ext.60.5 long. tube int.41 ext.24.5
 1.4i
 1.6 /i
 1.8
 1.9 D
 1.9 SDi
 1.9 TD TDi
 2.0/i 16v.
 2.8 VR6

... Golf III 91-97 ...

Bras & Triangle de suspension

Control arm
Brazo y triángulo
Wahacz
Рычаг подвески

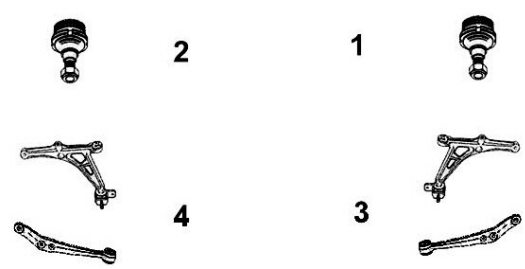

9005134

OE 1H0407151

Triangle de susp. G/D

L/R track control arm



3 Sans rotule Without tie rod end

TT /all models

Sauf GTi /16v. VR6

Sauf TDi 110hp 81kw 5 trous jante 15 pouces

11/91-10/97

7476109

OE 1H0407151+357407365

Triangle de susp. G

Left track control arm



NEW

4 Avec rotule With ball joint Ø 19

TT /all models 11/91-10/97

Sauf GTi /16v. VR6

Sauf TDi 110hp 81kw 5 trous jante 15 pouces

7476110

OE 1H0407151+357407365

Triangle de susp. D

Right track control arm



NEW

3 Avec rotule With ball joint Ø 19

TT /all models 11/91-10/97

Sauf GTi /16v. VR6

Sauf TDi 110hp 81kw 5 trous jante 15 pouces

9005753

OE 1H0407151A

Triangle de susp. G

Left track control arm



4 Sans rotule Without tie rod end

1.9 TDi 110hp 81kw 5 cyl. 11/91-10/97

2.0 /GTi 11/91-

2.0 GTi 16v. 11/91-10/97

2.8 VR6 11/91-10/97

2.9 VR6 10/94-

9005754

OE 1H0407152

Triangle de susp. D

Right track control arm



3 Sans rotule Without tie rod end

1.9 TDi 110hp 81kw 5 cyl. 11/91-10/97

2.0 /GTi 11/91-

2.0 GTi 16v. 11/91-10/97

2.8 VR6 11/91-10/97

2.9 VR6 10/94-

7476117

OE 1H0407151A+1H0407365

Triangle de susp. G

Left track control arm



NEW

4 Avec rotule With ball joint

1.9 TDi 110hp 81kw 5 cyl. 11/91-10/97

2.0 /GTi 11/91-

2.0 GTi 16v. 11/91-10/97

2.8 VR6 11/91-10/97

2.9 VR6 10/94-

7476115

OE 1H0407152+1H0407365

Triangle de susp. D

Right track control arm



NEW

4 Avec rotule With ball joint

1.9 TDi 110hp 81kw 5 cyl. 11/91-10/97

2.0 /GTi 11/91-

2.0 GTi 16v. 11/91-10/97

2.8 VR6 11/91-10/97

2.9 VR6 10/94-

9005260

OE 357407365

Rotule de susp. inf. G/D

L/R lower suspension ball joint

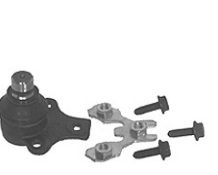

1 Ø 19 Cylindrique

TT /all models 11/91-10/97

Sauf GTi /16v. VR6

Sauf TDi 110hp 81kw 5 trous jante 15 pouces

9005268

OE 1H0407365

Rotule de susp. inf. G/D

L/R lower suspension ball joint



1 Cône Ø 16.8 - Ø 18

1.9 TDi 110hp 81kw 5 cyl. 11/91-10/97

2.0 /GTi 11/91-

2.0 GTi 16v. 11/91-10/97

2.8 VR6 11/91-10/97

2.9 VR6 10/94-

... Golf III 91-97 ...



VOLKSWAGEN

Bras & Triangle de suspension

Control arm
Brazo y triángulo
Wahacz
Рычаг подвески

G/L D/R



9155490

Kit rép. train AV

OE -

Front axle repair kit

Sans visserie Without screws and bolts
Barre Ø 17



TT /all models

11/91-10/97



Support d'amortisseur

Suspension mounting
Soporte amortiguador
Poduszka amortyzatora
Опора амортизатора

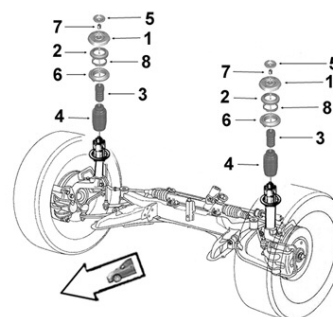

9005604

Support suspension AV G/D

OE 191412329

L/R front susp. mounting

1 Avec roulement With bearing



1.4i	-ch 1H-SW062538
1.6 /i	ABU AEA AEE
1.8	-ch 1H-SW062538
1.9 SDi	-ch 1H-SB019475
	-1H-SW062538
1.9 TDi	-ch 1H-SB019475
	-1H-SW062538

9001709

Support suspension G/D

OE 357412331A

L/R suspension mounting

1



1.4i	Ch- 1H-SW062539
1.6 /i	AEK AFT AKS
1.8/4WD/SW	Ch- 1H-SW062539
1.9 D /SW	Ch- 1H-SW062539
1.9 TDi	AFN
2.0i /SW	Ch-1H-SW062539
2.9i /SW	

9001708

Support suspension G/D

OE 357412329

L/R suspension mounting

1 Avec roulement With bearing



1.9 TD	-08/94
1.9 TDi	Except. AFN -08/94
2.0 /GTi	-08/94

9005352

Butée à billes G/D

OE 1J0412249

L/R ball bearing

2



1.4i		01/92-
1.6 /i		01/94-12/97
1.8	ABS	
1.8		01/92-
1.9 D		
1.9 SDi TD TDi		01/92-
2.0 /GTi /i 16v.		01/92-
2.8 VR6		01/92-

9005362

Butée de suspension G/D

OE 357412303E

L/R suspension bush

3 H84



1.4i	-09/94
1.6 /i	-09/94
1.8	-09/94
2.0	-09/94

9005338

Butée de suspension

OE 1H0412303B

Shock bush

3 H64



Ch-1H-SW062539

1.8 /4WD
1.9 D
1.9 SDi
1.9 TDi

... Golf III 91-97

9005363 Butée de suspension G/D
OE 357412303F L/R suspension bush



3 H83

2.0i
2.9 VR6

9005327 Protecteur amortisseur G/D
OE 357413175A L/R shock absorber protector



4 H221.5
1.4i
1.6 /i
1.8 /4WD /SW
1.9 D / SDi /TDi /SW
1.9 TD
2.0 /SW /i 16v.
2.8 VR6
2.9 VR6



Support d'amortisseur
Suspension mounting
Soporte amortiguador
Poduszka amortyzatora
Опора амортизатора

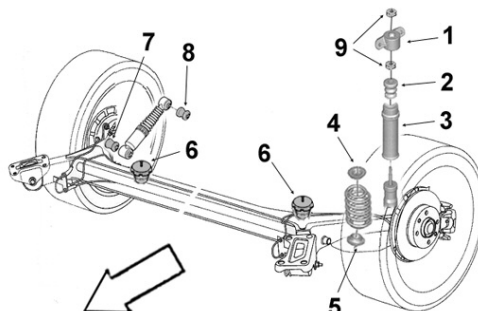

9005361 Butée de suspension AR G/D
OE 191512131B L/R rear suspension bush



2 H146
1.4i
1.6 /i
1.8 /4WD
1.9 D
1.9 SDi
1.9 TD TDi
2.0/i 16v.
2.8 VR6

9005368 Protecteur amortisseur G/D
OE 191513425 L/R shock absorber protector



3 H90
1.4i
1.6 /i
1.8
1.9 D
1.9 SDi
1.9 TD TDi
2.0/i 16v.
2.8 VR6

Eléments TRAIN ARRIERE
Rear axle parts
Tren TRAS
Elementy zawieszenia tylnego
элементы задней оси.



9001705 Articulation essieu AR G/D
OE 1H0501541A L/R Rear axle bush



Ø int.12 Ø ext.56.5 coll.74 long. tube int.90 ext.51 ep. coll.3

1.4i
1.6 /i
1.8
1.9 D SDi
1.9 TD TDi
2.0 /i 16v.
2.8 VR6

Golf IV 97-03 ...



VOLKSWAGEN

Eléments DIRECTION
Steering parts
Elementos Direcciones
Elementy układ kierowniczy
Элементы рулевой системы

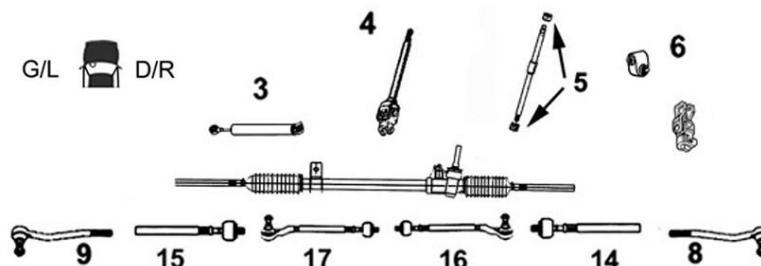

9006213 Axe de bielle G/D

Part/oe 1J0422807A L/R axial joint



14 Côté dir. M16x1.5 Côté rot. M14x1.5 long 338 mm

15

1.4i 16v. /SW	-ch 1JWW085662			
1.4i 16v.	-ch 1JWP050833	-ch 1JWD039151	-ch 1JWB062360	
1.6i /SW	-ch 1JWW085662			
1.6i	-ch 1JWP050833	-ch 1JWD039151	-ch 1JWB062360	
1.6i 16v.	-ch 1JWW085662			-05/04
1.6i 16v.	-ch 1JWP050833	-ch 1JWD039151	-ch 1JWB062360	-05/04
1.8i 20v. Turbo /GTi	-ch 1JWW085662			
1.8i 20v. Turbo /GTi	-ch 1JWP050833	-ch 1JWD039151	-ch 1JWB062360	
1.9 SDi /SW	-ch 1JWW085662			
1.9 SDi	-ch 1JWP050833	-ch 1JWD039151	-ch 1JWB062360	
1.9 TDi /SW	-ch 1JWW085662			
1.9 TDi	-ch 1JWP050833	-ch 1JWD039151	-ch 1JWB062360	
2.3i VR5 20v. /4WD	-ch 1JWW085662			
2.3i VR5 20v.	-ch 1JWP050833	-ch 1JWD039151	-ch 1JWB062360	

9006219 Axe de bielle G/D

Part/oe 1J0422803H L/R axial joint



14 Côté dir. M16x1.5 Côté rot. M14x1.5 long 320 mm

15

1.4i 16v.	Ch- 1JWW085662	Ch- 1JWP050833	Ch- 1JWD039151	Ch- 1JWB062360
1.4i 16v. SW				
1.6i	Ch- 1JWW085662	Ch- 1JWP050833	Ch- 1JWD039151	Ch- 1JWB062360
1.6i SW	Ch- 1JWB062360			
1.6i 16v.	Ch- 1JWP050833	Ch- J-WD039150	Ch- 1J-WB027484	Ch- 1J-WW062359
1.6i 16v. SW	Ch- 1J-WW062359			
1.8i 20v. Turbo	Ch- 1JWW085662	Ch- 1JWP050833	Ch- 1JWD039151	Ch- 1JWB062360
1.9 SDi	Ch- 1JWW085662	Ch- 1JWP050833	Ch- 1JWD039151	Ch- 1JWB062360
1.9 SDi SW	Ch- 1JWB062360			
1.9 TDi	Ch- 1JWW085662	Ch- 1JWP050833	Ch- 1JWD039151	Ch- 1JWB062360
1.9 TDi	Ch- 01JWP050833	Ch- 1J-WD039151		
1.9 TDi 4WD /SW 4WD				
1.9 TDi	Ch- 1J-WB027485	Ch- 1JWB062360		
2.3i VR5 20v. /4WD	Ch- 1JWW085662	Ch- 1JWP050833	Ch- 1JWD039151	Ch- 1JWB062360
2.3i VR5 20v. 4WD / 4WD SW	Ch- 1JWB062360			

9006385 Rotule de direction G

OE 1J0422811A Left tie rod end



9 M14 x 1.5

1.4i 16v.	-ch 1JWW085662	-ch 1JWP050833	-ch 1JWD039151	-ch 1JWB062360
1.6i	-ch 1JWW085662	-ch 1JWP050833	-ch 1JWD039151	-ch 1JWB062360
1.6i 16v.	-ch 1JWP050833	-ch 1JWD039150	-ch 1JWB027484	-ch 1JWW062359
1.8i 20v. Turbo	-ch 1JWW085662	-ch 1JWP050833	-ch 1JWD039151	-ch 1JWB062360
1.9 SDi	-ch 1JWW085662	-ch 1JWP050833	-ch 1JWD039151	-ch 1JWB062360
1.9 TDi /4WD	-ch 1JWW085662	-ch 1JWP050833	-ch 1JWD039151	-ch 1JWB062360
2.3i VR5 20v. /4WD	-ch 1JWW085662	-ch 1JWP050833	-ch 1JWD039151	-ch 1JWB062360

... Golf IV 97-03 ...



9006384

Rotule de direction D

OE 1J0422812A

Right tie rod end



8 M14 x 1.5

1.4i 16v.	-ch 1JWW085662	-ch 1JWP050833	-ch 1JWD039151	-ch 1JWB062360
1.6i	-ch 1JWW085662	-ch 1JWP050833	-ch 1JWD039151	-ch 1JWB062360
1.6i 16v.	-ch 1JWP050832	-ch 1JWD039150	-ch 1JWB027484	-ch 1JWW062359
1.8i 20v. Turbo	-ch 1JWW085662	-ch 1JWP050833	-ch 1JWD039151	-ch 1JWB062360
1.9 SDi	-ch 1JWW085662	-ch 1JWP050833	-ch 1JWD039151	-ch 1JWB062360
1.9 TDi /4WD	-ch 1JWW085662	-ch 1JWP050833	-ch 1JWD039151	-ch 1JWB062360
2.3i VR5 20v. /4WD	-ch 1JWW085662	-ch 1JWP050833	-ch 1JWD039151	-ch 1JWB062360

9006634

Rotule de direction G

OE 1J0422812B

Left tie rod end



9 M14 x 1.5

Dir. TRW

1.4i 16v.	Ch- 1JWW085662	Ch- 1JWP050833	Ch- 1JWD039151	Ch- 1JWB062360
1.4i 16v. SW				
1.6i	Ch- 1JWW085662	Ch- 1JWP050833	Ch- 1JWD039151	Ch- 1JWB062360
1.6i 16v.	Ch- 1JWW085662			-05/04
1.6i SW				
1.6i 16v.	Ch- 1JWD039151	Ch- 1JWB027485	Ch- 1JWW062360	-05/04
1.6i 16v. SW				
1.8i 20v. Turbo	Ch- 1JWW085662	Ch- 1JWP050833	Ch- 1JWD039151	Ch- 1JWB062360
1.9 SDi	Ch- 1JWW085662	Ch- 1JWP050833	Ch- 1JWD039151	Ch- 1JWB062360
1.9 SDi SW				
1.9 TDi 90hp 66kw 110hp 81kw	Ch- 1JWW085662	Ch- 1JWP050833	Ch- 1JWD039151	Ch- 1JWB062360
1.9 TDi 100hp 74kw 115hp 85kw 130hp 96kw /4WD 150hp 110kw /4WD				
1.9 TDi 4WD / SW				
2.3i VR5 20v. /4WD	Ch- 1JWW085662	Ch- 1JWP050833	Ch- 1JWD039151	Ch- 1JWB062360

9006635

Rotule de direction D

OE 1J0422811B

Right tie rod end



8 M14 x 1.5

Dir. TRW

1.4i 16v.	Ch- 1JWW085662	Ch- 1JWP050833	Ch- 1JWD039151	Ch- 1JWB062360
1.4i 16v. SW				
1.6i	Ch- 1JWW085662	Ch- 1JWP050833	Ch- 1JWD039151	Ch- 1JWB062360
1.6i 16v.	Ch- 1JWW085662			-05/04
1.6i SW				
1.6i 16v.	Ch- 1JWD039151	Ch- 1JWB027485	Ch- 1JWW062360	-05/04
1.6i 16v. SW				
1.8i 20v. Turbo	Ch- 1JWW085662	Ch- 1JWP050833	Ch- 1JWD039151	Ch- 1JWB062360
1.9 SDi	Ch- 1JWW085662	Ch- 1JWP050833	Ch- 1JWD039151	Ch- 1JWB062360
1.9 SDi SW				
1.9 TDi 90hp 66kw 110hp 81kw	Ch- 1JWW085662	Ch- 1JWP050833	Ch- 1JWD039151	Ch- 1JWB062360
1.9 TDi 100hp 74kw 115hp 85kw 130hp 96kw /4WD 150hp 110kw /4WD				
1.9 TDi 4WD / SW				
2.3i VR5 20v. /4WD	Ch- 1JWW085662	Ch- 1JWP050833	Ch- 1JWD039151	Ch- 1JWB062360

... Golf IV 97-03...



VOLKSWAGEN



Barre stabilisatrice
 Stabilizer bar
 Barra estabilizadora
 Drażek stabilizatora
 стабилизатор поперечной устойчивости

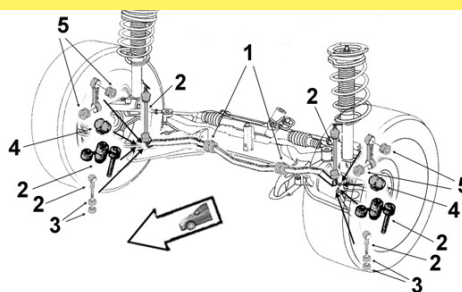

9005084 OE 1J0411315J	Biellette barre stab. <i>Stabilizer bar stub axle</i>	9005090 OE 1J0411315G	Biellette barre stab. <i>Stabilizer bar stub axle</i>
	2 Barre Ø 21 1.4i 16v. 01/98- 1.6i 01/98- 1.6i 16v. 10/00- 1.8 GTi 20v. Turbo 01/98- 1.8i 20v. Turbo 01/98- 1.9 SDi 01/98- 1.9 TDi 01/98- 2.3i VR5 20v. 01/98-		2 Barre Ø 23 -ch 1J-1-480000 1.4i 16v. Sport /SW 01/98- 1.6i 16v. Sport /SW 10/00- 1.6i Sport /SW 01/98- 1.8 GTi 20v. Turbo Sport 01/98- 1.8i 20v. Turbo Sport 01/98- 1.9 SDi Sport /SW 08/98- 1.9 TDi Sport/SW/4WD 01/98- 2.3i VR5 20v. Sport 02/98-
9005093 OE 1J0411315K	Biellette barre stab. <i>Stabilizer bar stub axle</i>	2306007 OE 1J0411315D	Biellette barre stab. G <i>Left stabilizer bar stub axle</i>
	2 Barre Ø 23 Ch- 1J-1-480001 1.4i 16v. Sport /SW 1.6i 16v. Sport /SW 1.6i Sport /SW 1.8 GTi 20v. Turbo Sport 1.8i 20v. Turbo Sport 1.9 SDi TDi Sport /SW 2.3i VR5 20v. Sport		2 1.9 TDi 4WD 100hp 74kw Ch- 1J-1-480001 BVM 11/01-05/04 1.9 TDi 4WD 115hp 90kw 09/99-11/01 1.9 TDi 4WD 130hp 96kw 150hp 110kw BVM 05/01-05/04 2.3 VR5 4WD 12/98- 2.8i V6 /24v. 4WD BVM 09/99-05/04 2.8i VR6 24v. BVM 09/99-05/04 3.2 V6 4WD
2306008 OE 1J0411316D	Biellette barre stab. D <i>Right stabilizer bar stub axle</i>	9005018 OE 1J0411327	Liaison élastique <i>Elastic link</i>
	2 1.9 TDi 4WD 100hp 74kw Ch- 1J-1-480001 BVM 11/01-05/04 1.9 TDi 4WD 115hp 90kw 09/99-11/01 1.9 TDi 4WD 130hp 96kw 150hp 110kw BVM 05/01-05/04 2.3 VR5 4WD 12/98- 2.8i V6 /24v. 4WD BVM 09/99-05/04 2.8i VR6 24v. BVM 09/99-05/04 3.2 V6 4WD		5 Ø int.14.5 ext. Ø29 coll.35 x2 long. tube int.22.5 ext.18 ep. coll.2 x2 1.4i 16v. 01/98- 1.6i 01/98- 1.6i 16v. 10/00- 1.8 GTi 20v. Turbo /20v. Turbo 01/98- 1.9 SDi TDi 01/98- 2.3i VR5 20v. 01/98- 2.8i V6 4WD 09/99-
2306134 OE 1J0411314S	Palier de barre <i>Bar main bearing</i>	9001730 OE 1J0411314R	Palier de barre milieu <i>Middle bar main bearing</i>
	1 Ø 17 1.8i 4WD /Break 05/98-05/04 1.9 TDi 4WD /Break 06/99-12/05 2.0i GTi 4WD /Break 03/00-12/05 2.3i VR5 4WD /Break 05/99-12/05 2.8 V6 4WD /Break 09/99-12/05		1 Barre Ø 21 -ch 1J-X-800000 1.4i 16v. /SW 1.6i /SW/16v. /SW 1.8i 20v. Turbo/GTi 20v. Turbo 1.9 SDi /SW 1.9 TDi /SW /4WD 2.3i VR5 20v. /4WD
9001732 OE 1J0411314T	Palier de barre milieu <i>Middle bar main bearing</i>		
	1 Barre Ø 23 Ch- 1J-Y-000001 1.4i 16v. /SW 1.6i //16v. / 1.8i 20v. Turbo/GTi 20v. Turbo 1.9 SDi /SW 1.9 TDi /SW /4WD 2.3i VR5 20v. /4WD 2.8i 09/99-05/04		

... Golf IV 97-03 ...



Eléments SUSPENSION

Suspension parts
Elementos suspensión
Elementy zawieszenie
Элементы подвески

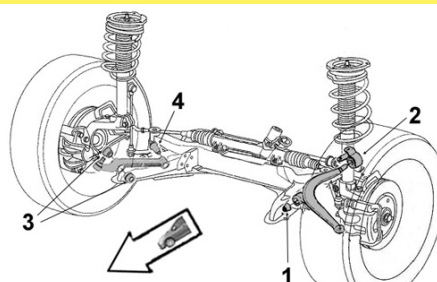

VOLKSWAGEN



9001523 OE 357407182	Articulation AV <i>Front bush</i>	9001542 OE 1J0407181	Articulation AR <i>Rear bush</i>
	1 Ø int.12 Ø ext.33 coll.36 long. tube int.54 ext.29 ep. coll.5 1.4i 16v. /SW 01/98- 1.6i /SW 01/98- 1.6i 16v. 10/00- 1.8i 20v. Turbo 01/98- 1.8 GTi 20v. Turbo 01/98- 1.9 SDi /SW 01/98- 1.9 TDi /SW /4WD 01/98- 2.3i VR5 20v. /4WD 01/98- 2.8 V6 4 motion 05/01-		2 Ø int.13 Ø ext.59.5 long. tube int.41 ext.23.5 1.4i 16v. /SW 01/98- 1.6i /SW 01/98- 1.6i 16v. 10/00- 1.8 /GTi 20v. Turbo 01/98- 1.9 SDi /SW 01/98- 1.9 TDi /SW /4WD 01/98- 2.3i VR5 20v. /4WD 01/98- 2.8 V6 09/99-

Bras & Triangle de suspension <i>Control arm</i> <i>Brazo y triángulo</i> <i>Wahacz</i> <i>Рычаг подвески</i>	G/L D/R		2		1		4		3
--	----------	--	----------	--	----------	--	----------	--	----------

9005136 OE 1J0407151C	Triangle de susp. G/D <i>L/R track control arm</i>		3 4 Sans rotule <i>Without tie rod end</i> 1.4i 16v. /SW 1.6i //16v. /SW 1.8i 20v. Turbo 1.9 SDi /SW 1.9 TDi /SW 2.3i VR5 20v. /4WD 2.8 V6
---------------------------------	--	--	---

7476118 OE 1J0407151C+1J040735H	Triangle de susp. G <i>Left track control arm</i>		4 Avec rotule <i>With ball joint</i> 1.4i 16v. /SW 1.6i 16v. /SW 1.6i /SW 1.8i 20v. Turbo 1.9 SDi /SW 1.9 TDi /SW 2.3i VR5 20v. /4WD 2.8 V6
7476119 OE 1J0407151C+1J0407366H	Triangle de susp. D <i>Right track control arm</i>		3 Avec rotule <i>With ball joint</i> 1.4i 16v. /SW 1.6i 16v. /SW 1.6i /SW 1.8i 20v. Turbo 1.9 SDi /SW 1.9 TDi /SW 2.3i VR5 20v. /4WD 2.8 V6

9005266 OE 1J0407365J	Rotule de susp. inf. G <i>Left lower suspension ball joint</i>		2 Axe Ø 18 1.4i 16v. /SW 1.6i /SW 1.6i 16v. /SW 1.8i 20v. Turbo 1.9 SDi /SW 1.9 TDi /SW 2.3i VR5 20v. /4WD 2.8 V6
9005267 OE 1J0407366J	Rotule de susp. inf. D <i>Right lower suspension ball joint</i>		1 Axe Ø 18 1.4i 16v. /SW 1.6i /SW 1.6i 16v. /SW 1.8i 20v. Turbo 1.9 SDi /SW 1.9 TDi 2.3i VR5 20v. /4WD 2.8 V6

... Golf IV 97-03 ...



VOLKSWAGEN



Support d'amortisseur
 Suspension mounting
 Soporte amortiguador
 Poduszka amortyzatora
 Опора амортизатора

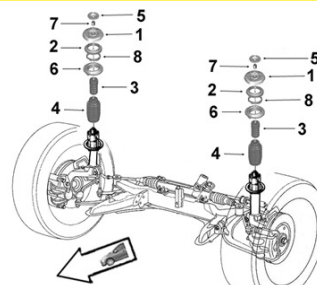

9005614

Tampon suspension AV G/D

OE 1J0412331C

L/R front suspension rebound stop



1	1.4i 16v. /SW	01/98-
	1.6i /SW	01/98-
	1.6i 16v. /SW	10/00-
	1.8 GTi 20v. Turbo	01/98-
	1.9 SDi /SW	01/98-
	1.9 TDi /SW /4WD	01/98-
	2.3i VR5 20v. /4WD	02/98-
	2.8 V6 4WD	05/01-
	3.2 V6 4WD	09/02-

9005352

Butée à billes G/D

OE 1J0412249

L/R ball bearing



2	1.4i 16v. /SW	01/98-
	1.6i /SW	01/98-
	1.6i 16v. /SW	10/00-
	1.8 GTi 20v. Turbo	01/98-
	1.8i 20v. Turbo	01/98-
	1.9 SDi /SW	01/98-
	1.9 TDi /SW /4WD	01/98-
	2.3i VR5 20v. /4WD	01/98-
	2.8 V6	09/99-
	3.2 V6 4WD	09/02-

9005338

Butée de suspension

OE 1H0412303B

Shock bush



3	H64	
	1.4i 16v. /SW	01/98-
	1.6i /SW	01/98-
	1.6i 16v. SW	10/00-
	1.8 GTi 20v. Turbo	01/98-
	1.8i 20v. Turbo	01/98-
	1.9 SDi /SW	01/98-
	1.9 TDi /SW /4WD	01/98-
	2.3i VR5 20v./4WD -ch 1J-Y-360000	01/98-
	2.8 V6 4 motion	05/01-

2656003

Butée de suspension

OE 1J0412303

Shock bush

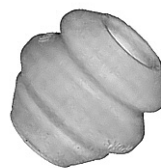

3	H53	
	1.4i 16v. Sport	01/98-05/04
	1.6i 16v. Sport	10/00-05/04
	1.6i Sport	01/98-05/04
	1.8 GTi 20v. Turbo Sport	01/98-05/04
	1.8i 20v. Turbo Sport	01/98-10/02
	1.9 SDi Sport	01/98-05/04
	1.9 TDi /4WD Sport	01/98-05/04
	2.3i VR5 20v. /4WD	02/98-05/04
	2.8i V6 24v. /4WD	09/99-05/04
	2.8i VR6 24v.	09/99-05/04

9005327

Protecteur amortisseur G/D

OE 357413175A

L/R shock absorber protector



4	H221.5	
	1.4i 16v. /SW	01/98-
	1.6i /SW	01/98-
	1.6i 16v. /SW	10/00-
	1.8 GTi 20v. Turbo	01/98-
	1.8i 20v. Turbo	01/98-
	1.9 SDi /SW	01/98-
	1.9 TDi /SW /4WD	01/98-
	2.3i VR5 20v. /4WD	01/98-
	2.8 V6 4WD	01/98-
	3.2 V6 4WD	09/02-



Barre stabilisatrice

Stabilizer bar
 Barra estabilizadora
 Drażek stabilizatora
 стабилизатор поперечной устойчивости

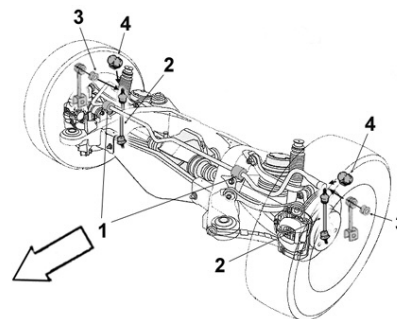

2306009

Biellette barre stab.

OE 1J0505466B

Stabilizer bar stub axle



2	1.9 TDi 4WD	BVM	07/98-05/04
	2.3 VR5 4WD		12/98-
	2.8i V6 24v. 4WD	BVM	09/99-05/04
	2.8i V6 4WD	BVM	09/99-05/04
	2.8i VR6 24v.	BVM	09/99-05/04
	3.2 V6 4WD		

... Golf IV 97-03





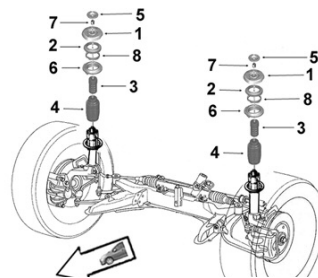

Support d'amortisseur
Suspension mounting
Soporte amortiguador
Poduszka amortyzatora
Опора амортизатора



VOLKSWAGEN







<p>9005630 OE 1J0513353B</p> 	<p>Support suspension G/D <i>L/R suspension mounting</i></p> <p>1</p> <table style="width: 100%; border-collapse: collapse;"> <tr><td>1.4i 16v. /SW</td><td>01/98-</td></tr> <tr><td>1.6i /SW</td><td>01/98-</td></tr> <tr><td>1.6i 16v. /SW</td><td>10/00-</td></tr> <tr><td>1.8i 20v. Turbo</td><td>01/98-</td></tr> <tr><td>1.8 GTi 20v. Turbo</td><td>01/98-</td></tr> <tr><td>1.9 SDi /SW</td><td>01/98-</td></tr> <tr><td>1.9 TDi /SW</td><td>01/98-</td></tr> <tr><td>2.3i VR5 20v.</td><td>02/98-</td></tr> </table>	1.4i 16v. /SW	01/98-	1.6i /SW	01/98-	1.6i 16v. /SW	10/00-	1.8i 20v. Turbo	01/98-	1.8 GTi 20v. Turbo	01/98-	1.9 SDi /SW	01/98-	1.9 TDi /SW	01/98-	2.3i VR5 20v.	02/98-	<p>9005328 OE 1J0512131B</p> 	<p>Butée de suspension G/D <i>L/R suspension bush</i></p> <p>2 H 129</p> <table style="width: 100%; border-collapse: collapse;"> <tr><td>1.4i 16v. /SW</td><td>01/98-</td></tr> <tr><td>1.6i /SW</td><td>01/98-</td></tr> <tr><td>1.6i 16v. /SW</td><td>10/00-</td></tr> <tr><td>1.8i 20v. Turbo</td><td>01/98-</td></tr> <tr><td>1.8 GTi 20v. Turbo</td><td>01/98-</td></tr> <tr><td>1.9 SDi /SW</td><td>01/98-</td></tr> <tr><td>1.9 TDi /SW</td><td>01/98-</td></tr> <tr><td>2.3i VR5 20v.</td><td>01/98-</td></tr> </table>	1.4i 16v. /SW	01/98-	1.6i /SW	01/98-	1.6i 16v. /SW	10/00-	1.8i 20v. Turbo	01/98-	1.8 GTi 20v. Turbo	01/98-	1.9 SDi /SW	01/98-	1.9 TDi /SW	01/98-	2.3i VR5 20v.	01/98-
1.4i 16v. /SW	01/98-																																		
1.6i /SW	01/98-																																		
1.6i 16v. /SW	10/00-																																		
1.8i 20v. Turbo	01/98-																																		
1.8 GTi 20v. Turbo	01/98-																																		
1.9 SDi /SW	01/98-																																		
1.9 TDi /SW	01/98-																																		
2.3i VR5 20v.	02/98-																																		
1.4i 16v. /SW	01/98-																																		
1.6i /SW	01/98-																																		
1.6i 16v. /SW	10/00-																																		
1.8i 20v. Turbo	01/98-																																		
1.8 GTi 20v. Turbo	01/98-																																		
1.9 SDi /SW	01/98-																																		
1.9 TDi /SW	01/98-																																		
2.3i VR5 20v.	01/98-																																		

<p>Eléments TRAIN ARRIERE <i>Rear axle parts</i> <i>Tren TRAS</i> <i>Elementy zawieszenia tylnego</i> <i>элементы задней оси.</i></p> 	<p>2606001 OE 6R0501541A</p>  <p>Articulation traverse <i>Cross bar bush</i></p> <p>Ø int. 12 Ø ext. 71.5 coll. 80 long. tube int. 90 ext. 54.5</p> <table style="width: 100%; border-collapse: collapse;"> <tr><td>1.4i 16v. /SW</td><td>BVM</td><td>01/98-05/04</td></tr> <tr><td>1.6i /SW</td><td></td><td>01/98-05/04</td></tr> <tr><td>1.6i 16v.</td><td>BVM</td><td>10/00-05/04</td></tr> <tr><td>1.8 GTi 20v. Turbo</td><td>BVM</td><td>01/98-05/04</td></tr> <tr><td>1.8i 20v. Turbo</td><td>BVM</td><td>01/98-10/02</td></tr> <tr><td>1.9 SDi /SW</td><td>BVM</td><td>01/98-05/04</td></tr> <tr><td>1.9 TDi /SW</td><td></td><td>01/98-05/04</td></tr> <tr><td>2.3i VR5 20v.</td><td></td><td>02/98-05/04</td></tr> </table>	1.4i 16v. /SW	BVM	01/98-05/04	1.6i /SW		01/98-05/04	1.6i 16v.	BVM	10/00-05/04	1.8 GTi 20v. Turbo	BVM	01/98-05/04	1.8i 20v. Turbo	BVM	01/98-10/02	1.9 SDi /SW	BVM	01/98-05/04	1.9 TDi /SW		01/98-05/04	2.3i VR5 20v.		02/98-05/04
1.4i 16v. /SW	BVM	01/98-05/04																							
1.6i /SW		01/98-05/04																							
1.6i 16v.	BVM	10/00-05/04																							
1.8 GTi 20v. Turbo	BVM	01/98-05/04																							
1.8i 20v. Turbo	BVM	01/98-10/02																							
1.9 SDi /SW	BVM	01/98-05/04																							
1.9 TDi /SW		01/98-05/04																							
2.3i VR5 20v.		02/98-05/04																							

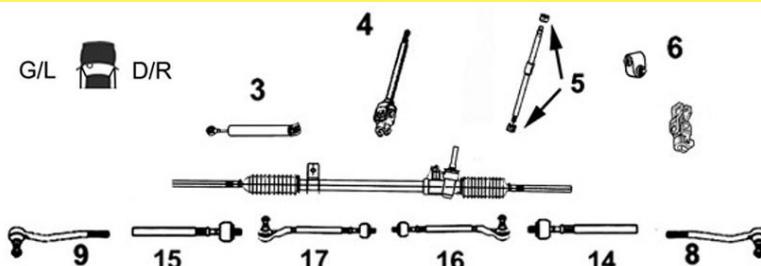
Golf V 03- ...

Eléments DIRECTION
Steering parts
Elementos Direcciones
Elementy układ kierowniczy
Элементы рулевой системы



<p>9006873 OE 1K0423810A</p> 	<p>Axe de bielle G/D <i>L/R axial joint</i></p> <p>14 Côté dir. M16x1.5 Côté rot. M16x1.5 long 310 mm</p> <p>15</p> <table style="width: 100%; border-collapse: collapse;"> <tr><td>1.4i 16v. /Plus /FSi TSi /Plus</td><td></td></tr> <tr><td>1.6i /FSi /Plus</td><td></td></tr> <tr><td>1.6 TDi Plus</td><td></td></tr> <tr><td>1.9 TDi /4WD /Plus</td><td></td></tr> <tr><td>1.9 TDi Plus</td><td></td></tr> <tr><td>2.0 FSi /Plus</td><td>12/05-03/09</td></tr> <tr><td>2.0 GTi 200hp 147kw</td><td>AXX</td></tr> <tr><td>2.0 TFSi /GTi</td><td>12/04-10/08</td></tr> <tr><td>2.0 SDi/TDi /4WD/ Plus</td><td></td></tr> <tr><td>3.2 FSi R32 4WD</td><td>10/05-10/08</td></tr> </table>	1.4i 16v. /Plus /FSi TSi /Plus		1.6i /FSi /Plus		1.6 TDi Plus		1.9 TDi /4WD /Plus		1.9 TDi Plus		2.0 FSi /Plus	12/05-03/09	2.0 GTi 200hp 147kw	AXX	2.0 TFSi /GTi	12/04-10/08	2.0 SDi/TDi /4WD/ Plus		3.2 FSi R32 4WD	10/05-10/08	<p>9006638 OE 1K0423811J</p> 	<p>Rotule de direction G <i>Left tie rod end</i></p> <p>9 M16 x 1.5</p> <table style="width: 100%; border-collapse: collapse;"> <tr><td>1.4i 16v./Plus/FSi 90hp 66kw</td><td></td></tr> <tr><td>1.4 TSi /Plus /Break</td><td>04/06-</td></tr> <tr><td>1.6i /Plus /Break /FSi /Plus</td><td></td></tr> <tr><td>1.6 TDi /Plus</td><td></td></tr> <tr><td>1.9 TDi /Plus /Break</td><td></td></tr> <tr><td>2.0 FSi /4WD /Plus</td><td></td></tr> <tr><td>2.0 GTi 200hp 147kw AXX</td><td></td></tr> <tr><td>2.0 TFSi</td><td>12/04-10/08</td></tr> <tr><td>2.0 SDi 75hp 55kw/TDi /Plus</td><td></td></tr> <tr><td>3.2 FSi 4WD</td><td>10/05-10/08</td></tr> </table>	1.4i 16v./Plus/FSi 90hp 66kw		1.4 TSi /Plus /Break	04/06-	1.6i /Plus /Break /FSi /Plus		1.6 TDi /Plus		1.9 TDi /Plus /Break		2.0 FSi /4WD /Plus		2.0 GTi 200hp 147kw AXX		2.0 TFSi	12/04-10/08	2.0 SDi 75hp 55kw/TDi /Plus		3.2 FSi 4WD	10/05-10/08	<p>9006637 OE 1K0423812J</p> 	<p>Rotule de direction D <i>Right tie rod end</i></p> <p>8 M16 x 1.5</p> <table style="width: 100%; border-collapse: collapse;"> <tr><td>1.4i 16v./Plus/FSi 90hp 66kw</td><td></td></tr> <tr><td>1.4 TSi /Plus /Break</td><td>04/06-</td></tr> <tr><td>1.6i /Plus /Break /FSi /Plus</td><td></td></tr> <tr><td>1.6 TDi /Plus</td><td></td></tr> <tr><td>1.9 TDi /Plus /Break</td><td></td></tr> <tr><td>2.0 FSi /4WD /Plus</td><td></td></tr> <tr><td>2.0 GTi 200hp 147kw AXX</td><td></td></tr> <tr><td>2.0 TFSi</td><td>12/04-10/08</td></tr> <tr><td>2.0 SDi 75hp 55kw/TDi /Plus</td><td></td></tr> <tr><td>3.2 FSi 4WD</td><td>10/05-10/08</td></tr> </table>	1.4i 16v./Plus/FSi 90hp 66kw		1.4 TSi /Plus /Break	04/06-	1.6i /Plus /Break /FSi /Plus		1.6 TDi /Plus		1.9 TDi /Plus /Break		2.0 FSi /4WD /Plus		2.0 GTi 200hp 147kw AXX		2.0 TFSi	12/04-10/08	2.0 SDi 75hp 55kw/TDi /Plus		3.2 FSi 4WD	10/05-10/08
1.4i 16v. /Plus /FSi TSi /Plus																																																																	
1.6i /FSi /Plus																																																																	
1.6 TDi Plus																																																																	
1.9 TDi /4WD /Plus																																																																	
1.9 TDi Plus																																																																	
2.0 FSi /Plus	12/05-03/09																																																																
2.0 GTi 200hp 147kw	AXX																																																																
2.0 TFSi /GTi	12/04-10/08																																																																
2.0 SDi/TDi /4WD/ Plus																																																																	
3.2 FSi R32 4WD	10/05-10/08																																																																
1.4i 16v./Plus/FSi 90hp 66kw																																																																	
1.4 TSi /Plus /Break	04/06-																																																																
1.6i /Plus /Break /FSi /Plus																																																																	
1.6 TDi /Plus																																																																	
1.9 TDi /Plus /Break																																																																	
2.0 FSi /4WD /Plus																																																																	
2.0 GTi 200hp 147kw AXX																																																																	
2.0 TFSi	12/04-10/08																																																																
2.0 SDi 75hp 55kw/TDi /Plus																																																																	
3.2 FSi 4WD	10/05-10/08																																																																
1.4i 16v./Plus/FSi 90hp 66kw																																																																	
1.4 TSi /Plus /Break	04/06-																																																																
1.6i /Plus /Break /FSi /Plus																																																																	
1.6 TDi /Plus																																																																	
1.9 TDi /Plus /Break																																																																	
2.0 FSi /4WD /Plus																																																																	
2.0 GTi 200hp 147kw AXX																																																																	
2.0 TFSi	12/04-10/08																																																																
2.0 SDi 75hp 55kw/TDi /Plus																																																																	
3.2 FSi 4WD	10/05-10/08																																																																

... Golf V 03- ...



VOLKSWAGEN



Barre stabilisatrice
 Stabilizer bar
 Barra estabilizadora
 Drażek stabilizatora
 стабилизатор поперечной устойчивости

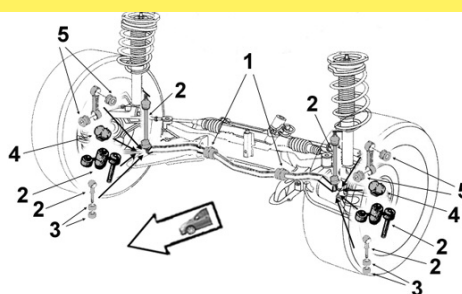

2306010 **Biellette barre stab.**
 OE 1K0411315P *Stabilizer bar stub axle*



2	1.4i 16v. /Break	BVM	11/03-10/08
	1.4i 16v. Plus		01/05-
	1.4 FSi	BVM	05/04-12/05
	1.4 TSi /Twincharger		04/06-10/08
	1.4 TSi Break	BVM	06/07-
	1.4 TSi Plus		05/06-
	1.6i /Break		05/04-10/08
	1.6 FSi /Break		11/03-10/07
	1.6 TDi Plus		01/05-
	1.9 TDi /4WD /Break		11/03-10/08
	2.0 FSi /4WD /Break		05/04-05/06
	2.0 GTi 16v. /TFSi /GTi		12/04-10/08
	2.0 SDi	BVM	05/04-12/06
	2.0 TDi /4WD /Break		11/03-10/08
	2.0 TDi Plus		05/05-
	3.2 FSi R32 4WD		10/05-10/08

9001759 **Articulation AV**
 OE 1K0407182 *Front bush*



1	Ø int.12 Ø ext.40 coll.48 long. tube int.54 ext.33 ep. coll.6	
	1.4i 16v.	11/03-10/08
	1.4i 16v. Plus	01/05-
	1.4 FSi	04/05-12/05
	1.4 TSi	04/06-
	1.6i	05/04-10/08
	1.6 FSi	11/03-10/07
	1.6 TDi Plus	02/09-
	1.9 TDi	11/03-
	2.0 FSi	11/03-10/08
	2.0 GTi	12/04-10/08
	2.0 SDi	05/04-12/06
	2.0 TDi	11/03-
	2.0 TDi Plus	01/05-
	3.2 FSi	10/05-10/08

2256003 **Articulation AR G**
 OE 1K0199231J *Left rear bush*



2	1.4i 16v.	11/03-10/08
	1.4i 16v. Plus	01/05-
	1.4 FSi	04/05-12/05
	1.4 TSi	04/06-
	1.6i	05/04-10/08
	1.6 FSi	11/03-10/07
	1.6 TDi Plus	02/09-
	1.9 TDi /4WD	11/03-
	2.0 FSi /4WD	11/03-10/08
	2.0 GTi	12/04-10/08
	2.0 TFSi /4WD	12/04-10/08
	2.0 SDi	05/04-12/06
	2.0 TDi /4WD	11/03-
	2.0 TDi Plus	05/05-
	3.2 FSi 4WD	10/05-10/08

2256002 **Articulation AR D**
 OE 1K0199232J *Right rear bush*



2	1.4i 16v.	11/03-10/08
	1.4i 16v. Plus	01/05-
	1.4 FSi	04/05-12/05
	1.4 TSi	04/06-
	1.6i	05/04-10/08
	1.6 FSi	11/03-10/07
	1.6 TDi Plus	02/09-
	1.9 TDi /4WD	11/03-
	2.0 FSi /4WD	11/03-10/08
	2.0 GTi	12/04-10/08
	2.0 TFSi /4WD	12/04-10/08
	2.0 SDi	05/04-12/06
	2.0 TDi /4WD	11/03-
	2.0 TDi Plus	05/05-
	3.2 FSi 4WD	10/05-10/08

... Golf V 03- ...







Bras & Triangle de suspension

Control arm
Brazo y triángulo
Wahacz
Рычаг подвески

G/L  D/R



VOLKSWAGEN



<p>7476018 OE 1K0407151AC</p> 	<p>Triangle de susp. G <i>Left track control arm</i></p> <p>4 Fonte Iron Sans rotule Without ball joint</p> <table border="0"> <tr><td>1.4 TSi /SW</td><td>05/06-</td></tr> <tr><td>1.6i</td><td>05/04-10/08</td></tr> <tr><td>1.6 FSi</td><td>11/03-10/07</td></tr> <tr><td>1.9 TDi /SW /4WD</td><td>11/03-12/09</td></tr> <tr><td>2.0 FSi /4WD</td><td>05/04-05/06</td></tr> <tr><td>2.0 GTi</td><td></td></tr> <tr><td>2.0 GTi 16v./TFSi /GTi</td><td>12/04-10/08</td></tr> <tr><td>2.0 TDi /Plus /4WD</td><td>11/03-</td></tr> <tr><td>3.2 FSi 4WD</td><td>10/05-</td></tr> <tr><td>3.2 FSi R32 4WD</td><td>10/05-10/08</td></tr> </table>	1.4 TSi /SW	05/06-	1.6i	05/04-10/08	1.6 FSi	11/03-10/07	1.9 TDi /SW /4WD	11/03-12/09	2.0 FSi /4WD	05/04-05/06	2.0 GTi		2.0 GTi 16v./TFSi /GTi	12/04-10/08	2.0 TDi /Plus /4WD	11/03-	3.2 FSi 4WD	10/05-	3.2 FSi R32 4WD	10/05-10/08	<p>7476017 OE 1K0407152AC</p> 	<p>Triangle de susp. D <i>Right track control arm</i></p> <p>3 Fonte Iron Sans rotule Without ball joint</p> <table border="0"> <tr><td>1.4 TSi /SW</td><td>05/06-</td></tr> <tr><td>1.6i</td><td>05/04-10/08</td></tr> <tr><td>1.6 FSi</td><td>11/03-10/07</td></tr> <tr><td>1.9 TDi /SW /4WD</td><td>11/03-12/09</td></tr> <tr><td>2.0 FSi /4WD</td><td>05/04-05/06</td></tr> <tr><td>2.0 GTi</td><td></td></tr> <tr><td>2.0 GTi 16v./TFSi /GTi</td><td>12/04-10/08</td></tr> <tr><td>2.0 TDi /Plus /4WD</td><td>11/03-</td></tr> <tr><td>3.2 FSi 4WD</td><td>10/05-</td></tr> <tr><td>3.2 FSi R32 4WD</td><td>10/05-10/08</td></tr> </table>	1.4 TSi /SW	05/06-	1.6i	05/04-10/08	1.6 FSi	11/03-10/07	1.9 TDi /SW /4WD	11/03-12/09	2.0 FSi /4WD	05/04-05/06	2.0 GTi		2.0 GTi 16v./TFSi /GTi	12/04-10/08	2.0 TDi /Plus /4WD	11/03-	3.2 FSi 4WD	10/05-	3.2 FSi R32 4WD	10/05-10/08		
1.4 TSi /SW	05/06-																																												
1.6i	05/04-10/08																																												
1.6 FSi	11/03-10/07																																												
1.9 TDi /SW /4WD	11/03-12/09																																												
2.0 FSi /4WD	05/04-05/06																																												
2.0 GTi																																													
2.0 GTi 16v./TFSi /GTi	12/04-10/08																																												
2.0 TDi /Plus /4WD	11/03-																																												
3.2 FSi 4WD	10/05-																																												
3.2 FSi R32 4WD	10/05-10/08																																												
1.4 TSi /SW	05/06-																																												
1.6i	05/04-10/08																																												
1.6 FSi	11/03-10/07																																												
1.9 TDi /SW /4WD	11/03-12/09																																												
2.0 FSi /4WD	05/04-05/06																																												
2.0 GTi																																													
2.0 GTi 16v./TFSi /GTi	12/04-10/08																																												
2.0 TDi /Plus /4WD	11/03-																																												
3.2 FSi 4WD	10/05-																																												
3.2 FSi R32 4WD	10/05-10/08																																												
<p>7476128 OE 1K0407151AC+1K0407365C</p>  <p>NEW</p>	<p>Triangle de susp. G <i>Left track control arm</i></p> <p>4 Avec rotule With ball joint</p> <table border="0"> <tr><td>1.4 TSi</td><td>04/06-</td></tr> <tr><td>1.6i Ch- 1K4100001</td><td></td></tr> <tr><td>1.6 FSi</td><td>11/03-10/07</td></tr> <tr><td>1.9 TDi /SW /4WD</td><td></td></tr> <tr><td>Ch- 1K4100001</td><td>11/03-12/09</td></tr> <tr><td>2.0 FSi Ch- 1K4100001</td><td>-05/06</td></tr> <tr><td>2.0 TFSi /GTi</td><td>12/04-10/08</td></tr> <tr><td>2.0 TDi Ch- 1K4100001</td><td></td></tr> <tr><td>2.0 TDi Plus</td><td>11/03-</td></tr> <tr><td>3.2 FSi 4WD</td><td>10/05-</td></tr> </table>	1.4 TSi	04/06-	1.6i Ch- 1K4100001		1.6 FSi	11/03-10/07	1.9 TDi /SW /4WD		Ch- 1K4100001	11/03-12/09	2.0 FSi Ch- 1K4100001	-05/06	2.0 TFSi /GTi	12/04-10/08	2.0 TDi Ch- 1K4100001		2.0 TDi Plus	11/03-	3.2 FSi 4WD	10/05-	<p>7476127 OE 1K0407152M+1K0407366C</p>  <p>NEW</p>	<p>Triangle de susp. D <i>Right track control arm</i></p> <p>3 Avec rotule With ball joint</p> <table border="0"> <tr><td>1.4 TSi</td><td>04/06-</td></tr> <tr><td>1.6i Ch- 1K4100001</td><td></td></tr> <tr><td>1.6 FSi</td><td>11/03-10/07</td></tr> <tr><td>1.9 TDi /SW /4WD</td><td></td></tr> <tr><td>Ch- 1K4100001</td><td>11/03-12/09</td></tr> <tr><td>2.0 FSi Ch- 1K4100001</td><td>-05/06</td></tr> <tr><td>2.0 TFSi /GTi</td><td>12/04-10/08</td></tr> <tr><td>2.0 TDi Ch- 1K4100001</td><td></td></tr> <tr><td>2.0 TDi Plus</td><td>11/03-</td></tr> <tr><td>3.2 FSi 4WD</td><td>10/05-</td></tr> </table>	1.4 TSi	04/06-	1.6i Ch- 1K4100001		1.6 FSi	11/03-10/07	1.9 TDi /SW /4WD		Ch- 1K4100001	11/03-12/09	2.0 FSi Ch- 1K4100001	-05/06	2.0 TFSi /GTi	12/04-10/08	2.0 TDi Ch- 1K4100001		2.0 TDi Plus	11/03-	3.2 FSi 4WD	10/05-		
1.4 TSi	04/06-																																												
1.6i Ch- 1K4100001																																													
1.6 FSi	11/03-10/07																																												
1.9 TDi /SW /4WD																																													
Ch- 1K4100001	11/03-12/09																																												
2.0 FSi Ch- 1K4100001	-05/06																																												
2.0 TFSi /GTi	12/04-10/08																																												
2.0 TDi Ch- 1K4100001																																													
2.0 TDi Plus	11/03-																																												
3.2 FSi 4WD	10/05-																																												
1.4 TSi	04/06-																																												
1.6i Ch- 1K4100001																																													
1.6 FSi	11/03-10/07																																												
1.9 TDi /SW /4WD																																													
Ch- 1K4100001	11/03-12/09																																												
2.0 FSi Ch- 1K4100001	-05/06																																												
2.0 TFSi /GTi	12/04-10/08																																												
2.0 TDi Ch- 1K4100001																																													
2.0 TDi Plus	11/03-																																												
3.2 FSi 4WD	10/05-																																												
<p>9005757 OE 1K0407151AH</p> 	<p>Triangle de susp. G <i>Left track control arm</i></p> <p>4 acier steel Sans rotule Without ball joint</p> <table border="0"> <tr><td>1.4i 16v.</td><td>Véhicule sans réglage automatique de la hauteur des phares</td><td>-Ch 1K6590000</td></tr> <tr><td>1.4i 16v. Plus</td><td></td><td>-Ch 1K6590000</td></tr> <tr><td>1.4 FSi</td><td>Véhicule sans réglage automatique de la hauteur des phares</td><td>-Ch 1K-6-061500</td></tr> <tr><td>1.6i</td><td>Véhicule sans réglage automatique de la hauteur des phares</td><td></td></tr> <tr><td>1.6 Plus</td><td></td><td>-Ch 1K6590000</td></tr> <tr><td>1.6 FSi</td><td>Véhicule sans réglage automatique de la hauteur des phares</td><td>-Ch 1K-6-061500</td></tr> <tr><td>1.6 FSi Plus</td><td></td><td>-Ch 1K6590000</td></tr> <tr><td>1.9 TDi</td><td>Véhicule sans réglage automatique de la hauteur des phares</td><td></td></tr> <tr><td>1.9 TDi Plus</td><td></td><td>-Ch 1K6590000</td></tr> <tr><td>2.0 FSi</td><td>Véhicule sans réglage automatique de la hauteur des phares</td><td></td></tr> <tr><td>2.0 GTi 200hp 147kw</td><td>Véhicule sans réglage automatique de la hauteur des phares</td><td>AXX</td></tr> <tr><td>2.0 FSi Plus</td><td></td><td>-Ch 1K6590000</td></tr> <tr><td>2.0 SDi</td><td>Véhicule sans réglage automatique de la hauteur des phares</td><td></td></tr> <tr><td>2.0 TDi</td><td>Véhicule sans réglage automatique de la hauteur des phares</td><td></td></tr> </table>			1.4i 16v.	Véhicule sans réglage automatique de la hauteur des phares	-Ch 1K6590000	1.4i 16v. Plus		-Ch 1K6590000	1.4 FSi	Véhicule sans réglage automatique de la hauteur des phares	-Ch 1K-6-061500	1.6i	Véhicule sans réglage automatique de la hauteur des phares		1.6 Plus		-Ch 1K6590000	1.6 FSi	Véhicule sans réglage automatique de la hauteur des phares	-Ch 1K-6-061500	1.6 FSi Plus		-Ch 1K6590000	1.9 TDi	Véhicule sans réglage automatique de la hauteur des phares		1.9 TDi Plus		-Ch 1K6590000	2.0 FSi	Véhicule sans réglage automatique de la hauteur des phares		2.0 GTi 200hp 147kw	Véhicule sans réglage automatique de la hauteur des phares	AXX	2.0 FSi Plus		-Ch 1K6590000	2.0 SDi	Véhicule sans réglage automatique de la hauteur des phares		2.0 TDi	Véhicule sans réglage automatique de la hauteur des phares	
1.4i 16v.	Véhicule sans réglage automatique de la hauteur des phares	-Ch 1K6590000																																											
1.4i 16v. Plus		-Ch 1K6590000																																											
1.4 FSi	Véhicule sans réglage automatique de la hauteur des phares	-Ch 1K-6-061500																																											
1.6i	Véhicule sans réglage automatique de la hauteur des phares																																												
1.6 Plus		-Ch 1K6590000																																											
1.6 FSi	Véhicule sans réglage automatique de la hauteur des phares	-Ch 1K-6-061500																																											
1.6 FSi Plus		-Ch 1K6590000																																											
1.9 TDi	Véhicule sans réglage automatique de la hauteur des phares																																												
1.9 TDi Plus		-Ch 1K6590000																																											
2.0 FSi	Véhicule sans réglage automatique de la hauteur des phares																																												
2.0 GTi 200hp 147kw	Véhicule sans réglage automatique de la hauteur des phares	AXX																																											
2.0 FSi Plus		-Ch 1K6590000																																											
2.0 SDi	Véhicule sans réglage automatique de la hauteur des phares																																												
2.0 TDi	Véhicule sans réglage automatique de la hauteur des phares																																												
<p>9005756 OE 1K0407152AH</p> 	<p>Triangle de susp. D <i>Right track control arm</i></p> <p>3 acier steel Sans rotule Without ball joint</p> <table border="0"> <tr><td>1.4i 16v.</td><td>Véhicule sans réglage automatique de la hauteur des phares</td><td>-Ch 1K6590000</td></tr> <tr><td>1.4i 16v. Plus</td><td></td><td>-Ch 1K6590000</td></tr> <tr><td>1.4 FSi</td><td>Véhicule sans réglage automatique de la hauteur des phares</td><td>-Ch 1K-6-061500</td></tr> <tr><td>1.6i</td><td>Véhicule sans réglage automatique de la hauteur des phares</td><td></td></tr> <tr><td>1.6 Plus</td><td></td><td>-Ch 1K6590000</td></tr> <tr><td>1.6 FSi</td><td>Véhicule sans réglage automatique de la hauteur des phares</td><td>-Ch 1K-6-061500</td></tr> <tr><td>1.6 FSi Plus</td><td></td><td>-Ch 1K6590000</td></tr> <tr><td>1.9 TDi</td><td>Véhicule sans réglage automatique de la hauteur des phares</td><td></td></tr> <tr><td>1.9 TDi Plus</td><td></td><td>-Ch 1K6590000</td></tr> <tr><td>2.0 FSi</td><td>Véhicule sans réglage automatique de la hauteur des phares</td><td></td></tr> <tr><td>2.0 GTi 200hp 147kw</td><td>Véhicule sans réglage automatique de la hauteur des phares</td><td>AXX</td></tr> <tr><td>2.0 FSi Plus</td><td></td><td>-Ch 1K6590000</td></tr> <tr><td>2.0 SDi</td><td>Véhicule sans réglage automatique de la hauteur des phares</td><td></td></tr> <tr><td>2.0 TDi</td><td>Véhicule sans réglage automatique de la hauteur des phares</td><td></td></tr> </table>			1.4i 16v.	Véhicule sans réglage automatique de la hauteur des phares	-Ch 1K6590000	1.4i 16v. Plus		-Ch 1K6590000	1.4 FSi	Véhicule sans réglage automatique de la hauteur des phares	-Ch 1K-6-061500	1.6i	Véhicule sans réglage automatique de la hauteur des phares		1.6 Plus		-Ch 1K6590000	1.6 FSi	Véhicule sans réglage automatique de la hauteur des phares	-Ch 1K-6-061500	1.6 FSi Plus		-Ch 1K6590000	1.9 TDi	Véhicule sans réglage automatique de la hauteur des phares		1.9 TDi Plus		-Ch 1K6590000	2.0 FSi	Véhicule sans réglage automatique de la hauteur des phares		2.0 GTi 200hp 147kw	Véhicule sans réglage automatique de la hauteur des phares	AXX	2.0 FSi Plus		-Ch 1K6590000	2.0 SDi	Véhicule sans réglage automatique de la hauteur des phares		2.0 TDi	Véhicule sans réglage automatique de la hauteur des phares	
1.4i 16v.	Véhicule sans réglage automatique de la hauteur des phares	-Ch 1K6590000																																											
1.4i 16v. Plus		-Ch 1K6590000																																											
1.4 FSi	Véhicule sans réglage automatique de la hauteur des phares	-Ch 1K-6-061500																																											
1.6i	Véhicule sans réglage automatique de la hauteur des phares																																												
1.6 Plus		-Ch 1K6590000																																											
1.6 FSi	Véhicule sans réglage automatique de la hauteur des phares	-Ch 1K-6-061500																																											
1.6 FSi Plus		-Ch 1K6590000																																											
1.9 TDi	Véhicule sans réglage automatique de la hauteur des phares																																												
1.9 TDi Plus		-Ch 1K6590000																																											
2.0 FSi	Véhicule sans réglage automatique de la hauteur des phares																																												
2.0 GTi 200hp 147kw	Véhicule sans réglage automatique de la hauteur des phares	AXX																																											
2.0 FSi Plus		-Ch 1K6590000																																											
2.0 SDi	Véhicule sans réglage automatique de la hauteur des phares																																												
2.0 TDi	Véhicule sans réglage automatique de la hauteur des phares																																												

... Golf V 03- ...

Bras & Triangle de suspension

Control arm
Brazo y triángulo
Wahacz
Рычаг подвески

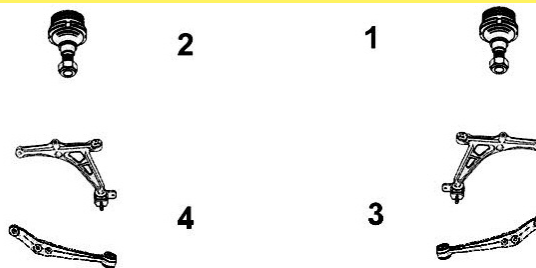
G/L  D/R



7476095

Triangle de susp. G

OE 1K0407365C + 1K0407151P *Left track control arm*

NEW

4 Avec rotule With ball joint



1.4i 16v.	Véhicule sans réglage automatique de la hauteur des phares	Ch- 1K4100001
1.4i 16v. Plus	Véhicule sans réglage automatique de la hauteur des phares	
1.4 FSi	Véhicule sans réglage automatique de la hauteur des phares	Ch- 1K4100001 -Ch 1K-6-061500
1.6i	Véhicule sans réglage automatique de la hauteur des phares	Ch- 1K4100001
1.6 FSi	Véhicule sans réglage automatique de la hauteur des phares	Ch- 1K4100000 -Ch 1K-6-061500
1.6 FSi Plus		-Ch 1K6590000
1.9 TDi	Véhicule sans réglage automatique de la hauteur des phares	Ch- 1K4100001
1.9 TDi Plus		-Ch 1K6590000
2.0 FSi	Véhicule sans réglage automatique de la hauteur des phares	Ch- 1K4100001
2.0 FSi Plus		-Ch 1K6590000
2.0 GTi 200hp 147kw	Véhicule sans réglage automatique de la hauteur des phares AXX	Ch- 1K4100001
2.0 SDi	Véhicule sans réglage automatique de la hauteur des phares	Ch- 1K4100001
2.0 TDi	Véhicule sans réglage automatique de la hauteur des phares	Ch- 1K4100001

7476097

Triangle de susp. D

OE 1K0407366C + 1K0407152P *Right track control arm*

NEW

3 Avec rotule With ball joint



1.4i 16v.	Véhicule sans réglage automatique de la hauteur des phares	Ch- 1K4100001
1.4i 16v. Plus	Véhicule sans réglage automatique de la hauteur des phares	
1.4 FSi	Véhicule sans réglage automatique de la hauteur des phares	Ch- 1K4100001 -Ch 1K-6-061500
1.6i	Véhicule sans réglage automatique de la hauteur des phares	Ch- 1K4100001
1.6 FSi	Véhicule sans réglage automatique de la hauteur des phares	Ch- 1K4100000 -Ch 1K-6-061500
1.6 FSi Plus		-Ch 1K6590000
1.9 TDi	Véhicule sans réglage automatique de la hauteur des phares	Ch- 1K4100001
1.9 TDi Plus		-Ch 1K6590000
2.0 FSi	Véhicule sans réglage automatique de la hauteur des phares	Ch- 1K4100001
2.0 FSi Plus		-Ch 1K6590000
2.0 GTi 200hp 147kw	Véhicule sans réglage automatique de la hauteur des phares AXX	Ch- 1K4100001
2.0 SDi	Véhicule sans réglage automatique de la hauteur des phares	Ch- 1K4100001
2.0 TDi	Véhicule sans réglage automatique de la hauteur des phares	Ch- 1K4100001

9005570

Rotule de susp. inf. G

OE 1K0407365C *Left lower suspension ball joint*

2	1.4i 16v.	Ch- 1K4100001
	1.4i 16v. Plus	
	1.4 FSi	Ch- 1K4100001
	1.4 TSi	04/06-
	1.4 TSi Plus	
	1.6i	Ch- 1K4100001
	1.6 Plus	
	1.6 FSi	Ch- 1K4100001
	1.6 FSi Plus	
	1.6 TDi Plus	02/09-
	1.9 TDid	12/05-03/09
	1.9 TDi	Ch- 1K4100001
	1.9 TDi Plus	
	2.0 FSi /GTi	Ch- 1K4100001
	2.0 FSi Plus	
	2.0 TFSi /GTi	12/04-10/08
	2.0 SDi	Ch- 1K4100001
	2.0 TDi	Ch- 1K4100001
	2.0 TDi Plus	
	3.2 FSi	10/05-10/08



9005569

Rotule de susp. inf. D

OE 1K0407366C *Right lower suspension ball joint*

1	1.4i 16v.	Ch- 1K4100001
	1.4i 16v. Plus	
	1.4 FSi	Ch- 1K4100001
	1.4 TSi	04/06-
	1.4 TSi Plus	
	1.6i	Ch- 1K4100001
	1.6 Plus	
	1.6 FSi	Ch- 1K4100001
	1.6 FSi Plus	
	1.6 TDi Plus	02/09-
	1.9 TDid	12/05-03/09
	1.9 TDi	Ch- 1K4100001
	1.9 TDi Plus	
	2.0 FSi /GTi	Ch- 1K4100001
	2.0 FSi Plus	
	2.0 TFSi /GTi	12/04-10/08
	2.0 SDi	Ch- 1K4100001
	2.0 TDi	Ch- 1K4100001
	2.0 TDi Plus	
	3.2 FSi	10/05-10/08



... Golf V 03- ...





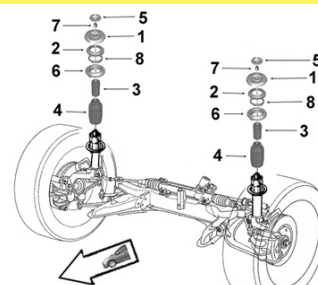

Support d'amortisseur
Suspension mounting
Soporte amortiguador
Poduszka amortyzatora
Опора амортизатора



VOLKSWAGEN





9005622 OE 1K0412331B	Support suspension G/D <i>L/R suspension mounting</i>	2656004 OE 1K0412303E	Butée de suspension <i>Shock bush</i>																																																				
1	 <table style="width: 100%; border-collapse: collapse;"> <tr><td>1.4i 16v. /Plus /FSi</td><td>11/03-</td></tr> <tr><td>1.4 TSi /Break /Plus</td><td>05/06-</td></tr> <tr><td>1.6i /Break /FSi /Plus</td><td>11/03-</td></tr> <tr><td>1.6 TDi Plus</td><td>02/09-</td></tr> <tr><td>1.9 TDi/Plus/4WD /Break</td><td>11/03-</td></tr> <tr><td>1.9 TDid Plus</td><td>12/05-03/09</td></tr> <tr><td>2.0 FSi /Plus /4WD</td><td>11/03-</td></tr> <tr><td>2.0 TFSi /GTi</td><td></td></tr> <tr><td>2.0 SDi</td><td>11/03-</td></tr> <tr><td>2.0 TDi /Plus/4WD/Break</td><td>11/03-</td></tr> <tr><td>3.2 FSi</td><td>10/05-</td></tr> </table>	1.4i 16v. /Plus /FSi	11/03-	1.4 TSi /Break /Plus	05/06-	1.6i /Break /FSi /Plus	11/03-	1.6 TDi Plus	02/09-	1.9 TDi/Plus/4WD /Break	11/03-	1.9 TDid Plus	12/05-03/09	2.0 FSi /Plus /4WD	11/03-	2.0 TFSi /GTi		2.0 SDi	11/03-	2.0 TDi /Plus/4WD/Break	11/03-	3.2 FSi	10/05-	3	 <table style="width: 100%; border-collapse: collapse;"> <tr><td colspan="2">H55</td></tr> <tr><td>1.4i 16v. /Plus</td><td>11/03-</td></tr> <tr><td>1.4 FSi</td><td>05/04-12/05</td></tr> <tr><td>1.4 TSi /Break /Plus</td><td>05/06-</td></tr> <tr><td>1.6i /Plus /Break</td><td>05/04-</td></tr> <tr><td>1.6 FSi /Plus</td><td>11/03-10/07</td></tr> <tr><td>1.6 TDi Plus</td><td></td></tr> <tr><td>1.9 TDi/4WD/Plus/Break</td><td>11/03-</td></tr> <tr><td>1.9 TDid Plus</td><td>12/05-</td></tr> <tr><td>2.0 FSi /4WD /Plus</td><td>05/04-05/06</td></tr> <tr><td>2.0 GTi 16v.</td><td>12/04-</td></tr> <tr><td>2.0 TFSi /GTi</td><td>12/04-</td></tr> <tr><td>2.0 SDi</td><td>05/04-12/06</td></tr> <tr><td>2.0 TDi/4WD/Plus/Break</td><td>11/03-</td></tr> <tr><td>3.2 FSi R32 4WD</td><td>10/05-</td></tr> </table>	H55		1.4i 16v. /Plus	11/03-	1.4 FSi	05/04-12/05	1.4 TSi /Break /Plus	05/06-	1.6i /Plus /Break	05/04-	1.6 FSi /Plus	11/03-10/07	1.6 TDi Plus		1.9 TDi/4WD/Plus/Break	11/03-	1.9 TDid Plus	12/05-	2.0 FSi /4WD /Plus	05/04-05/06	2.0 GTi 16v.	12/04-	2.0 TFSi /GTi	12/04-	2.0 SDi	05/04-12/06	2.0 TDi/4WD/Plus/Break	11/03-	3.2 FSi R32 4WD	10/05-
1.4i 16v. /Plus /FSi	11/03-																																																						
1.4 TSi /Break /Plus	05/06-																																																						
1.6i /Break /FSi /Plus	11/03-																																																						
1.6 TDi Plus	02/09-																																																						
1.9 TDi/Plus/4WD /Break	11/03-																																																						
1.9 TDid Plus	12/05-03/09																																																						
2.0 FSi /Plus /4WD	11/03-																																																						
2.0 TFSi /GTi																																																							
2.0 SDi	11/03-																																																						
2.0 TDi /Plus/4WD/Break	11/03-																																																						
3.2 FSi	10/05-																																																						
H55																																																							
1.4i 16v. /Plus	11/03-																																																						
1.4 FSi	05/04-12/05																																																						
1.4 TSi /Break /Plus	05/06-																																																						
1.6i /Plus /Break	05/04-																																																						
1.6 FSi /Plus	11/03-10/07																																																						
1.6 TDi Plus																																																							
1.9 TDi/4WD/Plus/Break	11/03-																																																						
1.9 TDid Plus	12/05-																																																						
2.0 FSi /4WD /Plus	05/04-05/06																																																						
2.0 GTi 16v.	12/04-																																																						
2.0 TFSi /GTi	12/04-																																																						
2.0 SDi	05/04-12/06																																																						
2.0 TDi/4WD/Plus/Break	11/03-																																																						
3.2 FSi R32 4WD	10/05-																																																						

2656052 OE 1K0412303B	Butée de suspension <i>Shock bush</i>	2656053 OE 6N0413175A	Protecteur amortisseur G/D <i>L/R shock absorber protector</i>																																																								
3	 <table style="width: 100%; border-collapse: collapse;"> <tr><td colspan="2">H70</td></tr> <tr><td>1.4i 16v. /Plus</td><td>11/03-</td></tr> <tr><td>1.4 FSi</td><td>01/04-12/05</td></tr> <tr><td>1.4 TSi /Plus /Break</td><td>04/06-</td></tr> <tr><td>1.6i /Plus</td><td>05/04-10/08</td></tr> <tr><td>1.6i Break</td><td>06/07-12/09</td></tr> <tr><td>1.6 FSi /Plus</td><td>11/03-06/07</td></tr> <tr><td>1.6 TDi Plus</td><td>04/09-</td></tr> <tr><td>1.9 TDi/Plus/4WD/Break</td><td>11/03-12/09</td></tr> <tr><td>2.0 FSi /Plus /4WD</td><td>05/04-05/06</td></tr> <tr><td>2.0 TFSi</td><td>12/04-10/08</td></tr> <tr><td>2.0 SDi</td><td>05/04-12/06</td></tr> <tr><td>2.0 TDi /Plus /Break</td><td>11/03-</td></tr> <tr><td>3.2 FSi</td><td>10/05-10/08</td></tr> </table>	H70		1.4i 16v. /Plus	11/03-	1.4 FSi	01/04-12/05	1.4 TSi /Plus /Break	04/06-	1.6i /Plus	05/04-10/08	1.6i Break	06/07-12/09	1.6 FSi /Plus	11/03-06/07	1.6 TDi Plus	04/09-	1.9 TDi/Plus/4WD/Break	11/03-12/09	2.0 FSi /Plus /4WD	05/04-05/06	2.0 TFSi	12/04-10/08	2.0 SDi	05/04-12/06	2.0 TDi /Plus /Break	11/03-	3.2 FSi	10/05-10/08	4	 <table style="width: 100%; border-collapse: collapse;"> <tr><td colspan="2">H206</td></tr> <tr><td>1.4i 16v.</td><td>11/03-10/08</td></tr> <tr><td>1.4i 16v. Plus</td><td>03/05-</td></tr> <tr><td>1.4 FSi</td><td>01/04-12/05</td></tr> <tr><td>1.4 TSi /Plus /Break</td><td>05/06-</td></tr> <tr><td>1.6i /Plus /Break</td><td>05/04-</td></tr> <tr><td>1.6 FSi /Plus</td><td>11/03-10/07</td></tr> <tr><td>1.6 TDi Plus</td><td>04/09-</td></tr> <tr><td>1.9 TDi/Plus/4WD/Break</td><td>11/03-</td></tr> <tr><td>2.0 FSi /GTi /Plus /4WD</td><td></td></tr> <tr><td>2.0 TFSi /GTi</td><td>12/04-</td></tr> <tr><td>2.0 SDi</td><td>05/04-12/06</td></tr> <tr><td>2.0 TDi/Plus/4WD/Break</td><td>11/03-</td></tr> <tr><td>3.2 FSi</td><td>10/05-</td></tr> </table>	H206		1.4i 16v.	11/03-10/08	1.4i 16v. Plus	03/05-	1.4 FSi	01/04-12/05	1.4 TSi /Plus /Break	05/06-	1.6i /Plus /Break	05/04-	1.6 FSi /Plus	11/03-10/07	1.6 TDi Plus	04/09-	1.9 TDi/Plus/4WD/Break	11/03-	2.0 FSi /GTi /Plus /4WD		2.0 TFSi /GTi	12/04-	2.0 SDi	05/04-12/06	2.0 TDi/Plus/4WD/Break	11/03-	3.2 FSi	10/05-
H70																																																											
1.4i 16v. /Plus	11/03-																																																										
1.4 FSi	01/04-12/05																																																										
1.4 TSi /Plus /Break	04/06-																																																										
1.6i /Plus	05/04-10/08																																																										
1.6i Break	06/07-12/09																																																										
1.6 FSi /Plus	11/03-06/07																																																										
1.6 TDi Plus	04/09-																																																										
1.9 TDi/Plus/4WD/Break	11/03-12/09																																																										
2.0 FSi /Plus /4WD	05/04-05/06																																																										
2.0 TFSi	12/04-10/08																																																										
2.0 SDi	05/04-12/06																																																										
2.0 TDi /Plus /Break	11/03-																																																										
3.2 FSi	10/05-10/08																																																										
H206																																																											
1.4i 16v.	11/03-10/08																																																										
1.4i 16v. Plus	03/05-																																																										
1.4 FSi	01/04-12/05																																																										
1.4 TSi /Plus /Break	05/06-																																																										
1.6i /Plus /Break	05/04-																																																										
1.6 FSi /Plus	11/03-10/07																																																										
1.6 TDi Plus	04/09-																																																										
1.9 TDi/Plus/4WD/Break	11/03-																																																										
2.0 FSi /GTi /Plus /4WD																																																											
2.0 TFSi /GTi	12/04-																																																										
2.0 SDi	05/04-12/06																																																										
2.0 TDi/Plus/4WD/Break	11/03-																																																										
3.2 FSi	10/05-																																																										

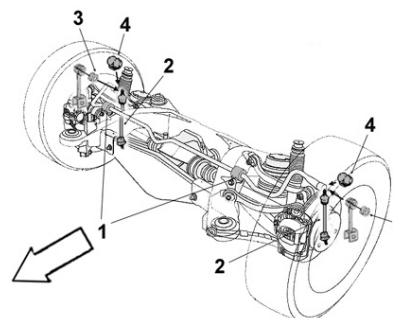

Barre stabilisatrice
Stabilizer bar
Barra estabilizadora
Drażek stabilizatora
стабилизатор поперечной устойчивости



9005094 OE 1K0505465K	Biellette barre stab. <i>Stabilizer bar stub axle</i>	9001739 OE 1K0511327AP	Palier de barre milieu <i>Middle bar main bearing</i>																																				
2	 <table style="width: 100%; border-collapse: collapse;"> <tr><td colspan="2">Ch- 1K-5-175001</td></tr> <tr><td>1.4i 16v.</td><td></td></tr> <tr><td>1.4 FSi TSi</td><td></td></tr> <tr><td>1.6i /FSi</td><td></td></tr> <tr><td>1.9 TDi</td><td></td></tr> <tr><td>2.0 FSi GTi TFSi SDi TDi</td><td></td></tr> <tr><td>1.6 TDi</td><td>02/09-</td></tr> <tr><td>2.0 TDi Plus</td><td>05/05-</td></tr> <tr><td>3.2 FSi</td><td>10/05-10/08</td></tr> </table>	Ch- 1K-5-175001		1.4i 16v.		1.4 FSi TSi		1.6i /FSi		1.9 TDi		2.0 FSi GTi TFSi SDi TDi		1.6 TDi	02/09-	2.0 TDi Plus	05/05-	3.2 FSi	10/05-10/08	1	 <table style="width: 100%; border-collapse: collapse;"> <tr><td colspan="2">Barre Ø 18.5</td></tr> <tr><td>1.4i 16v.</td><td>11/03-</td></tr> <tr><td>1.4 FSi</td><td>11/03-</td></tr> <tr><td>1.4 TSi /Break</td><td>11/05-</td></tr> <tr><td>1.6i</td><td>11/03-</td></tr> <tr><td>1.6 FSi</td><td>11/03-</td></tr> <tr><td>1.9 TDi</td><td>11/03-</td></tr> <tr><td>2.0 FSi GTi</td><td>11/03-</td></tr> <tr><td>2.0 SDi TDi</td><td>11/03-</td></tr> </table>	Barre Ø 18.5		1.4i 16v.	11/03-	1.4 FSi	11/03-	1.4 TSi /Break	11/05-	1.6i	11/03-	1.6 FSi	11/03-	1.9 TDi	11/03-	2.0 FSi GTi	11/03-	2.0 SDi TDi	11/03-
Ch- 1K-5-175001																																							
1.4i 16v.																																							
1.4 FSi TSi																																							
1.6i /FSi																																							
1.9 TDi																																							
2.0 FSi GTi TFSi SDi TDi																																							
1.6 TDi	02/09-																																						
2.0 TDi Plus	05/05-																																						
3.2 FSi	10/05-10/08																																						
Barre Ø 18.5																																							
1.4i 16v.	11/03-																																						
1.4 FSi	11/03-																																						
1.4 TSi /Break	11/05-																																						
1.6i	11/03-																																						
1.6 FSi	11/03-																																						
1.9 TDi	11/03-																																						
2.0 FSi GTi	11/03-																																						
2.0 SDi TDi	11/03-																																						

... Golf V 03- ...



Barre stabilisatrice
 Stabilizer bar
 Barra estabilizadora
 Drażek stabilizatora
 стабилизатор поперечной устойчивости

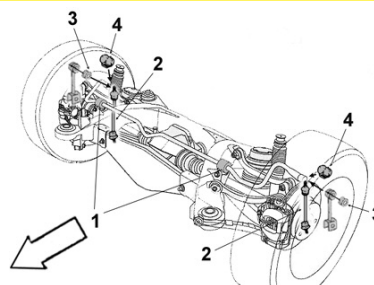

2306013 **Palier de barre milieu**
 OE 1K0511327AQ *Middle bar main bearing*

1	Barre Ø 19.6	
	1.4i 16v.	11/03-10/08
	1.4 FSi	05/04-12/05
	1.4 TSi /Break	05/06-10/08
	1.6i /Break	05/04-10/08
	1.6 FSi	11/03-10/07
	1.9 TDi /4WD /Break	11/03-
	2.0 FSi /GTi /4WD	05/04-10/08
	2.0 TFSi GTi	12/04-10/08
	2.0 SDi	05/04-12/06
	2.0 TDi /Break /4WD	11/03-10/08
	3.2 FSi R32 4WD	10/05-10/08



9001737 **Palier de barre milieu**
 OE 1K0511327AR *Middle bar main bearing*

1	Barre Ø 20.7	
	1.4i 16v. /Plus	11/03-
	1.4 FSi	05/04-
	1.4 TSi Plus	05/06-
	1.6i	05/04-
	1.6 FSi	11/03-
	1.6 TDi Plus	02/09-
	1.9 TDi /4WD	11/03-
	2.0 FSi /4WD	05/04-
	2.0 GTi 16v.	10/04-
	2.0 SDi	05/04-
	2.0 TDi /4WD	11/03-
	2.0 TDi Plus	01/05-



2306014 **Palier de barre milieu**
 OE 1K0511327AS *Middle bar main bearing*

1	Barre Ø 21.7	
	1.4i 16v.	11/03-10/08
	1.4 FSi	05/04-12/05
	1.4 TSi /Break	04/06-10/08
	1.6i /Plus /Break	05/04-12/08
	1.6 FSi	11/03-10/07
	1.9 TDi /4WD /Break	11/03-03/09
	2.0 FSi /4WD /GTi	05/04-10/08
	2.0 TFSi /GTi	12/04-10/08
	2.0 SDi	05/04-12/05
	2.0 TDi /4WD /Break	11/03-03/09
	3.2 FSi R32 4WD	10/05-10/08



Support d'amortisseur
 Suspension mounting
 Soporte amortiguador
 Poduszka amortyzatora
 Опора амортизатора

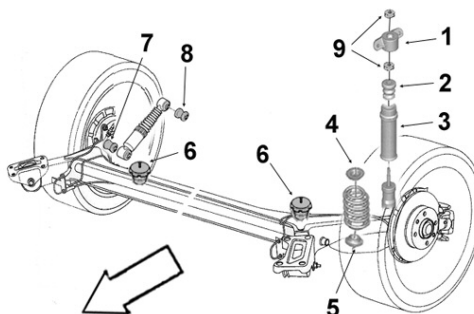



9005631 **Support suspension G/D**
 OE 1K0513353H *L/R suspension mounting*

1			
	1.9 TDi 4WD /Break	BKC BLS BXE	BVM6 05/04-
	2.0 FSi 4WD	BLX BVX	BVM6 05/04-12/05
	2.0 TDi 4WD	BKD	BVM6 05/04-
	3.2 FSi 4WD	BUB	BVM6 BVA6 10/05-



... Golf V 03-



2656049 Butée de suspension OE 1K0511353M <i>Shock bush</i>	2656051 Butée de suspension OE 1K0511353P <i>Shock bush</i>
 2 H 133 1.4i 16v./ Plus 11/03- 1.4 FSi 01/04-12/05 1.4 TSi /Plus /Break 04/06- 1.6i /Plus /Break 05/04- 1.6 FSi /Plus 11/03- 1.6 TDi Plus 1.9 TDi /Plus /Break 11/03- 2.0 FSi /Plus 05/04-05/06 2.0 SDi 05/04-12/06 2.0 TDi /Plus /Break 11/03-	 2 H 133 1.9 TDi 4WD 05/04-10/08 1.9 TDi 4WD Break 06/07-12/09 2.0 FSi 4WD 05/04-12/05 2.0 TDi 4WD 05/04-10/08

Eléments TRAIN ARRIERE <i>Rear axle parts</i> <i>Tren TRAS</i> <i>Elementy zawieszenia tylnego</i> <i>элементы задней оси.</i> 	9001786 Articulation essieu G/D inf. OE 1K0505553A <i>Lower L/R axle bush</i> Ø int. 12 Ø ext. 37 long. tube int. 50 ext. 28  1.4i 16v. BCA BUD 11/03- 1.4 FSi BKG BLN 11/03- 1.4 TSi 04/06- 1.6i BGU BSE 11/03- 1.6 FSi BAG BLF BLP 11/03- 1.6 TDi Plus 02/09- 1.9 TDi BKC/XE/LS/RU/XF 11/03- 2.0 FSi AXW BLR/LX/VY/VX/WA 11/03- 2.0 GTi AXX BYD 11/03- 2.0 SDi BDK 11/03- 2.0 TDi AZV BKD BMM/N 11/03- 2.0 TDi Plus 01/05- 3.2 FSi BUB 10/05-10/08
---	---

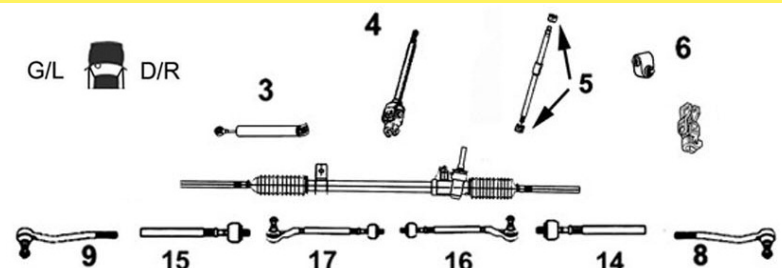
Golf VI 10/08- ...

Eléments DIRECTION <i>Steering parts</i> <i>Elementos Direcciones</i> <i>Elementy układ kierowniczy</i> <i>Элементы рулевой системы</i>	 <p style="text-align: center;">G/L D/R</p> <p style="text-align: center;">3 4 5 6</p> <p style="text-align: center;">9 15 17 16 14 8</p>
--	--

9006873 Axe de bielle G/D OE 1K0423810A <i>L/R axial joint</i>	14 Côté dir. M16x1.5 Côté rot. M16x1.5 long 310 mm 15 1.4i 10/08- 1.4 TSi 1.4 TSi Plus 05/06- 1.6 TDi /Plus 02/09- 2.0i Turbo 4WD 2.0 TSi GTi Turbo 10/08- 2.0 TDi
---	---

9006638 Rotule de direction G OE 1K0423811J <i>Left tie rod end</i>	9006637 Rotule de direction D OE 1K0423812J <i>Right tie rod end</i>
 9 M16 x 1.5 1.4i 1.4 TSi 1.6 TDi 10/09- 2.0i Turbo 4WD 2.0 TSi 2.0 TDi /4WD	 8 M16 x 1.5 1.4i 1.4 TSi 1.6i /Plus /Break 1.6 TDi 10/09- 2.0i Turbo 4WD 2.0 TSi 2.0 TDi /4WD

... Golf VI 10/08- ...

SASIC

VOLKSWAGEN



Barre stabilisatrice
 Stabilizer bar
 Barra estabilizadora
 Drażek stabilizatora
 стабилизатор поперечной устойчивости

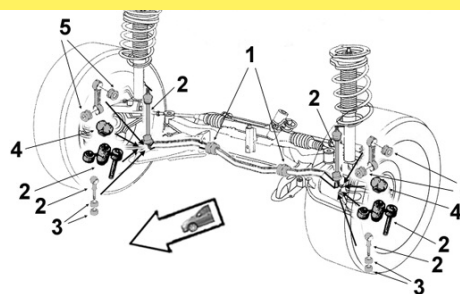

2306010 **Biellette barre stab.**
 OE 1K0411315P *Stabilizer bar stub axle*



2

1.4i /Break
 1.4 TSi /Break
 1.6 TDi /4WD /Break
 2.0i Turbo 4WD
 2.0 TSi
 2.0 TDi /4WD /Break



Eléments SUSPENSION
 Suspension parts
 Elementos suspensión
 Elementy zawieszenie
 Элементы подвески

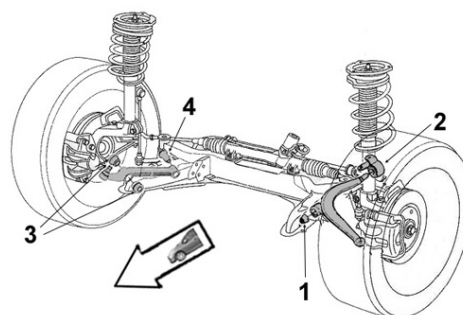

9001759 **Articulation AV**
 OE 1K0407182 *Front bush*



1 Ø int.12 Ø ext.40 coll.48 long. tube int.54 ext.33 ep. coll.6

1.4i /Break
 1.4 TSi /Break
 1.6 TDi /4WD /Break
 2.0i Turbo 4WD
 2.0 TSi
 2.0 TDi /4WD /Break

2256003 **Articulation AR G**
 OE 1K0199231J *Left rear bush*



2

1.4i /Break
 1.4 TSi /Break
 1.6 TDi /Break
 2.0i Turbo 4WD
 2.0 TSi
 2.0 TDi /4WD /Break

2256002 **Articulation AR D**
 OE 1K0199232J *Right rear bush*



2

1.4i /Break
 1.4 TSi /Break
 1.6 TDi /Break
 2.0i Turbo 4WD
 2.0 TSi
 2.0 TDi /4WD /Break

... Golf VI 10/08- ...

Bras & Triangle de suspension

Control arm
Brazo y triángulo
Wahacz
Рычаг подвески

G/L  D/R

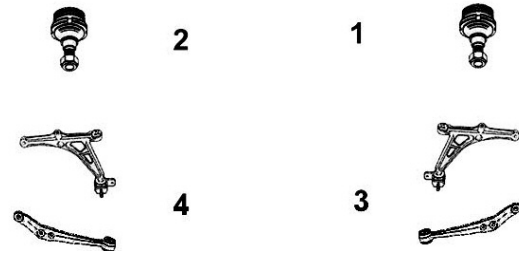

7476018

Triangle de susp. G

OE 1K0407151AC

Left track control arm

4 Fonte Iron Sans rotule Without ball joint



1.4 TSi
1.6 TDi
2.0i Turbo 4WD
2.0 TSi GTi
2.0 TDi /4WD

7476017

Triangle de susp. D

OE 1K0407152AC

Right track control arm

3 Fonte Iron Sans rotule Without ball joint



1.4 TSi
1.6 TDi
2.0i Turbo 4WD
2.0 TSi GTi
2.0 TDi /4WD

7476128

Triangle de susp. G

OE 1K0407151AC+1K0407365C *Left track control arm*

4 Avec rotule With ball joint

NEW



1.4 TSi
1.6 TDi
2.0i Turbo 4WD
2.0 TSi GTi
2.0 TDi /4WD

7476127

Triangle de susp. D

OE 1K0407152M+1K0407366C *Right track control arm*

3 Avec rotule With ball joint

NEW



1.4 TSi
1.6 TDi
2.0i Turbo 4WD
2.0 TSi GTi
2.0 TDi /4WD

9005570

Rotule de susp. inf. G

OE 1K0407365C

Left lower susp. ball joint

2

1.4i
1.4 TSi
1.6 TDi
1.6 TDi Plus
2.0i Turbo 4WD
2.0 TSi GTi
2.0 TDi /4WD



10/08-

9005569

Rotule de susp. inf. D

OE 1K0407366C

Right lower susp. ball joint

1

1.4i
1.4 TSi
1.6 TDi
1.6 TDi Plus
2.0i Turbo 4WD
2.0 TSi GTi
2.0 TDi /4WD



10/08-



Support d'amortisseur

Suspension mounting
Soporte amortiguador
Poduszka amortyzatora
Опора амортизатора

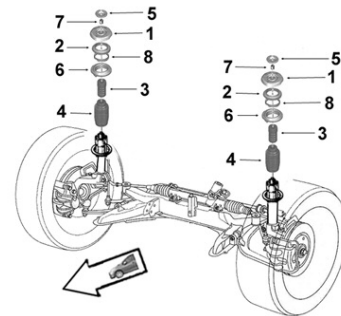

9005622

Support suspension G/D

OE 1K0412331B

L/R suspension mounting

1

1.4i
1.4 TSi
1.6 TDi
2.0i Turbo 4WD
2.0 TSi GTi
2.0 TDi /4WD

CDLF



2656004

Butée de suspension

OE 1K0412303E

Shock bush

3

H55

1.4i
1.4 TSi
1.6 TDi
2.0i Turbo 4WD
2.0 TSi GTi
2.0 TDi /4WD



... Golf VI 10/08-



VOLKSWAGEN



Support d'amortisseur
Suspension mounting
Soporte amortiguador
Poduszka amortyzatora
Опора амортизатора

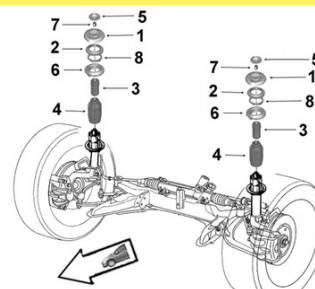

2656052 **Butée de suspension**

OE 1K0412303B *Shock bush*



3 H70
 1.4i
 1.4 TSi /Break
 1.6 TDi /Break
 2.0 TSi
 2.0 TDi 4WD
 02/09-

2656053 **Protecteur amortisseur G/D**

OE 6N0413175A *L/R shock absorber protector*



4 H206
 1.4i
 1.4 TSi /Break
 1.6 TDi /Break
 2.0i Turbo
 2.0 TSi GTi
 2.0 TDi /4WD /Break
 02/09-
 10/09-



Barre stabilisatrice
Stabilizer bar
Barra estabilizadora
Drążek stabilizatora
стабилизатор поперечной устойчивости

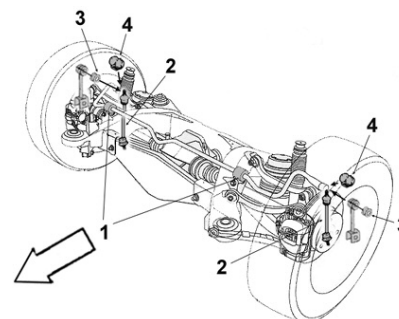

9005094 **Biellette barre stab.**

OE 1K0505465K *Stabilizer bar stub axle*



2
 1.4i /Break
 1.4 TSi /Break
 1.6 TDi /4WD /Break
 2.0i Turbo 4WD
 2.0 TSi
 2.0 TDi /4WD /Break

9001739 **Palier de barre milieu**

OE 1K0511327AP *Middle bar main bearing*



1 Barre Ø 18.5
 1.4i
 1.4 TSi
 1.6 TDi
 2.0i Turbo 4WD
 2.0 TSi
 2.0 TDi /4WD

2306013 **Palier de barre milieu**

OE 1K0511327AQ *Middle bar main bearing*



1 Barre Ø 19.6
Equipement OBD
 1.4i /Break / TSi /Break
 1.6 TDi /4WD /Break
 2.0i Turbo 4WD
 2.0 TSi
 2.0 TDi /4WD /Break

9001737 **Palier de barre milieu**

OE 1K0511327AR *Middle bar main bearing*



1 Barre Ø 20.7
Equipement OBE
 1.4i /Break
 1.4 TSi /Break
 1.6 TDi /4WD /Break
 2.0i Turbo 4WD
 2.0 TSi
 2.0 TDi /4WD /Break

2306014 **Palier de barre milieu**

OE 1K0511327AS *Middle bar main bearing*



1 Barre Ø 21.7
Equipements OBF OBE OBM
 1.4i /Break
 1.4 TSi /Break
 1.6 TDi /4WD /Break
 2.0i Turbo 4WD
 2.0 TSi
 2.0 TDi /4WD /Break

... Golf VI 10/08-



Support d'amortisseur
Suspension mounting
Soporte amortiguador
Poduszka amortyzatora
Опора амортизатора

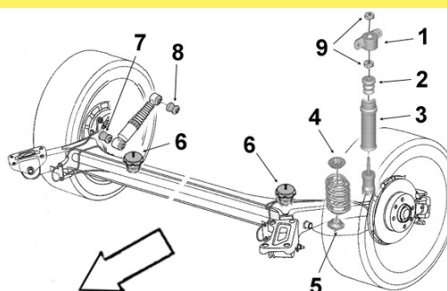

VOLKSWAGEN



2656059

Support suspension

OE 1K0513353R

Suspension mounting



1

1.6 TDi FAP SW 4WD
 105hp 77kw 01/10-
 2.0 TDi 4WD 140hp 103kw
 Berline 10/09-
 2.0 TDi 4WD FAP 140hp 103kw
 Berline 10/08-

2656049

Butée de suspension

OE 1K0511353M

Shock bush



2

H 133

1.4i
 1.4 TSi /Break
 1.6 TDi /Break
 2.0 TSi GTi
 2.0 TDi /Break

2656051

Butée de suspension

OE 1K0511353P

Shock bush



2

H 133

1.6 TDi 4WD Break 01/10-
 2.0 Turbo 4WD 10/09-
 2.0 TDi 4WD 10/08-

Eléments TRAIN ARRIERE

Rear axle parts

Tren TRAS

Elementy zawieszenia tylnego

Элементы задней оси.



9001786

Articulation essieu G/D inf.

OE 1K0505553A

Lower L/R axle bush



Ø int. 12 Ø ext. 37 long. tube int. 50 ext. 28

1.4i /Break
 1.4 TSi /Break
 1.6 TDi /4WD /Break
 2.0 TSi
 2.0 TDi /4WD /Break

Golf VII 11/12- ...

Eléments DIRECTION

Steering parts

Elementos Direcciones

Elementy układ kierowniczy

Элементы рулевой системы

G/L D/R

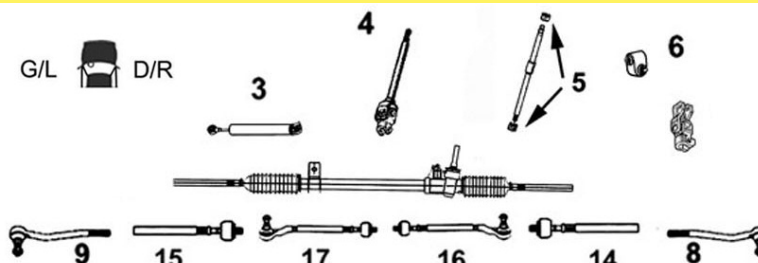

9006873

Axe de bielle G/D

OE 1K0423810A

L/R axial joint



14

15

Côté dir. M16x1.5 Côté rot. M16x1.5 long 310 mm

1.2 TSi
 1.4 TSi
 1.6 TDi
 2.0 TDi

... Golf VII 11/12-

Eléments DIRECTION
Steering parts
Elementos Direcciones
Elementy układ kierowniczy
Элементы рулевой системы

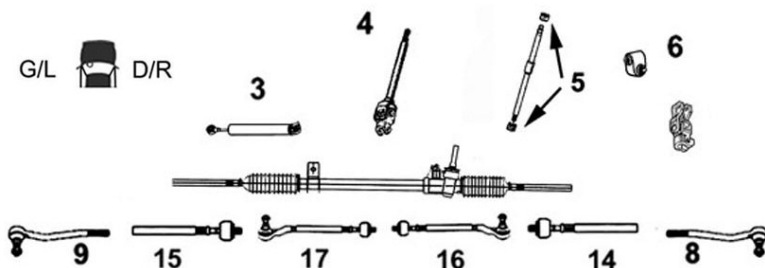

9006638

Rotule de direction G

OE 1K0423811J

Left tie rod end



9 M16 x 1.5

1.2 TSi	10/12-
1.4 TSi	10/12-
1.6 TDi FAP	10/12-
2.0 TDi FAP	10/12-

9006637

Rotule de direction D

OE 1K0423812J

Right tie rod end



8 M16 x 1.5

1.2 TSi	10/12-
1.4 TSi	10/12-
1.6 TDi FAP	10/12-
2.0 TDi FAP	10/12-



Support d'amortisseur

Suspension mounting
Soporte amortiguador
Poduszka amortyzatora
Опора амортизатора

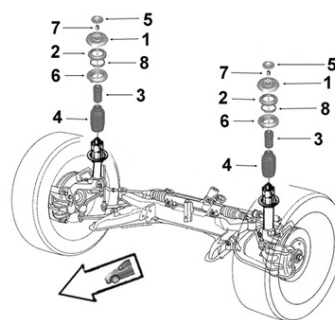

2656004

Butée de suspension

OE 1K0412303E

Shock bush



3 H55

1.2 TSi Berline
 1.4 TSi Berline

2656052

Butée de suspension

OE 1K0412303B

Shock bush



3 H70

1.2 TSi Berline
 1.4 TSi Berline

Golf III Cabriolet ...

Eléments DIRECTION
Steering parts
Elementos Direcciones
Elementy układ kierowniczy
Элементы рулевой системы

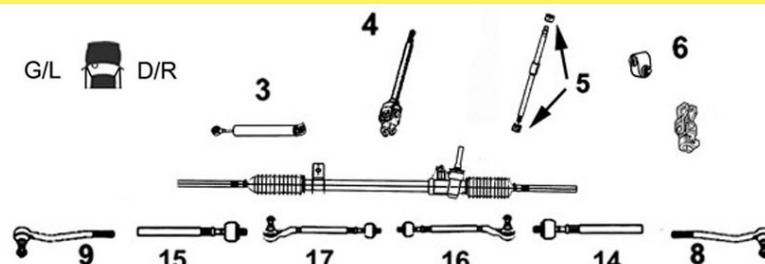

9006218

Axe de bielle G/D



Part/oe 1H0422803A *L/R axial joint*



14 Côté dir. M14x1.5 Côté rot. M14x1.5 long 371 mm
15

1.8i
 1.9 TDi
 2.0i

Golf III Cabriolet ...

9006380 OE 3A0422811	Rotule de direction G <i>Left tie rod end</i>	9006381 OE 3A0422812	Rotule de direction D <i>Right tie rod end</i>
	9 M14 x 1.5 1.8i 1.9 TDi 2.0i		8 M14 x 1.5 1.8i 1.9 TDi 2.0i



Barre stabilisatrice
 Stabilizer bar
 Barra estabilizadora
 Drażek stabilizatora
 стабилизатор поперечной устойчивости

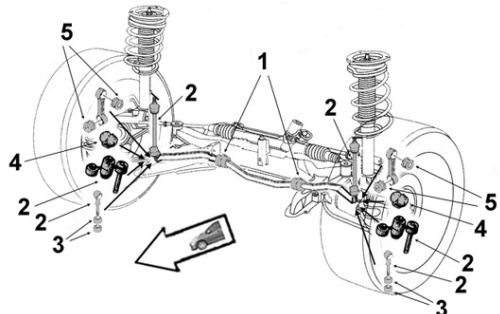



9005050 OE 191411315B	Biellette barre stab. <i>Stabilizer bar stub axle</i>
	2 Ø int.17 1.8i 1.9 TDi

Bras & Triangle de suspension
 Control arm
 Brazo y triángulo
 Wahacz
 Рычаг подвески

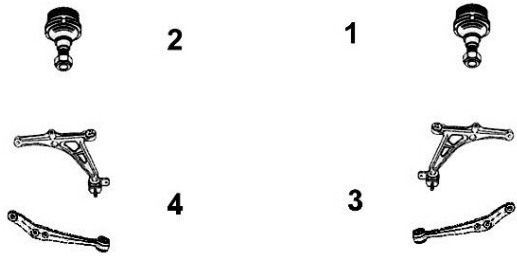
G/L  D/R



7476109 OE 1H0407151+357407365	Triangle de susp. G <i>Left track control arm</i>	7476110 OE 1H0407151+357407365	Triangle de susp. D <i>Right track control arm</i>
	4 Avec rotule With ball joint Ø 19 1.8i 1.9 TDi		3 Avec rotule With ball joint Ø 19 1.8i 1.9 TDi

9005134 OE 1H0407151	Triangle de susp. G/D <i>L/R track control arm</i>	9005260 OE 357407365	Rotule de susp. inf. G/D <i>L/R lower suspension ball joint</i>
	3/4 Sans rotule Without tie rod end 1.8i 1.9 TDi		1/2 Ø 19 Cylindrique 1.8i 1.9 TDi

... Golf III Cabriolet



Support d'amortisseur
Suspension mounting
Soporte amortiguador
Poduszka amortyzatora
Опора амортизатора

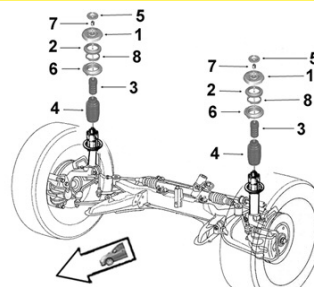

9001709

Support suspension G/D

OE 357412331A

L/R suspension mounting



1

1.8i
 1.9 TDi
 2.0i

9005327

Protecteur amortisseur G/D

OE 357413175A

L/R shock absorber protector



4

H221.5

1.8i
 1.9 TDi
 2.0i



Support d'amortisseur
Suspension mounting
Soporte amortiguador
Poduszka amortyzatora
Опора амортизатора

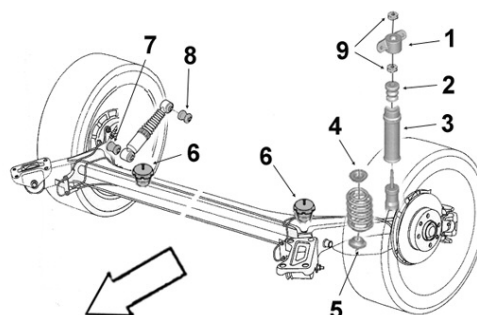

9005361

Butée de suspension AR G/D

OE 191512131B

L/R rear suspension bush



2

H146

1.8i
 1.9 TDi
 2.0i

Golf IV Cabriolet ...

Eléments DIRECTION

Steering parts

Elementos Direcciones

Elementy uklad kierowniczy

Элементы рулевой системы

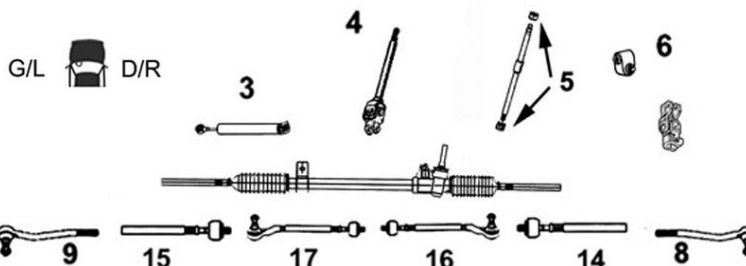

9006218

Axe de bielle G/D

Part/oe 1H0422803A

L/R axial joint



14
15

Côté dir. M14x1.5 Côté rot. M14x1.5 long 371 mm

1.6i
 1.8i
 2.0i

... Golf IV Cabriolet ...

9006380 Rotule de direction G OE 3A0422811 <i>Left tie rod end</i>	9006381 Rotule de direction D OE 3A0422812 <i>Right tie rod end</i>
 9 M14x1.5 1.6i 1.8i 2.0i	 8 M14x1.5 1.6i 1.8i 2.0i



Barre stabilisatrice
Stabilizer bar
Barra estabilizadora
Drążek stabilizatora
 стабилизатор поперечной устойчивости

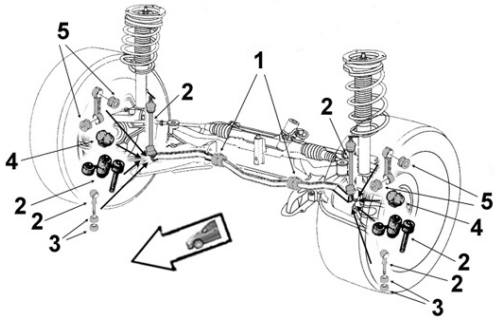

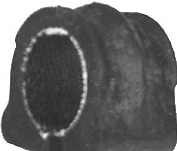

9005050 Biellette barre stab. OE 191411315B <i>Stabilizer bar stub axle</i>
 2 Ø int.17 1.6i 1.8i 2.0i

9001730 Palier de barre milieu OE 1J0411314R <i>Middle bar main bearing</i>	9001732 Palier de barre milieu OE 1J0411314T <i>Middle bar main bearing</i>
 1 Barre Ø 21 1.6i 1.8i 2.0i	 1 Barre Ø 23 1.6i 1.8i 2.0i

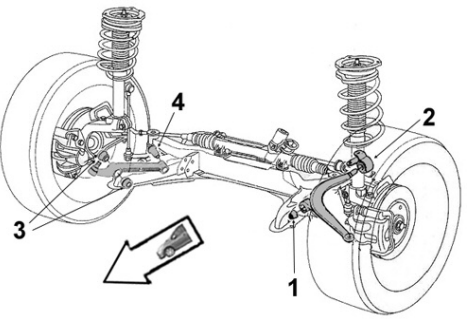

Eléments SUSPENSION
Suspension parts
Elementos suspensión
Elementy zawieszenie
 Элементы подвески



9001520 Articulation AR OE 191407181D <i>Rear bush</i>	9001523 Articulation AV OE 357407182 <i>Front bush</i>
 2 Ø int.17 Ø ext.60.5 long. tube int.41 ext.24.5 1.6i 1.8i 2.0i	 1 Ø int.12 Ø ext.33 coll.36 long. tube int.54 ext.29 ep. coll.5 1.6i 1.8i 2.0i

... Golf IV Cabriolet ...

VOLKSWAGEN SASIC

Bras & Triangle de suspension

Control arm
Brazo y triángulo
Wahacz
Рычаг подвески

G/L  D/R

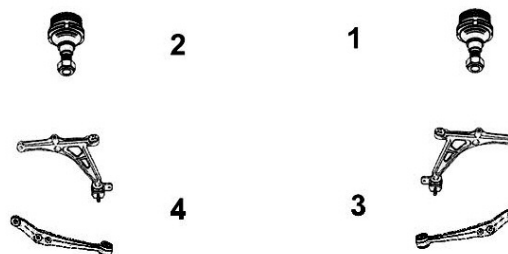

7476109

Triangle de susp. G

OE 1H0407151+357407365 *Left track control arm*

NEW



4 Avec rotule *With ball joint Ø 19*

1.6i
1.8i
2.0i

7476110

Triangle de susp. D

OE 1H0407151+357407365 *Right track control arm*

NEW



3 Avec rotule *With ball joint Ø 19*

1.6i
1.8i
2.0i

9005134

Triangle de susp. G/D

OE 1H0407151 *L/R track control arm*



3 Sans rotule *Without tie rod end*

1.6i
1.8i
2.0i

9005260

Rotule de susp. inf. G/D

OE 357407365 *L/R lower suspension ball joint*



1 Ø 19 *Cylindrique*

1.6i
1.8i
2.0i



Support d'amortisseur

Suspension mounting
Soporte amortiguador
Poduszka amortyzatora
Опора амортизатора

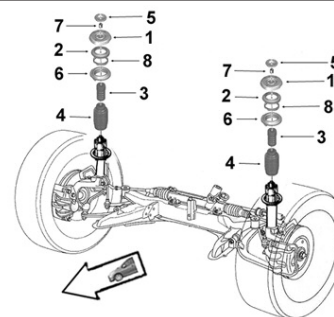

9001709

Support suspension G/D

OE 357412331A *L/R suspension mounting*



1

1.6i
1.8i
2.0i

9005352

Butée à billes G/D

OE 1J0412249 *L/R ball bearing*



2

1.6i
1.8i
2.0i

9005327

Protecteur amortisseur G/D

OE 357413175A *L/R shock absorber protector*



4 H221.5

1.6i
1.8i
2.0i

... Golf IV Cabriolet

Eléments TRAIN ARRIERE

Rear axle parts

Tren TRAS

Elementy zawieszenia tylnego

элементы задней оси.



9001705

OE 1H0501541A

Articulation essieu AR G/D

L/R Rear axle bush



Ø int.12 Ø ext.56.5 coll.74
long. tube int.90 ext.51 ep. coll.3

1.6i
1.8i
2.0i

Jetta ...

Eléments DIRECTION

Steering parts

Elementos Direcciones

Elementy uklad kierowniczy

Элементы рулевой системы

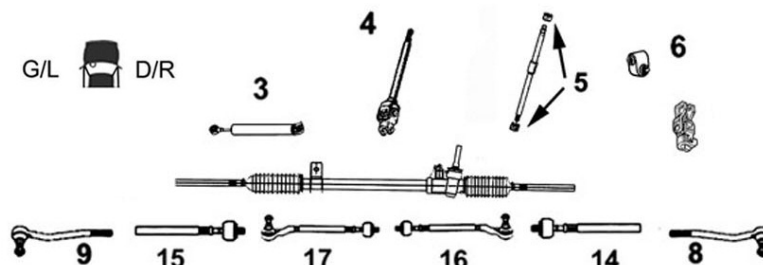

9006209

OE 171419821

Axe de bielle G/D

L/R axial joint



14 Côté dir. M22x1.5 Côté rot. M14x1.5
15 long 342 mm

TT /all models DNA 08/79-10/83

9006210

Part/oe 191419803

Axe de bielle G/D

L/R axial joint



14 Côté dir. M22x1.5 Côté rot. M14x1.5
15 long 368 mm

TT /all models DNA 12/83-12/92

9006217

Part/oe 191422803A

Axe de bielle G/D

L/R axial joint



14 Côté dir. M14x1.5 Côté rot. M14x1.5
15 long 347 mm

TT /all models DA 12/83-12/92

9006873

OE 1K0423810A

Axe de bielle G/D

L/R axial joint



14 Côté dir. M16x1.5 Côté rot. M16x1.5
15 long 310 mm

1.2 TSi 01/11-
1.4 TSi 07/06-
1.6 07/06-
1.6 FSi 09/05-
1.6 TDi 06/09-
1.9 TDi 08/05-
2.0 FSi 08/05-
2.0 TDi 08/05-

9006383

OE 3A0422811A

Rotule de direction G/D

L/R tie rod end



8 M14 x 1.5
9

TT /all models

08/79-10/83

9006380

OE 191419811

Rotule de direction G

Left tie rod end



9 M14 x 1.5

TT /all models DNA DA 12/83-12/92

9006381

OE 191419812

Rotule de direction D

Right tie rod end



8 M14 x 1.5

TT /all models DNA DA 12/83-12/92

... Jetta ...

Eléments DIRECTION

Steering parts
Elementos Direcciones
Elementy układ kierowniczy
Элементы рулевой системы

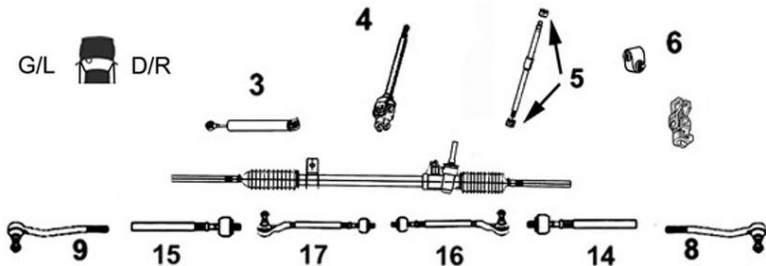

9006638 Rotule de direction G
OE 1K0423811J *Left tie rod end*



9 M16 x 1.5	
1.2 TSi	01/11-
1.4 TSi	12/06-12/09
1.6i	09/05-01/08
1.6 FSi	09/05-12/07
1.6 TDi	05/09-
1.9 TDi	09/05-12/09
2.0 FSi	09/05-12/06
2.0 TDi	09/05-

9006637 Rotule de direction D
OE 1K0423812J *Right tie rod end*



8 M16 x 1.5	
1.2 TSi	01/11-
1.4 TSi	12/06-12/09
1.6i	09/05-01/08
1.6 FSi	09/05-12/07
1.6 TDi	05/09-
1.9 TDi	09/05-12/09
2.0 FSi	09/05-12/06
2.0 TDi	09/05-



Barre stabilisatrice
Stabilizer bar
Barra estabilizadora
Drażek stabilizatora
стабилизатор поперечной устойчивости

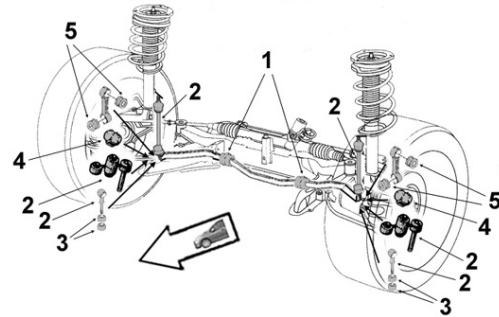

9005050 Bielle barre stab.
OE 191411315B *Stabilizer bar stub axle*



2 Ø int.17	
1.3	08/83-11/92
1.6	08/83-11/92
1.6 D	08/83-11/92
1.6 TD	08/83-11/92
1.8	08/83-11/92
1.8 GTi /16v.	08/83-11/92

2306010 Bielle barre stab.
OE 1K0411315P *Stabilizer bar stub axle*



2	
1.4 TSi	07/06-
1.6i	10/05-
1.6 FSi	09/05-
1.6 TDi	06/09-
1.9 TDi	08/05-
2.0 FSi	08/05-
2.0 TDi	08/05-

9001522 Palier de barre milieu
OE 191411314 *Middle bar main bearing*



1 Barre Ø 17	
1.05	08/83-10/91
1.3	08/83-10/91
1.6	08/83-10/91
1.6 D	08/83-10/91
1.6 TD	08/83-10/91
1.8	08/83-10/91
1.8i 16v.	08/83-10/91

... Jetta ...



Eléments SUSPENSION

Suspension parts
Elementos suspensión
Elementy zawieszenie
Элементы подвески

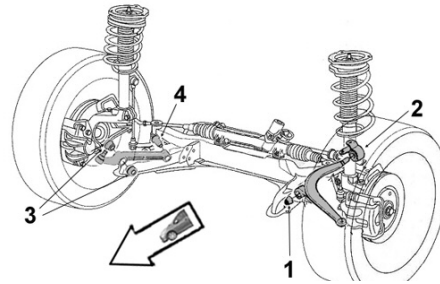

VOLKSWAGEN



9001520 OE 191407181D	Articulation AR <i>Rear bush</i>	9001523 OE 357407182	Articulation AV <i>Front bush</i>
	2 Ø int.17 Ø ext.60.5 long. tube int.41 ext.24.5 1.05 08/83-11/92 1.3 08/83-11/92 1.6 08/83-11/92 1.6 D 08/83-11/92 1.6 TD 08/83-11/92 1.8 08/83-11/92 1.8i 16v. 08/83-11/92		1 Ø int.12 Ø ext.33 coll.36 long. tube int.54 ext.29 ep. coll.5 1.3 08/83-11/92 1.6 08/83-11/92 1.6 D 08/83-11/92 1.6 TD 08/83-11/92 1.8 08/83-11/92 1.8 GTi 08/83-11/92 1.8 GTi 16v. 08/83-11/92
9001759 OE 1K0407182	Articulation AV <i>Front bush</i>		
	1 Ø int.12 Ø ext.40 coll.48 long. tube int.54 ext.33 ep. coll.6 1.2 TSi 01/11- 1.6 TDi 01/11- 2.0 TDi 01/11-		
Bras & Triangle de suspension <i>Control arm</i> <i>Brazo y triángulo</i> <i>Wahacz</i> <i>Рычаг подвески</i>			
		G/L  D/R	
		 2  4 	 1  3 
9005139 OE 171407153D	Triangle de susp. G/D <i>L/R track control arm</i>	9005133 OE 191407151B	Triangle de susp. G/D <i>L/R track control arm</i>
	3 4 Sans rotule Without tie rod end TT /all models 08/79-10/83		3 4 Sans rotule Without tie rod end TT /all models 12/83-12/92
7476102 OE 171407153D+171407365G	Triangle de susp. G <i>Left track control arm</i>	7476103 OE 171407153D+171407365G	Triangle de susp. D <i>Right track control arm</i>
	4 Avec rotule With ball joint Ø 17 TT /all models 08/79-10/83		3 Avec rotule With ball joint Ø 17 TT /all models 08/79-10/83







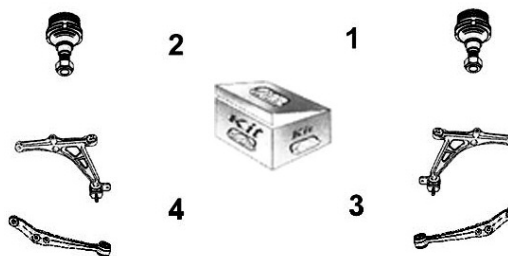

... Jetta ...

Bras & Triangle de suspension









Control arm
Brazo y triángulo
Wahacz
Рычаг подвески

G/L  D/R

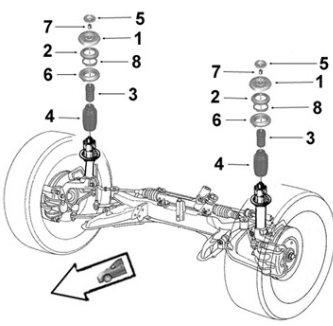

7476107	Triangle de susp. G OE 191407151B+357407365 <i>Left track control arm</i>	7476108	Triangle de susp. D OE 191407151B+357407365 <i>Right track control arm</i>
NEW 	4 Avec rotule With ball joint Ø 19 TT /all models 12/83-12/92	NEW 	3 Avec rotule With ball joint Ø 19 TT /all models 12/83-12/92
9005757	Triangle de susp. G OE 1K0407151AH <i>Left track control arm</i>	9005756	Triangle de susp. D OE 1K0407152AH <i>Right track control arm</i>
	4 acier steel 1.4 TSi 12/06-12/09 1.6i 09/05-01/08 1.6 FSi 09/05-12/07 1.6 TDi 05/09-12/09 1.9 TDi 09/05-12/09 2.0 FSi 09/05-12/06 2.0 TDi 09/05-12/09		3 acier steel 1.4 TSi 12/06-12/09 1.6i 09/05-01/08 1.6 FSi 09/05-12/07 1.6 TDi 05/09-12/09 1.9 TDi 09/05-12/09 2.0 FSi 09/05-12/06 2.0 TDi 09/05-12/09
9005262	Rotule de susp. inf. G/D OE 171407365G <i>L/R lower suspension ball joint</i>	9005261	Rotule de susp. inf. G/D OE 191407365 <i>L/R lower suspension ball joint</i>
	1 Ø 17 2 TT /all models Ch- 1783173584 10/77-10/83		1 Ø 17 2 TT /all models 12/83-07/87
9005260	Rotule de susp. inf. G/D OE 357407365 <i>L/R lower suspension ball joint</i>		
	2 1 Ø 19 Cylindrique TT /all models 08/87-12/92		
9005570	Rotule de susp. inf. G OE 1K0407365C <i>Left lower suspension ball joint</i>	9005569	Rotule de susp. inf. D OE 1K0407366C <i>Right lower suspension ball joint</i>
	2 1.2 TSi 02/11- 1.4 TSi 07/06- 1.6 10/05- 1.6 FSi 09/05- 1.6 TDi 06/09- 1.9 TDi 08/05- 2.0 FSi 08/05- 2.0 TDi 08/05-		1 1.2 TSi 02/11- 1.4 TSi 07/06- 1.6 10/05- 1.6 FSi 09/05- 1.6 TDi 06/09- 1.9 TDi 08/05- 2.0 FSi 08/05- 2.0 TDi 08/05-

... Jetta ...

9155490		Kit rép. train AV	
OE -		<i>Front axle repair kit</i>	
		Sans visserie <i>Without screws and bolts</i> Barre Ø 17	
TT /all models		12/83-12/92	
 <p>Support d'amortisseur <i>Suspension mounting</i> <i>Soporte amortiguador</i> <i>Poduszka amortyzatora</i> <i>Опора амортизатора</i></p>			
9005604 OE 191412329		Support suspension AV G/D <i>L/R front susp. mounting</i>	
		1 Avec roulement <i>With bearing</i>	
1.05 08/83- 1.3 08/83- 1.6 08/83- 1.6 D 08/83- 1.6 TD 08/83- 1.8 08/83- 1.8i 16v. 08/83-		9005622 OE 1K0412331B	
		Support suspension G/D <i>L/R suspension mounting</i>	
			
		1	
		1.2 TSi 01/11- 1.6 TDi 01/11- 2.0 TDi 01/11-	
9005362 OE 357412303E		Butée de suspension G/D <i>L/R suspension bush</i>	
		3 H84	
1.05 08/83-11/92 1.3 08/83-11/92 1.6 08/83-11/92 1.6 D 08/83-11/92 1.6 TD 08/83-11/92 1.8 08/83-11/92 1.8i 16v. 08/83-11/92			
2656052 OE 1K0412303B		Butée de suspension <i>Shock bush</i>	
		3 H70	
1.2 TSi 01/11- 1.4 TSi 12/06-12/09 1.6i 09/05-01/08 1.6 FSi 09/05-12/07 1.6 TDi 09/05- 1.9 TDi 09/05-12/09 2.0 FSi 09/05-12/06 2.0 TDi 09/05-			
2656053 OE 6N0413175A		Protecteur amortisseur G/D <i>L/R shock absorber protector</i>	
		4 H206	
1.2 TSi 01/11- 1.4 TSi 12/06-12/09 1.6i 09/05-01/08 1.6 FSi 09/05-12/07 1.6 TDi 05/09- 1.9 TDi 09/05-12/09 2.0 FSi 09/05-12/06 2.0 TDi 09/05-			

... Jetta ...



Barre stabilisatrice
Stabilizer bar
Barra estabilizadora
Drążek stabilizatora
 стабилизатор поперечной устойчивости

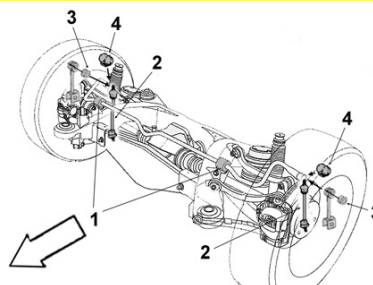

9005094 **Biellette barre stab.**
 OE 1K0505465K *Stabilizer bar stub axle*



2	1.2 TSi 1.4 TSi 1.6i 1.6 FSi 1.6 TDi 1.9 TDi 2.0 FSi 2.0 TDi	01/11- 07/06- 10/05- 09/05- 06/09- 08/05- 08/05- 08/05-
----------	---	--



Support d'amortisseur
Suspension mounting
Soporte amortiguador
Poduszka amortyzatora
 Опора амортизатора

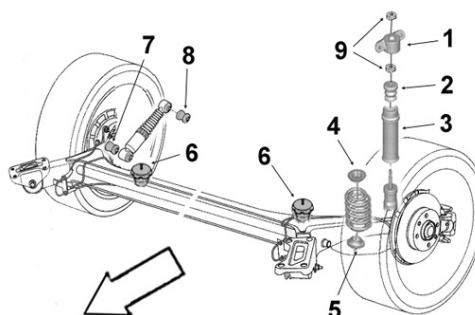

2656059 **Support suspension**
 OE 1K0513353R *Suspension mounting*



1	1.2 TSi BVM6 01/11- 1.6 TDi BVM5 /rob.7 01/11- 2.0 TDi BVM6/ rob.6 01/11-
----------	---

9005361 **Butée de suspension AR G/D**
 OE 191512131B *L/R rear suspension bush*



2	H146	
	1.05	-10/91
	1.3	-10/91
	1.6	-10/91
	1.6 D	-10/91
	1.6 TD	-10/91
	1.8	-10/91
	1.8i 16v.	-10/91

2656049 **Butée de suspension**
 OE 1K0511353M *Shock bush*



2	H 133	
	1.2 TSi	01/11-
	1.4 TSi	12/06-12/09
	1.6i	09/05-01/08
	1.6 FSi	09/05-12/07
	1.6 TDi	05/09-
	1.9 TDi	09/05-12/09
	2.0 FSi	09/05-12/06
	2.0 TDi	09/05-

9005368 **Protecteur amortisseur G/D**
 OE 191513425 *L/R shock absorber protector*



3	H90	
	1.05	08/83-11/92
	1.3	08/83-11/92
	1.6	08/83-11/92
	1.6 D	08/83-11/92
	1.6 TD	08/83-11/92
	1.8	08/83-11/92
	1.8i 16v.	08/83-11/92

... Jetta

Eléments TRAIN ARRIERE

Rear axle parts

Tren TRAS



Elementy zawieszenia tylnego

элементы задней оси.



VOLKSWAGEN



9001704 OE 191501541	Articulation essieu AR G/D <i>L/R Rear axle bush</i>	9001786 OE 1K0505553A	Articulation essieu G/D inf. <i>Lower L/R axle bush</i>
	Ø int.12 Ø ext.44.5 coll.72 long. tube int.90 ext.58 ep. coll.2.5 1.05 -10/91 1.3 -10/91 1.6 -10/91 1.6 D TD -10/91 1.8 -10/91 1.8i 16v. -10/91		Ø int. 12 Ø ext. 37 long. tube int. 50 ext. 28 1.2 TSi 01/11- 1.6 TDi 01/11- 2.0 TDi 01/11-

Lupo ...

Eléments DIRECTION





Steering parts

Elementos Direcciones

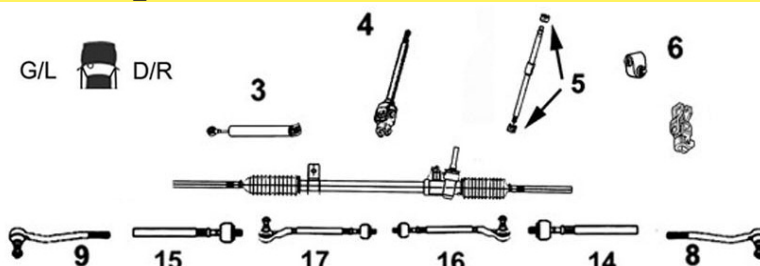
Elementy układ kierowniczy

Элементы рулевой системы



9006250 Part/oe 6X0419803A	Axe de bielle G/D <i>L/R axial joint</i>	9006251 Part/oe 6X0422804	Axe de bielle G/D <i>L/R axial joint</i>
	14 Côté dir. M22x1.5 Côté rot. M14x1.5 15 long 330 mm DNA 1.0i 1.4i 16v.		14 Côté dir. M14x1.5 Côté rot. M14x1.5 15 long 295 mm DA 1.0i 1.4 1.4i 16v. 1.6 GTi 1.7 SDi
9006869 Part/oe 6N0422804C	Axe de bielle G/D <i>L/R axial joint</i>		
	14 Côté dir. M14x1.5 Côté rot. M14x1.5 long 292 mm 15 DA 1.2 TDi 1.4i 16v.		
9006619 OE 6N0419811	Rotule de direction G <i>Left tie rod end</i>	9006618 OE 6N0419812	Rotule de direction D <i>Right tie rod end</i>
	9 M14 x 1.5 DNA 1.0i 1.4i 16v.		8 M14 x 1.5 DNA 1.0i 1.4i 16v.

... Lupo ...

Eléments DIRECTION
 Steering parts
 Elementos Direcciones
 Elementy układ kierowniczy
 Элементы рулевой системы

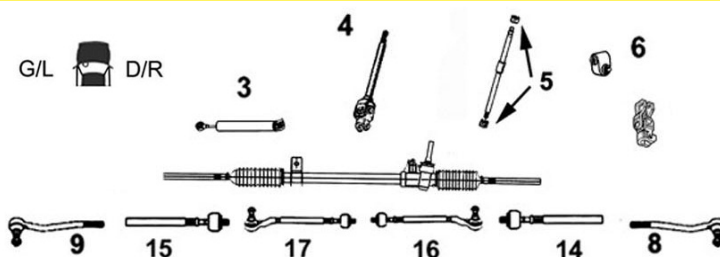

9006628 Rotule de direction G

OE 6X0422811

Left tie rod end



9	M14 x 1.5
1.0i	DA
1.2 TDi	
1.4	DA
1.4i 16v.	DA
1.4 TDi	
1.6 GTi	DA
1.7 SDi	DA

9006629 Rotule de direction D

OE 6X0422812

Right tie rod end



8	M14 x 1.5
1.0i	DA
1.2 TDi	
1.4	DA
1.4i 16v.	DA
1.4 TDi	
1.6 GTi	DA
1.7 SDi	DA



Barre stabilisatrice
 Stabilizer bar
 Barra estabilizadora
 Drażek stabilizatora
 стабилизатор поперечной устойчивости

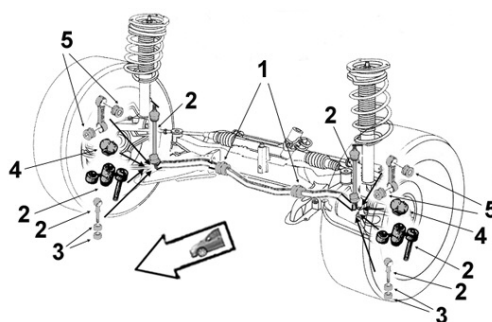

9005080 Bielle barre stab.

OE 6N0411315

Stabilizer bar stub axle



2	Ø 18 Axe fileté M 8 x 1.25
1.0i	10/98-
1.2 TDi	10/98-
1.4i	10/00-
1.4i 16v.	10/98-
1.4 TDi	09/99-06/05
1.6 GTi 16v.	04/01-06/05
1.7 SDi	10/98-

2306001 Bielle barre stab.

OE 6N0411315D

Stabilizer bar stub axle



2	Ø 20 Axe fileté M 8 x 1.25
1.0i	10/98-09/00
1.4i	10/00-06/05
1.4i 16v.	10/98-06/05
1.4 TDi	09/99-06/05
1.6 GTi 16v.	04/01-06/05
1.7 SDi	10/98-06/05

2306020 Palier de barre milieu

OE 6X0411313

Middle bar main bearing



1	Barre Ø 18	
1.0i	BVM	10/98-09/00
1.4i	BVM	10/00-06/05
1.4i 16v.		10/98-06/05
1.4 TDi	BVM	09/99-06/05
1.6 GTi 16v.	BVM	04/01-06/05
1.7 SDi	BVM	10/98-06/05

2306021 Palier de barre milieu

OE 6X0411313A

Middle bar main bearing



1	Barre Ø 20	
1.0i	BVM	10/98-09/00
1.4i	BVM	10/00-06/05
1.4i 16v.		07/99-07/05
1.4 TDi	BVM	09/99-06/05
1.6 GTi 16v.	BVM	04/01-06/05
1.7 SDi	BVM	10/98-06/05

... Lupo ...



Eléments SUSPENSION

Suspension parts

Elementos suspensión



Elementy zawieszenie

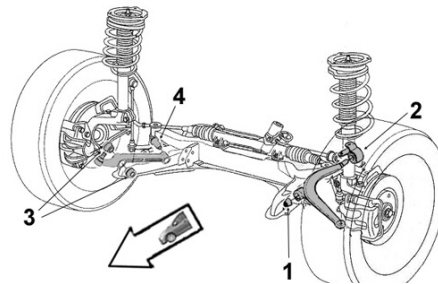



Элементы подвески





VOLKSWAGEN





2256008 OE 6N0407182	Articulation AV <i>Front bush</i>	9001692 OE 6N0407181	Articulation AR <i>Rear bush</i>
	1 Ø int. 10 Ø ext. 28 Coll. 34 long. tube int. 47 ext. 25 1.0 09/98-07/05 1.4i 10/00-07/05 1.4i 16v. 09/98-07/05 1.4 FSi 02/01-07/05 1.4 TDi 01/99-07/05 1.6 GTi 09/00-07/05 1.7 SDi 09/98-07/05		2 Ø int. 17 Ø ext. 59.5 long. tube int. 46 ext. 23.5 1.0i 10/98- 1.2 TDi 09/99- 1.4i 10/00- 1.4i 16v. 10/98- 1.4 TDi 09/99- 1.6 GTi 04/01- 1.7 SDi 10/98-

Bras & Triangle de suspension <i>Control arm</i> <i>Brazo y triángulo</i> <i>Wahacz</i> <i>Рычаг подвески</i>	G/L  D/R	 2	1 
		 4	 3

9005138 OE 6N0407151B	Triangle de susp. G/D <i>L/R track control arm</i>
	3 Sans rotule <i>Without tie rod end</i> 4 1.0i 1.4i 1.4i 16v. 1.4 TDi 1.6 GTi 1.7 SDi

7476121 OE 6N0407151B+6N0407365	Triangle de susp. G <i>Left track control arm</i>	7476120 OE 6N0407151B+6N0407365A	Triangle de susp. D <i>Right track control arm</i>
	4 Avec rotule <i>With ball joint</i> 1.0i 1.4i 1.4i 16v. 1.4 TDi 1.7 SDi		3 Avec rotule <i>With ball joint</i> 1.0i 1.4i 1.4i 16v. 1.4 TDi 1.7 SDi

9005270 OE 6N0407365	Rotule de susp. inf. G <i>Left lower suspension ball joint</i>	9005269 OE 6N0407365A	Rotule de susp. inf. D <i>Right lower suspension ball joint</i>
	2 Axe Ø 15 1.0i 1.4i 1.4i 16v. 1.4 TDi 1.7 SDi		1 Axe Ø 15 1.0i 1.4i 1.4i 16v. 1.4 TDi 1.7 SDi

... Lupo



Support d'amortisseur
Suspension mounting
Soporte amortiguador
Poduszka amortyzatora
Опора амортизатора

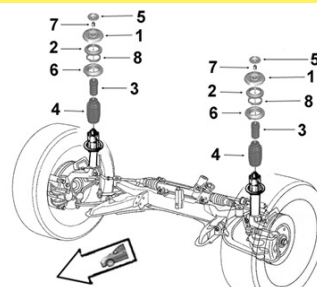

<p>9005616 Support suspension G/D OE 6N0412331A <i>L/R suspension mounting</i></p>	<p>9005352 Butée à billes G/D OE 1J0412249 <i>L/R ball bearing</i></p>																												
<p>1</p> <table style="width: 100%; border-collapse: collapse;"> <tr><td style="width: 30%;">1.0i</td><td style="width: 30%;">10/98-</td></tr> <tr><td>1.2 TDi</td><td>09/99-</td></tr> <tr><td>1.4i</td><td>10/00-</td></tr> <tr><td>1.4i 16v.</td><td>10/98-</td></tr> <tr><td>1.4 TDi</td><td>09/99-</td></tr> <tr><td>1.6 GTi</td><td>09/00-</td></tr> <tr><td>1.7 SDi</td><td>10/98-</td></tr> </table>	1.0i	10/98-	1.2 TDi	09/99-	1.4i	10/00-	1.4i 16v.	10/98-	1.4 TDi	09/99-	1.6 GTi	09/00-	1.7 SDi	10/98-	<p>2</p> <table style="width: 100%; border-collapse: collapse;"> <tr><td style="width: 30%;">1.0i</td><td style="width: 30%;">10/98-</td></tr> <tr><td>1.2 TDi</td><td>09/99-</td></tr> <tr><td>1.4i</td><td>10/00-</td></tr> <tr><td>1.4i 16v.</td><td>10/00-</td></tr> <tr><td>1.4 TDi</td><td>09/99-</td></tr> <tr><td>1.6 GTi</td><td>04/01-</td></tr> <tr><td>1.7 SDi</td><td>10/98-</td></tr> </table>	1.0i	10/98-	1.2 TDi	09/99-	1.4i	10/00-	1.4i 16v.	10/00-	1.4 TDi	09/99-	1.6 GTi	04/01-	1.7 SDi	10/98-
1.0i	10/98-																												
1.2 TDi	09/99-																												
1.4i	10/00-																												
1.4i 16v.	10/98-																												
1.4 TDi	09/99-																												
1.6 GTi	09/00-																												
1.7 SDi	10/98-																												
1.0i	10/98-																												
1.2 TDi	09/99-																												
1.4i	10/00-																												
1.4i 16v.	10/00-																												
1.4 TDi	09/99-																												
1.6 GTi	04/01-																												
1.7 SDi	10/98-																												
<p>9005338 Butée de suspension OE 1H0412303B <i>Shock bush</i></p>	<p>9005327 Protecteur amortisseur G/D OE 357413175A <i>L/R shock absorber protector</i></p>																												
<p>3 H64</p> <table style="width: 100%; border-collapse: collapse;"> <tr><td style="width: 30%;">1.0i</td><td style="width: 30%;">10/98-</td></tr> <tr><td>1.2 TDi</td><td>09/99-</td></tr> <tr><td>1.4i</td><td>10/00-</td></tr> <tr><td>1.4i 16v.</td><td>10/98-</td></tr> <tr><td>1.4 TDi</td><td>09/99-</td></tr> <tr><td>1.6 GTi</td><td>04/01-</td></tr> <tr><td>1.7 SDi</td><td>10/98-</td></tr> </table>	1.0i	10/98-	1.2 TDi	09/99-	1.4i	10/00-	1.4i 16v.	10/98-	1.4 TDi	09/99-	1.6 GTi	04/01-	1.7 SDi	10/98-	<p>4 H221.5</p> <table style="width: 100%; border-collapse: collapse;"> <tr><td style="width: 30%;">1.0i</td><td style="width: 30%;">10/98-</td></tr> <tr><td>1.2 TDi</td><td>09/99-</td></tr> <tr><td>1.4i</td><td>10/00-</td></tr> <tr><td>1.4i 16v.</td><td>10/98-</td></tr> <tr><td>1.4 TDi</td><td>09/99-</td></tr> <tr><td>1.6 GTi</td><td>04/01-</td></tr> <tr><td>1.7 SDi</td><td>10/98-</td></tr> </table>	1.0i	10/98-	1.2 TDi	09/99-	1.4i	10/00-	1.4i 16v.	10/98-	1.4 TDi	09/99-	1.6 GTi	04/01-	1.7 SDi	10/98-
1.0i	10/98-																												
1.2 TDi	09/99-																												
1.4i	10/00-																												
1.4i 16v.	10/98-																												
1.4 TDi	09/99-																												
1.6 GTi	04/01-																												
1.7 SDi	10/98-																												
1.0i	10/98-																												
1.2 TDi	09/99-																												
1.4i	10/00-																												
1.4i 16v.	10/98-																												
1.4 TDi	09/99-																												
1.6 GTi	04/01-																												
1.7 SDi	10/98-																												
<p>Eléments TRAIN ARRIERE <i>Rear axle parts</i> <i>Tren TRAS</i> <i>Elementy zawieszenia tylnego</i> <i>элементы задней оси.</i></p>	<p>9001703 Articulation essieu AR OE 6N0501541D <i>Rear axle bush</i></p>																												
	<p>Ø int.10 Ø ext.58 coll.66 long. tube int.58 ext.41 ep. coll.9</p> <table style="width: 100%; border-collapse: collapse;"> <tr><td style="width: 30%;">1.0i</td><td style="width: 30%;">10/98-</td></tr> <tr><td>1.2 TDi</td><td>09/99-</td></tr> <tr><td>1.4i</td><td>10/00-</td></tr> <tr><td>1.4i 16v.</td><td>10/98-</td></tr> <tr><td>1.4 TDi</td><td>09/99-</td></tr> <tr><td>1.6 GTi</td><td>04/01-</td></tr> <tr><td>1.7 SDi</td><td>10/98-</td></tr> </table>	1.0i	10/98-	1.2 TDi	09/99-	1.4i	10/00-	1.4i 16v.	10/98-	1.4 TDi	09/99-	1.6 GTi	04/01-	1.7 SDi	10/98-														
1.0i	10/98-																												
1.2 TDi	09/99-																												
1.4i	10/00-																												
1.4i 16v.	10/98-																												
1.4 TDi	09/99-																												
1.6 GTi	04/01-																												
1.7 SDi	10/98-																												

Passat I II 73-88

Eléments TRAIN ARRIERE
Rear axle parts
Tren TRAS
Elementy zawieszenia tylnego
элементы задней оси.



<p>9001696 Articulation essieu AR OE 321501541 <i>Rear axle bush</i></p>	<p>Ø int.12 Ø ext.44.5 coll.71 long. tube int.40 ext.26.5 ep. coll.5</p>																
<table style="width: 100%; border-collapse: collapse;"> <tr><td style="width: 30%;">1.3</td><td style="width: 30%;">08/80-03/88</td></tr> <tr><td>1.6</td><td>08/80-03/88</td></tr> <tr><td>1.6 D</td><td>08/80-03/88</td></tr> <tr><td>1.6 TD</td><td>08/80-03/88</td></tr> <tr><td>1.8</td><td>08/80-03/88</td></tr> <tr><td>1.9</td><td>08/80-03/88</td></tr> <tr><td>2.0</td><td>08/80-03/88</td></tr> <tr><td>2.2</td><td>08/80-03/88</td></tr> </table>	1.3	08/80-03/88	1.6	08/80-03/88	1.6 D	08/80-03/88	1.6 TD	08/80-03/88	1.8	08/80-03/88	1.9	08/80-03/88	2.0	08/80-03/88	2.2	08/80-03/88	
1.3	08/80-03/88																
1.6	08/80-03/88																
1.6 D	08/80-03/88																
1.6 TD	08/80-03/88																
1.8	08/80-03/88																
1.9	08/80-03/88																
2.0	08/80-03/88																
2.2	08/80-03/88																

Passat III IV 88-97 ...

Eléments DIRECTION





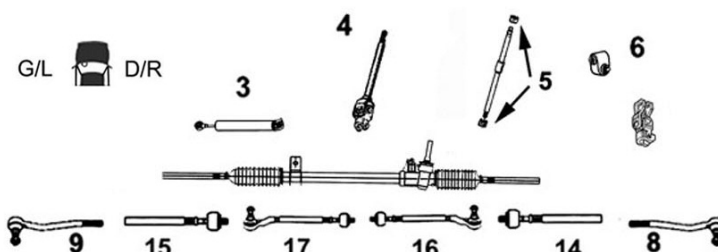

Steering parts

Elementos Direcciones

Elementy układ kierowniczy

Элементы рулевой системы



<p>9006211 Part/oe 1H0419804</p> 	<p>Axe de bielle G/D <i>L/R axial joint</i></p> <p>14 Côté dir. M22x1.5 Côté rot. M14x1.5 15 long 394 mm</p> <p>TT /all models DNA 04/88-08/93</p>	<p>9006212 OE 191422821C</p> 	<p>Axe de bielle G/D <i>L/R axial joint</i></p> <p>14 Côté dir. M14x1.5 Côté rot. M14x1.5 15 long 359 mm</p> <p>TT /all models sauf VR6 DA ZF 04/88-08/93</p>
<p>9006214 Part/oe 3A0422803C</p> 	<p>Axe de bielle G/D <i>L/R axial joint</i></p> <p>14 Côté dir. M14x1.5 Côté rot. M14x1.5 15 long 361 mm</p> <p>TT /all models DA Ch- 3AR099265 01/94-09/96</p>	<p>9006218 Part/oe 1H0422803A</p> 	<p>Axe de bielle G/D <i>L/R axial joint</i></p> <p>14 Côté dir. M14x1.5 Côté rot. M14x1.5 15 long 371 mm</p> <p>TT /all models DA TRW 04/88-08/93</p>
<p>9006380 OE 191419811</p> 	<p>Rotule de direction G <i>Left tie rod end</i></p> <p>9 M14 x 1.5</p> <p>TT /all models DNA DA 04/88-08/93 TT /all models Sauf VR6 Ch- 3AR099265 01/94-09/96</p>	<p>9006381 OE 191419812</p> 	<p>Rotule de direction D <i>Right tie rod end</i></p> <p>8 M14 x 1.5</p> <p>TT /all models DNA DA 04/88-08/93 TT /all models Sauf VR6 Ch- 3AR099265 01/94-09/96</p>
<p>9006383 OE 251419811</p> 	<p>Rotule de direction G/D <i>L/R tie rod end</i></p> <p>8 M14 x 1.5 9</p> <p>2.8 VR6 /SW Ch- 3AR099265 11/93-09/96</p>		

VOLKSWAGEN



... Passat III IV 88-97 ...



Eléments SUSPENSION

Suspension parts

Elementos suspensión

Elementy zawieszenia

Элементы подвески

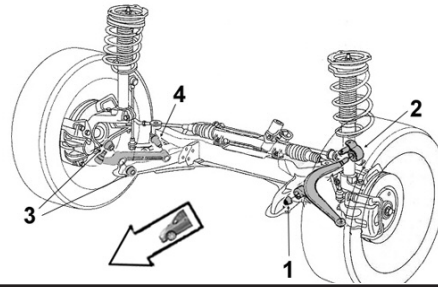

SASIC

VOLKSWAGEN

9001520

Articulation AR

OE 191407181E

Rear bush



2 Ø int.17 Ø ext.60.5
long. tube int.41 ext.24.5
1.6 -11/93
1.6 TD -11/93
1.8 -09/96
1.8i 16v./G60 -11/93
1.9 TD -09/96
1.9 TDi 11/93-09/96
2.0 i 16v. -09/96
2.8 VR6 11/93-09/96

9001523

Articulation AV

OE 357407182

Front bush



1 Ø int.12 Ø ext.33 coll.36
long. tube int.54 ext.29 ep. coll.5
1.6 -11/93
1.6 TD -11/93
1.8i 16v. /G60 -11/93
1.9 TD -11/93
2.0 -11/93
2.0i 16v. -11/93

Bras & Triangle de suspension

Control arm
Brazo y triángulo
Wahacz
Рычаг подвески

G/L  D/R

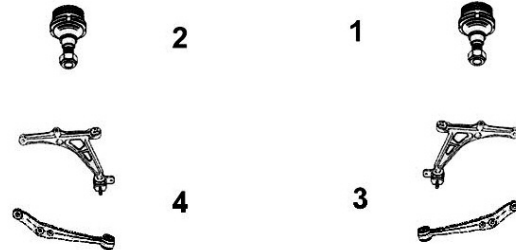

9005137

Triangle de susp. G/D

OE 357407151

L/R track control arm



3
4 Sans rotule Without tie rod end
TT /all models 04/88-08/93
TT /all models Sauf 2.0 16v. VR6 Ch- 3AR099265 01/94-09/96

7476114

Triangle de susp. G

OE 357407151+357407365 Left track control arm

NEW



4 Avec rotule With ball joint Ø 19
TT /all models Sauf 16v. VR6 04/88-08/93
TT /all models Sauf 2.0 16v. VR6 01/94-09/96
Ch- 3AR099265

7476113

Triangle de susp. D

OE 357407151+357407365 Right track control arm

NEW



3 Avec rotule With ball joint Ø 19
TT /all models Sauf 16v. VR6 04/88-08/93
TT /all models Sauf 2.0 16v. VR6 01/94-09/96
Ch- 3AR099265

9005260

Rotule de susp. inf. G/D

OE 357407365

L/R lower suspension ball joint



1
2 Ø 19 Cylindrique
TT /all models Sauf 16v. VR6 04/88-08/93
TT /all models Sauf 2.0 16v. VR6 01/94-09/96
Ch- 3AR099265

9005268

Rotule de susp. inf. G/D

OE 1H0407365

L/R lower suspension ball joint



1
2 Cône Ø 16.8 - Ø 18
1.9 TDi SW 03/96-05/97
2.0i 16v. SW 01/94-05/97
2.8 VR6 Ch- 31-N-255990 -08/96
2.8 VR6 SW Ch- 31-N-255990 -05/97
2.9i 4WD SW 01/94-05/97

... Passat III IV 88-97





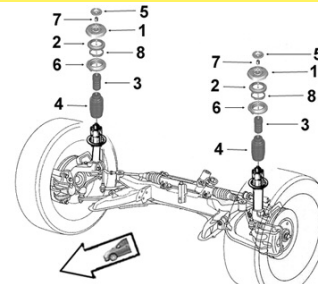



Support d'amortisseur
Suspension mounting
Soporte amortiguador
Poduszka amortyzatora
Опора амортизатора



VOLKSWAGEN



9001708 OE 357412329	Support suspension G/D <i>L/R suspension mounting</i>	9001709 OE 357412331A	Support suspension G/D <i>L/R suspension mounting</i>
1 Avec roulement With bearing		1	
	1.6 -10/93 1.6 TD -10/93 1.8 -10/93 1.8i 16v. -10/93 2.0 -10/93 2.0i 16v. -10/93		1.8 BVM BVA 11/93-09/96 1.9 TD 11/93-09/96 1.9 TDi 11/93-09/96 2.0 BVM BVA 11/93-09/96 2.0i 16v. 11/93-09/96 2.8 VR6 BVM BVA 11/93-09/96
9005352 OE 1J0412249	Butée à billes G/D <i>L/R ball bearing</i>	9005362 OE 357412303E	Butée de suspension G/D <i>L/R suspension bush</i>
2		3 H84	
	1.8 11/93- 1.9 TD 11/93- 1.9 TDi 11/93- 2.0 11/93- 2.0i 16v. 11/93- 2.8 VR6 11/93-		1.6 -10/93 1.6 TD -10/93 1.8 -10/93 1.8i 16v. -10/93 1.8 G60 -10/93 1.9 TD -10/93 2.0 -10/93 2.0i 16v. -10/93
9005363 OE 357412303F	Butée de suspension G/D <i>L/R suspension bush</i>	9005327 OE 357413175A	Protecteur amortisseur G/D <i>L/R shock absorber protector</i>
3 H83		4 H221.5	
	1.6 /i 11/93-10/96 1.8 11/93-10/96 1.9 TD 11/93-10/96 1.9 TDi 11/93-10/96 2.0 11/93-10/96 2.0i 16v. 11/93-10/96 2.8 VR6 11/93-10/96		1.8 11/93- 1.9 TD 11/93- 1.9 TDi 11/93- 2.0 11/93- 2.0i 16v. 11/93- 2.8 VR6 11/93-

Eléments TRAIN ARRIERE

Rear axle parts

Tren TRAS

Elementy zawieszenia tylnego

элементы задней оси.



9001702 OE 3A0501541	Articulation essieu AR <i>Rear axle bush</i>
Ø int.12 Ø ext.56.5 coll.85 long. tube int.50 ext.26 ep. coll.2.5	
	1.8 11/93- 1.9 TD 11/93- 1.9 TDi 11/93- 2.0 11/93- 2.0i 16v. 11/93- 2.8 VR6 06/91-

Passat V 96-05 ...

Eléments DIRECTION
 Steering parts
 Elementos Direcciones
 Elementy układ kierowniczy
 Элементы рулевой системы

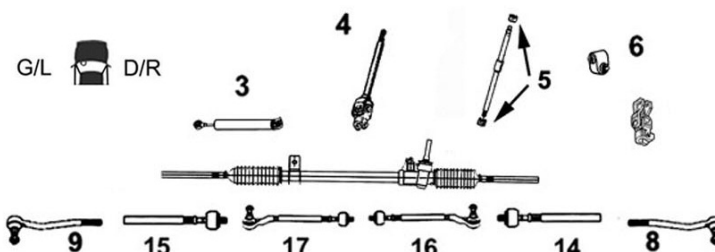

VOLKSWAGEN BASIC

7776081

Axe de bielle G/D

OE 4D0422821A

L/R axial joint

NEW



14 Côté dir. M16x1.5 Côté rot. M14x1.5
 15 long 128 mm

TT /all models / Break /4WD
 10/00-09/05

9006247

Axe de bielle G/D

OE 4D0422821

L/R axial joint



14 Côté dir. M16x1.5 Côté rot. M14x1.5
 15 long 128 mm

1.6i / GPL /Break -10/00
 1.8i /Turbo / Break /4WD -10/00
 1.9 TDi / Break /4WD -10/00
 2.0i Break /4WD -10/00
 2.3i VR5 20v. / Break /4WD -10/00
 2.5 TDi / Break /4WD -10/00
 2.8i V6 30v. / Break /4WD -10/00

9006413

Rotule de direction G/D

OE 4B0419811F

L/R tie rod end



8 M14x1.5

9 1.6i 10/96-12/05
 1.8i 10/96-10/00
 1.8i Turbo 10/00-12/05
 1.9 TDi 10/96-12/05
 2.0i 10/00-12/05
 2.3i 20v. VR5 10/96-10/00
 2.5 TDi /4WD 08/98-10/00
 2.5 V6 TDi 10/00-12/05
 2.8i 10/96-10/00



Barre stabilisatrice

Stabilizer bar
 Barra estabilizadora
 Drażek stabilizatora
 стабилизатор поперечной устойчивости

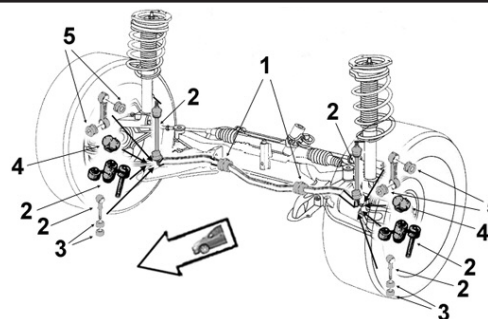

2306011

Biellette barre stab.

OE 4D0411317K

Stabilizer bar stub axle



2 -ch 3B-XP213726

1.6i 10/96-10/00
 1.8i 10/96-10/00
 1.9 TDi 10/96-10/00
 2.3i V5 20v. 10/96-10/00

9005086

Biellette barre stab. G

OE 8D0411317D

Left stabilizer bar stub axle



2 1.6i Ch- 3B-XP213727 -02/05
 1.8i
 1.8i 20v. Turbo 10/00-02/05
 1.9 TDi Ch- 3B-XP213727
 2.0i 10/00-02/05
 2.3i VR5 Ch- 3B-XP213727 -02/05
 2.5 V6 TDi 01/99-02/05
 2.8i V6 01/97-02/05

9005096

Biellette barre stab. D



OE 8D0411318D

Right stabilizer bar stub axle

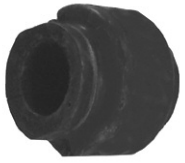

2 1.6i Ch- 3B-XP213727 -02/05
 1.8i
 1.8i 20v. Turbo 10/00-02/05
 1.9 TDi Ch- 3B-XP213727
 2.0i 10/00-02/05
 2.3i VR5 Ch- 3B-XP213727 -02/05
 2.5 V6 TDi 01/99-02/05
 2.8i V6 01/97-02/05

... Passat V 96-05 ...



<p>9001547 Palier de barre milieu OE 4D0411327G <i>Middle bar main bearing</i></p>	<p>9001548 Palier de barre milieu OE 4D0411327H <i>Middle bar main bearing</i></p>																																
																																	
<p>1 Barre Ø26.8</p> <table style="width: 100%; border-collapse: collapse;"> <tr><td>1.6i</td><td>10/96-</td></tr> <tr><td>1.8i</td><td>10/96-</td></tr> <tr><td>1.8i Turbo</td><td>10/00-</td></tr> <tr><td>1.9 TDi /4WD</td><td>10/96-</td></tr> <tr><td>2.0i</td><td>10/00-</td></tr> <tr><td>2.3i VR5</td><td>10/96-</td></tr> <tr><td>2.5 V6 TDi</td><td>10/03-</td></tr> <tr><td>2.8i V6</td><td>10/00-</td></tr> </table>	1.6i	10/96-	1.8i	10/96-	1.8i Turbo	10/00-	1.9 TDi /4WD	10/96-	2.0i	10/00-	2.3i VR5	10/96-	2.5 V6 TDi	10/03-	2.8i V6	10/00-	<p>1 Barre Ø29</p> <table style="width: 100%; border-collapse: collapse;"> <tr><td>1.6i /SW</td><td>10/96-</td></tr> <tr><td>1.8i</td><td>10/96-</td></tr> <tr><td>1.8i Turbo /SW</td><td>10/00-</td></tr> <tr><td>1.9 TDi /SW /4WD</td><td>10/96-</td></tr> <tr><td>2.0i</td><td>10/00-</td></tr> <tr><td>2.3i VR5</td><td>10/96-</td></tr> <tr><td>2.5 V6 TDi /4WD /SW</td><td>01/99-</td></tr> <tr><td>2.8i V6 30v. 4WD</td><td>06/99-</td></tr> </table>	1.6i /SW	10/96-	1.8i	10/96-	1.8i Turbo /SW	10/00-	1.9 TDi /SW /4WD	10/96-	2.0i	10/00-	2.3i VR5	10/96-	2.5 V6 TDi /4WD /SW	01/99-	2.8i V6 30v. 4WD	06/99-
1.6i	10/96-																																
1.8i	10/96-																																
1.8i Turbo	10/00-																																
1.9 TDi /4WD	10/96-																																
2.0i	10/00-																																
2.3i VR5	10/96-																																
2.5 V6 TDi	10/03-																																
2.8i V6	10/00-																																
1.6i /SW	10/96-																																
1.8i	10/96-																																
1.8i Turbo /SW	10/00-																																
1.9 TDi /SW /4WD	10/96-																																
2.0i	10/00-																																
2.3i VR5	10/96-																																
2.5 V6 TDi /4WD /SW	01/99-																																
2.8i V6 30v. 4WD	06/99-																																



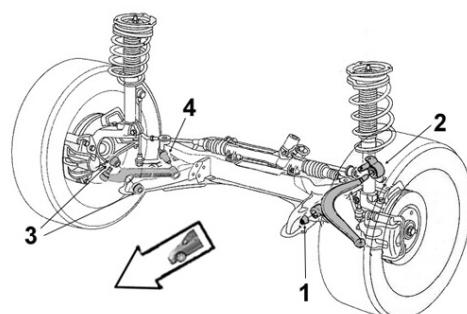

Eléments SUSPENSION

Suspension parts
Elementos suspensión
Elementy zawieszenie
Элементы подвески



<p>9001543 Articulation bras sup. OE 4D0407515C <i>Upper arm bush</i></p>	<p>9001758 Articulation bras sup. OE 4B0407515 <i>Upper arm bush</i></p>																										
																											
<p>4 Ø int.10 Ø ext.46.5 long. tube int.40 ext.25.5 -ch 3B-XE113734</p> <table style="width: 100%; border-collapse: collapse;"> <tr><td>1.6i</td><td>10/96-</td></tr> <tr><td>1.8i</td><td>10/96-</td></tr> <tr><td>1.9 TDi</td><td>10/96-</td></tr> <tr><td>2.3i VR5</td><td>10/96-</td></tr> <tr><td>2.5 V6 TDi</td><td>10/96-</td></tr> <tr><td>2.8i V6</td><td>06/99-</td></tr> </table>	1.6i	10/96-	1.8i	10/96-	1.9 TDi	10/96-	2.3i VR5	10/96-	2.5 V6 TDi	10/96-	2.8i V6	06/99-	<p>4 Ø int.10 Ø ext.46.5 long. tube int.40 ext.26 Ch- 3B-XE113735</p> <table style="width: 100%; border-collapse: collapse;"> <tr><td>1.6i</td><td>-02/05</td></tr> <tr><td>1.8i 20v. /Turbo</td><td>-02/05</td></tr> <tr><td>1.9 TDi /SW</td><td>-02/05</td></tr> <tr><td>2.0i</td><td>-02/05</td></tr> <tr><td>2.3i VR5</td><td>-02/05</td></tr> <tr><td>2.5 V6 TDi</td><td>-02/05</td></tr> <tr><td>2.8i V6 /4WD</td><td>-02/05</td></tr> </table>	1.6i	-02/05	1.8i 20v. /Turbo	-02/05	1.9 TDi /SW	-02/05	2.0i	-02/05	2.3i VR5	-02/05	2.5 V6 TDi	-02/05	2.8i V6 /4WD	-02/05
1.6i	10/96-																										
1.8i	10/96-																										
1.9 TDi	10/96-																										
2.3i VR5	10/96-																										
2.5 V6 TDi	10/96-																										
2.8i V6	06/99-																										
1.6i	-02/05																										
1.8i 20v. /Turbo	-02/05																										
1.9 TDi /SW	-02/05																										
2.0i	-02/05																										
2.3i VR5	-02/05																										
2.5 V6 TDi	-02/05																										
2.8i V6 /4WD	-02/05																										

<p>9001539 Articulation ext. bras inf. AV OE 4D0407182G <i>Front lower arm outer bush</i></p>																	
																	
<p>4 Ø int.12 Ø ext.50 long. tube int.60 ext.31</p> <table style="width: 100%; border-collapse: collapse;"> <tr><td>1.6i</td><td>10/96-</td></tr> <tr><td>1.8i</td><td>10/96-</td></tr> <tr><td>1.8i Turbo</td><td>10/00-</td></tr> <tr><td>1.9 TDi</td><td>10/96-</td></tr> <tr><td>2.0i</td><td>10/00-</td></tr> <tr><td>2.3i VR5</td><td>10/96-</td></tr> <tr><td>2.5 V6 TDi</td><td>01/99-</td></tr> <tr><td>2.8i V6</td><td>06/99-</td></tr> </table>	1.6i	10/96-	1.8i	10/96-	1.8i Turbo	10/00-	1.9 TDi	10/96-	2.0i	10/00-	2.3i VR5	10/96-	2.5 V6 TDi	01/99-	2.8i V6	06/99-	
1.6i	10/96-																
1.8i	10/96-																
1.8i Turbo	10/00-																
1.9 TDi	10/96-																
2.0i	10/00-																
2.3i VR5	10/96-																
2.5 V6 TDi	01/99-																
2.8i V6	06/99-																

<p>9001538 Articulation int. bras inf. AV OE 4D0407181H <i>Front lower arm inner bush</i></p>																	
																	
<p>3 Ø int.12 Ø ext.40 long. tube int.50 ext.42</p> <table style="width: 100%; border-collapse: collapse;"> <tr><td>1.6i</td><td>10/96-</td></tr> <tr><td>1.8i</td><td>10/96-</td></tr> <tr><td>1.8i Turbo</td><td>10/00-</td></tr> <tr><td>1.9 TDi</td><td>10/96-</td></tr> <tr><td>2.0i</td><td>10/00-</td></tr> <tr><td>2.3i VR5</td><td>10/96-</td></tr> <tr><td>2.5 V6 TDi</td><td>01/99-</td></tr> <tr><td>2.8i V6</td><td>10/00-</td></tr> </table>	1.6i	10/96-	1.8i	10/96-	1.8i Turbo	10/00-	1.9 TDi	10/96-	2.0i	10/00-	2.3i VR5	10/96-	2.5 V6 TDi	01/99-	2.8i V6	10/00-	
1.6i	10/96-																
1.8i	10/96-																
1.8i Turbo	10/00-																
1.9 TDi	10/96-																
2.0i	10/00-																
2.3i VR5	10/96-																
2.5 V6 TDi	01/99-																
2.8i V6	10/00-																

<p>9001540 Articulation bras inf. AR OE 4D0407183AC <i>Lower arm bush Rear</i></p>																	
																	
<p>4 Ø int.12 Ø ext.65 long. tube int.80 ext.65.5</p> <table style="width: 100%; border-collapse: collapse;"> <tr><td>1.6i</td><td>10/96-</td></tr> <tr><td>1.8i</td><td>10/96-</td></tr> <tr><td>1.8i Turbo</td><td>10/00-</td></tr> <tr><td>1.9 TDi</td><td>10/96-</td></tr> <tr><td>2.0i</td><td>10/00-</td></tr> <tr><td>2.3i VR5</td><td>10/96-</td></tr> <tr><td>2.5 V6 TDi</td><td>01/99-</td></tr> <tr><td>2.8i V6</td><td>06/99-</td></tr> </table>	1.6i	10/96-	1.8i	10/96-	1.8i Turbo	10/00-	1.9 TDi	10/96-	2.0i	10/00-	2.3i VR5	10/96-	2.5 V6 TDi	01/99-	2.8i V6	06/99-	
1.6i	10/96-																
1.8i	10/96-																
1.8i Turbo	10/00-																
1.9 TDi	10/96-																
2.0i	10/00-																
2.3i VR5	10/96-																
2.5 V6 TDi	01/99-																
2.8i V6	06/99-																

... Passat V 96-05 ...

Bras & Triangle de suspension

Control arm
Brazo y triángulo
Wahacz
Рычаг подвески

G/L  D/R

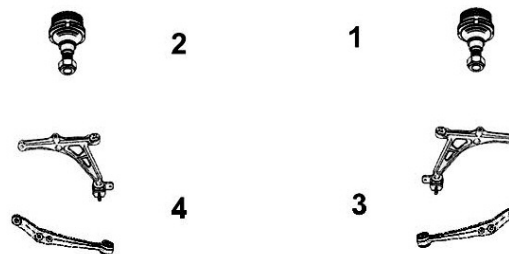

SASIC

VOLKSWAGEN

9005140 Bras de susp. AV sup. G

OE 8E0407505A *Left front upper track control arm*



4	Avec rotule With ball joint
	1.6i /SW 10/96-12/05
	1.8i 10/96-10/00
	1.8i Turbo 10/00-12/05
	1.9 TDi /SW 10/96-12/05
	2.0i 10/00-12/05
	2.3i 20v. VR5/4WD/SW 10/96-05/05
	2.5 TDi 08/98-12/05
	2.8i 10/96-09/05

9005141 Bras de susp. AV sup. D

OE 8E0407506A *Right front upper track control arm*



3	Avec rotule With ball joint
	1.6i /SW 10/96-12/05
	1.8i 10/96-10/00
	1.8i Turbo 10/00-12/05
	1.9 TDi /SW 10/96-12/05
	2.0i 10/00-12/05
	2.3i 20v. VR5/4WD/SW 10/96-05/05
	2.5 TDi 08/98-12/05
	2.8i 10/96-09/05

7476033 Bras de susp. AV inf. G/D

OE 4B3407151K *L/R front lower track control arm*



3	Avec rotule With ball joint	Ch- 3B-3-072001	
4	1.6i /SW		-03/05
	1.8i 20v. Turbo /SW		-03/05
	1.9 TDi /SW		-03/05
	2.0i /SW		-03/05
	2.0i 20v. /SW		-03/05
	2.3i V5 /4WD /SW		-03/05
	2.5 TDi /SW /4WD		-03/05
	2.8i V6 4WD /SW		-03/05

9005747 Bras de susp. AR sup. G

OE 8D0407509G *Left rear upper track control arm*



4	Avec rotule With ball joint		
	1.6i /SW	-ch 3BVP102593	-ch 3BVE083008 10/96-
	1.8i	-ch 3BVP102593	-ch 3BVE083008 10/96-
	1.9 TDi	-ch 3BVP102593	-ch 3BVE083008 10/96-
	2.3i 20v. VR5 /4WD/SW	-ch 3BVP102593	-ch 3BVE083008 10/96-
	2.3i 20v. VR5	-ch 3BVE083008	-ch 3BVE083008 10/96-
	2.5 TDi /4WD /SW	-ch 3BVE083008	-ch 3BVE083008 08/98-
	2.5 TDi /4WD	-ch 3BVP102593	-ch 3BVE083008 08/98-
	2.8i V6 30v. 4WD /SW	-ch 3BVE083008	-ch 3BVE083008 01/97-
	2.8i V6 30v. 4WD	-ch 3BVP102593	-ch 3BVE083008 01/97-

9005748 Bras de susp. AR sup. D





OE 8D0407510G *Right rear upper track control arm*



3	Avec rotule With ball joint		
	1.6i /SW	-ch 3BVP102593	-ch 3BVE083008 10/96-
	1.8i	-ch 3BVP102593	-ch 3BVE083008 10/96-
	1.9 TDi	-ch 3BVP102593	-ch 3BVE083008 10/96-
	2.3i 20v. VR5 /4WD/SW	-ch 3BVP102593	-ch 3BVE083008 10/96-
	2.3i 20v. VR5	-ch 3BVE083008	-ch 3BVE083008 10/96-
	2.5 TDi /4WD /SW	-ch 3BVE083008	-ch 3BVE083008 08/98-
	2.5 TDi /4WD	-ch 3BVP102593	-ch 3BVE083008 08/98-
	2.8i V6 30v. 4WD /SW	-ch 3BVE083008	-ch 3BVE083008 01/97-
	2.8i V6 30v. 4WD	-ch 3BVP102593	-ch 3BVE083008 01/97-

... Passat V 96-05...





9005749 Bras de susp. AR sup. G	
OE 4D0407509G	<i>Left rear upper track control arm</i>
	4 Avec rotule <i>With ball joint</i>
	1.6i /SW Ch- 3BVP102594 -12/05
	1.6i Ch- 3BVE083009 -12/05
	1.8i Ch- 3BVP102594 -10/00
	1.8i Ch- 3BVE083009 -10/00
	1.8i Turbo 10/00-12/05
	1.9 TDi Ch- 3BVE083009 -10/00
	1.9 TDi /SW Ch- 3BVP102594
	2.0i 10/00-12/05
	2.3i 20v. VR5/4WD/SW Ch- 3BVP102594 -03/05
	2.3i 20v. VR5 /4WD Ch- 3BVE083009 -03/05
	2.5 TDi /4WD Ch- 3BVE083009 ch-3BXE113734 ch-3BVP102594 ch-3BXE113734 -12/05
	2.5 V6 TDi 10/00-12/05
	2.8i V6 /4WD 10/96-12/05
9005750 Bras de susp. AR sup. D	
OE 4D0407510J	<i>Right rear upper track control arm</i>
	3 Avec rotule <i>With ball joint</i>
	1.6i /SW Ch- 3BVP102594 -12/05
	1.6i Ch- 3BVE083009 -12/05
	1.8i Ch- 3BVP102594 -10/00
	1.8i Ch- 3BVE083009 -10/00
	1.8i Turbo 10/00-12/05
	1.9 TDi Ch- 3BVE083009 -10/00
	1.9 TDi /SW Ch- 3BVP102594
	2.0i 10/00-12/05
	2.3i 20v. VR5/4WD/SW Ch- 3BVP102594 -03/05
	2.3i 20v. VR5 /4WD Ch- 3BVE083009 -03/05
	2.5 TDi /4WD Ch- 3BVE083009 ch-3BXE113734 ch-3BVP102594 ch-3BXE113734 -12/05
	2.5 V6 TDi 10/00-12/05
	2.8i V6 /4WD 10/96-12/05
9005157 Bras de susp. AV inf. G/D	
OE 4D0407151P	<i>L/R front lower track control arm</i>
	3 Avec rotule <i>With ball joint</i>
	4 1.6i /SW -ch 3B3150000 10/96-
	1.8i 10/96-10/00
	1.8i Turbo -ch 3B3150000 10/00-
	1.9 TDi /SW -ch 3B3150000 10/96-
	2.0i -ch 3B3150000 10/00-
	2.3i 20v. VR5/4WD/SW -ch 3B3150000 10/96-
	2.5 TDi /SW -ch 3B3150000 08/98-
	2.8i 10/96-
	9005156 Bras de susp. AR inf. G
OE 8E0407693AG	<i>Left rear lower track control arm</i>
	4 Avec rotule <i>With ball joint</i>
	1.6i /SW 10/96-12/05
	1.8i 10/96-10/00
	1.8i Turbo 10/00-12/05
	1.9 TDi /SW 10/96-12/05
	2.0i 10/00-12/05
	2.3i 20v. VR5 /4WD /SW 10/96-05/05
	2.5 TDi /4WD /SW 07/99-12/05
	2.8i 10/96-09/05
9005154 Bras de susp. AR inf. D	
OE 8E0407694AG	<i>Right rear lower track control arm</i>
	3 Avec rotule <i>With ball joint</i>
	1.6i /SW 10/96-12/05
	1.8i 10/96-10/00
	1.8i Turbo 10/00-12/05
	1.9 TDi /SW 10/96-12/05
	2.0i 10/00-12/05
	2.3i 20v. VR5 /4WD /SW 10/96-05/05
	2.5 TDi /4WD /SW 07/99-12/05
	2.8i 10/96-09/05

... Passat V 96-05 ...

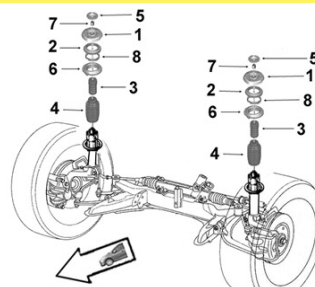

Support d'amortisseur
Suspension mounting
Soporte amortiguador
Poduszka amortyzatora
Опора амортизатора

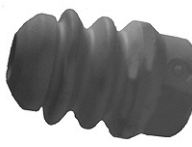

9001710 OE 4D0412377F	Support suspension G/D <i>L/R suspension mounting</i>																
	1																
	<table border="0"> <tr><td>1.6i</td><td>10/96-</td></tr> <tr><td>1.8i</td><td>10/96-</td></tr> <tr><td>1.8i Turbo</td><td>10/00-</td></tr> <tr><td>1.9 TDi</td><td>10/96-</td></tr> <tr><td>2.0i</td><td>10/00-</td></tr> <tr><td>2.3i VR5</td><td>10/96-</td></tr> <tr><td>2.5 V6 TDi</td><td>01/99-</td></tr> <tr><td>2.8i V6 30v. 4WD</td><td>01/97-</td></tr> </table>	1.6i	10/96-	1.8i	10/96-	1.8i Turbo	10/00-	1.9 TDi	10/96-	2.0i	10/00-	2.3i VR5	10/96-	2.5 V6 TDi	01/99-	2.8i V6 30v. 4WD	01/97-
1.6i	10/96-																
1.8i	10/96-																
1.8i Turbo	10/00-																
1.9 TDi	10/96-																
2.0i	10/00-																
2.3i VR5	10/96-																
2.5 V6 TDi	01/99-																
2.8i V6 30v. 4WD	01/97-																

9005326 OE 8D0412131F	Butée de suspension G/D <i>L/R suspension bush</i>																		
	3 H85																		
	<table border="0"> <tr><td>1.6i /SW</td><td>10/96-</td></tr> <tr><td>1.8i 20v. /SW</td><td>10/96-</td></tr> <tr><td>1.8i Turbo</td><td>10/00-</td></tr> <tr><td>1.9 TDi /4WD /SW</td><td>10/96-</td></tr> <tr><td>2.0i</td><td>10/00-</td></tr> <tr><td>2.3i VR5 /4WD /SW</td><td>10/96-</td></tr> <tr><td>2.5 TDi /4WD /SW</td><td>01/99-</td></tr> <tr><td>2.5 V6 TDi</td><td>10/03-</td></tr> <tr><td>2.8i</td><td>01/97-</td></tr> </table>	1.6i /SW	10/96-	1.8i 20v. /SW	10/96-	1.8i Turbo	10/00-	1.9 TDi /4WD /SW	10/96-	2.0i	10/00-	2.3i VR5 /4WD /SW	10/96-	2.5 TDi /4WD /SW	01/99-	2.5 V6 TDi	10/03-	2.8i	01/97-
1.6i /SW	10/96-																		
1.8i 20v. /SW	10/96-																		
1.8i Turbo	10/00-																		
1.9 TDi /4WD /SW	10/96-																		
2.0i	10/00-																		
2.3i VR5 /4WD /SW	10/96-																		
2.5 TDi /4WD /SW	01/99-																		
2.5 V6 TDi	10/03-																		
2.8i	01/97-																		

2656009 OE 8D0412131E	Butée de suspension <i>Shock bush</i>						
	3 H77						
	<table border="0"> <tr><td>1.9 TDi</td><td>06/99-10/00</td></tr> <tr><td>2.3i V5 20v.</td><td>10/96-10/00</td></tr> <tr><td>2.5 TDi</td><td>03/00-10/00</td></tr> </table>	1.9 TDi	06/99-10/00	2.3i V5 20v.	10/96-10/00	2.5 TDi	03/00-10/00
1.9 TDi	06/99-10/00						
2.3i V5 20v.	10/96-10/00						
2.5 TDi	03/00-10/00						



Support d'amortisseur
Suspension mounting
Soporte amortiguador
Poduszka amortyzatora
Опора амортизатора

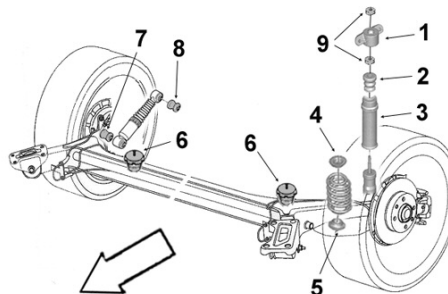

9005621 OE 8E0513353B	Support suspension G/D <i>L/R suspension mounting</i>														
	1 -ch 3B-1-300000														
	<table border="0"> <tr><td>1.6i</td><td>10/96-</td></tr> <tr><td>1.8i</td><td>10/96-09/00</td></tr> <tr><td>1.8i 20v. Turbo</td><td>10/00-</td></tr> <tr><td>1.9 TDi</td><td>10/96-</td></tr> <tr><td>2.0i</td><td>10/00-</td></tr> <tr><td>2.3i VR5</td><td>10/96-</td></tr> <tr><td>2.5 V6 TDi</td><td>01/99-</td></tr> </table>	1.6i	10/96-	1.8i	10/96-09/00	1.8i 20v. Turbo	10/00-	1.9 TDi	10/96-	2.0i	10/00-	2.3i VR5	10/96-	2.5 V6 TDi	01/99-
1.6i	10/96-														
1.8i	10/96-09/00														
1.8i 20v. Turbo	10/00-														
1.9 TDi	10/96-														
2.0i	10/00-														
2.3i VR5	10/96-														
2.5 V6 TDi	01/99-														

9005627 OE 3B0513353	Support suspension G/D <i>L/R suspension mounting</i>												
	1 Ch- 3B-1-300001												
	<table border="0"> <tr><td>1.6i</td><td>10/00-02/05</td></tr> <tr><td>1.8i 20v. Turbo</td><td>10/00-02/05</td></tr> <tr><td>1.9 TDi</td><td>10/00-02/05</td></tr> <tr><td>2.0i</td><td>10/00-02/05</td></tr> <tr><td>2.3i VR5</td><td>10/00-02/05</td></tr> <tr><td>2.5 V6 TDi</td><td>10/00-02/05</td></tr> </table>	1.6i	10/00-02/05	1.8i 20v. Turbo	10/00-02/05	1.9 TDi	10/00-02/05	2.0i	10/00-02/05	2.3i VR5	10/00-02/05	2.5 V6 TDi	10/00-02/05
1.6i	10/00-02/05												
1.8i 20v. Turbo	10/00-02/05												
1.9 TDi	10/00-02/05												
2.0i	10/00-02/05												
2.3i VR5	10/00-02/05												
2.5 V6 TDi	10/00-02/05												

... Passat V 96-05

Eléments TRAIN ARRIERE

Rear axle parts

Tren TRAS

Elementy zawieszenia tylnego

элементы задней оси.



VOLKSWAGEN



9001773 OE 4B0501521E	Support essieu AR G <i>Left rear axle mounting</i>	9001774 OE 4B0501522E	Support essieu AR D <i>Right rear axle mounting</i>	
	1.6i	10/96-09/05	1.6i	10/96-09/05
	1.8i	10/96-09/05	1.8i	10/96-09/05
	1.9 TDi	10/96-09/05	1.9 TDi	10/96-09/05
	2.0i	10/00-09/05	2.0i	10/00-09/05
	2.3i VR5	10/96-05/02	2.3i VR5	10/96-05/02
	2.5 V6 TDi	08/98-09/05	2.5 V6 TDi	08/98-09/05

Passat VI 05-10 ...

Eléments DIRECTION

Steering parts



Elementos Direcciones

Elementy układ kierowniczy

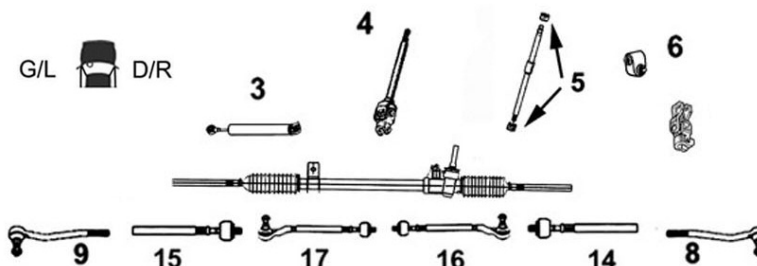
Элементы рулевой системы



9006873 OE 1K0423810A	Axe de bielle G/D <i>L/R axial joint</i>	
	14 Côté dir. M16x1.5 Côté rot. M16x1.5 long 310 mm 15	
	1.4 TSi /Break	11/07-
	1.6 /FSi Berline Break	03/05-
	1.6 TDi FAP /SW	09/09-10/10
	1.8 TFSi /Break	11/07-
	1.9 TDi Berline Break	03/05-
	2.0 FSi /4WD Berline Break	03/05-
	2.0 TFSi Berline Break	03/05-
	2.0 TFSi CC	10/09-07/11
	2.0 TSi	10/09-
	2.0 TDi /4WD Berline Break CC	03/05-
	3.2 FSi 4WD /Break	12/05-
	3.6 FSi 4WD /Break	09/07-

9006638 OE 1K0423811K	Rotule de direction G <i>Left tie rod end</i>	9006637 OE 1K0423812K	Rotule de direction D <i>Right tie rod end</i>	
	9 M16 x 1.5		8 M16 x 1.5	
	1.4 TSi /SW		1.4 TSi /SW	11/07-
	1.4 TSi ETH CC		1.4 TSi ETH CC	11/11-
	1.6i /SW		1.6i /SW	03/05-
	1.6 FSi /SW		1.6 FSi /SW	03/05-
	1.6 TDi FAP /SW		1.6 TDi FAP /SW	09/09-
	1.8 TSi /SW		1.8 TSi /SW	11/07-
	1.8 TSi CC		1.8 TSi CC	06/08-
	1.9 TDi /SW		1.9 TDi /SW	03/05-
	2.0 FSi /4WD /SW		2.0 FSi /4WD /SW	09/05-
	2.0 TFSi /SW		2.0 TFSi /SW	09/05-
	2.0 TFSi CC		2.0 TFSi CC	06/08-
	2.0 TDi /SW /4WD		2.0 TDi /SW /4WD	09/05-
	2.0 TDi FAP CC /4WD		2.0 TDi FAP CC /4WD	06/08-
	3.2 FSi 4WD /SW		3.2 FSi 4WD /SW	12/05-
3.6 FSi R36 4WD /SW	3.6 FSi R36 4WD /SW	09/07-		
3.6 FSi R36 4WD CC	3.6 FSi R36 4WD CC	06/08-		

... Passat VI 05-10 ...

Eléments DIRECTION

Steering parts

Elementos Direcciones

Elementy układ kierowniczy

Элементы рулевой системы

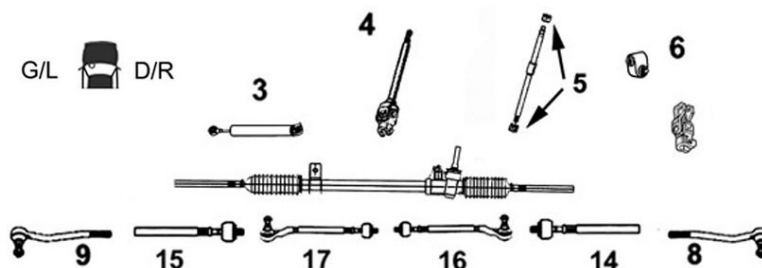

9006640

Rotule de direction G

OE 1K0423811G

Left tie rod end



9

M16 x 1.5

DA électrique

1.4 TSi /Break	11/07-10/10
1.6i /Break	06/05-10/10
1.6 FSi /Break	03/05-10/10
1.8 TSi /Break	11/07-10/10
1.8 TSi CC	06/08-
1.9 TDi /Break	03/05-10/10
2.0 FSi /4WD /Break	03/05-10/10
2.0 TDi /4WD /Break	03/05-10/10
2.0 TDi /CC /4WD	06/08-
3.2 FSi 4WD /Break	12/05-10/10
3.6 FSi 4WD Break	09/07-10/10
3.6 FSi 4WD CC	06/08-

9006639

Rotule de direction D

OE 1K0423812G

Right tie rod end



8

M16 x 1.5

DA électrique

1.4 TSi /Break	11/07-10/10
1.6i /Break	06/05-10/10
1.6 FSi /Break	03/05-10/10
1.8 TSi /Break	11/07-10/10
1.8 TSi CC	06/08-
1.9 TDi /Break	03/05-10/10
2.0 FSi /4WD /Break	03/05-10/10
2.0 TDi /4WD /Break	03/05-10/10
2.0 TDi /CC /4WD	06/08-
3.2 FSi 4WD /Break	12/05-10/10
3.6 FSi 4WD Break	09/07-10/10
3.6 FSi 4WD CC	06/08-



Barre stabilisatrice

Stabilizer bar

Barra estabilizadora

Drażek stabilizatora

стабилизатор поперечной устойчивости

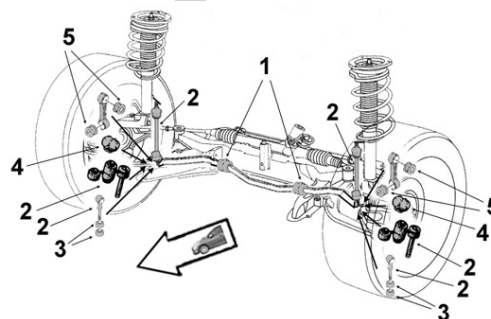

2306010

Biellette barre stab.

OE 1K0411315P

Stabilizer bar stub axle



2

1.4 TSi /Break		05/07-
1.6i /Break	BVM	06/05-
1.6 FSi /Break		03/05-
1.6 TDi /Break		09/09-
1.8 TSi /Break		05/07-
1.8 TSi CC		11/11-
1.9 TDi /Break	BVM	03/05-
2.0 FSi /Break		03/05-09/07
2.0 FSi 4WD/Break	BVM	09/05-
2.0 TFSi /Break		09/05-
2.0 TFSi TSi CC		11/11-
2.0 TDi /4WD /Break		03/05-
2.0 TDi CC		11/11-
3.2 FSi 4WD/Break		12/05-
3.6 FSi 4WD/Break		04/07-

... Passat VI 05-10 ...



Eléments SUSPENSION
Suspension parts
Elementos suspensión
Elementy zawieszenie
Элементы подвески

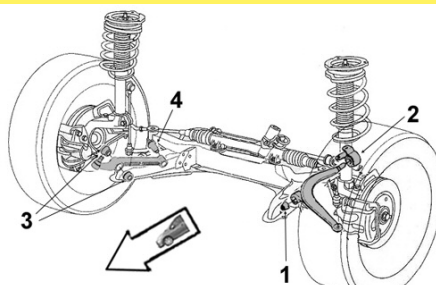

VOLKSWAGEN



2256007

OE 3C0199231D

Articulation AR inf.

Rear lower bush

2

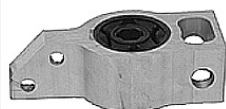

1.4 TSi /Break	06/05-
1.6i /Break	06/05-
1.6 FSi /Break	03/05-
1.6 TDi /Break	09/09-
1.8 TSi /Break	03/05-
1.9 TDi /Break	03/05-
2.0 FSi /4WD /Break	03/05-
2.0 TFSi TSi/4WD/Break	09/05-
2.0 TDi /4WD /Break	03/05-
3.2 FSi 4WD DSG/Break	12/05-
3.6 FSi 4WD /Break	04/07-

9001759

OE 1K0407182

Articulation AV

Front bush

1



**Ø int.12 Ø ext.40 coll.48
 long. tube int.54 ext.33 ep. coll.6**

1.4 TSi /Break	05/07-
1.6 /Break	06/05-
1.6 FSi /Break	03/05-
1.6 TDi /Break	09/09-
1.8 TSi /Break	05/07-
1.8 TSi CC	11/11-
1.9 TDi /Break	03/05-
2.0 FSi /Break	03/05-
2.0 TFSi TSi/CC/4WD/Break	09/07-
2.0 TDi CC	11/11-
2.0 TDi /Break	03/05-
3.2 FSi /Break	12/05-
3.6 FSi 4WD /Break	04/07-

Bras & Triangle de suspension

Control arm
Brazo y triángulo
Wahacz
Рычаг подвески

G/L D/R

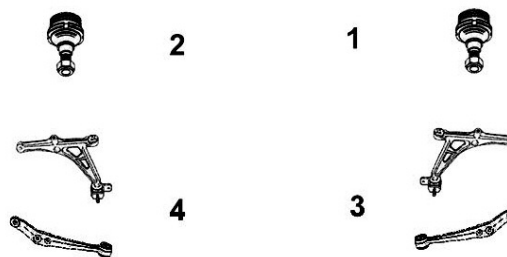

7476038

OE 3C0407151G

Triangle de susp. G/D

L/R track control arm

3

4

Sans rotule Without ball joint



1.4 TSi /Break	11/07-10/10
1.6i /Break	06/05-10/10
1.6 FSi /Break	03/05-10/10
1.6 TDi FAP /SW	09/09-10/10
1.8 TFSi /Break	11/07-10/10
1.8 TFSi CC	06/08-
1.9 TDi /Break	03/05-10/10
2.0 FSi /4WD /Break	03/05-10/10
2.0 TFSi /Break	09/05-10/10
2.0 TFSi CC	06/08-
2.0 TSi Break	10/09-10/10
2.0 TSi CC	10/09-
2.0 TDi /4WD /Break	03/05-10/10
2.0 TDi CC /4WD	06/08-
3.2 FSi 4WD /Break	12/05-10/10
3.6 FSi R36 4WD Break	09/07-10/10
3.6 FSi 4WD CC	06/08-

... Passat VI 05-10 ...

Bras & Triangle de suspension

Control arm
Brazo y triángulo
Wahacz
Рычаг подвески

G/L  D/R

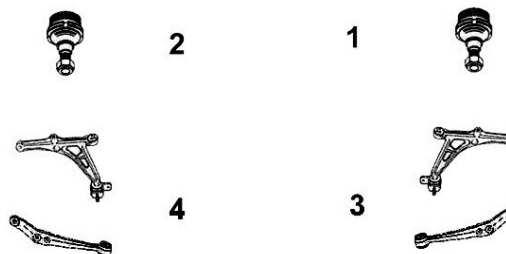

SASIC

VOLKSWAGEN

7576007

Rotule de susp. inf. G

OE 3C0407365A

Left lower suspension ball joint



2	1.4 TSi /Break	11/07-10/10
	1.6i /Break	06/05-10/10
	1.6 FSi /Break	03/05-10/10
	1.8 TFSi /Break	11/07-10/10
	1.8 TFSi CC	06/08-
	1.9 TDi /Break	03/05-10/10
	2.0 FSi /4WD /Break	03/05-10/10
	2.0 TSi CC	10/09-
	2.0 TDi /4WD /Break	03/05-10/10
	2.0 TDi CC /4WD	08/08-
	3.2 FSi 4WD /Break	12/05-10/10
	3.6 FSi 4WD CC	06/08-
	3.6 FSi R36 4WD/Break	09/07-10/10

7576005

Rotule de susp. inf. D

OE 3C0407366A

Right lower suspension ball joint



1	1.4 TSi /Break	11/07-10/10
	1.6i /Break	06/05-10/10
	1.6 FSi /Break	03/05-10/10
	1.8 TFSi /Break	11/07-10/10
	1.8 TFSi CC	06/08-
	1.9 TDi /Break	03/05-10/10
	2.0 FSi /4WD /Break	03/05-10/10
	2.0 TSi CC	10/09-
	2.0 TDi /4WD /Break	03/05-10/10
	2.0 TDi CC /4WD	08/08-
	3.2 FSi 4WD /Break	12/05-10/10
	3.6 FSi 4WD CC	06/08-
	3.6 FSi R36 4WD/Break	09/07-10/10



Support d'amortisseur

Suspension mounting
Soporte amortiguador
Poduszka amortyzatora
Опора амортизатора

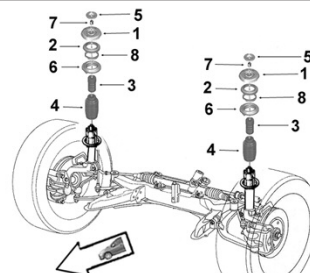

9005622

Support suspension G/D

OE1K0412331B

L/R suspension mounting



1	1.4 TSi	05/07-
	1.6	06/05-
	1.6 FSi	03/05-
	1.6 TDi	10/09-
	1.8 TSi	05/07-
	1.9 TDi	03/05-
	2.0 FSi /4WD/TFSi	03/05-
	2.0 TDi	03/05-
	3.2 FSi 4WD	12/05-
	3.6 FSi 4WD	09/07-

9005334

Butée de suspension

OE 1K0412303F

Shock bush



3	H55	
	1.4 TSi CC	11/11-
	1.6i /Break	06/05-
	1.6 FSi/Break Susp. sport	03/05-10/10
	1.8 TSi CC	06/08-
	1.9 TDi /Break	03/05-
	2.0 FSi /4WD	03/05-
	2.0 TFSi	09/05-
	2.0 TDi	03/05-
	3.2 FSi V6 4WD/DSG/SW	12/05-
	3.6 FSi 4WD/CC/Break	06/08-

2656004

Butée de suspension

OE 1K0412303E

Shock bush



3	H55	
	1.6 FSi Break Susp. pilotées	09/05-10/10

2656052

Butée de suspension

OE 1K0412303B

Shock bush



3	H70	
	1.4 TSi /Break	11/07-
	1.6i /Break	09/05-10/10
	1.6 FSi /Break	03/05-10/10
	1.6 TDi /Break	09/09-
	1.8 TSi /Break	11/07-
	1.9 TDi /Break	03/05-10/10
	2.0 FSi /4WD /Break	03/05-10/10
	2.0 TFSi TSi/4WD/Break	09/05-
	2.0 TDi /4WD /Break	03/05-
	3.2 FSi 4WD /Break	12/05-10/10

2656053

Protecteur amortisseur G/D

OE 6N0413175A

L/R shock absorber protector



4	H206	
	1.4 TSi /Break	11/07-
	1.4 TSi CC	11/11-
	1.6i /Break	09/05-10/10
	1.6 FSi /Break	03/05-10/10
	1.6 TDi /Break	09/09-
	1.8 TSi /CC /Break	11/07-
	1.9 TDi /Break	03/05-10/10
	2.0 FSi /4WD /Break	03/05-10/10
	2.0 TFSi /CC /Break	09/05-
	2.0 TSi CC	11/11-
	2.0 TDi /CC /4WD /Break	03/05-
	3.2 FSi 4WD	12/05-10/10
	3.6 FSi 4WD Break	06/08-07/11
	3.6 FSi 4WD CC	06/08-

... Passat VI 05-10





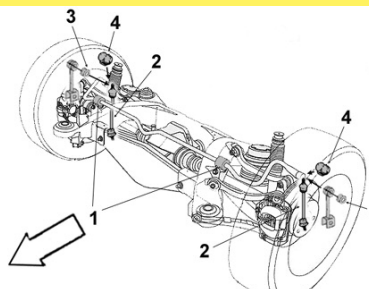

Barre stabilisatrice
 Stabilizer bar
 Barra estabilizadora
 Drażek stabilizatora
 стабилизатор поперечной устойчивости



VOLKSWAGEN



9005094 OE 1K0505465K	Biellette barre stab. <i>Stabilizer bar stub axle</i>	2306013 OE 1K0511327AQ	Palier de barre milieu <i>Middle bar main bearing</i>																																																				
	<p>2</p> <table style="width: 100%; border-collapse: collapse;"> <tr><td style="width: 60%;">1.4 TSi /Break</td><td style="width: 40%;">05/07-</td></tr> <tr><td>1.6 /Break</td><td>06/05-</td></tr> <tr><td>1.6 FSi /Break</td><td>03/05-</td></tr> <tr><td>1.6 TDi /Break</td><td>09/09-</td></tr> <tr><td>1.8 TSi /Break</td><td>05/07-</td></tr> <tr><td>1.8 TSi CC</td><td>11/11-</td></tr> <tr><td>1.9 TDi /Break</td><td>03/05-</td></tr> <tr><td>2.0 FSi /Break</td><td>03/05-</td></tr> <tr><td>2.0 TFSi TSi/4WD/Break</td><td>09/07-</td></tr> <tr><td>2.0 TFSi TSi CC</td><td>10/09-</td></tr> <tr><td>2.0 TDi /4WD /Break</td><td>03/05-</td></tr> <tr><td>2.0 TDi CC</td><td>11/11-</td></tr> <tr><td>3.2 FSi /Break</td><td>12/05-</td></tr> <tr><td>3.6 FSi /4WD /Break</td><td>05/07-</td></tr> </table>	1.4 TSi /Break	05/07-	1.6 /Break	06/05-	1.6 FSi /Break	03/05-	1.6 TDi /Break	09/09-	1.8 TSi /Break	05/07-	1.8 TSi CC	11/11-	1.9 TDi /Break	03/05-	2.0 FSi /Break	03/05-	2.0 TFSi TSi/4WD/Break	09/07-	2.0 TFSi TSi CC	10/09-	2.0 TDi /4WD /Break	03/05-	2.0 TDi CC	11/11-	3.2 FSi /Break	12/05-	3.6 FSi /4WD /Break	05/07-		<p>1 Barre Ø 19.6</p> <table style="width: 100%; border-collapse: collapse;"> <tr><td style="width: 60%;">1.6i /Break</td><td style="width: 40%;">-ch 3C-6-050000 06/05-</td></tr> </table>	1.6i /Break	-ch 3C-6-050000 06/05-																						
1.4 TSi /Break	05/07-																																																						
1.6 /Break	06/05-																																																						
1.6 FSi /Break	03/05-																																																						
1.6 TDi /Break	09/09-																																																						
1.8 TSi /Break	05/07-																																																						
1.8 TSi CC	11/11-																																																						
1.9 TDi /Break	03/05-																																																						
2.0 FSi /Break	03/05-																																																						
2.0 TFSi TSi/4WD/Break	09/07-																																																						
2.0 TFSi TSi CC	10/09-																																																						
2.0 TDi /4WD /Break	03/05-																																																						
2.0 TDi CC	11/11-																																																						
3.2 FSi /Break	12/05-																																																						
3.6 FSi /4WD /Break	05/07-																																																						
1.6i /Break	-ch 3C-6-050000 06/05-																																																						
9001737 OE 1K0511327AR	Palier de barre milieu <i>Middle bar main bearing</i>	2306014 OE 1K0511327AS	Palier de barre milieu <i>Middle bar main bearing</i>																																																				
	<p>1 Barre Ø 20.7</p> <table style="width: 100%; border-collapse: collapse;"> <tr><td style="width: 60%;">1.4 TSi /Break</td><td style="width: 40%;">11/07-</td></tr> <tr><td>1.4 TSi CC</td><td>11/11-</td></tr> <tr><td>1.6</td><td>06/05-</td></tr> <tr><td>1.6 FSi</td><td>09/05-</td></tr> <tr><td>1.6 TDi /Break</td><td>09/10-</td></tr> <tr><td>1.8 TSi /CC /Break</td><td>06/08-</td></tr> <tr><td>1.9 TDi</td><td>03/05-</td></tr> <tr><td>2.0 FSi /SW</td><td>03/05-</td></tr> <tr><td>2.0 TFSi/TSi/CC/Break</td><td>03/05-</td></tr> <tr><td>2.0 TDi /Break</td><td>03/05-</td></tr> <tr><td>2.0 TDi CC</td><td>11/11-</td></tr> </table>	1.4 TSi /Break	11/07-	1.4 TSi CC	11/11-	1.6	06/05-	1.6 FSi	09/05-	1.6 TDi /Break	09/10-	1.8 TSi /CC /Break	06/08-	1.9 TDi	03/05-	2.0 FSi /SW	03/05-	2.0 TFSi/TSi/CC/Break	03/05-	2.0 TDi /Break	03/05-	2.0 TDi CC	11/11-		<p>1 Barre Ø 21.7</p> <table style="width: 100%; border-collapse: collapse;"> <tr><td style="width: 60%;">1.4 TSi /Break</td><td style="width: 40%;">11/07-</td></tr> <tr><td>1.6i /Break</td><td>06/05-</td></tr> <tr><td>1.6 FSi /Break</td><td>03/05-</td></tr> <tr><td>1.6 TDi /Break</td><td>09/10-</td></tr> <tr><td>1.8 TSi /CC /Break</td><td>09/08-</td></tr> <tr><td>1.9 TDi /Break</td><td>03/05-</td></tr> <tr><td>2.0 FSi /Break</td><td>03/05-09/07</td></tr> <tr><td>2.0 FSi 4WD /Break</td><td>09/05-</td></tr> <tr><td>2.0 TFSi /Break</td><td>09/05-</td></tr> <tr><td>2.0 TDi/Break Equipt OBE/F/M</td><td>03/06-10/10</td></tr> <tr><td>2.0 TDi CC</td><td>06/08-07/11</td></tr> <tr><td>2.0 TDi /4WD /Break</td><td>03/05-04/08</td></tr> <tr><td>3.2 FSi 4WD DSG/Break</td><td>12/05-</td></tr> <tr><td>3.6 FSi 4WD/Break</td><td></td></tr> <tr><td>Equipt OBE/F/M</td><td>04/07-</td></tr> </table>	1.4 TSi /Break	11/07-	1.6i /Break	06/05-	1.6 FSi /Break	03/05-	1.6 TDi /Break	09/10-	1.8 TSi /CC /Break	09/08-	1.9 TDi /Break	03/05-	2.0 FSi /Break	03/05-09/07	2.0 FSi 4WD /Break	09/05-	2.0 TFSi /Break	09/05-	2.0 TDi/Break Equipt OBE/F/M	03/06-10/10	2.0 TDi CC	06/08-07/11	2.0 TDi /4WD /Break	03/05-04/08	3.2 FSi 4WD DSG/Break	12/05-	3.6 FSi 4WD/Break		Equipt OBE/F/M	04/07-
1.4 TSi /Break	11/07-																																																						
1.4 TSi CC	11/11-																																																						
1.6	06/05-																																																						
1.6 FSi	09/05-																																																						
1.6 TDi /Break	09/10-																																																						
1.8 TSi /CC /Break	06/08-																																																						
1.9 TDi	03/05-																																																						
2.0 FSi /SW	03/05-																																																						
2.0 TFSi/TSi/CC/Break	03/05-																																																						
2.0 TDi /Break	03/05-																																																						
2.0 TDi CC	11/11-																																																						
1.4 TSi /Break	11/07-																																																						
1.6i /Break	06/05-																																																						
1.6 FSi /Break	03/05-																																																						
1.6 TDi /Break	09/10-																																																						
1.8 TSi /CC /Break	09/08-																																																						
1.9 TDi /Break	03/05-																																																						
2.0 FSi /Break	03/05-09/07																																																						
2.0 FSi 4WD /Break	09/05-																																																						
2.0 TFSi /Break	09/05-																																																						
2.0 TDi/Break Equipt OBE/F/M	03/06-10/10																																																						
2.0 TDi CC	06/08-07/11																																																						
2.0 TDi /4WD /Break	03/05-04/08																																																						
3.2 FSi 4WD DSG/Break	12/05-																																																						
3.6 FSi 4WD/Break																																																							
Equipt OBE/F/M	04/07-																																																						

Eléments TRAIN ARRIERE

Rear axle parts
 Tren TRAS
 Elementy zawieszenia tylnego
 элементы задней оси.



9001786 OE 1K0505553A	Articulation essieu G/D inf. <i>Lower L/R axle bush</i>																		
	<p>Ø int. 12 Ø ext. 37 long. tube int. 50 ext. 28</p> <table style="width: 100%; border-collapse: collapse;"> <tr><td style="width: 60%;">1.4 TSi /Break</td><td style="width: 40%;">05/07-</td></tr> <tr><td>1.6 /Break</td><td>03/05-</td></tr> <tr><td>1.6 FSi /Break</td><td>03/05-</td></tr> <tr><td>1.8 TSi /Break</td><td>05/07-</td></tr> <tr><td>1.9 TDi /Break</td><td>03/05-</td></tr> <tr><td>2.0 FSi /Break</td><td>03/05-</td></tr> <tr><td>2.0 TDi /4WD /Break</td><td>03/05-</td></tr> <tr><td>3.2 FSi 4WD /Break</td><td>11/05-</td></tr> <tr><td>3.6 FSi 4WD /Break</td><td>04/07-</td></tr> </table>	1.4 TSi /Break	05/07-	1.6 /Break	03/05-	1.6 FSi /Break	03/05-	1.8 TSi /Break	05/07-	1.9 TDi /Break	03/05-	2.0 FSi /Break	03/05-	2.0 TDi /4WD /Break	03/05-	3.2 FSi 4WD /Break	11/05-	3.6 FSi 4WD /Break	04/07-
1.4 TSi /Break	05/07-																		
1.6 /Break	03/05-																		
1.6 FSi /Break	03/05-																		
1.8 TSi /Break	05/07-																		
1.9 TDi /Break	03/05-																		
2.0 FSi /Break	03/05-																		
2.0 TDi /4WD /Break	03/05-																		
3.2 FSi 4WD /Break	11/05-																		
3.6 FSi 4WD /Break	04/07-																		

Passat VII 10- ...

Eléments DIRECTION

Steering parts

Elementos Direcciones

Elementy uklad kierowniczy

Элементы рулевой системы

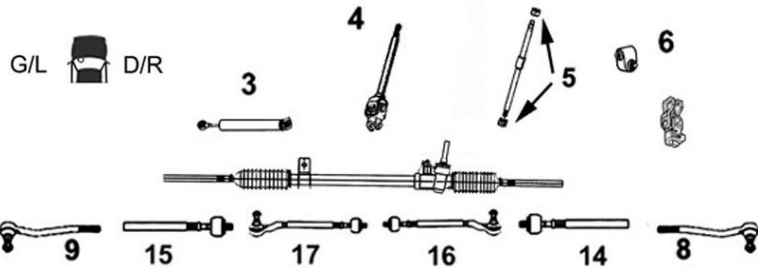

9006873

Axe de bielle G/D

OE 1K0423810A

L/R axial joint



14
15

Côté dir. M16x1.5 Côté rot. M16x1.5 long 310 mm

1.4 TSi /SW	10/10-
1.6 TDi FAP /SW	10/10-
1.8 TSi /SW	10/10-
2.0 TFSi /SW	10/10-
2.0 TSi 4WD SW	10/10-
2.0 TDi /SW /4WD	10/10-
3.6 FSi 4WD /SW	10/10-

9006638

Rotule de direction G

OE 1K0423811K

Left tie rod end



9

M16 x 1.5

1.4 TSi /ETH /GNV /SW	10/10-
1.6 TDi FAP /SW	10/10-
1.8 TSi /SW	10/10-
2.0 TFSi /SW /4WD	10/10-
2.0 TDi /SW /4WD	10/10-
3.6 FSi 4WD /SW	10/10-

9006637

Rotule de direction D

OE 1K0423812K

Right tie rod end



8

M16 x 1.5

1.4 TSi /ETH /GNV /SW	10/10-
1.6 TDi FAP /SW	10/10-
1.8 TSi /SW	10/10-
2.0 TFSi /SW /4WD	10/10-
2.0 TDi /SW /4WD	10/10-
3.6 FSi 4WD /SW	10/10-



Barre stabilisatrice

Stabilizer bar

Barra estabilizadora

Drażek stabilizatora

стабилизатор поперечной устойчивости

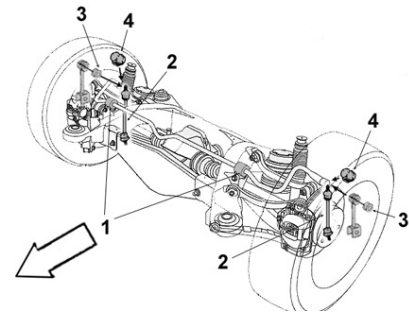

2306010

Biellette barre stab.

OE 1K0411315P

Stabilizer bar stub axle



2

1.4 TSi /SW	10/10-
1.6 TDi /SW	10/10-
1.8 TSi /SW	10/10-
2.0 TFSi /SW	11/10-
2.0 TSi 4WD	01/12-
2.0 TDi /SW /4WD	10/10-
3.6 FSi 4WD /SW	11/10-

... Passat VII 10- ...



Eléments SUSPENSION

Suspension parts

Elementos suspensión

Elementy zawieszenie

Элементы подвески

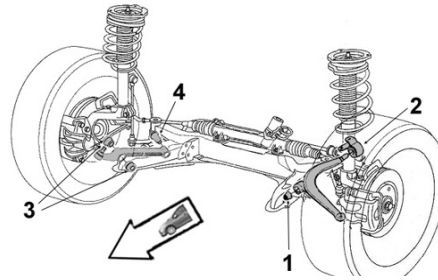

VOLKSWAGEN



9001759

Articulation AV inf.

OE 1K0407182

Front lower bush



1 Ø int.12 Ø ext.40 coll.48
long. tube int.54 ext.33 ep. coll.6

1.4 TSi / SW	10/10-
1.6 TDi FAP /SW	10/10-
1.8 TSi /SW	10/10-
2.0 TFSi /SW	11/10-
2.0 TSi 4WD	01/12-
2.0 TDi /SW /4WD	10/10-
3.6 FSi 4WD/ SW	11/10-

2256007

Articulation AR inf.

OE 3C0199231D

Rear lower bush

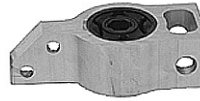

2

1.4 TSi / SW	10/10-
1.6 TDi FAP /SW	10/10-
1.8 TSi /SW	10/10-
2.0 TFSi /TSi /4WD/ SW	11/10-
2.0 TDi /SW /4WD	10/10-
3.6 FSi 4WD/ SW	11/10-

Bras & Triangle de suspension

Control arm

Brazo y triángulo

Wahacz

Рычаг подвески

G/L D/R

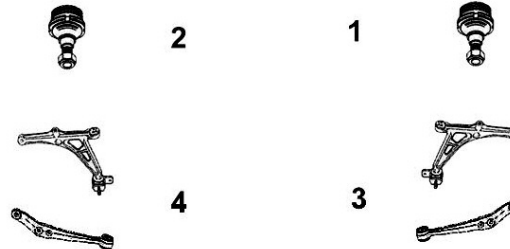

7476038

Triangle de susp. G/D

OE 3C0407151G

L/R track control arm



3 Sans rotule Without ball joint

1.4 TSi/ GNV/ ETH/ SW	10/10-
1.6 TDi FAP /SW	10/10-
1.8 TSi /SW	10/10-
2.0 TFSi /SW	10/10-
2.0 TDi /SW /4WD	10/10-
3.6 FSi /SW /4WD	10/10-



Support d'amortisseur

Suspension mounting

Soporte amortiguador

Poduszka amortyzatora

Опора амортизатора

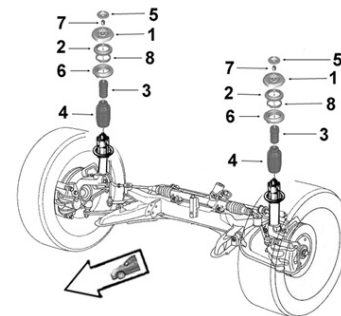

9005622

Support suspension G/D

OE 1K0412331B

L/R suspension mounting



1

1.4 TSi / SW	11/10-
1.6 TDi FAP /SW	10/10-
1.8 TSi /SW	10/10-
2.0 TFSi /SW	11/10-
2.0 TSi 4WD	01/12-
2.0 TDi /SW /4WD	10/10-
3.6 FSi 4WD/ SW	11/10-

2656004

Butée de suspension

OE 1K0412303E

Shock bush



3 H55

1.4 TSi /SW	10/10-
1.6 TDi /SW	10/10-
1.8 TSi /SW	10/10-
2.0 TFSi /SW	11/10-
2.0 TSi 4WD	01/12-
2.0 TDi /4WD /SW	10/10-
3.6 FSi 4WD/ SW	11/10-

... Passat VII 10-



Support d'amortisseur
 Suspension mounting
 Soporte amortiguador
 Poduszka amortyzatora
 Опора амортизатора

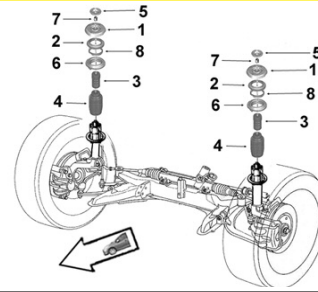

2656052 Butée de suspension
 OE 1K0412303B Shock bush



3 H70	
1.4 TSi / SW	10/10-
1.6 TDi /SW	10/10-
1.8 TSi /SW	10/10-
2.0 TFSi /SW	11/10-
2.0 TSi 4WD	01/12-
2.0 TDi /SW /4WD	10/10-
3.6 FSi 4WD/ SW	11/10-

2656053 Protecteur amortisseur G/D
 OE 6N0413175A L/R shock absorber protector



4 H206	
1.4 TSi / SW	10/10-
1.6 TDi FAP /SW	10/10-
1.8 TSi /SW	10/10-
2.0 TFSi /SW	11/10-
2.0 TSi 4WD	01/12-
2.0 TDi /SW /4WD	10/10-
3.6 FSi 4WD/ SW	11/10-



Barre stabilisatrice
 Stabilizer bar
 Barra estabilizadora
 Drażek stabilizatora
 стабилизатор поперечной устойчивости

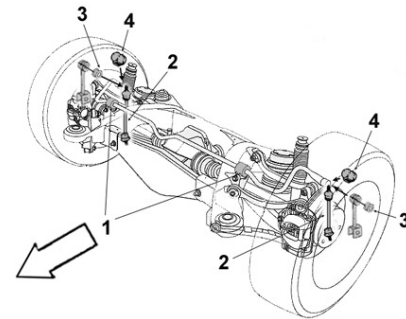

9005094 Biellette barre stab.
 OE 1K0505465K Stabilizer bar stub axle



2	
1.4 TSi / SW	10/10-
1.6 TDi FAP /SW	10/10-
1.8 TSi /SW	10/10-
2.0 TFSi /SW	11/10-
2.0 TSi 4WD	01/12-
2.0 TDi /SW /4WD	10/10-
3.6 FSi 4WD/ SW	11/10-

9001737 Palier de barre milieu
 OE 1K0511327AR Middle bar main bearing



1 Barre Ø 20.7	
1.4 TSi / SW	10/10-
1.6 TDi /SW	10/10-
1.8 TSi /SW	10/10-
2.0 TFSi /SW	11/10-
2.0 TSi 4WD	01/12-
2.0 TDi /SW /4WD	10/10-

2306014 Palier de barre milieu
 OE 1K0511327AS Middle bar main bearing



1 Barre Ø 21.7	
1.4 TSi / SW	10/10-
1.6 TDi FAP /SW	10/10-
1.8 TSi /SW	10/10-
2.0 TFSi /SW	11/10-
2.0 TSi 4WD	01/12-
2.0 TDi /SW /4WD	10/10-
3.6 FSi 4WD/ SW	11/10-

Eléments TRAIN ARRIERE
 Rear axle parts
 Tren TRAS
 Elementy zawieszenia tylnego
 элементы задней оси.



9001786 Articulation essieu G/D inf.
 OE 1K0505553A Lower L/R axle bush
 Ø int. 12 Ø ext. 37 long. tube int. 50 ext. 28



1.4 TSi / SW	10/10-
1.6 TDi /SW	10/10-
1.8 TSi /SW	10/10-
2.0 TFSi /SW	11/10-
2.0 TSi 4WD	01/12-
2.0 TDi /SW /4WD	10/10-
3.6 FSi 4WD/ SW	11/10-

Phaeton

Bras & Triangle de suspension

Control arm
Brazo y triángulo
Wahacz
Рычаг подвески

G/L  D/R



VOLKSWAGEN 

7476204 Bras de suspension Sup. AR G
OE 4E0407509E Rear Upper left track control arm

NEW



4 Avec rotule With ball joint Ø 18

3.0 TDi 4WD 09/04-
3.2i VR6 24v. /4WD 10/02-
4.2i V8 32v. 4WD 10/03-
5.0 TDi 4WD 05/03-
6.0i 4WD 11/02-

7476205 Bras de suspension Sup. AR D
OE 4E0407510E Rear Upper right track control arm

NEW



3 Avec rotule With ball joint Ø 18

3.0 TDi 4WD 09/04-
3.2i VR6 24v. /4WD 10/02-
4.2i V8 32v. 4WD 10/03-
5.0 TDi 4WD 05/03-
6.0i 4WD 11/02-

7476208 Bras de suspension Sup. AV G
OE 4E0407505E Front upper left track control arm

NEW



4 Avec rotule With ball joint Ø 18

3.0 TDi 4WD 09/04-
3.2i VR6 24v. /4WD 10/02-
4.2i V8 32v. 4WD 10/03-
5.0 TDi 4WD 05/03-
6.0i 4WD 11/02-

7476209 Bras de suspension Sup. AV D
OE 4E0407506E Front upper right track control arm

NEW



3 Avec rotule With ball joint Ø 18

3.0 TDi 4WD 09/04-
3.2i VR6 24v. /4WD 10/02-
4.2i V8 32v. 4WD 10/03-
5.0 TDi 4WD 05/03-
6.0i 4WD 11/02-

Polo -05/09 ...

Eléments DIRECTION

Steering parts
Elementos Direcciones
Elementy układ kierowniczy
Элементы рулевой системы

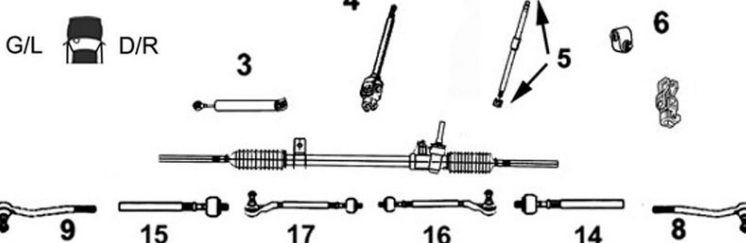

9006234 Axe de bielle G/D
Part/oe 6N0419804 L/R axial joint



14 Côté dir. M22x1.5 Côté rot. M14x1.5
15 long 320 mm

TT /all models 3/5ptes DNA
10/94-07/98

9006235 Axe de bielle G/D
Part/oe 6N0422803A L/R axial joint



14 Côté dir. M14x1.5 Côté rot. M14x1.5
15 long 311 mm

TT /all models 3/5ptes DA
10/94-07/98

9006251 Axe de bielle G/D
Part/oe 6Q0423803E L/R axial joint



14 Côté dir. M14x1.5 Côté rot. M14x1.5 long 295 mm
15 Dir. TRW Ch- 9N-3-190000

1.2 3/5ptes 01/02-
1.2i 12v. 3/5ptes /Dune 01/02-07/07
1.4i 16v. 3/5ptes 01/02-
1.4 TDi 3/5ptes /Dune 01/02-
1.9 SDi 3/5ptes 01/02-
1.9 TDi 3/5ptes /Dune 01/02-

... Polo -05/09 ...

Eléments DIRECTION

Steering parts







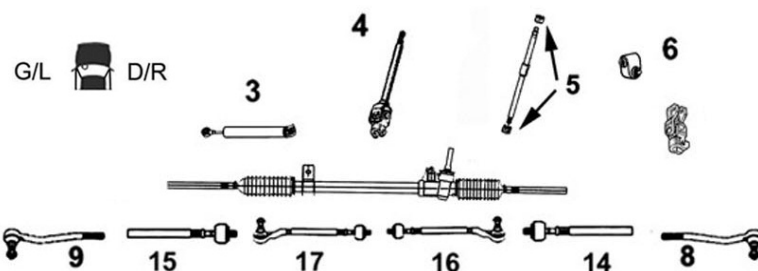

Elementos Direcciones

Elementy układ kierowniczy



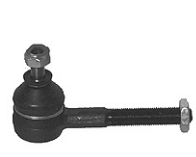





Элементы рулевой системы



VOLKSWAGEN BASIC

<p>9006251 Part/oe 6X0422804</p> 	<p>Axe de bielle G/D <i>L/R axial joint</i></p> <p>14 Côté dir. M14x1.5 Côté rot. M14x1.5 15 long 295 mm</p> <p>1.4 DA Ch- 9N-3-190000 11/99-12/01</p> <p>1.9 SDi Ch- 9N-3-190000 11/99-12/01</p>	<p>9006869 Part/oe 6N0422804C</p> 	<p>Axe de bielle G/D <i>L/R axial joint</i></p> <p>14 Côté dir. M14x1.5 Côté rot. M14x1.5 15 long 292 mm</p> <p>1.4i 16v. 11/99-12/01 1.4 TDi 11/99-12/01 1.6 GTi 16v. 11/99-12/01</p>
<p>9006872 Part/oe 6K0422803E</p> 	<p>Axe de bielle G/D <i>L/R axial joint</i></p> <p>14 Côté dir. M14x1.5 Côté rot. M14x1.5 15 long 318 mm</p> <p>1.4i Classic /Flight / Break -11/99 1.6i Flight 03/96-11/99 1.9 SDi /Flight / Break -11/99</p>	<p>9006874 OE 6Q0423810C</p> 	<p>Axe de bielle G/D <i>L/R axial joint</i></p> <p>14 Côté dir. M16x1.5 Côté rot. M14x1.5 15 long 299 mm Dir. SMI Koyo</p> <p>1.2i 3/5ptes 01/02-31/12/06 1.2i 12v. 3/5ptes /Dune 01/02-31/12/06 1.4i 06/05-31/12/06 1.4i 16v. 3/5ptes 01/02-31/12/06 1.4 TDi /Dune 05/05-31/12/06 1.6i 05/06-31/12/06 1.8 GTi 04/06-31/12/06 1.9 SDi 3/5ptes 01/02-31/12/06 1.9 TDi 3/5ptes /Dune 01/02-31/12/06</p>
<p>9006237 OE 871419801A</p> 	<p>Bielle de direction G <i>Left steering rod</i></p> <p>17</p> <p>TT /all models Sauf 1.3 G40 08/82-09/94</p>	<p>9006382 OE 811419812</p> 	<p>Rotule de direction G/D <i>L/R tie rod end</i></p> <p>8 M14 x 1.5 9</p> <p>TT /all models Sauf 1.3 G40 08/82-09/94</p>
<p>9006619 OE 6N0419811</p> 	<p>Rotule de direction G <i>Left tie rod end</i></p> <p>9 M14 x 1.5</p> <p>TT /all models 3/5ptes DNA DA 10/94-07/98</p>	<p>9006618 OE 6N0419812</p> 	<p>Rotule de direction D <i>Right tie rod end</i></p> <p>8 M14 x 1.5</p> <p>TT /all models 3/5ptes DNA DA 10/94-07/98</p>
<p>9006380 OE 3A0422811</p> 	<p>Rotule de direction G <i>Left tie rod end</i></p> <p>9 M14 x 1.5</p> <p>TT /all models Flight 10/94-12/99</p>	<p>9006381 OE 3A0422812</p> 	<p>Rotule de direction D <i>Right tie rod end</i></p> <p>8 M14 x 1.5</p> <p>TT /all models Flight 10/94-12/99</p>

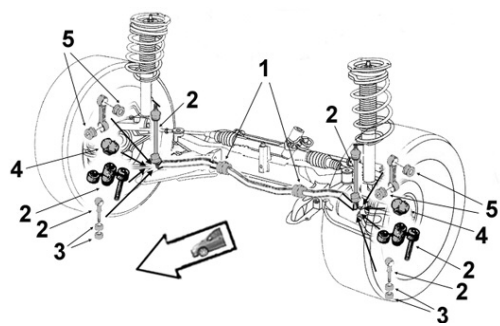
... Polo -05/09 ...

9006628 OE 6X0422811	Rotule de direction G <i>Left tie rod end</i>	9006629 OE 6X0422812	Rotule de direction D <i>Right tie rod end</i>
	9 M14 x 1.5 TT /all models 11/99-12/01		8 M14 x 1.5 TT /all models 11/99-12/01
9006634 OE 6Q0423811	Rotule de direction G <i>Left tie rod end</i>	9006635 OE 6Q0423812	Rotule de direction D <i>Right tie rod end</i>
	9 M14 x 1.5 Dir. SMI Koyo TRW 1.2i 3/5ptes 01/02- 1.2i 12v. 3/5ptes /Dune 01/02- 1.4i 16v. /Croospolo 3/5ptes 01/02- 1.9 SDi 3/5ptes 01/02- 1.9 TDi 3/5ptes /Dune 01/02- OE 6Q0423811C 1.4 06/05- 1.4 TDi /Crosspolo /Dune /Fox 01/02- 1.6i 05/06- 1.8 GTi 04/06-		8 M14 x 1.5 Dir. SMI Koyo TRW 1.2i 3/5ptes 01/02- 1.2i 12v. 3/5ptes /Dune 01/02- 1.4i 16v. /Croospolo 3/5ptes 01/02- 1.9 SDi 3/5ptes 01/02- 1.9 TDi 3/5ptes /Dune 01/02- OE 6Q0423812C 1.4 06/05- 1.4 TDi /Crosspolo /Dune /Fox 01/02- 1.6i 05/06- 1.8 GTi 04/06-
9004011 OE 867419507	Axe de volant <i>Steering wheel shaft</i>		
	4 TT /all models 01/91-09/94		
	Barre stabilisatrice <i>Stabilizer bar</i> <i>Barra estabilizadora</i> <i>Drażek stabilizatora</i> стабилизатор поперечной устойчивости		
			
9005089 OE 6Q0411315N	Biellette barre stab. <i>Stabilizer bar stub axle</i>	9005080 OE 6N0411315	Biellette barre stab. <i>Stabilizer bar stub axle</i>
	2 1.2 01/02- 1.2i 12v. 01/02- 1.4i 16v. 01/02- 1.4 TDi 01/02- 1.6i 05/06- 1.8 GTi 04/06- 1.9 SDi 01/02- 1.9 TDi 01/02-		2 Ø 18 Axe fileté M 8 x 1.25 1.3i 10/94- 1.4 10/99- 1.4i 16v. 10/96- 1.4 TDi 10/99- 1.6 10/94- 1.6 GTi 16v. 10/99- 1.9 D 01/96- 1.9 SDi 01/97-

... Polo -05/09 ...



Barre stabilisatrice
 Stabilizer bar
 Barra estabilizadora
 Drążek stabilizatora
 стабилизатор поперечной устойчивости

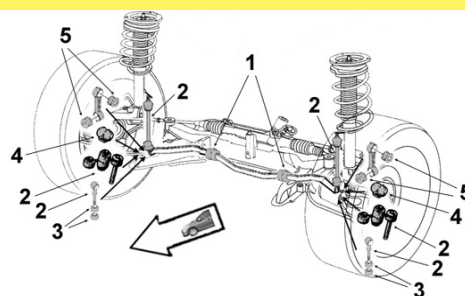

VOLKSWAGEN BASIC

2306001 OE 6N0411315D	Biellette barre stab. <i>Stabilizer bar stub axle</i>	9001526 OE 867411313	Palier de barre milieu <i>Middle bar main bearing</i>
	2 Ø 20 Axe fileté M 8 x 1.25 1.4i 11/99-12/01 1.4i 16v. 10/96-12/01 1.4 TDi 11/99-12/01 1.6 GTi 16v. 11/99-12/01 1.9 SDi 11/99-12/01		1 Ø int.16.5 1.0 01/84-09/94 1.0 Variant 06/91-06/94 1.1 01/84-09/94 1.3 01/84-09/94 1.3 D 01/84-09/94 1.4 D 01/84-09/94 1.4 D Variant 06/91-06/94
9001522 OE 191411314	Palier de barre milieu <i>Middle bar main bearing</i>	2306019 OE 6Q0411314R	Palier de barre milieu <i>Middle bar main bearing</i>
	1 Barre Ø 17 1.3i 10/94- 1.4 10/95- 1.4 Flight /Variant 01/95- 1.4i 16v. 10/96- 1.6 10/94- 1.6 Flight /Variant 01/95- 1.9 D 01/96- 1.9 SDi 01/97- 1.9 SDi Flight /Variant 01/95-		1 Barre Ø 18 1.2i /12v. 04/02- 1.4i 16v. 01/02- 1.4 TDi 01/02- 1.6i 05/06-09/09 1.8 GTI 04/06-09/09 1.9 SDi -ch 9N-3-150000 01/02- 1.9 TDi 01/02-
2306020 OE 6X0411313	Palier de barre milieu <i>Middle bar main bearing</i>	2306017 OE 6Q0411314P	Palier de barre milieu <i>Middle bar main bearing</i>
	1 Barre Ø 18 1.3i 10/94-12/95 1.4i 10/95-12/01 1.4i 16v. 11/99-12/01 1.4 TDi 11/99-12/01 1.6i 10/94-11/99 1.6 GTi 16v. 11/99-12/01 1.9 D 01/96-11/99 1.9 SDi 01/97-12/01		1 Barre Ø 18 1.2i /12v. Ch- 9N3150001 1.4i 16v. Ch- 9N3150001 1.4 TDi Ch- 9N3150001 1.6i 05/06- 1.9 SDi Ch- 9N3150001 01/02-05/05 1.9 TDi Ch- 9N3150001 01/04-
2306015 OE 6Q0411314F	Palier de barre milieu <i>Middle bar main bearing</i>	2306018 OE 6Q0411314Q	Palier de barre milieu <i>Middle bar main bearing</i>
	1 Ø 19 -ch 9N-3-150000 1.2i 04/02- 1.2i 12v. 01/02- 1.4i 16v. 01/02- 1.4 TDi 01/02- 1.9 SDi 01/02- 1.9 TDi 01/02-		1 Barre Ø 19 1.2i /12v. Ch- 9N-3-150001 1.4i 16v. Ch- 9N-3-150001 1.4 TDi Ch- 9N-3-150001 1.6i 05/06- 1.9 SDi Ch- 9N-3-150001 1.9 TDi Ch- 9N-3-150001
2306021 OE 6X0411313A	Palier de barre milieu <i>Middle bar main bearing</i>	2306022 OE 8Z0411314B	Palier de barre milieu <i>Middle bar main bearing</i>
	1 Barre Ø 20 1.4i 11/99-12/01 1.4i 16v. 10/96-12/01 1.4 TDi 11/99-12/01 1.6 GTi 16v. 11/99-12/01 1.9 SDi 11/99-12/01		1 Barre Ø 20 -ch 9N-3D170762 -ch 9N-3Y245376 1.2i 04/02-05/05 1.2i 12v. 01/02-12/05 1.4i 16v. 01/02-05/05 1.4 TDi 01/02-12/05 1.9 SDi 01/02-05/05 1.9 TDi 01/02-12/05

... Polo -05/09 ...



Eléments SUSPENSION
Suspension parts
Elementos suspensión
Elementy zawieszenie
Элементы подвески

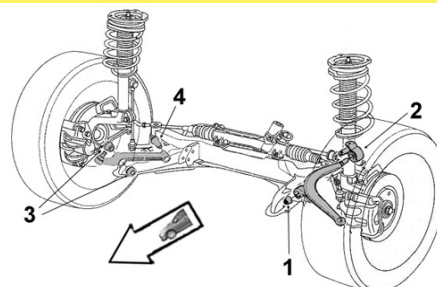

VOLKSWAGEN



2256008 OE 6N0407182	Articulation AV <i>Front bush</i>	2256038 OE 6Q0407182A	Articulation AV <i>Front bush</i>
	1 Ø int. 10 Ø ext. 28 Coll. 34 long. tube int. 47 ext. 25 1.0 10/94-09/01 1.3 10/94-07/95 1.4i 08/95-09/01 1.4i 16v. 04/96-09/01 1.4 TDi 10/99-09/01 1.6 GTi 09/98-09/01 1.6i 10/94-10/99 1.7 SDi 04/97-09/01 1.9 D 10/94-09/01 1.9 SDi 07/96-09/01		1 Ø int. 12 Ø ext. 33 coll. 39 long. tube int. 54 ext. 30 1.2i 04/02-04/07 1.2i 12v. 01/02-04/07 1.4i 07/03- 1.4i 16v. 01/02-05/08 1.4 FSi 03/02-07/06 1.4 TDi 01/02- 1.9 SDi 01/02- 1.9 TDi 01/04-
9001523 OE 357407182	Articulation AV <i>Front bush</i>	2256001 OE 6Q0407183A	Articulation AR <i>Rear bush</i>
	1 Ø int.12 Ø ext.33 coll.36 long. tube int.54 ext.29 ep. coll.5 1.3i 10/94- 1.4 /Flight /Variant 01/95- 1.4i 16v. 10/96- 1.6 /Flight /Variant 10/94- 1.8 Flight /Variant 01/95- 1.9 D /Flight /Variant 01/95- 1.9 SDi /Flight /Variant 01/95- 1.9 TDi Flight /Variant 01/95-		2 Ø int.18.5 Ø ext.64 coll.71.5 long. tube int.35 ext.46 1.2i 04/02-05/07 1.2i 12v. /Dune 01/02-07/07 1.4i 16v. 01/02- 1.4 TDi /Dune -ch 9N-9-050000 1.9 SDi 01/02- 1.9 TDi /Dune -ch 9N-9-050000 01/02-
9001692 OE 6N0407181	Articulation AR <i>Rear bush</i>	9001520 OE 191407181D	Articulation AR <i>Rear bush</i>
	2 Ø int.17 Ø ext.59.5 long. tube int.46 ext.23.5 1.3i 10/94- 1.4 10/95- 1.4i 16v. 10/96- 1.4 TDi 10/99- 1.6 10/94- 1.6 GTi 16v. 10/99- 1.9 D 01/96- 1.9 SDi 01/97-		2 Ø int.17 Ø ext.60.5 long. tube int.41 ext.24.5 1.4 Flight /Variant 01/95- 1.6 Flight /Variant 01/95- 1.8 Flight /Variant 01/95- 1.9 D Flight /Variant 01/95- 1.9 SDi Flight /Variant 01/95- 1.9 TDi Flight /Variant 01/95-
9001525 OE 861407183	Articulation ext. <i>Outer bush</i>		
	3 Ø int.12 Ø ext.33.5 coll.39 long. tube int.44.5 ext.16 ep. coll.6 1.0 Variant 06/91-06/94 1.05 01/84-09/94 1.1 01/84-09/94 1.3 01/84-09/94 1.3 Variant 06/91-06/94 1.3 D 01/84-09/94 1.4 D 01/84-09/94 1.4 D Variant 06/91-06/94		
9001524 OE 823407181	Articulation int. <i>Inner bush</i>		
	4 Ø int.10 Ø ext.37.5 coll.42 long. tube int.44 ext.16 ep. coll.7 1.0 Variant 06/91-06/94 1.05 06/91- 1.3 Variant 06/91-06/94 1.3i 06/91- 1.4 D 06/91- 1.4 D Variant 06/91-06/94		

... Polo -05/09 ...

SASIC

VOLKSWAGEN

Bras & Triangle de suspension

Control arm
Brazo y triángulo
Wahacz
Рычаг подвески



G/L  D/R





9005132 OE 861407151B 	Bras de suspension G/D <i>L/R track control arm</i> 3 Avec rotule <i>With ball joint</i> 4 TT /all models Sauf G40 08/82-09/94	9005138 OE 6N0407151B 	Triangle de susp. G/D <i>L/R track control arm</i> 3 Sans rotule <i>Without tie rod end</i> 4 TT /all models 3/5ptes 10/94-12/99 OE 6X0407151A TT /all models 11/99-12/01
9005133 OE 191407151B 	Triangle de susp. G/D <i>L/R track control arm</i> 3 Sans rotule <i>Without tie rod end</i> 4 TT /all models Flight /Variant 10/94-12/99		
7476107 OE 191407151B+357407365 <i>Left track control arm</i> 	Triangle de susp. G 4 Avec rotule <i>With ball joint</i> Ø 19 TT /all models Flight 10/94-12/99	7476108 OE 191407151B+357407365 <i>Right track control arm</i> 	Triangle de susp. D 3 Avec rotule <i>With ball joint</i> Ø 19 TT /all models Flight 10/94-12/99
7476121 OE 6N0407151B+6N0407365 <i>Left track control arm</i> 	Triangle de susp. G 4 Avec rotule <i>With ball joint</i> TT /all models 3/5ptes 10/94-12/99 TT /all models 11/99-12/01	7476120 OE 6N0407151B+6N0407365A <i>Right track control arm</i> 	Triangle de susp. D 3 Avec rotule <i>With ball joint</i> TT /all models 3/5ptes 10/94-12/99 TT /all models 11/99-12/01
9005758 OE 6Q0407151L 	Triangle de susp. inf. G/D <i>Lower L/R track control arm</i> 3 Sans rotule <i>Without tie rod end</i> -ch 9N-9-050000 4 1.2 3/5ptes 01/02- 1.2i 12v. 3/5ptes /Dune 01/02- 1.4 06/05- 1.4i 16v. 3/5ptes 01/02- 1.4 TDi 3/5ptes /Dune 01/02- 1.6i 05/06- 1.8i GTi 04/06- 1.9 SDi 3/5ptes 01/02- 1.9 TDi 3/5ptes /Dune 01/02-		

... Polo -05/09 ...

<p>7476123 OE 6Q0407151L+6Q0407365M <i>Left track control arm</i></p>	<p>Triangle de susp. G 4 Avec rotule With ball joint -ch 9N-9-050000</p> <table style="width: 100%; border-collapse: collapse;"> <tr><td>1.2 3/5ptes</td><td>01/02-</td></tr> <tr><td>1.2i 12v. 3/5ptes /Dune</td><td>01/02-</td></tr> <tr><td>1.4</td><td>06/05-</td></tr> <tr><td>1.4i 16v. 3/5ptes</td><td>01/02-</td></tr> <tr><td>1.4 TDi 3/5ptes</td><td>01/02-</td></tr> <tr><td>1.9 SDi 3/5ptes</td><td>01/02-</td></tr> <tr><td>1.9 TDi 3/5ptes /Dune</td><td>01/02-</td></tr> </table>	1.2 3/5ptes	01/02-	1.2i 12v. 3/5ptes /Dune	01/02-	1.4	06/05-	1.4i 16v. 3/5ptes	01/02-	1.4 TDi 3/5ptes	01/02-	1.9 SDi 3/5ptes	01/02-	1.9 TDi 3/5ptes /Dune	01/02-	<p>7476122 OE 6Q0407151L+6Q0407365M <i>Right track control arm</i></p>	<p>Triangle de susp. D 3 Avec rotule With ball joint -ch 9N-9-050000</p> <table style="width: 100%; border-collapse: collapse;"> <tr><td>1.2 3/5ptes</td><td>01/02-</td></tr> <tr><td>1.2i 12v. 3/5ptes /Dune</td><td>01/02-</td></tr> <tr><td>1.4</td><td>06/05-</td></tr> <tr><td>1.4i 16v. 3/5ptes</td><td>01/02-</td></tr> <tr><td>1.4 TDi 3/5ptes</td><td>01/02-</td></tr> <tr><td>1.9 SDi 3/5ptes</td><td>01/02-</td></tr> <tr><td>1.9 TDi 3/5ptes /Dune</td><td>01/02-</td></tr> </table>	1.2 3/5ptes	01/02-	1.2i 12v. 3/5ptes /Dune	01/02-	1.4	06/05-	1.4i 16v. 3/5ptes	01/02-	1.4 TDi 3/5ptes	01/02-	1.9 SDi 3/5ptes	01/02-	1.9 TDi 3/5ptes /Dune	01/02-
1.2 3/5ptes	01/02-																														
1.2i 12v. 3/5ptes /Dune	01/02-																														
1.4	06/05-																														
1.4i 16v. 3/5ptes	01/02-																														
1.4 TDi 3/5ptes	01/02-																														
1.9 SDi 3/5ptes	01/02-																														
1.9 TDi 3/5ptes /Dune	01/02-																														
1.2 3/5ptes	01/02-																														
1.2i 12v. 3/5ptes /Dune	01/02-																														
1.4	06/05-																														
1.4i 16v. 3/5ptes	01/02-																														
1.4 TDi 3/5ptes	01/02-																														
1.9 SDi 3/5ptes	01/02-																														
1.9 TDi 3/5ptes /Dune	01/02-																														

<p>9005270 OE 6N0407365</p>	<p>Rotule de susp. inf. G <i>Left lower suspension ball joint</i></p>	<p>9005269 OE 6N0407365A</p>	<p>Rotule de susp. inf. D <i>Right lower suspension ball joint</i></p>								
	<p>2 Axe Ø 15</p> <table style="width: 100%; border-collapse: collapse;"> <tr><td>TT /all models 3/5ptes</td><td>10/94-12/99</td></tr> <tr><td>TT /all models</td><td>11/99-12/01</td></tr> </table>	TT /all models 3/5ptes	10/94-12/99	TT /all models	11/99-12/01		<p>1 Axe Ø 15</p> <table style="width: 100%; border-collapse: collapse;"> <tr><td>TT /all models 3/5ptes</td><td>10/94-12/99</td></tr> <tr><td>TT /all models</td><td>11/99-12/01</td></tr> </table>	TT /all models 3/5ptes	10/94-12/99	TT /all models	11/99-12/01
TT /all models 3/5ptes	10/94-12/99										
TT /all models	11/99-12/01										
TT /all models 3/5ptes	10/94-12/99										
TT /all models	11/99-12/01										



<p>9005260 OE 357407365</p>	<p>Rotule de susp. inf. G/D <i>L/R lower suspension ball joint</i></p>				
	<p>1 Ø 19 Cylindrique</p> <table style="width: 100%; border-collapse: collapse;"> <tr><td>TT /all models Flight</td><td>10/94-12/99</td></tr> </table>			TT /all models Flight	10/94-12/99
TT /all models Flight	10/94-12/99				

<p>9005478 OE 6Q0407365M</p>	<p>Rotule de susp. inf. G <i>Left lower suspension ball joint</i></p>	<p>9005479 OE 6Q0407366M</p>	<p>Rotule de susp. inf. D <i>Right lower suspension ball joint</i></p>																																				
	<p>2 -ch 9N-9-050000</p> <table style="width: 100%; border-collapse: collapse;"> <tr><td>1.2 3/5ptes</td><td>01/02-</td></tr> <tr><td>1.2i 12v. 3/5ptes/Dune</td><td>01/02-</td></tr> <tr><td>1.4i</td><td>06/05-</td></tr> <tr><td>1.4i 16v. 3/5ptes</td><td>01/02-</td></tr> <tr><td>1.4 TDi 3/5ptes /Dune</td><td>01/02-</td></tr> <tr><td>1.6i 16v.</td><td>05/06-</td></tr> <tr><td>1.8 GTi Turbo</td><td>04/06-</td></tr> <tr><td>1.9 SDi 3/5ptes</td><td>01/02-</td></tr> <tr><td>1.9 TDi 3/5ptes /Dune</td><td>01/02-</td></tr> </table>	1.2 3/5ptes	01/02-	1.2i 12v. 3/5ptes/Dune	01/02-	1.4i	06/05-	1.4i 16v. 3/5ptes	01/02-	1.4 TDi 3/5ptes /Dune	01/02-	1.6i 16v.	05/06-	1.8 GTi Turbo	04/06-	1.9 SDi 3/5ptes	01/02-	1.9 TDi 3/5ptes /Dune	01/02-		<p>1 -ch 9N-9-050000</p> <table style="width: 100%; border-collapse: collapse;"> <tr><td>1.2 3/5ptes</td><td>01/02-</td></tr> <tr><td>1.2i 12v. 3/5ptes/Dune</td><td>01/02-</td></tr> <tr><td>1.4i</td><td>06/05-</td></tr> <tr><td>1.4i 16v. 3/5ptes</td><td>01/02-</td></tr> <tr><td>1.4 TDi 3/5ptes /Dune</td><td>01/02-</td></tr> <tr><td>1.6i 16v.</td><td>05/06-</td></tr> <tr><td>1.8 GTi Turbo</td><td>04/06-</td></tr> <tr><td>1.9 SDi 3/5ptes</td><td>01/02-</td></tr> <tr><td>1.9 TDi 3/5ptes /Dune</td><td>01/02-</td></tr> </table>	1.2 3/5ptes	01/02-	1.2i 12v. 3/5ptes/Dune	01/02-	1.4i	06/05-	1.4i 16v. 3/5ptes	01/02-	1.4 TDi 3/5ptes /Dune	01/02-	1.6i 16v.	05/06-	1.8 GTi Turbo	04/06-	1.9 SDi 3/5ptes	01/02-	1.9 TDi 3/5ptes /Dune	01/02-
1.2 3/5ptes	01/02-																																						
1.2i 12v. 3/5ptes/Dune	01/02-																																						
1.4i	06/05-																																						
1.4i 16v. 3/5ptes	01/02-																																						
1.4 TDi 3/5ptes /Dune	01/02-																																						
1.6i 16v.	05/06-																																						
1.8 GTi Turbo	04/06-																																						
1.9 SDi 3/5ptes	01/02-																																						
1.9 TDi 3/5ptes /Dune	01/02-																																						
1.2 3/5ptes	01/02-																																						
1.2i 12v. 3/5ptes/Dune	01/02-																																						
1.4i	06/05-																																						
1.4i 16v. 3/5ptes	01/02-																																						
1.4 TDi 3/5ptes /Dune	01/02-																																						
1.6i 16v.	05/06-																																						
1.8 GTi Turbo	04/06-																																						
1.9 SDi 3/5ptes	01/02-																																						
1.9 TDi 3/5ptes /Dune	01/02-																																						

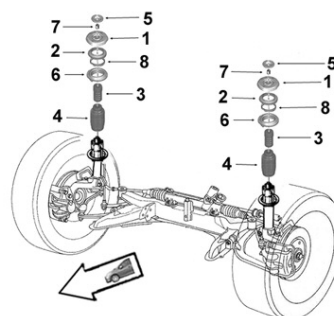

Support d'amortisseur
Suspension mounting
Soporte amortiguador
Poduszka amortyzatora
Опора амортизатора



<p>8005201 OE 871412323A</p>	<p>Support suspension G/D <i>L/R suspension mounting</i></p>	<p>9005616 OE 6N0412331A</p>	<p>Support suspension G/D <i>L/R suspension mounting</i></p>																										
	<p>1 Avec roulement With bearing</p> <table style="width: 100%; border-collapse: collapse;"> <tr><td>1.0 Variant</td><td>06/91-09/94</td></tr> <tr><td>1.1</td><td>01/84-06/94</td></tr> <tr><td>1.3</td><td>01/84-06/94</td></tr> <tr><td>1.3 Variant</td><td>06/91-09/94</td></tr> <tr><td>1.3 D</td><td>01/84-06/94</td></tr> <tr><td>1.4 D</td><td>01/84-06/94</td></tr> <tr><td>1.4 D Variant</td><td>06/91-09/94</td></tr> </table>	1.0 Variant	06/91-09/94	1.1	01/84-06/94	1.3	01/84-06/94	1.3 Variant	06/91-09/94	1.3 D	01/84-06/94	1.4 D	01/84-06/94	1.4 D Variant	06/91-09/94		<p>1</p> <table style="width: 100%; border-collapse: collapse;"> <tr><td>1.3i</td><td>10/94-</td></tr> <tr><td>1.4</td><td>10/95-</td></tr> <tr><td>1.4i 16v.</td><td>10/96-</td></tr> <tr><td>1.6</td><td>10/94-</td></tr> <tr><td>1.9 D</td><td>01/96-</td></tr> <tr><td>1.9 SDi</td><td>01/97-</td></tr> </table>	1.3i	10/94-	1.4	10/95-	1.4i 16v.	10/96-	1.6	10/94-	1.9 D	01/96-	1.9 SDi	01/97-
1.0 Variant	06/91-09/94																												
1.1	01/84-06/94																												
1.3	01/84-06/94																												
1.3 Variant	06/91-09/94																												
1.3 D	01/84-06/94																												
1.4 D	01/84-06/94																												
1.4 D Variant	06/91-09/94																												
1.3i	10/94-																												
1.4	10/95-																												
1.4i 16v.	10/96-																												
1.6	10/94-																												
1.9 D	01/96-																												
1.9 SDi	01/97-																												

... Polo -05/09 ...







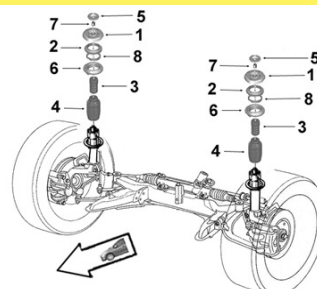

SASIC

VOLKSWAGEN





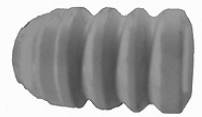





Support d'amortisseur
Suspension mounting
Soporte amortiguador
Poduszka amortyzatora
Опора амортизатора

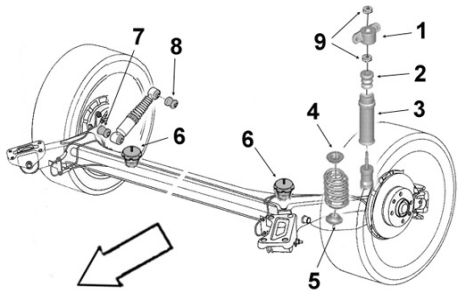

9001709 OE 357412331A	Support suspension G/D <i>L/R suspension mounting</i>	9005623 OE 6N0412331E	Support suspension G/D <i>L/R suspension mounting</i>
	1 1.4 Flight /Variant 01/95- 1.6 Flight /Variant 01/95- 1.9 SDi Flight /Variant 01/95-		1 1.2/i 12v. 01/02- 1.4/i 16v. 10/99- 1.4 TDi 10/99- 1.6 GTi 16v. 10/99- 1.6i 05/06-09/09 1.9 SDi 10/99- 1.9 TDi 01/02-
9005352 OE 1J0412249	Butée à billes G/D <i>L/R ball bearing</i>		
	2 1.3i 10/94- 1.4 10/94- 1.6 10/94- 1.9 D 01/96- 1.9 SDi 01/97-		
2656008 OE 6N0412303A	Butée de suspension <i>Shock bush</i>		
	3 H63 1.2i Sauf châssis sport 04/02-04/07 1.2i 04/07-09/09 1.2i 12v. Sauf châssis sport 01/02-04/07 1.4i Sauf châssis sport 11/99-12/01 1.4i 16v. Sauf châssis sport 11/99-04/07 1.4i 16v. 05/06-09/09 1.4 TDi Sauf châssis sport 11/99-05/09 1.6 GTi 16v. Sauf châssis sport 11/99-12/01 1.6i 05/06-09/09 1.9 SDi Sauf châssis sport 11/99-05/05 1.9 TDi Sauf châssis sport 01/02-05/09		
2656048 OE 6Q0412301A	Butée de suspension <i>Shock bush</i>	9005338 OE 1H0412303B	Butée de suspension <i>Shock bush</i>
	3 H56 Châssis sport 1.2i 04/02- 1.2i 12v. /Dune 01/02-04/07 1.4i 16v. 01/02- 1.4 TDi /Dune 01/02- 1.6i 05/06- 1.8 GTi Turbo 04/06- 1.9 SDi 01/02-05/05 1.9 TDi /Crosspolo /Dune 01/04-		3 H64 1.3i 10/94- 1.4 10/95- 1.4i 16v. 10/96- 1.6 10/94- 1.9 D 01/96- 1.9 SDi 01/97-
9005363 OE 357412303F	Butée de suspension G/D <i>L/R suspension bush</i>	2656053 OE 6N0413175A	Protecteur amortisseur G/D <i>L/R shock absorber protector</i>
	3 H83 1.4 Flight /Variant 01/95- 1.6 Flight /Variant 01/95- 1.9 SDi Flight /Variant 01/95-		4 H206 1.2 /12v. 04/02-09/09 1.4i /16v. 11/99-09/09 1.4 TDi 01/02-09/09 1.6 GTi 16v. 11/99-12/01 1.6i 05/06-09/09 1.8 GTi Turbo 04/06-09/09 1.9 SDi 11/99-05/05 1.9 TDi 01/02-09/09

... Polo -05/09 ...

<p>9005327 OE 357413175A</p> 	<p>Protecteur amortisseur G/D <i>L/R shock absorber protector</i></p> <p>4 H221.5</p> <table style="width: 100%; border-collapse: collapse;"> <tr><td style="width: 50%;">1.2</td><td style="width: 50%;">06/05-</td></tr> <tr><td>1.3i</td><td>10/94-</td></tr> <tr><td>1.4</td><td>10/95-</td></tr> <tr><td>1.4i 16v.</td><td>10/96-</td></tr> <tr><td>1.4 TDi</td><td>06/05-</td></tr> <tr><td>1.6</td><td>10/94-</td></tr> <tr><td>1.9 D</td><td>01/96-</td></tr> <tr><td>1.9 SDi</td><td>01/97-</td></tr> </table>	1.2	06/05-	1.3i	10/94-	1.4	10/95-	1.4i 16v.	10/96-	1.4 TDi	06/05-	1.6	10/94-	1.9 D	01/96-	1.9 SDi	01/97-	<p>9005369 OE 1H0413175</p> 	<p>Protecteur amortisseur G/D <i>L/R shock absorber protector</i></p> <p>4</p> <table style="width: 100%; border-collapse: collapse;"> <tr><td style="width: 50%;">1.4 Flight /Variant</td><td style="width: 50%;">01/95-</td></tr> <tr><td>1.6 Flight /Variant</td><td>01/95-</td></tr> <tr><td>1.9 SDi Flight /Variant</td><td>01/95-</td></tr> </table>	1.4 Flight /Variant	01/95-	1.6 Flight /Variant	01/95-	1.9 SDi Flight /Variant	01/95-				
1.2	06/05-																												
1.3i	10/94-																												
1.4	10/95-																												
1.4i 16v.	10/96-																												
1.4 TDi	06/05-																												
1.6	10/94-																												
1.9 D	01/96-																												
1.9 SDi	01/97-																												
1.4 Flight /Variant	01/95-																												
1.6 Flight /Variant	01/95-																												
1.9 SDi Flight /Variant	01/95-																												
<div style="display: flex; justify-content: space-between; align-items: center;"> <div style="width: 30%;">  <p>Support d'amortisseur <i>Suspension mounting</i> <i>Soporte amortiguador</i> <i>Poduszka amortyzatora</i> <i>Опора амортизатора</i></p> </div> <div style="width: 60%;">  </div> </div>																													
<p>9005630 OE 1J0513353B</p> 	<p>Support suspension G/D <i>L/R suspension mounting</i></p> <p>1</p> <table style="width: 100%; border-collapse: collapse;"> <tr><td style="width: 50%;">1.2</td><td style="width: 50%;">01/02-</td></tr> <tr><td>1.2i 12v.</td><td>01/02-</td></tr> <tr><td>1.4i 16v.</td><td>01/02-</td></tr> <tr><td>1.4 TDi</td><td>01/02-</td></tr> <tr><td>1.6i</td><td>05/06-09/09</td></tr> <tr><td>1.8 GTi</td><td>04/06-09/09</td></tr> <tr><td>1.9 SDi</td><td>01/02-</td></tr> <tr><td>1.9 TDi</td><td>01/02-</td></tr> </table>	1.2	01/02-	1.2i 12v.	01/02-	1.4i 16v.	01/02-	1.4 TDi	01/02-	1.6i	05/06-09/09	1.8 GTi	04/06-09/09	1.9 SDi	01/02-	1.9 TDi	01/02-	<p>9005367 OE 861512131A</p> 	<p>Butée de suspension AR G/D <i>L/R rear suspension bush</i></p> <p>2 H106</p> <table style="width: 100%; border-collapse: collapse;"> <tr><td style="width: 50%;">0.9</td><td style="width: 50%;">01/75-12/81</td></tr> <tr><td>1.05</td><td>01/82-12/90</td></tr> <tr><td>1.1</td><td>01/75-12/90</td></tr> <tr><td>1.3</td><td>01/75-06/92</td></tr> <tr><td>1.3 G40</td><td>01/91-12/94</td></tr> </table>	0.9	01/75-12/81	1.05	01/82-12/90	1.1	01/75-12/90	1.3	01/75-06/92	1.3 G40	01/91-12/94
1.2	01/02-																												
1.2i 12v.	01/02-																												
1.4i 16v.	01/02-																												
1.4 TDi	01/02-																												
1.6i	05/06-09/09																												
1.8 GTi	04/06-09/09																												
1.9 SDi	01/02-																												
1.9 TDi	01/02-																												
0.9	01/75-12/81																												
1.05	01/82-12/90																												
1.1	01/75-12/90																												
1.3	01/75-06/92																												
1.3 G40	01/91-12/94																												
<p>9005366 OE 6N0512131A</p> <p>Butée de suspension AR G/D <i>L/R rear suspension bush</i></p>  <table style="width: 100%; border-collapse: collapse;"> <tr><td style="width: 50%;">2 H134 -ch 6N-W-098090</td><td style="width: 50%;"></td></tr> <tr><td>1.3i</td><td>10/94-09/99</td></tr> <tr><td>1.4i</td><td>10/94-09/99</td></tr> <tr><td>1.4i 16v.</td><td>10/94-09/99</td></tr> <tr><td>1.6</td><td>10/94-09/99</td></tr> <tr><td>1.9 D</td><td>10/94-09/99</td></tr> <tr><td>1.9 SDi</td><td>10/94-09/99</td></tr> </table>				2 H134 -ch 6N-W-098090		1.3i	10/94-09/99	1.4i	10/94-09/99	1.4i 16v.	10/94-09/99	1.6	10/94-09/99	1.9 D	10/94-09/99	1.9 SDi	10/94-09/99												
2 H134 -ch 6N-W-098090																													
1.3i	10/94-09/99																												
1.4i	10/94-09/99																												
1.4i 16v.	10/94-09/99																												
1.6	10/94-09/99																												
1.9 D	10/94-09/99																												
1.9 SDi	10/94-09/99																												
<p>9005364 OE 6K0512131A</p> <p>Butée de suspension AR G/D <i>L/R rear suspension bush</i></p>  <table style="width: 100%; border-collapse: collapse;"> <tr><td style="width: 50%;">2 H110</td><td style="width: 50%;"></td></tr> <tr><td>1.3i</td><td>Ch- 6N-W-098091 10/94-09/99</td></tr> <tr><td>1.4</td><td>10/99-</td></tr> <tr><td>1.4 Flight /Variant</td><td>01/95-</td></tr> <tr><td>1.4i</td><td>Ch- 6N-W-098091 10/94-09/99</td></tr> <tr><td>1.4i 16v.</td><td>Ch- 6N-W-098091</td></tr> <tr><td>1.4 TDi</td><td>10/99-</td></tr> <tr><td>1.6</td><td>Ch- 6N-W-098091 10/94-09/99</td></tr> <tr><td>1.6 Flight /Variant</td><td>01/95-</td></tr> <tr><td>1.6 GTi 16v.</td><td>10/99-</td></tr> <tr><td>1.9 D</td><td>Ch- 6N-W-098091 10/94-09/99</td></tr> <tr><td>1.9 SDi</td><td>Ch- 6N-W-098091 10/94-</td></tr> </table>				2 H110		1.3i	Ch- 6N-W-098091 10/94-09/99	1.4	10/99-	1.4 Flight /Variant	01/95-	1.4i	Ch- 6N-W-098091 10/94-09/99	1.4i 16v.	Ch- 6N-W-098091	1.4 TDi	10/99-	1.6	Ch- 6N-W-098091 10/94-09/99	1.6 Flight /Variant	01/95-	1.6 GTi 16v.	10/99-	1.9 D	Ch- 6N-W-098091 10/94-09/99	1.9 SDi	Ch- 6N-W-098091 10/94-		
2 H110																													
1.3i	Ch- 6N-W-098091 10/94-09/99																												
1.4	10/99-																												
1.4 Flight /Variant	01/95-																												
1.4i	Ch- 6N-W-098091 10/94-09/99																												
1.4i 16v.	Ch- 6N-W-098091																												
1.4 TDi	10/99-																												
1.6	Ch- 6N-W-098091 10/94-09/99																												
1.6 Flight /Variant	01/95-																												
1.6 GTi 16v.	10/99-																												
1.9 D	Ch- 6N-W-098091 10/94-09/99																												
1.9 SDi	Ch- 6N-W-098091 10/94-																												
<p>9005368 OE 191513425</p> 	<p>Protecteur amortisseur G/D <i>L/R shock absorber protector</i></p> <p>3 H90</p> <table style="width: 100%; border-collapse: collapse;"> <tr><td style="width: 50%;">1.05</td><td style="width: 50%;">10/90-06/94</td></tr> <tr><td>1.4 D</td><td>10/90-06/94</td></tr> </table>			1.05	10/90-06/94	1.4 D	10/90-06/94																						
1.05	10/90-06/94																												
1.4 D	10/90-06/94																												

... Polo -05/09

Eléments TRAIN ARRIERE





Rear axle parts

Tren TRAS

Elementy zawieszenia tylnego

элементы задней оси.



9001697 OE 861511271	Articulation essieu AR <i>Rear axle bush</i>	2606001 OE 6R0501541A	Articulation traverse <i>Cross bar bush</i>
	Ø int.10 Ø ext.44 coll.58.5 long. tube int.54 ext.31 ep. coll.10 1.05 -09/94 1.1 -09/94 1.3 -09/94 1.3 D -09/94 1.4 D -09/94		Ø int. 12 Ø ext. 71.5 coll. 80 long. tube int. 90 ext. 54.5 1.2i 04/02-09/09 1.2i 12v. 01/02-04/07 1.2i Fox 06/05- 1.4i 06/05-04/07 1.4i 16v. 01/02-05/09 1.4i Fox 06/05- 1.4 TDi 01/02-05/09 1.4 TDi Fox 06/05- 1.6i 05/06-09/09 1.8 GTi 04/06-09/09 1.9 SDi 01/02-05/05 1.9 TDi 01/02-05/09
9001703 OE 6N0501541D	Articulation essieu AR <i>Rear axle bush</i>	9001789 OE 6K0501541A	Articulation essieu AR <i>Rear axle bush</i>
	Ø int.10 Ø ext.58 coll.66 long. tube int.58 ext.41 ep. coll.9 1.3i 10/94- 1.4 10/95- 1.4 Flight /Variant 01/95- 1.4i 16v. 10/96- 1.6 Flight /Variant 01/95- 1.6i 16v. 10/96- 1.9 D 01/96- 1.9 SDi 01/96- 1.9 SDi SMI-Koyo/TRW 01/95-		Ø int.12 Ø ext.72 coll.80 long. tube int.90 ext.55 ep. coll.5/9 1.4 10/99- 1.4i 16v. 10/99- 1.4 TDi 10/99- 1.6 GTi 16v. 10/99- 1.9 SDi 10/99-

Polo (6R) 06/09- ...

Eléments DIRECTION

Steering parts

Elementos Direcciones

Elementy uklad kierowniczy

Элементы рулевой системы

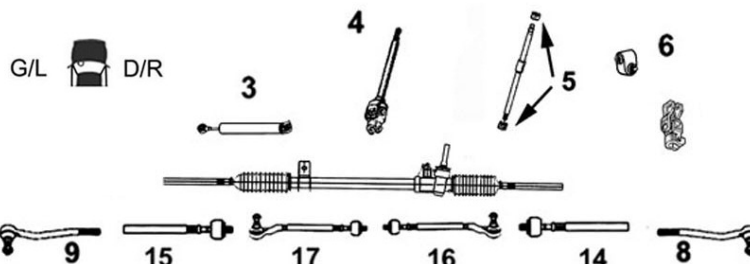



7776079 Part/oe 6R0423803A	Axe de bielle G/D <i>L/R axial joint</i>
	14 Côté dir. M14x1.5 Côté rot. M14x1.5 long 310 mm 15 DA electro-hydraulique 1.2i 09/09- 1.2 TSi /Crosspolo 03/10- 1.2 TDi 03/10- 1.4i /Crosspolo 09/09- 1.4 TSi GTi 06/10- 1.6 TDi /Crosspolo 09/09-

... Polo (6R) 06/09- ...

9006634	Rotule de direction G	
OE 6R0423811	<i>Left tie rod end</i>	
	9 M14 x 1.5	
	1.2 TSi /Crosspolo	09/09-
	1.2i /Fox	09/09-
	1.2 TDi FAP	03/10-
	1.4i /Crosspolo	09/09-
	1.4 TSi GTi	06/10-
	1.6 TDi FAP	09/09-

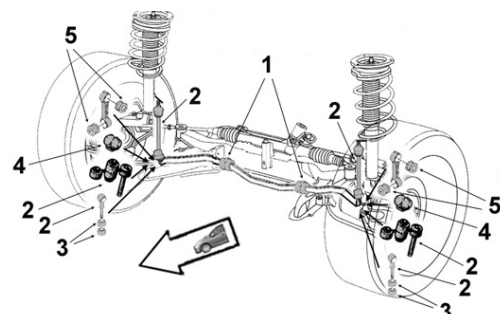
9006635	Rotule de direction D	
OE 6R0423812	<i>Right tie rod end</i>	
	8 M14 x 1.5	
	1.2 TSi /Crosspolo	09/09-
	1.2i /Fox	09/09-
	1.2 TDi FAP	03/10-
	1.4i /Crosspolo	09/09-
	1.4 TSi GTi	06/10-
	1.6 TDi FAP	09/09-

 <p>Barre stabilisatrice Stabilizer bar Barra estabilizadora Drażek stabilizatora стабилизатор поперечной устойчивости</p>	
--	--

9005089	Biellette barre stab.	
OE 6Q0411315N	<i>Stabilizer bar stub axle</i>	
	2	
	1.2i /Crosspolo	-15/11/10
	1.2 TDi	-15/11/10
	1.4i	
	1.4 TSi	-15/11/10
	1.6 TDi	

2306017	Palier de barre milieu	
OE 6Q0411314P	<i>Middle bar main bearing</i>	
	1 Barre Ø 18	
	1.2 TSi /Crosspolo	
	1.2i /Fox	
	1.2 TDi	
	1.4i	
	1.6 TDi	

2306019	Palier de barre milieu	
OE 6Q0411314R	<i>Middle bar main bearing</i>	
	1 Barre Ø 18	
	1.2 TSi /Crosspolo	
	1.2i	
	1.2 TDi	
	1.4i	
	1.4 TSi	
	1.6 TDi	

2306018	Palier de barre milieu	
OE 6Q0411314Q	<i>Middle bar main bearing</i>	
	1 Barre Ø 19	
	1.2 TSi /Crosspolo	
	1.2i	
	1.2 TDi	
	1.4i	
	1.4 TSi	
	1.6 TDi	

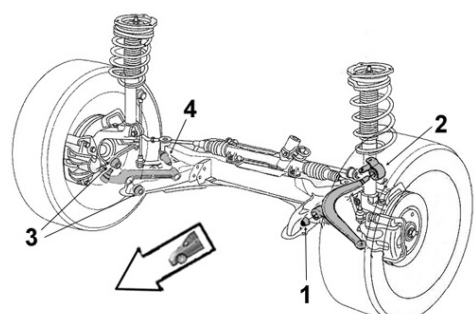
 <p>Eléments SUSPENSION Suspension parts Elementos suspensión Elementy zawieszenie Элементы подвески</p>	
--	--

9001523	Articulation AV	
OE 357407182	<i>Front bush</i>	
	1	
	Ø int.12 Ø ext.33 coll.36	
	long. tube int.54 ext.29 ep. coll.5	
	1.2i TSi /Crosspolo	
	1.2i	
	1.2 TDi	
	1.4i	
	1.4 TSi	
	1.6 TDi	

9001542	Articulation AR	
OE 1J0407181	<i>Rear bush</i>	
	2	
	Ø int.13 Ø ext.59.5	
	long. tube int.41 ext.23.5	
	1.2i TSi /Crosspolo	
	1.2i	
	1.2 TDi	
	1.4i	
	1.4 TSi	
	1.6 TDi	

... Polo (6R) 06/09- ...

Bras & Triangle de suspension

Control arm
Brazo y triángulo
Wahacz
Рычаг подвески

G/L  D/R

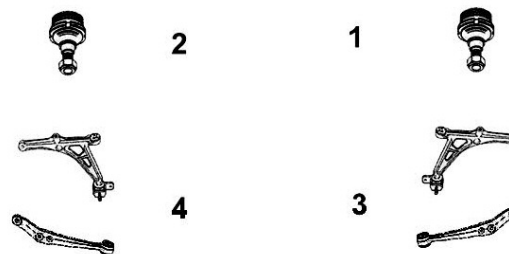

7476091

Triangle de susp. inf. G

OE 6R0407151F

Lower left track control arm

NEW



4 Sans rotule Without tie rod end

1.2i	09/09-
1.2 TSi /Crosspolo	09/09-
1.2 TDi	03/10-
1.4i /Crosspolo	09/09-
1.4 TSi	06/10-
1.6 TDi FAP /Crosspolo	09/09-

7476092

Triangle de susp. inf. D

OE 6R0407152F

Lower right track control arm

NEW



3 Sans rotule Without tie rod end

1.2i	09/09-
1.2 TSi /Crosspolo	09/09-
1.2 TDi	03/10-
1.4i /Crosspolo	09/09-
1.4 TSi	06/10-
1.6 TDi FAP /Crosspolo	09/09-

7476183

Triangle de susp. inf. G

OE 6R0407151F+6R0407365A *Lower L track control arm*

NEW



4 Avec rotule With ball joint

1.2i	09/09-
1.2 TSi /Crosspolo	09/09-
1.2 TDi	03/10-
1.4i /Crosspolo	09/09-
1.4 TSi	06/10-
1.6 TDi FAP /Crosspolo	09/09-

7476184

Triangle de susp. inf. D

OE 6R0407152F+6R0407366A *Lower R track control arm*

NEW



3 Avec rotule With ball joint

1.2i	09/09-
1.2 TSi /Crosspolo	09/09-
1.2 TDi	03/10-
1.4i /Crosspolo	09/09-
1.4 TSi	06/10-
1.6 TDi FAP /Crosspolo	09/09-

7576019

Rotule de susp. inf. G

OE 6R0407365A *Left lower suspension ball joint*

NEW



2

1.2i	09/09-
1.2 TSi /Crosspolo	09/09-
1.2 TDi	03/10-
1.4i /Crosspolo	09/09-
1.4 TSi	06/10-
1.6 TDi FAP /Crosspolo	09/09-

7576020

Rotule de susp. inf. D

OE 6R0407366A *Right lower suspension ball joint*

NEW



1

1.2i	09/09-
1.2 TSi /Crosspolo	09/09-
1.2 TDi	03/10-
1.4i /Crosspolo	09/09-
1.4 TSi	06/10-
1.6 TDi FAP /Crosspolo	09/09-

9005478

Rotule de susp. inf. G

OE 6Q0407365M *Left lower suspension ball joint*



2

1.2i	01/10-
------	--------

9005479

Rotule de susp. inf. D

OE 6Q0407366M *Right lower suspension ball joint*



1

1.2i	01/10-
------	--------

SASIC

VOLKSWAGEN

... Polo (6R) 06/09- ...



Support d'amortisseur
Suspension mounting
Soporte amortiguador
Poduszka amortyzatora
Опора амортизатора

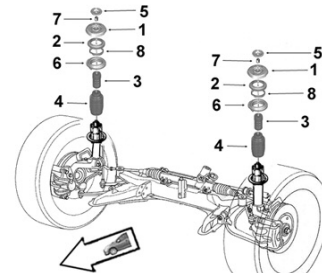

9005614 **Tampon suspension AV G/D**
 OE 1J0412331C *L/R front suspension rebound stop*



1
 1.2i
 1.2 TSi /Crosspolo
 1.2 TDi
 1.4i
 1.4 TSi GTi
 1.6 TDi
 03/10-

2656003 **Butée de suspension**
 OE 1J0412303 *Shock bush*



3 H53
 1.2 TSi
 1.4 TSi GTi

9005338 **Butée de suspension**
 OE 1H0412303B *Shock bush*



3 H64
 1.2 TSi /Crosspolo
 1.2 TDi
 1.4i /Crosspolo
 1.6 TDi /Crosspolo
 03/10-

9005327 **Protecteur amortisseur G/D**
 OE 357413175A *L/R shock absorber protector*



4 H221.5
 1.2 TSi /Crosspolo
 1.2 TDi
 1.4i /Crosspolo
 1.4 TSi GTi
 1.6 TDi
 03/10-



Support d'amortisseur
Suspension mounting
Soporte amortiguador
Poduszka amortyzatora
Опора амортизатора

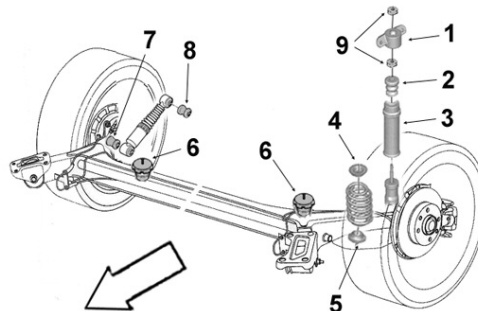

9005630 **Support suspension G/D**
 OE 1J0513353B *L/R suspension mounting*



1
 1.2 TSi /Crosspolo
 1.2i Châssis standard
 1.2 TDi Châssis standard
 1.4i Châssis standard
 1.6 TDi Châssis standard
 03/10-

2656057 **Support suspension**
 OE 6R0513353B *Suspension mounting*



1 Châssis sport
 1.2 TSi
 1.2i
 1.4i
 1.4 TSi GTi
 1.6 TDi FAP
 10/09-
 09/09-
 09/09-
 06/10-

... Polo (6R) 06/09-

Eléments TRAIN ARRIERE

Rear axle parts

Tren TRAS

Elementy zawieszenia tylnego

элементы задней оси.



2606001

Articulation traverse

OE 6R0501541A

Cross bar bush

Ø int. 12 Ø ext. 71.5 coll. 80 long. tube int. 90 ext. 54.5



1.2i
1.2 TSi /Crosspolo
1.2 TDi
1.4i /Crosspolo
1.4 TSi
1.6 TDi /Crosspolo

Up ...



Barre stabilisatrice

Stabilizer bar

Barra estabilizadora

Drażek stabilizatora

стабилизатор поперечной устойчивости

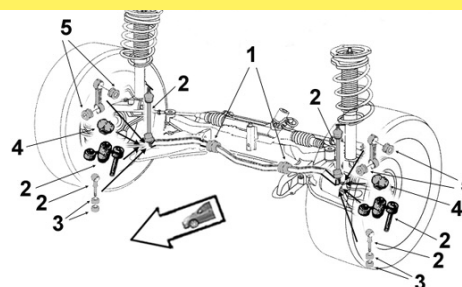

2306017

Palier de barre milieu

OE 6Q0411314P

Middle bar main bearing

NEW



1 Barre Ø 18

1.0i



Eléments SUSPENSION

Suspension parts

Elementos suspensión

Elementy zawieszenie

Элементы подвески

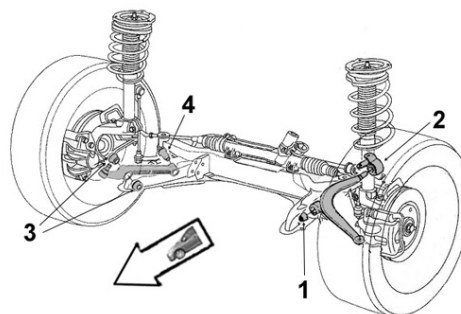

9001523

Articulation AV

OE 357407182

Front bush

1 Ø int.12 Ø ext.33 coll.36
long. tube int.54 ext.29 ep. coll.5



1.0i

9001542

Articulation AR

OE 1J0407181

Rear bush

2 Ø int.13 Ø ext.59.5
long. tube int.41 ext.23.5



1.0i

... Up ...

Bras & Triangle de suspension

Control arm
Brazo y triángulo
Wahacz
Рычаг подвески

G/L  D/R

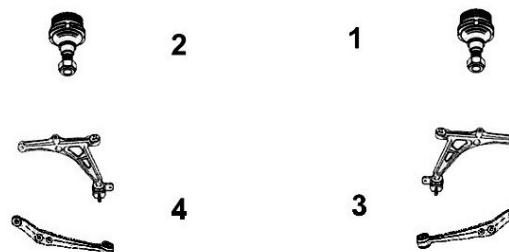

VOLKSWAGEN 

7576019

Rotule de susp. inf. G

OE 6R0407365A

Left lower suspension ball joint

NEW

2



1.0i

09/11-

7576020

Rotule de susp. inf. D

OE 6R0407366A

Right lower suspension ball joint

NEW

1



1.0i

09/11-



Support d'amortisseur

Suspension mounting
Soporte amortiguador
Poduszka amortyzatora
Опора амортизатора

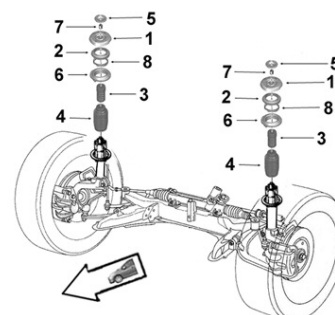

9005327

Protecteur amortisseur G/D

OE 357413175A

L/R shock absorber protector

4

H221.5



1.0i



Support d'amortisseur

Suspension mounting
Soporte amortiguador
Poduszka amortyzatora
Опора амортизатора

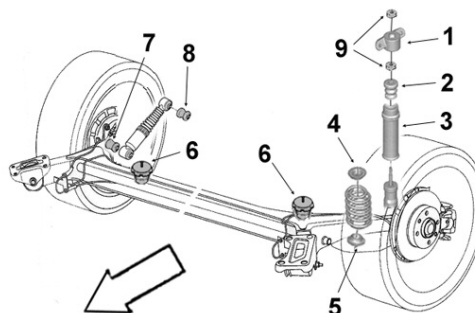

2656062

Bague palier susp.

OE 1S0512335A

bearing ring suspension

9

Ø int. 15.8 Ø ext. 41 long. tube int.27 ext.24.3



1.0i

... Up

Eléments TRAIN ARRIERE

Rear axle parts

Tren TRAS

Elementy zawieszenia tylnego

элементы задней оси.



2606005

Articulation essieu AR

OE 1S0501541B

Rear axle bush

Ø int.10 Ø ext.58 coll.74 long. tube int. 64 ext. 41 ep coll. 15.3



1.0i

Santana ...

Eléments DIRECTION

Steering parts

Elementos Direcciones

Elementy uklad kierowniczy

Элементы рулевой системы

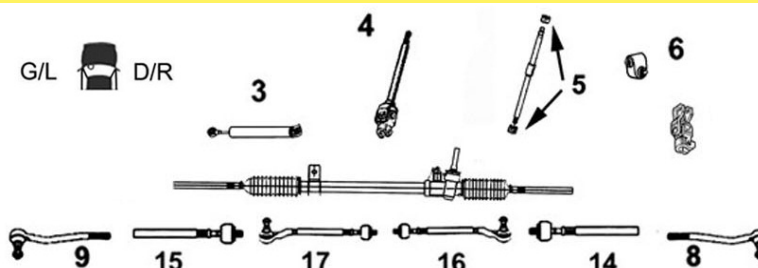

9006244

Axe de bielle G

Part/oe 811419801E

Left axial joint

15 M14x1.5

TT /all models -07/85



9006245

Axe de bielle D

Part/oe 811419802J

Right axial joint

14 M14x1.5

TT /all models -07/85



9006300

Rotule de direction G/D

OE 811419812A

L/R tie rod end

8
9 M14x1.5

TT /all models

Ch- 32B040821



9006382

Rotule de direction G/D

OE 811419812

L/R tie rod end

8
9 M14x1.5

TT /all models

-ch 32B040820

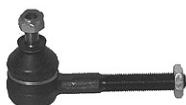

... Santana

Bras & Triangle de suspension

Control arm
Brazo y triángulo
Wahacz
Рычаг подвески

G/L  D/R

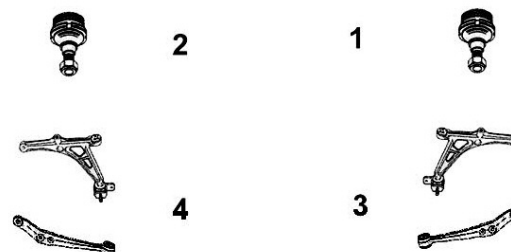

9005200

Rotule de susp. inf. G/D

OE 823407365E

L/R lower suspension ball joint



1 Ø 17
2

TT /all models DNA -07/85

9005201

Rotule de susp. inf. D

OE 855407365B

Right lower suspension ball joint



1 Ø 17 Trou Oublon

TT /all models DA -07/85

Scirocco ...

Eléments DIRECTION

Steering parts
Elementos Direcciones
Elementy układ kierowniczy
Элементы рулевой системы

G/L  D/R

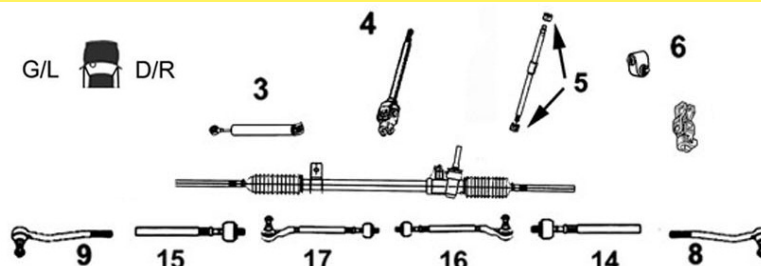

9006210

Axe de bielle G/D

Part/oe 191419803

L/R axial joint



14 Côté dir. M22x1.5 Côté rot. M14x1.5
15 long 368 mm

TT /all models DNA 11/84-12/91

9006217

Axe de bielle G/D

Part/oe 191422803A

L/R axial joint



14 Côté dir. M14x1.5 Côté rot. M14x1.5
15 long 347 mm

TT /all models DA 11/84-12/91

9006873

Axe de bielle G/D

OE 1K0423810A

L/R axial joint



14 Côté dir. M16x1.5 Côté rot. M16x1.5 long 310 mm
15

1.4 TSi	DA	09/08-
2.0 TFSi TSi	DA	09/08-
2.0 TDi	DA	09/08-

9006380

Rotule de direction G

OE 3A0422811

Left tie rod end



9 M14 x 1.5

TT /all models 11/84-12/91

9006381

Rotule de direction D

OE 3A0422812

Right tie rod end



8 M14 x 1.5

TT /all models 11/84-12/91

... Scirocco ...

Eléments DIRECTION

Steering parts

Elementos Direcciones

Elementy układ kierowniczy

Элементы рулевой системы

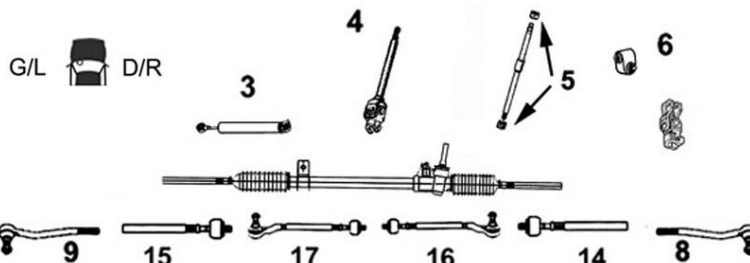

9006638

Rotule de direction G

OE 1K0423811J

Left tie rod end



9

M16 x 1.5

1.4 TSi	07/08-
2.0 TFSi TSi	07/08-
2.0 TDi FAP	07/08-

9006637

Rotule de direction D

OE 1K0423812J

Right tie rod end



8

M16 x 1.5

1.4 TSi	07/08-
2.0 TFSi TSi	07/08-
2.0 TDi FAP	07/08-



Barre stabilisatrice

Stabilizer bar

Barra estabilizadora

Drążek stabilizatora

стабилизатор поперечной устойчивости

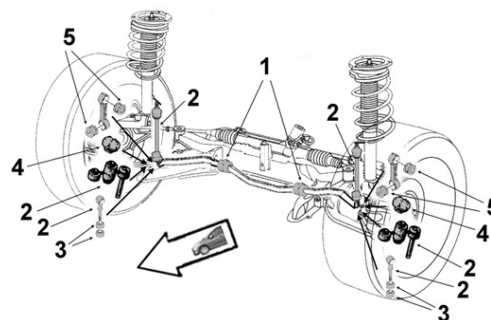

2306010

Biellette barre stab.

OE 1K0411315P

Stabilizer bar stub axle



2

1.4 TSi	09/08-
2.0 TSi /R	09/08-
2.0 TDi	09/08-



Eléments SUSPENSION

Suspension parts

Elementos suspensión

Elementy zawieszenie

Элементы подвески

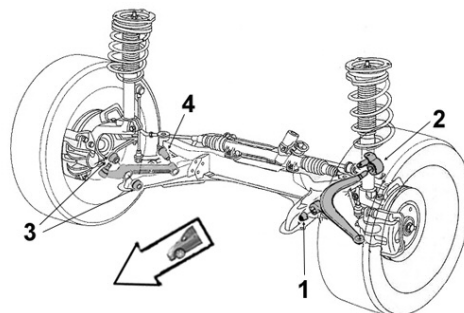

9001759

Articulation AV

OE 1K0407182

Front bush

















1

Ø int.12 Ø ext.40 coll.48 long. tube int.54 ext.33 ep. coll.6

1.4 TSi	09/08-
2.0 TSi /R	09/08-
2.0 TDi	09/08-

... Scirocco ...

2256003 Articulation AR G		2256002 Articulation AR D	
OE 1K0199231J <i>Left rear bush</i>		OE 1K0199232J <i>Right rear bush</i>	
	2		2
	1.4 TSi 09/08- 2.0 TSi /R 09/08- 2.0 TDi 09/08-		1.4 TSi 09/08- 2.0 TSi /R 09/08- 2.0 TDi 09/08-
<p>Bras & Triangle de suspension G/L  D/R</p> <p><i>Control arm</i>  2 1 </p> <p><i>Brazo y triángulo</i>  4 3 </p> <p><i>Wahacz</i></p> <p><i>Рычаг подвески</i></p>			
9005133 Triangle de susp. G/D		9005133 Triangle de susp. G/D	
OE 191407151B <i>L/R track control arm</i>		OE 191407151B <i>L/R track control arm</i>	
	3 4	3 4	
	Sans rotule <i>Without tie rod end</i>		
	TT /all models	11/84-12/91	
7476107 Triangle de susp. G		7476108 Triangle de susp. D	
OE 191407151B+357407365 <i>Left track control arm</i>		OE 191407151B+357407365 <i>Right track control arm</i>	
	4		3
NEW	Avec rotule <i>With ball joint</i> Ø 19	NEW	Avec rotule <i>With ball joint</i> Ø 19
	TT /all models 08/87-12/91		TT /all models 08/87-12/91
7476018 Triangle de susp. G		7476017 Triangle de susp. D	
OE 1K0407151AC <i>Left track control arm</i>		OE 1K0407152AC <i>Right track control arm</i>	
	4		3
	Fonte Iron Sans rotule <i>Without tie rod end</i>		
	1.4 TSi 09/08-06/09 2.0 TFSi TSi 09/08-06/09 2.0 TDi 09/08-06/09		1.4 TSi 09/08-06/09 2.0 TFSi TSi 09/08-06/09 2.0 TDi 09/08-06/09
7476128 Triangle de susp. G		7476127 Triangle de susp. D	
OE 1K0407151AC+1K0407365C <i>Left track control arm</i>		OE 1K0407152M+1K0407366C <i>Right track control arm</i>	
	4		3
NEW	Avec rotule <i>With ball joint</i>	NEW	Avec rotule <i>With ball joint</i>
	1.4 TSi 09/08-06/09 2.0 TFSi TSi 09/08-06/09 2.0 TDi 09/08-06/09		1.4 TSi 09/08-06/09 2.0 TFSi TSi 09/08-06/09 2.0 TDi 09/08-06/09

... Scirocco ...

Bras & Triangle de suspension

Control arm
Brazo y triángulo
Wahacz
Рычаг подвески

G/L  D/R

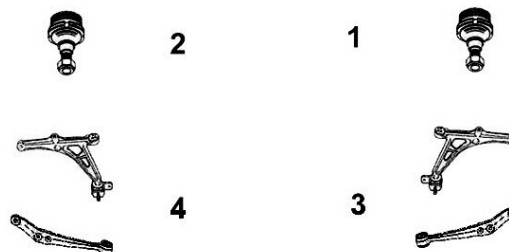

9005261 Rotule de susp. inf. G/D
OE 191407365 L/R lower suspension ball joint



1
2 Ø 17
TT /all models 11/84-07/87

9005260 Rotule de susp. inf. G/D
OE 357407365 L/R lower suspension ball joint



1
2 Ø 19 Cylindrique
TT /all models 08/87-12/91

9005570 Rotule de susp. inf. G
OE 1K0407365C Left lower suspension ball joint



2
1.4 TSi 09/08-
2.0 TFSi TSi 09/08-
2.0 TDi 09/08-

9005569 Rotule de susp. inf. D
OE 1K0407366C Right lower suspension ball joint



1
1.4 TSi 09/08-
2.0 TFSi TSi 09/08-
2.0 TDi 09/08-



Support d'amortisseur

Suspension mounting
Soporte amortiguador
Poduszka amortyzatora
Опора амортизатора

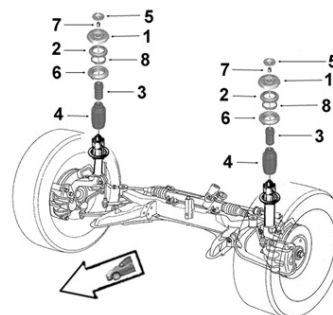

9005622 Support suspension G/D
OE 1K0412331B L/R suspension mounting



1
1.4 TSi 09/08-
2.0 TFSi TSi 09/08-
2.0 TDi 09/08-

2656052 Butée de suspension
OE 1K0412303B Shock bush



3 H70
1.4 TSi 07/08-
2.0 TFSi 07/08-
2.0 TSi 10/09-
2.0 TDi 07/08-

2656053 Protecteur amortisseur G/D
OE 6N0413175A L/R shock absorber protector



4 H206
1.4 TSi 07/08-
2.0 TFSi 07/08-
2.0 TSi 10/09-
2.0 TDi 07/08-

... Scirocco



Barre stabilisatrice
 Stabilizer bar
 Barra estabilizadora
 Drążek stabilizatora
 стабилизатор поперечной устойчивости

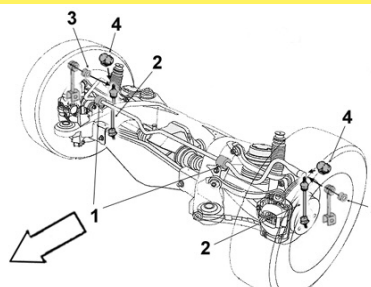

9005094 **Biellette barre stab.**
 OE 1K0505465K *Stabilizer bar stub axle*



2

1.4 TSi	09/08-
2.0 TSi /R	09/08-
2.0 TDi	09/08-

9001737 **Palier de barre milieu**
 OE 1K0511327AR *Middle bar main bearing*



1 Barre Ø 20.7

1.4 TSi	09/08-
2.0 TSi	09/08-
2.0 TDi	09/08-

2306014 **Palier de barre milieu**
 OE 1K0511327AS *Middle bar main bearing*



1 Barre Ø 21.7

1.4 TSi	09/08-
2.0 TSi /R	09/08-
2.0 TDi	09/08-

2656049 **Butée de suspension**
 OE 1K0511353M *Shock bush*



2 H 133

1.4 TSi	09/08-
2.0 TSi TFSi	09/08-
2.0 TDi	09/08-



Barre stabilisatrice
 Stabilizer bar
 Barra estabilizadora
 Drążek stabilizatora
 стабилизатор поперечной устойчивости

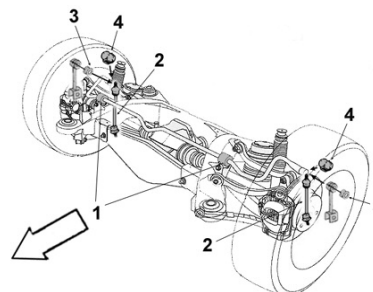

9001786 **Articulation essieu G/D inf.**
 OE 1K0505553A *Lower L/R axle bush*



Ø int. 12 Ø ext. 37 long. tube int. 50 ext. 28

1.4 TSi	09/08-
2.0 TSi /R	09/08-
2.0 TDi	09/08-

Sharan ...

Eléments DIRECTION
Steering parts
Elementos Direcciones
Elementy układ kierowniczy
Элементы рулевой системы

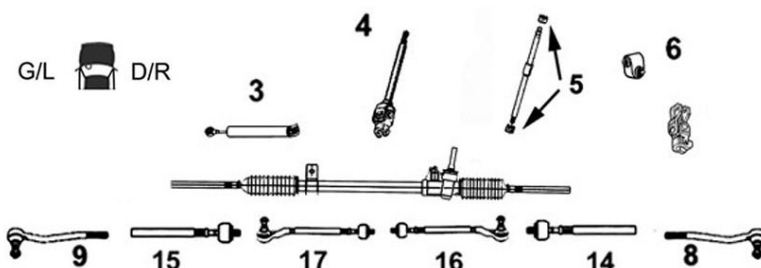

9006229 **Axe de bielle G/D**

Part/oe 7M3422804A *L/R axial joint*



14 Côté dir. M14x1.5 Côté rot. M14x1.5
15 long 184 mm

1.8i 20v. Turbo	09/97-04/10
1.9 TDi	-04/10
2.0	-04/10
2.0 TDi	05/06-04/10
2.8 VR6	-04/10

9006873 **Axe de bielle G/D**

OE 1K0423810A *L/R axial joint*



14 Côté dir. M16x1.5 Côté rot. M16x1.5
15 long 310 mm

1.4 TSi	05/10-
2.0 TDi	05/10-

9006460 **Rotule de direction G**

OE 7M3422817 *Left tie rod end*



9 M14 x 1.5

1.8i 20v. Turbo	09/97-04/10
1.9 TDi	-04/10
2.0	-04/10
2.0 TDi	05/06-04/10
2.8 VR6	-04/10

9006459 **Rotule de direction D**

OE 7M3422818 *Right tie rod end*



8 M14 x 1.5

1.8i 20v. Turbo	09/97-04/10
1.9 TDi	-04/10
2.0	-04/10
2.0 TDi	05/06-04/10
2.8 VR6	-04/10

9006638 **Rotule de direction G**

OE 1K0423811J *Left tie rod end*



9 M16 x 1.5

1.4 TSi	05/10-
2.0 TDi	05/10-

9006637 **Rotule de direction D**

OE 1K0423812J *Right tie rod end*



8 M16 x 1.5

1.4 TSi	05/10-
2.0 TDi	05/10-



Barre stabilisatrice
Stabilizer bar
Barra estabilizadora
Drażek stabilizatora
 стабилизатор поперечной устойчивости

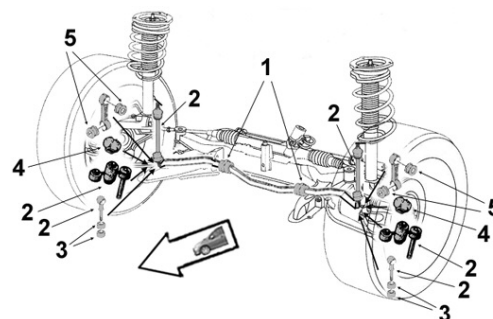

2306010 **Biellette barre stab.**

OE 1K0411315P *Stabilizer bar stub axle*



2

1.4 TSi	05/10-
2.0 TDi	05/10-

9001779 **Palier de barre milieu**

OE 7M0411031 *Middle bar main bearing*



1 Ø 16.5

1.8i 20v. Turbo	05/10-
1.9 TDi	-04/10
2.0	-04/10
2.8 VR6	-04/10

... Sharan ...



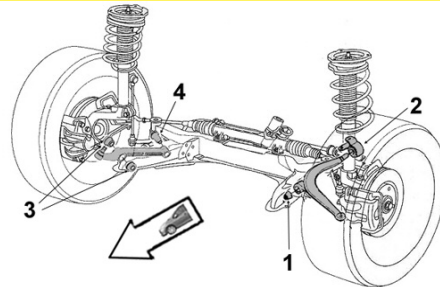

Eléments SUSPENSION
Suspension parts
Elementos suspensión
Elementy zawieszenie
Элементы подвески





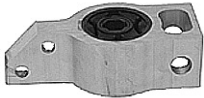





VOLKSWAGEN





9001436	Articulation AV	2256007	Articulation AR inf.
OE 7M0501541	<i>Front bush</i>	OE 3C0199231D	<i>Rear lower bush</i>
	1 Ø int.14 Ø ext.35 coll.38 x2 long. tube int.60 ext.33 ep. coll.5x2		2
	1.8i 20v. Turbo -04/10 1.9 TDi /4WD -04/10 2.0 -04/10 2.8 VR6 /4WD -04/10		1.4 TSI 05/10- 2.0 TDi 05/10-

9001763	Articulation AR
OE 7M0407181A	<i>Rear bush</i>
	2 Ø int.18 Ø ext.60.5 long. tube int. 48 ext. 33 ep. coll.4
	1.8i 20v. Turbo -04/10 1.9 TDi /4WD -04/10 2.0 -04/10 2.8 VR6 /4WD -04/10

Bras & Triangle de suspension	G/L  D/R		2	1	
<i>Control arm</i> <i>Brazo y triángulo</i> <i>Wahacz</i> <i>Рычаг подвески</i>					
			4	3	

7476038	Triangle de susp. G/D
OE 3C0407151G	<i>L/R track control arm</i>
	3 Sans rotule <i>Without tie rod end</i>
	1.4 TSi 05/10- 2.0 TFSi 12/10- 2.0 TDi 05/10-

9005751	9005752		
OE 7M0407151B	OE 7M0407152B		
Triangle de susp. G	Triangle de susp. D		
<i>Left track control arm</i>	<i>Right track control arm</i>		
	4 Sans rotule <i>Without tie rod end</i>		3 Sans rotule <i>Without tie rod end</i>
	1.8i 20v. Turbo -04/10 1.9 TDi /4WD -04/10 2.0 -04/10 2.0 TDi -04/10 2.8 VR6 /4WD -04/10		1.8i 20v. Turbo -04/10 1.9 TDi /4WD -04/10 2.0 -04/10 2.0 TDi -04/10 2.8 VR6 /4WD -04/10

... Sharan ...

Bras & Triangle de suspension

Control arm
Brazo y triángulo
Wahacz
Рычаг подвески

G/L  D/R

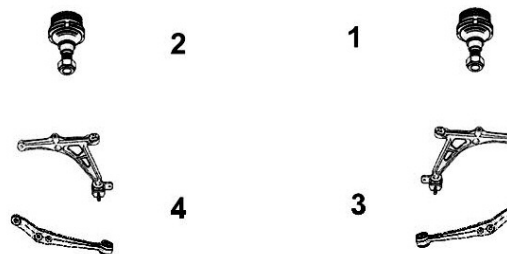

9005247

Rotule de susp. inf. G/D

OE 7M3407365C

L/R lower suspension ball joint



1
2

1.8i 20v. Turbo
1.9 TDi /4WD
2.0
2.0 TDi
2.8 VR6 /4WD

-04/10
-04/10
-04/10
-04/10
-04/10



Support d'amortisseur

Suspension mounting
Soporte amortiguador
Poduszka amortyzatora
Опора амортизатора

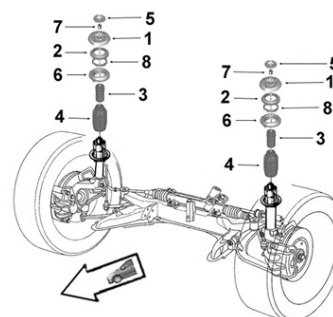

9005352

Butée à billes G/D

OE 1J0412249

L/R ball bearing



2

1.8i 20v. Turbo
1.9 TDi
2.0
2.0 TDi
2.8 VR6

-04/10

9005363

Butée de suspension G/D

OE 357412303F

L/R suspension bush



3

H83

1.8i 20v. Turbo
1.9 TDi
2.0
2.8 VR6

-06/00
-06/00
-06/00
-06/00

2656053

Protecteur amortisseur G/D

OE 6N0413175A

L/R shock absorber protector



4

H206

1.4 TSi
2.0 TDi

09/10-
09/10-

... Sharan



Barre stabilisatrice
 Stabilizer bar
 Barra estabilizadora
 Drążek stabilizatora
 стабилизатор поперечной устойчивости

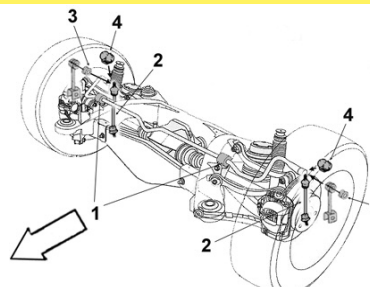

9005094

Biellette barre stab.

OE 1K0505465K

Stabilizer bar stub axle

2



1.4 TSi
 2.0 TDi

09/10-
 09/10-



Eléments SUSPENSION
 Suspension parts
 Elementos suspensión
 Elementy zawieszenie
 Элементы подвески

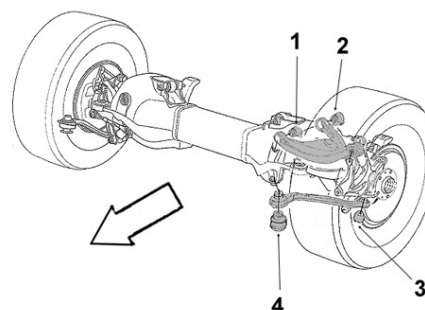

9001436

Articulation AV

OE 7M0501541

Front bush

1

Ø int.14 Ø ext.35 coll.38 x2 long. tube int.60 ext.33 ep. coll.5x2



1.8i 20v. Turbo
 1.9 TDi
 2.0
 2.8 VR6

06/00-

Tiguan ...

Eléments DIRECTION
 Steering parts
 Elementos Direcciones
 Elementy układ kierowniczy
 Элементы рулевой системы

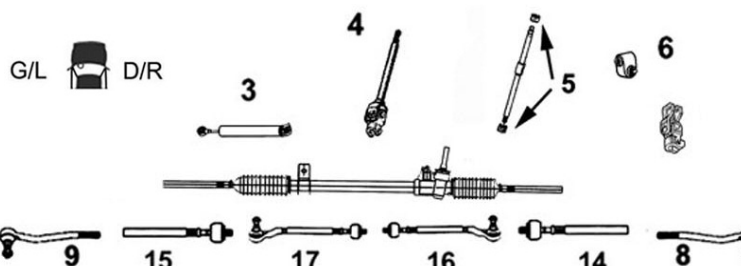

9006873

Axe de bielle G/D

OE 1K0423810A

L/R axial joint

14
 15

Côté dir. M16x1.5 Côté rot. M16x1.5 long 310 mm



1.4 TSi /4WD
 2.0 TFSi TSi /4WD
 2.0 TDi /4WD

... Tiguan ...

Eléments DIRECTION

Steering parts

Elementos Direcciones

Elementy układ kierowniczy

Элементы рулевой системы

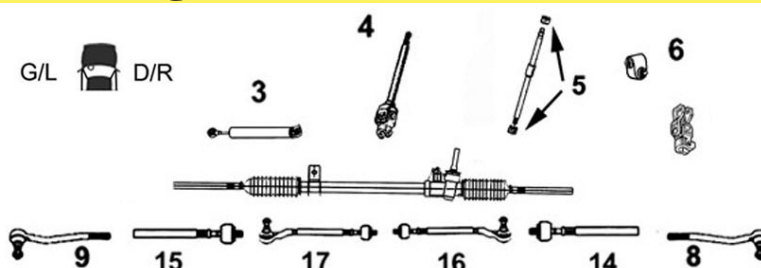

9006638

Rotule de direction G

OE 1K0423811K

Left tie rod end



9 M16 x 1.5

1.4 TSi /4WD
2.0 TFSi 4WD
2.0 TSi 4WD
2.0 TDi /FAP /4WD

9006637

Rotule de direction D

OE 1K0423812K

Right tie rod end



8 M16 x 1.5

1.4 TSi /4WD
2.0 TFSi 4WD
2.0 TSi 4WD
2.0 TDi /4WD



Barre stabilisatrice

Stabilizer bar

Barra estabilizadora

Drążek stabilizatora

стабилизатор поперечной устойчивости

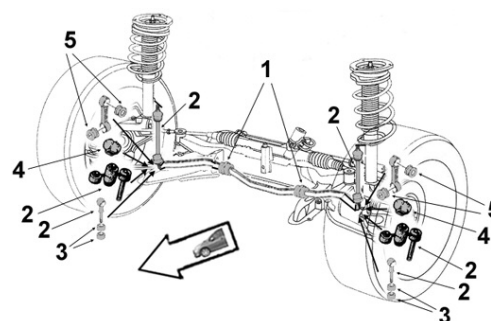

2306010

Biellette barre stab.

OE 1K0411315P

Stabilizer bar stub axle



2

1.4 TSi /4WD
2.0 TFSi TSi 4WD
2.0 TDi /4WD FAP

11/07-16/04/12
-16/04/12
11/07-16/04/12



Eléments SUSPENSION

Suspension parts

Elementos suspensión

Elementy zawieszenie

Элементы подвески

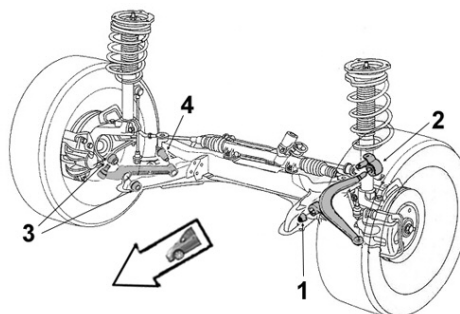

2256007

Articulation AR inf.

OE 3C0199231D

Rear lower bush



2

1.4 TSi 4WD BVM 11/07-
2.0 TFSi TSi 11/07-
2.0 TDi 4WD FAP 11/07-

9001759

Articulation AV inf.

OE 1K0407182

Front lower bush



1

**Ø int.12 Ø ext.40 coll.48
long. tube int.54 ext.33 ep. coll.6**

1.4 TSi 4WD 11/07-
2.0 TFSi TSi 4WD 11/07-
2.0 TDi 4WD 11/07-

... Tiguan ...

Bras & Triangle de suspension

Control arm
Brazo y triángulo
Wahacz
Рычаг подвески

G/L  D/R

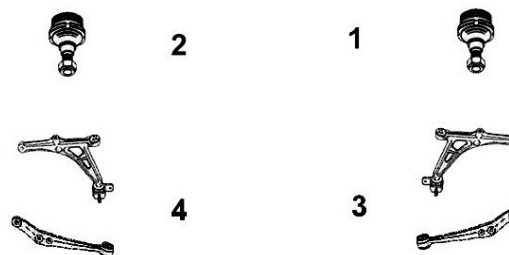

7476038

Triangle de susp. G/D

OE 3C0407151G

L/R track control arm



3 Sans rotule *Without tie rod end*
4

1.4 TSi /4WD
2.0 TFSi /4WD
2.0 TDi /4WD

11/07-02/11/09
12/07-02/11/09
11/07-02/11/09

7476180

Triangle de susp. G

OE 3C0407151G+1K0407365C

L track control arm

NEW



4 Avec rotule *With ball joint*

1.4 TSi /4WD 11/07-02/11/09
2.0 TFSi /4WD 12/07-02/11/09
2.0 TDi /4WD 11/07-02/11/09

7476179

Triangle de susp. D

OE 3C0407151G+1K0407366C

R track control arm

NEW



3 Avec rotule *With ball joint*

1.4 TSi /4WD 11/07-02/11/09
2.0 TFSi /4WD 12/07-02/11/09
2.0 TDi /4WD 11/07-02/11/09

9005570

Rotule de susp. inf. G

OE 1K0407365C

Left lower suspension ball joint



2

1.4 TSi /4WD 05/06-
2.0 TSi TFSI 4WD 12/07-
2.0 TDi /4WD 11/07-

9005569

Rotule de susp. inf. D

OE 1K0407366C

Right lower suspension ball joint



1

1.4 TSi /4WD 05/06-
2.0 TSi TFSI 4WD 12/07-
2.0 TDi /4WD 11/07-



Support d'amortisseur

Suspension mounting
Soporte amortiguador
Poduszka amortyzatora
Опора амортизатора

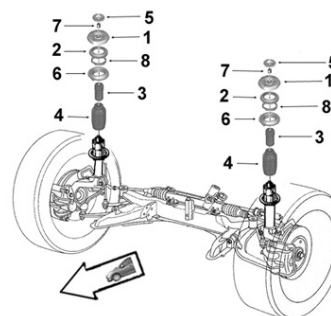

9005622

Support suspension G/D

OE 1K0412331B

L/R suspension mounting



1

1.4 TSi 4WD 11/07-
2.0 TFSi TSi
Sans susp. pilotée 11/07-
2.0 TDi 4WD
Sans susp. pilotée 11/07-

2656052

Butée de suspension

OE 1K0412303B

Shock bush



3

H70
1.4 TSi 2WD 11/07-
2.0 TDi 2WD 11/07-

... Tiguan



Support d'amortisseur
 Suspension mounting
 Soporte amortiguador
 Poduszka amortyzatora
 Опора амортизатора

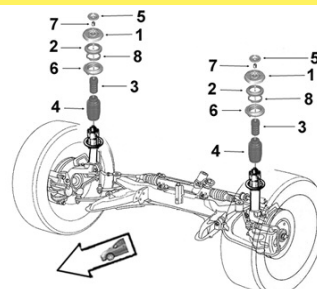

2656053 **Protecteur amortisseur G/D**
 OE 6N0413175A *L/R shock absorber protector*

4 H206



1.4 TSi /4WD
 2.0 TFSi 4WD
 2.0 TSi 4WD
 2.0 TDi /4WD

11/07-
 12/07-
 06/10-
 11/07-



Barre stabilisatrice
 Stabilizer bar
 Barra estabilizadora
 Drażek stabilizatora
 стабилизатор поперечной устойчивости

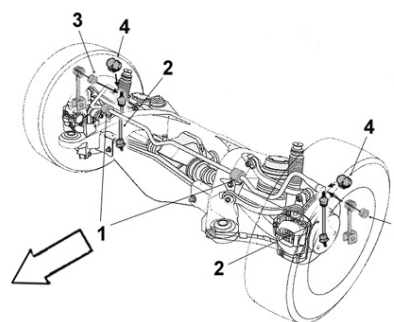

9005094 **Biellette barre stab.**
 OE 1K0505465K *Stabilizer bar stub axle*

2



1.4 TSi 4WD 11/07-
 2.0 TFSi TSi 4WD 11/07-
 2.0 TDi 4WD 11/07-

9001737 **Palier de barre milieu**
 OE 1K0511327AR *Middle bar main bearing*

1 Barre Ø 20.7



1.4 TSi 4WD 11/07-
 2.0 TFSi TSi 4WD 11/07-
 2.0 TDi 4WD 11/07-

2306014 **Palier de barre milieu**
 OE 1K0511327AS *Middle bar main bearing*

1 Barre Ø 21.7



1.4 TSi 4WD BVM 11/07-
 2.0 TFSi TSi 4WD 11/07-
 2.0 TDi 4WD FAP 11/07-

Eléments TRAIN ARRIERE
 Rear axle parts
 Tren TRAS
 Elementy zawieszenia tylnego
 элементы задней оси.



9001786 **Articulation essieu G/D inf.**
 OE 1K0505553A *Lower L/R axle bush*
 Ø int. 12 Ø ext. 37 long. tube int. 50 ext. 28



1.4 TSi 4WD 11/07-
 2.0 TFSi TSi 4WD 11/07-
 2.0 TDi 4WD 11/07-

Touareg ...

Eléments DIRECTION

Steering parts

Elementos Direcciones

Elementy układ kierowniczy

Элементы рулевой системы

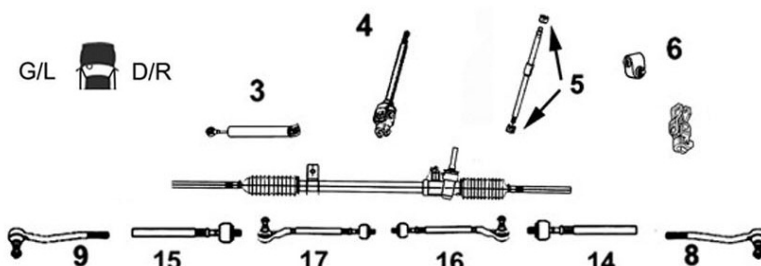

7776024 Axe de bielle G/D

Part/oe 7L0422803D L/R axial joint



14 Côté dir. M16x1.5 Côté rot. M16x1.5 long 288 mm

15	2.5 TDi 4WD	01/03-04/10
	3.0 TDi 4WD	11/04-
	3.2 4WD	10/02-11/06
	3.6 FSi 4WD	03/06-
	4.2 /FSi 4WD	12/02-04/10
	4.2 TDi 4WD	06/10-
	5.0 TDi 4WD	10/02-04/10
	6.0i W12 48v. 4WD	03/05-04/10

7676022 Rotule de direction G

OE 7L0422817D Left tie rod end



9	M16 x 1.5	
	2.5 TDi 4WD	01/03-04/10
	3.0 TDi 4WD	11/04-
	3.2 4WD	10/02-11/06
	3.6 FSi 4WD	03/06-
	4.2 /FSi 4WD	12/02-04/10
	4.2 TDi 4WD	06/10-
	5.0 TDi 4WD	10/02-04/10
	6.0i W12 48v. 4WD	03/05-04/10

7676021 Rotule de direction D

OE 7L0422818D Right tie rod end



8	M16 x 1.5	
	2.5 TDi 4WD	01/03-04/10
	3.0 TDi 4WD	11/04-
	3.2 4WD	10/02-11/06
	3.6 FSi 4WD	03/06-
	4.2 /FSi 4WD	12/02-04/10
	4.2 TDi 4WD	06/10-
	5.0 TDi 4WD	10/02-04/10
	6.0i W12 48v. 4WD	03/05-04/10



Eléments SUSPENSION

Suspension parts

Elementos suspensión

Elementy zawieszenie

Элементы подвески

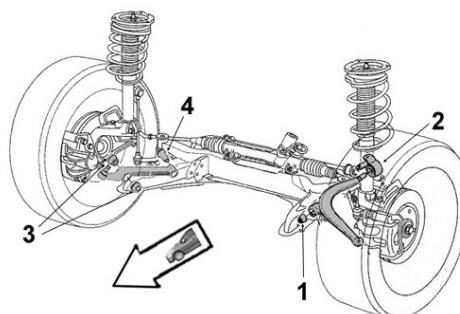

2256050 Articulation AR triangle inf.

OE 7L0407183A Track control arm rear bush



2 Ø int.14 Ø ext.40.5 coll.59 49.5 long. tube int.60 ext.35 ep. coll.5.6 3.7

	2.5 TDi 4WD	06/03-
	3.0 TDi 4WD	12/04-
	3.2i V6 24v. 4WD	11/02-
	3.6 FSi 4WD	09/05-
	4.2i V8 40v. 4WD	02/03-
	5.0 TDi 4WD	11/02-
	6.0i W12 48v. 4WD	01/05-

... Touareg

Bras & Triangle de suspension

Control arm
Brazo y triángulo
Wahacz
Рычаг подвески

G/L  D/R



7476034 Triangle de susp. G/D
OE 7L0407021B L/R track control arm



3 Avec rotule With ball joint
4

2.5 TDi 4WD	06/03-04/10
3.0 TDi 4WD	11/04-04/10
3.2i V6 24v. 4WD	11/02-12/06
3.6 FSi 4WD	03/06-04/10
4.2i V8 40v. 4WD	02/03-04/10
5.0 TDi 4WD	11/02-04/10
6.0i W12 48v. 4WD	01/05-04/10

7476037 Triangle de susp. inf. G
OE 7L0407151H Lower left track control arm



4 Avec rotule With ball joint
PR 1LC/1LE/1LF

2.5 TDi 4WD	06/03-01/06/08
3.0 TDi 4WD	11/04-01/06/08
3.2i V6 24v. 4WD	11/02-01/06/08
3.6 FSi 4WD	03/06-01/06/08
4.2i V8 40v. 4WD	02/03-01/06/08
5.0 TDi 4WD	11/02-01/06/08
6.0i W12 48v. 4WD	08/04-01/06/08

7476035 Triangle de susp. inf. D
OE 7L0407152H Lower right track control arm



3 Avec rotule With ball joint
PR 1LC/1LE/1LF

2.5 TDi 4WD	06/03-01/06/08
3.0 TDi 4WD	11/04-01/06/08
3.2i V6 24v. 4WD	11/02-01/06/08
3.6 FSi 4WD	03/06-01/06/08
4.2i V8 40v. 4WD	02/03-01/06/08
5.0 TDi 4WD	11/02-01/06/08
6.0i W12 48v. 4WD	08/04-01/06/08

Touran ...

Eléments DIRECTION

Steering parts
Elementos Direcciones
Elementy układ kierowniczy
Элементы рулевой системы

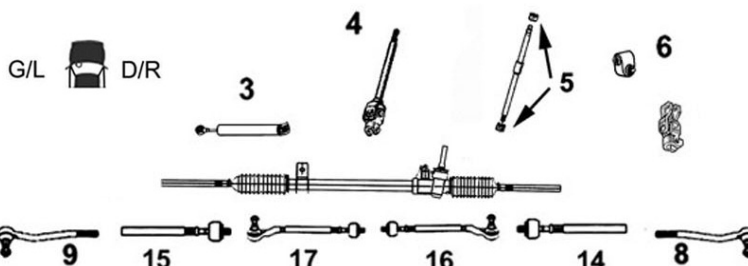

9006873 Axe de bielle G/D
OE 1K0423810A L/R axial joint



14 Côté dir. M16x1.5 Côté rot. M16x1.5 long 310 mm
15

1.2 TSi
1.4 TSi
1.6i
1.6i FSi
1.6 TDi
1.9 TDi
2.0 FSi
2.0 TDi

9006638 Rotule de direction G
OE 1K0423811K Left tie rod end



9 M16 x 1.5

1.2 TSi	09/10-
1.4 TSi	05/06-
1.6i	01/04-09/10
1.6 FSi	03/03-12/06
1.6 TDi	03/03-
1.9 TDi	03/03-09/10
2.0 FSi	05/04-05/06
2.0 TDi	03/03-

9006637 Rotule de direction D
OE 1K0423812K Right tie rod end



8 M16 x 1.5

1.2 TSi	09/10-
1.4 TSi	05/06-
1.6i	01/04-09/10
1.6 FSi	03/03-12/06
1.6 TDi	03/03-
1.9 TDi	03/03-09/10
2.0 FSi	05/04-05/06
2.0 TDi	03/03-

... Touran ...



Barre stabilisatrice
 Stabilizer bar
 Barra estabilizadora
 Drążek stabilizatora
 стабилизатор поперечной устойчивости

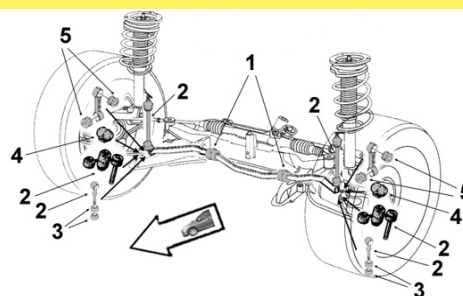

2306010 **Biellette barre stab.**
 OE 1K0411315P *Stabilizer bar stub axle*



2	1.2 TSi		09/10-
	1.4 TSi		11/06-16/04/12
	1.6i	BVM	11/06-
	1.6 FSi		03/03-
	1.6 TDi		05/10-
	1.9 TDi	BVM	03/03-
	1.9 TDi FAP	BVA	11/06-04/08
	2.0 FSi		10/03-
	2.0 TDi		03/03-



Eléments SUSPENSION
 Suspension parts
 Elementos suspensión
 Elementy zawieszenie
 Элементы подвески

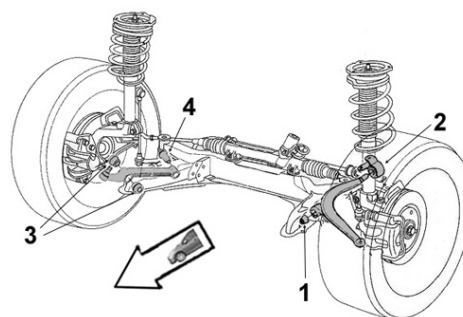

9001759 **Articulation AV**
 OE 1K0407182 *Front bush*



1	Ø int.12 Ø ext.40 coll.48 long. tube int.54 ext.33 ep. coll.6		
	1.2 TSi		
	1.4 TSi		11/06-
	1.6		11/06-
	1.6 FSi		03/03-01/07
	1.6 TDi		
	1.9 TDi		03/03-
	2.0 FSi		
2.0 TDi		03/03-	

2256003 **Articulation AR G**
 OE 1K0199231J *Left rear bush*



2	1.2 TSi	09/10-
	1.4 TSi	11/06-
	1.6i	11/06-
	1.6 FSi	03/03-01/07
	1.6 TDi	09/10-
	1.9 TDi	03/03-
	2.0 FSi	10/03-05/08
	2.0 TDi	03/03-

2256002 **Articulation AR D**
 OE 1K0199232J *Right rear bush*



2	1.2 TSi	09/10-
	1.4 TSi	11/06-
	1.6i	11/06-
	1.6 FSi	03/03-01/07
	1.6 TDi	09/10-
	1.9 TDi	03/03-
	2.0 FSi	10/03-05/08
	2.0 TDi	03/03-

... Touran ...

Bras & Triangle de suspension

Control arm
Brazo y triángulo
Wahacz
Рычаг подвески

G/L  D/R

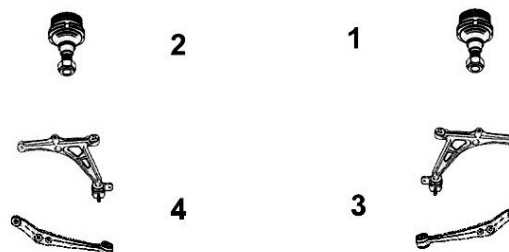

7476018

Triangle de susp. G

OE 1K0407151AC

Left track control arm



4 Fonte Iron Sans rotule Without tie rod end

-ch 1T-9-140000 -ch 1T-A-008000

1.4 TSi 16v.	05/06-24/05/09
1.6i	01/04-24/05/09
1.6 FSi	03/03-24/05/09
1.9 TDi	03/03-24/05/09
2.0 FSi	05/04-24/05/09
2.0 TDi	03/03-24/05/09

7476017

Triangle de susp. D

OE 1K0407152AC

Right track control arm



3 Fonte Iron Sans rotule Without tie rod end

-ch 1T-9-140000 -ch 1T-A-008000

1.4 TSi 16v.	05/06-24/05/09
1.6i	01/04-24/05/09
1.6 FSi	03/03-24/05/09
1.9 TDi	03/03-24/05/09
2.0 FSi	05/04-24/05/09
2.0 TDi	03/03-24/05/09

7476128

Triangle de susp. G

OE 1K0407151AC+1K0407365C *L track control arm*



NEW

4 Avec rotule With ball joint

-ch 1T-9-140000 -ch 1T-A-008000

1.4 TSi 16v.	05/06-24/05/09
1.4 TSi 16v.	05/06-24/05/09
2.0 FSi	05/04-24/05/09
2.0 FSi	05/04-24/05/09

7476127

Triangle de susp. D

OE 1K0407152M+1K0407366C *R track control arm*



NEW

3 Avec rotule With ball joint

-ch 1T-9-140000 -ch 1T-A-008000

1.4 TSi 16v.	05/06-24/05/09
1.4 TSi 16v.	05/06-24/05/09
2.0 FSi	05/04-24/05/09
2.0 FSi	05/04-24/05/09

9005570

Rotule de susp. inf. G

OE 1K0407365C

Left lower suspension ball joint



2

1.2 TSi		
1.4 TSi 16v.		05/06-
1.6i	Ch- 1T4074201	
1.6 FSi	Ch- 1T4074201	-12/06
1.6 TDi		
1.9 TDi	Ch- 1T4074201	
2.0 /FSi		
2.0 TDi	Ch- 1T4074201	

9005569

Rotule de susp. inf. D

OE 1K0407366C

Right lower suspension ball joint



1

1.2 TSi		
1.4 TSi 16v.		05/06-
1.6i	Ch- 1T4074201	
1.6 FSi	Ch- 1T4074201	-12/06
1.6 TDi		
1.9 TDi	Ch- 1T4074201	
2.0 /FSi		
2.0 TDi	Ch- 1T4074201	

... Touran ...



Support d'amortisseur
Suspension mounting
Soporte amortiguador
Poduszka amortyzatora
Опора амортизатора

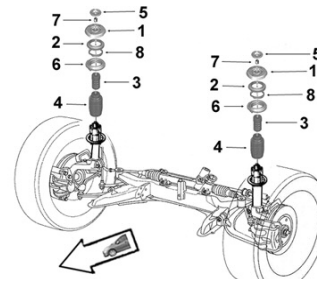

9005622 **Support suspension G/D**
 OE 1K0412331B *L/R suspension mounting*



1

1.2 TSi	
1.4 TSi	11/06-
1.6	11/06-
1.6 FSi	03/03-
1.6 TDi	
1.9 TDi	03/03-
2.0 /FSi	
2.0 TDi	03/03-

2656052 **Butée de suspension**
 OE 1K0412303B *Shock bush*



3 **H70**

1.2 TSi	09/10-
1.4 TSi	11/06-
1.6i	01/04-09/10
1.6 FSi	03/03-12/06
1.6 TDi	09/10-
1.9 TDi	03/03-09/10
2.0 FSi	05/04-05/06
2.0 TDi	03/03--

2656053 **Protecteur amortisseur G/D**
 OE 6N0413175A *L/R shock absorber protector*



4 **H206**

1.2 TSi	09/10-
1.4 TSi	11/06-
1.6i	01/04-12/06
1.6 FSi	03/03-12/06
1.6 TDi	09/10-
1.9 TDi	03/03-09/10
2.0 FSi	05/04-05/06
2.0 TDi	03/03-



Barre stabilisatrice
Stabilizer bar
Barra estabilizadora
Drażek stabilizatora
стабилизатор поперечной устойчивости

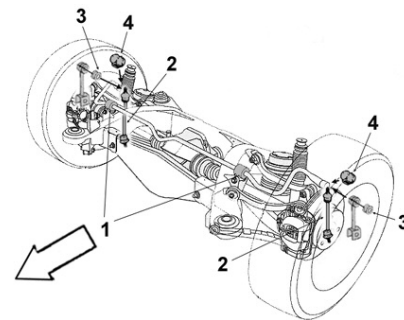

9005094 **Biellette barre stab.**
 OE 1K0505465K *Stabilizer bar stub axle*



2

1.2 TSi	
1.4 TSi	11/06-
1.6	Ch- 1T-4-195001
1.6 FSi	Ch- 1T-4-195001
1.6 TDi	
1.9 TDi	Ch- 1T-4-195001
2.0 FSi	
2.0 TDi	Ch- 1T-4-195001

9001737 **Palier de barre milieu**
 OE 1K0511327AR *Middle bar main bearing*



1 **Barre Ø 20.7**

1.2 TSi	09/10-
1.4 TSi	-ch 1T-6-300000 02/06-
1.6	
1.6 FSi	03/03-
1.6 TDi	09/10-
1.9 TDi	
2.0 FSi	-ch 1T-6-300000 10/03-
2.0 TDi	03/03-

2306014 **Palier de barre milieu**
 OE 1K0511327AS *Middle bar main bearing*



1 **Barre Ø 21.7**

1.4 TSi 16v.	11/06-
1.6i	11/06-
1.6 FSi	02/03-
1.6 TDi	09/10-
1.9 TDi	02/03-
2.0 FSi	10/03-
2.0 TDi /FAP	02/03-

... Touran

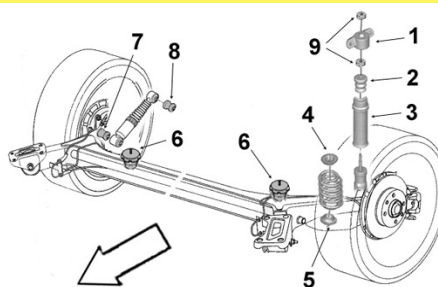

Support d'amortisseur
 Suspension mounting
 Soporte amortiguador
 Poduszka amortyzatora
 Опора амортизатора

**2656051****Butée de suspension**

OE 1K0511353P

Shock bush**2 H 133 Susp. sport -ch 1T-6-170000**

1.4 TSi	05/06-
1.6i	01/04-
1.6 FSi	03/03-
1.9 TDi	03/03-
2.0 FSi	05/04-
2.0 TDi	03/03-

2656039**Butée de suspension**

OE 1K0511353R

Shock bush**2 H 143 Susp. normale -ch 1T-6-170000**

1.4 TSi 16v.	05/06-12/06
1.6i	01/04-12/06
1.6 FSi	03/03-12/06
1.9 TDi	03/03-12/06
2.0 FSi	05/04-05/06
2.0 TDi 16v.	03/03-12/06

Eléments TRAIN ARRIERE*Rear axle parts**Tren TRAS**Elementy zawieszenia tylnego**элементы задней оси.***9001786****Articulation essieu G/D inf.**

OE 1K0505553A

Lower L/R axle bush

Ø int. 12 Ø ext. 37 long. tube int. 50 ext. 28

1.2 TSi	
1.4 TSi	
1.6	
1.6 FSi	
1.6 TDi	
1.9 TDi	
2.0 FSi	
2.0 TDi	

Vento ...

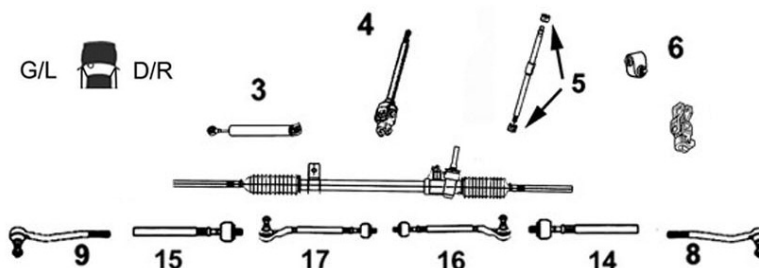
Eléments DIRECTION*Steering parts**Elementos Direcciones**Elementy układ kierowniczy**Элементы рулевой системы*G/L  D/R**9006211****Axe de bielle G/D**

Part/oe 1H0419803

L/R axial joint**14** Côté dir. M22x1.5 Côté rot. M14x1.5
15 long 394 mm

TT /all models DNA
 Sauf 16v. et Dir. ZF 11/91-

9006212**Axe de bielle G/D**

OE 803419811

L/R axial joint**14** Côté dir. M14x1.5 Côté rot. M14x1.5
15 long 359 mm

TT /all models DA ZF 11/91-

9006218**Axe de bielle G/D**



Part/oe 1H0422803

L/R axial joint**14** Côté dir. M14x1.5 Côté rot. M14x1.5 long 371 mm
15

TT /all models DA TRW

11/91-



... Vento ...

9006380 OE 191419811	Rotule de direction G <i>Left tie rod end</i>	9006381 OE 191419812	Rotule de direction D <i>Right tie rod end</i>
	9 M14x1.5 TT /all models DNA DA 11/91-		8 M14x1.5 TT /all models DNA DA 11/91-

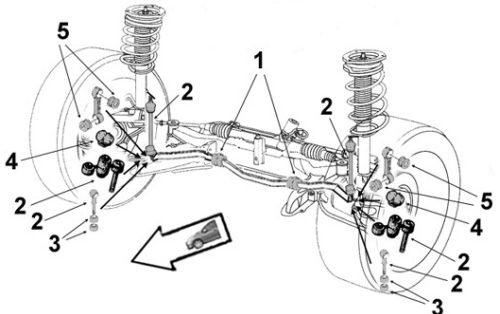

Barre stabilisatrice
 Stabilizer bar
 Barra estabilizadora
 Drążek stabilizatora
 стабилизатор поперечной устойчивости





9005050 OE 191411315B	Biellette barre stab. <i>Stabilizer bar stub axle</i>	9001522 OE 191411314	Palier de barre milieu <i>Middle bar main bearing</i>
	2 Ø int.17 1.4i 11/91- 1.6 11/91- 1.8i 11/91- 1.9 SDi 11/91- 1.9 TD 11/91- 1.9 TDi 11/91- 2.0 sauf GTi 16v. 11/91- 2.8 VR6 11/91-		1 Barre Ø 17 1.4i 10/94- 1.6 10/94- 1.8i 10/94- 1.9 SDi 10/94- 1.9 TD 10/94- 2.0 10/94- 2.0i 16v. 10/94- 2.8 VR6 10/94-

9001760 OE 1H0411314	Palier de barre milieu <i>Middle bar main bearing</i>		
	1 Barre Ø 20 2.0 GTi	01/97-12/97	

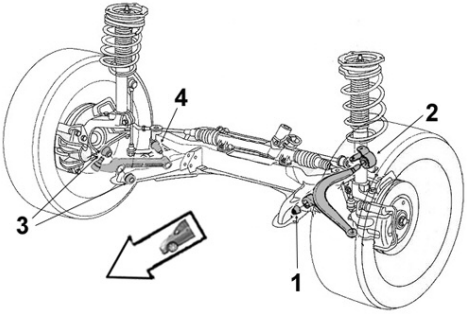

Eléments SUSPENSION
 Suspension parts
 Elementos suspensión
 Elementy zawieszenie
 Элементы подвески



9001520 OE 191407181D	Articulation AR <i>Rear bush</i>	9001523 OE 357407182	Articulation AV <i>Front bush</i>
	2 Ø int.17 Ø ext.60.5 long. tube int.41 ext.24.5 1.4i 10/94- 1.6 10/94- 1.8i 10/94- 1.9 SDi 10/94- 1.9 TD 10/94- 2.0/i 16v. 10/94- 2.8 VR6 10/94-		1 Ø int.12 Ø ext.33 coll.36 long. tube int.54 ext.29 ep. coll.5 1.4i 10/94- 1.6 10/94- 1.8i 10/94- 1.9 SDi 10/94- 1.9 TD 10/94- 2.0/i 16v. 10/94- 2.8 VR6 10/94-

... Vento ...

Bras & Triangle de suspension

Control arm
Brazo y triángulo
Wahacz
Рычаг подвески

G/L  D/R



9005134

Triangle de susp. G/D

OE 1H0407151

L/R track control arm



3 Sans rotule *Without tie rod end*

1.4i	11/91-
1.6	11/91-
1.8i	11/91-
1.9 SDi	11/91-
1.9 TD	11/91-
1.9 TDi	11/91-

9005753

Triangle de susp. G

OE 1H0407151A

Left track control arm



4 Sans rotule *Without tie rod end*

1.9 TDi 110hp 81kw	11/91-
2.0i GT /16v.	11/91-
2.8 VR6	11/91-

9005754

Triangle de susp. D

OE 1H0407152

Right track control arm



3 Sans rotule *Without tie rod end*

1.9 TDi 110hp 81kw	11/91-
2.0i GT /16v.	11/91-
2.8 VR6	11/91-

7476109

Triangle de susp. G

OE 1H0407151+357407365 *Left track control arm*

NEW



4 Avec rotule *With ball joint Ø 19*

1.4i	11/91-
1.6	11/91-
1.8i	11/91-
1.9 SDi	11/91-
1.9 TD	11/91-
1.9 TDi	11/91-

7476110

Triangle de susp. D

OE 1H0407151+357407365 *Right track control arm*

NEW



3 Avec rotule *With ball joint Ø 19*

1.4i	11/91-
1.6	11/91-
1.8i	11/91-
1.9 SDi	11/91-
1.9 TD	11/91-
1.9 TDi	11/91-

7476117

Triangle de susp. G

OE 1H0407151A+1H0407365 *Left track control arm*

NEW



4 Avec rotule *With ball joint*

2.0i GT /16v.	11/91-
2.8 VR6	11/91-

7476115

Triangle de susp. D

OE 1H0407152+1H0407365 *Right track control arm*

NEW



3 Avec rotule *With ball joint*

2.0i GT /16v.	11/91-
2.8 VR6	11/91-

9005260

Rotule de susp. inf. G/D

OE 357407365

L/R lower suspension ball joint



1 **2** Ø 19 *Cylindrique*

1.4i	11/91-
1.6	11/91-
1.8i	11/91-
1.9 SDi	11/91-
1.9 TD	11/91-
1.9 TDi	11/91-
2.0i 16v. sauf GT	11/91-

9005268

Rotule de susp. inf. G/D

OE 1H0407365

L/R lower suspension ball joint









1 **2** Cône Ø 16.8 - Ø 18







2.0i GT /16v.	11/91-
2.8 VR6	11/91-







... Vento ...





9155490	Kit rép. train AV	
OE -	<i>Front axle repair kit</i>	
	Sans visserie <i>Without screws and bolts</i> Barre Ø 17	
	TT /all models	11/91-

 <p>Support d'amortisseur <i>Suspension mounting</i> <i>Soporte amortiguador</i> <i>Poduszka amortyzatora</i> <i>Опора амортизатора</i></p>	
---	---

<table border="1" style="width: 100%; border-collapse: collapse;"> <tr> <td style="width: 15%;">9005604</td> <td style="width: 35%;">Support suspension AV G/D</td> <td style="width: 50%;"></td> </tr> <tr> <td>OE 191412329</td> <td><i>L/R front susp. mounting</i></td> <td></td> </tr> <tr> <td></td> <td>1 Avec roulement <i>With bearing</i></td> <td></td> </tr> <tr> <td></td> <td>1.4i -ch 1H-S-062538 11/91-</td> <td></td> </tr> <tr> <td></td> <td>1.6 ABU AEA AEE 10/94-</td> <td></td> </tr> <tr> <td></td> <td>1.8i -ch 1H-S-062538 11/91-</td> <td></td> </tr> </table>	9005604	Support suspension AV G/D		OE 191412329	<i>L/R front susp. mounting</i>			1 Avec roulement <i>With bearing</i>			1.4i -ch 1H-S-062538 11/91-			1.6 ABU AEA AEE 10/94-			1.8i -ch 1H-S-062538 11/91-		<table border="1" style="width: 100%; border-collapse: collapse;"> <tr> <td style="width: 15%;">9001709</td> <td style="width: 35%;">Support suspension G/D</td> <td style="width: 50%;"></td> </tr> <tr> <td>OE 357412331A</td> <td><i>L/R suspension mounting</i></td> <td></td> </tr> <tr> <td></td> <td>1</td> <td></td> </tr> <tr> <td></td> <td>1.4i Ch- 1H-S-062539 11/91-</td> <td></td> </tr> <tr> <td></td> <td>1.6 AEK AFT AKS 11/91-</td> <td></td> </tr> <tr> <td></td> <td>1.8i Ch- 1H-S-062539 11/91-</td> <td></td> </tr> <tr> <td></td> <td>1.9 SDi 04/97-09/98</td> <td></td> </tr> <tr> <td></td> <td>1.9 TD Ch-1H-SW062539 -09/98</td> <td></td> </tr> <tr> <td></td> <td>1.9 TDi 11/91-</td> <td></td> </tr> <tr> <td></td> <td>2.0/i 16v. 11/91-</td> <td></td> </tr> <tr> <td></td> <td>2.8 VR6 11/91-</td> <td></td> </tr> </table>	9001709	Support suspension G/D		OE 357412331A	<i>L/R suspension mounting</i>			1			1.4i Ch- 1H-S-062539 11/91-			1.6 AEK AFT AKS 11/91-			1.8i Ch- 1H-S-062539 11/91-			1.9 SDi 04/97-09/98			1.9 TD Ch-1H-SW062539 -09/98			1.9 TDi 11/91-			2.0/i 16v. 11/91-			2.8 VR6 11/91-	
9005604	Support suspension AV G/D																																																			
OE 191412329	<i>L/R front susp. mounting</i>																																																			
	1 Avec roulement <i>With bearing</i>																																																			
	1.4i -ch 1H-S-062538 11/91-																																																			
	1.6 ABU AEA AEE 10/94-																																																			
	1.8i -ch 1H-S-062538 11/91-																																																			
9001709	Support suspension G/D																																																			
OE 357412331A	<i>L/R suspension mounting</i>																																																			
	1																																																			
	1.4i Ch- 1H-S-062539 11/91-																																																			
	1.6 AEK AFT AKS 11/91-																																																			
	1.8i Ch- 1H-S-062539 11/91-																																																			
	1.9 SDi 04/97-09/98																																																			
	1.9 TD Ch-1H-SW062539 -09/98																																																			
	1.9 TDi 11/91-																																																			
	2.0/i 16v. 11/91-																																																			
	2.8 VR6 11/91-																																																			

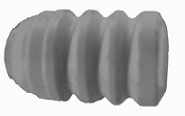
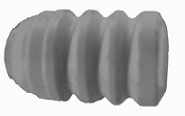
<table border="1" style="width: 100%; border-collapse: collapse;"> <tr> <td style="width: 15%;">9001708</td> <td style="width: 35%;">Support suspension G/D</td> <td style="width: 50%;"></td> </tr> <tr> <td>OE 357412329</td> <td><i>L/R suspension mounting</i></td> <td></td> </tr> <tr> <td></td> <td>1 Avec roulement <i>With bearing</i></td> <td></td> </tr> <tr> <td></td> <td>1.8i -08/94</td> <td></td> </tr> <tr> <td></td> <td>1.9 SDi -08/94</td> <td></td> </tr> <tr> <td></td> <td>1.9 TD -08/94</td> <td></td> </tr> <tr> <td></td> <td>1.9 TDi Except AFN -08/94</td> <td></td> </tr> <tr> <td></td> <td>2.0 -08/94</td> <td></td> </tr> </table>	9001708	Support suspension G/D		OE 357412329	<i>L/R suspension mounting</i>			1 Avec roulement <i>With bearing</i>			1.8i -08/94			1.9 SDi -08/94			1.9 TD -08/94			1.9 TDi Except AFN -08/94			2.0 -08/94		<table border="1" style="width: 100%; border-collapse: collapse;"> <tr> <td style="width: 15%;">9005352</td> <td style="width: 35%;">Butée à billes G/D</td> <td style="width: 50%;"></td> </tr> <tr> <td>OE 1J0412249</td> <td><i>L/R ball bearing</i></td> <td></td> </tr> <tr> <td></td> <td>2</td> <td></td> </tr> <tr> <td></td> <td>1.4i 01/92-</td> <td></td> </tr> <tr> <td></td> <td>1.8i ABS</td> <td></td> </tr> <tr> <td></td> <td>1.8i 01/92-</td> <td></td> </tr> <tr> <td></td> <td>1.9 SDi 01/92-</td> <td></td> </tr> <tr> <td></td> <td>1.9 TD/TDi 01/92-</td> <td></td> </tr> <tr> <td></td> <td>2.0/i 16v. 01/92-</td> <td></td> </tr> <tr> <td></td> <td>2.8 VR6 01/92-</td> <td></td> </tr> </table>	9005352	Butée à billes G/D		OE 1J0412249	<i>L/R ball bearing</i>			2			1.4i 01/92-			1.8i ABS			1.8i 01/92-			1.9 SDi 01/92-			1.9 TD/TDi 01/92-			2.0/i 16v. 01/92-			2.8 VR6 01/92-	
9001708	Support suspension G/D																																																						
OE 357412329	<i>L/R suspension mounting</i>																																																						
	1 Avec roulement <i>With bearing</i>																																																						
	1.8i -08/94																																																						
	1.9 SDi -08/94																																																						
	1.9 TD -08/94																																																						
	1.9 TDi Except AFN -08/94																																																						
	2.0 -08/94																																																						
9005352	Butée à billes G/D																																																						
OE 1J0412249	<i>L/R ball bearing</i>																																																						
	2																																																						
	1.4i 01/92-																																																						
	1.8i ABS																																																						
	1.8i 01/92-																																																						
	1.9 SDi 01/92-																																																						
	1.9 TD/TDi 01/92-																																																						
	2.0/i 16v. 01/92-																																																						
	2.8 VR6 01/92-																																																						

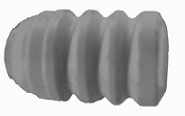
<table border="1" style="width: 100%; border-collapse: collapse;"> <tr> <td style="width: 15%;">9005362</td> <td style="width: 35%;">Butée de suspension G/D</td> <td style="width: 50%;"></td> </tr> <tr> <td>OE 357412303E</td> <td><i>L/R suspension bush</i></td> <td></td> </tr> <tr> <td></td> <td>3 H84</td> <td></td> </tr> <tr> <td></td> <td>1.4i -09/94</td> <td></td> </tr> <tr> <td></td> <td>1.6 -09/94</td> <td></td> </tr> <tr> <td></td> <td>1.8i -09/94</td> <td></td> </tr> <tr> <td></td> <td>1.9 SDi -09/94</td> <td></td> </tr> <tr> <td></td> <td>1.9 TD -09/94</td> <td></td> </tr> <tr> <td></td> <td>2.0 -09/94</td> <td></td> </tr> </table>	9005362	Butée de suspension G/D		OE 357412303E	<i>L/R suspension bush</i>			3 H84			1.4i -09/94			1.6 -09/94			1.8i -09/94			1.9 SDi -09/94			1.9 TD -09/94			2.0 -09/94		<table border="1" style="width: 100%; border-collapse: collapse;"> <tr> <td style="width: 15%;">9005338</td> <td style="width: 35%;">Butée de suspension</td> <td style="width: 50%;"></td> </tr> <tr> <td>OE 1H0412303B</td> <td><i>Shock bush</i></td> <td></td> </tr> <tr> <td></td> <td>3 H64</td> <td></td> </tr> <tr> <td></td> <td>1.8 /GT</td> <td></td> </tr> <tr> <td></td> <td>1.9 SDi</td> <td></td> </tr> <tr> <td></td> <td>1.9 TD</td> <td></td> </tr> <tr> <td></td> <td>1.9 TDi</td> <td></td> </tr> </table>	9005338	Butée de suspension		OE 1H0412303B	<i>Shock bush</i>			3 H64			1.8 /GT			1.9 SDi			1.9 TD			1.9 TDi	
9005362	Butée de suspension G/D																																																
OE 357412303E	<i>L/R suspension bush</i>																																																
	3 H84																																																
	1.4i -09/94																																																
	1.6 -09/94																																																
	1.8i -09/94																																																
	1.9 SDi -09/94																																																
	1.9 TD -09/94																																																
	2.0 -09/94																																																
9005338	Butée de suspension																																																
OE 1H0412303B	<i>Shock bush</i>																																																
	3 H64																																																
	1.8 /GT																																																
	1.9 SDi																																																
	1.9 TD																																																
	1.9 TDi																																																

<table border="1" style="width: 100%; border-collapse: collapse;"> <tr> <td style="width: 15%;">9005363</td> <td style="width: 35%;">Butée de suspension G/D</td> <td style="width: 50%;"></td> </tr> <tr> <td>OE 357412303F</td> <td><i>L/R suspension bush</i></td> <td></td> </tr> <tr> <td></td> <td>3 H83</td> <td></td> </tr> <tr> <td></td> <td>2.0i /16v. 10/94-</td> <td></td> </tr> <tr> <td></td> <td>2.8 VR6 10/94-</td> <td></td> </tr> </table>	9005363	Butée de suspension G/D		OE 357412303F	<i>L/R suspension bush</i>			3 H83			2.0i /16v. 10/94-			2.8 VR6 10/94-		<table border="1" style="width: 100%; border-collapse: collapse;"> <tr> <td style="width: 15%;">9005327</td> <td style="width: 35%;">Protecteur amortisseur G/D</td> <td style="width: 50%;"></td> </tr> <tr> <td>OE 357413175A</td> <td><i>L/R shock absorber protector</i></td> <td></td> </tr> <tr> <td></td> <td>4 H221.5</td> <td></td> </tr> <tr> <td></td> <td>1.4i 10/94-</td> <td></td> </tr> <tr> <td></td> <td>1.6 10/94-</td> <td></td> </tr> <tr> <td></td> <td>1.8i</td> <td></td> </tr> <tr> <td></td> <td>1.9 SDi 10/94-</td> <td></td> </tr> <tr> <td></td> <td>1.9 TD/TDi 10/94-</td> <td></td> </tr> <tr> <td></td> <td>2.0/i 16v. 10/94-</td> <td></td> </tr> <tr> <td></td> <td>2.8 VR6 10/94-</td> <td></td> </tr> </table>	9005327	Protecteur amortisseur G/D		OE 357413175A	<i>L/R shock absorber protector</i>			4 H221.5			1.4i 10/94-			1.6 10/94-			1.8i			1.9 SDi 10/94-			1.9 TD/TDi 10/94-			2.0/i 16v. 10/94-			2.8 VR6 10/94-	
9005363	Butée de suspension G/D																																													
OE 357412303F	<i>L/R suspension bush</i>																																													
	3 H83																																													
	2.0i /16v. 10/94-																																													
	2.8 VR6 10/94-																																													
9005327	Protecteur amortisseur G/D																																													
OE 357413175A	<i>L/R shock absorber protector</i>																																													
	4 H221.5																																													
	1.4i 10/94-																																													
	1.6 10/94-																																													
	1.8i																																													
	1.9 SDi 10/94-																																													
	1.9 TD/TDi 10/94-																																													
	2.0/i 16v. 10/94-																																													
	2.8 VR6 10/94-																																													

... Vento



Support d'amortisseur
Suspension mounting
Soporte amortiguador
Poduszka amortyzatora
Опора амортизатора

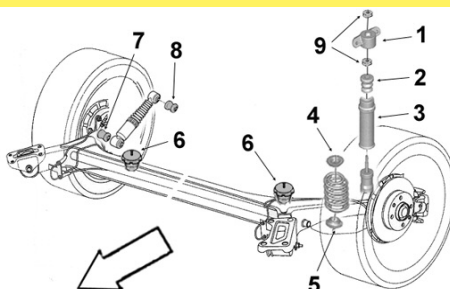

9005361 **Butée de suspension AR G/D**
 OE 191512131B *L/R rear suspension bush*



2 H146

1.4i	10/94-
1.6	10/94-
1.8i	
1.9 SDi	10/94-
1.9 TD/TDi	10/94-
2.0/i 16v.	10/94-
2.8 VR6	10/94-

9005368 **Protecteur amortisseur G/D**
 OE 191513425 *L/R shock absorber protector*



3 H90

1.4i	10/94-
1.6	10/94-
1.8i	10/94-
1.9 SDi	10/94-
1.9 TD	10/94-
2.0/i 16v.	10/94-
2.8 VR6	10/94-

Eléments TRAIN ARRIERE
Rear axle parts
Tren TRAS
Elementy zawieszenia tylnego
элементы задней оси.



9001705 **Articulation essieu AR G/D**
 OE 1H0501541A *L/R Rear axle bush*



Ø int.12 Ø ext.56.5 coll.74
long. tube int.90 ext.51 ep. coll.3

1.4i	10/94-
1.6	10/94-
1.8i	10/94-
1.9 SDi	10/94-
1.9 TD	10/94-
2.0/i 16v.	10/94-
2.8 VR6	10/94-

Caddy ...

Eléments DIRECTION
Steering parts
Elementos Direcciones
Elementy uklad kierowniczy
Элементы рулевой системы

G/L D/R

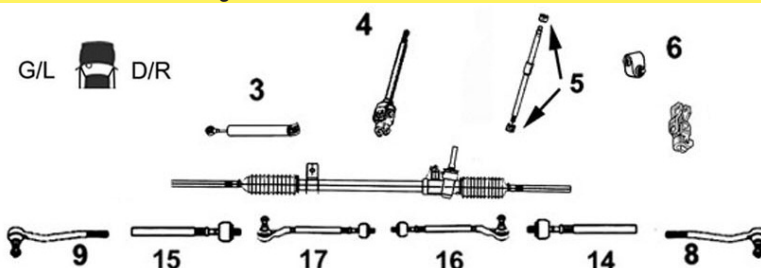

9006870 **Axe de bielle G/D**
 OE 6K0422821B *L/R axial joint*



14 Côté dir. M14x1.5 Côté rot. M14x1.5
15 long 335 mm

Pneus 185/60/R14 -ch 9K1523000

1.4	01/96-
1.6	01/96-
1.7 SDi	01/96-
1.9 TDi	01/96-

9006871 **Axe de bielle G/D**
 Part/oe 6K0422821A *L/R axial joint*



14 Côté dir. M14x1.5 Côté rot. M14x1.5
15 long 345 mm

Sauf pneus 185/60/R14

1.4	01/96-
1.6	01/96-
1.7 SDi	01/96-
1.9 TDi	01/96-

9006872 **Axe de bielle G/D**
 Part/oe 6K0422803E *L/R axial joint*



14 Côté dir. M14x1.5 Côté rot. M14x1.5
15 long 318 mm

Pneus 185/60/R14

1.4	Ch- 9K1523001	01/96-
1.4i 16v.		01/01-03/04
1.6i	Ch- 9K1523001	01/96-
1.7 SDi	Ch- 9K1523001	01/96-
1.9 SDi		09/96-12/00
1.9 TDi	Ch- 9K1523001	01/96-











9006873 **Axe de bielle G/D**
 OE 1K0423810A *L/R axial joint*

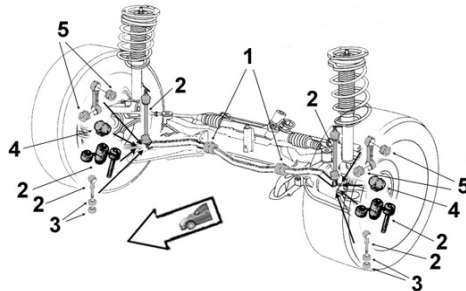

14 Côté dir. M16x1.5 Côté rot. M16x1.5
15 long 310 mm

1.2 TSi	07/10-
1.4i 16v.	03/04-
1.6i	03/04-
1.6 TDi	07/10-
1.9 TDi /DSG /4WD /FAP /Tramper	03/04-
2.0i /GNV /Tramper	06/06-

... Caddy ...

<p>9006380 Rotule de direction G <i>Left tie rod end</i> OE 3A0422811</p>  <p>9 M14 x 1.5</p> <table style="width: 100%;"> <tr><td>1.4</td><td>01/96-02/04</td></tr> <tr><td>1.6</td><td>01/96-02/04</td></tr> <tr><td>1.7 SDi</td><td>01/96-02/04</td></tr> <tr><td>1.9 SDi</td><td>01/96-02/04</td></tr> <tr><td>1.9 TDi</td><td>01/96-02/04</td></tr> </table>	1.4	01/96-02/04	1.6	01/96-02/04	1.7 SDi	01/96-02/04	1.9 SDi	01/96-02/04	1.9 TDi	01/96-02/04	<p>9006381 Rotule de direction D <i>Right tie rod end</i> OE 3A0422812</p>  <p>8 M14 x 1.5</p> <table style="width: 100%;"> <tr><td>1.4</td><td>01/96-02/04</td></tr> <tr><td>1.6</td><td>01/96-02/04</td></tr> <tr><td>1.7 SDi</td><td>01/96-02/04</td></tr> <tr><td>1.9 SDi</td><td>01/96-02/04</td></tr> <tr><td>1.9 TDi</td><td>01/96-02/04</td></tr> </table>	1.4	01/96-02/04	1.6	01/96-02/04	1.7 SDi	01/96-02/04	1.9 SDi	01/96-02/04	1.9 TDi	01/96-02/04																				
1.4	01/96-02/04																																								
1.6	01/96-02/04																																								
1.7 SDi	01/96-02/04																																								
1.9 SDi	01/96-02/04																																								
1.9 TDi	01/96-02/04																																								
1.4	01/96-02/04																																								
1.6	01/96-02/04																																								
1.7 SDi	01/96-02/04																																								
1.9 SDi	01/96-02/04																																								
1.9 TDi	01/96-02/04																																								
<p>9006640 Rotule de direction G <i>Left tie rod end</i> OE 1K0423811G</p>  <p>9 M16 x 1.5</p> <table style="width: 100%;"> <tr><td>1.4i 16v.</td><td>03/04-</td></tr> <tr><td>1.9 TDi</td><td>03/04-</td></tr> <tr><td>2.0i 16v.</td><td>04/06-</td></tr> <tr><td>2.0 SDi</td><td>03/04-</td></tr> </table>	1.4i 16v.	03/04-	1.9 TDi	03/04-	2.0i 16v.	04/06-	2.0 SDi	03/04-	<p>9006639 Rotule de direction D <i>Right tie rod end</i> OE 1K0423812G</p>  <p>8 M16 x 1.5</p> <table style="width: 100%;"> <tr><td>1.4i 16v.</td><td>03/04-</td></tr> <tr><td>1.9 TDi</td><td>03/04-</td></tr> <tr><td>2.0i 16v.</td><td>04/06-</td></tr> <tr><td>2.0 SDi</td><td>03/04-</td></tr> </table>	1.4i 16v.	03/04-	1.9 TDi	03/04-	2.0i 16v.	04/06-	2.0 SDi	03/04-																								
1.4i 16v.	03/04-																																								
1.9 TDi	03/04-																																								
2.0i 16v.	04/06-																																								
2.0 SDi	03/04-																																								
1.4i 16v.	03/04-																																								
1.9 TDi	03/04-																																								
2.0i 16v.	04/06-																																								
2.0 SDi	03/04-																																								
<p>9006638 Rotule de direction G <i>Left tie rod end</i> OE 1K0423811K</p>  <p>9 M16 x 1.5</p> <table style="width: 100%;"> <tr><td>1.2 TSi</td><td>07/10-</td></tr> <tr><td>1.4i 16v.</td><td>03/04-07/10</td></tr> <tr><td>1.6i</td><td>03/04-07/10</td></tr> <tr><td>1.6i GPL CHGA</td><td>06/11-</td></tr> <tr><td>1.6 TDi /FAP</td><td>07/10-</td></tr> <tr><td>1.9 TDi /FAP /4WD</td><td>03/04-07/10</td></tr> <tr><td>2.0i GNV</td><td>06/06-</td></tr> <tr><td>2.0 SDi</td><td>03/04-07/10</td></tr> <tr><td>2.0 TDi /4WD CFHC/F</td><td>11/10-</td></tr> </table> <p style="text-align: center;">OE 1K0423811J</p> <table style="width: 100%;"> <tr><td>2.0 TDi FAP BMM</td><td>09/07-07/10</td></tr> </table>	1.2 TSi	07/10-	1.4i 16v.	03/04-07/10	1.6i	03/04-07/10	1.6i GPL CHGA	06/11-	1.6 TDi /FAP	07/10-	1.9 TDi /FAP /4WD	03/04-07/10	2.0i GNV	06/06-	2.0 SDi	03/04-07/10	2.0 TDi /4WD CFHC/F	11/10-	2.0 TDi FAP BMM	09/07-07/10	<p>9006637 Rotule de direction D <i>Right tie rod end</i> OE 1K0423812K</p>  <p>8 M16 x 1.5</p> <table style="width: 100%;"> <tr><td>1.2 TSi</td><td>07/10-</td></tr> <tr><td>1.4i 16v.</td><td>03/04-07/10</td></tr> <tr><td>1.6i</td><td>03/04-07/10</td></tr> <tr><td>1.6i GPL CHGA</td><td>06/11-</td></tr> <tr><td>1.6 TDi /FAP</td><td>07/10-</td></tr> <tr><td>1.9 TDi /FAP /4WD</td><td>03/04-07/10</td></tr> <tr><td>2.0i GNV</td><td>06/06-</td></tr> <tr><td>2.0 SDi</td><td>03/04-07/10</td></tr> <tr><td>2.0 TDi FAP BMM</td><td>09/07-07/10</td></tr> <tr><td>2.0 TDi /4WD CFHC/F</td><td>11/10-</td></tr> </table>	1.2 TSi	07/10-	1.4i 16v.	03/04-07/10	1.6i	03/04-07/10	1.6i GPL CHGA	06/11-	1.6 TDi /FAP	07/10-	1.9 TDi /FAP /4WD	03/04-07/10	2.0i GNV	06/06-	2.0 SDi	03/04-07/10	2.0 TDi FAP BMM	09/07-07/10	2.0 TDi /4WD CFHC/F	11/10-
1.2 TSi	07/10-																																								
1.4i 16v.	03/04-07/10																																								
1.6i	03/04-07/10																																								
1.6i GPL CHGA	06/11-																																								
1.6 TDi /FAP	07/10-																																								
1.9 TDi /FAP /4WD	03/04-07/10																																								
2.0i GNV	06/06-																																								
2.0 SDi	03/04-07/10																																								
2.0 TDi /4WD CFHC/F	11/10-																																								
2.0 TDi FAP BMM	09/07-07/10																																								
1.2 TSi	07/10-																																								
1.4i 16v.	03/04-07/10																																								
1.6i	03/04-07/10																																								
1.6i GPL CHGA	06/11-																																								
1.6 TDi /FAP	07/10-																																								
1.9 TDi /FAP /4WD	03/04-07/10																																								
2.0i GNV	06/06-																																								
2.0 SDi	03/04-07/10																																								
2.0 TDi FAP BMM	09/07-07/10																																								
2.0 TDi /4WD CFHC/F	11/10-																																								
 <p>Barre stabilisatrice <i>Stabilizer bar</i> <i>Barra estabilizadora</i> <i>Drażek stabilizatora</i> стабилизатор поперечной устойчивости</p>																																									
<p>2306010 Biellette barre stab. <i>Stabilizer bar stub axle</i> OE 1K0411315P</p>  <p>2</p> <table style="width: 100%;"> <tr><td>1.2 TSi</td><td>07/10-</td></tr> <tr><td>1.4 16v.</td><td>03/04-</td></tr> <tr><td>1.6i</td><td>03/04-</td></tr> <tr><td>1.6 TDi</td><td>07/10-</td></tr> <tr><td>1.9 TDi /4WD</td><td>03/04-</td></tr> <tr><td>2.0i</td><td>04/06-</td></tr> <tr><td>2.0 SDi</td><td>03/04-</td></tr> <tr><td>2.0 TDi /4WD</td><td>09/07-</td></tr> </table>	1.2 TSi	07/10-	1.4 16v.	03/04-	1.6i	03/04-	1.6 TDi	07/10-	1.9 TDi /4WD	03/04-	2.0i	04/06-	2.0 SDi	03/04-	2.0 TDi /4WD	09/07-	<p>9001522 Palier de barre milieu <i>Middle bar main bearing</i> OE 191411314</p>  <p>1 Barre Ø 17 -ch 9K-V-525700</p> <table style="width: 100%;"> <tr><td>1.4</td><td>01/96-01/04</td></tr> <tr><td>1.6</td><td>01/96-01/04</td></tr> <tr><td>1.7 SDi</td><td>01/96-01/04</td></tr> <tr><td>1.9 TDi</td><td>01/96-01/04</td></tr> </table>	1.4	01/96-01/04	1.6	01/96-01/04	1.7 SDi	01/96-01/04	1.9 TDi	01/96-01/04																
1.2 TSi	07/10-																																								
1.4 16v.	03/04-																																								
1.6i	03/04-																																								
1.6 TDi	07/10-																																								
1.9 TDi /4WD	03/04-																																								
2.0i	04/06-																																								
2.0 SDi	03/04-																																								
2.0 TDi /4WD	09/07-																																								
1.4	01/96-01/04																																								
1.6	01/96-01/04																																								
1.7 SDi	01/96-01/04																																								
1.9 TDi	01/96-01/04																																								
<p>9001760 Palier de barre milieu <i>Middle bar main bearing</i> OE 1H0411314</p>  <p>1 Barre Ø 20 Ch- 9K-V-525701</p> <table style="width: 100%;"> <tr><td>1.4</td><td>01/96-01/04</td></tr> <tr><td>1.6</td><td>01/96-01/04</td></tr> <tr><td>1.7 SDi</td><td>01/96-01/04</td></tr> <tr><td>1.9 TDi</td><td>01/96-01/04</td></tr> </table>	1.4	01/96-01/04	1.6	01/96-01/04	1.7 SDi	01/96-01/04	1.9 TDi	01/96-01/04																																	
1.4	01/96-01/04																																								
1.6	01/96-01/04																																								
1.7 SDi	01/96-01/04																																								
1.9 TDi	01/96-01/04																																								

... Caddy ...



Eléments SUSPENSION
Suspension parts
Elementos suspensión
Elementy zawieszenie
Элементы подвески

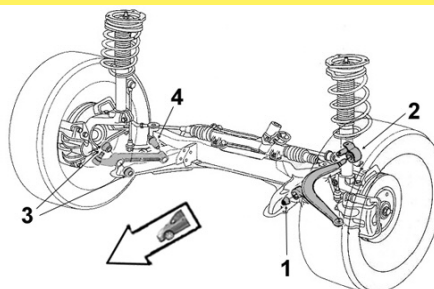

VOLKSWAGEN SASIC

9001759

Articulation AV

OE 1K0407182

Front bush



1 Ø int.12 Ø ext.40 coll.48
 long. tube int.54 ext.33 ep. coll.6
 1.2 TSi 07/10-
 1.4i 16v. 03/04-07/10
 1.6i 03/04-07/10
 1.6i / GPL 06/11-
 1.6 TDi 07/10-
 1.9 TDi /FAP /4WD 03/04-07/10
 2.0i GNV 06/06-
 2.0 SDi 03/04-07/10
 2.0 TDi /4WD /FAP 10/07-

9001523

Articulation AV

OE 357407182

Front bush



1 Ø int.12 Ø ext.33 coll.36
 long. tube int.54 ext.29 ep. coll.5
 1.4 01/96-01/04
 1.6 01/96-01/04
 1.7 SDi 01/96-01/04
 1.9 TDi 01/96-01/04

9001520

Articulation AR

OE 191407181E

Rear bush



2 Ø int.17 Ø ext.60.5
 long. tube int.41 ext.24.5
 1.6 01/96-01/04
 1.7 SDi 01/96-01/04
 1.9 TDi 01/96-01/04

2256003

Articulation AR G

OE 1K0199231J

Left rear bush



2
 1.4i 16v. 03/04-07/10
 1.6i 03/04-07/10
 1.9 TDI /FAP /4WD 03/04-07/10
 2.0i GNV 06/06-07/10
 2.0 SDi 03/04-07/10
 2.0 TDi 09/07-07/10

2256002

Articulation AR D

OE 1K0199232J

Right rear bush



2
 1.4i 16v. 03/04-07/10
 1.6i 03/04-07/10
 1.9 TDI /FAP /4WD 03/04-07/10
 2.0i GNV 06/06-07/10
 2.0 SDi 03/04-07/10
 2.0 TDi 09/07-07/10

Bras & Triangle de suspension

G/L D/R

Control arm
Brazo y triángulo
Wahacz
Рычаг подвески

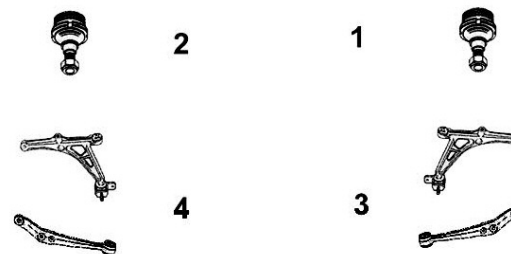

9005133

Triangle de susp. G/D











OE 191407151B

L/R track control arm



3
4 Sans rotule Without tie rod end
 1.4 01/96-01/04
 1.6 01/96-09/00
 1.7 SDi 01/96-09/00
 1.9 SDi 01/96-03/04
 1.9 TDi 01/96-03/04

... Caddy ...

7476107 Triangle de susp. G		7476108 Triangle de susp. D	
OE 191407151B+357407365 <i>Left track control arm</i>		OE 191407151B+357407365 <i>Right track control arm</i>	
NEW 	4 Avec rotule <i>With ball joint</i> Ø 19	NEW 	3 Avec rotule <i>With ball joint</i> Ø 19
	1.4 01/96-01/04 1.6 01/96-09/00 1.7 SDi 01/96-09/00 1.9 SDi 09/96-12/00 1.9 TDi 01/96-03/04		1.4 01/96-01/04 1.6 01/96-09/00 1.7 SDi 01/96-09/00 1.9 SDi 09/96-12/00 1.9 TDi 01/96-03/04
9005757 Triangle de susp. G		9005756 Triangle de susp. D	
OE 1K0407151AH <i>Left track control arm</i>		OE 1K0407152AH <i>Right track control arm</i>	
	4 acier steel Sans rotule <i>Without tie rod end</i>		3 acier steel Sans rotule <i>Without tie rod end</i>
	1.4i 16v. Ch- 2K4016001 -06/06 1.6i Ch- 2K4016001 BGU BSE 03/04-07/10 1.9 TDi Ch- 2K4016001 2.0i Ch- 2K4016001 2.0 SDi Ch- 2K4016001 2.0 TDi Ch- 2K4016001 BMM 09/07-07/10		1.4i 16v. Ch- 2K4016001 -06/06 1.6i Ch- 2K4016001 BGU BSE 03/04-07/10 1.9 TDi Ch- 2K4016001 2.0i Ch- 2K4016001 2.0 SDi Ch- 2K4016001 2.0 TDi Ch- 2K4016001 BMM 09/07-07/10
7476018 Triangle de susp. G		7476017 Triangle de susp. D	
OE 1K0407151AC <i>Left track control arm</i>		OE 1K0407152AC <i>Right track control arm</i>	
	4 Fonte Iron Sans rotule <i>Without tie rod end</i> -ch 2k-4-016000		3 Fonte Iron Sans rotule <i>Without tie rod end</i> -ch 2k-4-016000
	1.4i 16v. /Tramper 03/04- 1.6i /Tramper 03/04- 1.9 TDi /DSG /4WD /FAP /Tramper 03/04- 2.0i /GNV /Tramper 06/06- 2.0 SDi 03/04- 2.0 TDi /DPF /Tramper 10/07-		1.4i 16v. /Tramper 03/04- 1.6i /Tramper 03/04- 1.9 TDi /DSG /4WD /FAP /Tramper 03/04- 2.0i /GNV /Tramper 06/06- 2.0 SDi 03/04- 2.0 TDi /DPF /Tramper 10/07-
7476128 Triangle de susp. G		7476127 Triangle de susp. D	
OE 1K0407151AC+1K0407365C <i>Left track control arm</i>		OE 1K0407152M+1K0407366C <i>Right track control arm</i>	
NEW 	4 Avec rotule <i>With ball joint</i> -ch 2k-4-016000	NEW 	3 Avec rotule <i>With ball joint</i> -ch 2k-4-016000
	1.4i 16v. /Tramper 03/04- 1.6i /Tramper 03/04- 1.9 TDi /DSG /4WD /FAP /Tramper 03/04- 2.0i /GNV /Tramper 06/06- 2.0 SDi 03/04- 2.0 TDi /DPF /Tramper 10/07-		1.4i 16v. /Tramper 03/04- 1.6i /Tramper 03/04- 1.9 TDi /DSG /4WD /FAP /Tramper 03/04- 2.0i /GNV /Tramper 06/06- 2.0 SDi 03/04- 2.0 TDi /DPF /Tramper 10/07-
9005260 Rotule de susp. inf. G/D		9005260 Rotule de susp. inf. G/D	
OE 357407365 <i>L/R lower suspension ball joint</i>		OE 357407365 <i>L/R lower suspension ball joint</i>	
	1 2 Ø 19 Cylindrique		
	1.4 01/96-01/04 1.4i 16v. 01/01-03/04 1.6 01/96-09/00 1.7 SDi 01/96-09/00 1.9 SDi 09/96-12/00 1.9 TDi 01/96-03/04		1.4 01/96-01/04 1.4i 16v. 01/01-03/04 1.6 01/96-09/00 1.7 SDi 01/96-09/00 1.9 SDi 09/96-12/00 1.9 TDi 01/96-03/04
9005570 Rotule de susp. inf. G		9005569 Rotule de susp. inf. D	
OE 1K0407365C <i>Left lower suspension ball joint</i>		OE 1K0407366C <i>Right lower suspension ball joint</i>	
	2		1
	1.2 TSi 07/10- 1.4i 16v. /Tramper 03/04- 1.6i /Tramper /GNV 03/04- 1.6 TDi 07/10- 1.9 TDi /DSG /4WD /FAP /Tramper 03/04- 2.0i /GNV /Tramper 06/06- 2.0 SDi 03/04- 2.0 TDi /DPF /Tramper /4WD 10/07-		1.2 TSi 07/10- 1.4i 16v. /Tramper 03/04- 1.6i /Tramper /GNV 03/04- 1.6 TDi 07/10- 1.9 TDi /DSG /4WD /FAP /Tramper 03/04- 2.0i /GNV /Tramper 06/06- 2.0 SDi 03/04- 2.0 TDi /DPF /Tramper /4WD 10/07-

... Caddy





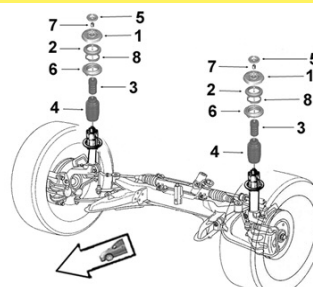

SASIC

VOLKSWAGEN



Support d'amortisseur
Suspension mounting
Soporte amortiguador
Poduszka amortyzatora
Опора амортизатора



9005622 OE 1K0412331B	Support suspension G/D <i>L/R suspension mounting</i>	9005352 OE 1J0412249	Butée à billes G/D <i>L/R ball bearing</i>
	1 1.4i 16v. 03/04-07/10 1.6i 03/04-07/10 1.9 TDi 03/04- 2.0 06/06- 2.0 SDi 03/04- 2.0 TDi FAP BMM 09/07-07/10		2 1.4 01/96- 1.6 01/96- 1.7 SDi 01/96- 1.9 TDi 01/96-
9005337 OE 1K0412303P	Butée de suspension <i>Shock bush</i>	2656002 OE 1H0412303	Butée de suspension <i>Shock bush</i>
	3 H85 1.2 TSi 07/10- 1.6i GPL 07/10- 1.6 TDi 07/10- 2.0i GNV 07/10- 2.0 TDi /4WD /FAP 07/10-		3 H103 1.4i 09/96-12/00 1.4i 16v. 01/01-03/04 1.6i 09/96-12/00 1.7 SDi 09/96-09/00 1.9 SDi 09/96-12/00 1.9 TDi 09/96-12/00
9005339 OE 1K0412303S	Butée de suspension <i>Shock bush</i>		
	3 H90 1.4i 16v. 03/04- 1.9 TDi /DSG /4WD /FAP /Tramper 03/04- 2.0i /GNV /Tramper 06/06- 2.0 SDi 03/04- 2.0 TDi FAP 09/07-07/10		
2656053 OE 6N0413175A	Protecteur amortisseur G/D <i>L/R shock absorber protector</i>		
	4 H206 1.2 TSi 07/10- 1.4i 16v. 03/04-07/10 1.6i 03/04-07/10 1.6i GPL VL 06/11- 1.6 TDi VL 07/10- 1.9 TDi 03/04-07/10 2.0i GPL 06/06-07/10 2.0i GPL VL 07/10- 2.0 SDi 03/04-07/10 2.0 TDi 09/07-07/10 2.0 TDi /4WD VL 11/10-		
9005369 OE 1H0413175	Protecteur amortisseur G/D <i>L/R shock absorber protector</i>		
	4 1.4 01/96- 1.6 01/96- 1.7 SDi 01/96- 1.9 SDi 01/96- 1.9 TDi 01/96-		

Crafter ...

Eléments DIRECTION

Steering parts

Elementos Direcciones

Elementy układu kierowniczy

Элементы рулевой системы

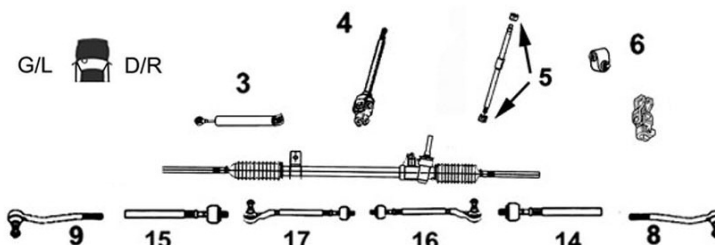

7776017

Axe de bielle G/D

Part/oe 2E0713491

L/R axial joint

14 Côté dir. M18x1.5 Côté rot. M16x1.5
15 long 400 mm

2.0 TDi

2.5 TDi

06/11-

06/06-



7676010

Rotule de direction G/D

OE 2E0713501

L/R tie rod end

8 M16 x 1.5
9

2.5 TDi

06/06-



Barre stabilisatrice

Stabilizer bar

Barra estabilizadora

Drażek stabilizatora

стабилизатор поперечной устойчивости

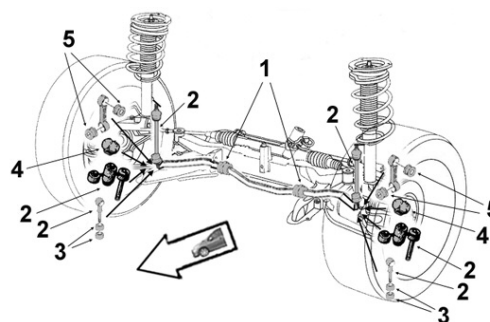

2306005

Biellette barre stab. G

OE 2E0411317C

Left stabilizer bar stub axle

2

2.0 TDi FAP

2.5 TDi /FAP 30.35 30.50

06/11-

04/06-



2306004

Biellette barre stab. D

OE 2E0411318C

Right stabilizer bar stub axle

2

2.0 TDi FAP

2.5 TDi /FAP 30.35 30.50

06/11-

04/06-



Eléments SUSPENSION

Suspension parts

Elementos suspensión

Elementy zawieszenie

Элементы подвески

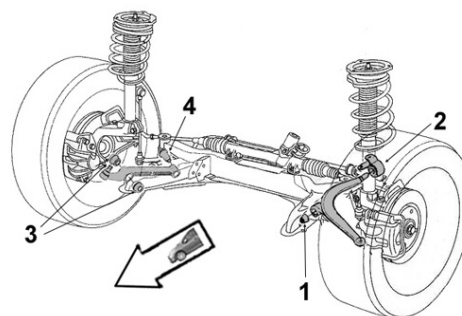

2256055

Articulation AV

OE 2E0407523

Front bush

1 Ø int.14 Ø ext. 52 coll. 59 x2
long. tube int.75 ext.48 ep. coll.5x2

2.0 TDi

2.5 TDi

06/06-

06/06-



2256057

Articulation AR

OE 2E0407523A

Rear bush

2 Ø int.14 Ø ext. 52 coll. 59 x2
long. tube int.75 ext.48 ep. coll.5x2

2.0 TDi

2.5 TDi

06/06-

06/06-



... Crafter

Bras & Triangle de suspension

Control arm
Brazo y triángulo
Wahacz
Рычаг подвески

G/L  D/R



7476111

Triangle de susp. G

OE 2E0407151M

Left track control arm

NEW

4 Avec rotule With ball joint



2.0 TDi
2.5 TDi

06/06-
06/06-

7476112

Triangle de susp. D

OE 2E0407152M

Right track control arm

NEW

3 Avec rotule With ball joint



2.0 TDi
2.5 TDi

06/06-
06/06-



Barre stabilisatrice

Stabilizer bar
Barra estabilizadora
Drażek stabilizatora
стабилизатор поперечной устойчивости

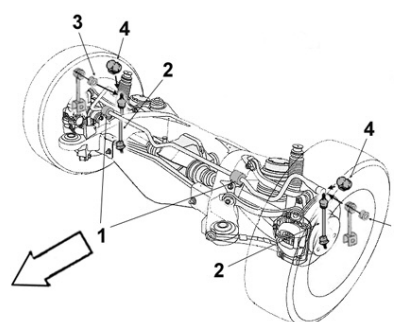

2306100

Art. barre stab. bout

OE 2D0511413

End Stabilizer bar bush

3 Ø int.12 Ø ext.26.6 coll.30.5
long. tube int. 26 ext. 12.8 ep. coll. 4X2



2.0 TDi FAP
2.5 TDi /FAP 30.35

06/11-
04/06-

2306101

Palier de barre milieu

OE 2D0511413B

Middle bar main bearing

1 Ø 27



2.5 TDi

04/06-

LT I 75-96

Bras & Triangle de suspension

Control arm
Brazo y triángulo
Wahacz
Рычаг подвески

G/L  D/R

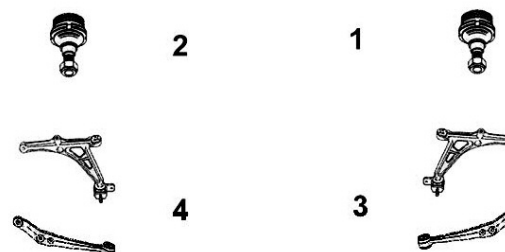

9005472

Rotule de susp. sup. G/D

OE 281407361

L/R upper susp. ball joint

1
2



TT /all models LT 28-31 04/75-
TT /all models LT 35 05/75-08/78
TT /all models LT 40-45 08/78-07/96

9005473

Rotule de susp. inf. G/D

OE 281407187B

L/R lower suspension ball joint

1
2



TT /all models LT 28-31 04/75-
TT /all models LT 35 05/75-08/78
TT /all models LT 40-45 08/78-07/96

LT II III 96- ...

Eléments DIRECTION
Steering parts
Elementos Direcciones
Elementy uklad kierowniczy
Элементы рулевой системы

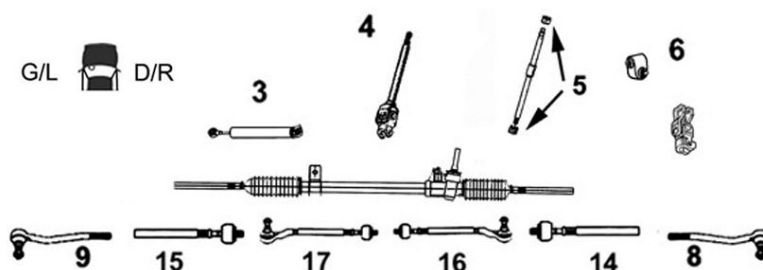

9006848

Axe de bielle G/D

Part/oe 2D0422803

L/R axial joint



14 Côté dir. M16x1.5 Côté rot. M16x1.5
15 long 380 mm

2.3i	09/96-12/99
2.5 SDi	09/96-06/01
2.5 TDi	09/96-06/06
2.8 TDi	08/97-06/06

9006545

Rotule de direction G/D

OE 2D0422811

L/R tie rod end



8
9 M16 x 1.5

2.3i	09/96-12/99
2.5 SDi	09/96-06/01
2.5 TDi	09/96-06/06
2.8 TDi	08/97-06/06



Barre stabilisatrice

Stabilizer bar
Barra estabilizadora
Drażek stabilizatora
стабилизатор поперечной устойчивости

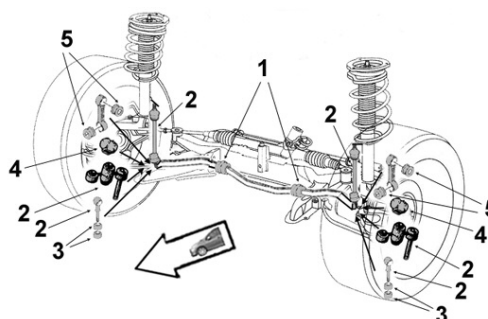

2306144

Biellette barre stab.

OE 2D0411052

Stabilizer bar stub axle

NEW



2

2.3i	09/96-07/06
2.5 SDi	05/96-07/06
2.5 TDi	09/96-06/06
2.8 TDi	05/96-07/06

2306075

Palier de barre milieu

OE 2D0411041B

Middle bar main bearing



1 Ø 25

2.3	09/96-12/99
2.5 SDi	09/96-06/01
2.5 TDi	09/96-06/06
2.8 TDi	08/97-06/06

2306102

Palier biellette barre stab.

OE 2D0411041A

Stabilizer bar stub axle Main bearing



5

2.3i	05/96-07/06
2.5 SDi	05/96-07/06
2.5 TDi	05/96-07/06
2.8 TDi	05/96-07/06

... LT II III 96- ...

Bras & Triangle de suspension

Control arm
Brazo y triángulo
Wahacz
Рычаг подвески

G/L  D/R

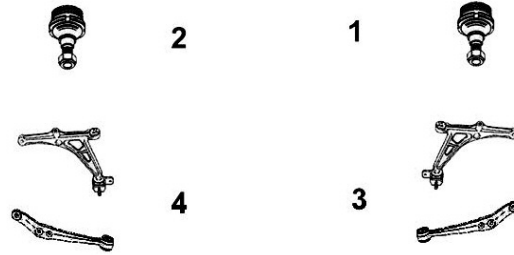

7476151

OE 2D0407021

Triangle de susp. G

Left track control arm

NEW

4 Avec rotule With ball joint



2.3i Combi	09/96-12/99
2.5 SDi Fourgon Combi	09/96-06/01
2.5 TDi Fourgon Combi	09/96-12/05
2.8 TDi Fourgon	08/97-06/06

7476150

OE 2D0407022B

Triangle de susp. D

Right track control arm

NEW

3 Avec rotule With ball joint



2.3i Combi	09/96-12/99
2.5 SDi Fourgon Combi	09/96-06/01
2.5 TDi Fourgon Combi	09/96-12/05
2.8 TDi Fourgon	08/97-06/06

9005538

OE 2D0407361B

Rotule de susp. inf. G/D

L/R lower suspension ball joint



1
2

2.3i	09/96-12/99
2.5 SDi	09/96-06/01
2.5 TDi	09/96-06/06
2.8 TDi	08/97-06/06



Support d'amortisseur

Suspension mounting
Soporte amortiguador
Poduszka amortyzatora
Опора амортизатора

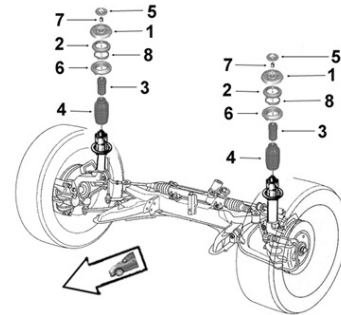

2656007

OE 2D0407183

Support suspension G/D Sup.

L/R upper suspension mounting

1



2.3i		05/96-07/06
2.5 SDi	BVM	07/97-06/01
2.5 TDi	BVM	09/96-12/05
2.8 TDi	BVM	08/97-12/05

2656005

OE 2D0407183A

Support suspension G/D inf.

L/R lower suspension mounting

1



2.3i		05/96-07/06
2.5 SDi	BVM	07/97-06/01
2.5 TDi	BVM	09/96-12/05
2.8 TDi	BVM	08/97-12/05

... LT II III 96-



Barre stabilisatrice
 Stabilizer bar
 Barra estabilizadora
 Drażek stabilizatora
 стабилизатор поперечной устойчивости

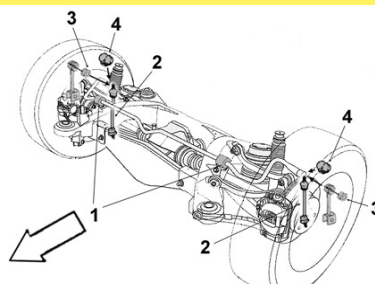

VOLKSWAGEN



2306100

OE 2D0511413

Art. barre stab. bout

End Stabilizer bar bush



3 Ø int.12 Ø ext.26.6 coll.30.5
 long.tube int. 26 ext. 12.8 ep. coll. 4X2

2.3i	05/96-07/06
2.5 SDi	05/96-07/06
2.5 TDi	05/96-07/06
2.8 TDi	05/96-07/06

2306101

OE 2D0511413B

Palier de barre milieu

Middle bar main bearing



1 Ø 27

2.3i	05/96-07/06
2.5 SDi	05/96-07/06
2.5 TDi	05/96-07/06
2.8 TDi	05/96-07/06

Transporter TYP3 (F24) 80-92

Éléments DIRECTION

Steering parts
Elementos Direcciones
Elementy układ kierowniczy
Элементы рулевой системы

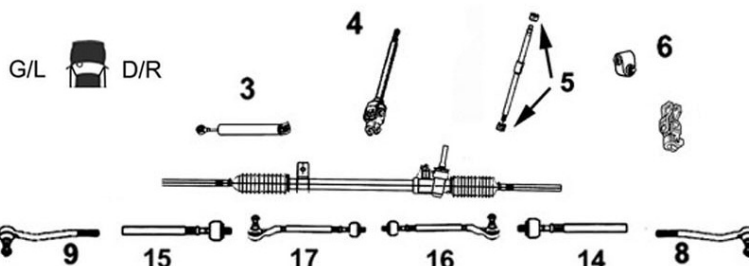

9006383

OE 3A0422811A

Rotule de direction G/D

L/R tie rod end



8
9 M14 x 1.5

TT /all models

Bras & Triangle de suspension

Control arm
Brazo y triángulo
Wahacz
Рычаг подвески

G/L D/R

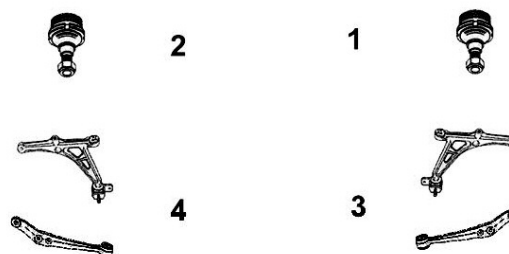

9005263

OE 251407187C

Rotule de susp. inf. G/D

L/R lower suspension ball joint



1
2

TT /all models

9005264

OE 251407361

Rotule de susp. sup. G/D

L/R upper susp. ball joint



1
2

TT /all models

Transporter TYP4 (F70/D) 91-03 ...

Eléments DIRECTION

Steering parts

Elementos Direcciones

Elementy układ kierowniczy

Элементы рулевой системы

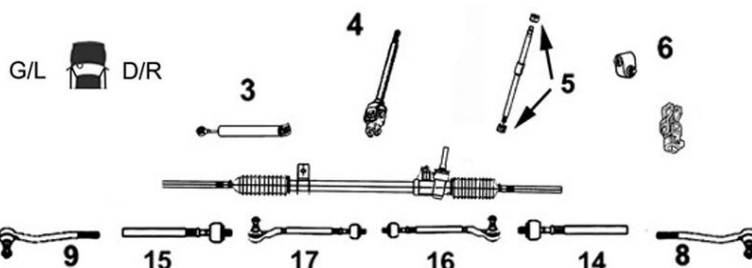

VOLKSWAGEN SASIC

9006867

Axe de bielle

OE 701419810

L/R axial joint



14
15

Côté dir. M14x1.5 Côté rot. M16x1.5 long 298 mm

TT /all models DNA Côté pignon

-03/96

9006868

Axe de bielle

OE 701419810A

L/R axial joint



14
15

Côté dir. M14x1.5 Côté rot. M16x1.5 long 298 mm

TT /all models DNA Côté opposé au pignon

-03/96

TT /all models DA

-03/96

9006623

Rotule de direction G Ext.

OE 701419811A

Left outer tie rod end



9

M16 x 1.5

TT /all models -ch 70-M-096448

9006621

Rotule de direction D Ext.

OE 701419812

Right outer tie rod end



8

M16 x 1.5

TT /all models -ch 70-M-096448

9006624

Rotule de direction G Ext.

OE 701419811B

Left outer tie rod end

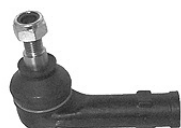

9

M16 x 1.5

TT /all models
Ch- 70-M-096449 -ch 70S002791 -12/95

9006622

Rotule de direction D Ext.

OE 701419812A

Right outer tie rod end

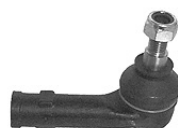

8

M16 x 1.5

TT /all models
Ch- 70-M-096449 -ch 70S002791 -12/95

9006630

Rotule de direction G

OE 701419811C

Left tie rod end



9

M16 x 1.5

TT /all models -ch 70-T-199999

9006633

Rotule de direction D

OE 701419812D

Right tie rod end



8

M16 x 1.5

TT /all models Ch- 70-T-200000

... Transporter TYP4 (F70/D) 91-03



Barre stabilisatrice
 Stabilizer bar
 Barra estabilizadora
 Drążek stabilizatora
 стабилизатор поперечной устойчивости

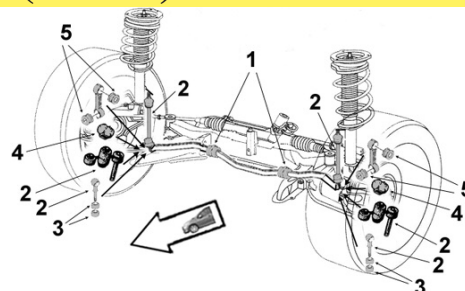

VOLKSWAGEN



2306002 **Biellette barre stab.**
 OE 7D0411049 *Stabilizer bar stub axle*



2 Barre Ø 23.5

1.8		01/91-12/96
1.9 D		01/91-12/96
1.9 TD		01/91-
2.0		01/91-
2.4 D		01/91-12/96
2.5i	-ch 70-S-002791	01/91-12/96
2.5 TDi		01/91-

Bras & Triangle de suspension

Control arm
 Brazo y triángulo
 Wahacz
 Рычаг подвески

G/L  D/R

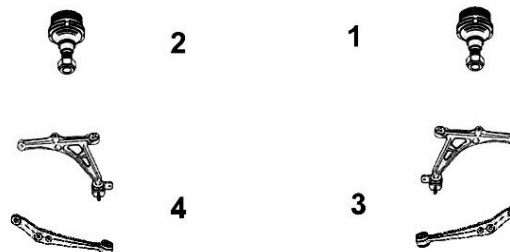

9005476 **Rotule de susp. sup. G/D**
 OE 701407187B *L/R upper susp. ball joint*



1
2

TT /all models

9005474 **Rotule de susp. inf. G/D**
 OE 701407361B *L/R lower suspension ball joint*



1
2

TT /all models -ch 70T199999

9005477 **Rotule de susp. inf. G/D**
 OE 7D0407361 *L/R lower suspension ball joint*



1
2

TT /all models Ch- 70T200000

Transporter TYP5 (F7J/H) 03- ...

Eléments DIRECTION

Steering parts

Elementos Direcciones

Elementy układ kierowniczy

Элементы рулевой системы

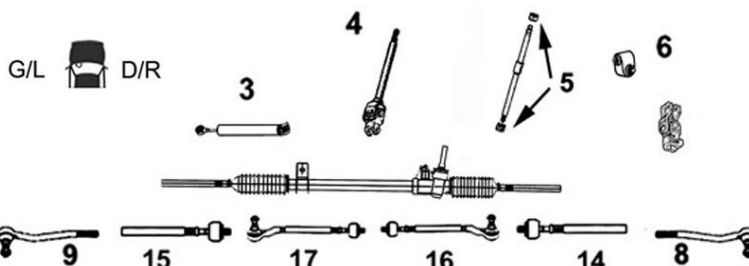

7776071

Axe de bielle G/D

Part/oe 7H0419804F L/R axial joint

NEW



14 Côté dir. M16x1.5 Côté rot. M16x1.5 long 177 mm

15

1.9 TDi	06/03-
2.0i	06/03-
2.0i Turbo /4WD	11/09-
2.0 TSi /4WD	11/09-
2.0 TDi /4WD /FAP	11/09-
2.5 TDi /FAP /4WD	06/03-
3.2i V6 24v. /4WD	06/03-

9006632

Rotule de direction G

OE 701419811E

Left tie rod end



9 M16 x 1.5

TT /all models Ch- 70-T-200000

9006631

Rotule de direction D

OE 701419812B

Right tie rod end



8 M16 x 1.5

TT /all models -ch 70-T-199999

7676020

Rotule de direction G

OE 7H0422817D

Left tie rod end



9 M16 x 1.5

1.9 TDi	06/03-
2.0i	06/03-
2.0i Turbo /4WD	11/09-
2.0 TSi /4WD	11/09-
2.0 TDi /4WD /FAP	11/09-
2.5 TDi /FAP /4WD	06/03-
3.2i V6 24v. /4WD	06/03-

7676019

Rotule de direction D

OE 7H0422818D

Right tie rod end



8 M16 x 1.5

1.9 TDi	06/03-
2.0i	06/03-
2.0i Turbo /4WD	11/09-
2.0 TSi /4WD	11/09-
2.0 TDi /4WD /FAP	11/09-
2.5 TDi /FAP /4WD	06/03-
3.2i V6 24v. /4WD	06/03-



Barre stabilisatrice

Stabilizer bar

Barra estabilizadora

Drażek stabilizatora

стабилизатор поперечной устойчивости

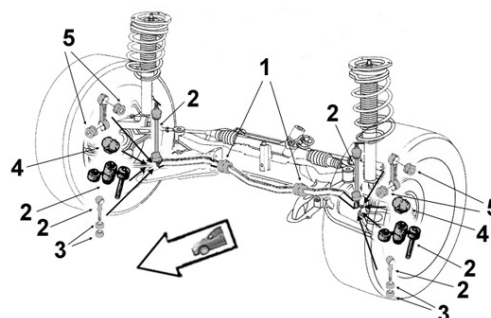

2306003

Biellette barre stab.

OE 7H5411317A

Stabilizer bar stub axle



2 -ch 7H-7-200000

1.9 TDi	BVM5	06/03-08/09
2.0i	BVM5	06/03-08/09
2.5 TDi/ 4WD	BVM6 BVA6	06/03-08/09
3.2i/ 4WD	BVA6	06/03-08/09

... Transporter TYP5 (F7J/H) 03- ...

Bras & Triangle de suspension

Control arm
Brazo y triángulo
Wahacz
Рычаг подвески

G/L  D/R



7476190

Triangle de susp. G

OE 7H0407151F

Left track control arm

NEW

4 Sans rotule Without tie rod end



1.9 TDi	-kg 3200	01/03-12/11
2.0i /Turbo	-kg 3200	01/03-12/11
2.0 TSi	-kg 3200	01/03-12/11
2.0 TDi	3200kg	01/03-12/11
2.5 TDi	-kg 3200	01/03-12/11
3.2i	-kg 3200	01/03-12/11

7476191

Triangle de susp. D

OE 7H0407152F

Right track control arm

NEW

3 Sans rotule Without tie rod end



1.9 TDi	-kg 3200	01/03-12/11
2.0i /Turbo	-kg 3200	01/03-12/11
2.0 TSi	-kg 3200	01/03-12/11
2.0 TDi	3200kg	01/03-12/11
2.5 TDi	-kg 3200	01/03-12/11
3.2i	-kg 3200	01/03-12/11

7576024

Rotule de susp. inf. G/D

OE 7H0407361A

L/R lower suspension ball joint

NEW

1
2



1.9 TDi	-kg 3200	01/03-
2.0i /Turbo	-kg 3200	01/03-
2.0 TSi	-kg 3200	01/03-
2.0 TDi	3200kg	01/03-
2.5 TDi	-kg 3200	01/03-
3.2i	-kg 3200	01/03-

7576025

Rotule de susp. inf. G/D

OE 7H8407361A

L/R lower suspension ball joint

NEW

1
2



1.9 TDi	Kg- 3200	01/03-
2.0i /Turbo	Kg- 3200	01/03-
2.0 TSi	Kg- 3200	01/03-
2.0 TDi	3200kg	01/03-
2.5 TDi	Kg- 3200	01/03-
3.2i	Kg- 3200	01/03-



Support d'amortisseur

Suspension mounting
Soporte amortiguador
Poduszka amortyzatora
Опора амортизатора

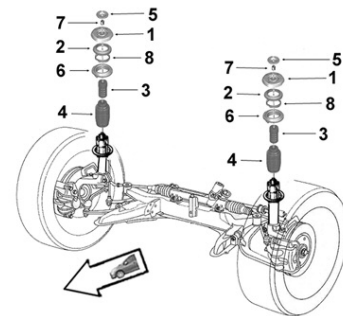

2656060

Support suspension

OE 7E0412331

Suspension mounting

1



1.9 TDi	04/03-11/09
2.0i	11/03-
2.0 TSi	
2.0 TDi /BiTDi /4WD	09/09-
2.5 TDi /4WD	04/03-11/09
3.2 /4WD	02/04-11/09

... Transporter TYP5 (F7J/H) 03-



Barre stabilisatrice
 Stabilizer bar
 Barra estabilizadora
 Дрәжек стабилизатора
 стабилизатор поперечной устойчивости

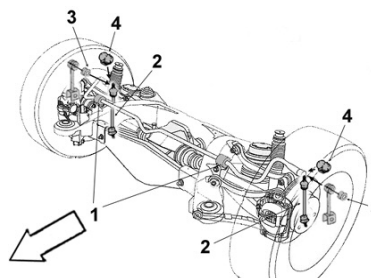

2306114 **Palier de barre bout**
 OE 7H5511414 *End bar main bearing*



4 Barre Ø 24

1.9 TDi	01/05-
2.0i /Turbo	01/05-
2.0 TSi	01/05-
2.0 TDi	01/05-
2.5 TDi	01/05-
3.2i	01/05-

Eléments TRAIN ARRIERE

Rear axle parts
Tren TRAS
Elementy zawieszenia tylnego
элементы задней оси.



2256058 **Articulation Int.**
 OE 7H0501132A *Inner bush*



Ø int.14 Ø ext. 60 coll. 69.5 coll. 71 long. tube int.75 ext.48 ep. coll.6.5 coll 5

Sauf 3200kg

1.9 TDi	04/03-11/09
2.0i	11/03-
2.0 TSi /4WD	05/11-
2.0 TDi BiTDi /4WD	09/09-
2.5 TDi /4WD	04/03-11/09
3.2 /4WD	02/04-11/09

340/360

Eléments DIRECTION

Steering parts

Elementos Direcciones

Elementy układ kierowniczy

Элементы рулевой системы

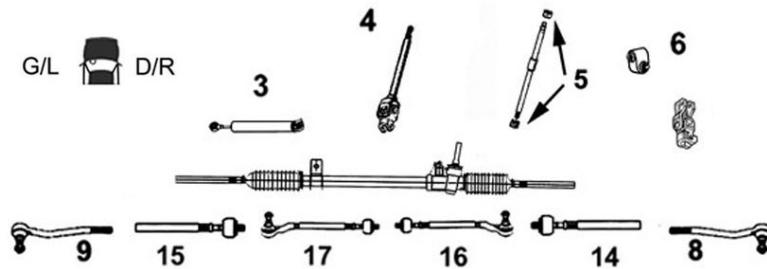

9006281

Axe de bielle G/D

OE 3268829

L/R axial joint



14 Côté dir. M14x1.5 Côté rot. M14x1.5
15 long 290 mm

TT /all models

02/76-

9006608

Rotule de direction G/D

OE 3211955

L/R tie rod end



8 M14 x 1.5
9

TT /all models

02/76-

440/460

Eléments DIRECTION

Steering parts

Elementos Direcciones

Elementy układ kierowniczy

Элементы рулевой системы

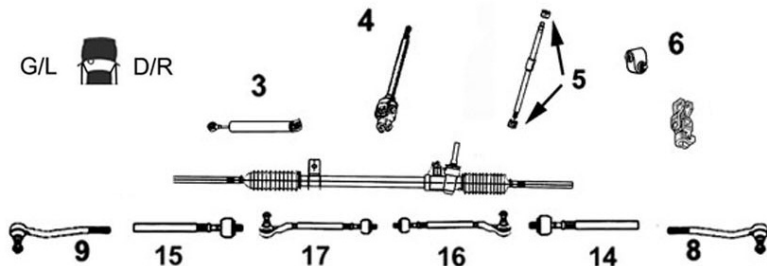

9006283

Axe de bielle G/D

OE 3410369

L/R axial joint



14 Côté dir. M14x1.5 Côté rot. M12x1.25
15 long 320 mm

TT /all models Camgear 08/88-

9006878

Axe de bielle G/D

Part/oe 3410412

L/R axial joint



14 Côté dir. M14x1.5 Côté rot. M12x1.25
15 long 300 mm

TT /all models DA ZF 08/88-

9006609

Rotule de direction G/D

OE 3480012

L/R tie rod end



8 M12 x 1.25
9

TT /all models

08/88-

9004017

Axe de volant

OE 3468941

Steering wheel shaft



4

TT /all models

08/88-

480

Eléments DIRECTION

Steering parts

Elementos Direcciones

Elementy układ kierowniczy

Элементы рулевой системы

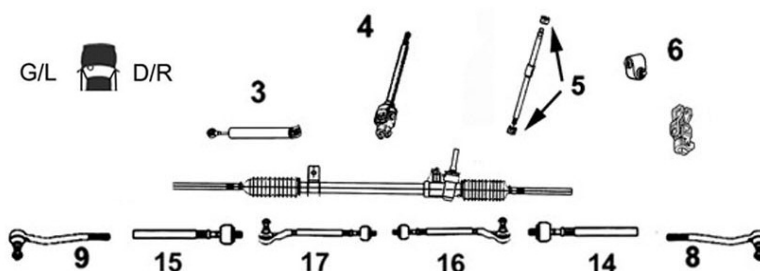

9006283

Axe de bielle G/D

OE 3410369

L/R axial joint



14 Côté dir. M14x1.5 Côté rot. M12x1.25
15 long 320 mm

TT /all models Camgear 04/86-

9006878

Axe de bielle G/D

Part/oe 3410412

L/R axial joint



14 Côté dir. M14x1.5 Côté rot. M12x1.25
15 long 300 mm

TT /all models DA ZF 04/86-

9006609

Rotule de direction G/D

OE 3480012

L/R tie rod end



8
9 M12 x 1.25

TT /all models 04/86-

9004017

Axe de volant

OE 3468941

Steering wheel shaft



4

TT /all models 04/86-

740 ...

Eléments DIRECTION

Steering parts

Elementos Direcciones

Elementy układ kierowniczy

Элементы рулевой системы

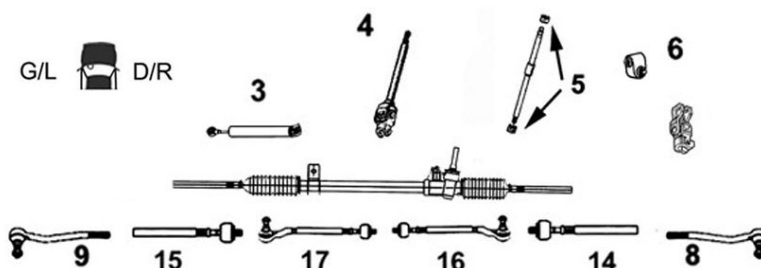

9006282

Axe de bielle G/D

OE 1359347

L/R axial joint



14 Côté dir. M18x1.5 Côté rot. M14x2.0
15 long 294 mm

TT /all models 01/84-12/88

9006285

Axe de bielle G/D

OE 9140504

L/R axial joint



14 Côté dir. M14x1.5 Côté rot. M14x2.0
15 long 275 mm

TT /all models 01/89-

9006610

Rotule de direction G/D

OE 3516944

L/R tie rod end

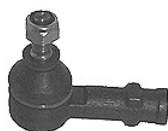

8
9 M14 x 2

TT /all models

01/84-

... 740

Bras & Triangle de suspension

Control arm
Brazo y triángulo
Wahacz
Рычаг подвески

G/L  D/R

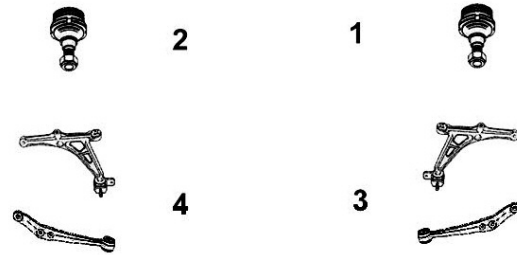

9005419
OE 270477

Rotule de susp. inf. G/D
L/R lower suspension ball joint



1
2

TT /all models

01/84-

760 ...

Eléments DIRECTION

Steering parts
Elementos Direcciones
Elementy uklad kierowniczy
Элементы рулевой системы

G/L  D/R

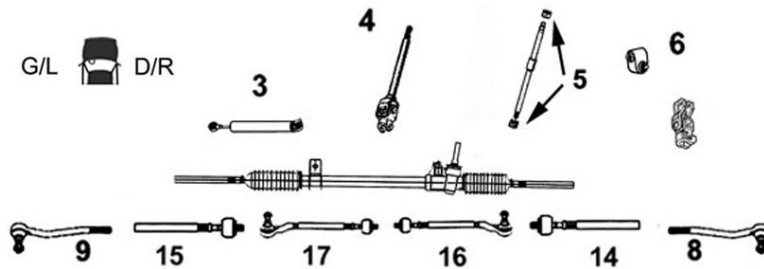

9006282
OE 1359347

Axe de bielle G/D
L/R axial joint



14 Côté dir. M18x1.5 Côté rot. M14x2.0
15 long 294 mm

TT /all models

02/82-12/88

9006285
OE 9140504

Axe de bielle G/D
L/R axial joint



14 Côté dir. M14x1.5 Côté rot. M14x2.0
15 long 275 mm

TT /all models

01/89-

9006610
OE 3516944

Rotule de direction G/D
L/R tie rod end

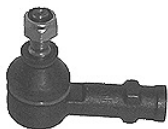

8
9 M14 x 2

TT /all models

02/82-

VOLVO



... 760

Bras & Triangle de suspension

Control arm
Brazo y triángulo
Wahacz
Рычаг подвески

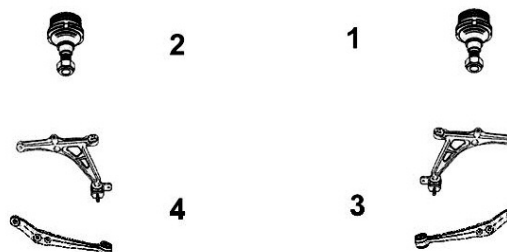
G/L  D/R**9005419****Rotule de susp. inf. G/D**

OE 270477

L/R lower suspension ball joint1
2

TT /all models

02/82-

780 ...

Eléments DIRECTION

Steering parts
Elementos Direcciones
Elementy uklad kierowniczy
Элементы рулевой системы

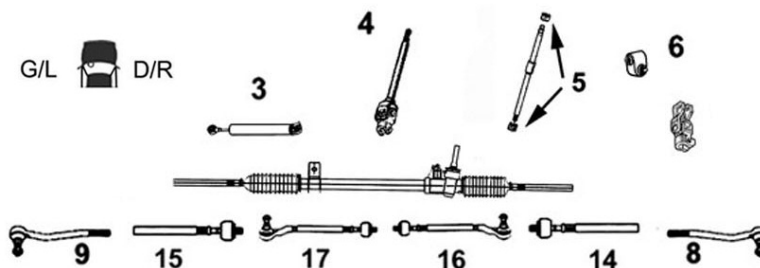
G/L  D/R**9006282****Axe de bielle G/D**

OE 1359347

L/R axial joint14 Côté dir. M18x1.5 Côté rot. M14x2.0
15 long 294 mm

TT /all models Coupé 01/85-12/88

9006285**Axe de bielle G/D**

OE 9140504

L/R axial joint14 Côté dir. M14x1.5 Côté rot. M14x2.0
15 long 275 mm

TT /all models Coupé 01/89-

9006610**Rotule de direction G/D**

OE 3516944

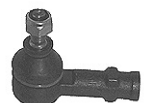
L/R tie rod end8
9 M14x2

TT /all models Coupé

01/85-

... 780

Bras & Triangle de suspension

Control arm
Brazo y triángulo
Wahacz
Рычаг подвески

G/L  D/R



9005419

Rotule de susp. inf. G/D

OE 270477

L/R lower suspension ball joint



1
2

TT /all models Coupé

01/85-

850

Eléments DIRECTION

Steering parts
Elementos Direcciones
Elementy układ kierowniczy
Элементы рулевой системы

G/L  D/R

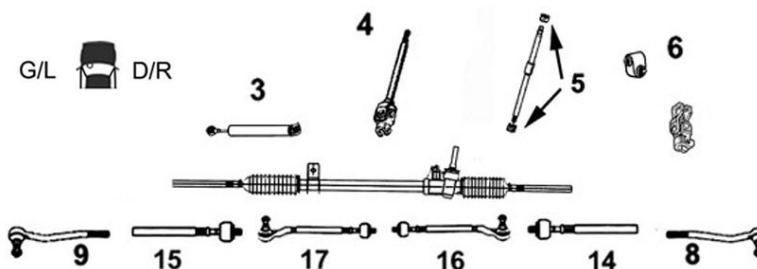

9006612

Rotule de direction G

OE 271598

Left tie rod end



9

M14 x 2

TT /all models

06/91-

9006611

Rotule de direction D

OE 271599

Right tie rod end



8

M14 x 2

TT /all models

06/91-

Bras & Triangle de suspension

Control arm
Brazo y triángulo
Wahacz
Рычаг подвески

G/L  D/R

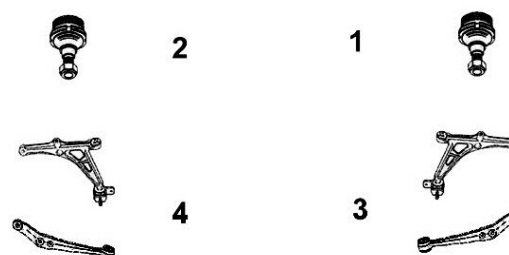

9005786

Triangle de susp. inf. G

OE 8628495

Lower left track control arm



4

Avec rotule With ball joint

TT /all models

-ch 131536

9005784

Triangle de susp. inf. D

OE 8628496

Lower right track control arm



3

Avec rotule With ball joint

TT /all models

-ch 131536

940 960

Eléments DIRECTION

Steering parts

Elementos Direcciones

Elementy uklad kierowniczy

Элементы рулевой системы

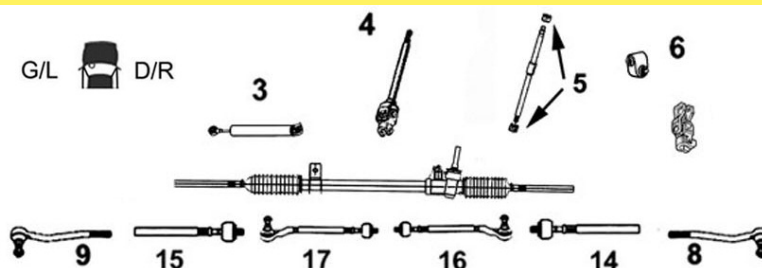
**9006285****Axe de bielle G/D**

OE 9140504

L/R axial joint

14 Côté dir. M14x1.5 Côté rot. M14x2.0
15 long 275 mm

TT /all models

01/89-

**9006610****Rotule de direction G/D**

OE 3516944

L/R tie rod end

8 M14 x 2
9

TT /all models

01/90-

**Bras & Triangle de suspension**

Control arm

Brazo y triángulo

Wahacz

Рычаг подвески

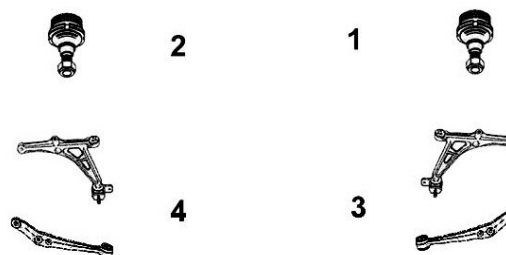
G/L  D/R**9005419****Rotule de susp. inf. G/D**

OE 270477

L/R lower suspension ball joint

1
2

TT /all models

01/90-



C30 ...

Eléments DIRECTION

Steering parts

Elementos Direcciones

Elementy uklad kierowniczy

Элементы рулевой системы

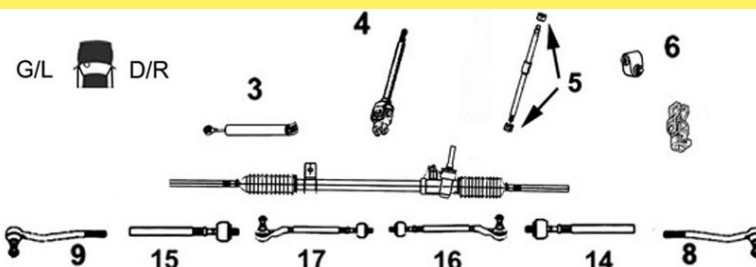
**9006839****Axe de bielle G/D**

OE 31201817

L/R axial joint

14 Côté dir. M14x1.5 Côté rot. M16x1.5 long 288 mm
15

1.6i 16v.

12/06-12/09

1.6 D

10/09-

1.6 TD

12/06-12/09

1.8i 16v.

12/06-12/09

2.0i 16v.

12/06-12/09

2.0 D

12/06-

2.0 TD

10/09-

2.4i 20v.

12/06-12/09

2.4 TDi 20v.

12/06-12/09

2.5i 20v. Turbo

12/06-12/09



... C30 ...



Barre stabilisatrice
 Stabilizer bar
 Barra estabilizadora
 Drażek stabilizatora
 стабилизатор поперечной устойчивости

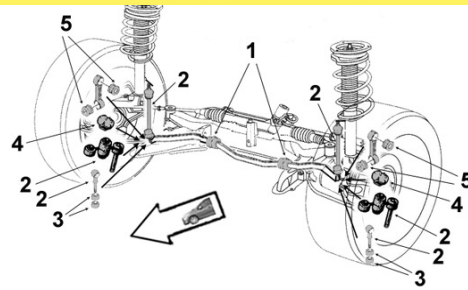

2306024

OE 8623576

Biellette barre stab.

Stabilizer bar stub axle



2

1.6i 16v.	BVM	12/06-
1.6 D		12/06-
1.6 TD FAP	BVM	12/06-
1.8i 16v.	BVM	12/06-
2.0i 16v. /ETH		12/06-
2.0 TD		12/06-
2.4i 20v.		12/06-
2.4 TDi 20v. FAP		12/06-
2.5i 20v. Turbo		12/06-



Eléments SUSPENSION
 Suspension parts
 Elementos suspensión
 Elementy zawieszenie
 Элементы подвески

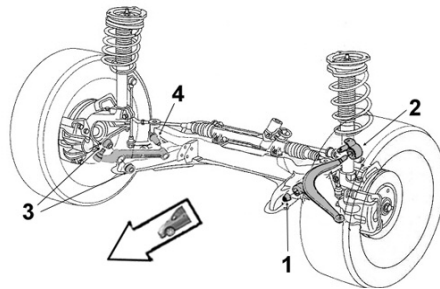

2256020

OE 30714128

Articulation AV

Front bush



1

**Ø int. 14 Ø ext. 41 coll. 45.5
 long. tube int. 65 ext 31.5**

1.6i 16v.	BVM	12/06-
1.6 TD FAP	BVM	12/06-
1.8i 16v.	BVM	12/06-
2.0i 16v.		12/06-
2.0 D FAP	BVM	12/06-
2.0 Di	BVM	10/08-
2.0 TD FAP	BVA	01/08-
2.4i 20v.		12/06-
2.5i 20v. Turbo		12/06-09/07

2256021

OE -

Articulation AR

Rear bush



2

Ø int.22

1.6i 16v.	BVM	12/06-
1.6 TD FAP	BVM	12/06-
1.8i 16v.	BVM	12/06-
2.0i 16v.		12/06-
2.0 D FAP	BVM	12/06-
2.0 Di	BVM	10/08-
2.0 TD FAP	BVA	01/08-
2.4i 20v.		12/06-
2.5i 20v. Turbo		12/06-09/07

Bras & Triangle de suspension

*Control arm
 Brazo y triángulo
 Wahacz
 Рычаг подвески*

G/L D/R

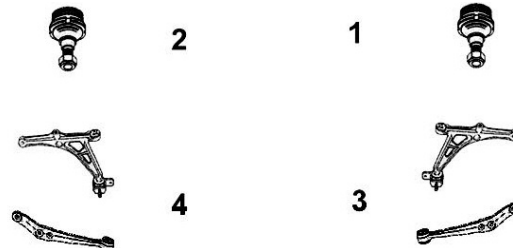

9005814

OE 31277464

Triangle de susp. G

Left track control arm



4

Avec rotule With ball joint Cône Ø 15 - Ø 18 -ch 260

1.6i 16v.	09/07-
1.6 D /FAP	09/07-
1.6 TD FAP	09/07-
1.8i 16v. /ETH	09/07-
2.0i 16v. /ETH	09/07-
2.0 D/Di FAP	09/07-
2.0 D3 D4	09/07-
2.0 TD FAP	09/07-
2.4i 20v.	09/07-
2.4 TDi 20v. /FAP	09/07-
2.5i 20v. Turbo	09/07-

9005813

OE 31277465

Triangle de susp. D

Right track control arm



3

Avec rotule With ball joint Cône Ø 15 - Ø 18 -ch 260

1.6i 16v.	09/07-
1.6 D /FAP	09/07-
1.6 TD FAP	09/07-
1.8i 16v. /ETH	09/07-
2.0i 16v. /ETH	09/07-
2.0 D/Di FAP	09/07-
2.0 D3 D4	09/07-
2.0 TD FAP	09/07-
2.4i 20v.	09/07-
2.4 TDi 20v. /FAP	09/07-
2.5i 20v. Turbo	09/07-

... C30

SASIC

VOLVO

Bras & Triangle de suspension

Control arm
Brazo y triángulo
Wahacz
Рычаг подвески

G/L  D/R

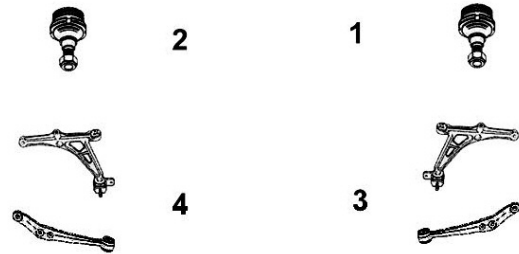

7476192

OE 31277463

Triangle de susp. G

Left track control arm

NEW



4 Avec rotule With ball joint Cône Ø 18- Ø 21 Ch- 261

1.6i 16v.	09/07-
1.6 D /FAP	09/07-
1.6 TD FAP	09/07-
1.8i 16v. /ETH	09/07-
2.0i 16v. /ETH	09/07-
2.0 D/ Di FAP	09/07-
2.0 D3D4	09/07-
2.0 TD FAP	09/07-
2.4i 20v.	09/07-
2.4 TDi 20v. FAP	09/07-
2.5i 20v. Turbo	09/07-

7476193

OE 31277462

Triangle de susp. D

Right track control arm

NEW



3 Avec rotule With ball joint Cône Ø 18- Ø 21 Ch- 261

1.6i 16v.	09/07-
1.6 D /FAP	09/07-
1.6 TD FAP	09/07-
1.8i 16v. /ETH	09/07-
2.0i 16v. /ETH	09/07-
2.0 D/ Di FAP	09/07-
2.0 D3D4	09/07-
2.0 TD FAP	09/07-
2.4i 20v.	09/07-
2.4 TDi 20v. FAP	09/07-
2.5i 20v. Turbo	09/07-

7576041

Part/oe 31277462

Rotule de susp. G/D

L/R suspension ball joint

NEW



1 Cône Ø 18- Ø 21
2 Ch- 261

1.6i 16v.	09/07-
1.6 D /FAP	09/07-
1.6 TD FAP	09/07-
1.8i 16v. /ETH	09/07-
2.0i 16v. /ETH	09/07-

2.0 D/Di FAP	09/07-
2.0 D3 D4	09/07-
2.4i 20v.	09/07-
2.4 TDi 20v. FAP	09/07-
2.5i 20v. Turbo	09/07-

9005527

Part/oe 31277464

Rotule de susp. G/D

L/R suspension ball joint

NEW



1 Cône Ø 15 - Ø 18
2 Ch- 260

1.6i 16v.	09/07-
1.6 D /FAP	09/07-
1.6 TD FAP	09/07-
1.8i 16v. /ETH	09/07-
2.0i 16v. /ETH	09/07-

2.0 D/Di FAP	09/07-
2.0 D3 D4	09/07-
2.4i 20v.	09/07-
2.4 TDi 20v. FAP	09/07-
2.5i 20v. Turbo	09/07-

C70 Coupé ...

Eléments DIRECTION

Steering parts
Elementos Direcciones
Elementy układ kierowniczy
Элементы рулевой системы

G/L  D/R

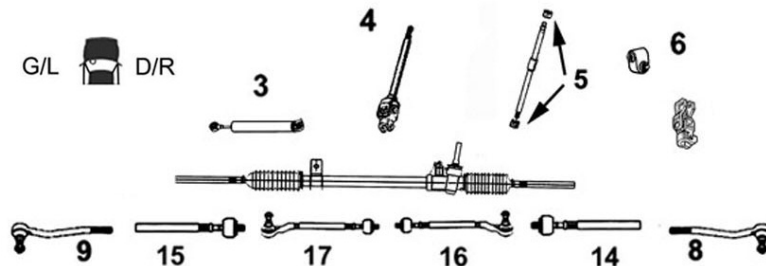

9006839

OE 31201817

Axe de bielle G/D

L/R axial joint

NEW





14 Côté dir. M14x1.5 Côté rot. M16x1.5 long 288 mm
15

2.0 TD	07/06-12/09
2.4i 20v.	01/06-12/09
2.4 TDi 20v.	05/06-12/09
2.5i 20v. Turbo	01/06-12/09

... C70 Coupé ...

VOLVO



9006612 OE 271598	Rotule de direction G <i>Left tie rod end</i>	9006611 OE 271599	Rotule de direction D <i>Right tie rod end</i>
	9 M14x2 2.0 2.3i 20v. Turbo T5 2.5 2.5 Turbo		8 M14x2 2.0 2.3i 20v. Turbo T5 2.5 2.5 Turbo



Barre stabilisatrice
Stabilizer bar
Barra estabilizadora
Drażek stabilizatora
 стабилизатор поперечной устойчивости

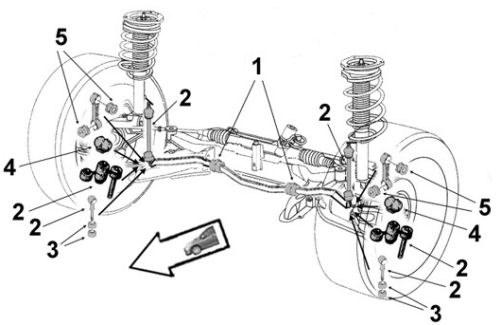



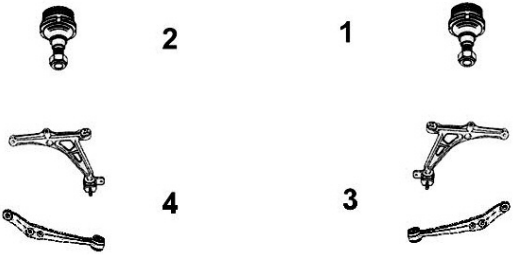

2306024 OE 8623576	Biellette barre stab. <i>Stabilizer bar stub axle</i>		
	2 2.0 TD 2.4i 20v. 2.4 TDi 20v. FAP 2.5i 20v. Turbo	04/08- 01/06- 05/06- 03/06-	

Bras & Triangle de suspension
Control arm
Brazo y triángulo
Wahacz
 Рычаг подвески

G/L  D/R



9005814 OE 31277464	Triangle de susp. G <i>Left track control arm</i>	9005813 OE 31277465	Triangle de susp. D <i>Right track control arm</i>
	4 Avec rotule With ball joint Cône Ø 15 - Ø 18 -ch 2026 2.0 D3 01/06- 2.0 D4 01/06- 2.0 TD FAP 01/06- 2.4i 20v. 01/06- 2.4 TDi 20v. /FAP 01/06- 2.5i 20v. Turbo 01/06-		3 Avec rotule With ball joint Cône Ø 15 - Ø 18 -ch 2026 2.0 D3 01/06- 2.0 D4 01/06- 2.0 TD FAP 01/06- 2.4i 20v. 01/06- 2.4 TDi 20v. /FAP 01/06- 2.5i 20v. Turbo 01/06-

7476192 OE 31277463	Triangle de susp. G <i>Left track control arm</i>	7476193 OE 31277462	Triangle de susp. D <i>Right track control arm</i>
	4 Avec rotule With ball joint Cône Ø 18- Ø 21 Ch-2027 2.0 D3 05/06- 2.0 D4 05/06- 2.0 TD FAP 05/06- 2.4i 20v. 05/06- 2.4 TDi 20v. /FAP 05/06- 2.5i 20v. Turbo 05/06-		3 Avec rotule With ball joint Cône Ø 18- Ø 21 Ch-2027 2.0 D3 05/06- 2.0 D4 05/06- 2.0 TD FAP 05/06- 2.4i 20v. 05/06- 2.4 TDi 20v. /FAP 05/06- 2.5i 20v. Turbo 05/06-

... C70 Coupé

Bras & Triangle de suspension

Control arm
Brazo y triángulo
Wahacz
Рычаг подвески

G/L  D/R**9005788**

OE 272336

Triangle de susp. inf. G

Lower left track control arm

4 Avec rotule With ball joint

2.3 T5
2.5 Turbo

9005787

OE 272337

Triangle de susp. inf. D

Lower right track control arm

3 Avec rotule With ball joint

2.3 T5
2.5 Turbo

9005527

Part/oe 31277464

Rotule de susp. G/D

L/R suspension ball joint

1 Cône Ø 15 - Ø 18
2 -ch 2026

2.0 D3	01/06-
2.0 D4	01/06-
2.0 TD FAP	01/06-
2.4i 20v.	01/06-
2.4 TDi 20v. /FAP	01/06-
2.5i 20v. Turbo	01/06-

7576041

Part/oe 31277462

Rotule de susp. G/D

L/R suspension ball joint

NEW

**1** Cône Ø 18- Ø 21
2 Ch-2027

2.0 D3	01/06-
2.0 D4	01/06-
2.0 TD FAP	01/06-
2.4i 20v.	01/06-
2.4 TDi 20v. /FAP	01/06-
2.5i 20v. Turbo	01/06-

S40 V40 ...

Eléments DIRECTION

Steering parts
Elementos Direcciones
Elementy układ kierowniczy
Элементы рулевой системы

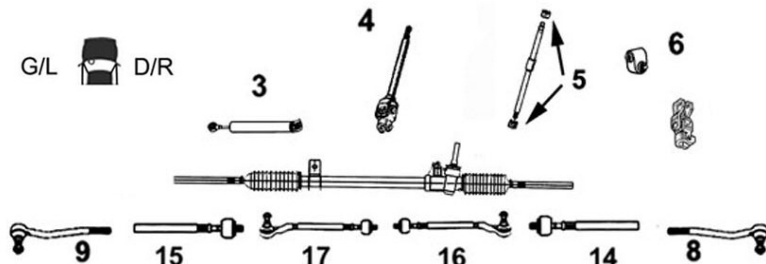
G/L  D/R**9006839**

OE 31201817

Axe de bielle G/D

L/R axial joint

14 Côté dir. M14x1.5 Côté rot. M16x1.5
15 long 288 mm
S40

1.6i 16v.	11/04-
1.6 TD	11/04-
1.8i 16v.	01/04-
2.0i 16v.	09/06-
2.0 D	01/04-06/07
2.0 TD	06/07-
2.4i 20v.	01/04-
2.4 TDi 20v.	02/06-
2.5i 20v. Turbo	01/04-

9006880

Part/oe 3345797

Axe de bielle G/D

L/R axial joint

14 Côté dir. M16x1.5 Côté rot. M12x1.25
15 long 305 mm

1.6i 16v.	-05/00
1.8i 16v.	-12/00
1.9i 16v. Turbo T4	-05/00
1.9 TD	-05/00
1.9 TDi	06/00-12/00
2.0i 16v. /Turbo /T4	-12/00

9006693

OE 30875012

Rotule de direction G/D

L/R tie rod end



8 M12 x 1.25
9

1.6i 16v.	-12/00
1.8i 16v.	-12/00
1.9i 16v. Turbo T4	-05/00
1.9 TD	-05/00
1.9 TDi	-12/00
2.0i 16v. /Turbo /T4	-12/00

... S40 V40 ...

VOLVO





9006617 OE 274225	Rotule de direction G <i>Left tie rod end</i>	9006615 OE 274226	Rotule de direction D <i>Right tie rod end</i>														
	9 M14 x 1.5		8 M14 x 1.5														
	<table style="width: 100%; border-collapse: collapse;"> <tr><td style="width: 50%;">1.6i 16v.</td><td style="width: 50%;">01/01-12/03</td></tr> <tr><td>1.8i 16v.</td><td>01/01-12/03</td></tr> <tr><td>1.9 TDi</td><td>01/01-12/03</td></tr> <tr><td>2.0i 16v. /Turbo /T4</td><td>01/01-12/03</td></tr> </table>		1.6i 16v.	01/01-12/03	1.8i 16v.	01/01-12/03	1.9 TDi	01/01-12/03	2.0i 16v. /Turbo /T4	01/01-12/03	<table style="width: 100%; border-collapse: collapse;"> <tr><td style="width: 50%;">1.6i 16v.</td><td style="width: 50%;">01/01-12/03</td></tr> <tr><td>1.8i 16v.</td><td>01/01-12/03</td></tr> <tr><td>1.9 TDi</td><td>01/01-12/03</td></tr> <tr><td>2.0i 16v. /Turbo /T4</td><td>01/01-12/03</td></tr> </table>	1.6i 16v.	01/01-12/03	1.8i 16v.	01/01-12/03	1.9 TDi	01/01-12/03
1.6i 16v.	01/01-12/03																
1.8i 16v.	01/01-12/03																
1.9 TDi	01/01-12/03																
2.0i 16v. /Turbo /T4	01/01-12/03																
1.6i 16v.	01/01-12/03																
1.8i 16v.	01/01-12/03																
1.9 TDi	01/01-12/03																
2.0i 16v. /Turbo /T4	01/01-12/03																

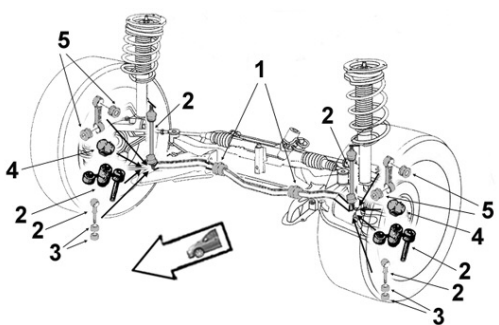

Barre stabilisatrice
Stabilizer bar
Barra estabilizadora
Drażek stabilizatora
стабилизатор поперечной устойчивости





2306069 OE 30884358	Biellette barre stab. <i>Stabilizer bar stub axle</i>	2306067 OE 30884179	Biellette barre stab. <i>Stabilizer bar stub axle</i>																						
	2		2																						
	<table style="width: 100%; border-collapse: collapse;"> <tr><td style="width: 50%;">1.6i 16v.</td><td style="width: 50%;">06/97-12/00</td></tr> <tr><td>1.8i 16v.</td><td>03/96-12/00</td></tr> <tr><td>1.9i 16v. Turbo</td><td>06/97-12/00</td></tr> <tr><td>1.9 TD</td><td>06/96-12/00</td></tr> <tr><td>1.9 TDi</td><td>01/99-12/00</td></tr> <tr><td>2.0i 16v.</td><td>03/96-12/00</td></tr> <tr><td>2.0i 16v. Turbo</td><td>01/98-12/00</td></tr> </table>		1.6i 16v.	06/97-12/00	1.8i 16v.	03/96-12/00	1.9i 16v. Turbo	06/97-12/00	1.9 TD	06/96-12/00	1.9 TDi	01/99-12/00	2.0i 16v.	03/96-12/00	2.0i 16v. Turbo	01/98-12/00	<table style="width: 100%; border-collapse: collapse;"> <tr><td style="width: 50%;">1.6i 16v.</td><td style="width: 50%;">01/01-09/03</td></tr> <tr><td>1.8i 16v.</td><td>01/01-12/03</td></tr> <tr><td>1.9 TDi</td><td>01/01-12/03</td></tr> <tr><td>2.0i 16v.</td><td>01/01-12/03</td></tr> <tr><td>2.0i 16v. Turbo</td><td>01/01-12/03</td></tr> </table>	1.6i 16v.	01/01-09/03	1.8i 16v.	01/01-12/03	1.9 TDi	01/01-12/03	2.0i 16v.	01/01-12/03
1.6i 16v.	06/97-12/00																								
1.8i 16v.	03/96-12/00																								
1.9i 16v. Turbo	06/97-12/00																								
1.9 TD	06/96-12/00																								
1.9 TDi	01/99-12/00																								
2.0i 16v.	03/96-12/00																								
2.0i 16v. Turbo	01/98-12/00																								
1.6i 16v.	01/01-09/03																								
1.8i 16v.	01/01-12/03																								
1.9 TDi	01/01-12/03																								
2.0i 16v.	01/01-12/03																								
2.0i 16v. Turbo	01/01-12/03																								

2306024 OE 8623576	Biellette barre stab. <i>Stabilizer bar stub axle</i>															
	2															
	<table style="width: 100%; border-collapse: collapse;"> <tr><td style="width: 50%;">1.6i 16v.</td><td style="width: 50%;">01/05-</td></tr> <tr><td>1.6 TD</td><td>01/05-</td></tr> <tr><td>1.8i 16v.</td><td>04/04-</td></tr> <tr><td>2.0i 16v.</td><td>09/06-</td></tr> <tr><td>2.0 TD</td><td>01/04-</td></tr> <tr><td>2.4i 20v.</td><td>01/04-</td></tr> <tr><td>2.4 TD D5</td><td>02/06-</td></tr> <tr><td>2.5i 20v. Turbo /4WD</td><td>01/04-</td></tr> </table>	1.6i 16v.	01/05-	1.6 TD	01/05-	1.8i 16v.	04/04-	2.0i 16v.	09/06-	2.0 TD	01/04-	2.4i 20v.	01/04-	2.4 TD D5	02/06-	2.5i 20v. Turbo /4WD
1.6i 16v.	01/05-															
1.6 TD	01/05-															
1.8i 16v.	04/04-															
2.0i 16v.	09/06-															
2.0 TD	01/04-															
2.4i 20v.	01/04-															
2.4 TD D5	02/06-															
2.5i 20v. Turbo /4WD	01/04-															

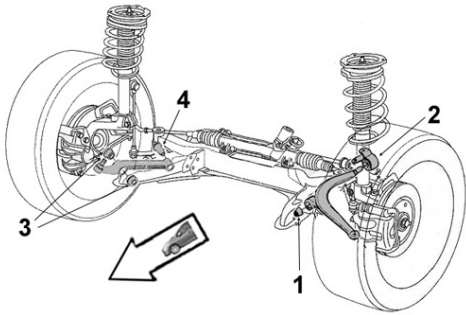

Eléments SUSPENSION
Suspension parts
Elementos suspensión
Elementy zawieszenie
Элементы подвески



2256044 OE 30818467	Articulation AV <i>Front bush</i>	2256020 OE 30714128	Articulation AV <i>Front bush</i>																								
	1 Ø int.12 Ø ext.36 coll.40 long. tube int. 60 ext. 37		1 Ø int. 14 Ø ext. 41 coll. 45.5 long. tube int. 65 ext 31.5																								
	<table style="width: 100%; border-collapse: collapse;"> <tr><td style="width: 50%;">1.6i 16v.</td><td style="width: 50%;">06/97-12/03</td></tr> <tr><td>1.8i 16v.</td><td>03/96-12/03</td></tr> <tr><td>1.9i 16v. Turbo</td><td>06/97-12/03</td></tr> <tr><td>1.9 TD</td><td>06/96-12/03</td></tr> <tr><td>1.9 TDi</td><td>01/99-12/03</td></tr> <tr><td>2.0i 16v.</td><td>03/96-12/03</td></tr> <tr><td>2.0i 16v. Turbo</td><td>01/98-12/03</td></tr> </table>		1.6i 16v.	06/97-12/03	1.8i 16v.	03/96-12/03	1.9i 16v. Turbo	06/97-12/03	1.9 TD	06/96-12/03	1.9 TDi	01/99-12/03	2.0i 16v.	03/96-12/03	2.0i 16v. Turbo	01/98-12/03	<table style="width: 100%; border-collapse: collapse;"> <tr><td style="width: 50%;">1.6i 16v. S40</td><td style="width: 50%;">BVM 11/04-</td></tr> <tr><td>1.6 TD S40</td><td>11/04-</td></tr> <tr><td>1.8i 16v. S40</td><td>BVM 06/07-</td></tr> <tr><td>2.0 D S40</td><td>01/04-</td></tr> <tr><td>2.4i 20v. S40</td><td>01/04-</td></tr> <tr><td>2.5i 20v. Turbo S40</td><td>01/04-06/07</td></tr> </table>	1.6i 16v. S40	BVM 11/04-	1.6 TD S40	11/04-	1.8i 16v. S40	BVM 06/07-	2.0 D S40	01/04-	2.4i 20v. S40	01/04-
1.6i 16v.	06/97-12/03																										
1.8i 16v.	03/96-12/03																										
1.9i 16v. Turbo	06/97-12/03																										
1.9 TD	06/96-12/03																										
1.9 TDi	01/99-12/03																										
2.0i 16v.	03/96-12/03																										
2.0i 16v. Turbo	01/98-12/03																										
1.6i 16v. S40	BVM 11/04-																										
1.6 TD S40	11/04-																										
1.8i 16v. S40	BVM 06/07-																										
2.0 D S40	01/04-																										
2.4i 20v. S40	01/04-																										
2.5i 20v. Turbo S40	01/04-06/07																										

... S40 V40 ...



Eléments SUSPENSION
Suspension parts
Elementos suspensión
Elementy zawieszenie
Элементы подвески

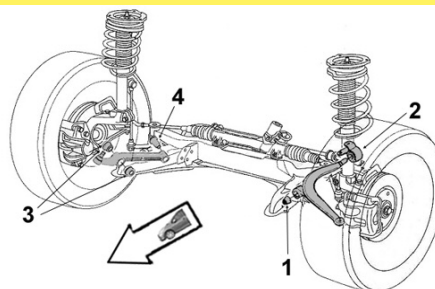

VOLVO



2256041

Articulation AR G

OE 30872510

Left rear bush



2

Ø int. 20.5

1.6i 16v.	06/97-12/03
1.8i 16v.	03/96-12/03
1.9i 16v. Turbo	06/97-12/03
1.9 TD	06/96-12/03
1.9 TDi	01/99-12/03
2.0i 16v.	03/96-12/03
2.0i 16v. Turbo	01/98-12/03

2256042

Articulation AR D

OE 30872511

Right rear bush



2

Ø int. 20.5

1.6i 16v.	06/97-12/03
1.8i 16v.	03/96-12/03
1.9i 16v. Turbo	06/97-12/03
1.9 TD	06/96-12/03
1.9 TDi	01/99-12/03
2.0i 16v.	03/96-12/03
2.0i 16v. Turbo	01/98-12/03

2256021

Articulation AR

OE -

Rear bush



2

Ø int.22

S40

1.6i 16v.	
1.6 TD	
1.8i 16v.	
2.0 D	
2.4i 20v.	
2.5i 20v. Turbo	

BVM

11/04-

BVM

11/04-

06/07-

01/04-

01/04-

01/04-06/07

Bras & Triangle de suspension

Control arm
Brazo y triángulo
Wahacz
Рычаг подвески

G/L D/R



2

1



4

3



9005790

Triangle de susp. inf. G

OE 30887025

Lower left track control arm



4

Avec rotule With ball joint

1.6i 16v.	07/97-12/01
1.8i 16v.	03/96-12/01
1.9i 16v. Turbo	07/97-05/00
1.9 TD	03/96-12/03
1.9 TDi	06/00-12/03
2.0i 16v. /Turbo /T4	03/96-12/01

9005789

Triangle de susp. inf. D

OE 30887033

Lower right track control arm



3



Avec rotule With ball joint



1.6i 16v.	07/97-12/01
1.8i 16v.	03/96-12/01
1.9i 16v. Turbo	07/97-05/00
1.9 TD	03/96-12/03
1.9 TDi	06/00-12/03
2.0i 16v. /Turbo /T4	03/96-12/01

... S40 V40

VOLVO



9005814 OE 31277464	Triangle de susp. G <i>Left track control arm</i>	9005813 OE 31277465	Triangle de susp. D <i>Right track control arm</i>																																										
	4 Avec rotule With ball joint Cône Ø 15 - Ø 18 S40 -ch 209290		3 Avec rotule With ball joint Cône Ø 15 - Ø 18 S40 -ch 209290																																										
	<table style="width: 100%; border-collapse: collapse;"> <tr><td>1.6i 16v.</td><td>11/04-</td></tr> <tr><td>1.6 TD /FAP</td><td>11/04-</td></tr> <tr><td>1.8i 16v. /ETH</td><td>01/04-</td></tr> <tr><td>2.0i 16v. /ETH</td><td>06/07-</td></tr> <tr><td>2.0 D FAP</td><td>01/04-</td></tr> <tr><td>2.0 D3</td><td>07/10-</td></tr> <tr><td>2.0 D4</td><td>06/10-</td></tr> <tr><td>2.0 TD FAP</td><td>06/12-</td></tr> <tr><td>2.4i 20v.</td><td>01/04-</td></tr> <tr><td>2.4 TDi 20v. /FAP</td><td>03/06-</td></tr> <tr><td>2.5i 20v. Turbo /4WD</td><td>01/04-</td></tr> </table>		1.6i 16v.	11/04-	1.6 TD /FAP	11/04-	1.8i 16v. /ETH	01/04-	2.0i 16v. /ETH	06/07-	2.0 D FAP	01/04-	2.0 D3	07/10-	2.0 D4	06/10-	2.0 TD FAP	06/12-	2.4i 20v.	01/04-	2.4 TDi 20v. /FAP	03/06-	2.5i 20v. Turbo /4WD	01/04-	<table style="width: 100%; border-collapse: collapse;"> <tr><td>1.6i 16v.</td><td>11/04-</td></tr> <tr><td>1.6 TD /FAP</td><td>11/04-</td></tr> <tr><td>1.8i 16v. /ETH</td><td>01/04-</td></tr> <tr><td>2.0i 16v. /ETH</td><td>06/07-</td></tr> <tr><td>2.0 D FAP</td><td>01/04-</td></tr> <tr><td>2.0 D3</td><td>07/10-</td></tr> <tr><td>2.0 D4</td><td>06/10-</td></tr> <tr><td>2.0 TD FAP</td><td>06/12-</td></tr> <tr><td>2.4i 20v.</td><td>01/04-</td></tr> <tr><td>2.4 TDi 20v. /FAP</td><td>03/06-</td></tr> <tr><td>2.5i 20v. Turbo /4WD</td><td>01/04-</td></tr> </table>	1.6i 16v.	11/04-	1.6 TD /FAP	11/04-	1.8i 16v. /ETH	01/04-	2.0i 16v. /ETH	06/07-	2.0 D FAP	01/04-	2.0 D3	07/10-	2.0 D4	06/10-	2.0 TD FAP	06/12-	2.4i 20v.	01/04-	2.4 TDi 20v. /FAP	03/06-
1.6i 16v.	11/04-																																												
1.6 TD /FAP	11/04-																																												
1.8i 16v. /ETH	01/04-																																												
2.0i 16v. /ETH	06/07-																																												
2.0 D FAP	01/04-																																												
2.0 D3	07/10-																																												
2.0 D4	06/10-																																												
2.0 TD FAP	06/12-																																												
2.4i 20v.	01/04-																																												
2.4 TDi 20v. /FAP	03/06-																																												
2.5i 20v. Turbo /4WD	01/04-																																												
1.6i 16v.	11/04-																																												
1.6 TD /FAP	11/04-																																												
1.8i 16v. /ETH	01/04-																																												
2.0i 16v. /ETH	06/07-																																												
2.0 D FAP	01/04-																																												
2.0 D3	07/10-																																												
2.0 D4	06/10-																																												
2.0 TD FAP	06/12-																																												
2.4i 20v.	01/04-																																												
2.4 TDi 20v. /FAP	03/06-																																												
2.5i 20v. Turbo /4WD	01/04-																																												

7476192 OE 31277463	Triangle de susp. G <i>Left track control arm</i>	7476193 OE 31277462	Triangle de susp. D <i>Right track control arm</i>																																										
	4 Avec rotule With ball joint Cône Ø 18- Ø 21 S40 Ch-209291		3 Avec rotule With ball joint Cône Ø 18- Ø 21 S40 Ch-209291																																										
	<table style="width: 100%; border-collapse: collapse;"> <tr><td>1.6i 16v.</td><td>11/04-</td></tr> <tr><td>1.6 TD /FAP</td><td>11/04-</td></tr> <tr><td>1.8i 16v. /ETH</td><td>01/04-</td></tr> <tr><td>2.0i 16v. /ETH</td><td>09/06-</td></tr> <tr><td>2.0 D FAP</td><td>01/04-</td></tr> <tr><td>2.0 D3</td><td>01/04-</td></tr> <tr><td>2.0 D4</td><td>01/04-</td></tr> <tr><td>2.0 TD FAP</td><td>06/07-</td></tr> <tr><td>2.4i 20v.</td><td>01/04-</td></tr> <tr><td>2.4 TDi 20v. FAP</td><td>02/06-</td></tr> <tr><td>2.5i 20v. Turbo /4WD</td><td>01/04-</td></tr> </table>		1.6i 16v.	11/04-	1.6 TD /FAP	11/04-	1.8i 16v. /ETH	01/04-	2.0i 16v. /ETH	09/06-	2.0 D FAP	01/04-	2.0 D3	01/04-	2.0 D4	01/04-	2.0 TD FAP	06/07-	2.4i 20v.	01/04-	2.4 TDi 20v. FAP	02/06-	2.5i 20v. Turbo /4WD	01/04-	<table style="width: 100%; border-collapse: collapse;"> <tr><td>1.6i 16v.</td><td>11/04-</td></tr> <tr><td>1.6 TD /FAP</td><td>11/04-</td></tr> <tr><td>1.8i 16v. /ETH</td><td>01/04-</td></tr> <tr><td>2.0i 16v. /ETH</td><td>09/06-</td></tr> <tr><td>2.0 D FAP</td><td>01/04-</td></tr> <tr><td>2.0 D3</td><td>01/04-</td></tr> <tr><td>2.0 D4</td><td>01/04-</td></tr> <tr><td>2.0 TD FAP</td><td>06/07-</td></tr> <tr><td>2.4i 20v.</td><td>01/04-</td></tr> <tr><td>2.4 TDi 20v. FAP</td><td>02/06-</td></tr> <tr><td>2.5i 20v. Turbo /4WD</td><td>01/04-</td></tr> </table>	1.6i 16v.	11/04-	1.6 TD /FAP	11/04-	1.8i 16v. /ETH	01/04-	2.0i 16v. /ETH	09/06-	2.0 D FAP	01/04-	2.0 D3	01/04-	2.0 D4	01/04-	2.0 TD FAP	06/07-	2.4i 20v.	01/04-	2.4 TDi 20v. FAP	02/06-
1.6i 16v.	11/04-																																												
1.6 TD /FAP	11/04-																																												
1.8i 16v. /ETH	01/04-																																												
2.0i 16v. /ETH	09/06-																																												
2.0 D FAP	01/04-																																												
2.0 D3	01/04-																																												
2.0 D4	01/04-																																												
2.0 TD FAP	06/07-																																												
2.4i 20v.	01/04-																																												
2.4 TDi 20v. FAP	02/06-																																												
2.5i 20v. Turbo /4WD	01/04-																																												
1.6i 16v.	11/04-																																												
1.6 TD /FAP	11/04-																																												
1.8i 16v. /ETH	01/04-																																												
2.0i 16v. /ETH	09/06-																																												
2.0 D FAP	01/04-																																												
2.0 D3	01/04-																																												
2.0 D4	01/04-																																												
2.0 TD FAP	06/07-																																												
2.4i 20v.	01/04-																																												
2.4 TDi 20v. FAP	02/06-																																												
2.5i 20v. Turbo /4WD	01/04-																																												

9005527 Part/oe 31277464	Rotule de susp. G/D <i>L/R suspension ball joint</i>																													
	1 Cône Ø 15 - Ø 18 S40 -ch 209290																													
	<table style="width: 100%; border-collapse: collapse;"> <tr><td>1.6i 16v.</td><td>11/04-</td><td>2.0 TD FAP</td><td>06/12-</td></tr> <tr><td>1.6 TD /FAP</td><td>11/04-</td><td>2.4i 20v.</td><td>01/04-</td></tr> <tr><td>1.8i 16v. /ETH</td><td>01/04-</td><td>2.4 TDi 20v. /FAP</td><td>03/06-</td></tr> <tr><td>2.0i 16v. /ETH</td><td>06/07-</td><td>2.5i 20v. Turbo /4WD</td><td>01/04-</td></tr> <tr><td>2.0 D FAP</td><td>01/04-</td><td></td><td></td></tr> <tr><td>2.0 D3</td><td>07/10-</td><td></td><td></td></tr> <tr><td>2.0 D4</td><td>06/10-</td><td></td><td></td></tr> </table>	1.6i 16v.	11/04-	2.0 TD FAP	06/12-	1.6 TD /FAP	11/04-	2.4i 20v.	01/04-	1.8i 16v. /ETH	01/04-	2.4 TDi 20v. /FAP	03/06-	2.0i 16v. /ETH	06/07-	2.5i 20v. Turbo /4WD	01/04-	2.0 D FAP	01/04-			2.0 D3	07/10-			2.0 D4	06/10-			
1.6i 16v.	11/04-	2.0 TD FAP	06/12-																											
1.6 TD /FAP	11/04-	2.4i 20v.	01/04-																											
1.8i 16v. /ETH	01/04-	2.4 TDi 20v. /FAP	03/06-																											
2.0i 16v. /ETH	06/07-	2.5i 20v. Turbo /4WD	01/04-																											
2.0 D FAP	01/04-																													
2.0 D3	07/10-																													
2.0 D4	06/10-																													

7576041 Part/oe 31277462	Rotule de susp. G/D <i>L/R suspension ball joint</i>																																													
	1 Cône Ø 18- Ø 21 S40 Ch-209291																																													
	<table style="width: 100%; border-collapse: collapse;"> <tr><td>1.6i 16v.</td><td>11/04-</td><td></td><td></td></tr> <tr><td>1.6 TD /FAP</td><td>11/04-</td><td></td><td></td></tr> <tr><td>1.8i 16v. /ETH</td><td>01/04-</td><td></td><td></td></tr> <tr><td>2.0i 16v. /ETH</td><td>09/06-</td><td></td><td></td></tr> <tr><td>2.0 D FAP</td><td>01/04-</td><td></td><td></td></tr> <tr><td>2.0 D3</td><td>01/04-</td><td></td><td></td></tr> <tr><td>2.0 D4</td><td>01/04-</td><td></td><td></td></tr> <tr><td>2.0 TD FAP</td><td>06/07-</td><td></td><td></td></tr> <tr><td>2.4i 20v.</td><td>01/04-</td><td></td><td></td></tr> <tr><td>2.4 TDi 20v. FAP</td><td>02/06-</td><td></td><td></td></tr> <tr><td>2.5i 20v. Turbo /4WD</td><td>01/04-</td><td></td><td></td></tr> </table>	1.6i 16v.	11/04-			1.6 TD /FAP	11/04-			1.8i 16v. /ETH	01/04-			2.0i 16v. /ETH	09/06-			2.0 D FAP	01/04-			2.0 D3	01/04-			2.0 D4	01/04-			2.0 TD FAP	06/07-			2.4i 20v.	01/04-			2.4 TDi 20v. FAP	02/06-			2.5i 20v. Turbo /4WD	01/04-			
1.6i 16v.	11/04-																																													
1.6 TD /FAP	11/04-																																													
1.8i 16v. /ETH	01/04-																																													
2.0i 16v. /ETH	09/06-																																													
2.0 D FAP	01/04-																																													
2.0 D3	01/04-																																													
2.0 D4	01/04-																																													
2.0 TD FAP	06/07-																																													
2.4i 20v.	01/04-																																													
2.4 TDi 20v. FAP	02/06-																																													
2.5i 20v. Turbo /4WD	01/04-																																													

S60 ...

VOLVO



Eléments DIRECTION
 Steering parts
 Elementos Direcciones
 Elementy układ kierowniczy
 Элементы рулевой системы

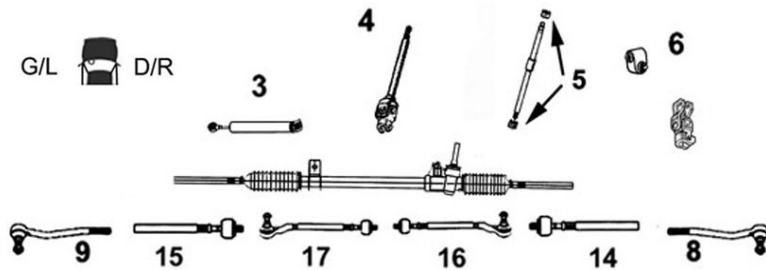

9006879
 OE 274179

Axe de bielle G/D
L/R axial joint

14 Côté dir. M16x1.5 Côté rot. M14x1.5
15 long 124 mm



2.0i 20v. Turbo	-04/09
2.3i 20v. Turbo	-04/09
2.4i 20v. /Turbo /4WD	-04/09
2.4 TDi /D5	-04/09
2.5i 20v. Turbo /4WD	-04/09

7776025
 Part/oe 31280658

Axe de bielle G/D
L/R axial joint

14 Côté dir. M16x1.5 Côté rot. M18x1.5
15 long 315 mm



1.6i Turbo	11/10-
2.0i Turbo	04/10-
2.0 D	04/10-
2.4 TDi /4WD	04/10-
3.0i Turbo 4WD	04/10-

9006614
 OE 30761719

Rotule de direction G
Left tie rod end

9 M14 x 1.5



2.0i 20v. Turbo	09/01-04/10
2.3i 20v. Turbo	09/00-06/04
2.4i 20v. /Turbo /4WD	09/00-04/09
2.4 TDi 20v.	01/01-04/09
2.5i 20v. Turbo /4WD	02/02-04/09

9006613
 OE 30761718

Rotule de direction D
Right tie rod end

8 M14 x 1.5



2.0i 20v. Turbo	09/01-04/10
2.3i 20v. Turbo	09/00-06/04
2.4i 20v. /Turbo /4WD	09/00-04/09
2.4 TDi 20v.	01/01-04/09
2.5i 20v. Turbo /4WD	02/02-04/09

7676025
 OE 31302344

Rotule de direction G
Left tie rod end

9 M18 x 1.5



1.6i Turbo	11/10-
2.0i Turbo	04/10-
2.0 D3	04/10-
2.4 TDi /4WD	04/10-
3.0i Turbo 4WD	04/10-

7676024
 OE 31302345

Rotule de direction D
Right tie rod end

8 M18 x 1.5



1.6i Turbo	11/10-
2.0i Turbo	04/10-
2.0 D3	04/10-
2.4 TDi /4WD	04/10-
3.0i Turbo 4WD	04/10-

Bras & Triangle de suspension

Control arm
 Brazo y triángulo
 Wahacz
 Рычаг подвески

G/L D/R

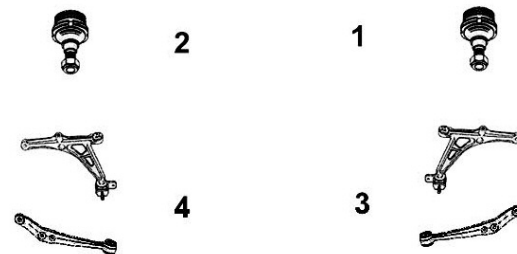

7476220
 OE 30635229

Triangle de susp. G
Left track control arm

4 sans rotule Without tie rod end

Sauf roue 16.5 pouces -ch 626501



2.0i Turbo	09/00-
2.3i Turbo	09/00-
2.4i /Turbo /4WD	06/04-
2.4 TDi	06/04-
2.5i Turbo /4WD	01/03-

7476219
 OE 30635230

Triangle de susp. D
Right track control arm





3 sans rotule Without tie rod end

Sauf roue 16.5 pouces -ch 626501



2.0i Turbo	09/00-
2.3i Turbo	09/00-
2.4i /Turbo /4WD	06/04-
2.4 TDi	06/04-
2.5i Turbo /4WD	01/03-

... S60

7476043 OE 31317661	Triangle de susp. G <i>Left track control arm</i>	7476042 OE 31317662	Triangle de susp. D <i>Right track control arm</i>
	4 Avec rotule With ball joint 1.6i Turbo 11/10- 2.0i Turbo 04/10- 2.0 D3 04/10- 2.4 TDi /4WD 04/10- 3.0i Turbo 4WD 04/10-		3 Avec rotule With ball joint 1.6i Turbo 11/10- 2.0i Turbo 04/10- 2.0 D3 04/10- 2.4 TDi /4WD 04/10- 3.0i Turbo 4WD 04/10-
9005582 OE 274548	Rotule de susp. G/D <i>L/R suspension ball joint</i>	7576038 OE 31201485	Rotule de susp. inf. G/D <i>L/R lower suspension ball joint</i>
	1 M12 x 1.75 2 TT /all models -ch 626501 09/00-04/10	 NEW	1 M14 x 1.5 2 TT /all models Ch- 626502 09/00-04/10

VOLVO



V50 ...

Eléments DIRECTION

Steering parts

Elementos Direcciones

Elementy uklad kierowniczy

Элементы рулевой системы

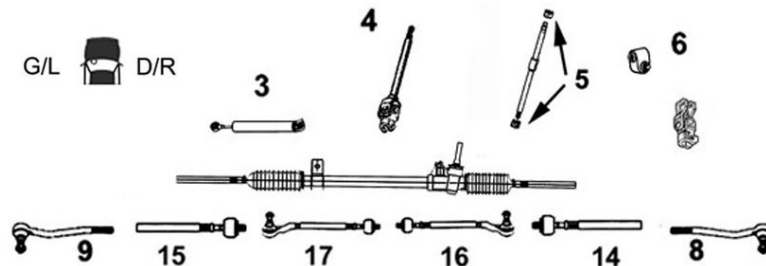

9006839

OE 31201817

Axe de bielle G/D

L/R axial joint



14 Côté dir. M14x1.5 Côté rot. M16x1.5 long 288 mm
15

1.6i 16v.	11/04-
1.6 D	11/04-
1.8i 16v.	01/04-
2.0i 16v.	09/06-
2.0 D	01/04-06/07
2.0 TD	06/07-
2.4i 20v.	01/04-
2.4 TDi 20v.	02/06-
2.5i 20v. Turbo /4WD	01/04-



Barre stabilisatrice

Stabilizer bar

Barra estabilizadora

Drażek stabilizatora

стабилизатор поперечной устойчивости

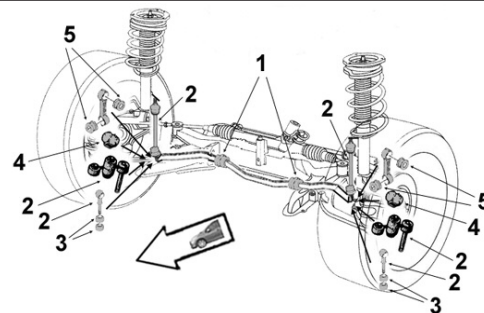

2306024

OE 8623576

Biellette barre stab.

Stabilizer bar stub axle



2	1.6i 16v.	BVM	01/05-
	1.6 D		01/05-
	1.8i 16v.	BVM	04/04-
	2.0i 16v.		09/06-
	2.0 TD		04/04-
	2.4i 20v.		04/04-
	2.4 TD		03/06-
	2.5i 20v. Turbo /4WD		04/04-

... V50 ...



Eléments SUSPENSION
Suspension parts
Elementos suspensión
Elementy zawieszenie
Элементы подвески

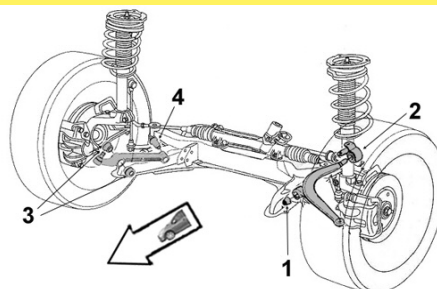

VOLVO



2256020

OE 30714128

Articulation AV

Front bush



1 Ø int. 14 Ø ext. 41 coll. 45.5
 long. tube int. 65 ext 31.5
 1.6i 16v. BVM 11/04-
 1.6 D 11/04-
 1.8i 16v. BVM 01/04-
 2.0 D BVM 01/04-06/07
 2.0 TD FAP BVM 06/07-
 2.0 TDCi BVM 10/08-
 2.4i 20v. 01/04-
 2.5i 20v. Turbo BVM 01/04-06/07

2256021

OE -

Articulation AR

Rear bush



2 Ø int.22
 1.6i 16v. BVM 11/04-
 1.6 D 11/04-
 1.8i 16v. BVM 01/04-
 2.0 D BVM 01/04-06/07
 2.0 TD FAP BVM 06/07-
 2.0 TDCi BVM 10/08-
 2.4i 20v. 01/04-
 2.5i 20v. Turbo BVM 01/04-06/07

Bras & Triangle de suspension

Control arm
Brazo y triángulo
Wahacz
Рычаг подвески

G/L D/R



9005814

OE 31277464

Triangle de susp. G

Left track control arm



4 Avec rotule With ball joint Cône Ø 15 - Ø 18
 -ch 214682
 1.6i 16v. 11/04-
 1.6 D /FAP 11/04-
 1.8i 16v. /ETH 01/04-
 2.0i 16v. /ETH 09/06-
 2.0 D /D3 01/04-
 2.0 D D4 07/10-
 2.0 TD FAP 06/07-
 2.0 TDCi FAP 10/08-
 2.4i 20v. 01/04-
 2.4 TDi 20v. /FAP 02/06-
 2.5i 20v. Turbo /4WD 01/04-

9005813

OE 31277465

Triangle de susp. D

Right track control arm



3 Avec rotule With ball joint Cône Ø 15 - Ø 18
 -ch 214682
 1.6i 16v. 11/04-
 1.6 D /FAP 11/04-
 1.8i 16v. /ETH 01/04-
 2.0i 16v. /ETH 09/06-
 2.0 D /D3 01/04-
 2.0 D D4 07/10-
 2.0 TD FAP 06/07-
 2.0 TDCi FAP 10/08-
 2.4i 20v. 01/04-
 2.4 TDi 20v. /FAP 02/06-
 2.5i 20v. Turbo /4WD 01/04-

7476192

OE 31277463

Triangle de susp. G

Left track control arm



NEW
4 Avec rotule With ball joint Cône Ø 18- Ø 21
Ch-214683
 1.6i 16v. 11/04-
 1.6 D /FAP 11/04-
 1.8i 16v. /ETH 01/04-
 2.0i 16v. /ETH 09/06-
 2.0 D /D3 01/04-
 2.0 D4 06/10-
 2.0 TD FAP 06/07-
 2.0 TDCi FAP 10/08-
 2.4i 20v. 01/04-
 2.4 TDi 20v. FAP 02/06-
 2.5i 20v. Turbo /4WD 01/04-

7476193

OE 31277462

Triangle de susp. D

Right track control arm



NEW
3 Avec rotule With ball joint Cône Ø 18- Ø 21
Ch-214683
 1.6i 16v. 11/04-
 1.6 D /FAP 11/04-
 1.8i 16v. /ETH 01/04-
 2.0i 16v. /ETH 09/06-
 2.0 D /D3 01/04-
 2.0 D4 06/10-
 2.0 TD FAP 06/07-
 2.0 TDCi FAP 10/08-
 2.4i 20v. 01/04-
 2.4 TDi 20v. FAP 02/06-
 2.5i 20v. Turbo /4WD 01/04-

... V50

VOLVO



9005527 **Rotule de susp. G/D**
 Part/oe 31277464 *L/R suspension ball joint*



1 Cône Ø 15 - Ø 18 -ch 214682
2

1.6i 16v.	11/04-	2.0 TD FAP	06/07-
1.6 D /FAP	11/04-	2.0 TDCi FAP	10/08-
1.8i 16v. /ETH	01/04-	2.4i 20v.	01/04-
2.0i 16v. /ETH	09/06-	2.4 TDi 20v. /FAP	02/06-
2.0 D /D3	01/04-	2.5i 20v. Turbo /4WD	01/04-
2.0 D4	06/10-		

7576041 **Rotule de susp. G/D**
 Part/oe 31277462 *L/R suspension ball joint*

NEW



1 Cône Ø 18 - Ø 21 Ch-214683
2

1.6i 16v.	11/04-	2.0 TD FAP	06/07-
1.6 D /FAP	11/04-	2.0 TDCi FAP	10/08-
1.8i 16v. /ETH	01/04-	2.4i 20v.	01/04-
2.0i 16v. /ETH	09/06-	2.4 TDi 20v. FAP	02/06-
2.0 D /D3	01/04-	2.5i 20v. Turbo /4WD	01/04-
2.0 D4	06/10-		

V60 ...

Eléments DIRECTION
Steering parts
Elementos Direcciones
Elementy uklad kierowniczy
Элементы рулевой системы

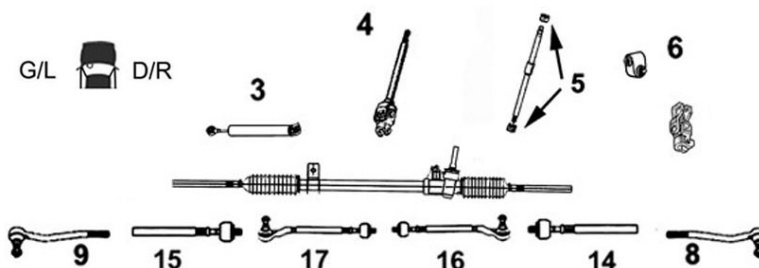

7776025 **Axe de bielle G/D**
 Part/oe 31280658 *L/R axial joint*



14 Côté dir. M16x1.5 Côté rot. M18x1.5 long 315 mm
15

1.6i Turbo	09/10-
2.0i Turbo	09/10-
2.0 D	09/10-
2.4 TDi /4WD	09/10-
3.0i Turbo 4WD	09/10-

7676025 **Rotule de direction G**
 OE 31302344 *Left tie rod end*



9 M18 x 1.5

1.6i Turbo	09/10-
2.0i Turbo	09/10-
2.0 D3	09/10-
2.4 TDi D5 /4WD	09/10-
3.0i Turbo 4WD	09/10-

7676024 **Rotule de direction D**
 OE 31302345 *Right tie rod end*



8 M18 x 1.5

1.6i Turbo	09/10-
2.0i Turbo	09/10-
2.0 D3	09/10-
2.4 TDi D5 /4WD	09/10-
3.0i Turbo 4WD	09/10-

... V60

Bras & Triangle de suspension

Control arm
Brazo y triángulo
Wahacz
Рычаг подвески

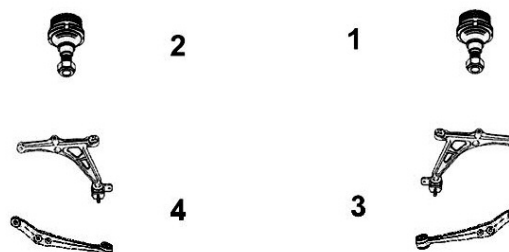
G/L  D/R**7476043****Triangle de susp. G**

OE 31317661

*Left track control arm***4** Avec rotule *With ball joint*

1.6i Turbo	09/10-
2.0i Turbo	09/10-
2.0 D3	09/10-
2.4 TDi D5 /4WD	09/10-
3.0i Turbo 4WD	09/10-

7476042**Triangle de susp. D**

OE 31317662

*Right track control arm***3** Avec rotule *With ball joint*

1.6i Turbo	09/10-
2.0i Turbo	09/10-
2.0 D3	09/10-
2.4 TDi D5 /4WD	09/10-
3.0i Turbo 4WD	09/10-

S70 V70 ...

Éléments DIRECTION

Steering parts
Elementos Direcciones
Elementy układ kierowniczy
Элементы рулевой системы

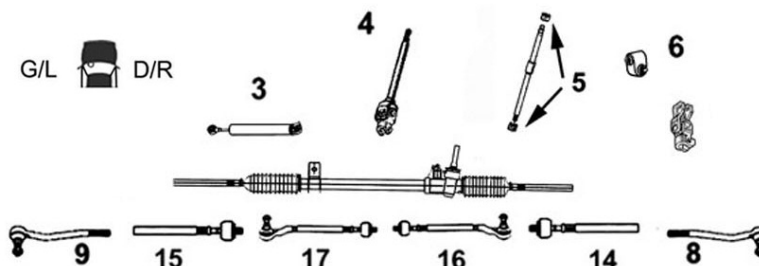
G/L  D/R**9006879****Axe de bielle G/D**

OE 274353

*L/R axial joint***14** Côté dir. M16x1.5 Côté rot. M14x1.5
15 long 124 mm

2.3i T5 V70	-12/03
2.4i V70 /Turbo /4WD	-06/07
2.5i Turbo /4WD V70	-12/03

OE 274179

2.4 TDi 2.0v. /4WD V70	-04/05
2.5 TDi V70	02/00-12/00

7776025**Axe de bielle G/D**

OE Part/oe 31280658

*L/R axial joint***14** Côté dir. M16x1.5 Côté rot. M18x1.5
15 long 315 mm

1.6 D V70	09/09-
2.0i Turbo V70	10/07-
2.0 D V70	06/10-
2.0 TD V70	10/07-
2.4 TDi V70 /4WD	03/07-
2.5i Turbo V70	03/07-
3.0i Turbo 4WD V70	03/07-
3.2i V70 /4WD	10/07-

9006612**Rotule de direction G**

OE 271598

*Left tie rod end***9** M14 x 2

2.0i	-02/00
2.3i 20v. Turbo T5/4WD	-02/00
2.4i 20v. Turbo /4WD	-02/00
2.5i /Turbo	-02/00
2.5 TDi	-02/00

9006611**Rotule de direction D**

OE 271599

*Right tie rod end***8** M14 x 2

2.0i	-02/00
2.3i 20v. Turbo T5/4WD	-02/00
2.4i 20v. Turbo /4WD	-02/00
2.5i /Turbo	-02/00
2.5 TDi	-02/00

9006614**Rotule de direction G**

OE 274175

*Left tie rod end***9** M14 x 1.5

2.3i 20v. Turbo T5	03/00-06/04
2.4i 20v. /Turbo	03/00-08/07
2.4 TDi 20v. /D5 /4WD	03/00-08/07
2.5i 20v. Turbo /4WD	03/00-08/07

OE 30761719

2.5 TDi	03/00-12/00
---------	-------------

9006613**Rotule de direction D**

OE 274176









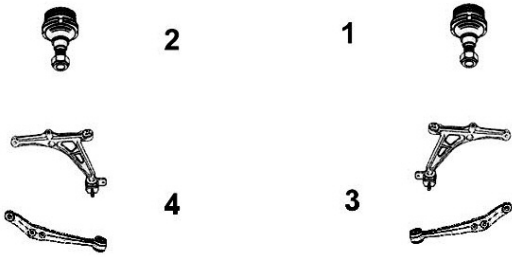

*Right tie rod end***8** M14 x 1.5

2.3i 20v. Turbo T5	03/00-06/04
2.4i 20v. /Turbo	03/00-08/07
2.4 TDi 20v./D5 /4WD	03/00-08/07
2.5i 20v. Turbo /4WD	03/00-08/07

OE 30761718

2.5 TDi	03/00-12/00
---------	-------------

... S70 V70 ...

7676025 OE 31302344	Rotule de direction G <i>Left tie rod end</i>	7676024 OE 31302345	Rotule de direction D <i>Right tie rod end</i>
	9 M18 x 1.5 1.6 D V70 09/09- 2.0i 16v. /Turbo V70 10/07- 2.0 D3 V70 06/10- 2.0 TD FAP V70 10/07- 2.4 TDi /D5 /Turbo V70 03/07- 2.5i 20v. Turbo V70 03/07- 3.0i Turbo 4WD V70 03/07- 3.2i /4WD V70 03/07-		8 M18 x 1.5 1.6 D V70 09/09- 2.0i 16v. /Turbo V70 10/07- 2.0 D3 V70 06/10- 2.0 TD FAP V70 10/07- 2.4 TDi /D5 /Turbo V70 03/07- 2.5i 20v. Turbo V70 03/07- 3.0i Turbo 4WD V70 03/07- 3.2i /4WD V70 03/07-
Bras & Triangle de suspension <i>Control arm</i> <i>Brazo y triángulo</i> <i>Wahacz</i> <i>Рычаг подвески</i>		G/L  D/R	
9005788 OE 8628497	Triangle de susp. inf. G <i>ower left track control arm</i>	9005787 OE 8628498	Triangle de susp. inf. D <i>Lower right track control arm</i>
	4 Avec rotule With ball joint 2.0i V70 -02/00 2.3i 20v. Turbo T5 /4WD -05/04 2.4i 20v. turbo V70 /4WD -02/00 2.5i 20v. Turbo -05/04 2.5 TDi -05/04		3 Avec rotule With ball joint 2.0i V70 -02/00 2.3i 20v. Turbo T5 /4WD -05/04 2.4i 20v. turbo V70 /4WD -02/00 2.5i 20v. Turbo -05/04 2.5 TDi -05/04
9005786 OE 8628495	Triangle de susp. inf. G <i>Lower left track control arm</i>	9005784 OE 8628496	Triangle de susp. inf. D <i>Lower right track control arm</i>
	4 Avec rotule With ball joint 2.0i -05/04 2.3i 20v. Turbo V70 /4WD -02/00 2.4i 20v. Turbo V70 /4WD -02/00 2.5i -05/04		3 Avec rotule With ball joint 2.0i -05/04 2.3i 20v. Turbo V70 /4WD -02/00 2.4i 20v. Turbo V70 /4WD -02/00 2.5i -05/04
7476220 OE 30635229	Triangle de susp. G <i>Left track control arm</i>	7476219 OE 30635230	Triangle de susp. D <i>Right track control arm</i>
	4 sans rotule Without tie rod end Sauf roue 16.5 pouces -ch 645617 -ch647151 2.4i V70 06/00- 2.4 TDi V70 04/05- 2.5i V70 04/05-		3 sans rotule Without tie rod end Sauf roue 16.5 pouces -ch 645617 -ch647151 2.4i V70 06/00- 2.4 TDi V70 04/05- 2.5i V70 04/05-
7476043 OE 31277343	Triangle de susp. G <i>Left track control arm</i>	7476042 OE 31277344	Triangle de susp. D <i>Right track control arm</i>
	4 Avec rotule With ball joint 1.6 D V70 09/09- 2.0i 16v. /Turbo V70 10/07- 2.0 D3 V70 06/10- 2.0 TD FAP V70 10/07- 2.4 TDi /D5 FAP V70 03/07- 2.5i 20v. Turbo V70 03/07- 3.0i Turbo 4WD V70 03/07- 3.2i / 4WD V70 10/07-		3 Avec rotule With ball joint 1.6 D V70 09/09- 2.0i 16v. /Turbo V70 10/07- 2.0 D3 V70 06/10- 2.0 TD FAP V70 10/07- 2.4 TDi /D5 FAP V70 03/07- 2.5i 20v. Turbo V70 03/07- 3.0i Turbo 4WD V70 03/07- 3.2i / 4WD V70 10/07-

VOLVO



... S70 V70

Bras & Triangle de suspension

Control arm
Brazo y triángulo
Wahacz
Рычаг подвески

G/L  D/R**9005582****Rotule de susp. G/D**

OE 274548

L/R suspension ball joint**1**
2 M12 x 1.75

TT /all models V70 -ch FC1-647148 -ch FC2-645617

02/00-06/07

7576038**Rotule de susp. inf. G/D**

OE 31201485

L/R lower suspension ball joint

NEW

**1**
2 M14 x 1.5

TT /all models V70 Ch FC1-647149 ch- FC2-645618

02/00-06/07

S80 ...

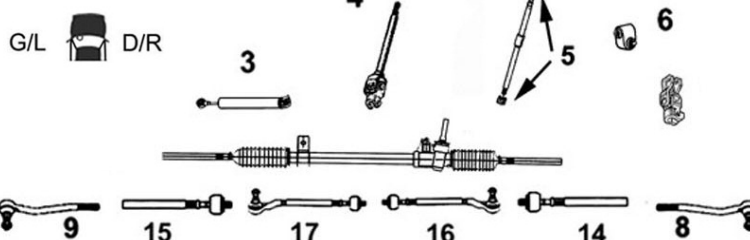
Eléments DIRECTION*Steering parts**Elementos Direcciones**Elementy układ kierowniczy**Элементы рулевой системы***9006879****Axe de bielle G/D**

OE 274179

L/R axial joint**14**
15 Côté dir. M16x1.5 Côté rot. M14x1.5 long 124 mm2.4i 20v.
2.4 TDi
3.0 /Turbo**9006614****Rotule de direction G**

OE 30761719

Left tie rod end**9** M14 x 1.52.4i 20v.
2.4 TDi
3.0 /Turbo01/03-06/06
01/03-06/06
01/03-06/06**9006613****Rotule de direction D**

OE 30761718

Right tie rod end**8** M14 x 1.52.4i 20v.
2.4 TDi
3.0 /Turbo01/03-06/06
01/03-06/06
01/03-06/06

... S80

Bras & Triangle de suspension

Control arm
Brazo y triángulo
Wahacz
Рычаг подвески

G/L  D/R

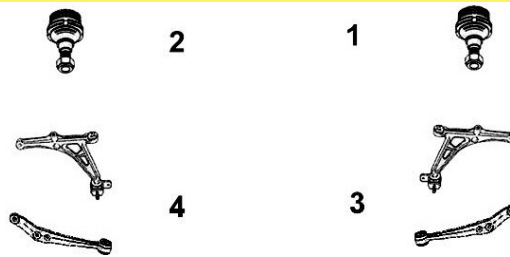

7476043

Triangle de susp. G

OE 31277343

Left track control arm



4 Avec rotule With ball joint

2.4 TDi 20v.	06/06-06/09
2.5i 20v. Turbo	06/06-06/09
3.2i/ 4WD	06/06-06/09
4.4i 4WD	06/06-06/09

7476042

Triangle de susp. D

OE 31277344

Right track control arm



3 Avec rotule With ball joint

2.4 TDi 20v.	06/06-06/09
2.5i 20v. Turbo	06/06-06/09
3.2i/ 4WD	06/06-06/09
4.4i 4WD	06/06-06/09

9005582

Rotule de susp. G/D

OE 274548

L/R suspension ball joint



1
2 M12 x 1.75

TT /all models

07/98-06/06

XC60

Eléments DIRECTION

Steering parts
Elementos Direcciones
Elementy układ kierowniczy
Элементы рулевой системы

G/L  D/R

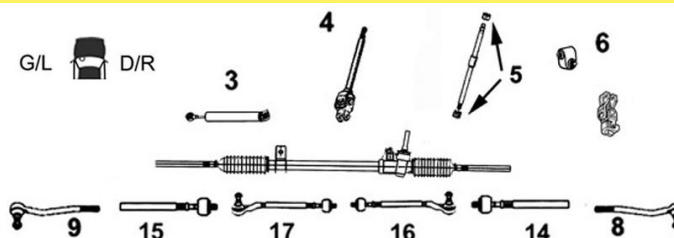

7676025

Rotule de direction G

OE 31302344

Left tie rod end



9 M18 x 1.5

2.4 TDi 20v. /D5 /4WD	10/08-
3.0i Turbo 4WD	10/08-
3.2i 4WD	04/09-

7676024

Rotule de direction D

OE 31302345

Right tie rod end



8 M18 x 1.5

2.4 TDi 20v. /D5 /4WD	10/08-
3.0i Turbo 4WD	10/08-
3.2i 4WD	04/09-

XC70 ...

Eléments DIRECTION

Steering parts
Elementos Direcciones
Elementy układ kierowniczy
Элементы рулевой системы

G/L  D/R

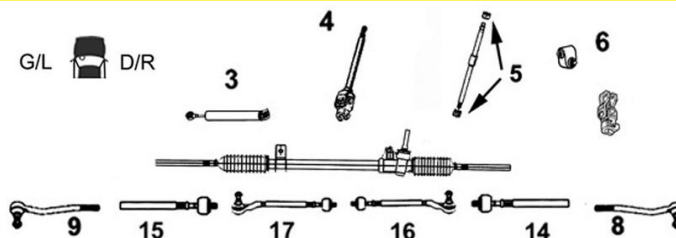

9006879

Axe de bielle G/D

OE 274179

L/R axial joint



14 Côté dir. M16x1.5 Côté rot. M14x1.5
15 long 124 mm

2.4i 20v.	05/02-12/02
2.4 TDi	05/02-03/07
2.5i 20v.	01/03-03/07

7776025

Axe de bielle G/D

Part/oe 31280658

L/R axial joint



14 Côté dir. M16x1.5 Côté rot. M18x1.5
15 long 315 mm

2.4 TDi /4WD	03/07-
3.2i 4WD	03/07-

... XC70

Eléments DIRECTION

Steering parts

Elementos Direcciones

Elementy układ kierowniczy

Элементы рулевой системы

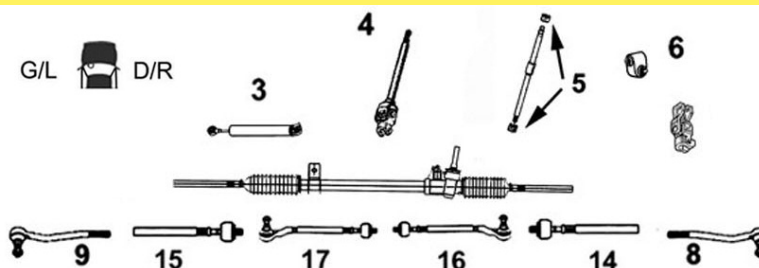
**7676025****Rotule de direction G**

OE 31302344

Left tie rod end**9 M18 x 1.5**2.4 TDi 20v. /4WD
3.0i Turbo 4WD
3.2i 4WD10/07-
12/08-
03/07-12/08**7676024****Rotule de direction D**

OE 31302345

Right tie rod end**8 M18 x 1.5**2.4 TDi 20v. /4WD
3.0i Turbo 4WD
3.2i 4WD03/07-
12/08-
03/07-12/08**Bras & Triangle de suspension**Control arm
Brazo y triángulo
Wahacz
Рычаг подвески

G/L D/R

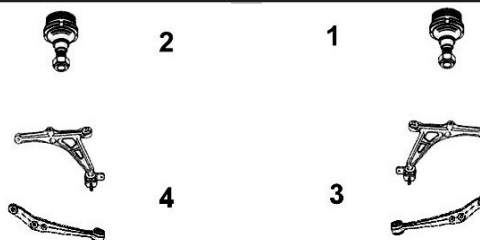
**9005582****Rotule de susp. G/D**

OE 274548

L/R suspension ball joint**1/2 M12 x 1.75**

TT /all models -ch 269745 05/02-03/07

7576038**Rotule de susp. inf. G/D**

OE 31201485

L/R lower suspension ball joint**1/2 M14 x 1.5**

TT /all models Ch- 269746 05/02-03/07

XC90

Eléments DIRECTION

Steering parts

Elementos Direcciones

Elementy układ kierowniczy

Элементы рулевой системы

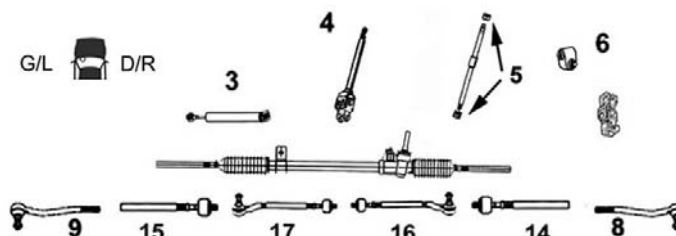
**9006879****Axe de bielle G/D**

OE 274179

L/R axial joint**14/15** Côté dir. M16x1.5 Côté rot. M14x1.5 long 124 mm2.4 TDi
2.5i 20v.
3.2i
4.406/06-
06/06-12/06
06/06-
06/06-**Bras & Triangle de suspension**Control arm
Brazo y triángulo
Wahacz
Рычаг подвески

G/L D/R

**7576038****Rotule de susp. inf. G/D**

OE 31201485

L/R lower suspension ball joint**1/2 M14 x 1.5**

TT /all models



CORRESPONDANCE ORIGINE ⇨ SASIC CROSSING LIST O.E ⇨ SASIC

MARQUE Make	OE	SASIC		MARQUE Make	OE	SASIC		
ALFA ROMEO	46474556	9005149	3 5 20 23	AUDI	1K0511353J	2656043	48	
	46474557	9005148	3 5 20 23		1K0511353M	2656049	48	
	46843389	9005031	9 10 19		1K0513353H	9005631	48	
	50509340	9005663	7 11 18		1K0513353R	2656059	47	
	510615	9006404	1 16		3C0407151G			
	51787336	7476195	12 17 23		+1K0407365C	7476180	88	
	51787337	7476194	12 17 23		3C0407151G			
	51834093	9005661	6 10 18		+1K0407366C	7476179	88	
	51834094	9005660	6 10 18		1J0407151C			
	51842924	7476197	12 17 23		+1J0407365H	7476118	41	
	51842925	7476198	12 17 23		1J0407151C			
	51895366	7470006	21		+1J0407366H	7476119	41	
	51895367	7470005	21		1K0407151AC			
	55700753	2306023	21		+1K0407365C	7476128	41	
	55701901	2656040	22		1K0407152AD			
	55701902	2656041	22		+1K0407366C	7476127	41	
	60501401	9005146	1 16		1K0407365C			
	60507910	9006240	13		+ 1K0407151P	7476095	41	
	60511622	9006339	13		1K0407366C			
	60521320	9006405	1 2		+ 1K0407152P	7476097	41	
	60570627	9005082	2 4 8 19		6R0407151F			
	60570731	9005634	3 5 8		+6R0407365A	7476183	32	
	60570732	9005636	3 5 8		6R0407152F			
	60586771	9005149	8		+6R0407366A	7476184	32	
	60588843	9005151	13		357407182	9001523	32 39	
	60588844	9005150	13		357413175A	9005327	33 45	
	60613575	9005022	7 11 18		3C0407151G	7476038	88	
	60625029	9005031	6		3C0407365A	7576007	42	
	60628255	9005023	15		3C0407366A	7576005	42	
	60628284	9005024	15		431505172	9001546	27 30 73	
	60630757	9005020	14		437407152A	9005158	30 31	
	60666020	9005664	15		437407156A	9005158	52	
	60666021	9005666	15		443419811D	9006302	29 31 50 71	
	60686892	9005662	7 11 18		443419812D	9006301	29 31 50 71	
	60695895	7476015	15		4A0407151	9005161	52 72	
	60695896	7476014	15		4A0407152	9005160	52 72	
	60724204	9006238	1 2		4A0407181A	9001544	30 72	
	60801528	9005151	13		4A0407183D	9001545	30 72	
	60801529	9005150	13		4A0411327A	9001742	71	
	60809814	9005148	8		4A0411327F	9001798	71	
	7601502	8005206	3 5 9		4A0412249	8005208	72	
	7601642	9001502	2 4		4A0419811A	9006304	50	
	77363706	7676061	12 16 23		4A0419812A	9006303	50	
	77363707	7676060	12 16 23		4A0511247	9003102	73	
	77363829	7676014	20		4B0407515	9001758	57 74 85	
	77363830	7676013	20		4B0419811F	9006413	50 73 84	
	7760424	9001728	4 8		4B0422821	9006247	50 73 84	
	7760425	9001729	3 4		4B0501521E	9001773	77	
	82388433	9003100	13		4B0501522E	9001774	77	
	9947436	9006335	7		4B0511327	2306105	61 77	
	9947437	9006334	7		4B3407151K	7476033	76	
	9947719	9006654	2 7 19 22		4D0407151P	9005157	53 76 86	
	9947919	9006647	6 9 14 17		4D0407181H	9001538	52 74 85	
	9947920	9006648	6 9 14 17		4D0407182G	9001539	52 57 74 85	
	9948297	7776019	14		4D0407183AC	9001540	74 85	
	Part/oe 51783056	2256032	21		4D0407183M	9001540	52 57	
	Part/oe 51895367	7570004	22		4D0407183Q	9001540	58	
	Part/oe 55700751	2256009	21		4D0407509J	9005749	75 85	
			4D0407510G	9005750	75			
			4D0407510J	9005750	85			
			4D0407515C	9001543	52			
			4D0411317K	2306011	51			
			4D0411327E	9001547	51			
			4D0411327H	9001547	64 68 83 84			
			4D0411327I	9001548	51 74 84			
			4D0411327J	9001740	56 78			
			4D0412377F	9001710	53 76			
			4D0422821A	7776081	73			
			4E0407505E	7476208	80 86			
			4E0407506E	7476209	80 86			
			4E0407509H	7476204	79 85			
			4E0407510H	7476205	79 85			
			4F0407151A	7476201	80			
			4F0407183A	2256005	79			
			4F0407183C	2256005	58			
			4F0407183E	2256005	58			
			4F0407693H	7476199	80			
			4F0407694H	7476200	80			
			4F0422821D	7776077	78			
			4F0498811A	7676051	51 55 73 78			
			4H0422810A	7776078	63 67 90 93			
			6N0413175A	2656053	34 45 89 96			
			6Q0411314Q	2306018	31			
			6Q0411315N	9005089	31			
			6R0407151F	7476091	32			
			6R0407152F	7476092	32			
			6R0407365A	7576019	32			
			6R0407366A	7576020	32			
			6R0501541A	2606001	49			
			7L0407021B	7476034	93			
			7L0422817D	7676022	93			
			7L0422818D	7676021	93			
			811407181A	9001503	25			
			811411327A	9001504	24			
			811419812A	9006300	24 28			
			811511247	9001552	27			
			823407365E	9005200	25 28			
			823411313A	9001505	24			
			855407365A	9005201	25 29			
			893407365A	9005209	26 29			
			893407365E	9005516	26 29			
			893407365F	9005203	26 28			
			893407366A	9005208	26 29			
			893407366E	9005517	26 29			
			893407366F	9005204	26 28			
			893411327E	9001762	24			

Cross OE > SASIC



CORRESPONDANCE ORIGINE ⇨ SASIC
CROSSING LIST O.E ⇨ SASIC

MARQUE Make	OE	SASIC	📄	MARQUE Make	OE	SASIC	📄
AUDI	893412131B	9005324	27	BMW	31126777851	9005683	118 162
	8A0407181	9001506	25		31126777852	9005682	118 162
	8A0407365	9005206	26		31129058815	9001555	109
	8A0407366	9005207	26		31129059288	9001777	112
	8A0407465	9005087	24		31129068753	9001565	141
	8A0501541	9001553	27		31303414299	2306059	156
	8D0407509G	9005747	53		31303414300	2306058	156
	8D0407510G	9005748	53		31306781547	2306064	144 148
	8D0411317D	9005086	51 74		31306781548	2306063	144 148
	8D0411318D	9005096	51 74		31331091709	9005629	142
	8D0412131E	2656009	60 76		31331091868	2656033	143
	8D0412131F	9005326	53 60 76 81 86		31331139452	9001420	110 138
	8D0501530	7476158	54		31336750892	2656020	119
	8D0501541A	9001764	54		31336752735	9001422	100
	8D0501541D	9001554	54		31336760943	9001422	125 129
	8D0512333	9001549	54		31336770568	9001422	103 106 119 142 146 150
	8E0407151R	7476019	60		31336770568	9001422	155 158
	8E0407181C	2256004	57 91		31336771352	2656044	125 126 133
	8E0407505A	9005140	53 59 75		31351091764	9005053	108 111
	8E0407506A	9005141	53 59 75		31351095661	9005054	141
	8E0407509A	9005749	58		31351095662	9005056	141
	8E0407509P	7476206	59		31351127414	9001566	108
	8E0407510A	9005750	58		31351129139	9001567	108
	8E0407510P	7476207	59		31351133738	9001573	138
	8E0407693AG	9005156	53 59 75 86		31351134582	9005058	111 138
	8E0407693AL	7476202	59		31351135805	9001568	138
	8E0407694AG	9005154	53 59 75 86		31351140193	9001574	138
	8E0407694AL	7476203	59		31356761591	2306108	145 148
	8E0411317	9005069	56		31356765933	2306062	99 102 105 124 128 132
	8E0411318	9005068	56		31356765933	2306062	135 154 161
	8E0411811B	9006413	55		31356765934	2306061	99 102 105 124 128 132
	8E0412377C	9005620	60		31356765934	2306061	135 154 161
	8E0422821C	7776081	55		31356780847	9005057	116 117
	8E0505145AP	9003101	62		32106765089	7676017	99 102 105 123 127 131
	8E0505145AR	9001746	62		32106765089	7676017	134 153 161
	8E0505203D	9001776	62 81		32106765090	7676015	99 102 105 123 127 131
	8E0505465AF	2306012	61		32106765090	7676015	134 153 161
	8E0511327A	2306104	61		32106774220	9006429	116 161
	8E0513353B	9005621	77		32106774221	9006428	116 161
	8K0407151D	7476124	66 70 82 83 91		32106776946	7676018	144 147 150 151 152 153
	8K0407152D	7476125	66 70 82 83 91		32106793621	7776080	123 127 131 153
	8K0407182B	2256054	65 69 91		32106793623	7676062	123 127 131 153
	8K0407183A	2256053	65 69 91		32106793624	7676063	123 127 131 153
	8K0407505A	7476135	65 69		32111126757	9006320	108
	8K0407506A	7476189	65 69		32111130449	9006253	108
	8K0407509A	7476137	65 69		32111130451	9006254	108
	8K0407510A	7476188	65 69		32211096327	9006430	159
	8K0407515	2256052	65 69		32211135666	9006255	137 152
	8K0407689G	7576018	66 70 82 83 92		32211135819	9006323	137 152
	8K0407693N	7476227	66 70 91		32211135820	9006324	137 152
	8K0407694N	7476225	66 70 91		32303418202	7676057	156
	8K0411327A	2306118	64 68 81		32413413476	7676057	159 160
	8K0411327B	2306107	68 81 83 84		33171093008	9001418	143
	8K0411327C	2306109	90		33171134872	9001419	114
	8K0422817B	7676052	63 68 90		33171135242	9001417	111
	8K0422818B	7676053	63 68 90		33306786980	2606010	159
	8K0505145B	2606007	67 71		33311091422	9001556	143
	8K0505145C	2606008	67 71		33311128670	9001558	140
	8K0512131	2656050	67 82 92		33311129144	9001557	110
	8K0513353E	2656042	67 70 92		33316770781	9003110	122
	8R0407515	2256051	91		33316770783	9001792	122
	8Z0423811A	9006634	33		33316770784	9001790	122
	8Z0423812A	9006635	33		33321092247	9001563	113 114 121 158
Part/oe 1J0422803A	9006213	34	33326770786	9001414	114 121 122 159		
Part/oe 1J0422803H	9006219	35	33326770824	9001564	114 121 158		
Part/oe 7L0422803D	7776024	92	33326771828	9001559	114 121 159		
Part/oe 811419801E	9006244	24 28	33326775551	2256059	113 121 160 162		
Part/oe 811419802J	9006245	24 28	33326775552	9001778	101 104 107 129 130 134		
BMW	31103418341	7576023	157	33326775552	9001778	136 155	
	31103438623	7576029	157	33329061945	9001560	110	
	31103443127	7476144	157	33503414297	2306060	158	
	31103443128	7476143	157	33506781540	2306065	147 150 151	
	31103451881	7476138	157	33531135624	9005351	139	
	31103451882	7476139	157	33551094619	9005030	120	
	31120305612	2256039	145 148	33551095532	9005059	143	
	31120307882	2256040	156	33551126932	9005060	110 113	
	31120393540	9003106	99 102 105 124 128 132	33551131155	9001570	113 139	
	31120393540	9003106	135	33551135307	9005061	113 139	
	31121094233	7476011	142	33551136491	9001572	120	
	31121094234	7476010	142	33551138104	9001572	113 139	
	31121123025	9005163	107	33556764428	9005029	101 104 107 126 130 133	
	31121123026	9005162	107	33556764428	9005029	136	
	31121126253	9005221	109	Part/oe 31126757623	9003108	117	
	31121126254	9005220	109	Part/oe 31126757623	9003109	117	
	31121127725	9005166	109	Part/oe 32106765236	7776018	98 101 104 123 127 131	
	31121127726	9005164	109	Part/oe 32106765236	7776018	134 161	
	31121139131	9005223	112	Part/oe 32106777479	7776020	144 147 150 151	
	31121140398	9005222	112	Part/oe 32106777503	9006817	115 161	
	31121141717	7476025	142	Part/oe 32111094673	9006423	140	
	31121141718	7476024	142	Part/oe 32111094674	9006422	140	
	31126758510	9005222	112	Part/oe 32111094674	9006818	140	
	31126758513	7476021	112 160	Part/oe 32111139316	9006257	111	
	31126758514	7476020	112 160	Part/oe 32211095956	9006257	115	
	31126768297	7476028	145 149	Part/oe 32216751277	9006819	115 159	
	31126768298	7476027	145 149	Part/oe 32216762244	9006811	98 101 104 123 127 131	
	31126768988	7576030	125 129 133 154	Part/oe 32216762244	9006811	134 153	
	31126769797	7476009	100 103 106 125 129 133	CHEVROLET	13278358	7776091	165
	31126769797	7476009	136 154 162		13278359	7676069	165 168
	31126769798	7476008	100 103 106 125 129 133		13334023	7476214	165
	31126769798	7476008	136 154 162		352492	7476215	165
	31126770849	7476093	100 103 106 124 128 132		48810A78B00000	7676023	167
	31126770849	7476093	135 154		521257	7776063	167
	31126770850	7476094	100 103 106 124 128 132		93740722	7676005	163 165
	31126770850	7476094	135 154		93740723	7676007	163 165
	31126774825	7476013	146 149		93741074	7776068	167
	31126774826	7476012	146 149		93741092	7776064	167

Les références constructeurs (origine) ne servent qu'à identifier les pièces et sont données à titre indicatif.
References from carmakers or OE suppliers, are given for identification of the parts and have only a guidance value.



CORRESPONDANCE ORIGINE ⇨ SASIC
CROSSING LIST O.E ⇨ SASIC

MARQUE Make	OE	SASIC		MARQUE Make	OE	SASIC	
CHEVROLET	95967285	7676107	168	CITROEN	352323	5233233	266
	96391875	2306074	163		352343	5233433	273
	96415063	7476162	166 168		352349	5233273UN	266 314
	96415064	7476161	166 168		352350	5233503	262
	96535089	7576003	164 166		352351	5233513	262
	96611265	7476041	167		352352	5233523	262
	96819161	7476171	164		352357	5233573	273
	96819162	7476170	164		352375	5233623	176 277 293 300
	96870465	7476040	163 166		352381	2005258	270
	96870466	7476039	163 166		352382	2005259	270
	Part/oe 96626236	7576047	164		352383	5233833	176 288 300
					352384	5233843	232
					352391	5233913	176 218 226 249 299
					352392	5233923	176 218 226 249 252 300
					352393	5233933	324
	CITROEN	1607502480	7670018		223	352394	8003204
	1607510680	7470015	244	352398	5233983	194 201 213	
	1607510780	7470014	244	352399	5233993	195 202	
	1607690980	2650034	330	3523AA	5233AA3	194 201 213	
	1607691280	2650033	330	3523AC	5233AC3	277	
	1608652180	7770015	188	3523AG	2250001	194	
	1609274680	2650032	259 342	3523AQ	2250002	233 240	
	1609274780	2650031	259 342	3523AR	5233AR3	233	
	1609948280	7670015	229	3523AT	2250017	202	
	1609948380	7670014	229	3523AZ	2250014	232 240	
	1610817780	7670019	228	3523CA	2250019	231 240	
	1610817880	7670021	228	3523CS	2250021	187 224	
	1610976380	7670002	323	3523CW	2250018	252	
	1610976480	7670001	323	356108	5613083	318	
	3520H5+364043	7470017	177 278 293 302	359905	1003560	172	
	3520H5+364051	7470019	178 279 288 302	364017	6403183	320	
	3521E5+364043	7470016	177 278 293 302	364021	6403213	186	
	3521E5+364050	7470018	178 279 288 302	364026	6403263	320	
	352041	5203413	319	364032	6403323	327	
	352051	5203513	267 315	364033	6403333	328	
	352054	5203543	267	364036	6403363	172 263	
	352076	5203763	319	364043	2005113	179 279 294 304	
	352077	5203773	319	364051	6403513	179 279 289 304	
	352078	5203783	171 262	364054	6403543	328	
	352079	5203793	171 262	364055	6403553	327	
	352092	5203923	171 263	364062	6403623	196 211	
	352093	5203933	171	364065	6403563	205 211 214	
	352095	5203953	325	364066	6403663	196 205	
	352096	5203963	326	364068	6403533	180 226 304	
	3520C2	5203C13	271	364069	7570003	236 241	
	3520H4	5203F73	278	364071	6403343	235 271 274	
	3520H5	5203F73	177 293	364072	6403723	241	
	3520J9	5203J33	278	364073	6403533	219 250 252	
	3520K7	5203F73	288	364074	6403573	235 241	
	3520L0	5203953	325	364076	7570001	329	
	3520L1	5203963	326	364077	7570008	189	
	3520N3	5203N33	326	364078	7570007	247	
	3520N4	5203N43	326	381215	8123153B1	256 265	
	3520P0	5203K33	233	381232	8123323B1	313	
	3520P4	5203943	254 336	381295	8123323B1	313	
	3520P6	5203P63	244	3812A4	3008069	253 334	
	3520P8	5203943	254	3812E2	8123E23	242	
	3520Q2	5203Q23	191 747	3812E4	7770009	174 287 297	
	3520Q5	5203J33	179 303	3812E5	8123E53	216	
	3520R0	5203T33	214	3812E6	7770018	199	
	3520R1	5203L43	203 214	3812E7	8123E73	239	
	3520R7	5203Q93	211	3812E8	8123E83	209	
	3520R8	7470001	337	3812E9	7770005	225	
	3520S0	7470008	327	3812F1	7770021	186	
	3520S2	5203K83	179 219 226 304 800 935	3812F2	7770002	216 248	
	3520S6	7470021	337	3812F6	7770001	199 246	
	3520V1	5203T33	195 204	3812F7	7770012	251	
	3520V2	7470003	219 250	3812F8	7770007	248	
	3520V3	5203J33	288	381711	8173113	318	
	3520V8	7470001	244	381732	3008074	260	
	3520W1	5203N63	234 240	381733	3008074	169	
	3520W7	7470026	203 247	381741	8173303	169 216 260 269 273	
	3520X6	7470028	235	381742	8173313	169 216 260 269 273	
	3520Y4	7470005	258 341	381743	8173433	269 273	
	352128	5213283	319	381744	8173443	269 273	
	352134	5213343	267 315	381747	3008077	169 260	
	352137	5213373	267	381750	8173183	175 216 256 265 279 287	
	352152	5213523	319	381750	8173183	291 313	
	352153	5213533	319	381755	8173553	193 199 213	
	352166	5213663	326	381756	8173563	193 199 213	
	352181	5213813	271	381759	8173533	228	
	3521E4	5213A73	278	381760	8173543	228	
	3521E5	5213A73	177 293	381763	8173633	190	
	3521F9	5213F33	278	381764	8173643	190	
	3521G3	5213G33	234	381765	7670005	239	
	3521G7	5213A73	288	381766	7670006	239	
	3521H2	5213653	325	381767	8173673	188 209	
	3521H3	5213663	326	381768	8173683	188 209	
	3521J2	5213Q43	214	381771	7670013	225	
	3521J3	5213J33	326	381772	7670012	225	
	3521J4	5213J43	326	381773	7670011	243 335	
	3521K4	5213643	254 336	381786	7670008	257 340	
	3521K6	5213K63	244	381787	7670009	257 340	
	3521L3	5213L33	191	381788	7670016	175 217 248 298	
	3521L9	5213F33	278	381789	7670017	175 217 248 298	
	3521N2	5213H63	203 214	381791	7670004	200 246	
	3521N8	5213N03	211	381792	7670003	200 246	
	3521N9	7470002	337	381794	7670022	251	
	3521P3	5213G83	179 219 226 304	4005A1	0054A14	268	
	3521P7	7470022	337	401144	0114444	174 275 291 313	
	3521R2	5213Q43	195 204	401165	0114654	174 287 296	
	3521R3	7470004	219 250	4018A3	0184H44	322	
	3521R4	5213F33	288 302 303	4018A4	3008070	322	
	3521S0	7470002	244	4018E0	0184E04	323	
	3521S4	5213J63	234 235 240	405909	0594094	253 335	
	3521S9	7470025	203 247	405912	0594124	243 335	
	3521T7	7470027	235				
	3521V5	7470006	258 341				
	352314	5233143	266 314				
	352320	5233203	266 315				

Cross OE > SASIC



CORRESPONDANCE ORIGINE ⇨ SASIC
CROSSING LIST O.E ⇨ SASIC

MARQUE Make	OE	SASIC		MARQUE Make	OE	SASIC	
CITROEN	410353	1034534	318	CITROEN	509315	0935155	254 324 336
	4103A7	1034A74	318		509433	0945335	266
	4103C9	1034C94	292		509437	0945375	266
	4103E4	1034E44	323		509440	0945405	314
	4103E6	1034E64	323		509456	0945565	170 261
	4103F6	1034F64	253 335		509457	0945575	170 261
	4103F7	1034F74	335		509459	0945595	170 260
	410419	1044194	314		509460	0945605	170 261
	4123A7	1234A74	335		509465	0945655	175 277 287 293 298
	412610	1264104	318 321 323		509466	0945665	277 292
	503139	0315395	337		509469	0945695	254 336
	503150	0315505	245 338		509471	0945715	261
	503151	2650035	181 221 227 250 253 307		509472	0945725	261
	503155	0355185	268 316		509473	0945735	270
	503174	2650011	197 207 215		509477	0945775	299
	503323	0335235	295 316		509479	0945795	277
	503327	0335275	181 268 281 295 307		509483	0945835	230
	503328	0335285	321 331		509490	0945905	231
	503335	0335355	264		509491	2300003	201
	503336	0335365	173 264		509495	2300006	194
	503339	0335395	255 338		509496	2300002	193 213
	503340	0335405	282 289 307		509497	2300001	193
	503341	0335415	320		509498	2300023	230
	503342	2650009	331		509499	2300004	230 239
	503345	0335455	274		5094A0	2300024	230
	503351	0335515	295 307		5094A1	2300008	231
	503356	0335565	271		5094A6	2300026	201 213
	503357	0335575	331		5094A7	2300044	191
	503359	0335595	282 289 307		5094A8	2300016	191
	503360	2650007	197		5094C5	2300032	210
	503365	0335655	181 282 289		5094C8	2300043	258 340
	503366	0335665	236		5094E0	0945885	217 225 249
	503370	2650001	181 221 227 250 307		5094E2	2300027	217 225
	503372	0335725	207		5094E3	0945895	175 218 225 249 299
	503375	2650038	189 196 205 211 214 220		5094E4	2300035	175 218 249 299
	503375	2650038	227 247		5094E5	2300041	258 340
	503382	0335825	197		5094E6	2300034	299
	503384	0335845	197		5094E7	2300036	175 252 299
	503385	2650018	221		513147	1315475	183 312
	503396	2650008	192		513163	1315635	174 265
	5033A5	2650012	245 338		513165	1315655	174
	5033A6	2650023	331		513171	1315715	286 296
	5033C3	2650043	189 207 211 247		513172	1315725	334
	5033C6	2650024	221		513173	1315735	334
	5033E5	2650013	212		513182	1315695	286 296
	5033F2	2650025	259 342		513183	1315705	286 296
	503517	0355175	321		513198	1315985	291 311
	503527	0355275	250		5131A4	2600001	222
	503543	0355385	255		5131A5	2600002	223
	503547	0355395	330		5131C1	1315C15	198 208
	503550	0355505	330		5131C2	1315C25	198 209 215
	503555	0355385	245 337		5131C6	2600013	208
	503557	2650004	192		5131C7	1315C75	238
	503563	0355275	173 181 189 197 206 211		5131C8	1315C85	238
	503563	0355275	215 221 227 247 250 253		5131C9	2600003	192
	503563	0355275	263 281 289 295 307 316		5131E0	2250011	237 241
	503733	8003208	316		5131E9	2600006	212
	503818	0385185	329		5131F2	2600004	183 227 253
	503819	0385195	329		5131G4	2600011	222 251
	503823	0385235	280		5131G8	2600012	259 342
	503824	0385245	280		5131H1	2600007	184 312
	503827	0385275	281 295		5131H4	2600009	190 209 212 248
	503828	0385285	329		5131K0	2600005	227 253
	503829	0385295	329		515261	1525615	256 339
	503850	0385155	263		515264	1525625	183 291 312
	503852	2001003	173		516434	1645345	245
	503862	0385225	281		516533	2650039	238
	503868	0385165	244 255 337		516610	1665105	317
	503870	0385175	244 255 337		516631	1665315	285 295
	503872	0385185	329		516637	1665375	173 264
	503874	0385195	329		516647	1665475	245 256 339
	503876	0385235	180 294 306		516656	1665565	339
	503878	0385245	180 289 294		516662	1665625	264
	503891	2650005	196 206 214		516663	1665635	183 286 290 311
	503893	0385935	181 289 306		516666	1665665	238
	5038E2	0385895	330		516669	1665695	245
	5038E3	0385875	330		516688	2650026	333
	5038E6	2650003	236		516694	1665675	197 207
5038F5	2650015	197 206 215	516695	1665685	197 208 215		
5038F6	2650022	192	516696	1665745	198 208		
5038F7	2650028	220	516697	2650029	333		
5038F8	2650036	187 224	5166A3	2650027	334		
5038G0	0385855	181 220 227 306	517109	1715095	285		
5038G4	2650037	220 250	517110	1715105	285		
5038G6	2650021	189 206 211	517111	1715115	183 290 310		
508733	0875335	169	517112	1715125	182 290 310		
508735	0875355	254 335	517258	2300046	188		
508737	0875375	323	5175CF	1755CF5	237 242		
508740	0875405	260 269	517843	1785435	274		
508748	0875485	269	517844	1785315	274		
508749	0875415	273	517847	2600015	238 242		
508751	0875515	243	517848	2300021	188		
508752	2300011	229 239	517849	2300022	188 224		
508753	2300009	229 239	517852	2300017	237 241		
508756	2300028	335	521020	2105205	321		
508757	2300030	175 225 252 298	525413	2545135	181 282 290 295 308 316		
508758	2300018	187 223	525418	2545185	173 264		
508759	0875455	193 200 213 246	525428	2545285	331		
508759	0875455QT	193 200 213	525433	2545335	181 282 290 308		
508760	0875485	229	525442	2650041	222 251		
508761	0875395	175 276 287 292 298	525446	2545195	245 255 338		
508764	2300019	217 249	525448	2650044	189 207 212 247		
508768	2300012	189 210	91503310	0935045	266		
508769	2300013	189 210	91504358	5203343	257 267		
508777	0875505	217	91504359	5213233	257 267 315		
508779	2300029	340	91539592	2005281	314		

Les références constructeurs (origine) ne servent qu'à identifier les pièces et sont données à titre indicatif.
References from carmakers or OE suppliers, are given for identification of the parts and have only a guidance value.



CORRESPONDANCE ORIGINE ⇨ SASIC
CROSSING LIST O.E ⇨ SASIC

MARQUE Make	OE	SASIC		MARQUE Make	OE	SASIC		
CITROEN	95495440	2006020	184	DACIA	Part/oe 545011697R	7574011	346	
	95496044	2006030	185		Part/oe 6001550441	3008250	348 352 355 358	
	95496045	2006031	185		Part/oe 8200820930	4001528	349 356	
	95496537	2004005	265 313		Part/oe 8201108350	7774016	344	
	95597955	2005200	185		DAEWOO	26001806	9006373	359 363
	95603308	2005252	170			26001807	9006372	359 363
	95603309	2005110	172			48810A78B00000	7676023	362
	95632592	2005261	186 317			520808	7776065	362
	95632593	2005262	186 317			520838	7776075	364
	95637690	2005256	185			521257	7776063	362
	96048007581	2006021	174 275 291			93740722	7676005	360
	96050338	2005251	171			93740723	7676007	360
	96051398	2005274	292			93741074	7776068	362
	96052007	2005201	292			93741092	7776064	362
	96055072	2005272	169			94788122	9005251	360 363
	96064489	2005271	170			96391875	2306074	360 364 365
	96070064	2005257	185	96415063		7476162	361 365	
	96075449	2005117	271	96415064		7476161	341 365	
	96079308	2004006	269	96535089		7576003	361	
	96081921	2004002	313	96611265	7476041	363 365		
	96083570	2005260	270	96870465	7476040	361		
	96089104	2005276	269	96870466	7476039	361		
	96089106	2005277	270	Part/oe 96268439	9001536	364		
	96102027	2001022	287 296	Part/oe 96268439	9001537	364		
	96106474	2005254	171	DAIHATSU	4546087401	7776099	366	
	96110483	2005250	176 293 299	FIAT	1300716080	0875375	427 431	
	96111480	2005203	292		1300720080	0935155	413 440	
	96131127	2004003	292		1303672080	9005370	385 415 442	
	96133255	2005253	170		1304640080	1315725	426 430	
	96133608	2005301	171		1304641080	1315735	426 430	
	96133609	2005300	171		1305551080	9001719	414 441	
	96136394	8123953	265 313		1305552080	9001716	414 441	
	96145457	2005202	269		1305782080	0945695	413 440	
	96158745	2005273	276 292		1306003080	0594094	413 440	
	96168072	2006161	272		1306716080	0184H44	427	
	96176177	2001013	272 275		1307021080	0335395	415 442	
	96176180	2001012	272 275		1307258080	1034E64	427	
	9677609080	2650042	189		1307259080	1034E44	427	
	Part/oe 1440177280	2300045	336		1312317080	9001724	414 441	
	Part/oe 1608532180	7770014	223		1313045080	0335415	426 429 433	
	Part/oe 1611075080	7770008	322		1313046080	9005377	425 430 433	
	Part/oe 3520Q1	2250008	240		1313056080	0935155	427 431 434	
	Part/oe 3520Q2	2250003	191		1317389080	5203943	414 441	
	Part/oe 3520Q2	2250006	191		1317390080	5213643	414 441	
	Part/oe 3520R7	2250007	210		1317425080	0875355	413 440	
	Part/oe 3520R7	2250012	210		1323165080	0385185	429	
	Part/oe 3520S0	2250004	324		1323166080	0385195	429	
	Part/oe 3520S0	2250005	325		1331640080	6403323	428 432	
	Part/oe 3520W5	2250015	210		1331641080	6403333	428 432	
	Part/oe 3520W5	2250016	210		1339464080	5203963	428 432	
	Part/oe 3520Y4	2256009	258 341		1339465080	5203953	428 432	
	Part/oe 3520Y4	2256032	258 341		1339466080	5213663	428 432	
	Part/oe 3520Y4	7570004	259 341		1339467080	5213653	428 432	
	Part/oe 3521L3	7570002	192		1345896080	0385895	432	
	Part/oe 365604	2250013	232 240		1345897080	0385875	432	
	Part/oe 381227	8123273	318		1346384080	5203P63	414	
	Part/oe 381295	8123953	268		1346385080	5213K63	414	
	Part/oe 381299	8123993	272		1350788080	2650034	435	
	Part/oe 3812A0	3008075	169 260		1350789080	2650033	435	
	Part/oe 3812A6	3008156	272		1351266080	2650026	436	
	Part/oe 3812A9	3008154	268		1352225080	7470007	435	
	Part/oe 3812C6	3008155	174 287 297		1352227080	7470008	435	
	Part/oe 3812C8	3008079	228		1355179080	0355395	430 433 435	
	Part/oe 3812E0	3008159	216		1355891080	2650029	437	
	Part/oe 3812E1	3008080	193 199 212		1356060080	7470015	415	
	Part/oe 3812F0	7770003	243 335		1356061080	7470014	415	
	Part/oe 3812F3	7770006	228	1356065080	7470021	441		
	Part/oe 3812F4	7770004	174 297	1356066080	7470022	441		
	Part/oe 381774	7670007	186	1357216080	2650027	437		
	Part/oe 400133	7770011	190	1376345080	7670002	433		
	Part/oe 400177	7770013	257 339	1376346080	7670001	433		
Part/oe 508183	8003210	324	1400099680	2300028	440			
Part/oe 5081N9	2300037	323	1471655080	9006653	426			
Part/oe 5081N9	2300038	324	1479759080	1525615	415 442			
Part/oe 516672	2001026	183 311	1497407080	7470002	442			
Part/oe 516673	2001025	183 311	1497408080	7470001	442			
Part/oe 5170F5	2300039	333	381711	8173113	422			
Part/oe ZF09941080	3008071	318	4103A7	1034A74	423			
DACIA	401604793R	7574003	350 357	4254520	9006330	438		
	485200410R	7674019	343 353 354 359	4318655	9006263	437		
	485202867R	7674018	343 353 354 359	4339248	5613083	423		
	545000138R	7474012	345	4388159	6403183	424		
	545004269R	7474017	350 357	4390179	0355175	426		
	545011362R	7474018	350 357	4391813	5213283	424		
	545011697R	7474013	345	4391814	5203413	424		
	546114237R	2304026	345	4400895	8005200	377 380 390 418 439		
	6001547140	4005153	349 356	4402649	9005230	389 417		
	6001547495	2654028	347 352 358	4409263	9005378	390		
	6001547499	4005537	344 346 351 355 357	4448132	9001500	388		
	6001548402	4005536	351	4466980	2105205	425		
	6001548403	2654001	346 351 357	46421522	2256014	386 420 443		
	6001549290	2654002	346 351 357	46430002	9005109	392		
	6001549989	2604001	347 352 358	46430003	9005108	392		
	6001550442	4006158	348 355	46437959	9005529	387		
	6001550443	4006157	348 355	46454597	9005797	386		
	8200277960	4005152	343 348 353 354 356 359	46454598	9005796	386		
	8200651172	4005300	344 346 351 355 357	46456189	9006655	385 443		
	8200814411	2304033	345 347	46456660	9006657	385 443		
	8200814709	2654020	347	46469709	9001752	370 373 383		
	8200876298	2654001	346	46474556	9005149	372 375 383		
	8201108332	7674016	344	46474557	9005148	372 375 383		
	8201108339	7674017	344	46536244	9005619	385		
	Part/oe 485213172R	7774018	343 354 358	46738808	9001785	420		
	Part/oe 545004269R	4003214	349 356	46760673	9005618	387 421 444		
	Part/oe 545011362R	4003212	349 356	46760674	9005617	387 421 444		
	Part/oe 545011697R	2254015	345					

Cross OE > SASIC



CORRESPONDANCE ORIGINE ⇨ SASIC
CROSSING LIST O.E ⇨ SASIC

MARQUE Make	OE	SASIC		MARQUE Make	OE	SASIC		
FIAT	46767261	9003111	422	FIAT	7775344	9001715	391	
	46777741	9005798	387		7775940	9005602	393	
	46777742	9005799	387		82387676	9006339	376	
	46790552	9001713	420		82446499	9005232	376	
	46821119	9001743	420		93501180	9005144	409 411	
	50003871	9001754	377 379 439		93501181	9005143	409 411	
	50006261	9006341	377 438		93501837	7570001	435	
	50700443	9001767	406		93501847	2650019	435	
	50700778	9001723	406		9403817738	7670011	413 440	
	50702649	2606002	373 407		9405038689	0385165	415 442	
	50705790	2650023	436		9405038709	0385175	415 442	
	51701045	9005000	382 384		98845031	9006442	419	
	51717001	9005002	422		98845032	9006443	419	
	51783623	2600012	380 403		9939038	9006265	403	
	51785487	2300043	378 401		9940260	9006268	376	
	51785488	2300041	401		9941625	9006271	368 370 407 410	
	51801136	9005099	366 371 406		9946948	9006269	390	
	51804551	2606003	397 400		9946949	9006342	367 390	
	51815479	2300029	378 381 401		9947436	9006335	368 371 407	
	51827736	7476178	373 407		9947437	9006334	368 370 374 407 410	
	51827738	7476177	373 407		9947438	9006335	374 410	
	51832937	9005801	384		9947714	9006654	375 382 384 419	
	51832938	9005800	384		9948292	9006827	385	
	51839218	9005793	381 393		9949218	9006444	371 406	
	51839219	9005794	381 393		Part/oe 1352227080	2250004	434	
	51842192	9005711	392		Part/oe 1352227080	2250005	434	
	51842193	9005712	392		Part/oe 1355449080	2300039	436	
	51856872	9005097	388		Part/oe 1357572080	2300037	434	
	51857021	7476030	367		Part/oe 1357572080	2300038	434	
	51857022	7476029	367		Part/oe 1359225080	7770008	433	
	51857133	7476032	389		Part/oe 1400245280	2300045	440	
	51857134	7476031	389		Part/oe 46404169	9005373	370 373	
	51866009	2650025	380 393 396 400 403		Part/oe 46545661	2256012	389 392	
	51866700	9005802	387 421 444		Part/oe 46551790	2256013	391	
	51866701	9005803	387 421 444		Part/oe 46773884	9005373		
	51895366	7470006	379 396 399 402 438		Part/oe 50708824	2256010	367	
	51895367	7470005	379 396 399 402 438		Part/oe 50708824	2256011	367	
	51932035	7476218	421		Part/oe 51769073	2256015	420 443	
	51932036	7476217	421		Part/oe 51769074	2256017	420 443	
	51963725	2650031	380 403 439		Part/oe 51783057	2256009	378 396 402	
	51963726	2650032	380 403 439		Part/oe 51783057	2256032	378 392 396 399 402	
	55700753	2306023	395 398		Part/oe 51784191	7770013	377 437	
	55701901	2656040	394 397 400		Part/oe 51895367	7570004	379 393 396 399 402	
	55701902	2656041	394 397 400		Part/oe 5960321	9006264	377 388 437	
	5920893	1034534	422		Part/oe 7076231	9006830	377 437	
	5927292	9001720	374 391 392 405 417		Part/oe 7077206	9006831	377 437	
	5927293	9001738	374 405 417		Part/oe 77362502	9006832	380	
	5947887	9001725	418		Part/oe 77362506	7776022	388	
	5958246	9006337	416 438		Part/oe 9566950880	3008069	413 439	
	5960254	9001753	418		Part/oe 98845025	7776058	419	
	5960835	9006332	388		Part/oe 98845026	9006834	419	
	5968311	9005600	418		Part/oe 9945562	9006270	390	
	60570627	9005082	368 371 375 408 410		Part/oe 9945836	3008070	426 431	
	7079382	9006825	385		Part/oe 9947713	3008069	382 384	
	7079388	9006824	385		Part/oe 9948343	9006828	390	
	7081835	9005531	421		Part/oe 9949217	9006833	406	
	7082812	9005530	387 421 444					
	71747915	9005104	369 372 409 412		FORD	1000445	9001689	451 455 476 486 496
	71747916	9005103	369 372 409 412			1002513	8005209	459 477 490
	7520850	9001569	386			1003609	9001599	458 476
	7543028	9006340	377 438			1007602	9005751	474
	7558962	9005102	404 405			1010037	9001594	458 496
	7563151	9001734	416			1011857	9006661	457 488 495
	7567284	6403263	424			1012632	9005752	474
	7591277	9005106	379 439			1013794	9001454	459 477 498
	7601064	9001722	369 372 383 408 411			1014654	9001588	458 496
	7601065	9001717	369 372 382 408 411			1015260	9005726	489
	7601068	9001714	369 372 382 408 411			1015263	9005728	459
	7601261	9005107	389			1015265	9005727	459
	7601502	8005206	370 373 376 409 412			1015546	9006351	450 485
	7601642	9001502	368 371 408 410			1015547	9006350	450 485
	7602150	9005611	370 373 409 412			1016439	9001747	460 478 495
	7603476	9001735	416			1020175	9006660	457 488 495
	7607086	9005379	409 412			1020214	9005728	459
	7633721	9006262	403 404 407 410 416			1023058	9001592	482
	7640534	9004002	416			1023328	2656034	449 483
	7669756	9006333	374 404 405			1023587	9005624	460 478
	7674825	9005174	379 439			1030025	9005249	477 490
	7693020	9001726	410 412			1032100	9005719	477
	7695185	5213533	424			1032102	9005718	477
	7695186	5203773	424			1034417	9006357	455 494 495
	7695190	5213523	424			1035929	9001595	451 455 476 486 494
7695191	5203763	424		1039103	9006364	501		
7705615	9005171	417		1041979	9001787	453		
7705616	9005170	417		1043158	9005128	482		
77362278	0184E04	431		1043159	9005129	482		
77362507	9006441	366 388		1044014	7776023	457 488		
77362508	9006440	366 388		1047145	9006364	501		
77363829	7676014	390 395 398		1047797	9005249	456 459		
77363830	7676013	390 395 398		1055191	9001596	458 489 496		
77364568	7670008	378 381 401 438		1055194	9005246	503		
77364569	7670009	378 381 401 438		1058279	9005117	492 487		
7736514	9005713	394		1058280	9005118	452		
7736515	9005714	394		1061570	9001586	466		
77365223	7676064	419		1063372	9001588	489 496		
77365224	7676065	419		1063987	9005719	497		
7736703	9004001	391		1063988	9005718	497		
7750982	9001736	391		1064128	7476152	469		
7750990	9001733	391		1067818	9005064	451 455 457 476		
7757917	9005371	393		1067918	9001793	466		
7760424	9001728	368 371 375 408 411		1071336	9005064	465 489 496		
7760425	9001729	368 371 408 411		1072279	9005724	459 489		
7762158	9005372	393		1073217	9001780	465		
7769900	9005152	394		1073249	9001782	469		
7769901	9005153	394		1087177	9005633	468 506		
7775343	9001718	391		1097316	9006461	449 480		
				1097323	9006462	449 480		

Les références constructeurs (origine) ne servent qu'à identifier les pièces et sont données à titre indicatif.
References from carmakers or OE suppliers, are given for identification of the parts and have only a guidance value.



CORRESPONDANCE ORIGINE ⇨ SASIC
CROSSING LIST O.E ⇨ SASIC

MARQUE Make	OE	SASIC		MARQUE Make	OE	SASIC	
FORD	1102592	9005352	474	FORD	1737309	7476145	463
	1106874	2656010	468		3736028	2306032	501
	1107013	9006463	464		4041490	9003125	504
	1107015	9006464	464		4055743	9003126	505
	1111156	9005247	474		4059923	9006885	501
	1115177	8005210	483 506		4059924	9006884	501
	1117698	9005008	481		4094280	9005649	504
	1118695	9001783	481		4131788	9002461	503
	1127648	2306027	484		4381840	9006667	499 505
	1128725	2306033	449 481		4386870	9005528	500 506
	1130273	9005064	485		4419557	2306133	500 507
	1130452	9005010	484		4419559	2306132	499 506
	1135077	9005004	494		4440885	2306137	504
	1138313	9006467	480		4472940	9006837	460 470
	1141293	9005129	482		4519467	2306028	498 501
	1141294	9005128	482		4540787	2256049	502
	1141774	9005062	473		4609099	9005626	483
	1145272	9001534	451		5021410	9006352	450 453 454 485 495
	1146150	9005003	471		5021413	9006354	491
	1198235	2656032	462 472		5021414	9006353	491
	1202548	9006662	460 470		5021426	9005241	454
	1202549	9006663	460 470		5021430	9005244	503
	1207973	9005721	467		5021458	9005111	452
	1207974	9005720	467		5021459	9005110	452
	1209035	9005004	465		5021460	9005116	492
	1212807	9005811	461 471		5021461	9005114	492
	1212808	9005812	461 471		5021462	9005126	491
	1219697	9005009	481		5021463	9005127	491
	1230909	2306024	446 465 479		5027451	9006359	480
	1234258	9006459	473		5027452	9006358	480
	1234259	9006460	473		5030221	9006361	491
	1254220	2656045	462		5030222	9006362	491
	1300459	2656037	448 470		5106995	9005007	481
	1305960	2306113	446 466 479		6087888	9005113	452 487
	1311416	9005717	483		6087889	9005112	452 487
	1311417	9005716	483		6120231	9006354	450
	1317446	9006689	464		6120232	9006353	450
	1317447	9006690	446		6131083	9006228	491
	1328877	9006689	446		6148996	9006365	501
	1330236	9005723	497		6150277	9005606	457 498
	1330237	9005722	497		6150970	9005066	501
	1330238	9005726	459		6150971	9005067	501
	1330239	9005724	459		6154289	9005126	452
	1332453	9005012	506		6154290	9005127	452
	1332463	9005013	507		6156463	9006231	500
	1337964	2306110	448 469		6160988	9006360	490
	1337965	2306097	448 469		6172643	9006363	501
	1345913	2306085	469		6180350	9006222	450 485
	1348231	2306087	466		6185334	9006221	450
	1355048	7476044	499 506		6185338	9006227	450 490
	1355050	7476045	499 506		6192705	9001690	451 486
	1371748	2306111	469		6197238	9006223	450 485
	1377471	2656011	468		6495311	9005610	453 488
	1377612	2656023	447 468		6517356	9001772	502
	1377849	2306025	473 481 493		6521811	9001602	502
	1377929	2656031	498 504		6521812	9001603	502
	1377929	2656031			6562752	9003112	505
	1388549	9006689	446		6608818	9001745	502
	1404785	9006690	446		6608830	9005820	503
	1416474	2306112	469		6608832	9005821	503
	1433273	7676024	173 481 493		6615742	9005117	487
	1433274	7676025	473 481 493		6650261	9005246	503
	1448621	9005809	477		6763456	9001455	504
	1448622	9005810	477		6770225	9005118	452 487
	1451914	9005526	503		6790115	9001593	482
	1469208	2306030	448 468		6799585	9001456	449 483
	1469212	9005003	461		6838725	9001435	484
	1469224	9005632	462 472		6870549	9001589	482
	1471446	9005004	465 476		6901534	9001598	484
	1487402	2306029	468		6960036	9005063	449 481
	1507181	7476042	474 483 493		6969518	9006357	475
	1507182	7476043	474 183 193		7102392	9001534	451 455 458 485 489 496
	1510270	9006839	445 478		7152269	9005121	456
	1535299	2656035	464		7152270	9005123	456
	1541485	7676027	478		7152271	9005122	456
	1541488	7676028	478		7152272	9005124	456
	1541811	9006690	464		7152278	9005119	456 497
	1545338	7676092	445 463		7152281	9005120	456 497
	1545339	7676091	445 463		7201717	9001436	473 475
	1545457	7776082	445 463		7201848	9001709	474
	1570284	7476193	447 467		7257202	9004007	455 495
	1570285	7476192	447 467		7294416	9006225	480
	1570748	9005814	447 467		7350847	9001458	453
	1570750	9005813	447 467		7403748	9001448	475
	1580517	9005099	476		93BB3395AC	9005243	454
	1596574	7776025	472 480 492		94FB3395BA	9005249	497
	1619120	9001587	454 492		Part/oe 1020497	9006229	472
	1634900	9001600	451 486		Part/oe 1085520	9006232	464 499 505
	1637183	9005111	452 487		Part/oe 1092382	9006229	472
	1637185	9005110	452 487		Part/oe 1146130	2256018	461 471
	1652651	9006221	450 485		Part/oe 1146131	2256019	461 471
	1652936	9001518	455		Part/oe 1317453	9006838	464
1659374	9006220	454 475 495	Part/oe 1328380	2256020	446 466		
1679382	7576002	462 472	Part/oe 1328380	2256021	446 466		
1679384	9005527	447 467	Part/oe 1377655	9006838	464		
1679388	7576041	447 467	Part/oe 1522081	2256022	482		
1679401	7576004	467	Part/oe 1522081	2256023	482		
1714576	7676068	445 465	Part/oe 1522081	7576008	483		
1714700	7676067	445 465	Part/oe 3903149	9006233	480		
1719542	2306031	448 468	Part/oe 6525844	9005240	452 456 487 497		
1723323	7476047	479	Part/oe 6869951	9006835	500		
1723324	7476048	479	Part/oe 7294415	9006224	479		
1735889	9005816	503					
1735890	9005817	503	HONDA	51320SAA003	2306068	511	
1736669	9006465	501		51321SAA003	2306072	511	
1737305	7476147	463		51350S6DG00	7476210	509	

Cross OE > SASIC



CORRESPONDANCE ORIGINE ⇨ SASIC
CROSSING LIST O.E ⇨ SASIC

MARQUE Make	OE	SASIC		MARQUE Make	OE	SASIC		
HONDA	51350SAAE11	7476168	511	KIA	545203E003	7476239	536	
	51350SAAJ01	7476169	511		545300X000	7576034	533	
	51360S6DG00	7476211	509		5453025000	7576031	540	
	53010S84A01	7776014	507		545302K000	7576043	533 535 538	
	53010SAAJ01	7776110	510		545303S000	7576032	539	
	53010SMGE01	7776083	507		545703E001	7576035	537	
	53010TF0003	7776102	509 510		546121G010	0355275	531	
	53011SAAJ01	7776111	510		5483007000	2306143	533	
	53011SMGE01	7776084	508		548302B000	2306121	536	
	53521S5A003	7776109	507		548302E100	2306125	539	
	53540SAA003	7676073	510		548302H200	2306119	530	
	53540SB2003	9006474	507 508		5484007000	2306142	533	
	53540SH3013	9006695	508		548402B000	2306122	536	
	53540SMG003	7676070	508		555301H100	2306120	532	
	53540TF0003	7676102	510 511		555302B000	2306123	537	
	53541S5A003	7676074	508 509		555302E100	2306124	540	
	53560SAA003	7676072	510		555303R000	2306145	532 540	
	53560SH3013	9006697	508		565400U500	7776101	534	
	53560SMG003	7676071	508		565402H000	7776027	530	
	53560TF0003	7676103	510 511		5682007000	7676031	534	
	HYUNDAI	517600Q000	7576009		517	568200X010	7676075	532
		517602E000	7576027		522	568201G000	7676048	534
		517602E010	7576045		523	568201G900	7676032	534
		517702E010	7576044		523	568201W000	7676105	534
		545001C010	7476175		513	568201W090	7676104	534
		545001E000	7476059		512	568201Y501	7676100	532
		5450025000	7476157		512	568201Y551	7676101	532
		545002H000	7476050		517	568202E000	7676097	538
545011C010		7476174	513	568202E900	7676095	538		
545011E000		7476058	512	568202H000	7676030	530		
5450125000		7476155	512	568202H090	7676029	530		
545012H100		7476049	517	568202K000	7676109	537 540		
545300X000		7576034	515	568202K050	7676108	537 540		
5453025000		7576031	512 514 516 519	568202S000	7676099	538		
545303S000		7576032	519	568202S050	7676098	538		
546122C000		0355275	513 518	56820A6000	7676111	530		
548301C000		2306128	513	56820A6090	7676110	530		
548302B200		2306121	520 521	572407000	7776028	532		
548302E100		2306125	522	577241G000	7776030	534		
548302H200		2306119	517	577242E000	7776067	538		
548401C000		2306127	513	577242S000	7776087	538		
548402B200		2306122	520 521	KDX5332240B	7776029	534		
553261C000		2656067	514	MDX5032280	7676031	532		
555301H100		2306120	518	LADA	21012904192	9005279	541	
555302B200		2306123	520 521		21013003057	9006478	541	
555302E100		2306124	523		21213414116	9006274	541	
555303R000		2306145	518 520	LANCIA	1303672080	9005370	549 561	
565402H000		7776027	516		1305551080	9001719	560	
568200X900		7676075	514		1305552080	9001716	560	
568201E000		7676081	512		1305782080	0945695	560	
568201E900		7676082	512		1306003080	0594094	559	
568202E000		7676097	522		1307021080	0335395	561	
568202E900		7676095	522		1312317080	9001724	560	
568202H000		7676030	516		1313056080	0935155	560	
568202H090		7676029	516		1317425080	0875355	560	
568202K000		7676109	515 518		1346384080	5203P63	551	
568202K050	7676108	515 518	1346385080		5213K63	551		
568202S000	7676099	519	1356060080		7470015	551		
568202S050	7676098	519	1356061080		7470014	551		
577240X010	7776108	514	4402649		9005230	559		
577241J000	7776085	515	46430002		9005109	556		
577242E000	7776067	521	46430003		9005108	556		
577242S000	7776087	519	46474556		9005149	544 547		
IVECO	500310933	9005233	524 525 527 528		46474557	9005148	544 547	
	500334716	7476221	527 528	50702649	2606002	548		
	500334717	7476222	527 528	51701045	9005000	542		
	500379801	7476224	527 528	51801136	9005099	546 557		
	500379802	7476223	527 528	51827736	7476178	547		
	8560291	9001583	524	51827738	7476177	547		
	8581021	9001577	526	51832937	9005801	549		
	8581295	9001582	524	51832938	9005800	549		
	93800662	9006338	523 525	51839218	9005793	550 558		
	93801556	9001579	526	51839219	9005794	550 558		
	93802242	9005231	524	5927292	9001720	555		
	93802248	9001580	524	5958244	9006262	552		
	93802629	9001578	526	5958246	9006337	558		
	93803961	9001576	526	5960036	9006333	558		
	93807640	9001427	525 526 529	5960037	9006333	558		
	9983325	9006343	523	60570627	9005082	542 546 552		
Part/oe 2992593	7776001	526	71737047	5203943	561			
Part/oe 500334716	7576039	527 528	71737048	5213643	561			
Part/oe 500379802	7576040	527 528	71747915	9005104	544 547			
JEEP	ES2221L	9006671	529	71747916	9005103	544 547		
	ES2222L	9006675	529	7545270	9006493	545 552		
	ES2223R	9006672	529	7601064	9001722	543 546 553		
	ES3094L	9006673	529	7601065	9001717	543 546 553		
KIA	0K01134510B	7576042	539	7601068	9001714	543 546 553		
	0K2A134300C	7476230	536	7601261	9005107	559		
	0K2A134350C	7476231	536	7601502	8005206	544 548		
	0K30B34300B	7476053	535	7601642	9001502	542 546 552		
	0K30B34350B	7476054	535	7633721	9006262	541 545		
	517600Q000	7576009	531	7736514	9005713	557		
	517602E000	7576027	539	7736515	9005714	557		
	517602E010	7576045	539	7760424	9001728	543 546 552		
	517702E010	7576044	539	7760425	9001729	542 552		
	5450007100	7476052	533	7762158	9005372	556		
	545001E000	7476059	535	7769900	9005152	556		
	545002H000	7476050	531	7769901	9005153	556		
	54500FD000	7476057	535	7775343	9001718	555		
	5450107100	7476051	533	7775344	9001715	555		
	545011E000	7476058	535	82387676	9006339	545 548 554		
	545012H100	7476049	531	82391821	9005179	547 553		
	54501FD000	7476055	535	82446499	9005232	554		
	545103E003	7476238	536	82480099	9005284	549		
				93501180	9005144	543		

Les références constructeurs (origine) ne servent qu'à identifier les pièces et sont données à titre indicatif.
References from carmakers or OE suppliers, are given for identification of the parts and have only a guidance value.



CORRESPONDANCE ORIGINE ⇨ SASIC
CROSSING LIST O.E ⇨ SASIC

MARQUE Make	OE	SASIC		MARQUE Make	OE	SASIC	
LANCIA	93501181	9005143	543	MERCEDES	2023230285	9001796	587
	9403817738	7670011	551		2023304807	9005733	587 606
	9405038689	0385165	561		2023304907	9005734	587 606
	9405038709	0385175	561		2023503408	9002516	589
	9939038	9006265	552		2023510842	9001619	578
	9940260	9006268	554		2023520165	9001606	575 589 594 602
	9941625	9006271	541 545		2033200789	2306047	593
	9946815	9006287	548		2033202889	2306037	590
	9946949	9006342	555		2033232085	2306048	590
	9947436	9006335	542 545		2033303611	7476001	592 608
	9947437	9006334	542 545		2033303903	9006540	590 597 607
	9947714	9006654	542		2033303911	7476002	591 597 608
	9947919	9006647	554		2033304003	9006539	590 597 607
	9947920	9006648	554		2033330914	2256030	591
	9949218	9006444	545		2033331014	2256027	591 595
	Part/oe 46404169	9005373	544		2043200489	2306038	596 599 605
	Part/oe 46545661	2256012	550 557		2043200589	2306039	596 599 605
	Part/oe 5960321	9006264	558		2043300903	7676012	595 599
	Part/oe 77362502	9006832	550		2043301003	7676011	595 599
	Part/oe 9566950880	3008069	559		2043301911	7476061	592 597 608
	Part/oe 9945562	9006270	555		2043302011	7476060	593 597 608
	LAND ROVER	NRC5869	9006503		562	2043304311	7476002
QJB100220		9006505	562	2043304411	7476001	596 597 599	
QJB100230		9006507	562	2043306711	7476003	596 599	
LEXUS	4333049185	9005568	562	2043306811	7476004	596 599	
MAZDA	1E0032240	7776023	567	2043330414	2256031	595	
	B25D34300D	7476172	568	2043380415	7776015	595 598	
	B25D34350D	7476173	568	2103302207	9005733	601	
	B45532280	9006511	567 569	2103307607	9005746	601	
	BP4K34170D	2306024	565 566	2103307707	9005744	601	
	BP4L32240	7776088	564 566	2103308807	9005734	601	
	BP4L32280	7676079	564 566	2103380515	9006542	600	
	BP4L32290	7676080	564 566	2103380615	9006541	600	
	BTDA34550	9005286	568	2103503306	9005076	594 598 602 607 608	
	C51334300	7476148	565 567	2103503806	9005070	576 579 589 594 598 602	
	C51334350	7476149	565 567	2103503806	9005070	607 608	
	D65132280	7676077	563	2103520965	9005071	575	
	D65132290	7676078	563	2113303389	2306103	605	
	D65134300B	7476145	563	2113300335	9005291	588 601 604 607	
	D65134350B	7476147	563	2113300435	9005536	604	
	D65332240	7906001	563	2113302703	9006544	603	
	DR612870X	2656035	564	2113302803	9006543	603	
	G03099356	9005287	569	2113304311	7476007	604	
	H26032280	9006512	568	2113304411	7476005	604	
	Part/oe DD3234300A	7576002	563	2113308907	9005739	603	
	MERCEDES	0003301007	7576033	598 604 606	2113309007	9005738	603
		0003385110	9006529	570 571	2113309107	7476063	603
		0003385410	9006529	570	2113309207	7476062	603
		0003385610	9006531	571	4143200389	2306040	615
		0003385910	9006531	571	6013210350	2306100	614 615
		0003386010	9006533	577	6013300435	9006681	615
		0003386110	9006538	577	6013300535	9006680	615
		0003386210	9006533	577	6313200028	9005290	611
0003386310		9006534	577	6313300703	9006844	610	
0013304835		9006532	611	6313380410	9006535	611	
0013307735		9006530	586 606	6383170912	9001620	577	
1243200289		9005040	574 588 593 601	6383230268	9005073	609 618	
1243200489		9005072	574 601	6383230285	9001614	609 619	
1243201444		9001635	574	6383230368	9005074	609 618	
1243234985		9001797	587 600	6383230468	2306042	609 619	
1243300803		9006845	570	6383230568	2306041	609 619	
1243300903		9006845	570	6383300010	9005741	610 620	
1243303007		9005731	572	6383300110	9005740	610 620	
1243303107		9005732	573	6383330027	9005534	620	
1243303807		9005729	578	6383330814	2256029	610 619	
1243303907		9005730	578	6384600048	9006684	609 618	
1243330327		9005289	573 578	6384600055	9006843	618	
1243334214		9001608	572	6384600255	9006843	609	
1243510242		9001615	577	6393200489	2306044	616 619	
1243511942		9001616	576	6393200589	2306043	616 619	
1243527765		9001622	577	6393300810	7476213	617 620	
1243529065		9001604	576 579	6393300910	7476212	617 620	
1293511542		9001617	576	6393330314	2256028	610 617 619	
1683200373		2656058	581	6393530050	2256048	621	
1683201189		2306034		6394600048	9006679	618	
1683301107		9005743	580	6394600055	9006847	618	
1683301135		9006682	579	6394600255	9006847	616	
1683301207		9005742	580	6394600348	9006678	618	
1683301235		9006683	579	6394600648	9006679	616	
1683301535		9006682	579	6394600748	9006678	616	
1683301635		9006683	579	6399810325	2656038	617 620	
1683302307		9005743	580	9013200389	2306144	612	
1683302407		9005742	580	9013230085	2656022	614	
1683330227		9005533	581	9013230285	2306102	612	
1683330614		2256025	580	9013260081	2306131	614	
1683330714		2256024	580	9013302407	7476151	613	
169320007328		2656047	583 585	9013302507	7476150	613	
1693200589		2306045	583 586	9013331227	9005538	613	
1693200989		2306035	582 584	9014600148	9006545	612	
1693300503		7676034	582 584	9043230085	2306075	612	
1693300603		7676033	582 584	9043260881	2306101	614	
1693300907		7476154	582 585	9063201789	2306005	612	
1693301007		7476153	582 585	9063201889	2306004	612	
1693330127		7576028	583 585	9063304007	7476111	613	
1703300107		9005736	587 607	9063304107	7476112	613	
1703300207		9005737	587 607	9063330014	2256055	613	
1683302307				9063330114	2256057	613	
+1683330227	7476185	581	9064600148	7676010	612		
1683302407			Part/oe 1683301335	9006842	579		
+1683330227	7476187	581	Part/oe 1693300403	7776069	581		
2013202444	9001636	578	Part/oe 1693300803	7776074	581 584		
2013505606	9005076	576 579 589	Part/oe 2103380415	9006841	600		
2013512842	9001618	579	Part/oe 2303380015	9006840	590 597 602		
2013528865	9001605	575 579 589 594	Part/oe 6393300510	9005537	620		
2014601505	7776012	577	Part/oe 9014600205	9006848	611		
			Part/oe 9064600055	7776017	611		

Cross OE > SASIC



CORRESPONDANCE ORIGINE ⇨ SASIC
CROSSING LIST O.E ⇨ SASIC

MARQUE Make	OE	SASIC		MARQUE Make	OE	SASIC	
MINI	31106779437	9005522	623 629	NISSAN	545016F600	9005836	652 654
	31106779438	9005521	623 629		545018H31A	7476068	663
	31126756309	9005520	623 629		545019F500	9005831	655
	31126757551	2256034	622 628		54501AV60C	9005833	655
	31126761409	7476023	623 629		54501BB00A	7476070	657
	31126761410	7476022	623 629		54501EL000	7476090	661
	31126767530	2256035	625 631 634 637 639		54501F4600	9005829	647
	31126772301	7476160	626 632 635 637 640		5450200Q0B	9005769	667
	31126772302	7476159	626 632 635 637 640		5450200Q0C	7474025	667
	31126772303	7576021	626 632 635 638 640		5450300Q0B	9005770	667
	31126772304	7576022	626 632 635 638 640		5450300Q0C	7474026	667
	31306772749	2656019	626 632 635 641		545600F001	9003127	659
	31306778833	2656065	623 629		54560AX600	4001585	651 653 661
	31351507989	9005026	622		5457000QAA	4001548	665
	31356757069	2306077	622 628		54570AX600	2256047	651 653 661
	31356757146	2306078	622 625 628 631 634 637		54613JD04A	2306115	648 649 656
	31356757146	2306078	639		54613JD17A	2306117	658
	31356758302	2306081	622 625 628 631 634		54613JG03A	2304027	648
	31356772843	2306079	625 634		546181AA0A	2304009	656 662
	31356772844	2306080	625 631 634		546184M400	2306050	646
	31356778831	9005028	622 625 628 631 634 637		54618BC40A	4005147	651 653 660
	31356778831	9005028	639		54618MB40A	9005032	659
	32106778437	7676054	624 630 633 636 639		546681AA0A	2304010	656 662
	32106778438	7676055	624 630 633 636 639		55034JD00A	2654029	649 658 664
	32116761560	9006425	621 627		55240JD000	2656054	658
	32136761559	7676059	621 627		55618JY00B	2304012	657 663
	32216754565	9006427	621		55619JY00B	2304013	657 663
	32216754566	9006424	621		8200750273	7474006	665
	33506772789	2306057	627 633 636 638 640		8200750274	7474007	665
	33551507999	9005027	624 630		D85200P725	9006579	662
	33556754823	2306083	627 633 636 641		D85201U026	7676035	646
	33556756151	2306084	624 627 630 633 636 641		D85201HA0A	7676093	651
	33556772788	2306082	627 638 640		D86401HA0A	7676094	651
	Part/oe 32106778548	7776097	624 630 633 636 638 641		Part/oe 4852000QAM	3008247	666
	Part/oe 32116780786	9006813	621		Part/oe 4852165F01	9006849	645
					Part/oe 49001BN013	7776057	646
					Part/oe 5450086J00	9005299	655
					Part/oe 54500EL000	7576017	661
					Part/oe 5450200QAA	2254007	667
					Part/oe 5450200QAB	2254008	667
					Part/oe 5450200QAB	4005278	668
					Part/oe 8200942417	4005277	1001
					Part/oe D85211HA0A	7776107	650
					Part/oe D8521JD00B	7774019	662
MITSUBISHI	4156A028	2300046	644	OPEL	0312510	2656063	680 693 696 705 712 719
	4422A012	7770021	644		0312510	2656063	726
	4422A018	7670007	644		0353282	9001657	691 710 728
	4422A052	7670018	642		0402952	2606004	683 705 727
	4422A076	7770014	642		1603009	9006374	694
	4543200010	2306073	643		1603121	9005250	672 676
	MB241171	9006547	644		1603161	9005252	689
	MB808909	2256041	643 645		1603164	9005251	702
	MB808910	2256042	643 645		1603167	9005250	687 716
	MB831043	9006548	644		1603187	9005252	692 712 729
	MN101372	2650036	642		1603202	9005542	692 712 729
	MR131680	2306069	642		1603215	9006691	677 723
					1603227	9006558	708 721
			1603228	9006557	708 721		
			1603286	9006561	717		
			1603288	9006563	681 724		
			1603289	9006564	681 724		
			1603302	9006855	723		
			1603357	7776034	680		
			1603358	7776042	680 723		
			1603359	7776060	681 723		
			1603430	9006562	703		
			1603453	9006201	690 709 727		
			1603455	9006692	690 709 727		
			1603542	9006691	723		
			1603543	7776038	696		
			1603544	7676014	696		
			1603545	7676013	696		
			1603642	7776072	723		
			1603645	9006374	688 690 709 727		
			1603844	7776035	694		
			1609012	7676083	703		
			1609013	7676084	703		
			1609026	7676069	670 684 699 724		
			1609027	7776093	670 684		
			1609029	7776094	684		
			1609184	7776089	723		
			1603128+352003	7476130	692 711 729		
			1603187+352002	7476129	692 711 729		
			5352011+1603202	7476132	692 711 729		
			5352012+1603202	7476131	692 711 729		
			312503	8005202	689 712		
			322126	9006205	672 700		
			322146	9006203	673 686 713		
			322147	9006204	673 686 713		
			322149	9006200	688		
			322158	9006202	690 709 727		
			322171	9006379	706		
			322172	9006378	706		
			322175	9006555	706		
			322176	9006554	706		
			322177	9006379	707		
			322178	9006378	707		
			322179	9006560	707		
			322180	9006559	707		
			324038	9006373	672 700		
			324039	9006372	672 700		
			324055	9006370	673 686 713		
			324056	9006371	673 686 713		
			344349	2656013	683 709 722		
			344401	9005356	677 702		
			344402	9005357	677		
NISSAN	5461847B0A						
	+56112V0100						
	+5611360U0A	2306049	651				
	4011000QAB	7574001	666				
	4016000Q0B	7574007	666				
	4016000QAB	4005279	665				
	4016000QAD	4005276	665				
	401604F100	9005430	652				
	401607F000	9005539	660				
	40160W2200	9005427	659				
	4852000QAH	4006153	664				
	4852000QAJ	4006154	664				
	4852000QAK	4006147	667				
	4852000QAL	4006148	667				
	4852000QAN	4006134	666				
	4852000QAP	4006135	666				
	4852000M025	9006688	658				
	4852000M085	7676035	645 646 647 650				
	4852017B25	9006551	650				
	4852050A26	9006552	658				
	4852050Y25	9006688	646				
	4852073J25	9006688	655				
	48520AX600	9006577	650				
	48520AX602	4006135	650 997 1031 1070 1128				
	48520BM425	9006580	646				
	4852100QAF	3008249	664				
	485210C005	7776105	650				
	485211M210	7776104	645				
	485214M500	7776070	646				
	485214U110	7776031	647				
	485218H385	7776032	662				
	485271U61A	7676037	651 653 660				
48527JD01A	7676039	656 1046					
48640AX600	9006578	650					
48640AX602	4006134	650					
486471U61A	7676038	651 653 660					
48647JD01A	7676040	656					
54035JD00A	2656061	657					
54050AX601	2656001	652					
543209U01A	2656030	654					
54320JG01B	2654022	663					
543219U01A	2656029	654					
54325ED02A	8005213	648 652 654 657					
5442300QAA	4001545	665					
5450000Q0C	9005767	665					
5450000M060	9005826	647					
545001KA1B	7476235	648 649					
545006F600	7476064	652					
545008H31A	7476067	663					
545009F500	9005830	655					
54500AV60C	9005832	655					
54500BB00A	7476069	657					
54500BC42A	9005834	652 654					
54500EL000	7476089	661					
54500F4600	9005828	647					
5450100Q0C	9005768	665					
545010M060	9005827	647					
545011KA0B	7476237	648 649					
545014F105	7476065	652					

Les références constructeurs (origine) ne servent qu'à identifier les pièces et sont données à titre indicatif.
References from carmakers or OE suppliers, are given for identification of the parts and have only a guidance value.



CORRESPONDANCE ORIGINE ⇨ SASIC
CROSSING LIST O.E ⇨ SASIC

MARQUE Make	OE	SASIC		MARQUE Make	OE	SASIC	
PEUGEOT	3520F3	5203F33	793	PEUGEOT	352394	8003204	904
	3520F7	5203F73	794		352396	5233453	873 878
	3520G8	5203G83	762		352398	5233983	749
	3520H1	5203H13	832		3523AA	5233AA3	749
	3520H3	5203H33	793		3523AG	2250001	761 770
	3520H5	5203F73	932		3523AP	8003204	909
	3520K4	5203A63	827		3523AQ	2250002	842 862
	3520K5	5203683	827		3523AZ	2250014	842 862
	3520K6	7470013	873 879		3523CA	2250019	842 862
	3520L0	5203953	910		3523CS	2250021	848 850
	3520L1	5203963	904		3523CW	2250018	898
	3520N3	5203N33	910		356104	5613043	822
	3520N4	5203N43	904 910		356105	5613053	926 927
	3520N6	5203N63	844 863		356106	5613063	853
	3520P4	5203943	883 893 918		356108	5613083	922
	3520P6	5203P63	887		356109	5613093	853 858
	3520P8	5203943	883		359904	1003561	743
	3520Q2	5203Q23			359905	1003560	743
	3520Q5	5203J33	934		364007	6403073	752 786
	3520R7	5203Q93	775 780		364012	6403123	822
	3520R8	7470001	894 918		364013	6403133	854 859 870
	3520S0	7470008	914		364017	6403183	924
	3520S6	7470021	894 918		364021	6403213	790 827
	3520S8	5203N63	843		364026	6403263	924
	3520T0	5203K83	805		364027	6403253	853 859 870
	3520T3	5203T33	750		364032	6403323	905
	3520V2	7470003	809 819 867		364033	6403333	905
	3520V6	5203G83	762		364035	6403353	839
	3520V7	5203L83	763		364036	6403363	743
	3520V8	7470001	887		364041	6403413	839
	3520W0	5203L73	762 771		364043	2005113	936
	3520X7	7470033	844 863		364044	6403313	794
	3520Y4	7470005	890 901		364049	6403483	794
	352123	5213233	738		364051	6403513	936
	352126	5213263	786 789		364054	6403543	905 910
	352128	5213283	923		364055	6403553	905 910
	352134	5213343	755		364060	6403533	810 819
	352137	5213373	756		364062	6403623	776 780
	352141	5213383	814		364066	6403663	750
	352152	5213523	923		364068	6403533	863 936
	352153	5213533	923		364069	7570003	845 863
	352166	5213663	904		364071	6403343	827 832 873 879
	3521A3	5213A33	793		364072	6403723	845
	3521A7	5213A73	794 932		364073	6403533	800 805 867 898
	3521C8	5213C83	762		364074	6403573	845 863
	3521E1	5213E13	832		364076	7570001	914
	3521E3	5213E33	793		364077	7570008	782
	3521E5	5213A73			364078	7570007	780
	3521G4	5213763	827		364083	7570006	863
	3521G5	5213493	827		381215	8123153B1	737 851 857 869
3521G6	7470012	873 879	381232	8123323B1	753		
3521H2	5213653	904 910	381247	8123473	787		
3521H3	5213663	904	381248	8123483	787		
3521J3	5213J33	910	381272	8123723	825		
3521J4	5213J43	904 910	381273	8123733	825		
3521J6	5213J63	844 863	381292	8123923	791		
3521K4	5213643	883 893 918	381295	8123323B1	753		
3521K6	5213K63	887	381296	8123963	787		
3521L3	5213L33	747	381297	8123973	785 787 812		
3521L6	5213F33	935	381298	8123983	825		
3521N8	5213N03	775 780	3812A4	3008069	882 891 916		
3521N9	7470002	894 918	3812C4	3008160	830		
3521P1	7470007	914	3812E2	8123E23	885		
3521P3	5213G83	800 936	3812E4	7770009	928		
3521P7	7470022	894 918	3812E5	8123E53	797 803		
3521P9	5213J63	844	3812E6	7770018	748		
3521Q1	5213G83	805	3812E7	8123E73	840		
3521Q4	5213Q43	750	3812E8	8123E83	773		
3521R3	7470004	809 819 867	3812F1	7770021	847		
3521R7	5213C83	762	3812F2	7770002	807 817 865		
3521R9	5213I03	763	3812F7	7770012	897		
3521S0	7470002	887	3812F8	7770007	807		
3521S1	5213H93	763 771	381330	8133303	925 926		
3521T8	7470032	844 863	381709	8173093	851		
3521V5	7470006	890 901	381711	8173113	922		
352309	5233093	822	381733	3008074	739		
352310	5233103	822 853 858	381739	8173393	830		
352311	5233113	752 786	381740	8173403	830		
352312	5233123	853	381741	8173303	740 759 769 788 797 803		
352314	5233143	738	381741	8173303	872		
352316	5233163	853 858 869	381742	8173313	740 759 769 788 797 803		
352317	5233173	789	381742	8173313	872		
352320	5233203	738 755	381743	8173433	872 877		
352322	5233223UN	789	381743	8173433	872 877		
352323	5233233	755 789 814	381744	8173443	740		
352324	5233243	789	381747	3008077	788 825		
352331	5233313	755 814	381748	8173263	788 825		
352340	5233403	826	381749	8173273	788 825		
352343	5233433	873 878	381750	8173183	737 753 785 788 791 798		
352349	5233273UN	755	381750	8173183	803 812 851 857 869 929		
352350	5233503	741	381755	8173553	749		
352351	5233513	742	381756	8173563	749		
352352	5233523	741	381757	8173573	840		
352357	5233573	873	381758	8173583	840		
352358	5233583	814	381763	8173633	746		
352361	5233613	831	381764	8173643	746		
352375	5233623	793 931	381765	7670005	841		
352376	5233763	761	381766	7670006	841		
352377	5233773	761 770	381767	8173673	773 778 783		
352378	5233603	831	381768	8173683	773 778 783		
352383	5233833	931	381773	7670011	886 892 917		
352389	5233423	826	381786	7670008	889 900		
352391	5233913	799 804 809 818 866 931	381787	7670009	889 900		
352392	5233923	799 804 809 818 866 898	381788	7670016	807 817 865 929		
352392	5233923	931	381789	7670017	807 817 865 929		
352393	5233933	909	381794	7670022	897		
			3817A1	7670024	861		

Les références constructeurs (origine) ne servent qu'à identifier les pièces et sont données à titre indicatif.
References from carmakers or OE suppliers, are given for identification of the parts and have only a guidance value.



CORRESPONDANCE ORIGINE ⇨ SASIC
CROSSING LIST O.E ⇨ SASIC

MARQUE Make	OE	SASIC		MARQUE Make	OE	SASIC	
PEUGEOT	3817A2	7670023	861	PEUGEOT	5038E2	0385895	911
	389911	8993113	751 785 821		5038E3	0385875	911
	389912	8993123	852		5038E5	2650002	1396
	389917	8993173	751 785 821		5038E6	2650003	845
	389918	8993183	852		5038E7	2650014	776
	389922	8993223	925 926		5038F5	2650015	750
	401138	0114384	824 829		5038F6	2650022	748
	401141	0114414	857 868		5038F8	2650036	848 850
	401143	0114434	824		5038G0	0385855	800 805 938
	401144	0114444	753 791 812 927		5038G4	2650037	810
	401165	0114654	928		5038G6	2650021	780 784
	4018A3	0184H44	903		5038H3	2650016	819 867
	4018A4	3008070	902 908		508705	0875055	852
	4018E0	0184E04	909		508709	0875095	852
	405705	0574054	821 851		508715	0875155	852 857
	405909	0594094	882 892 916		508718	0875185	858
	405912	0594124	886 892 916		508720	0875205	858
	410346	1034464	857		508721	0875215	788
	410353	1034534	922		508727	0875275	826
	410394	1034944	754 813		508732	0875325	754 813
	410396	1034964	753 812		508733	0875335	740
	4103A7	1034A74	922		508735	0875355	883 893 917
	4103A8	1034A84	754 812		508737	0875375	903 909
	4103C1	1034C94	792 825		508740	0875405	740 831
	4103C3	1034C34	825		508742	0875425	792
	4103C5	1034C54	825		508743	0875485	831
	4103C8	1034C84	792		508749	0875415	872
	4103E4	1034E44	903		508751	0875515	886
	4103E6	1034E64	903		508752	2300011	841 861
	4103E9	1034E94	753 812		508753	2300009	841 861
	4103F6	1034F64	882 892 917		508756	2300028	893 917
	4103F7	1034F74	882 892 917		508757	2300030	866 897 929
	4123A7	1234A74	892 917		508758	2300018	848 850
	412610	1264104	903 922		508759	0875455	749 759 770 782
	503139	0315395	884 895 919		508759	0875455QT	749 759 770 782
	503150	0315505	884 888 895 919		508760	0875485	878
	503151	2650035	801 805 510 819 867 899		508761	0875395	792 929
	503151	2650035	939		508764	2300019	808 818 866
	503155	0355185	756 791 816		508768	2300012	774 779 783
	503213	0325135	821		508769	2300013	774 779 783
	503223	0325235	790 854 859		508777	0875505	798 804
	503323	0335235	756 795 815		508779	2300029	889 900
	503327	0335275	756 795 815 835 939		508802	0885025	822
	503328	0335285	911 925		509304	0935045	737
	503335	0335355	744		509315	0935155	883 893 903 917
	503336	0335365	744		509316	0935155	909 913
	503339	0335395	884 895 920		509402	0945025	822
	503340	0335405	834 835 874 939		509409	0945095	852
	503341	0335415	907 911		509424	0945245	785 788
	503342	2650009	907 911		509432	0945325	858
	503351	0335515	939		509433	0945335	737
	503357	0335575	907 911		509434	0945345UN	789 826
	503358	0335585	765 772		509435	0945355UN	789 826
	503359	0335595	834 939		509436	0945365	754 813
	503360	2650007	766 772		509437	0945375	754 813
	503365	0335655	939		509440	0945405	754 813
	503368	0335685	766		509442	0945425	754 813
	503370	2650001	801 806 811 819 867 940		509443	0945435	754 813
	503375	2650038	750 776 780 784 800 805		509453	0945535UN	826
	503375	2650038	898		509456	0945565	741
	503385	2650018	801 806		509457	0945575	741
	503396	2650008	748		509458	0945585	741
	5033A5	2650012	888 895 920		509459	0945595	741
	5033A6	2650023	915		509460	0945605	741
	5033C3	2650043	777 780 782 784		509463	0945635	792
	5033C6	2650024	801 806		509464	0945645	792
	5033E4	2650017	820 868		509465	0945655	793 929
	5033E6	2650019	915		509466	0945665	792
	5033F2	2650025	891 902		509468	0945685	741
	503517	0355175	925		509469	0945695	883 893 917
	503527	0355275	819 867 898 744 750 756		509470	0945705	872
	503539	0355395	906		509471	0945715	741
	503547	0355395	911 915		509472	0945725	740
	503550	0355505	906 911 915		509474	0945745	831
	503554	0355325	834 874 879		509475	0945755	831
	503555	0355385	884 888 895 919		509476	0945765	740
	503557	2650004	748		509477	0945775	793 930
	503563	0355275	744 750 756 765 771 776		509479	0945795	792
	503563	0355275	780 784 790 795 801 805		509480	0945805	760
	503563	0355275	810 815 828 939		509481	0945815	759
	503726	0375265	828		509482	2300005	760 770
	503733	8003208	756 790 815		509487	0945875	798 808
	503818	0385185	906		509494	2300007	760
	503819	0385195	906		509495	2300006	760 770
	503820	0385205	874 879		509498	2300023	842 861
	503826	0385265	833		509499	2300004	842 862
	503828	0385285	906 911		5094A0	2300024	842 862
	503829	0385295	906 911		5094A1	2300008	842
	503850	0385155	744		5094A2	2300025	749
	503852	2001003	744		5094A7	2300044	746
	503856	0385565	764 771		5094A8	2300016	746
	503860	0385605	764 771		5094C1	2300014	774 779
	503862	0385225	795		5094C2	2300015	774 779
	503864	0385225	795		5094C3	2300031	774
	503866	0385255	833		5094C5	2300032	774
	503868	0385165	884 887 894 919		5094C8	2300043	889 900
	503870	0385175	884 887 894 919		5094E0	0945885	799 804 808
	503872	0385185	906		5094E2	2300027	808 897
	503874	0385195	906		5094E3	0945895	804 808 818 866 897 930
	503876	0385235	938		5094E4	2300035	930
	503878	0385245	938		5094E5	2300041	889 900
	503893	0385935	938		5094E6	2300034	930
	5038C5	0385365	764 771		5094E7	2300036	818 930
	5038C6	0385405	765 771		513104	1315045	824
	5038C7	0385345	764		513117	1315175	855
	5038C8	0385A15	764		513127	1315275	855 860

Cross OE > SASIC



CORRESPONDANCE ORIGINE ⇨ SASIC
CROSSING LIST O.E ⇨ SASIC

MARQUE Make	OE	SASIC		MARQUE Make	OE	SASIC	
PEUGEOT	513127	1315275S	855 860	PEUGEOT	Part/oe 1608532180	7770014	849
	513139	1315395	824 856 860		Part/oe 1611075080	7770008	913
	513143	1315435	758 817		Part/oe 3520Q1	2250008	843
	513146	1315465	925		Part/oe 3520Q2	2250003	747
	513147	1315475	829 943		Part/oe 3520Q2	2250006	747
	513152	1315525	877 881		Part/oe 3520R7	2250007	775 779
	513153	1315535	875 880		Part/oe 3520R7	2250012	775 779
	513154	1315545	875 880		Part/oe 3520S0	2250004	914
	513155	1315555	876 881		Part/oe 3520S0	2250005	914
	513156	1315565	876 880		Part/oe 3520Y4	2256009	890 901
	513163	1315635	745		Part/oe 3520Y4	2256032	890 901
	513165	1315655	745		Part/oe 3520Y4	7570004	890 901
	513169	1315695	796		Part/oe 3521L3	7570002	747
	513170	1315705	796		Part/oe 365604	2250013	843 862
	513171	1315715	797		Part/oe 381227	8123273	921
	513173	1315735	908		Part/oe 381283	3008071	921
	513174	1315745	758 817		Part/oe 381295	8123953	753
	513176	1315765	875 880		Part/oe 381299	8123993	872
	513178	1315785	836		Part/oe 3812A0	3008075	739
	513180	1315805	837		Part/oe 3812A6	3008156	872
	513194	1315945	768 773		Part/oe 3812A9	3008154	830
	513198	1315985	943		Part/oe 3812C0	2006021	928
	513199	1315995	837		Part/oe 3812C5	3008157	759 769
	5131A4	2600001	803 807		Part/oe 3812C6	3008155	928
	5131A5	2600002	802 807		Part/oe 3812C7	3008161	877
	5131C6	2600013	751		Part/oe 3812E0	3008159	797 803
	5131C9	2600003	748		Part/oe 3812E1	3008080	748
	5131E0	2250011	846 864		Part/oe 3812F0	7770003	886 892 916
	5131E1	1315625	877 882		Part/oe 3812F3	7770006	861
	5131E9	2600006	777		Part/oe 3812F4	7770004	928
	5131F0	2600014	777		Part/oe 3812G3	7770016	860
	5131F2	2600004	868 944		Part/oe 381774	7670007	847
	5131F8	1315935	768 773		Part/oe 400133	7770011	746
	5131F9	2600016	778		Part/oe 400177	7770013	889 899
	5131G4	2600011	811 899		Part/oe 508183	8003210	903
	5131G8	2600012	891 902		Part/oe 5081N9	2300037	913
	5131H1	2600007	944 945		Part/oe 5081N9	2300038	913
	5131H4	2600009	781 782 784		Part/oe 516120	1615205	837
	5131H7	2600008	811 820		Part/oe 516123	1615235	838
	5131K0	2600005	868		Part/oe 516672	2001026	942
	514232	1425325	802 806		Part/oe 516673	2001025	942
	515110	1515105	758 817		Part/oe 5170F5	2300039	915
	515124	1515245	829				
	515125	1515255	829				
	515240	1525165	856 860 871	RENAULT	0608268700	4001555	946
	515241	1525175	856 860 871		0855599000	400399J	948 950 957
	515253	1525185	856 860 871		7700799404		
	515259	1525595	839		+7703034237	4001505	991 997 1032 1039 1143
	515261	1525615	885 897 921		7700799404		
	515262	1525625	944		+7703034237	4001505	1167 1173
	516434	1645345	876 881 885 888 896 921		8200891487		
	516533	2650039	847 865		+7703034237	2304021	997 1143 1147 1153
	516610	1665105	816		401600004R	7574005	1061 1064 1067
	516631	1665315	796 816 828		401604793R	7574003	1009 1123 1155
	516637	1665375	745 768 772		401606676R	4005278	1025 1055 1058 1156
	516647	1665475	885 888 896 921		401606676R	4005278	1200
	516656	1665565	885 896 921		401608374R	7574012	1191
	516657	1665575	838		485200001R	7674010	1060 1063 1066
	516658	1665585	839		485200002R	7674011	1060 1063 1066
	516662	1665625	745		485200368R	7674020	989 1012 1159
	516663	1665635	942		485200604R	7676039	
	516669	1665695	888		485200780R	7674015	1190
	516688	2650026	916		485202710R	7674006	1027 1111 1113 1116
	516694	1665675	751		485202710R	7674006	1119 1140
	516697	2650029	916		485202714R	4006147	1156 1198
	5166A3	2650027	916		485204680R	7674007	1027 1111 1113 1116
	517102	1715025	855		485204680R	7674007	1119 1140
	517109	1715095	745 758 796 816		485206730R	7674013	1190
	517110	1715105	745 758 796 816		485207812R	7676040	1046
	517111	1715115	829 941		485208355R	7674021	989 1012 1159
	517112	1715125	829 941		485209446R	4006148	1023 1054 1057 1156
	517115	2300033	846		485209446R	4006148	1198
	517230	1725305	875		5000387333	4001510	1183
	517242	1725425	836		5000387433	4001720	1185
	517243	1725435	836		5000387990	4001512	1185
	517247	1725295	875 880		5000389581	4004008	1183
	517258	2300046	849		5000391009	4001507	1184
	5175CF	1755CF5	846 864		5000391010	4001506	1184
	517838	1785385	836		5000391054	4001625	1183
	517843	1785435	875 880		5000391730	4001524	1193
	517844	1785315	875 880		5000392206	4003389	1194
	517847	2600015	847 865		5000392464	4001509	1183
	517848	2300021	849		5000392656	4003349	1218
	517849	2300022	849 851		5000396624	4003392	1194
	517852	2300017	846 864		5001836749	T791016	1193
	517902	1795025	823 855		5001844135	T731014	1181 1192
	518106	1815065	785 852 858 869		5001844136	T731013	1181 1192
	521013	2105135	823		5001847436	T731023	1181
	521014	2105145	823		5001847437	T731024	1181
	521017	2105175	854 870		5001865610	T791007	1182
	521020	2105205	925		5010215010	T251035	1182 1193
	521023	2105235	854 859		540340002R	2654019	1112 1115 1118 1121
	521036	2105225	854 859		540340002R	2654019	1142
	522020	2205205	856		540500001R	2654005	1062 1065 1068
	525407	2545075	739 752 787 790 823 854		540500002R	2654006	1062 1065 1068
	525407	2545075	859 870		540500011R	2654027	1191
	525413	2545135	756 795 816 828 940		540500558R	2654033	1013
	525418	2545185	744		543024644R	2654035	989 1010 1013 1124 1160
	525426	2545265	835 879		543200001N	2654008	1062 1065 1067
525428	2545285	907 912		543200002R	2654009	1062 1065	
525433	2545335	766 767 940		543200919R	2654022	1047	
525442	2650041	802 806 811 820 899		543256557R	2654023	1029 1062 1065 1067	
525446	2545195	884 888 895 920		543256557R	2654023	1069 1112 1115 1118	
525448	2650044	777 781 782 784		543256557R	2654023	1121 1142	
9677609080	2650042	781 784		543259539R	2654030	989 1011 1013 1124 1160	
Part/oe 1440177280	2300045	893 918		54325ED02A	8005213	1047	
				543884315R	2654032	990 1011 1013 1124 1161	
				545008682R	7474011	1028 1112 1115 1117	

Les références constructeurs (origine) ne servent qu'à identifier les pièces et sont données à titre indicatif.
References from carmakers or OE suppliers, are given for identification of the parts and have only a guidance value.



CORRESPONDANCE ORIGINE ⇨ SASIC

CROSSING LIST O.E ⇨ SASIC

MARQUE Make	OE	SASIC		MARQUE Make	OE	SASIC	
RENAULT	545008682R	7474011	1120 1141	RENAULT	7700710718	4001485	964
	545018194R	7474010	1028 1112 1115 1117		7700710719	4001486	958
	545018194R	7474010	1120 1141		7700714835	4001610	1196
	545046817R	7474027	1012 1160		7700720958	4006143	1195
	545048101R	7474002	1024		7700730733	4003391	1197
	545050804R	7474001	1024		7700734714	4001508	1183
	545055711R	7474028	1012 1160		7700734718	4001612	1196
	546120005R	2304032	1111 1114 1119		7700739241	4001619	1185
	546120316R	2304031	1117 1119		7700754515	4001405	973 979
	546130003R	2304025	1060 1063 1066		7700757132	4005370	976 981
	546180001R	2304011	1060 1063 1066		7700757323	4005371	954 1165
	546180002R	2304019	1111 1114 1117 1119		7700757324	4001603	954 1165
	546180002R	2304019	1140		7700757691	4001325	975 981
	546180004R	2304030	1190		7700759787	4004001	972 977
	54618J00A	2304009	1046		7700760263	4001496	958
	54668JD00A	2304010	1046		7700760264	4001495	958 991
	55034JY00A	2654029	1047		7700760265	4001462	951 1162
	550445344R	2604003	1113 1116 1121		7700760571	4001329	960
	550446624R	2604007	1062 1065 1068		7700762130	4001477	972 978
	551100019R	2304039	1192		7700762574	4001406	952 959 1163
	5516010769	T251001	1181 1182 1193		7700762843	4003384	976 981 1050 1134
	552402790R	2654031	1014		7700762844	4003385	976 981 1053 1079 1133
	552419683R	2654026	1192		7700763621	4004002	972 977
	55618JY00B	2304012	1047		7700763934	4001472	952 1162
	55619JY00B	2304013	1047		7700765658	4004000	972 977
	6000022714	4006130	1125		7700766869	4005123	983
	6000022715	4006131	1125		7700766870	4005121	982
	6000022721	4006109	991 1128		7700767936	4001616	975 981
	6000022730	4006103	1149		7700769226	4001500	973 978
	6000022731	4006104	1149		7700771562	4001480	972 978
	6000022736	4006129	1048 1051		7700772687	4001487	974 979
	6000022737	4006128	1048 1051		7700773245	4001479	973 978
	6000022815	3008045	966 971 977		7700774026	4001483	973 978
	6000030047	4006114	966		7700776733	4003398	969 1075 1079 1084 1089
	6000030048	4006115	966		7700776733	4003398	1094
	6000030064	4006118	991		7700776743	4005372	969 1075 1079 1083
	6000030065	4006117	991		7700776743	4005372	1088 1093 1132
	6000073600	4001647	1003 1159		7700777276	4001409	973 979
	6000073602	4005527	1004 1154		7700777540	4001490	983 1015
	6001006724	4001433	953 1163		7700777654	4005301	954 960 969 1074 1078
	6001007821	4001494	951 1162		7700777654	4005301	1083 1088 1093 1132
	6006000779	4004007	1183		7700777654	4005301	1165
	6006000974	4001722	1185		7700781441	4001489	983 1018
	6006001514	4005513	1165		7700781442	4003347	983 1016 1018
	6025000249	4003378	1017 1019		7700781463	4001410	983 1018
	6025004756	4005127	1015		7700781498	4005122	983
	6025006302	4003379	1023		7700781500	4005124	982 1018
	6025102672	4005128	1018		7700783449	4003362	959 974 980
	6025103689	4006137	1017		7700783450	4003361	959 974 980
	6025105409	4001520	1018		7700783463	4003352	953 1164
	6025107253	4004009	1014 1017		7700783464	4003354	953 1164
	6025305979	4001623	988 1022		7700784170	4001475	967 991 1071 1085 1090
	6025305980	4001622	988 1022		7700784170	4001475	1129
	6025307649	4003217	987 1021		7700784171	4001522	998 1070 1081 1091 1129
	6025307650	4003218	987 1021		7700785788	4001476	967 991 998 1032 1039
	6025308155	4005274	987 1021		7700785788	4001476	1071 1086 1091 1129
	6025311529	4001544	987 1021		7700785788	4001476	1143 1167 1173
	6025315757	4003382	989 1017 1019 1023		7700785937	4001549	973 979
	6025370229	7674002	986 1020		7700789412	4001478	972 978
	6025370230	7674001	986 1020		7700789815	4001473	958
	7700302122	4001548	1187		7700789816	4001447	958
	7700302123	4001545	1187		7700793457	4004006	951 1161
	7700302278	4005133	1185 1188		7700794386	4003350	993
	7700309154	4001552	1186		7700794387	4003351	993
	7700312851	4005279	1188		7700795187	4001377	975 981
	7700314855	4005134	1032 1039 1167 1173		7700797821	4001503	983 1018
	7700413493	4003369	1049 1052		7700797822	4001504	983
	7700413494	4003368	1049 1052		7700798052	4001445	952 1162
	7700421804	4005267	1049 1052 1126		7700798053	4001539	952 991 998 1162
	7700424399	4001540	1033 1144 1174		7700798187	4001564	984
	7700424481	2654025	1025 1056 1059 1157		7700799064	4001492	992
	7700424482	4001626	1025 1056 1059 1157		7700799065	4001493	992
	7700426450	4001620	994 1003 1037 1042 1145		7700799066	4001412	992
	7700426450	4001620	1151 1154 1171 1177		7700802667	4005373	994 1037 1042 1171
	7700428440	4001614	1003 1154		7700802667	4005373	1177
	7700428665	4001553	1072 1081 1086 1091		7700803635	0355275	975 981
	7700428665	4001553	1129		7700805329	4001547	974 979
	7700428738	4001554	1072 1076 1081 1086		7700805494	4005132	986 1020 1048 1051 1125
	7700428738	4001554	1091 1130		7700805920	4001605	1126
	7700434126	4005379	1004		7700805922	4001636	1127
	7700436705	4005534	1133		7700806238	4001534	1125
	7700436706	4005149	1037 1043 1132 1172		7700806239	4001533	1125
	7700436706	4005149	1178		7700806832	4005138	1127
	7700436707	4001587	1043 1133 1178		7700807180	4001414	954 960
	7700437136	4005148	1032 1039 1129 1167		7700807580	4003376	1126
	7700437136	4005148	1173		7700807581	4003375	1126
	7700437911	4001643	1132		7700817328	4001482	972 978
	7700500113	4001304	916 955		7700818644	4005511	994 1201
	7700504987	4006107	961		7700819237	4005376	1151
	7700518856	4001402	947 956		7700821159	4005510	1151
	7700531796	4003397	948		7700821167	4003387	1152
	7700547187	4001452	961		7700822503	4001535	987 1021 1049 1052
7700586241	5203343	963	7700824022	0355275	988 1022 1050 1053 1126		
7700586466	5213233	963	7700824042	4001536	1049 1052		
7700611100	4001514	1195	7700826619	4001618	988 1022 1050 1053		
7700626057	4003394	948	7700827435	4001600	1151		
7700667182	4001440	1195	7700827436	4001602	994		
7700667184	2304007	1189	7700829529	4001615	1003 1037 1042 1145		
7700667186	4001442	1195	7700829529	4001615	1148 1171 1177		
7700667187	4001443	1195	7700831368	4003358	1131		
7700667189	4001444	1231	7700831369	4003357	1131		
7700670684	4004003	1194	7700832419	4001606	1050 1053		
7700687433	4001460	951 957 982 1161	7700832420	4001607	1050 1053		
7700693154	4001515	958	7700833756	4001640	1056 1059		
7700706135	4001516	958	7700835254	4001604	969 1074 1078 1083 1088		
7700710716	4005126	1015	7700835254	4001604	1093 1132		

Cross OE > SASIC



CORRESPONDANCE ORIGINE ⇨ SASIC
CROSSING LIST O.E ⇨ SASIC

MARQUE Make	OE	SASIC		MARQUE Make	OE	SASIC	
RENAULT	7700835929	4001517	998 1072 1081 1086 1091	RENAULT	7702106144	4001560	933 944
	7700835929	4001517	1127 1143		7702107985	4001562	936
	7700840296	4001639	1074 1083 1093		7702144561	4001446	952 1162
	7700840741	4001413	967		7703090293	4006138	949 951 957 964 970 972
	7700846916	4001638	1151		7703090293	4006138	977 982 985 1014 1030
	7700847382	4005129	1071 1085 1129		7703090293	4006138	1161 1183
	7700847383	4001518	998 1091 1130		7704000423	4003395	1197
	7701041312	4006109	1070 1076 1080 1085		7704000661	4001609	969 1074 1079 1083 1088
	7701041312	4006109	1090		7704000661	4001609	1093 1132
	7701047812	4006134	1070		7704000681	4001417	952 958 973 979 1163
	7701047813	4006135	1143 1167		7704001091	4003380	1197
	7701056096	2304006	1095 1101 1107		7704001232	4003381	1197
	7701056678	4005150	1006 1095 1101 1104		7704001280	4001435	1015
	7701056678	4005150	1107		7704001281	4001420	965
	7701056969	4005276	1188		7704001283	4001434	1015
	7701056970	7574001	1188		7704001601	4001424	961 965
	7701059672	2304015	1006 1096 1107 1122		7704001647	4003396	1197
	7701059672	2304015	1136		7704001726	4005378	1196
	7701059966	2304016	1007 1135		7704001734	4001502	983 1018
	7701062549	2304028	1006		7704001919	4001469	946 949 955 961 964 970
	7701063888	2304023	1099 1109 1138		7704001919	4001469	985
	7701069131	2304022	1044 1179		7704002466	4001427	983 1015
	7701070154	7574007	1188		7704002623	4001542	1015
	7701070790	2304020	1044 1179		7704003844	4001428	954 960
	7701208891	2954002	1098 1102 1105 1109		7705040000	4001429	961 965
	7701208891	2954002	1138		7705040002	4001430	965 1015
	7701348037	4001484	947 949 956		8200002876	4001627	1056 1059
	7701348454	4001415	947 949 956		8200002877	4001628	1025 1056 1059 1157
	7701348973	4006142	1183 1194		8200010491	4001630	1202
	7701349064	4001513	1185		8200010518	4005306	1201
	7701349773	4001416	949		8200012475	4005500	1026
	7701451904	4005252	947 950 956		8200012476	4005501	1026
	7701453465	4005120	961 964		8200016214	4005512	1026
	7701460955	4006111	946 949 955 963 970		8200024373	2304029	1149
	7701461140	4006042B1	962		8200024453	4003377	1189
	7701461331	4005259	965 971 985 1016 1030		8200024454	4003348	1189
	7701461332	4005258	965 971 985 1016 1030		8200033379	4005502	1033 1040 1131 1165
	7701461667	4005270	1196		8200033379	4005502	1174
	7701461770	4006133	1194		8200038284	4005517	1103
	7701462427	4006132	1182		8200038285	4005518	1099 1103 1109 1139
	7701462692	4005268	1184		8200040073	4001629	1098 1102 1105 1109
	7701462693	4005269	1184		8200040073	4001629	1137
	7701463025	4006044B1	963 970 985 1014 1029		8200042594	4003324	1004 1146 1154
	7701463035	4006052	1194		8200127285	2654007	1011 1124
	7701463346	4006054B1	951 1161		8200127308	4005147	1122 1160 1006
	7701463686	4005250	947 950 956		8200150759	4005151	1071 1081 1085 1090
	7701463687	4005251	947 950 956		8200150759	4005151	1129
	7701464037	4005261	974		8200150768	2304005	998 1071 1076 1081
	7701465689	4005263	984 1016 1019		8200150768	2304005	1085 1091 1129
	7701466236	4006045B1	971 977		8200180137	4001642	1025 1157
	7701466799	4006233	1124		8200190743	2654003	1202
	7701466800	4006234	1124		8200197179	4003367	1000 1034 1041 1144
	7701467218	4006245	1149		8200197179	4003367	1169 1176
	7701467219	4006247	1149		8200197187	4003366	1000 1035 1041 1144
	7701467235	4006240	966		8200197187	4003366	1169 1176
	7701467237	4006241	966		8200201714	4001644	1025 1157
	7701467271	4006242	990		8200222463	4001645	1098 1102 1105 1109
	7701467272	4006243	990		8200222463	4001645	1137
	7701467501	4006235	1048 1051		8200245679	4005508	1099 1106 1110 1139
	7701467502	4006237	1048 1051		8200254108	7474020	1035 1175
	7701468411	4005273	968 1035 1041 1073 1082		8200254109	7474019	1035 1175
	7701468411	4005273	1087 1092 1131 1169		8200272594	2304001	1054 1057
	7701468411	4005273	1176		8200300587	4001586	1158
	7701468820	4005254	962 965		8200322166	2654010	1025 1056 1059
	7701468821	4005256	962 965 971		8200380840	4005509	1139
	7701468883	4005257	1001 1141 1150		8200380965	2604002	1045 1180
	7701469228	4005262	984 1016 1019		8200411123	2654018	1138
	7701469229	4006048B1	982 1017		8200431675	4005507	1202
	7701469230	4006113	971 977		8200432285	2654013	1098 1109
	7701469231	4006112	951 949 955 963 970		8200455604	2304003	1054 1057
	7701469777	4006238	990		8200463368	2654016	1011
	7701469778	4006239	990		8200504291	4001634	1009 1123
	7701470363	4006153	1186		8200504295	4001635	1010 1123
	7701470364	4006154	1186		8200565072	9005770	1199
	7701470765	4006108	1167		8200565079	9005769	1199
	7701470766	4006109	1167		8200586561	7474003	1045 1180
	7701472038	4005257	953 959 968 974 980 993		8200586567	7474005	1045 1180
	7701472038	4005257	1087 1092 1164 1170		8200591283	2654011	1045 1180
	7701472038	4005257	1087 1092 1164 1170		8200602608	4005533	1158
	7701472087	4006108	991 1070 1076 1080		8200602609	4005532	1158
	7701472087	4006108	1085 1090 1128		8200602630	7474023	1055 1058
	7701474492	4006134	1076 1080 1085 1090		8200602631	7474024	1055 1058
	7701474492	4006134	1146 1149 1152 1158		8200619656	4001632	1201
	7701474493	4006135	1076 1080 1085 1090		8200619779	4005524	1201
	7701474493	4006135	1146 1149 1152 1158		8200619922	2304008	1157
	7701474641	4006134	997 1031 1039 1128		8200630328	4001646	1098 1109
	7701474641	4006134	1146 1149 1152 1158		8200630478	4001633	1202
	7701474642	4006135	1039 1173		8200651161	4001540	999 1040 1147 1168
	7701474795	4006161	1005 1094 1100 1104		8200651162	4001588	999
	7701474795	4006161	348 355		8200651163	4001413	1073 1077 1082 1087
	7701474796	4006159	1005 1094 1100 1104		8200651163	4001413	1092 1130
	7701474796	4006159	348 355		8200651164	4001530	1150
7701474869	4003210	1033 1040 1168 1175	8200651168	4001532	1150		
7701474870	4003211	1034 1040 1168 1175	8200651169	4001529	967 999 1073 1082 1092		
7701475842	4006134	1005 1122	8200651169	4001529	1131		
7701475843	4006135	1005 1122	8200651172	4005300	994 1003 1037 1042 1145		
7701476762	4006144	996	8200651172	4005300	1148 1151 1154 1159		
7701476763	4006145	996	8200651172	4005300	1171 1177		
7701477385	4005281	1201	8200661217	4005141	1024 1054 1057 1156		
7701478407	7674008	1044 1179	8200661217	4005141	1198		
7701478408	7674009	1044 1179	8200669065	4005146	1044 1095 1101 1104		
7701479190	2604006	1100 1103 1106 1110	8200669065	4005146	1107 1135 1179		
7701479190	2604006	1139	8200669066	2304002	1095 1101 1107 1135		
7701479191	2604005	1100 1110	8200681622	2304017	1153		
7701641726	4003365	974 979	8200681777	2654015	1154 1159		
7701641727	4003364	974 979	8200688871	7474009	1191		

Les références constructeurs (origine) ne servent qu'à identifier les pièces et sont données à titre indicatif.
References from carmakers or OE suppliers, are given for identification of the parts and have only a guidance value.



CORRESPONDANCE ORIGINE ⇨ SASIC
CROSSING LIST O.E ⇨ SASIC

MARQUE Make	OE	SASIC	📄	MARQUE Make	OE	SASIC	📄		
RENAULT	8200688875	7474008	1191	RENAULT	Part/oe 8200298454	4003221	1096 1102 1105 1108		
	8200688877	7574006	1191		Part/oe 8200298454	4003221	1137		
	8200691425	2304018	1153		Part/oe 8200298455	4003222	1097 1102 1105 1108		
	8200711554	4001546	1033 1040 1168 1174		Part/oe 8200298455	4003222	1137		
	8200713522	4005140	1186		Part/oe 8200298455	4003222			
	8200713523	4005139	1186		Part/oe 8200346941	4005280	1097 1102 1105 1108		
	8200714446	4005118	1149		Part/oe 8200346941	4005280	1137		
	8200714448	4005119	1149		Part/oe 8200586561	7574008	1045 1180		
	8200715229	4005506	1026		Part/oe 8200586567	7574009	1045 1180		
	8200725672	7474021	1097 1108		Part/oe 8200602612	4003319	1055 1058		
	8200725673	7474022	1097 1108		Part/oe 8200602613	4003320	1055 1058		
	8200737112	4003360	968 1001 1073 1082 1092		Part/oe 8200602617	2254007	1024 1199		
	8200737112	4003360	1131		Part/oe 8200602617	2254008	1024 1199		
	8200737114	4003359	968 1001 1073 1082 1092		Part/oe 8200679067	2254003	1096 1101 1104 1107 1136		
	8200737114	4003359	1131		Part/oe 8200725672	4003221	1096		
	8200737125	4003374	1150		Part/oe 8200725673	2254002	1096 1101 1104 1107 1136		
	8200737126	4003372	1150		Part/oe 8200725673	4003222	1097		
	8200737134	4003358	968 1073 1077 1082		Part/oe 8200744091	4001584	1007 1122		
	8200737134	4003358	1087 1092		Part/oe 8200744091	4001585	1007 1122		
	8200737135	4003357	968 1073 1077 1082		Part/oe 8200744091	4003215	1008 1123		
	8200737135	4003357	1087 1092		Part/oe 8200744091	4005280	1097		
	8200739838	4005526	1134		Part/oe 8200744092	4003216	1008 1123		
	8200744091	7474016	1008 1123		Part/oe 8200942403	7574010	1153		
	8200744092	7474015	1008 1123		Part/oe 8200942407	4005277	1036 1041 1074 1078		
	8200747691	2654017	1011 1154		Part/oe 8200942407	4005277	1087 1131 1148 1170		
	8200750273	7474006	1187		Part/oe 8200942407	4005277	1176		
	8200750274	7474007	1187						
	8200767822	9005768	1187		ROVER	GSJ281	9006585	1205	
	8200767825	9005767	1187			GSJ734	9006584	1204 1206 1207	
	8200824774	2654012	1098 1102 1105 1109			QGX100050	9006697	1203	
	8200824774	2654012	1137			QGX100060	9006695	1203	
	8200876657	7474025	1200			QJB000826EVA	9006588	1203	
	8200876659	7474026	1200			QJB10004EVA	9006584		
	8200904007	4001637	1201			QJB100120	9006588	1205	
	8200942403	7474032	1153			QJB100180	9006698	1204	
	8200942407	7474030	1001 1035 1041 1147			QJB100190	9006699	1204	
	8200942407	7474030	1169 1176			RBG000020SLP	9005401	1204 1206	
	8200942408	7474029	1001 1035 1041 1147			RBJ100781	9005197	1203 1205 1206	
	8200942408	7474029	1169 1176			RBJ100791	9005198	1203 1205 1206	
	8200942423	7474031	1153						
	Part/oe 485210001R	7774015	1060 1063 1066			SAAB	4242749	9006370	1207
	Part/oe 485212373R	7774017	1190				4242756	9006371	1207
	Part/oe 485213026R	7774020	1046				4836540	9006561	1207
	Part/oe 485215612R	7774013	1027 1110 1113 1116				5237516	9005564	1208
	Part/oe 485215612R	7774013	1118 1140				8962250	9006279	1208
	Part/oe 485215961R	7774013	1044 1179				8972135	9005448	1208
	Part/oe 485219204R	7774019	1046				93172254	9006558	1208
Part/oe 545006560R	2254010	1028 1117 1141 1111			93172255	9006557	1207 1208		
Part/oe 545008682R	2254010	1114 1119			93194328	9006558	1207		
Part/oe 545008682R	2254011	1028 1111 1114 1117		SEAT	004402649	9005230	1245		
Part/oe 545008682R	2254011	1120			132156126A	9001527	1227		
Part/oe 545008682R	2254011	1120			132156127A	9001528	1227		
Part/oe 545008682R	7574002	1029 1112 1115 1118			191407151B	9005133	1221 1230 1251 1258		
Part/oe 545008682R	7574002	1120 1141			191407181D	9001520	1230		
Part/oe 545010012R	2254012	1061 1064 1067			191407181E	9001520	1221 1250 1257		
Part/oe 545010012R	2254013	1061 1064 1067			191411314	9001522	1220 1229 1249 1257		
Part/oe 6025370493	3008049	986 1020			191411315B	9005050	1229 1249		
Part/oe 7700302115	2254001	1187			191412329	9005604	1223 1231 1254		
Part/oe 7700430765	4005277	1001 1144			191419812	9006381	1220 1229 1248		
Part/oe 7701209534	4005528	1056 1059			191501541	9001704	1256		
Part/oe 7701209534	4005529	1056 1059			191512131B	9005361	1256		
Part/oe 7701352441	7774010	1182			191513425	9005368	1256		
Part/oe 7701469251	3008110	1069			1H0407151A	9005753	1251		
Part/oe 7701469280	3008109	1069 1080 1084 1089			1H0407152	9005754	1251		
Part/oe 7701469280	3008109	1128			1H0407365	9005268	1253		
Part/oe 7701469283	3008051	1070 1080 1089			1H0411314	9001760	1220 1229		
Part/oe 7701469502	3008049	1069 1079 1084 1089			1H0412303	2656002	1223 1254		
Part/oe 7701469502	3008049	1128			1H0412303B	9005338	1219 1236 1242 1254		
Part/oe 7701469517	3008245	1148			1H0413175	9005369	1223 1231 1255		
Part/oe 7701469570	3008245	1148			1H0501541A	9001705	1256		
Part/oe 7701469572	3008245	1124			1J0407151C	9005136	1240 1251		
Part/oe 7701469665	3008235	1048 1051			1J0407181	9001542	1234 1240 1246 1250		
Part/oe 7701469665	4006235	1048			1J0407365J	9005266	1241 1253		
Part/oe 7701469665	4006237	1048			1J0407366J	9005267	1241 1253		
Part/oe 7701470362	3008249	1186			1J0411314R	9001730	1239 1250		
Part/oe 7701470763	3008181	1031 1166			1J0411314T	9001732	1239 1250		
Part/oe 7701470764	3008034	1030 1166			1J0411315D	2306007	1239 1249		
Part/oe 7701471124	3008036	995			1J0411315G	9005090	1239 1249		
Part/oe 7701471125	3008037	995			1J0411315J	9005084	1238 1249		
Part/oe 7701471144	3008039	995			1J0411315K	9005093	1238 1249		
Part/oe 7701471844	3008046	1069 1076 1080 1084			1J0411316D	2306008	1239 1249		
Part/oe 7701471844	3008046	1089 1128			1J0411327	9005018	1239 1249		
Part/oe 7701471885	3008050	1069 1079 1084 1089			1J0412249	9005352	1211 1218 1223 1231		
Part/oe 7701471885	3008050	1128			1J0412249	9005352	1236 1242 1254		
Part/oe 7701472087	3008047	1069 1076 1080 1084			1J0412303	2656003	1242		
Part/oe 7701472087	3008047	1089 1127			1J0412331C	9005614	1236 1242 1254		
Part/oe 7701472088	3008043	1080			1J0422811B	9006635	1238 1248		
Part/oe 7701472089	3008043	1080 1090			1J0422812B	9006634	1238 1248		
Part/oe 7701472113	3008035	995 1031 1038 1142 1146			1J0505466B	2306009	1243		
Part/oe 7701472113	3008035	1166 1172			1J0512131B	9005328	1255		
Part/oe 7701472120	3008040	995 996 1031 1038 1142			1J0513353B	9005630	1224 1237 1243		
Part/oe 7701472120	3008040	1166 1172			1K0199231J	2256003	1213 1240 1251		
Part/oe 7701472734	3008055	1146			1K0199232J	2256002	1213 1240 1251		
Part/oe 7701472735	3008055	996 1143			1K0407151AB	9005757	1240 1251		
Part/oe 7701473333	3008247	1198			1K0407151AD	7476018	1214 1251		
Part/oe 7701473498	3008246	1148			1K0407151AH	9005757	1214		
Part/oe 7701473656	3008243	996 1031 1038 1166 1173			1K0407151AK	7476018	1241		
Part/oe 7701474448	3008242	1094 1100 1103 1106			1K0407152AB	9005756	1240 1251		
Part/oe 7701474448	3008242	1134			1K0407152AD	7476017	1214 1251		
Part/oe 7701475841	3008241	1005 1121			1K0407152AH	9005756	1214		
Part/oe 7701477878	7774012	1152			1K0407152BF	7476017	1241		
Part/oe 7701478551	3008042	1054 1057			1K0407182	9001759	1213 1239 1250		
Part/oe 7701478552	7774011	1023 1155			1K0407183E	2256001	1221		
Part/oe 7704001921	4005519	1197			1K0407365C	9005570	1214 1241 1253		
Part/oe 8200254163	4003226	1034 1041 1169 1175			1K0407366C	9005569	1214 1241 1253		
Part/oe 8200254166	4003227	1034 1041 1169 1175			1K0411315P	2306010	1210 1213 1239 1249		
Part/oe 8200255760	4005272	1097 1108							

Cross OE > SASIC



CORRESPONDANCE ORIGINE ⇨ SASIC
CROSSING LIST O.E ⇨ SASIC

MARQUE Make	OE	SASIC		MARQUE Make	OE	SASIC		
SEAT	1K0412303B	2656052	1215 1242	SEAT	7M0422817A	9006460	1209	
	1K0412303E	2656004	1215 1242 1255		7M0422818A	9006459	1209	
	1K0412303F	9005334	1215 1242 1254		7M0501541	9001436	1210 1212	
	1K0412331B	9005622	1215 1242 1254		7M3407365C	9005247	1211	
	1K0423810A	9006873	1212 1238 1248		8E0407151R	7476019	1226	
	1K0423811J	9006638	1209 1212 1238 1248		8E0407509P	7476206	1225	
	1K0423812J	9006637	1209 1212 1238 1248		8E0407510P	7476207	1225	
	1K0505465K	9005094	1215 1243 1255		8E0407693AL	7476202	1225	
	1K0505553A	9001786	1216 1244 1256		8E0407694AL	7476203	1225	
	1K0511327AQ	2306013	1215 1255		8E0411317	9005069	1225	
	1K0511327AR	9001737	1243		8E0411318	9005068	1225	
	1K0511327AS	2306014	1243		8E0422821C	7776081	1224	
	1S0501541B	2606005	1247		8E0505203D	9001776	1226	
	1S0512335A	2656062	1247		8E0505465AF	2306012	1226	
	1K0407365C				8E0511327A	2306104	1226	
	+ 1K0407151P	7476095	1214		Part/oe 141162449A	9006264	1245	
	191407151B				Part/oe 191419803	9006210	1219 1228 1247	
	+357407365	7476107	1222 1230 1252 1258		Part/oe 191422804A	9006217	1228	
	191407151B				Part/oe 1H0422803A	9006218	1219 1247	
	+357407365	7476108	1222 1230 1252 1258		Part/oe 1J0422803H	9006219	1237 1247	
	1H0407151A				Part/oe 6K0422804E	9006872	1228	
	+1H0407365	7476117	1252		Part/oe 6K0422821	9006871	1228	
	1H0407152				Part/oe 6K0422821E	9006872	1219	
	+1H0407365	7476115	1252		Part/oe 6N0419803	9006234	1216	
	1J0407151C				Part/oe 6N0419804	9006234	1216	
	+1J0407365H	7476118	1241 1252		Part/oe 6N0422804C	9006869	1216	
	1J0407151C				Part/oe 6N0422821A	9006235	1216	
	+1J0407366H	7476119	1241 1252		Part/oe 6Q0423803B	9006251	1219 1232	
	1K0407151AD				Part/oe 6Q0423803E	9006251	1216	
	+1K0407365C	7476128	1214 1241 1252		Part/oe 6R0423803A	7776079	1233 1247	
	1K0407152AD				Part/oe 6X0419804A	9006250	1216 1363	
	+1K0407366C	7476127	1214 1241 1252		Part/oe 7M3422804A	9006229	1209	
	1K0407366C				SE021156110A	9005130	1228 1244	
	+ 1K0407152P	7476097	1214		SE021156110B	9005131	1228 1244	
	6N0407151B				SE021156228A	9001575	1227	
	+6N0407365	7476121	1218		SE022162406A	9006333	1227 1244	
	6N0407151B				SE022162449B	9006262	1227 1244	
	+6N0407365A	7476120	1218		SE141156110A	9005107	1245	
	6Q0407151L				SE141162410A	9006332	1245	
	+6Q0407365M	7476123	1222 1234					
	6Q0407151L				SKODA	115420240	9005454	1267
	+6Q0407366M	7476122	1222 1234			115500440	9006600	1266
	6R0407151F					1H0412303B	9005338	1272
	+6R0407365A	7476183	1235 1253			1J0407151	9005136	1270
	6R0407152F					1J0407181	9001542	1259 1262 1270 1275
	+6R0407366A	7476184	1235 1253			1J0407181	9001542	1277
	357407182	9001523	1221 1230 1234 1239			1J0407365J	9005266	1271
	357407182	9001523	1246 1250 1257			1J0407366J	9005267	1271
	357407365	9005260	1222 1230 1253 1258			1J0411314R	9001730	1269
	357407365	9005260	1316 1329 1333 1353			1J0411314S	2306134	1269
	357407365	9005260	1356 1360 1368 1389			1J0411314T	9001732	1269
	357407365	9005260	1402 1418 1423			1J0411315G	9005090	1269
	357412303E	9005362	1223 1231 1254			1J0411315J	9005084	1269
	357412303F	9005363	1211 1223 1231 1254			1J0411315K	9005093	1269
	357412331A	9001709	1223 1231 1254 1258			1J0411327	9005018	1269
	357413175A	9005327	1219 1236 1242 1255 1276 1277			1J0412249	9005352	1265 1272 1279
	3A0422811	9006380	1220 1229 1248 1257			1J0412303	2656003	1272
	3A0422812	9006381	1257			1J0412331C	9005614	1265 1272 1279
	3C0199231D	2256007	1210			1J0422811A	9006385	1268
	3C0407151G	7476038	1211			1J0422811B	9006635	1268
	3C0407365A	7576007	1241			1J0422812A	9006384	1268
	3C0407366A	7576005	1241			1J0422812B	9006634	1268
	4D0411327J	9001740	1225			1J0512131B	9005328	1273
	6K0501541A	9001789	1230			1J0513353B	9005630	1266 1273
	6K0512131A	9005364	1224 1232			1K0199231J	2256003	1270 1281 1285
	6N0407181	9001692	1217			1K0199232J	2256002	1270 1281 1285
	6N0407182	2256008	1217			1K0407151AC	7476018	1271
	6N0407365	9005270	1218			1K0407151T	7476018	1281
	6N0407365A	9005269	1218			1K0407152AD	7476017	1271
	6N0411315C	9005080	1217			1K0407152T	7476017	1281
	6N0412303A	2656008	1231			1K0407182	9001759	1270 1281 1285
	6N0412331A	9005616	1218			1K0407183E	2256001	1262
	6N0412331E	9005623	1223 1231 1236			1K0407365C	9005570	1271 1282 1285
	6N0413175A	2656053	1211 1215 1223 1231			1K0407366C	9005569	1271 1282 1285
	6N0413175A	2656053	1236 1242 1255			1K0411315P	2306010	1269 1280 1284
	6N0419811	9006619	1217			1K0412303B	2656052	1272 1283
	6N0419812	9006618	1217			1K0412303F	9005334	1272
	6N0501541D	9001703	1219 1224 1232			1K0412331B	9005622	1272 1283 1286
	6Q0407151L	9005758	1221 1234			1K0423810A	9006873	1268 1279 1284
	6Q0407182A	2256038	1221 1234			1K0423811G	9006640	1269 1280 1284
	6Q0407183A	2256001	1221 1234			1K0423811K	9006638	1268 1280 1284
	6Q0407365M	9005478	1222 1235			1K0423812G	9006639	1269 1280 1284
	6Q0407366M	9005479	1222 1235			1K0423812K	9006637	1268 1280 1284
	6Q0411314P	2306017	1233 1246			1K0505465K	9005094	1273 1283 1286
	6Q0411314Q	2306018	1233 1250			1K0505553A	9001786	1274 1283 1286
	6Q0411314R	2306019	1233 1249			1K0511327AP	9001739	1273 1283
	6Q0411315N	9005089	1220 1233			1K0511327AQ	2306013	1273 1286
	6Q0412301A	2656048	1223 1236			1K0511327AR	9001737	1273
	6Q0423810C	9006874	1219 1232			1K0511327AS	2306014	1273
	6Q0423811	9006634	1220			1K0511353P	2656051	1274
	6Q0423811C	9006634	1233			1S0501541B	2606005	1260
	6Q0423812	9006635	1220			1S0512335A	2656062	1260
6Q0423812C	9006635	1233		1J0407151C				
6Q0501541E	9001750	1224 1237		+1J0407365H	7476118	1271		
6R0407151F	7476091	1235 252		1J0407151C				
6R0407152F	7476092	1235 1252		+1J0407366H	7476119	1271		
6R0407365A	7576019	1235 1246 1253		1K0407151AC				
6R0407366A	7576020	1235 1246 1253		+1K0407365C	7476128	1271 1281		
6R0501541A	2606001	1237 1244 1256		1K0407152AC				
6X0407151A	9005138	1218		+1K0407366C	7476127	1271 1281		
6X0422811	9006628	1217		6Q0407151L				
6X0422812	9006629	1217		+6Q0407365M	7476123	1262 1278		
7M0407151B	9005751	1211		6Q0407151L				
7M0407152B	9005752	1211		+6Q0407366M	7476122	1262 1278		
7M0407181A	9001763	1210		6R0407151F				
7M0411031	9001779	1210		+6R0407365A	7476183	1263 1278		

Cross OE > SASIC

Les références constructeurs (origine) ne servent qu'à identifier les pièces et sont données à titre indicatif.
References from carmakers or OE suppliers, are given for identification of the parts and have only a guidance value.



CORRESPONDANCE ORIGINE ⇨ SASIC
CROSSING LIST O.E ⇨ SASIC

MARQUE Make	OE	SASIC		MARQUE Make	OE	SASIC	
SKODA	6R0407152F			TOYOTA	4806805050	7476080	1294
	+6R0407366A	7476184	1263 1278		4806805070	7476165	1295
	357407182	9001523	1261 1270 1275 1277		4806809041	7476163	1308
	357412303F	9005363	1272		4806812171	7476082	1299
	357413175A	9005327	1272 1276 1277		4806812260	9005848	1301
	4B3407151K	7476033	1282		4806813010	9005848	1300
	4D0407151P	9005157	1282		4806842022	7476087	1304
	6N0412303A	2656008	1265		4806842050	7476229	1304
	6N0412331E	9005623	1265 1279		4806859035	9005846	1308
	6N0413175A	2656053	1265 1272 1279 1283		4806905050	7476081	1294
	6N0413175A	2656053	1286		4806905070	7476167	1295
	6Q0407151L	9005758	1262 1277		4806909041	7476164	1308
	6Q0407183A	2256001	1262		4806912171	7476083	1299
	6Q0407365M	9005478	1263 1278		4806912260	9005849	1301
	6Q0407366M	9005479	1263 1278		4806913010	9005849	1300
	6Q0411314F	2306015	1261		4806942022	7476088	1304
	6Q0411314P	2306017	1259 1261		4806942050	7476228	1304
	6Q0411314Q	2306018	1261		4806959035	9005847	1308
	6Q0411314R	2306019	1261 1277		483310H010	2650008	1298
	6Q0411315N	9005089	1261 1277		4860905010	9001768	1295
	6Q0423810C	9006874	1260 1276		486090H010	2650022	1298
	6Q0423811C	9006634	1276		4860942012	2656024	1305
	6Q0423812C	9006635	1276		4860952021	2656055	1309
	6R0407151F	7476091	1263		4860952050	2656027	1309
	6R0407152F	7476092	1263		486190H010	2650004	1298
	6R0407365A	7576019	1259 1264 1275 1278		488150D100	2306088	1307
	6R0407366A	7576020	1259 1264 1275 1278		488150H010	2300016	1297
	6R0423811	9006634	1260 1275		4881552010	2306092	1307
	6R0423812	9006635	1260 1275		4881552030	2306091	1307
	6R0501541A	2606001	1266 1274		488170D010	2300044	1297
	6U0407365	9005454	1267		4881952010	2306055	1307
	6U0422811	9006600	1267		488200D010	2306054	1305 1307
	8D0412131F	9005326	1283		4882033010	9005044	1299 1303
	8E0407505A	9005140	1282		4883005020	9005049	1295
	8E0407506A	9005141	1282		ES2382	9006604	1299 1303
	8E0407509A	9005749	1282		Part/oe 455000H010	7770011	1296
	8E0407510A	9005750	1282		Part/oe 455030D030	7776050	1306
	8E0407693AG	9005156	1282		Part/oe 4550319215	7776048	1298 1302
	8E0407694AG	9005154	1282		Part/oe 4550349055	7776047	1302
	8Z0411314B	2306022	1261		Part/oe 4550349105	7776044	1296
	Part/oe 007350278N	9006861	1267		Part/oe 4550359055	7776051	1306
	Part/oe 1J0422803H	9006219	1268		Part/oe 480680H010	2250003	1297
	Part/oe 1J0422807A	9006213	1268		Part/oe 480680H010	2250006	1297
	Part/oe 6Q0423803B	9006251	1260		Part/oe 4806859035	2250003	1308
Part/oe 6R0423803A	7776079	1274	Part/oe 4806859035	2256045	1308		
			Part/oe 4806859035	7570002	1297 1309		
SMART	2271V007000005	7576011	1287 1288	VOLKSWAGEN	171407153D	9005139	1327 1359
	4513200189	2306071	1287		171407181A	9001693	1326
	4513300010	2256043	1288		171407182D	9001694	1326
4543200010	2306073	1287	171407365G		9005262	1327 1360	
SUZUKI	4520050E00	7476041	1289		171411313	9001699	1326
	4520075F21	7476232	1291		171411314A	9001698	1326
	4520172K01000	7476105	1290		171412329A	9001707	1327
	4520272K01000	7476104	1290		171419821	9006209	1326 1357
	4881063J00	7676085	1289 1290		191407151B	9005133	1319 1329 1359 1388
4883063J00000	7776095	1289 1290	191407151B		9005133	1401 1422	
TALBOT	12858600	6003001	1291		191407181D	9001520	1318 1329 1332 1355
	12891400	6003000	1291		191407181D	9001520	1359 1387 1417
	352034	5203343	1292		191407181E	9001520	1368 1422
	352123	5213233	1292		191407365	9005261	1329 1360 1402
	381215	8123153B1	1292		191411314	9001522	1318 1328 1332 1358
381750	8173183	1292	191411314		9001522	1386 1417 1421	
TOYOTA	4806805050				191411315B	9005050	1328 1332 1353 1355
	+4333029375	7476133	1294		191411315B	9005050	1358 1417
	4806812171				191412329	9005604	1330 1334 1361 1419
	+4333049185	7476181	1300		191419811	9006380	1318 1328 1331 1357
	4806813010				191419811	9006380	1367 1417
	+4333009090	7476141	1300 1301		191419812	9006381	1318 1328 1331 1357
	4806905050				191419812	9006381	1367 1417
	+4333029375	7476134	1294		191422821C	9006212	1331 1416 1367
	4806912171				191501541	9001704	1321 1330 1363
	+4333049185	7476182	1300		191512131B	9005361	1320 1330 1335 1354
	4806913010				191512131B	9005361	1362 1420
	+4333009090	7476140	1300 1301		191513425	9005368	1320 1330 1335 1362
	4333009090	9005568	1300 1302 1304		191513425	9005368	1391 1420
	4333009210	7576012	1295		1H0407151	9005134	1333 1353 1356 1418
	4333029375	9005567	1295		1H0407151A	9005753	1333 1418
	4333049025	7576013	1304		1H0407152	9005754	1333 1418
	4333049095	7576037	1293 1304 1306		1H0407365	9005268	1333 1368 1418
	4504609230	7676043	1293		1H0407366A	9005268	1319
	4504609295	8173643	1296		1H0411314	9001760	1332 1417 1421
	4504609480	7676089	1307		1H0411314	9001760	1424
	4504609570	7676041	1293		1H0412303	2656002	1316 1334 1340 1366
	4504619265	9006603	1301		1H0412303B	9005338	1390 1395 1419
	4504629305	9006604	1298 1307		1H0412303B	9005338	1320 1391 1424
	4504629365	9006607	1294		1H0413175	9005369	1321 1335 1357 1420
	4504629425	7676044	1294		1H0501541A	9001705	1311 1315 1339
	4504649095	9006642	1303		1J0407151C	9005136	1311 1315 1339 1393
	4504649115	9006603	1299		1J0407181	9001542	1396
	4504649195	7676087	1303		1J0407181	9001542	1312 1316 1339
	4504659045	7676045	1306	1J0407365J	9005266	1312 1316 1339	
	4504709125	8173633	1296	1J0407366G	9005267	1312 1316 1339	
	4504709220	7676090	1307	1J0411314R	9001730	1311 1315 1338 1355	
	4504709270	7676042	1293	1J0411314S	2306134	1315 1338	
	4504719115	9006605	1301	1J0411314T	9001732	1311 1315 1338 1355	
	4504729125	9006641	1294	1J0411315D	2306007	1338	
	4504749025	9006643	1303	1J0411315G	9005090	1310 1314 1338	
	4504749045	9006605	1299	1J0411315J	9005084	1310 1314 1338	
	4504749135	7676088	1303	1J0411315K	9005093	1310 1338	
	4504759035	7676047	1306	1J0411316D	2306008	1338	
	4550305050	7776043	1293	1J0411327	9005018	1310 1315 1338	
	4550312130	7776045	1298	1J0412249	9005352	1312 1316 1334 1340	
	4550319036	9006865	1298	1J0412249	9005352	1356 1366 1369 1390	
	4550319255	7776045	1301	1J0412249	9005352	1406 1419 1424	
4550359045	7776049	1306	1J0412303	2656003	1313 1316 1340 1395		
			1J0412331C	9005614	1312 1316 1340 1395		
			1J0422811A	9006385	1336		

Cross OE > SASIC



CORRESPONDANCE ORIGINE ⇨ SASIC
CROSSING LIST O.E ⇨ SASIC

MARQUE Make	OE	SASIC		MARQUE Make	OE	SASIC	
VOLKSWAGEN	1J0422811B	9006635	1309 1314 1337	VOLKSWAGEN	191407151B		
	1J0422812A	9006384	1337		+357407365	7476107	1319 1329 1360 1388
	1J0422812B	9006634	1309 1314 1337		191407151B		
	1J0422821A	9006213	1336		+357407365	7476107	1401 1423
	1J0505466B	2306009	1340		191407151B		
	1J0512131B	9005328	1317 1341		+357407365	7476108	1319 1329 1360 1388
	1J0513353B	9005630	1313 1317 1341 1391		191407151B		
	1J0513353B	9005630	1395		+357407365	7476108	1401 1423
	1K0199231J	2256003	1323 1342 1348 1401		1H0407151		
	1K0199231J	2256003	1413 1422		+357407365	7476109	1333 1353 1356 1418
	1K0199232J	2256002	1323 1342 1348 1401		1H0407151		
	1K0199232J	2256002	1413 1422		+357407365	7476110	1333 1353 1356 1418
	1K0407151AC	7476018	1323 1343 1349 1401		1H0407151A		
	1K0407151AC	7476018	1414 1423		+1H0407365	7476117	1333 1418
	1K0407151AH	9005757	1343 1360 1423		1H0407152		
	1K0407152AC	7476017	1323 1343 1349 1401		+1H0407365	7476115	1333 1418
	1K0407152AC	7476017	1414 1423		1J0407151C		
	1K0407152AH	9005756	1343 1360 1423		+1J040735H	7476118	1312 1316 1339
	1K0407182	9001759	1311 1323 1342 1348		1J0407151C		
	1K0407182	9001759	1359 1377 1381 1400		+1J0407366H	7476119	1312 1316 1339
	1K0407182	9001759	1408 1413 1422		1K0407151AC		
	1K0407183E	2256001	1387		+1K0407365C	7476128	1323 1343 1349 1401
	1K0407365C	9005570	1312 1324 1344 1349		1K0407151AC		
	1K0407365C	9005570	1360 1402 1409 1414		+1K0407365C	7476128	1414 1423
	1K0407365C	9005570	1423		1K0407152M		
	1K0407366C	9005569	1312 1324 1344 1349		+1K0407366C	7476127	1323 1343 1349 1401
	1K0407366C	9005569	1360 1402 1409 1414		1K0407152M		
	1K0407366C	9005569	1423		+1K0407366C	7476127	1414 1423
	1K0411315P	2306010	1310 1322 1342 1348		1K0407365C		
	1K0411315P	2306010	1358 1376 1380 1400		+1K0407151P	7476095	1344
	1K0411315P	2306010	1404 1408 1413 1421		1K0407366C		
	1K0412303B	2656052	1313 1324 1345 1350		+1K0407152P	7476097	1344
	1K0412303B	2656052	1352 1361 1378 1382		357407151		
	1K0412303B	2656052	1402 1409 1415		+357407365	7476113	1368
	1K0412303E	2656004	1324 1345 1349 1352		357407151		
	1K0412303E	2656004	1378 1381		+357407365	7476114	1368
	1K0412303F	9005334	1324 1378		6N0407151B		
	1K0412303P	9005337	1424		+6N0407365	7476121	1365 1388
	1K0412303S	9005339	1424		6N0407151B		
	1K0412331B	9005622	1324 1345 1349 1361		+6N0407365A	7476120	1365 1388
	1K0412331B	9005622	1378 1381 1402 1409		6Q0407151L		
	1K0412331B	9005622	1415 1424		+6Q0407365M	7476122	1389
	1K0423810A	9006873	1322 1341 1347 1351		6Q0407151L		
	1K0423810A	9006873	1357 1375 1380 1399		+6Q0407365M	7476123	1389
	1K0423810A	9006873	1404 1407 1412 1420		6R0407151F		
	1K0423811G	9006640	1376 1421		+6R0407365A	7476183	1394
	1K0423811J	9006638	1322 1341 1347 1352		6R0407152F		
	1K0423811J	9006638	1358 1400 1404		+6R0407366A	7476184	1394
	1K0423811K	9006638	1310 1375 1380 1408		321501541	9001696	1366
	1K0423811K	9006638	1412 1421		357407151	9005137	1368
	1K0423812G	9006639	1376 1421		357407182	9001523	1311 1315 1318 1329
	1K0423812J	9006637	1322 1341 1347 1352		357407182	9001523	1332 1339 1355 1359
	1K0423812J	9006637	1358 1400 1404		357407182	9001523	1368 1387 1393 1396
	1K0423812K	9006637	1310 1375 1380 1408		357407182	9001523	1417 1422
	1K0423812K	9006637	1412 1421		357412303E	9005362	1320 1327 1330 1334
	1K0505465K	9005094	1313 1325 1345 1350		357412303E	9005362	1361 1369 1419
	1K0505465K	9005094	1362 1379 1382 1403		357412303F	9005363	1320 1335 1369 1390 1406 1419
	1K0505465K	9005094	1407 1410 1415		357412329	9001708	1319 1334 1369 1419
	1K0505553A	9001786	1347 1351 1363 1379		357412331A	9001709	1319 1334 1354 1356
	1K0505553A	9001786	1382 1403 1410 1416		357412331A	9001709	1356 1369 1390 1419
	1K0511327AP	9001739	1345 1350		357413175A	9005327	1313 1317 1320 1335
	1K0511327AQ	2306013	1325 1346 1350 1379		357413175A	9005327	1340 1354 1356 1366
	1K0511327AR	9001737	1325 1346 1350 1379		357413175A	9005327	1369 1391 1395 1397
	1K0511327AS	2306014	1382 1403 1410 1415		3A0422811	9006380	1419
	1K0511327AS	2306014	1325 1346 1350 1379		3A0422811	9006380	1353 1355 1384 1399
	1K0511353M	2656049	1382 1403 1410 1415		3A0422811A	9006383	1421
	1K0511353M	2656049	1325 1347 1351 1362		3A0422811A	9006383	1429
	1K0511353M	2656049	1403		3A0422812	9006381	1353 1355 1384 1399
	1K0511353P	2656051	1347 1351 1416		3A0422812	9006381	1421
	1K0511353R	2656039	1416		3A0501541	9001702	1369
	1K0513353H	9005631	1346		3B0513353	9005627	1374
	1K0513353R	2656059	1351 1362		3C0199231D	2256007	1377 1381 1405 1408
	1S0501541B	2606005	1398		3C0407151G	7476038	1377 1381 1405 1409
	1S0512335A	2656062	1397		3C0407365A	7576007	1378
	3C0407151G				3C0407366A	7576005	1378
	+1K0407365C	7476180	1409		4B0407515	9001758	1371
	3C0407151G				4B0419811F	9006413	1370
	+1K0407366C	7476179	1409		4B0501521E	9001773	1375
	251407187C	9005263	1429		4B0501522E	9001774	1375
	251407361	9005264	1429		4B3407151K	7476033	1372
	251419811	9006383	1367 1326 1357		4D0407151P	9005157	1373
	281407187B	9005473	1426		4D0407181H	9001538	1371
	281407361	9005472	1426		4D0407182G	9001539	1371
	2D0407021	7476151	1428		4D0407183AC	9001540	1371
	2D0407022B	7476150	1428		4D0407509G	9005749	1373
	2D0407183	2656007	1428		4D0407510J	9005750	1373
	2D0407183A	2656005	1428		4D0407515C	9001543	1371
	2D0407361B	9005538	1428		4D0411317K	2306011	1370
	2D0411041A	2306102	1427		4D0411327G	9001547	1371
	2D0411041B	2306075	1427		4D0411327H	9001548	1371
	2D0411052	2306144	1427		4D0412377F	9001710	1374
	2D0422811	9006545	1427		4D0422821	9006247	1370
	2D0511413	2306100	1426 1429		4D0422821A	7776081	1370
	2D0511413B	2306101	1426 1429		4E0407505E	7476208	1383
	2E0407151M	7476111	1426		4E0407506E	7476209	1383
	2E0407152M	7476112	1426		4E0407509E	7476204	1383
	2E0407523	2256055	1425		4E0407510E	7476205	1383
	2E0407523A	2256057	1425		6K0422821B	9006870	1420
	2E0411317C	2306005	1425		6K0501541A	9001789	1392
	2E0411318C	2306004	1425		6K0512131A	9005364	1391
2E0713501	7676010	1425	6N0407151B	9005138	1365 1388		
171407153D			6N0407181	9001692	1365		
+171407365G	7476102	1327 1359	6N0407182	2256008	1365 1387		
171407153D			6N0407365	9005270	1365 1389		
+171407365G	7476103	1327 1359	6N0407365A	9005269	1365 1389		
			6N0411315	9005080	1364 1385		

Les références constructeurs (origine) ne servent qu'à identifier les pièces et sont données à titre indicatif.
References from carmakers or OE suppliers, are given for identification of the parts and have only a guidance value.



CORRESPONDANCE ORIGINE ⇨ SASIC
CROSSING LIST O.E ⇨ SASIC

MARQUE Make	OE	SASIC		MARQUE Make	OE	SASIC	
VOLKSWAGEN	6N0411315D	2306001	1364 1386	VOLKSWAGEN	Part/oe 1H0422803	9006218	1354 1367
	6N0412303A	2656008	1390		Part/oe 1J0422803H	9006219	1314 1336
	6N0412331A	9005616	1366 1389		Part/oe 1J0422804H	9006219	1309
	6N0412331E	9005623	1390		Part/oe 1J0422807A	9006213	1336
	6N0413175A	2656053	1313 1324 1345 1350		Part/oe 2D0422803	9006848	1427
	6N0413175A	2656053	1361 1378 1382 1390		Part/oe 2E0713491	7776017	1425
	6N0413175A	2656053	1402 1406 1410 1415		Part/oe 3A0422803C	9006214	1367
	6N0413175A	2656053	1424		Part/oe 3A0422804C	9006214	1317
	6N0419811	9006619	1363 1384		Part/oe 6K0422803E	9006872	1384 1420
	6N0419812	9006618	1363 1384		Part/oe 6K0422821A	9006871	1420
	6N0501541D	9001703	1366 1392		Part/oe 6N0419804	9006234	1383
	6N0512131A	9005366	1391		Part/oe 6N0422803A	9006235	1383
	6Q0407151L	9005758	1388		Part/oe 6N0422804A	9006235	1383
	6Q0407182A	2256038	1387		Part/oe 6N0422804C	9006869	1363 1384
	6Q0407183A	2256001	1387		Part/oe 6Q0423803E	9006251	1383
	6Q0407365M	9005478	1389 1394		Part/oe 6R0423803A	7776079	1392
	6Q0407366M	9005479	1389 1394		Part/oe 6X0419803A	9006250	1363
	6Q0411314F	2306015	1386		Part/oe 6X0422804	9006251	1363 1384
	6Q0411314P	2306017	1386 1393 1396		Part/oe 7H0419804F	7776071	1432
	6Q0411314Q	2306018	1386 1393		Part/oe 7L0422803D	7776024	1411
	6Q0411314R	2306019	1386 1393		Part/oe 7M3422804A	9006229	1404
	6Q0411315N	9005089	1385 1393		Part/oe 811419801E	9006244	1398
	6Q0412301A	2656048	1390		Part/oe 811419802J	9006245	1398
	6Q0423810C	9006874	1384				
	6Q0423811	9006634	1385				
	6Q0423812	9006635	1385				
	6R0407151F	7476091	1394				
	6R0407152F	7476092	1394				
	6R0407365A	7576019	1394 1397				
	6R0407366A	7576020	1394 1397				
	6R0423811	9006634	1393				
	6R0423812	9006635	1393				
	6R0501541A	2606001	1314 1317 1341 1392				
	6R0501541A	2606001	1396				
	6R0513353B	2656057	1395				
	6X0411313	2306020	1364 1386				
	6X0411313A	2306021	1364 1386				
	6X0422811	9006628	1364 1385				
	6X0422812	9006629	1364 1385				
	701407187B	9005476	1431				
	701407361B	9005474	1431				
	701419810	9006867	1430				
	701419810A	9006868	1430				
	701419811A	9006623	1430				
	701419811B	9006624	1430				
	701419811C	9006630	1430				
	701419811E	9006632	1432				
	701419812	9006621	1430				
	701419812A	9006622	1430				
	701419812B	9006631	1432				
	701419812D	9006633	1430				
	7D0407361	9005477	1431				
	7D0411049	2306002	1431				
	7E0412331	2656060	1433				
	7H0407151F	7476190	1433				
	7H0407152F	7476191	1433				
	7H0407361A	7576024	1433				
	7H0422817D	7676020	1432				
	7H0422818D	7676019	1432				
	7H0501132A	2256058	1434				
	7H5411317A	2306003	1432				
	7H5511414	2306114	1434				
	7H8407361A	7576025	1433				
	7L0407021B	7476034	1412				
	7L0407151H	7476037	1412				
	7L0407152H	7476035	1412				
	7L0407183A	2256050	1411				
	7L0422817D	7676022	1411				
	7L0422818D	7676021	1411				
	7M0407151B	9005751	1405				
	7M0407152B	9005752	1405				
	7M0407181A	9001763	1405				
	7M0411031	9001779	1404				
	7M0501541	9001436	1405 1407				
	7M3407365C	9005247	1406				
	7M3422817	9006460	1404				
	7M3422818	9006459	1404				
	811419812	9006382	1321 1384 1398				
	811419812A	9006300	1398				
	823407181	9001524	1387				
	823407365E	9005200	1399				
	855407365B	9005201	1399				
	861407151B	9005132	1388				
	861407183	9001525	1387				
	861511271	9001697	1392				
	861512131A	9005367	1391				
	867411313	9001526	1386				
	867419507	9004011	1385				
	871412323A	8005201	1321 1389				
	871419801A	9006237	1384				
	8D0407509G	9005747	1372				
	8D0407510G	9005748	1372				
8D0411317D	9005086	1370					
8D0411318D	9005096	1370					
8D0412131E	2656009	1374					
8D0412131F	9005326	1374					
8E0407505A	9005140	1372					
8E0407506A	9005141	1372					
8E0407693AG	9005156	1373					
8E0407694AG	9005154	1373					
8E0513353B	9005621	1374					
8Z0411314B	2306022	1386					
Part/oe 191419803	9006210	1328 1357 1399					
Part/oe 191422803A	9006217	1328 1357 1399					
Part/oe 1H0419803	9006211	1331 1416 1367					
Part/oe 1H0422803	9006218	1331 1416 1317 1352					
				VOLVO	1359347	9006282	1436 1437 1438
					270477	9005419	1437 1438 1439 1440
					271598	9006612	1439 1443 1452
					271599	9006611	1439 1443 1452
					272336	9005788	1444
					272337	9005787	1444
					274175	9006614	1452
					274176	9006613	1452
					274179	9006879	1448 1454 1455 1456
					274225	9006617	1445
					274226	9006615	1445
					274353	9006879	1452
					274548	9005582	1449 1454 1455 1456
					30635229	7476220	1448 1453
					30635230	7476219	1448 1453
					30714128	2256020	1441 1445 1450
					30761718	9006613	1448 1454
					30761719	9006614	1448 1454
					30818467	2256044	1445
					30872510	2256041	1446
					30872511	2256042	1446
					30875012	9006693	1444
					30884179	2306067	1445
					30884358	2306069	1445
					30887025	9005790	1446
					30887033	9005789	1446
					30889962	9005790	1446
					30889963	9005789	1446
					31201485	7576038	1449 1454 1456
					31201817	9006839	1440 1442 1444 1449
					31277343	7476043	1453 1455 1449 1452
					31277344	7476042	1453 1455
					31277462	7476193	1442 1443 1447 1450
					31277463	7476192	1442 1443 1447 1450
					31277464	9005814	1441 1443 1447 1450
					31277465	9005813	1441 1443 1447 1450
					31302344	7676025	1448 1451 1453 1455
					31302344	7676025	1456
					31302345	7676024	1448 1451 1453 1455
					31302345	7676024	1456
					31317662	7476042	1449 1452
					3211955	9006608	1435
					3268829	9006281	1435
					3410369	9006283	1435 1436
					3468941	9004017	1435 1436
					3480012	9006609	1435 1436
					3516944	9006610	1436 1437 1438 1440
					8623576	2306024	1441 1443 1445 1449
					8628495	9005786	1439 1453
					8628496	9005784	1439 1453
					8628497	9005788	1453
					8628498	9005787	1453
					9140504	9006285	1436 1437 1438 1440
					Part/oe 31277462	7576041	1442 1444 1447 1451
					Part/oe 31277464	9005527	1442 1444 1447 1451
					Part/oe 31280658	7776025	1448 1451 1452 1455
					Part/oe 3345797	9006880	1444
					Part/oe 3410412	9006878	1435 1436

Cross OE > SASIC

DÉPÔTS RÉGIONAUX

Ets BG DISTRIBUTION

1350 Av. Louis Roche
92230 GENNEVILLIERS
☎ : 01 41 21 05 45
Fax : 01 41 21 07 87

MAGASIN CENTRAL PUTANGES

Zone industrielle
61210 PUTANGES
☎ : 02 33 67 80 20
Fax : 02 33 67 80 29

Ets ADIPA

10 Rue du Lamineur
BP 20381
44819 SAINT - HERBLAIN
☎ : 02 40 92 21 21
Fax : 02 40 92 23 24

Ets BEZIAT

34 rue Marcel Delattre BP131
33321 BEGLES Cedex
☎ : 05 56 49 54 44
Fax : 05 56 49 00 26

Ets CEDIS

82 rue de Fenouillet
31200 TOULOUSE
☎ : 05 61 47 92 44
Fax : 05 61 57 30 99

Ets NORD ÉQUIP'AUTO

40, rue Chaland
59790 RONCHIN
☎ : 03 20 53 37 43
Fax : 03 20 52 90 20

Ets FED SERVICES

48, Av. de la Paix
54510 TOMBLAINE
☎ : 03 83 18 01 70
Fax : 03 83 18 01 79

Ets CENTRAL DEPOT

4 rue Etienne Dolet
Zi des Forges
18100 VIERZON
☎ : 02 48 71 33 99
Fax : 02 48 75 42 94

Ets CDAL

8 rue de Bourgogne
69800 ST PRIEST
☎ : 04 37 56 15 15
Fax : 04 37 56 15 16

Ets MARSEILLE DÉPÔT

375 Bd National
13003 MARSEILLE
☎ : 04 91 50 70 44
Fax : 04 91 50 07 70

DÉPÔTS A L'ÉTRANGER

Warehouses abroad

ITALY

FULL PARTS S.r.l
47853 CORIANO (RN)

PHONE : +39 0541 793084
www.fullparts.it

POLAND

LOGISTICS SERVICE

PHONE : +33 (1) 30 25 78 40
FAX : +33 (1) 30 25 78 49
ser.exp@sasic.fr



Traductions et abréviations Translations & abbreviations

FRANCAIS	ENGLISH	ESPAGNOL	DEUTSCH	POLSKI	RUSSE
A partir de	From	Desde	Ab	Od	з
Année	Year	Año	Jahr	Rok	Год
Avec	With	Con	Mit	Z	С
Avec climatiseur	With air conditioning	Aire acondicionado	Mit Klimaanlage	Z klimatyzacja	С кондиционер
Berline	Saloon car	berlina	Limousine	Sedan	Седан
Break	Station wagon	Familiar	Kombi	Kombi	SW
Catalytique	Catalytic	Catalítico	Katalysator	Katalisator	КАТАЛИТИЧЕСКИЕ
Côté berceau	Frame side	Lado cuna	Rahmenseite	Od strony belki	сторона опоры
Côté opposé au pignon	Opposite pinion side	Lado opuesto al piñón	Gegenüberliegende Seite des Ritzel	Strona przeciwna do kola	стороны противоп. шестерни
Côté pignon	Pinion side	Lado piñón	Ritzelseite	Od strony kola	Боковой фронтон
Côté pivot	Pivot side	Lado pivote			Сторона поворота
Et	And	Y	Und	Ed	и
Fourgonnette	Van	Furgón	Lieferwagen	Furgonetka	фургон
Long. tube int.	Length tube inner	Long. tubo int.	Länge Rohr Innen	Długosc rury wew.	длина труба внутри
Modèle	Model	Modelo	Modell	Model	модель
Observations	Remark	Observaciones	Bemerkungen	Uwagi	наблюдения
Pour	For	Para	Fur	Do	Для
Sans	Without	Sin	Ohne	Bez	без
Sauf	Except	Excepto	Außer	Zwyjtkiem	кроме
Susp. active	active susp.	Susp. active	Active fahrwerk	Zaw. active	подвески active
Susp. renforcée	Reinforced susp.	Susp. reforzada	Verstärktes fahrwerk	Zaw. wzmacnione	подв. усиленная
susp. réhaussée	heightened susp.	Susp. realzada	Erhöhtes fahrwerk	Zaw. podwyższone	подв. руки цветные
Susp. variable	Variable susp.	Susp. variable	Variablen fahrwerk Regulowanym	Zawieszaniem	перем. подвески

ABS	Système anti blocage des roues	Antiskid system	Systema contra casquijo	Antiblockiersystem	ABS	АБС
AR	Arrière	Rear	Trasero	Hinten	Tyl	задн.
Auto	Automatique	Automatic	Automático	Automatisch	Automat	автоматический
AV	Avant	Front	Delantero	Vorn	Przod	передн.
BVA	Boîte automatique	Automatic gearbox	Caja de velocidades automatica	Automatisches Getriebe	Skrzynia automatyczna	АКМ
BVM	Boîte manuelle	Mechanical gearbox	Caja de velocidades mecánica	Mechanische Getriebe	Skrzynia manualna	РКП
Cab.	Cabriolet	Convertible	Cabriolet	Kabriolett	Kabriolet	Cab.
-ch	Jusqu'au chassis N°	Up to chassis Nr	Hasta bastidor N°	Bis Fahrgestell Nr.	Do nadwozia	к кузова Номер
Ch-	Depuis chassis N°	From chassis Nr	Desde bastidor N°	Ab Fahrgestell Nr.	Od nadwozia	з кузова Номер
Coll.	Collerette	Flange	abrazadera	Flansch	kol.	ворот
D	Diesel	Diesel	Diesel	Diesel	Diesel	Дизел
DNA	Direction non assistée	Manual steering	Dirección mecánica	Manuelle Lenkung	Bez wspomagania Kierownicy	редуктор управления
DA	Direction assistée	Power steering	Dirección asistida	Servolenkung	Ze wspomaganiam Kierownicy	усилитель управления
D	Droit	Right	Derecha	Rechts	Prawa	правый
E	Essence	Gasoline	Gasolina	Benzin	Benzyna	сущность
Ep. Coll	Epaisseur collerette	Flange th.	Esp. abraz.	Dicke Flansch	Gr. kol.	Підсос ворот
Ext.	Extérieur	Outer	Exterior	Außen	Zewnetrzny	наруж.
G	Gauche	Left	Izquierda	Links	Léwa	левого
G/D	Gauche et droite	Left and right	Izquierda y derecha	Links und rechts	Lewa i prawa	левого и правый
Inj.	Injection	Injection	Inyección	Injektion	Wtrysk	Впрыскивание
Int.	Intérieur	inner	Interior	In	Wewnetrzny	внутри
mot.	Moteur	Engine	Motor	Motor	Silnik	Двигатель
-M	Jusqu'au moteur N°	Up to engine Nr	Hasta motor N°	Bis motor Nr.	Do silnika Nr	к Двигатель Номер
M-	Depuis moteur N°	From engine Nr	Desde motor N°	Ab motor Nr.	Od silnika Nr	з Двигатель Номер
v.	Soupapes	Engine valves	Valvulas	Ventils	Zawór	Клапан
TT	Tous types	All models	Todos modelos	Alle Type	Wszystkie typy	Все модели
TD	Turbodiesel	Turbodiesel	Turbo diesel	Turbo diesel	Turbodiesel	турбо Дизел
vit.	Vitesses	Speeds	Velocidad	Geschwindigkeit	Prędkosc	Скорость
	Avec roulement	With bearing	Con rodamiento	Mit Lager	Z lozysko	С Кольцо

Traductions Translations

FR	UK	DE
Amortisseur vibrations	Shock absorber bolt	Schwingungsdämpfer
Appui ressort	Support spring	Auflager Feder
Art. balancier pont	Beam bush	Gelenk Achsbrücke
Art. barre anti-devers	Anti-banking bar bush	Gelenk Fahrwerkstabilisierung
Art. barre Panhard	Rod bush Panhard	Gelenk Strebe Panhard
Art. bielle de réaction	Track rod bush	Spurstangengelenk
Art. de fusée	Swivel bush	Gelenk Achsschenkel
Art. jumelle lame ressort	Spring shackle bush	Gelenk Lasche Blattfeder
Art. lame ressort	Spring leaf bush	Gelenk Querblattfeder
Art. œil de crémaillère	Eye rack bush	Gelenk Zahnstangenauge
Art. support mot.	Engine mounting bush	Gelenk Motorlager
Art. tirant de chasse	Rod bushing	Gelenk Zugstrebe Nachlauf
Articulation	Bushing	Gelenk
Articulation amortisseur	Shock absorber bush	Stoßdämpferbuchse
Articulation berceau	Cradle bush	Wiegegelenk
Articulation Bras	Arm bush	Armelenk
Articulation cent. Bras	Middle arm bush	Mittleres Armgelenk
Articulation chape	Tread bush	Gabelgelenk
Articulation essieu	Axle bush	Gelenk Achse
Articulation lame	Leaf bush	Gelenk Querblatt
Articulation porte moyeu	Hub seat bush	Gelenk Nabe
Articulation traverse	cross bar bush	Gelenk Querstrebe
Articulation triangle	Track control arm bush	Gelenk Dreieckslenker
Articulation vérin DA	Power steering cylinder bush	Zylindergelenk Servolenkung
Bague de palier AR	Rear bearing ring	Lagerbuchse hinten
Batteur support éch. Central	Middle exhaust bushing	Mittlere Auspuffaufhängung
Bielle de poussée	Cross rod	Schubstange
Bielle de réaction	Track rod	Spurstange
Biellette barre stabilisatrice	Stabilizer bar stub axle	Stabilisatorstrebe
Biellette support	Rod holder	Halterung Verbindungsstrebe
Bouchon caoutchouc	Rubber plug cap	Gummistopfen
Butée à billes	Ball bearing	Kugellager
Butée attaque	Bushing	Anfahranschlag
Butée de choc	Bumper buffer	Stoßstangenlager
Butée de suspension	Shock bush	Fahrwerkklager
Butée de talonnage	Bushing	Lager
Butée protecteur	suspension bush	Sicherheitsanschlag Fahrwerk
Butée support moteur AV	Front engine mounting bush	Motorlagerbuchse vorne
Butoir de suspension	Bushing	Anschlag Fahrwerk
Chape	Tread	Gabelgelenk
Climatisation	AC	Klimaanlage
Coiffe de support moteur	Engine mounting cap	Kappe Motorlager
Colonnnette	Rubber	Abstandhalter
Colonnnette filtre à air	Air filter spacer	Abstandhalter Luftfilter
Colonnnette ligne échap.	Exhaust strap	Abstandhalter Auspuffanlage
Colonnnette silencieux échap.	Exhaust rubber	Abstandhalter Schalldämpfer Auspuff
Coupelle	Cup	Teller
Coupelle amortisseur	Shock absorber cup	Teller Stoßdämpfer
Coupelle rebond.	Spring cup	Federteller
Coupelle ressort	Spring cup	Federteller
Embase corps inj. mono point	Base plate monotronic flange cradle	
Flector de direction	Steering flector	Biegegelenk Lenkung
Jeu de 2 Art. de bras	Set of 2 arm bushes	Satz 2 Armgelenk
Jeu de 2 articulations	Set of 2 bushes	Satz 2 Gelenk
Joint amortisseur	Shock absorber gasket	Dichtung Stoßdämpfer
Kit rép. Flector de direction	Flector repair kit	Reparatursatz Biegegelenk Lenkung
Kit rép. Protecteurs de dir.	Flector repair kit	Reparatursatz Schutzmanschetten Lenkung
Kit rép. Support susp.	Susp. Mounting repair kit	Reparatursatz Aufhängung
Kit. Rép. Colonnnette	Rubber repair kit	Reparatursatz Abstandhalter
Liaison élastique	Elastic link	Elastische Verbindung
Limiteur de débattement	Wheelbase stop	Hubbegrenzer des Schwingungsdämpfers
Limiteur support moteur	Engine mounting limitation	Begrenzer Motorlager
Palier arbre de cardan	Drive shaft main bearing	Lager Kardanwelle
Palier de barre	Bar main bearing	Strebenlager
Palier de barre bout	End bar main bearing	Strebenendlager
Palier de barre milieu	Middle bar main bearing	Strebenmittellager
Plot	Pin	Kontakt
Protecteur amortisseur	Shock absorber protector	Schutzkappe Stoßdämpfer
Protecteur de direction	Steering protector	Schutzkappe Lenkung
Sangle échappement	Exhaust strap	Aufhängungsgummi Auspuff
Sans climatisation	Without AC	Ohne Klimaanlage
sans filtre à particules	Without DPF	ohne Rußpartikelfilter
Silentbloc essieu	Axle silentbloc	Gummidämpfer
Silentbloc pont	Axle silentbloc	Gummidämpfer
Support BV	Gearbox mounting	Halterung Getriebe
Support central arbre trasm.	Middle mounting prop shaft	Mittelhalterung Antriebswelle
Support échappement	Exhaust pipe mounting	Halterung Auspuff
Support essieu	Axle mounting	Halterung Achse
Support moteur	Engine mounting	Motorlager
Support suspension	Suspension mounting	Aufhängung
Support train AR	rear axle mounting	Halterung Hinterachse
Support traverse	Cross bar mounting	Halterung Querstrebe
suspension	Suspension	Fahrwerk
Suspension hydractive	Hydractive suspension	Hydractive-Fahrwerk
suspension normale	Normal suspension	Normales Fahrwerk
Tampon élastique	Snubber	Federpuffer
Tampon suspension	Susp. Rebound stop	Fahrwerkklager
Tirant Berceau	Cradle pin	Zugstrebe Wiege
Tirant de chasse	Bushing	Zugstrebe Nachlauf

Traductions Translations

ES	RU	PL
Amortiguador de vibraciones	Гаситель колебаний	amortyzator drgan
Apoyo	Опорная пружина	mocowanie sprzynna
Articulación balancín puente	Втулка балки	tuleja wahacza mostu zownowagi
Articulación barra estabilizadora	Втулка штанги противокачения	Przegub drążka stabilizatora
Articulación barra Panhard	Втулка Panhard	tuleja drazka Panhard
Articulación biela de reacción	Стержень обратной тяги	tuleja drazka reakcyjnego
Articulación de mangueta	Втулка шарнирного соединения	tuleja zwrotnica
Articulación Pieza de unión de hoja de ballesta	Втулка серьги рессоры	wieszak pióra resoru
Articulación ballesta	Втулка листа рессоры	tuleja pióra resoru
Articulación Ojo de cremallera	Втулка зубчатой рейки	tuleja ucha zebatki
Articulación Soporte motor	Втулка крепления двигателя	tuleja wspornika silnika
Articulación tirante de avance del pivote	Втулка шатуна	tuleja drazka poprzecznego zwrotnicy
Articulación	Сайлент-блок	przegub
Articulación amortiguador	Втулка амортизатора	tuleja amortyzatora
Articulación cuna	Опорный вкладыш	tuleja belki
Articulación brazo	Шарнирная траверса	tuleja ramienia
Articulación cent. brazo	Центральная шарнирная траверса	tuleja srod. ramienia
Articulación brida	Карданный шарнир	tuleja uchwytu
Articulación eje	Втулка оси	Przegub tylniej
Articulación hoja	Вкладыш-пластинка	tuleja pióra
Articulación cubo	Втулка седла	tuleja przewoznik centrum
Articulación traviesa	Втулка траверсы	tuleja belki poprzecznej
Articulación triángulo	Втулка поперечной тяги подвески	tuleja wahacza
Articulación cilindro DA	Втулка цилиндра рулевого управления	Przegub siłownika
Anillo de cojinete TRAS.	Кольцо заднего подшипника	pierscien lozyska tylnego
Batidor soporte escape central	Центральный вкладыш выхлопной системы	amortyzator wspornika układu wydechowego srodkowy
Biela de empuje	Поперечная тяга	drażek przenoszący
Biela de reacción	Тяга поперечной устойчивости	drażek reakcyjny
Bieleta barra estabilizadora	Поворотная цапфа стабилизатора поперечной устойчивости	łącznik drazka słab.
Bieleta soporte	Крепление тяги	łącznik wspornika
Tapón caucho	Резиновая заглушка	korek gumowy
Tope de bolas	Шариковый подшипник	łożysko kulkowe
Tope de ataque	Сайлент-блок	Tuleja
Tope de choque	Демпфер бампера	zderzak
Tope de suspensión	Упорная втулка	odbój zawieszenia
Tope de calibración	Сайлент-блок	odbój krancowy
Tope protector susp.	Втулка подвески	odbój osłony zaw.
Tope soporte motor DEL.	Втулка передней опоры двигателя	odbój wspornika silnika przedni
Tope de suspensión	Сайлент-блок	zderzak zawieszenia
Brida	Хомут	uchwytu
climatización	Кондиционер	klimatyzacja
Tapa de soporte motor	Наконечник крепления двигателя	osłona prawego wspornika
columna	Резиновая прокладка	sworzen
Col. filtro de aire	Прокладка воздушного фильтра	sworzen filtra powietrza
Columna línea de escape	Крепление выхлопной трубы	sworzen rury wydechowej
Columna silencioso escape	Резиновая прокладка выхлопной системы	sworzen tłumika
copela	Манжета	miseczka
Copela amortiguador	Демпферная манжета	miseczka amortyzatora
Copela rebote	Стакан нажимной пружины	miseczka odb.
Copela muelle	Стакан нажимной пружины	miseczka sprzynny
	Фланцевая моноопора установочной плиты	oprawka korpusu wtrysku jednopunktowego
Flector de dirección	Муфта типа "Флектор" для рулевого механизма	przegub układu kierowniczego
Juego de 2 Articulacións brazo	Комплект из 2 шарнирных траверс	luz 2 tuleja ramienia
Juego de 2 Articulacións	Комплект из 2 втулок	luz 2 tuleja
Junta amortiguador	Уплотнительное кольцо амортизатора	uszczelka amortyzatora
Kit rep. flector de dirección	Ремкомплект "Флектор"	zestaw naprawczy przegubu ukl. kier.
Kit rep. protectores de dir.	Ремкомплект "Флектор"	zestaw naprawczy oslon ukl. kier.
Kit rep. Soporte suspensión	Ремкомплект крепления подвески	wspornik zawieszenia
Kit rep. Columna	Резиновый ремкомплект	zestaw naprawczy trzpienia
Unión elástica	Гибкое соединение	polaczenie elastyczne
limitador de oscilación	Ограничитель хода	ogranicznik wychylenia
limitador de Soporte motor	Ограничитель крепления двигателя	ogranicznik wspornika silnika
Cojinete árbol de cardán	Коренной подшипник вала привода	łożysko walu kardanowego
Cojinete de barra	Коренной подшипник штанги	łożysko drazka
Cojinete de barra extremo	Коренной подшипник концевой штанги	łożysko drazka koncowe
Cojinete de barra central	Коренной подшипник центральной штанги	łożysko drazka srodkowe
contacto	Шпилька	kolek
Protector amortiguador	Защита смортизатора	osłona amortyzatora
Protector de dirección	Защита рулевого управления	Osłona układu kierowniczego
Correa de escape	Крепление выхлопной трубы	opaska układu wydechowego
Sin climatización	Без кондиционера	bez klimatyzacji
sin filtro de particulas	Без сажевого фильтра DPF	bez filtra czasteczek
Silentbloc eje	Сайлентблок оси	amortyzator gumowy osi
Silentbloc puente	Сайлентблок оси	amortyzator gumowy mostu
Soporte CC	Опора коробки передач	wspornik skrzyni biegów
Soporte central Arbol de transmisión	Центральное крепление карданного вала	wspornik srodkowy wal napedowy
Soporte escape	Крепление выхлопной трубы	wspornik układu wydechowego
Soporte eje	Крепление моста	wspornik os
Soporte motor	Опора двигателя	wspornik silnika
Soporte suspensión	Опора подвески	wspornik zawieszenia
Soporte tren TRAS.	Крепление заднего моста	wspornik zawieszenia tylnego
Soporte traviesa	Крепление траверсы	wspornik belki poprzecznej
suspensión	Подвеска	zawieszenie
suspensión Hydractive	Гидроактивная подвеска	zawieszenie Hydractiv.
suspensión normal	Обычная подвеска	zawieszenie normalne
Tampón elástico	Пружинный буфер	zderzak elastyczny
Tampón suspensión	Буферная подвеска	zderzak zawieszenia
Tirante Cuna	Распорный болт	drażek poprzeczny belka
tirante de avance del pivote	Сайлент-блок	drażek poprzeczny zwrotnicy



SASIC à l'international - Conditions générales de vente

SASIC - general terms of sales

1/ GÉNÉRALITÉS :

Toute remise de commande ou passage de marché avec notre Société comporte acceptation implicite par l'acheteur, des conditions ci-dessous.

La réception de notre accusé de commande sans réserve écrite immédiate, vaut donc acceptation de ces conditions. Il ne pourra y être dérogé que par mention écrite figurant sur nos offres ou accusés de réception de commandes.

2/ PRIX ET CONDITIONS DE LIVRAISON :

Les prix de notre Tarif Général, de nos tarifs particuliers, ou ceux donnés à nos clients par nos représentants, n'ont qu'une valeur indicative. Ils peuvent être modifiés sans préavis et ne nous lient pas à terme. Sauf spécification formelle, la validité de nos offres ne dépasse pas 30 jours.

Dans tous les cas le contrat de vente ne devient effectif qu'après acceptation écrite de la commande par notre Service Export, le prix facturé normalement étant celui en vigueur à la date de mise à disposition. Sauf conditions particulières écrites, nos prix unitaires calculés en Euros s'entendent " Départ usine - PUTANGES - Orne". Ils n'incluent pas l'emballage et le transport qui sont calculés en sus. La livraison est réputée, effectuée dans notre usine et les conditions de vente telles que Franco Transitaire F.O.B. ou C.A.F ne sont considérées que comme des concessions de prix sans déplacement de responsabilité ; nos prix à l'Export sont nets hors taxes.

Les marchandises voyagent donc aux risques et périls de l'acheteur auquel il appartient de prendre toutes dispositions auprès des transitaires, transporteurs, assureurs, etc... pour protéger ses intérêts. A cet égard, l'acheteur est réputé assurer les marchandises dans tous les cas de vente non C.A.F., contre les risques de vol, perte, avarie ou destruction. En cas de dommages survenus au cours du transport, la responsabilité du fournisseur ne sera pas engagée.

SASIC pourra cependant aider l'acheteur à sauvegarder ses intérêts, dans la mesure où toutes les dispositions nécessaires auront effectivement été prises par l'acheteur lui-même.

3/ DÉLAIS DE LIVRAISON :

Ils sont donnés à titre indicatif et sans engagement. Un retard de livraison quelle qu'en soit la raison ne peut justifier l'annulation ou la suspension d'une commande par l'acheteur. Il ne pourra en aucun cas donner lieu à des pénalités ou à des indemnités. Cela vaut également pour les livraisons partielles.

Le respect des délais dépend aussi de la stricte observation des conditions de paiement. A défaut d'obtention de garanties suffisantes, une commande pourra être refusée et un marché même préalablement accepté, pourra être suspendu ou annulé sans indemnité.

4/ CONDITIONS DE PAIEMENT, INTÉRÊTS DE RETARD :

Sauf conditions particulières écrites, le paiement s'effectue en nos bureaux, comptant à réception de facture et sans escompte. Dans le cas du non respect par l'acheteur des échéances convenues tout retard dans le paiement entraîne de plein droit, le jour suivant la date de règlement figurant sur la facture, l'exigibilité d'intérêts de retard à un taux égal à trois fois le taux d'intérêt légal conformément à l'article L.441-6 du Code de commerce, ainsi qu'une indemnité forfaitaire pour frais de recouvrement d'un montant de 40 Euros suivant l'article D.441-5 du Code de commerce. La totalité de la dette non échue deviendrait de plein droit immédiatement exigible avec possibilité pour SASIC de suspendre ou annuler les commandes en cours.

Les taux ci-dessus seront réajustés automatiquement selon l'évolution du taux de l'intérêt légal et des taux du marché monétaire en France.

5/ RÉSERVE DE PROPRIÉTÉ DES MARCHANDISES :

Application des lois 80-335 du 12 Mai 1980 et 85-98 du 25 Janvier 1985.

Les marchandises facturées par SASIC demeurent sa propriété jusqu'au paiement intégral du prix convenu et de ses accessoires. Jusqu'à cette date, les marchandises seront considérées comme étant en dépôt chez l'acheteur qui en assumera la responsabilité depuis la sortie de notre Usine ou de nos Dépôts. En cas de non paiement à l'échéance contractuelle, elles devront être restituées sans formalité, dès la première demande de SASIC, qui se prévaut des dispositions prévues par la loi en cas de redressement et de liquidation judiciaire de l'acheteur.

6/ RÉCLAMATIONS - GARANTIE :

SASIC fabrique et distribue des pièces détachées adaptables aux véhicules automobiles. Si malgré les soins apportés à la fabrication comme à la sélection de nos fournisseurs, il était reconnu que nos fournitures comportaient un défaut de matière ou de fabrication, SASIC ne serait tenue qu'à la réparation gratuite par ses soins, ou à son choix, au remplacement des pièces défectueuses. Dans le cas où la réparation ou le remplacement s'avérerait impossible pour quelque raison que ce soit, SASIC ne serait tenue qu'au seul remboursement de la valeur des pièces défectueuses facturées sans prise en compte de frais supplémentaires ni indemnité d'aucune sorte. Cela s'applique également en cas de livraison non conforme.

Dans tous les cas, la garantie ne peut être mise en oeuvre qu'après réclamation écrite, adressée au plus tard 60 jours après la facturation des marchandises et après examen par nous-mêmes suivi de notre accord sur le bien fondé de la réclamation. Aucune réclamation ne sera acceptée en cas de montage incorrect, de réparation locale ou de rénovation de nos pièces.

La garantie ne couvre que les produits vendus sous la marque SASIC et figurant dans nos documentations. Nous déclinons toute responsabilité en cas d'erreur de références ou de désignation par l'acheteur et nous n'acceptons pas, dans de tels cas, le retour des pièces.

Lorsqu'après accord du Service Export SASIC et en l'absence de faute du fournisseur, un retour de pièces est accepté, tous les frais de retour et de déballage sont à la charge de l'acheteur.

7/ MINIMUM DE COMMANDE - FRAIS ADMINISTRATIFS :

Nous n'acceptons pas les commandes inférieures à 1000 Euros.

Pour les expéditions par Colis Postaux, les prix habituels sont majorés de 10 %.

Pour toute facturation n'atteignant pas un montant Départ Usine de 1000 Euros, des frais forfaitaires de 100 Euros s'ajouteront au montant des marchandises.

Ces frais atteindront 7 % du montant des marchandises pour les expéditions d'une valeur de 1 000 à 2 000 Euros.

8/ ATTRIBUTION DE JURIDICTION :

Pour tous litiges y compris en cas d'appel en garantie ou de pluralité de défendeurs, les Tribunaux du siège de la Société SASIC seront seuls compétents et la Loi Française s'appliquera.

1/Application :

The following general terms of sales will be deemed to be accepted for any order placed with us, in absence of immediate partial or total written refusal of these terms. No change in these terms will be valid without our written acceptance.

2/Prices and delivery terms :

Prices of our General Export price list or of our special price lists, or those given by our representatives or agents, have only guidance value. They do not bind us. They can be modified without notice.

Except in the case of different written indications, our offers are not valid after 30 days.

In any case sales contracts will not be valid before the written acceptance by our Export Department, of our customers orders. We normally charge prices which are in force the day of the delivery. Under normal conditions, our unit prices are net exworks -Putanges Orne- they are calculated in Euros and do not include packing and inland or sea freight which have to be added. They are "before tax". The delivery is deemed to be effected in our factory and any delivery term such as free carrier, Fob or even CIF should be considered only as facilities granted to customers without any consequence on the customer's responsibility on the goods.

Our goods travel under the responsibility and at the risk of our customers. They should take any necessary step near forwarding agents, carriers, insurance companies etc... to protect their interests.

Should goods be damaged between our factory and the customers warehouse, our responsibility would not be involved. We might however assist our customers to protect their interests in as much as any necessary step has actually been taken by our customers themselves. In this respect the customer is deemed to insure the goods when sales terms are not CIF, against all risks of pilferage, fire, damage by water, destruction etc...

3/Delivery time :

It is only given for information purpose and does not bind us. A late delivery can not justify a cancellation of the order by the purchaser. It will in no case justify any request for indemnity. This also applies to partial deliveries.

Failure by the customer to fulfill his financial commitments will involve postponed deliveries. In the event of inadequate financial guarantees, SASIC will be entitled to refuse orders or even to postpone or to cancel orders or contracts already accepted, without any indemnity for the purchaser.

4/Payments :

Except in the case of special written terms, they will be effected cash, without any cash discount, in our offices immediately upon receipt of our invoices. Should the buyer do not respect the agreed expiry date, any late payment automatically generates in full's right, the day following the date of payment mentioned on the invoice, the payability of interests calculated at a legal rate of three times the legal rate as defined in article L.441-6 of the French Code of Commerce as well as a fixed fee of 40 Euros for covering up cost following art. D.441-5 of the French Code of Commerce., and SASIC could require the payment of the whole customer's debt even if not yet due for payment. SASIC could also postpone or cancel any order in course.

Above rates will automatically be adjusted every year, taking into consideration variations of the legal rates and of the French Monetary Market.

5/Ownership of the goods: (french laws 80-335 of 12-05-80 and 85-98 of 25-01-85)

SASIC remains the owner of goods invoiced, as long as they have not been entirely paid by the purchaser.

Until then, goods are deemed to be entrusted to the purchaser who becomes responsible, as soon as they leave our factory or our bonds. Should the payment not be effected on due date, goods will be restituted at SASIC's first request without any formality. SASIC will also use legal procedures and privileges granted by the French law to suppliers in case of legal supervision or compulsory liquidation by the court, of our customers.

6/Claims guarantee :

SASIC manufactures and distributes replacement parts for cars. The greatest cares are given to the manufacturing process or to the selection of top level suppliers. In case however of a latent or obvious defect, raw material or machining... SASIC's responsibility would be limited to the free repair or if we choose, to the free replacement of defective parts, only. Should, for any reason, repair or replacement be impossible SASIC responsibility would be limited to the reimbursement of goods invoiced, and we would not take into account any extra charges or indemnity. This also applies to wrong deliveries. In any case no guarantee will be applicable without a written claim sent to SASIC within 60 days following the issue of SASIC invoices, and before SASIC acceptance of the claim being fully justified. It is limited to actual genuine SASIC goods, packed in our SASIC boxes or bags and mentioned in our catalogues. No claim will be accepted in case of wrong fitting, local repair or rebuilding of our parts. We refuse any responsibility in case of wrong references or description used by the purchaser and we shall not accept in these cases the return of the goods or their reimbursement. If, in absence of mistake by SASIC, and after approval by our Export Department a return of goods was effected, any corresponding charges : freight - unpacking etc... would be borne by the purchaser.

7/Minimum value - administrative cost :

We do not accept orders the value of which would not reach 1000 Euros.

In case of deliveries by parcel post, usual prices will be increased by 10 %.

For any delivery under 1000 Euros ex works, a lump amount of 100 Euros, will be added to the value of the goods.

This amount will reach 7 % of the value of the goods for deliveries between 1 000 à 2 000 Euros.

8/Jurisdiction :

In the event of claims of any kind, including guarantee claims or in case of claims involving several defendants, only the courts of our head office will be competent, and the French law will apply.